

1 Unpack the Printer

- Carefully remove all items from the box.

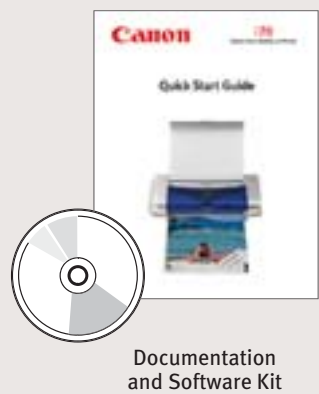
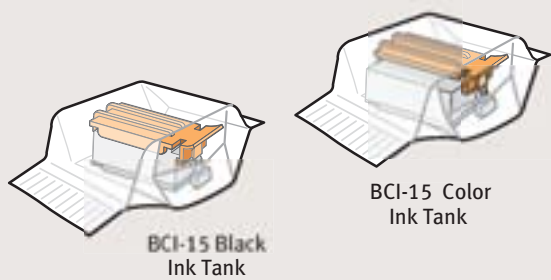
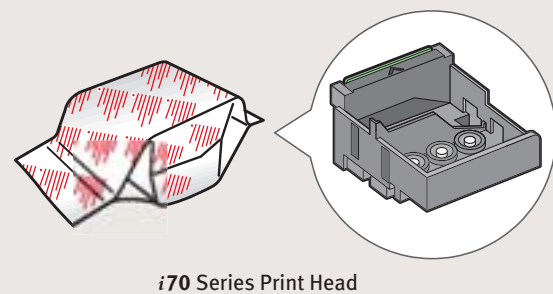
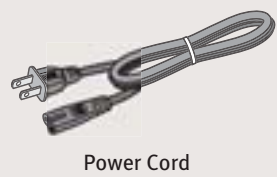

NOTE: Electronic User's Guide is included on the CD-ROM.

2 Prepare the Printer

- Remove all shipping tape and materials from the unit.

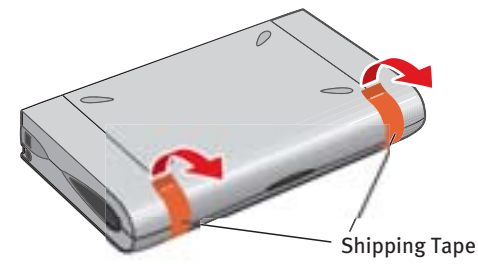

- Plug the power cord into the AC adapter. Connect the DC plug to the printer.

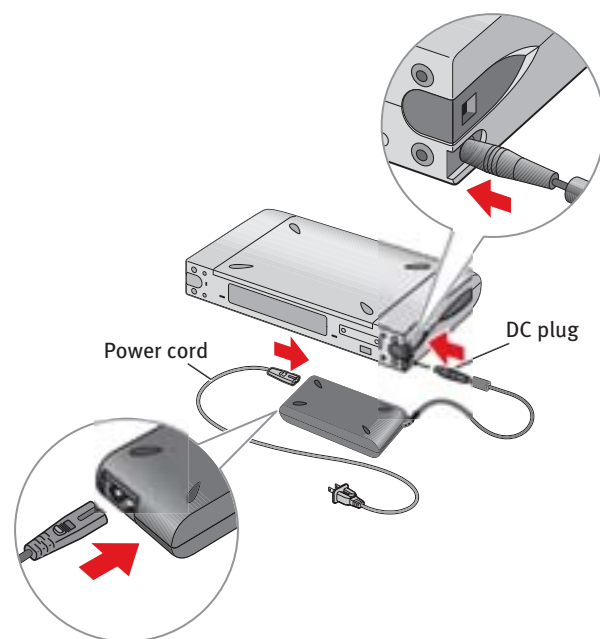

- Plug the power cord into the power outlet.

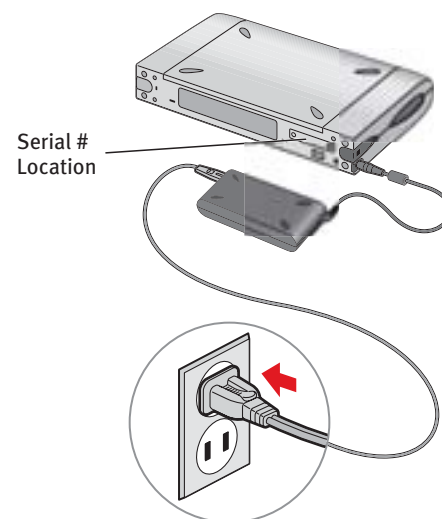

- Lift open the paper rest and **TURN THE PRINTER ON**. The printer will initialize.



3 Install the Print Head

- Open the print head cover.

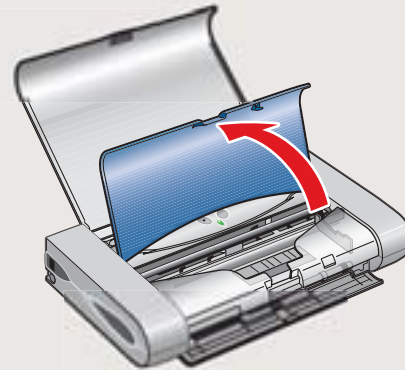

- Press in on the lock button and lift the gray lock lever.

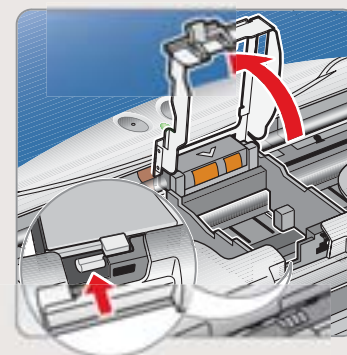

- Remove the print head from its package. Turn the print head over and remove the protective cap from the print head cover.

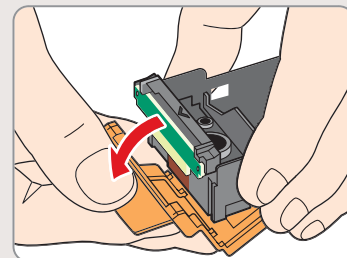

NOTE: Do not touch the print head nozzles.

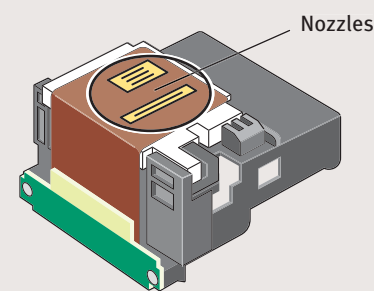

- Place the print head into the holder.

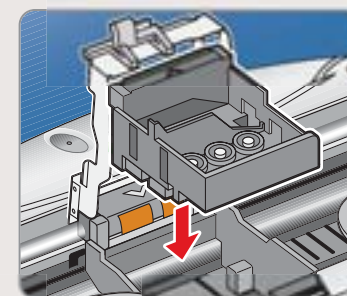

- Lower the gray lock lever until it is secure.

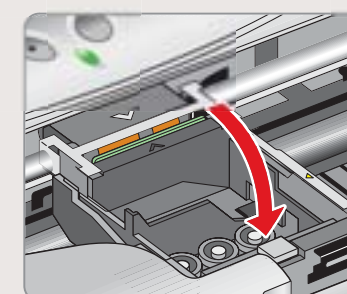

4 Install the Ink Tanks

- Remove the BCI-15 Black ink tank from its package.
- You **MUST** remove the protective cap.

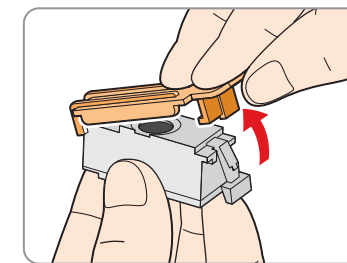

- Insert the black ink tank into the back slot.

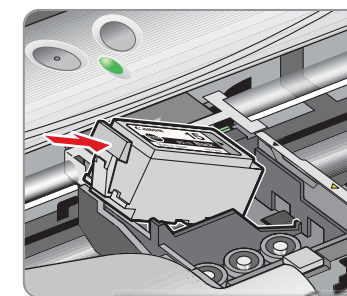

- Press down until it locks into place.

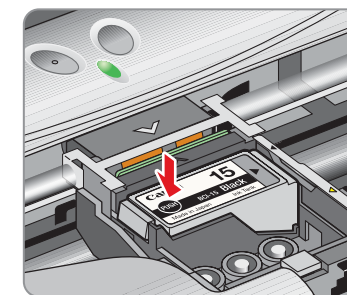

- Using the procedure above, insert the color ink tank into the front slot.

- Close the print head cover and move the paper thickness lever to the right.

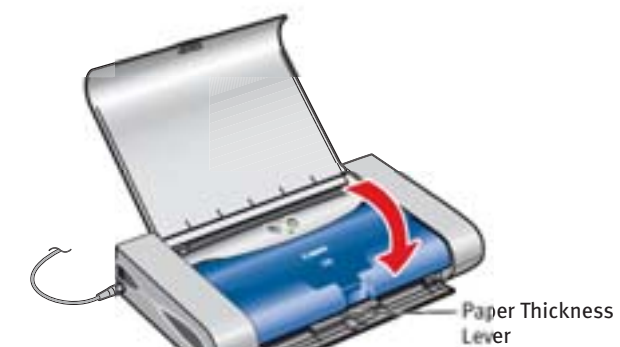

5 Connect to Your Computer

- TURN THE PRINTER OFF.**
IMPORTANT: Be sure the printer is off before continuing, or the computer will attempt to install the printer driver before the printer is ready.
- Connect the USB cable to the computer, the other to the printer.

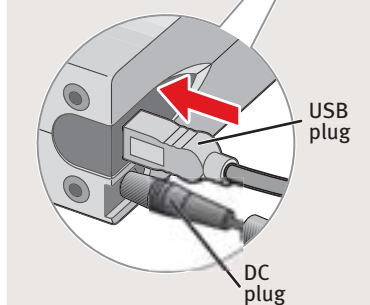
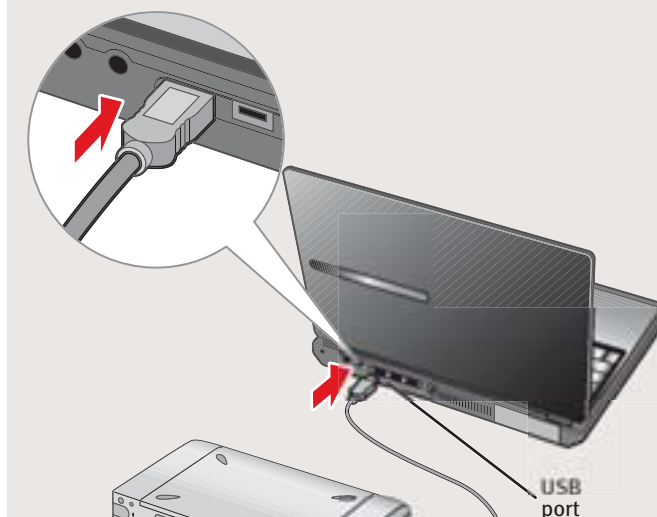
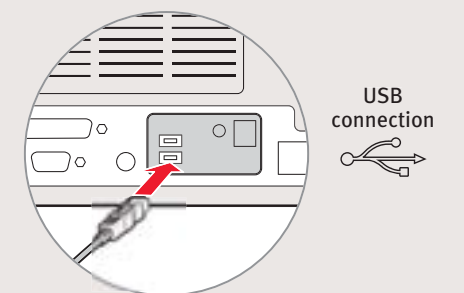

Continue with Step 6 on side two.



6 Install the Printer Driver (Windows®)

- 1 Be sure that the printer is off, then turn on your computer.

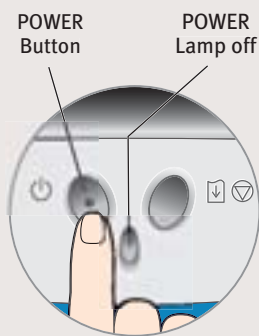

NOTE: For Windows® XP or Windows 2000, log on to Windows as an Administrator before continuing.

IMPORTANT: If you see the Add New Hardware Wizard, click **Cancel**.

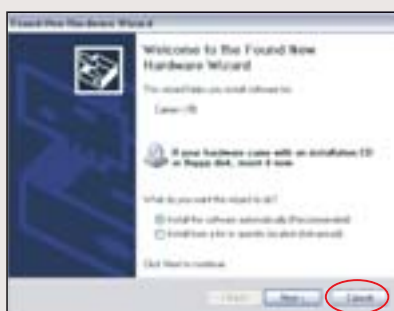

- 2 Close any open software applications, then insert the "Setup Software & User's Guide" CD-ROM. The setup program should run automatically.

NOTE: If the setup program does not run automatically, Click **Start**, then **Run**, then type D:/msetup.exe, where D is your CD-ROM drive.

- 3 Read the License Agreement, then click **Yes**.
- 4 When the main menu appears, click **Install**.



- 5 When the Printer Port window appears, **TURN THE PRINTER ON**. The software will begin identifying the printer port being used.



IMPORTANT: If your computer cannot detect a printer port, refer to the Troubleshooting chapter in the *i70 Quick Start Guide* for instructions.

- 6 When the driver installation is complete, click **Finish**.
- 7 Register your product to ensure product support. Follow the on-screen instructions.



NOTE: Be sure to register your product. The serial number is located on the back of the printer.

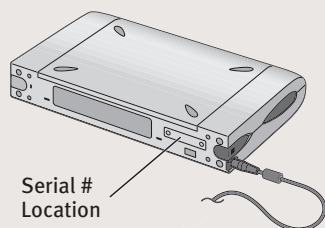

- 8 When the software menu appears, click **Install**.



IMPORTANT: To ensure highest quality output, continue with **Step 7 Align the Print Head**.

6 Install the Printer Driver (Macintosh®)

NOTE: If you are using Mac OS 8.6 to 9.x, please refer to your Quick Start guide for installation instructions.

- 1 Turn on your Mac and your printer and insert the "Setup Software & User's Guide" CD-ROM.

- 2 Open the Mac OS X folder, then double-click the Printer Driver folder.

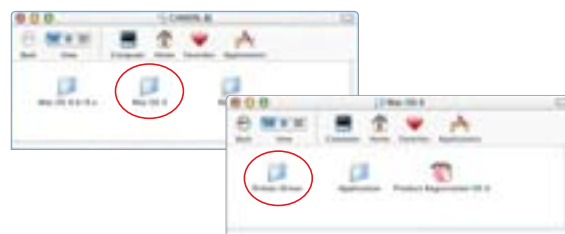

- 3 Double-click the **i70** icon.

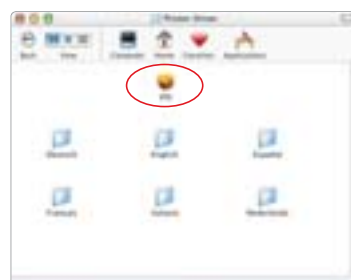

NOTE: For v10.2 users, skip to Step 5.

- 4 Click the **lock icon** and enter the Administrator name and password, then click **OK**.



- 5 When the "Welcome to the BJ printer installer" screen appears, click **Continue**.
- 6 Read the Software License Agreement and click **Continue**, then click **Agree**.

- 7 Select a destination for the printer driver to be installed. Then click **Continue**.



- 8 Click **Install**. When a message asking for your confirmation to proceed with the installation, click **Continue Installation**.



- 9 When the message "The software was successfully installed" appears, click **Restart**.

- 10 Access your CD-ROM again. From the Application folder, double-click on the software to be installed.

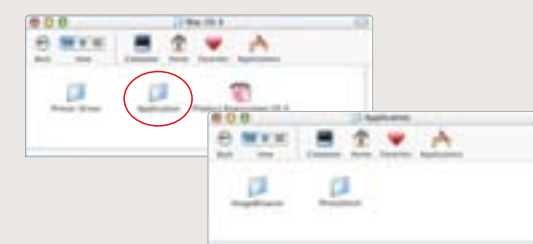

- 11 Follow the on-screen instructions. When the "Installation is Complete" screen appears, click **OK**.

NOTE: Be sure to register your product. The serial number is located on the back of the printer.

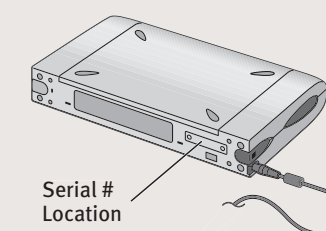

IMPORTANT: To ensure highest quality output, continue with **Step 7 Align the Print Head**.

7 Align the Print Head

Before using the printer, align the print head to ensure the best quality printing.

- 1 Load a stack of blank paper in the paper rest.
- 2 Start the alignment procedure.

Windows:

- a. For Windows XP select **Start**, then **Control Panel**. Then click on **Printers and Other Hardware**, then **Printers and Faxes**.
- b. Right-click the **Canon i70** icon, then click **Printing Preferences**.
- c. Click the **Maintenance** tab, then click the **Print Head Alignment** icon.
- d. When asked to start print head alignment, click **OK**.

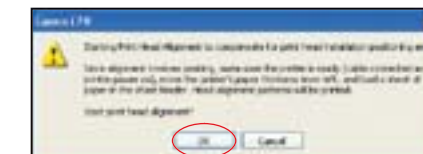

- e. Follow the on-screen instructions to complete print head alignment.

Macintosh OS X:

- a. Double-click the **Macintosh HD** icon, then **Applications** folder. Double-click the **Utilities** folder, then the **Print Center** icon. The Printer List window appears.



Under **Printers** menu, select **Configure Printer**. Select **i70**, and click **Select**.

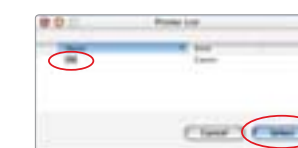

- b. Click the down-arrow to select **Test Print**.
- c. Click the **Print Head Alignment** icon.

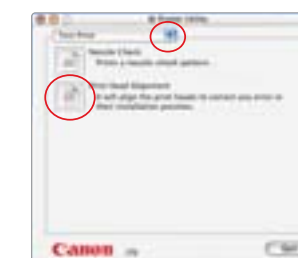

- 3 Follow the on-screen instructions.
- 4 Click **OK** (Windows) or **Send** (Macintosh) when finished.

Free Manuals Download Website

<http://myh66.com>

<http://usermanuals.us>

<http://www.somanuals.com>

<http://www.4manuals.cc>

<http://www.manual-lib.com>

<http://www.404manual.com>

<http://www.luxmanual.com>

<http://aubethermostatmanual.com>

Golf course search by state

<http://golfingnear.com>

Email search by domain

<http://emailbydomain.com>

Auto manuals search

<http://auto.somanuals.com>

TV manuals search

<http://tv.somanuals.com>