

# Set-Up Sheet

## READ THIS GUIDE FIRST

Thank you for purchasing the Canon imageCLASS D320. To get your machine ready for use, please follow the instructions in this Set-Up Sheet before referring to any other documentation.

**1**

### Unpack the machine and its components.

Check that you have the following:



● Machine

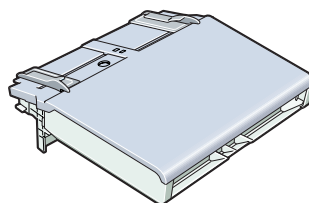

● Cassette/Multi-purpose tray

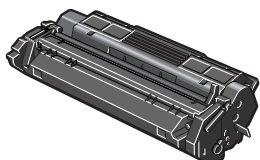

● Canon S35 Cartridge

- Power Cord
- Documentation  
(Set-Up Sheet, Basic Guide, Registration Card, Limited Warranty Card)
- CD-ROM



### IMPORTANT

- Save your sales receipt for proof of purchase in case your machine requires warranty service.



### NOTE

- A printer cable is not included. You need a USB cable (less than 16.4ft./5m) to connect your machine to a computer.

## 2

### Removing Shipping Materials

- 1 Place the machine on a flat surface.
- 2 Remove the shipping tapes on the machine and cassette/multi-purpose tray.

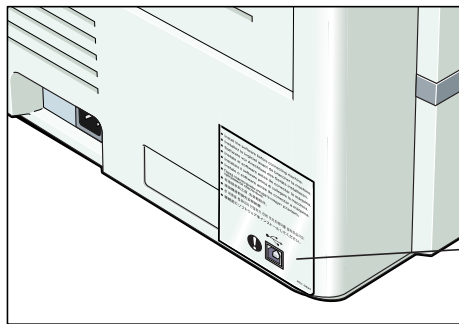

Left side view

#### NOTE

- DO NOT remove the transparent USB label (A) at this stage.

- 3 Open the platen glass cover (B) to remove the inner protection sheet (C).

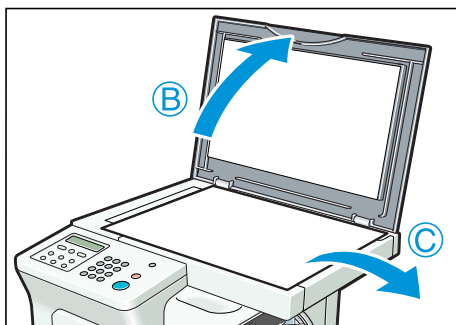

## 3

### Installing the Cassette

- Raise the cassette slightly toward the machine, and align the hooks on both sides of the cassette with the guides in the machine, then insert the cassette into the machine as far as it will go (1). Then gently lower the cassette (2).

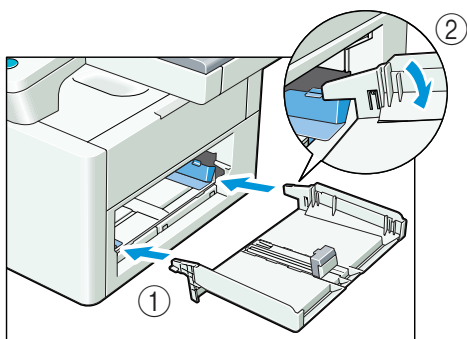

#### NOTE

- Install the cassette so that there is no space between the cassette and the feeding slot.

# 4

## Loading Paper in the Cassette

- 1 Load the paper stack in the cassette.
  - Insert the paper stack into the cassette as far as it will go.

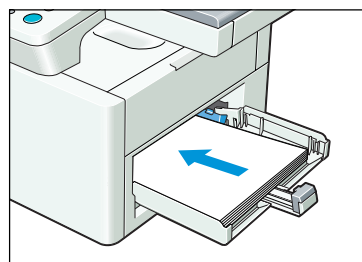

- 2 Slide the width guides (A) and the length guide (B) to fit the size of the paper stack.
  - Adjust the guides so that there is no space between the guides and the paper.

### NOTE

- Make sure the paper stack does not exceed the width and length guides' claws.

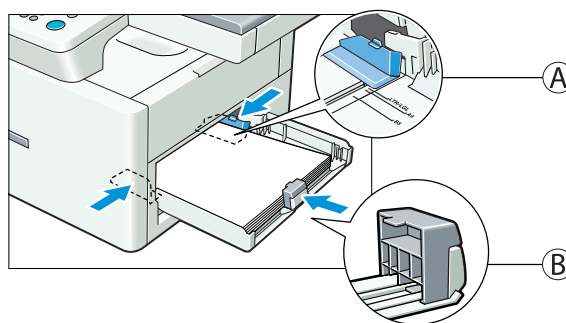

- 3 Set the multi-purpose tray on top of the cassette.

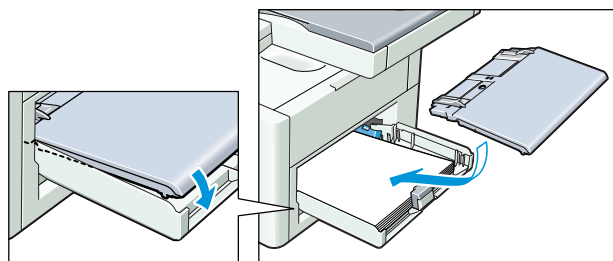

# 5

## Connecting the Power Cord

When the power cord is plugged into the machine and into the wall outlet, the machine is turned on. There is no separate ON/OFF power switch. Once connected, the machine needs to warm up before you can use it. The LCD displays PLEASE WAIT, then INSTALL CARTRIDGE. The LCD returns to the standby display when you install the cartridge and load paper in the cassette or multi-purpose tray.

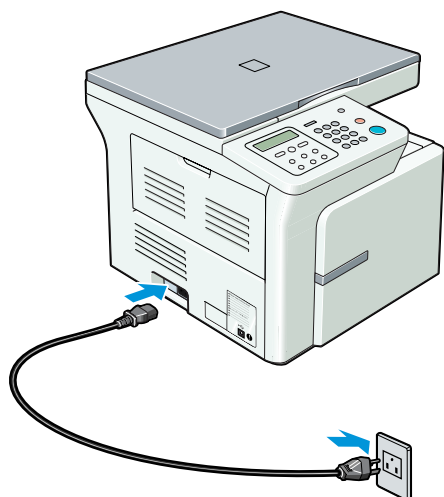

### NOTE

- Insert the power cord straight into the power cord connector on the left side of the machine. Do not insert it at an angle. Otherwise, the machine may not be properly connected to the power source and may not turn on. If this happens, disconnect the power cord, and reconnect it correctly after a minute or more.
- When disconnecting or connecting the power cord, be sure to unplug or plug the power cord from the wall outlet, not from the power cord connector on the machine.

# 6

## Installing the Cartridge

1 Remove the new cartridge from its protective bag.

 **NOTE**

- Save the protective bag. You may need it later when you remove the cartridge.

2 Rock the cartridge 5 or 6 times to distribute the toner evenly.

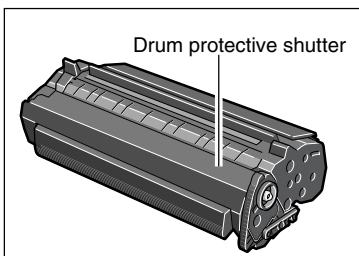
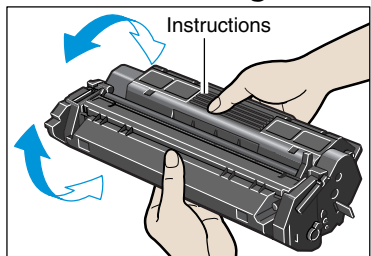

 **NOTE**

- Always hold the cartridge as shown so that the side with the instructions are facing upward. Do not forcefully move or push the protective shutter of the drum in any way.

3 Place the cartridge on a flat and stable surface, grip the sealing tape tab and snap it in the direction shown below. Make sure that the tab itself is detached from the cartridge.

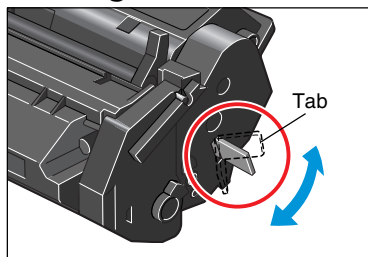

4 While grasping the cartridge firmly, slowly pull the sealing tape tab straight out with the other hand to remove the sealing tape completely. Discard the tape.

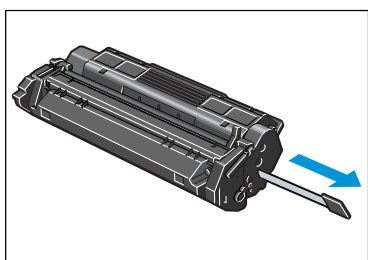

 **IMPORTANT**

- Be sure to remove the sealing tape completely. Otherwise, toner will not be supplied to the machine and no image or text will be transferred to the page.
- To avoid breaking the sealing tape when removing, pull the tab straight out. Do not pull it out at an upward or downward angle.

5 Open the right cover.

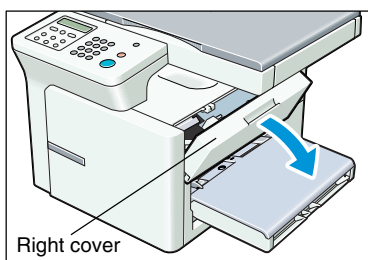

**Turn over to  
continue**

**6** Hold the cartridge and position the arrow mark on the cartridge towards the inside of the machine shown below.

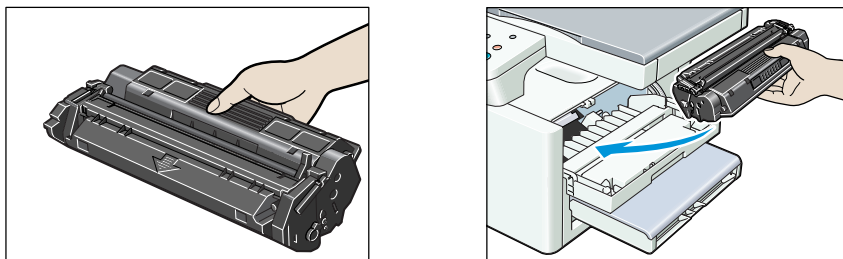

**7** Align the projections **(A)** on both sides of the cartridge to the guides **(B)** in the machine (location **(1)**) and gently slide the cartridge into the machine until the right cover slightly rises up (location **(2)**).

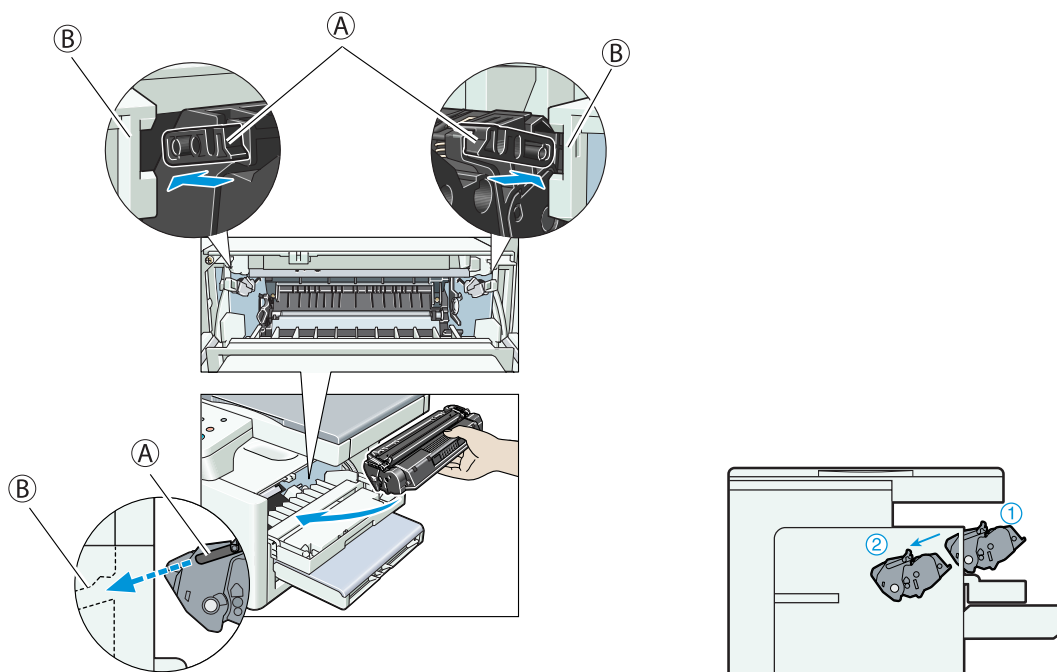

**IMPORTANT**

- **The right cover moves simultaneously with the action of the cartridge. Do not push the cartridge farther than location (2). Doing so will result in catching your hand in the right cover.**

**8** Close the right cover, and the cartridge will be set in place (location **(3)**).

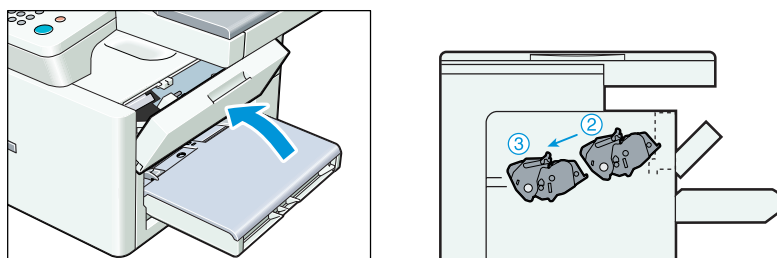

# 7

## Installing User Software (Windows 98/Me/2000/XP)

### IMPORTANT

- Before you can print, you must install the user software on your computer.

Screen shots in the following installation procedures are for Windows 98.

1 Make sure the USB cable is NOT connected to your machine and computer at this stage.

### IMPORTANT

- If the Plug and Play is automatically carried out and the Found New Hardware Wizard appears, click **Cancel**, and follow this procedure.

2 Insert the CD-ROM into your CD-ROM drive.

3 If **AutoRun** is enabled, the installation starts automatically.

### NOTE

- If installation does not start automatically, choose **Run...** from the **Start Menu**, Type **D:\Drivers\us\_eng\prnsetup\Setup.exe** (if your CD-ROM drive is drive D:) in the command line and click **OK**.

4 Click **Next>**.

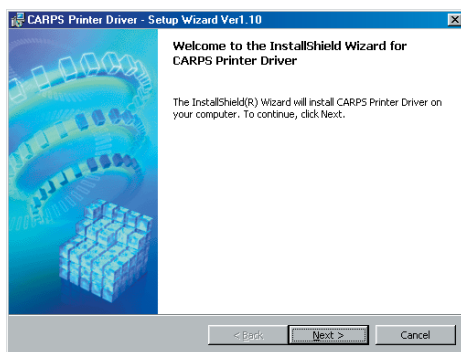

5 When the License Agreement appears, check the contents. Select **I accept the terms in the license agreement**, then click **Next>**.

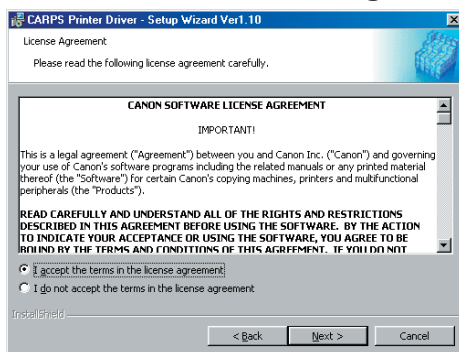

### NOTE

- The message recommending to restart your computer may appear under some operating systems. In this case, continue installing after restarting your computer.

## 6 Check **Install Printer Driver through a USB Connection**, then click **Next>** .

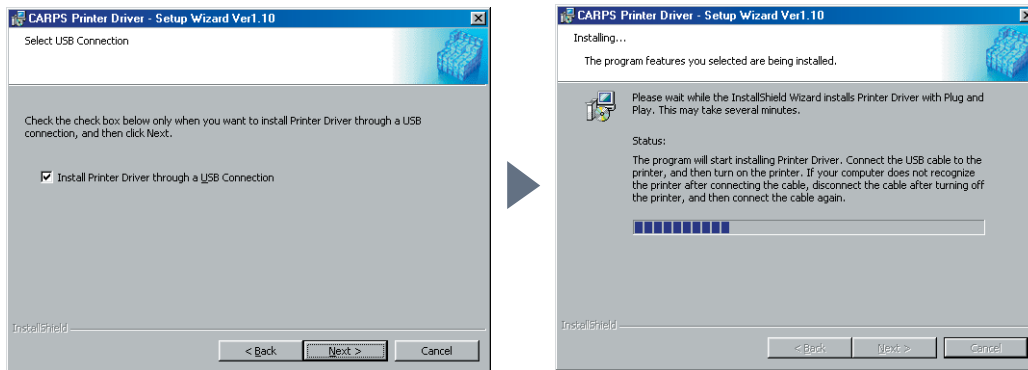

When the screen (on the upper right) appears, follow the procedure below.

**6-1 Remove the transparent USB label (A) .**

**6-2 Connect the USB cable (B) to the machine and computer.**

The program will start installing the Printer Driver automatically.

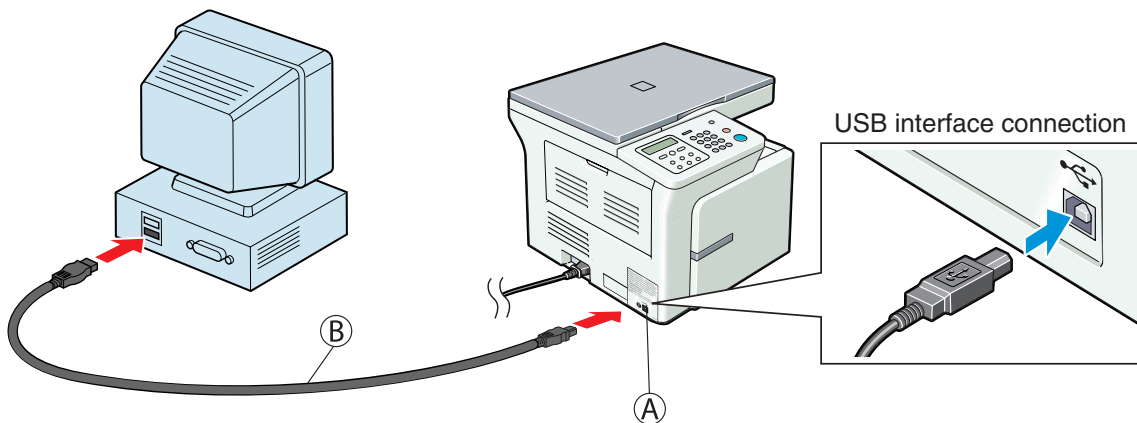

## 7 When the following screen appears, select **Yes, I want to restart my computer now.** Then click **Exit.**

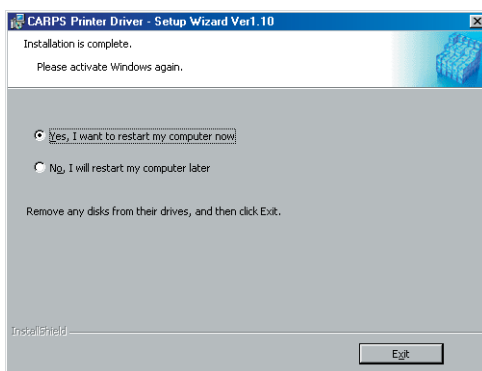



## Reading Electronic Manuals

To see the guides, proceed as follows.

- 1 Insert the CD-ROM into your CD-ROM drive.
- 2 On the Windows desktop, click **Start**, and then Click **Run...**
- 3 In the Run dialog box, type **D:\Manuals** and click **OK** (where D: is the CD-ROM drive containing the installation disk).  
The Printer Guide is available in the manuals folder.

### **NOTE**

- If you do not have Adobe Acrobat Reader installed on your computer, follow the procedure below to install it.

- 1 Insert the CD-ROM into your CD-ROM drive.
- 2 On the Windows desktop, click **Start**, and then Click **Run...**
- 3 In the Run dialog box, type **D:\Acread** and click **OK** (where D: is the CD-ROM drive containing the installation disk).
- 4 Double-click the **.exe file** in the Acrobat folder.



## Free Manuals Download Website

<http://myh66.com>

<http://usermanuals.us>

<http://www.somanuals.com>

<http://www.4manuals.cc>

<http://www.manual-lib.com>

<http://www.404manual.com>

<http://www.luxmanual.com>

<http://aubethermostatmanual.com>

Golf course search by state

<http://golfingnear.com>

Email search by domain

<http://emailbydomain.com>

Auto manuals search

<http://auto.somanuals.com>

TV manuals search

<http://tv.somanuals.com>