

Basic Guide

- What Can I Do with This Machine?
- Before Using the Machine
- Document Handling
- Print Media
- Sending Faxes
- Receiving Faxes
- Copying
- Printing
- Scanning
- PC Faxing
- Maintenance
- Troubleshooting
- Machine Settings
- Appendix

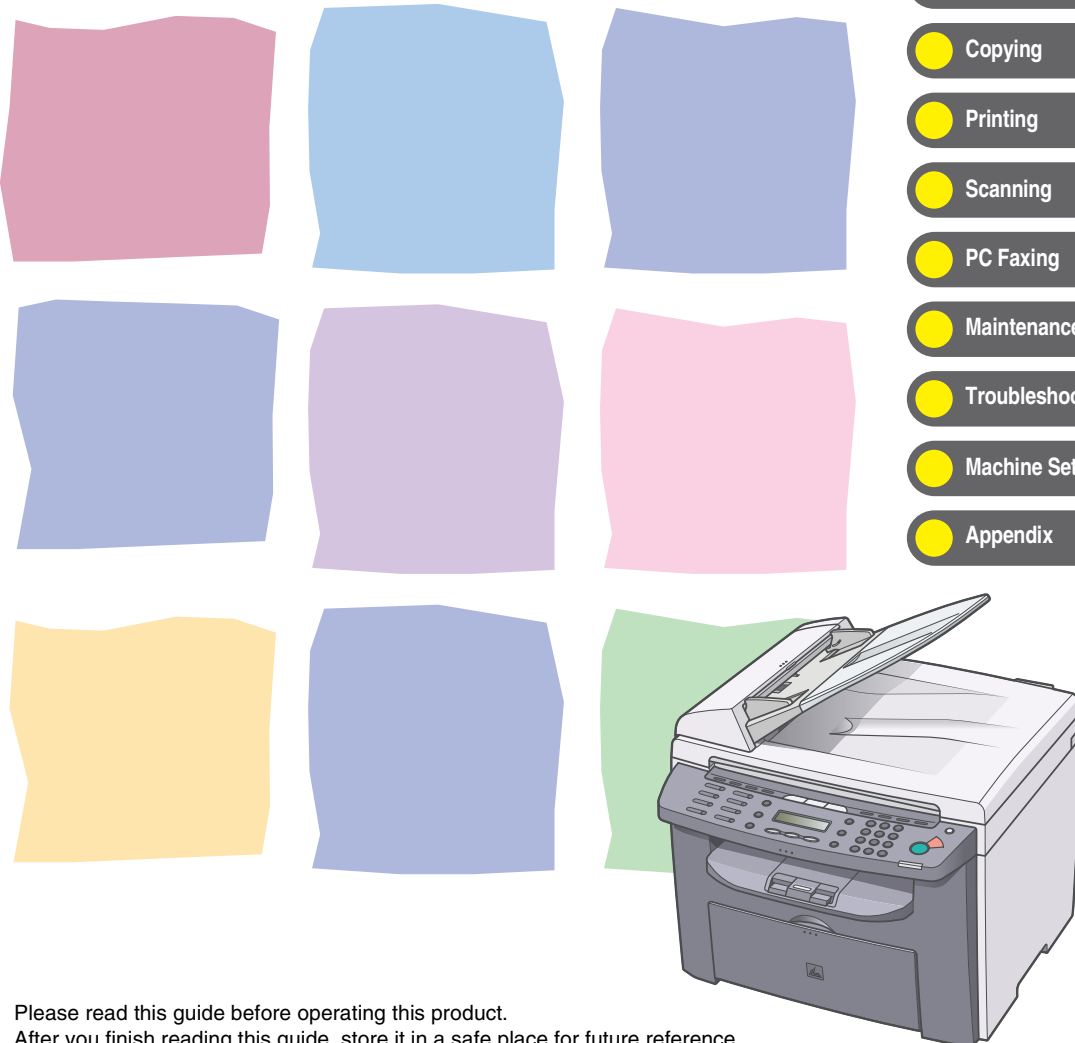

Please read this guide before operating this product.
After you finish reading this guide, store it in a safe place for future reference.

Manuals for the Machine

- Machine Set-Up
- Software Installation

Starter Guide

- Basic Features
- Maintenance
- Machine Settings
- Specifications

Basic Guide (This Document)

- Advanced Features
- System Monitor
- Reports and Lists

Advanced Guide



- Scanning Features

Scanner Driver Guide



Indicates the manual is supplied in PDF format in the accompanying CD-ROM.

- To view the manual in PDF format, Adobe Reader/Acrobat Reader/Acrobat is required. If Adobe Reader/Acrobat Reader/Acrobat is not installed on your system, please download it from the Adobe Systems Incorporated website (<http://www.adobe.com>).
- Considerable effort has been made to ensure that this manual is free of inaccuracies and omissions. However, as we are constantly improving our products, if you need an exact specification, please contact Canon.
- The machine illustration on the cover may differ slightly from your machine.

What Can I Do with This Machine?

Fax Features

Specify a recipient with a single key

One-Touch Speed Dialing

→ p. 4-7

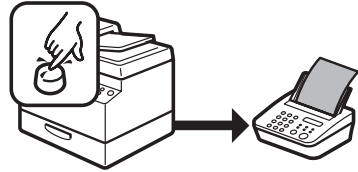

Specify a recipient with a two-digit code

Coded Dialing

→ p. 4-14

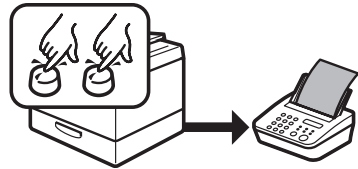

Specify multiple recipients with a single key

Group Dialing

→ p. 4-21

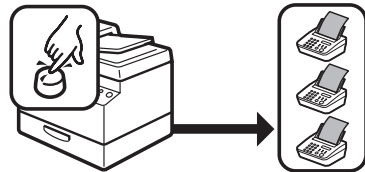

Look up a particular recipient

Using Address Book

→ Advanced Guide

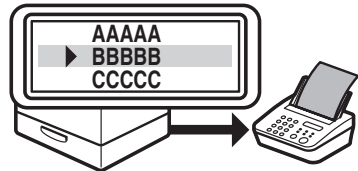

Redial when the line is busy

Redialing

→ Advanced Guide

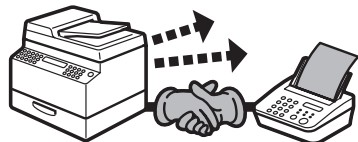

Send a fax to multiple recipients

Broadcasting

→ Advanced Guide

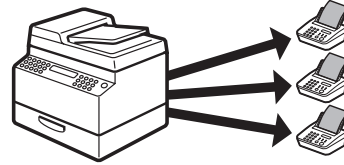

Receive faxes in memory without printing out

Memory Reception

→ Advanced Guide

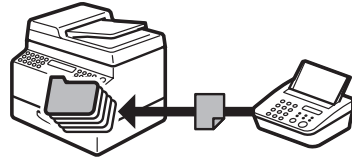

Reject faxes without their numbers

Reception Restriction

→ Advanced Guide

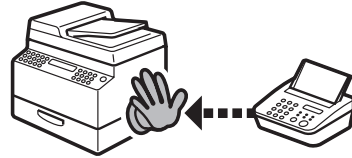

Copy Features

Select a scan mode depending on the type of image

Image Quality

→ p. 6-3

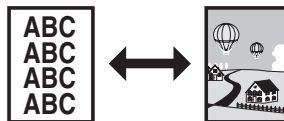

Adjust the density level of scanned images

Density

→ p. 6-4



Enlarge or reduce copied images

Zoom Ratio

→ p. 6-6

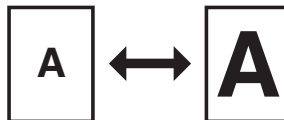

Sorts copies by page order

Collate Copy

→ Advanced Guide

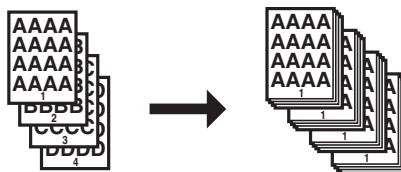

Make two-sided copies

Two-Sided Copying

→ Advanced Guide



Copy two documents on one sheet

2 on 1 Combination

→ [Advanced Guide](#)

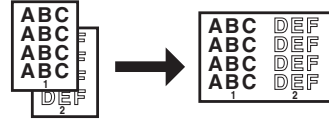

Printer Feature

Print a document from a PC

Printing

→ [Online Help](#)

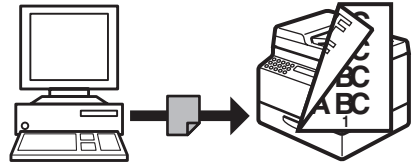

Scanner Feature

Specify detailed scanning options to suit various images

Scanning

→ [Scanner Driver Guide](#)

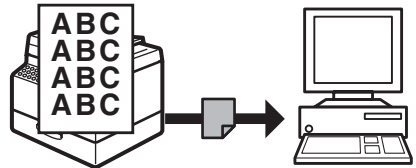

PC Fax Feature

Send a fax from a PC

PC Faxing

→ [Online Help](#)

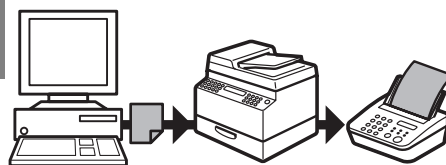

Contents

Manuals for the Machine	i
What Can I Do with This Machine?	ii
Fax Features.....	ii
Copy Features	iv
Printer Feature.....	v
Scanner Feature	v
PC Fax Feature	vi
Contents	vii
Preface	xiii
Important Safety Instructions	xiii
Handling and Maintenance	xiii
Location	xiv
Power Supply.....	xv
Customer Support (U.S.A.).....	xvi
Customer Support (Canada).....	xvi
How to Use This Guide	xvii
Symbols Used in This Manual	xvii

Legal Notices	xviii
Copyright	xviii
Disclaimers	xviii
Legal Limitations on the Usage of Your Product and the Use of Images.....	xix
Trademarks.....	xx
Users in the U.S.A.....	xxi
Pre-Installation Requirements for Canon Facsimile Equipment.....	xxi
Connection of the Equipment	xxii
In Case of Equipment Malfunction.....	xxii
Rights of the Telephone Company	xxiii
FCC Notice	xxiii
Users in Canada.....	xxv
Pre-Installation Requirements for Canon Facsimile Equipment.....	xxv
Notice.....	xxvi
Laser Safety	xxviii
CDRH Regulations	xxviii
 1 Before Using the Machine	 1-1
Machine Components	1-1
Operation Panel	1-4
Main Operation Panel.....	1-4
Facsimile Operation Panel.....	1-6

- LCD (Standby Mode) 1-7**
 - Fax Mode..... 1-7
 - Copy Mode 1-7
 - Scan Mode..... 1-7
- Toner Cartridge..... 1-8**
 - Maintaining the Toner Cartridge 1-9
 - Checking the toner level 1-10
- Timer Settings 1-11**
 - Setting the Sleep Mode 1-11
 - Setting Daylight Saving Time..... 1-14
- 2 Document Handling..... 2-1**
 - Document Requirements 2-1**
 - Scanning Area..... 2-3**
 - Loading Documents 2-4**
 - On the Platen Glass..... 2-4
 - In the ADF..... 2-6
- 3 Print Media 3-1**
 - Paper Requirements..... 3-1**
 - Printable Area 3-2**
 - Paper Guidelines 3-3**
 - Loading Paper..... 3-4**
 - Into the Multi-Purpose Tray 3-4
 - Setting Paper Size and Type..... 3-7**

- 4 Sending Faxes 4-1**
 - Scan Settings 4-3**
 - Image Quality..... 4-3
 - Density..... 4-5
 - Speed Dialing 4-6**
 - Registering Recipients for Speed Dialing 4-6
 - Using Speed Dialing 4-30
 - Manual Sending 4-32**
- 5 Receiving Faxes 5-1**
- 6 Copying 6-1**
 - Scan Settings 6-3**
 - Image Quality..... 6-3
 - Density..... 6-4
 - Zoom Ratio 6-6
- 7 Printing 7-1**
- 8 Scanning 8-1**
- 9 PC Faxing 9-1**

10 Maintenance	10-1
Cleaning the Machine	10-1
Exterior	10-1
Interior.....	10-2
Fuser Roller	10-4
Scanning area.....	10-5
Replacing the Toner Cartridge	10-8
Redistributing Toner	10-8
Replacing the Toner Cartridge with a New One	10-10
Recycling Used Cartridges	10-12
The Clean Earth Campaign	10-12
U.S.A. PROGRAM.....	10-14
CANADA PROGRAM-CANADA PROGRAMME	10-17
Transporting the Machine	10-19
11 Troubleshooting	11-1
Clearing Jams	11-1
Document Jams.....	11-1
Paper Jams.....	11-3
LCD Messages	11-9
Common	11-9
Facsimile.....	11-16
Printer	11-19

Error Codes	11-20
If You Cannot Solve a Problem	11-21
Customer Support (U.S.A.).....	11-21
Customer Support (Canada).....	11-21
12 Machine Settings	12-1
Machine Settings	12-1
Printing User's Data List	12-1
Accessing the Setting Menu	12-3
Setting Menu	12-5
PAPER SETTINGS	12-5
COMMON SETTINGS	12-5
COPY SETTINGS	12-6
TIMER SETTINGS	12-7
FAX SETTINGS	12-8
BROADCAST	12-12
ADDRESS BOOK SET.	12-12
ADJUST./CLEANING	12-13
REPORT SETTINGS	12-14
13 Appendix	13-1
Specifications	13-1
General	13-1
Copier	13-2
Printer	13-3
Facsimile.....	13-3
Telephone.....	13-5
Index	13-6

Preface

Thank you for choosing a Canon product. Before using the machine, please read the following instructions for your safety.

Important Safety Instructions



WARNING

Except as specifically described in this guide, do not attempt to service the machine yourself. Never attempt to disassemble the machine: opening and removing its interior covers will expose you to dangerous voltages and other risks. For all service, contact Canon Customer Care Center, or a Canon Authorized Service Facility.

Handling and Maintenance

- Follow all warnings and instructions marked on the machine.
- Do not subject the machine to strong physical shocks or vibrations.
- Always unplug the machine before moving or cleaning it.
- To avoid paper jams, never unplug the power cord, open the scanning platform, or add or remove paper in the machine while printing.
- When transporting the machine, be sure to remove the toner cartridge from the machine.
- Place the toner cartridge in its original protective bag or wrap it in a thick cloth to prevent exposure to light.
- Always grip the handle on the sides of the machine when you lift the machine. Never lift the machine by any of its trays or attachments.
- Do not insert any objects into the slots or openings on the machine since they may touch dangerous voltage points or short out parts. This could result in fire or electric shock.
- Do not allow small objects (such as pins, paper clips, or staples) to fall into the machine.
- To avoid spillage in or around the machine, do not eat or drink near it.
- Keep the machine clean. Dust accumulation can prevent the machine from operating properly.



- Turn off the main power switch and unplug the power cord from the wall outlet and contact Canon Customer Care Center in any of the following cases:
 - When the power cord or plug is damaged or frayed.
 - If liquid or small object has fallen into the machine.
 - If the machine has been exposed to rain or water.
 - If the machine does not operate normally when you have followed the instructions in this guide. Adjust only those controls that are covered by the instructions in this guide. Improper adjustment of other controls may result in damage and may require extensive work by a qualified technician to restore the product to normal operation.
 - If the machine has been dropped.
 - If the machine exhibits a distinct change in performance, indicating a need for servicing.

Location

- Place the machine on a flat, stable, vibration-free surface that is strong enough to support its weight.
- Place the machine in a cool, dry, clean, well ventilated place.
- Make sure the area is free from dust.
- Make sure the location is not exposed to high temperature or humidity.
- Keep the machine away from direct sunlight as this can damage it. If you have to place the machine near a window, install heavy curtains or blinds.
- Do not use the machine near water. Make sure that no wet or humid objects come into contact with the machine.
- Do not use or store the machine outdoors.
- Do not place the machine near devices that contain magnets or generate magnetic fields, such as speakers.

- If possible, place the machine near an existing telephone line outlet for easy connection of the telephone line cord, and to avoid the expense of installing a new outlet.
- Place the machine near a standard 120 V AC (60 Hz) power outlet.
- To ensure reliable operation of the machine and to protect it from overheating (which can cause it to operate abnormally and create a fire risk), do not block the exhaust vent. Never block or cover any openings on the machine by placing it on a bed, sofa, rug, or other similar surface. Do not place the machine in a cupboard or built-in installation, or near a radiator or other heat source unless proper ventilation is provided. Leave enough space around all sides of the machine.
- Do not stack boxes or furniture around the power outlet. Keep the area free so you can reach the outlet quickly. If you notice anything unusual (smoke, strange odors, noises) around the machine, unplug the power cord immediately. Contact Canon Customer Care Center.
- Do not allow anything to rest on the power cord, and do not place the machine where the cord will be walked on. Make sure the cord is not knotted or kinked.

Power Supply

- During electrical storms, turn off the main power switch and unplug the power cord from the power outlet.
(Please note that any documents stored in the machine's memory will be deleted when you unplug the power cord.)
- Whenever you turn off the main power switch, wait at least five seconds before you turn it on again.
- Do not plug the power cord into an uninterruptible power supply (UPS).

WARNING

This product emits low level magnetic flux. If you use a cardiac pacemaker and feel abnormalities, please move away from this product and consult your doctor.

Customer Support (U.S.A.)

Your machine is designed with the latest technology to provide trouble-free operation. If you encounter a problem with the machine's operation, try to solve it by using the information in Chapter 11. If you cannot solve the problem or if you think your machine needs servicing, contact Canon Customer Care Center at 1-800-828-4040 between the hours of 8:00 A.M. to 8:00 P.M. EST Monday through Friday and 10:00 A.M. to 8:00 P.M. on Saturday. On-line support for 24 hours is also available at the website. <http://www.canontechsupport.com/>

Customer Support (Canada)

Canon Canada Inc., offers a full range of customer technical support options*:

- For step-by-step troubleshooting, e-mail technical support, the latest driver or document downloads, and answers to frequently asked questions, visit <http://www.canon.ca/>
- Free live technical support 9 A.M. to 8 P.M. EST Monday through Friday (excluding holidays) for products still under warranty 1-800-652-2666
- For the location of the authorized service facility nearest you, visit <http://www.canon.ca/> or 1-800-652-2666
- If the problem cannot be corrected by using one of the above technical support options, repair options are available at the time of your call to the live technical support number above or via the website at <http://www.canon.ca/>

* Support program specifics are subject to change without notice.

How to Use This Guide

Symbols Used in This Manual

The following symbols are used throughout the manuals for the machine and indicate the warnings, cautions and notes you should keep in mind when using the machine.



WARNING

Indicates a warning that may lead to death or serious injury if not observed.



CAUTION

Explains how to avoid actions that could injure you or damage your machine.



NOTE

Explains operating restrictions and how to avoid minor difficulties.

In addition, this guide uses distinctive notations to identify keys and information in the LCD:

- The keys you press appear in square brackets: [Stop/Reset].
- Information in the LCD appears in angle brackets: <LOAD PAPER>.

The numbers that point to the keys on the operation panel diagram correspond to the order of steps to take in the procedure.

Legal Notices

Copyright

Copyright © 2006 by Canon Inc. All rights reserved. No part of this publication may be reproduced, transmitted, transcribed, stored in a retrieval system, or translated into any language or computer language in any form or by any means, electronic, mechanical, magnetic, optical, chemical, manual, or otherwise, without the prior written permission of Canon Inc.

Disclaimers

The information in this document is subject to change without notice.

CANON INC. MAKES NO WARRANTY OF ANY KIND WITH REGARD TO THIS MATERIAL, EITHER EXPRESS OR IMPLIED, EXCEPT AS PROVIDED HEREIN, INCLUDING WITHOUT LIMITATION, THEREOF, WARRANTIES AS TO MARKETABILITY, MERCHANTABILITY, FITNESS FOR A PARTICULAR PURPOSE OF USE OR NON-INFRINGEMENT. CANON INC. SHALL NOT BE LIABLE FOR ANY DIRECT, INCIDENTAL, OR CONSEQUENTIAL DAMAGES OF ANY NATURE, OR LOSSES OR EXPENSES RESULTING FROM THE USE OF THIS MATERIAL.

Legal Limitations on the Usage of Your Product and the Use of Images

Using your product to scan, print or otherwise reproduce certain documents, and the use of such images as scanned, printed or otherwise reproduced by your product, may be prohibited by law and may result in criminal and/or civil liability.

A non-exhaustive list of these documents is set forth below. This list is intended to be a guide only. If you are uncertain about the legality of using your product to scan, print or otherwise reproduce any particular document, and/or of the use of the images scanned, printed or otherwise reproduced, you should consult in advance with your legal advisor for guidance.

- Paper Money
- Money Orders
- Certificates of Deposit
- Postage Stamps (canceled or uncanceled)
- Identifying Badges or Insignias
- Selective Service or Draft Papers
- Checks or Drafts Issued by Governmental Agencies
- Motor Vehicle Licenses and Certificates of Title
- Travelers Checks
- Food Stamps
- Passports
- Immigration Papers
- Internal Revenue Stamps (canceled or uncanceled)
- Bonds or Other Certificates of Indebtedness
- Stock Certificates
- Copyrighted Works/Works of Art without Permission of Copyright Owner

Trademarks

Canon, the Canon logo, and imageCLASS are trademarks of Canon Inc.

All other product and brand names are registered trademarks, trademarks or service marks of their respective owners.



As an ENERGY STAR Partner, Canon U.S.A., Inc. has determined that this product meets the ENERGY STAR Program for energy efficiency.

The International ENERGY STAR Office Equipment Program is an international program that promotes energy saving through the use of computers and other office equipment.

The program backs the development and dissemination of products with functions that effectively reduce energy consumption. It is an open system in which business proprietors can participate voluntarily.

The targeted products are office equipment, such as computers, displays, printers, facsimiles, and copiers. The standards and logos are uniform among participating nations.

Users in the U.S.A.

Pre-Installation Requirements for Canon Facsimile Equipment

A. Location

Supply a suitable table, cabinet, or desk. See p. 13-1 for the machine's weight and dimensions.

B. Order Information

1. Only a single line, touch-tone or rotary telephone set is to be used.
2. Order an RJ11-C modular jack (USOC code), which should be installed by the telephone company. If the RJ11-C jack is not present, installation cannot occur.
3. Order a regular voice grade line or the equivalent from your telephone company's business representative.

Use one line per machine.

DDD (DIRECT DISTANCE DIAL) LINE

-or-

IDDD (INTERNATIONAL DIRECT DISTANCE DIAL) LINE IF YOU COMMUNICATE OVERSEAS

NOTE

Canon recommends an individual line following industry standards, e.g. the 2500 (Touch Tone) or 500 (Rotary/Pulse Dial) telephones. A dedicated extension off a PBX machine without "Call Waiting" can be used with the machine. Key telephone systems are not recommended because they send non-standard signals to individual telephones for ringing and special codes, which may cause a fax error. This machine is not supported on Voice Over Internet Protocol (VOIP).

C. Power Requirements

This equipment should be connected to a standard 120-volt AC, three-wire grounded outlet only. Do not connect this machine to an outlet or power line shared with other appliances that cause "electrical noise." Air conditioners, electric typewriters, copiers, and machines of this sort generate electrical noise which often interferes with communications equipment and the sending and receiving of documents.

Connection of the Equipment

This equipment complies with Part 68 of the FCC rules and the requirements adopted by the ACTA. On the rear panel of this equipment is a label that contains, among other information, a product identifier in the format US:AAAEQ##TXXXX. If requested, this number must be provided to the telephone company.

An FCC compliant telephone cord and modular jack are provided with this equipment. This equipment is designed to be connected to the telephone network or premises wiring using a compatible modular jack which is Part 68 compliant. See the Starter Guide for details.

The Ringer Equivalence Number (REN) is used to determine the number of devices that may be connected to a telephone line. Excessive RENs on a telephone line may result in the devices not ringing in response to an incoming call. In most but not all areas, the sum of RENs should not exceed five (5.0). To be certain of the number of devices that may be connected to a line, as determined by the total RENs, contact the local telephone company. The REN for this product is part of the product identifier that has the format US:AAAEQ##TXXXX. The digits represented by ## are the REN without a decimal point (e.g., 10 is a REN of 1.0).

This equipment may not be used on coin service provided by the telephone company. Connection to party lines is subjected to state tariffs.

In Case of Equipment Malfunction

Should any malfunction occur which cannot be corrected by the procedures described in this guide, disconnect the equipment from the telephone line and unplug the power cord. The telephone line should not be reconnected or the power cord plugged in until the problem is completely resolved. Users should contact Canon Authorized Service Facilities for servicing of equipment. Information regarding Authorized Service Facility locations can be obtained by calling Canon Customer Care Center (1-800-828-4040).

Rights of the Telephone Company

Should the equipment cause harm to the telephone network, the telephone company may temporarily disconnect service. The telephone company also retains the right to make changes in facilities and services which may affect the operation of this equipment. When such changes are necessary, the telephone company is required to give adequate prior notice to the user.

FCC Notice

imageCLASS MF4150: Model F149200

This device complies with Part 15 of the FCC Rules. Operation is subject to the following two conditions:

- (1) This device may not cause harmful interference, and
- (2) this device must accept an interference received, including interference that may cause undesired operation.

NOTE

This equipment has been tested and found to comply with the limits for a class B digital device, pursuant to Part 15 of the FCC Rules. These limits are designed to provide reasonable protection against harmful interference in a residential installation. This equipment generates, uses and can radiate radio frequency energy and, if not installed and used in accordance with the instructions, may cause harmful interference to radio communications. However, there is no guarantee that interference will not occur in a particular installation. If this equipment does cause harmful interference to radio or television reception, which can be determined by turning the equipment off and on, the user is encouraged to try to correct the interference by one or more of the following measures:

- Reorient or relocate the receiving antenna.
- Increase the separation between the equipment and receiver.
- Connect the equipment into an outlet on a circuit different from that to which the receiver is connected.
- Consult the dealer or an experienced radio/TV technician for help.

Use of shielded cable is required to comply with class B limits in Subpart B of Part 15 of FCC Rules.

Do not make any changes or modifications to the equipment unless otherwise specified in this manual. If such changes or modifications should be made, you could be required to stop operation of the equipment.

Canon U.S.A., Inc.
One Canon Plaza, Lake Success, NY 11042, U.S.A.
TEL No. 1-516-328-5600

The Telephone Consumer Protection Act of 1991 makes it unlawful for any person to use a computer or other electronic device to send any message via a telephone fax machine unless such message clearly contains in a margin at the top or bottom of each transmitted page or on the first page of the transmission, the date and time it is sent and an identification of the business or other entity, or other individual sending the message and the telephone number of the sending machine or such business, other entity, or individual.

In order to program this information into the machine, follow the instructions in the Starter Guide.

Pre-Installation Requirements for Canon Facsimile Equipment

A. Location

Supply a suitable table, cabinet, or desk. See p. 13-1 for the machine's weight and dimensions.

B. Order Information

1. Provide only a single-line to touch-tone or rotary telephone set terminated with a standard 4-pin modular phone plug. (Touch-tone is recommended if available in your area.)
2. Order an CA11A modular jack (USOC code), which should be installed by the telephone company. If the CA11A jack is not present, installation cannot occur.
3. Order a normal business line from your telephone company's business representative. The line should be a regular voice grade line or equivalent. Use one line per machine.
DDD (DIRECT DISTANCE DIAL) LINE
-or-
IDDD (INTERNATIONAL DIRECT DISTANCE DIAL) LINE IF YOU COMMUNICATE OVERSEAS

NOTE

Canon recommends an individual line following industry standards, e.g., the 2500 (touch tone) or 500 (rotary/pulse dial) telephones. A dedicated extension off a PBX machine without "Camp On" signals is also permissible with the machine. Key telephone systems are not recommended because they send non-standard signals to individual telephones for ringing and special codes, which may cause a fax error.

C. Power Requirements

The power outlet should be a three-prong grounded receptacle (Single or Duplex). It should be independent from copiers, heaters, air conditioners or any electric equipment that is thermostatically controlled. The rated value is 120 volts and 15 amperes. The CA11A modular jack should be relatively close to the power outlet to facilitate installation.

Notice

This equipment meets the applicable Industry Canada Terminal Equipment Technical Specifications. This is confirmed by the registration number. The abbreviation, IC, before the registration number signifies that registration was performed based on a Declaration of Conformity indicating that Industry Canada technical specifications were met. It does not imply that Industry Canada approved the equipment.

Cet appareil est conforme aux Spécifications techniques des équipements terminaux de l'Industrie du Canada.

Ceci est confirmé par le numéro d'enregistrement. L'abréviation IC précédant le numéro d'enregistrement signifie que l'enregistrement a été effectué sur la base de la Déclaration de conformité indiquant que le produit est conforme aux spécifications techniques du Canada. Ceci n'implique pas que le produit ait été approuvé par l'industrie du Canada.

Before installing this equipment, users should ensure that it is permissible to be connected to the facilities of the local telecommunications company. The equipment must also be installed using an acceptable method of connection. The customer should be aware that compliance with the above conditions may not prevent degradation of service in some situations.

Repairs to certified equipment should be coordinated by a representative designated by the supplier. Any repairs or alterations made by the user to this equipment, or equipment malfunctions, may give the telecommunications company cause to request the user to disconnect the equipment.

Users should ensure for their own protection that the electrical ground connections of the power utility, telephone lines and internal metallic water pipe system, if present, are connected together. This precaution may be particularly important in rural areas.

 **CAUTION**

Users should not attempt to make such connections themselves, but should contact the appropriate electric inspection authority, or electrician, as appropriate.

 **NOTE**

This Class B digital apparatus meets all requirements of the Canadian Interference- Causing Equipment Regulations.

Cet appareil numérique de la classe B respecte toutes les exigences du Règlement sur le matériel brouilleur du Canada.

The Ringer Equivalence Number (REN) for this terminal equipment is 1.0. The REN assigned to each terminal equipment provides an indication of the maximum number of terminals allowed to be connected to a telephone interface. The termination on an interface may consist of any combination of devices subject only to the requirement that the sum of the Ringer Equivalence Numbers of all the devices does not exceed five.

Le Nombre d'équivalence Ringer (REN) de cet appareil terminal est 1.0. Le REN attribué à chaque équipement terminal fournit une indication sur le nombre maximum de terminaux pouvant être connectés sur une interface téléphonique. La terminaison sur une interface peut consister en n'importe quelle combinaison d'appareils, à la condition seulement que la somme des Nombres d'équivalence Ringer de tous les appareils ne soit pas supérieure à 5.

CANON CANADA INC.

1-800-652-2666

9 A.M. to 8 P.M. EST Monday through Friday (excluding holidays)

Laser Safety

This machine complies with 21 CFR Chapter 1 Subchapter J as a Class 1 laser product under the U.S. Department of Health and Human Services (DHHS) Radiation Performance Standard according to the Radiation Control for Health and Safety Act of 1968. This means that the machine does not produce hazardous radiation. Since radiation emitted inside the machine is completely confined within protective housings and external covers, the laser beam cannot escape from the machine during any phase of user operation.

CDRH Regulations

The Center for Devices and Radiological Health (CDRH) of the U.S. Food and Drug Administration implemented regulations for laser products on August 2, 1976. These regulations apply to laser products manufactured from August 1, 1976. Compliance is mandatory for products marketed in the United States.

CAUTION

Use of controls, adjustments, or performance of procedures other than those specified in this manual may result in hazardous radiation exposure.

The label is attached to the laser scanner machine inside the machine and is not in a user access area.



DANGER - Invisible laser radiation when open.
AVOID DIRECT EXPOSURE TO BEAM.

CAUTION - CLASS 3B, INVISIBLE LASER RADIATION WHEN OPEN.
AVOID EXPOSURE TO THE BEAM.

WARNING - KLASS 3B OSYNLIG LASERSTRÅLNING NÅR DENNA DEL ÄR ÖPPNAD. STRÅLEN ÄR FARLIG.

ATTENTION - RAYONNEMENT LASER INVISIBLE DE CLASSE 3B.
EN CAS D'OUVERTURE ÉVITEZ L'EXPOSITION AU FAISCEAU.

VORSICHT - UNSICHTBARE LASERSTRÄHLUNG KLASSE 3B, WENN ABDECKUNG GEÖFFNET, NICHT DEM STRAHL AUSSETZEN.

PRECAUCIÓN - RADIACIÓN LASER INVISIBLE DE CLASE 3B PRESENTE AL ABRIR.
EVITE LA EXPOSICIÓN AL HAZ.

VAROITUS - LUOKAN 3B NÄKYMÄTTÖMÄLLE LASER-SÄTEILYÄ AVATTUNA.
VÄLTÄ ALTISTUMISTA SÄTEELLE.

注意 - ここを開くとクラス3B不可視レーザー放射が出ます。ビームに身をさらさないこと。

注意 - 打开时，存在不可见的3B类激光辐射，请避免接触该激光束

注意 - 打開機器蓋板時有3B級不可視雷射光釋出，應避免曝射

주의 - 열리면 등급 3B 비가시 레이저 방사선이 방출됩니다.
광선에 노출을 피하십시오.

FC6-5293

1

Before Using the Machine

Machine Components

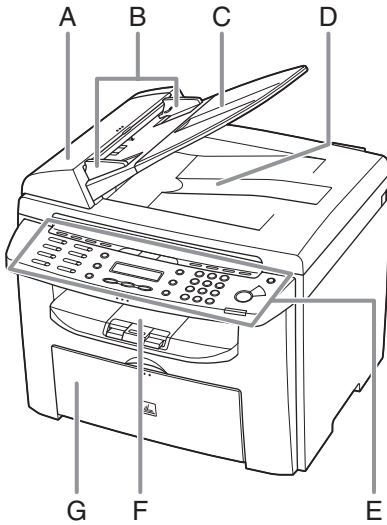

- A ADF (Automatic Document Feeder)
Holds documents and feeds them automatically into the scanning area.
- B Slide guides
Adjust to the width of the document.
- C Document feeder tray
Holds documents.
- D Document delivery tray
Receives documents.
- E Operation panel
Controls the machine.
- F Output tray
Receives copies, prints and faxes.
- G Paper feeding tray
Loads the paper supply.

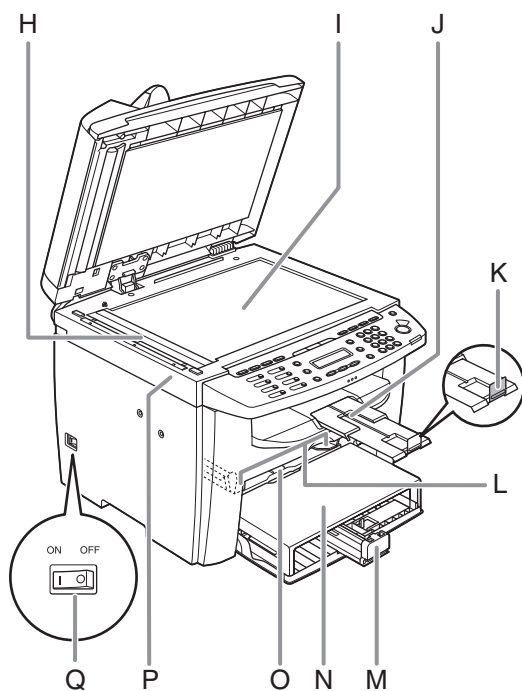

- H** Scanning area
Scans documents from the ADF.
- I** Platen glass
Place documents.
- J** Output tray extension
Extension for the output tray.
- K** Paper stopper
Prevents the paper from falling off the output tray.
Open the paper stopper from its original position for LTR/A4 paper. For LGL paper, pull out the output tray extension first, and then open the paper stopper.
- L** Slide guides for multi-purpose tray
Adjusts to the width of the paper.
- M** Paper guide rail
Holds the paper supply.
- N** Dust cover
Protects the paper supply in the paper feeding tray from the dirt and dust.
- O** Multi-purpose tray
Feeds paper when you insert one by one manually.
- P** Scanning platform
Open this platform when replacing the toner cartridge or clearing paper jams.
- Q** Main power switch
Turn the power on or off.



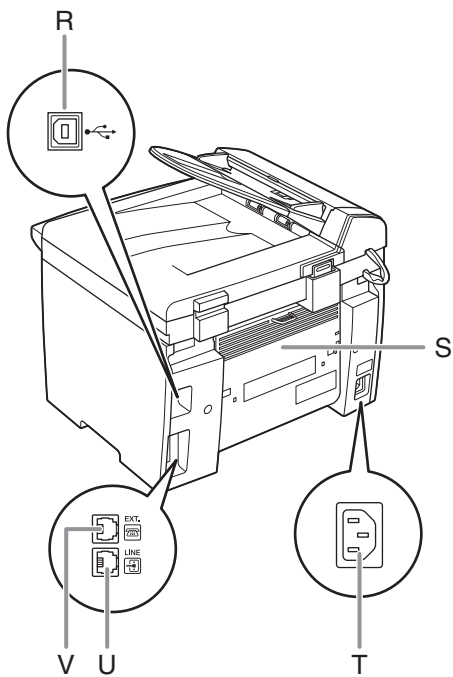

- R USB port
Connect the USB (Universal Serial Bus) cable.
- S Rear cover
Open this cover when clearing paper jams.
- T Power socket
Connect the power cord.
- U Telephone line jack
Connect the external telephone cable.
- V External device jack
Connect an external device.

Operation Panel

Main Operation Panel

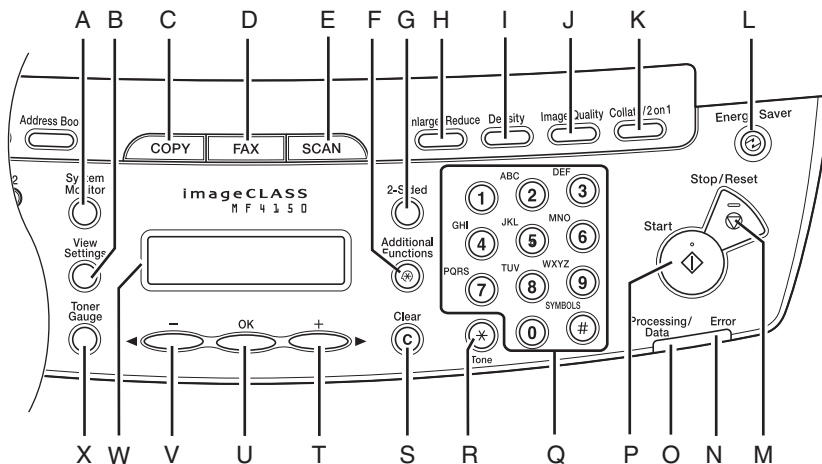

- | | |
|--|---|
| <p>A [System Monitor] key
Press to check print status, fax status, print and scan counts, remaining memory, or print transmission/reception results.</p> <p>B [View Settings] key
Press to confirm settings of the copy function.</p> <p>C [COPY] key
Press to switch to the Copy mode.</p> <p>D [FAX] key
Press to switch to the Fax mode.</p> <p>E [SCAN] key
Press to switch to the Scan mode.</p> <p>F [Additional Functions] key
Press to select or cancel the modes in Additional Functions.</p> | <p>G [2-Sided] key
Press to set two-sided copying.</p> <p>H [Enlarge/Reduce] key
Press to enlarge or reduce copy ratio.</p> <p>I [Density] key
Press to adjust copy or fax density.</p> <p>J [Image Quality] key
Press to select image quality for copy or fax.</p> <p>K [Collate/2 on 1] key
Press to collate copies, or press to set 2 on 1 copying.</p> <p>L [Energy Saver] key
Press to set or cancel the Sleep mode manually. The key lights green when the Sleep mode is set, and goes off when the mode is canceled.</p> |
|--|---|



- M** [Stop/Reset] key
Press to stop a current job. Also, press to return the machine to the standby mode.
- N** Error indicator
Flashes when an error has occurred.
- O** Processing/Data indicator
Flashes during sending or receiving faxes.
Lights when the machine has waiting jobs and stores the data in memory.
- P** [Start] key
Press to start copying, scanning and sending faxes.
- Q** Numeric keys
Enter letters and numbers.
- R** [Tone] key
Press to switch from rotary pulse to tone dialing.
- S** [Clear] key
Press to clear entered alphanumeric characters.
- T** [+▶] key
Press to increase the value for various settings. Also press to see the next item in the menu.
- U** [OK] key
Press to accept a set function or mode.
- V** [◀-] key
Press to decrease the value for various settings. Also press to see the previous item in the menu.
- W** LCD display
Displays messages and prompts during operation. Displays selection, text, and numbers when adjusting the settings.
- X** [Toner Gauge] key
Press to check the toner remaining in the toner cartridge.

Facsimile Operation Panel

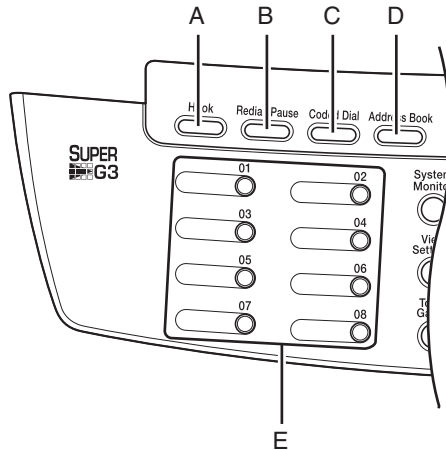

- A [Hook] key
Press when you want to dial without lifting up the handset of the external telephone.
- B [Redial/Pause] key
Press to redial the last dialed number when fax is standing by, or press to insert a pause when entering a fax number.
- C [Coded Dial] key
Press to perform coded dialing.
- D [Address Book] key
Press to search pre-registered destinations under one-touch speed dialing keys or coded dialing numbers by name.
- E One-Touch Speed Dial keys
Press to use one-touch speed dialing (Pre-registered frequently used numbers or group dialing).

LCD (Standby Mode)

Fax Mode

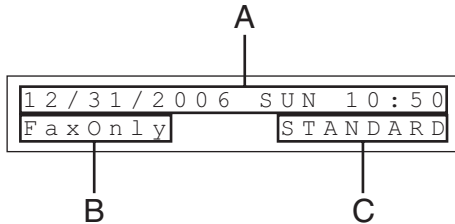

- A Date & Time
- B Receive mode
- C Image quality

Copy Mode

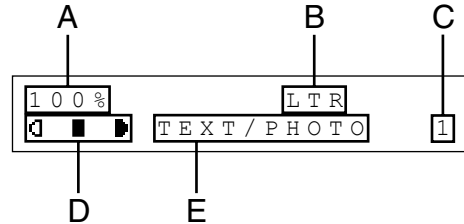

- A Zoom ratio
- B Paper size
- C Quantity
- D Density
- E Image quality

Scan Mode

SCANNING MODE

NOTE

- Depending on your needs, you can change the standby display which appears when the main power switch is turned on. For details, see "Setting Menu," on p. 12-5.
- When the main power switch is turned on, the LCD displays <PLEASE WAIT> first, and then displays <INITIALIZING...> until the standby display appears. It is also possible to see the standby display without having <INITIALIZING...> shown.
- If the machine remains idle for one minute, the display returns to the standby mode (Auto Clear Function).

Toner Cartridge

The lifetime of the Canon genuine starter toner cartridge which comes with the machine is approximately 1,000 pages, the Canon genuine replacement toner cartridge is approximately 2,000 pages. The page counts are on the basis of “ISO/IEC 19752”^{*} when printing A4 size paper with the default print density setting. The level of toner consumption varies depending on the type of documents printed. If your average document contains a lot of graphics, tables, or charts, the life of the toner cartridge will be shorter as they consume more toner. To purchase the Canon genuine replacement toner cartridge, contact your local Canon dealer or Canon Customer Care Center (U.S.A.: 1-800-828-4040, Canada: 1-800-652-2666).

^{*} “ISO/IEC 19752” is the global standard related to “Method for the determination of toner cartridge yield for monochromatic electrophotographic printers and multi-function devices that may contain printer components” issued by ISO (International Organization for Standardization).

Toner Cartridge name:
Canon Cartridge 104

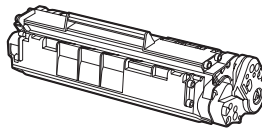

Model Name	Type	Supported Canon Genuine Cartridge	Print Yield
MF4150	Bundled	Canon Cartridge 104 Starter	Approx. 1,000 pages
	Replacement	Canon Cartridge 104	Approx. 2,000 pages

Maintaining the Toner Cartridge

- Keep the toner cartridge away from computer screens, disk drives, and floppy disks. The magnet inside the toner cartridge may harm these items.
- Avoid locations subject to high temperature, high humidity, or rapid changes in temperature.
- Do not expose the toner cartridge to direct sunlight or bright light for more than five minutes.
- Store the toner cartridge in its protective bag. Do not open the bag until you are ready to install the toner cartridge in the machine.
- Save the toner cartridge's protective bag in case you need to repack and transport the toner cartridge at a later date.
- Do not store the toner cartridge in a salty atmosphere or where there are corrosive gases such as from aerosol sprays.
- Do not remove the toner cartridge from the machine unnecessarily.
- Do not open the drum protective shutter on the toner cartridge. Print quality may deteriorate if the drum surface is exposed to light or is damaged.
- Always hold the toner cartridge by its handle to avoid touching the drum protective shutter.
- Do not stand the toner cartridge on end, and do not turn it upside down. If toner becomes caked in the toner cartridge, it may become impossible to free it even by shaking the toner cartridge.

CAUTION

Do not place the toner cartridge in fire. Toner powder is flammable.

Checking the toner level

You can check the amount of toner remaining in the toner cartridge by pressing the [Toner Gauge] key. The toner level is displayed in the LCD at four levels.

If the toner gauge indicates that the toner is empty, it is recommended that the toner cartridge be replaced. (See “Replacing the Toner Cartridge,” on p. 10-8.)

Toner full



Toner high



Toner low



Toner empty



NOTE

To return to the standby mode, press [Stop/Reset]

Timer Settings

Setting the Sleep Mode

When the machine remains idle for a certain period of time, it automatically enters the Sleep mode.

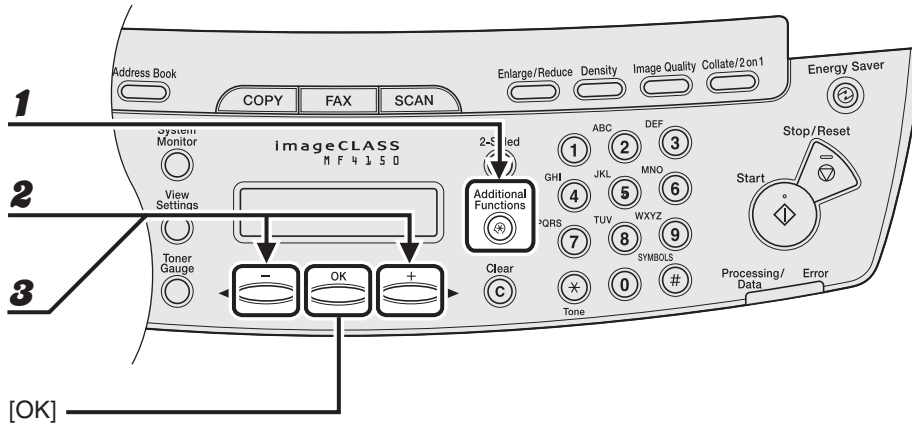

- 1** Press [Additional Functions].
- 2** Press [◀] or [▶] to select <TIMER SETTINGS>, then press [OK].
- 3** Press [◀] or [▶] to select <AUTO SLEEP>, then press [OK].

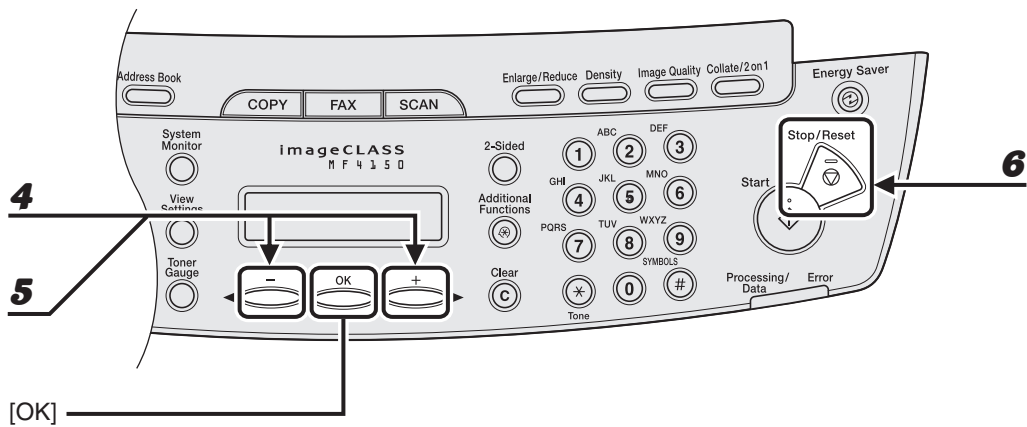

- 4** Press [**←**] or [**→**] to select <ON>, then press [OK].
- 5** Press [**←**] or [**→**] to select the desired interval, then press [OK].
 You can set the interval from 3 to 30 minutes (in one-minute increments).
 You can also enter values with the numeric keys.
- 6** Press [Stop/Reset] to return to the standby mode.



 **NOTE**

- To resume the normal mode from the Sleep mode, press [Energy Saver] on the operation panel.
- To enter the Sleep mode manually, press [Energy Saver] on the operation panel.
- The machine will not enter the Sleep mode when:
 - the machine is in operation
 - the Processing/Data indicator lights or flashes
 - an error code or message appears on the display and the Error indicator flashes
 - no paper is loaded in the paper feeding tray
 - paper is loaded in the multi-purpose tray
 - a paper jam occurs in the machine
- The machine will leave the Sleep mode when:
 - you press [Energy Saver] on the operation panel
 - a fax is received
 - the handset of the external telephone is off the hook
 - a print job is sent from a computer, and the print is started

Setting Daylight Saving Time

In some countries or areas, time is advanced throughout the summer season. This is called “Daylight Saving Time.”

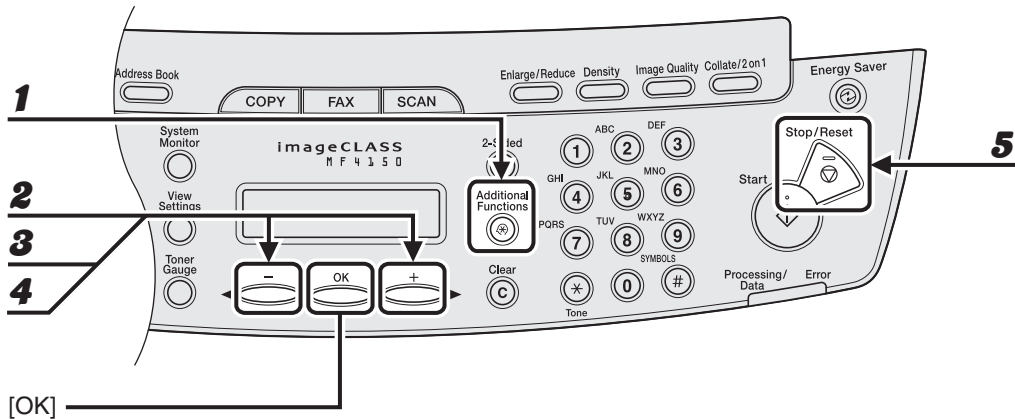

- 1** Press [Additional Functions].
- 2** Press [◀] or [▶] to select <TIMER SETTINGS>, then press [OK].
- 3** Press [◀] or [▶] to select <DAYLIGHT SV.TIME>, then press [OK].
- 4** Press [◀] or [▶] to select <ON> or <OFF>, then press [OK].
<ON>: adapts to Daylight Saving Time.
<OFF>: does not adapt to Daylight Saving Time.
- 5** Press [Stop/Reset] to return to the standby mode.

2

Document Handling

Document Requirements

	Platen Glass	ADF
Type	<ul style="list-style-type: none">– Plain paper– Thick documents– Photographs– Small documents (e.g., index cards)– Special types of paper (e.g., tracing paper*¹, transparencies*¹, etc.)– Book (Height: max. 1" (24 mm))	Plain paper (Multipage documents of the same size, thickness and weight or one page documents.)
Size (W x L)	Max. 8 1/2" x 11 5/8" (Max. 216 x 296 mm)	Max. 8 1/2" x 14" (Max. 216 x 356 mm) Min. 4 1/8" x 5 7/8" (Min. 105 x 148.5 mm)
Weight	Max. 4.4 lb (2 kg)	11 to 28 lb bond (40 to 105 g/m ²)
Quantity	1 sheet	Max. 35 sheets* ² (Max. 10 sheets for LGL documents)

*¹ When copying a transparent document such as tracing paper or transparencies, use a piece of plain white paper to cover the document after placing it face-down on the platen glass.

*² 21 lb bond (80 g/m²) paper

- Do not place the document on the platen glass or in the ADF until the glue, ink or correction fluid on the document is completely dry.
- Remove all fasteners (staples, paper clips, etc.) before loading the document in the ADF.
- To prevent document jams in the ADF, do not use any of the following:
 - Wrinkled or creased paper
 - Carbon paper or carbon-backed paper
 - Curled or rolled paper
 - Coated paper
 - Torn paper
 - Onion skin or thin paper
 - Documents with staples or paper clips attached
 - Paper printed with a thermal transfer printer
 - Transparencies

Scanning Area

Make sure your document's text and graphics fall within the shaded area in the following diagram. Note that the margin widths listed are approximate and there may be slight variations in actual use.

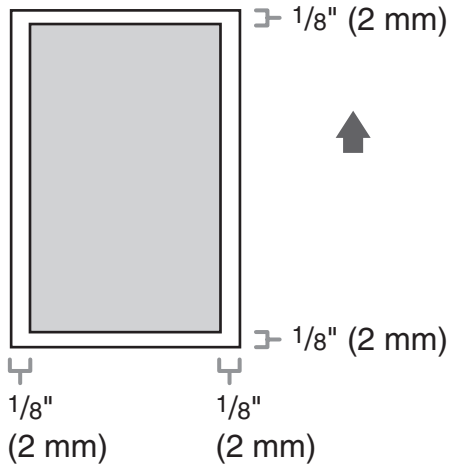

Loading Documents

On the Platen Glass

- 1** Lift up the ADF.

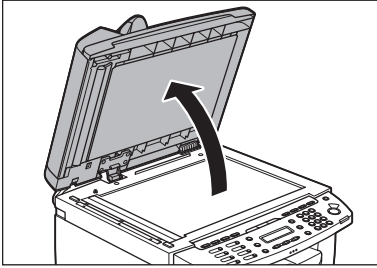

- 2** Place your document face down.

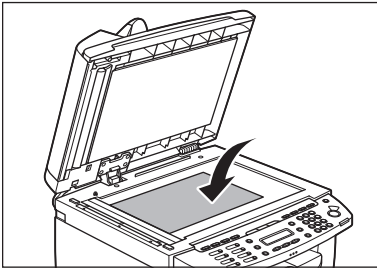

3 Align the document with the appropriate paper size marks.

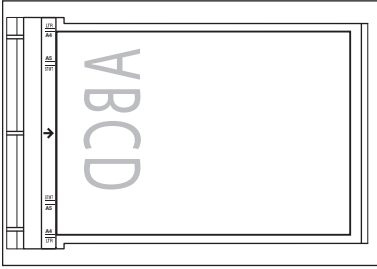

If your document does not match any of the paper size marks, align the center of your document with the arrow mark.

4 Gently close the ADF.

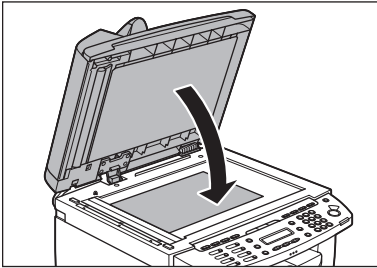

The document is ready for scanning.

CAUTION

- When closing the ADF be careful not to get your fingers caught, as this may result in personal injury.
- Do not press down the ADF forcefully, as this may damage the platen glass and cause personal injury.

NOTE

Remove the document from the platen glass when scanning is complete.

In the ADF

- 1** Fan the document stack and even the edges.

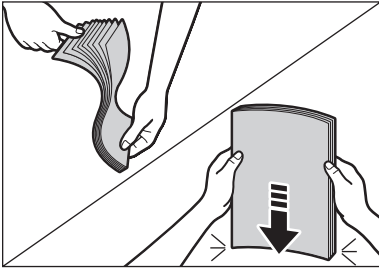

- 2** Adjust the slide guides to the width of the documents.

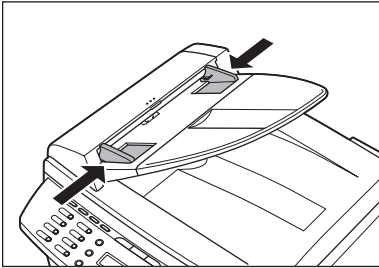

3 Neatly place the documents face up in the document feeder tray.

When enlarging STMT originals to LTR paper, place your originals horizontally.

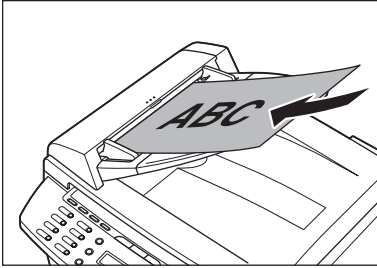

The document is ready for scanning.

NOTE

- Do not add or remove documents while they are being scanned.
- When scanning is complete, remove the documents from the document delivery tray to avoid paper jams.
- Avoid using ADF to scan the same document more than 30 times. When scanned repeatedly, documents can become folded or torn, which may cause paper jams.
- If the feeder rollers are soiled from scanning a document written in pencil, clean them. (See “Cleaning the Machine,” on p. 10-1.)

3 Print Media

Paper Requirements

	Paper feeding tray	Multi-purpose tray
Size (W x L)	LTR, LGL, A4, B5, A5, Executive, Envelope (COM10, Monarch, DL, ISO-C5), Oficio, Brazil-Oficio, Mexico-Oficio, Folio, Government-LTR, Government-LGL, Foolscap (3" x 5" to 8 1/2" x 14" (76 x 127 to 216 x 356 mm))	
Weight	16 to 43 lb bond (60 to 163 g/m ²)	
Quantity	Max. 250 sheets (Height: max. 1" (25 mm))	Max. 1 sheet
Type	Plain Paper, Plain Paper L, Heavy Paper, Heavy Paper H, Transparency	

NOTE

The default paper size is LTR. If you use a different paper size, you must change the paper size settings. (See "Setting Paper Size and Type," on p. 3-7.)

Printable Area

The shaded area indicates the approximate printable area of LTR paper and envelope. Note that the margin widths listed are approximate and there may be slight variations in actual use.

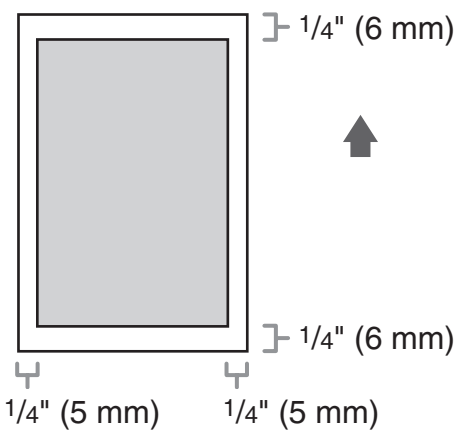

Paper Guidelines

- To prevent paper jams, do not use any of the following:
 - Wrinkled or creased paper
 - Curled or rolled paper
 - Coated paper
 - Torn paper
 - Damp paper
 - Very thin paper
 - Paper which has been printed on using a thermal transfer printer (Do not copy on the reverse side.)
- The following types of paper do not print well:
 - Highly textured paper
 - Very smooth paper
 - Shiny paper
- Make sure the paper is free from dust, lint, and oil stains.
- Be sure to test paper before purchasing large quantities.
- Store all paper wrapped and on a flat surface until ready for use. Keep opened packs in their original packaging in a cool, dry location.
- Store paper at 64.4°F–75.2°F (18°C–24°C), 40%–60% relative humidity.
- Use only the transparencies designed for laser printers. Canon recommends you to use Canon type transparencies with this machine.

Loading Paper

To load paper in the paper feeding tray, see “Set Up the Paper Trays and Load Paper,” in the Starter Guide.

Into the Multi-Purpose Tray

Use the multi-purpose tray when you want to copy or print on the different paper which is in the paper feeding tray. Load paper one by one in the multi-purpose tray.

NOTE

- The paper in the multi-purpose tray is fed prior to the paper in the paper feeding tray.
- The recommended envelopes are COM10, MONARCH, DL, and ISO-C5. Using other envelopes may affect the quality of the printout.
- Make sure to set the correct paper size in the printer driver. (See Online Help.)
- When printing received documents, it is possible to feed paper only from the paper feeding tray. If paper is loaded into the multi-purpose tray, <REMOVE MP PAPER> appears.

- 1** Spread the paper guides a little wider than the actual paper width.

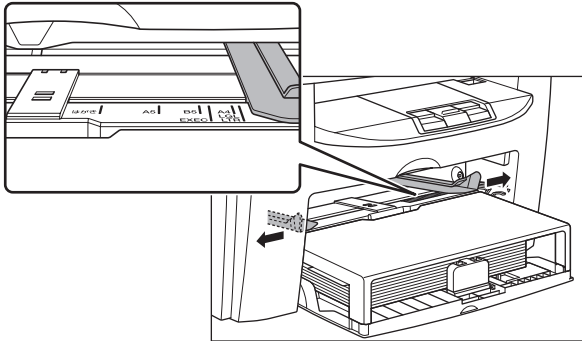

- 2** When setting a paper, gently insert the paper into the multi-purpose tray with the print side up.

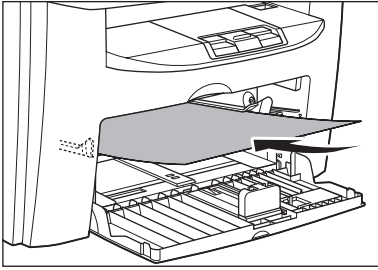

NOTE

When you load paper with a logo on, position the paper with the print side up (logo side) and insert it so that the top of the paper feeds first in the multi-purpose tray.

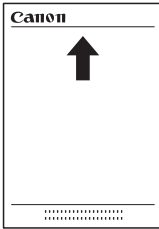

When setting an envelope, gently insert the envelope into the multi-purpose tray with the print side up and the right edge (i.e., closer to the stamp) first.

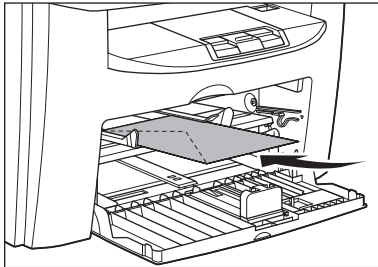

- 3** Slide the paper guides so that they fit to both sides of the paper.

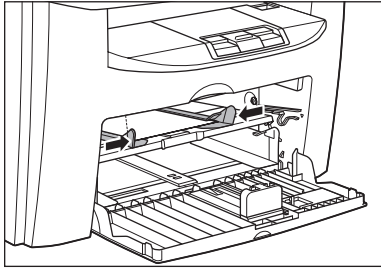

 **NOTE**

If the paper guides are not adjusted correctly for the size of the paper, the quality of your printouts may be adversely affected.

- 4** Specify the size and the type of the paper you load.

For details on how to specify the paper size and type, see “Setting Paper Size and Type,” on p. 3-7.

Setting Paper Size and Type

The default setting is <LTR> and <PLAIN PAPER>. When you place other sizes and/or types of paper, follow this procedure to change the settings.

The procedure is same for the paper feeding tray and multi-purpose tray except for selecting the paper feeding tray or multi-purpose tray in step 3 and 6.

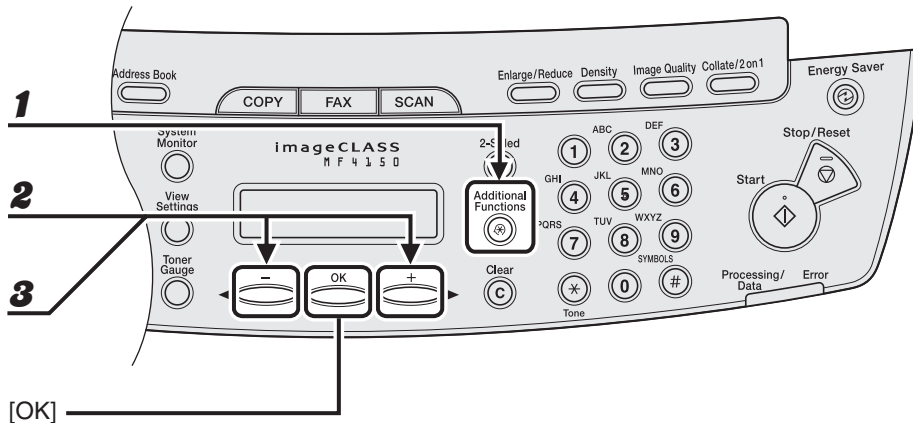

- 1** Press [Additional Functions].
- 2** Press [←] or [→] to select <PAPER SETTINGS>, then press [OK].
- 3** Press [←] or [→] to select <CASSETTE> or <MP TRAY>, then press [OK].

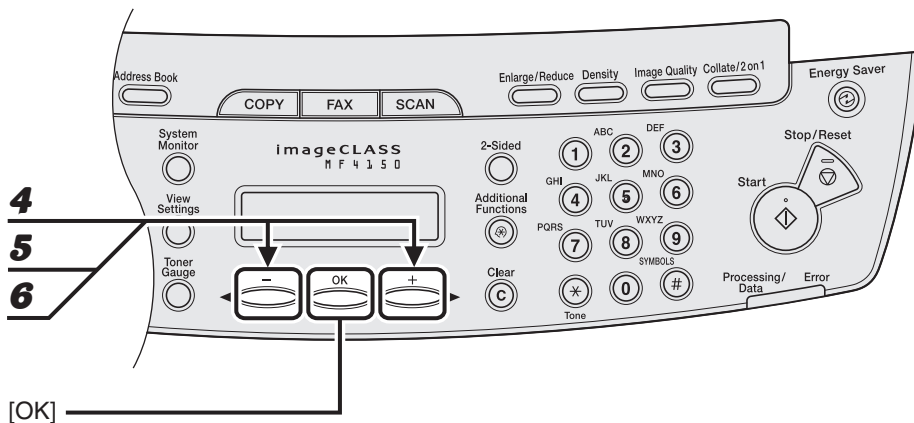

4 Press [**←**] or [**→**] to select <PAPER SIZE>, then press [OK].

5 Press [**←**] or [**→**] to select the paper size, then press [OK].

<LTR>, <LGL>, <A4>, <B5>, <A5>, <EXECUTIVE>, <COM10>, <MONARCH>, <DL>, <ISO-C5>, <OFICIO>, <BRAZIL-OFICIO>, <MEXICO-OFICIO>, <FOLIO>, <GOVERNMENT-LETTER>, <GOVERNMENT-LEGAL>, <FOOLSCAP>

NOTE

The paper sizes available will vary depending on the country where the unit was purchased.

6 Press [**←**] or [**→**] to select <CASSETTE> or <MP TRAY>, then press [OK].



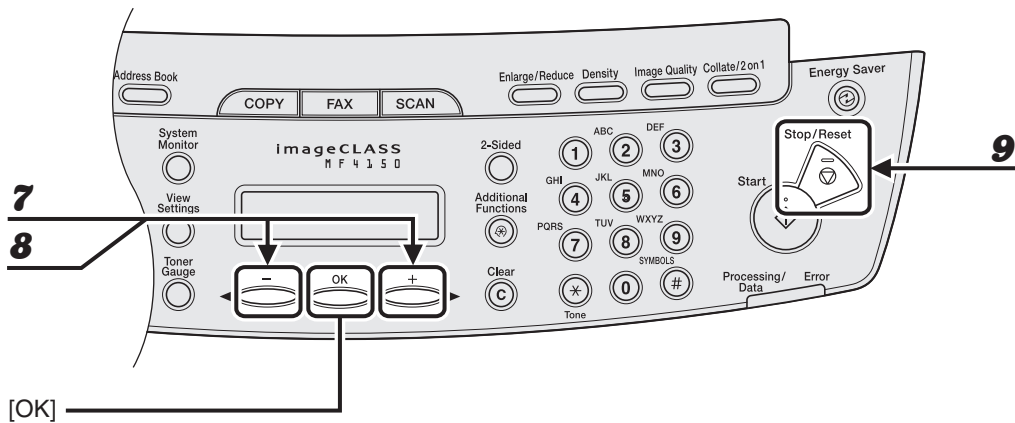

7 Press [**←**] or [**→**] to select <PAPER TYPE>, then press [OK].

8 Press [**←**] or [**→**] to select the paper type, then press [OK].

You can select from the following paper types:

<PLAIN PAPER> or <PLAIN PAPER L>^{*1} for Plain paper (17 lb to 24 lb (64 g/m² to 90 g/m²))

<HEAVY PAPER> or <HEAVY PAPER H>^{*2} for Heavy paper (Paper feeding tray: 28 lb to 34 lb (105 g/m² to 128 g/m²), Multi-purpose tray: 28 lb to 43 lb (105 g/m² to 163 g/m²)) or Envelope
<TRANSPARENCY> for Transparency

^{*1} If paper curls excessively when printed with <PLAIN PAPER> selected, select <PLAIN PAPER L>.

^{*2} If print fixing is not sufficient when printed with <HEAVY PAPER> selected, select <HEAVY PAPER H>.

9 Press [Stop/Reset] to return to the standby mode.

4 Sending Faxes

Follow this procedure to send a fax.

For advanced sending features, see Chapter 1, “Advanced Fax Features,” in the Advanced Guide.

1 Set a Document

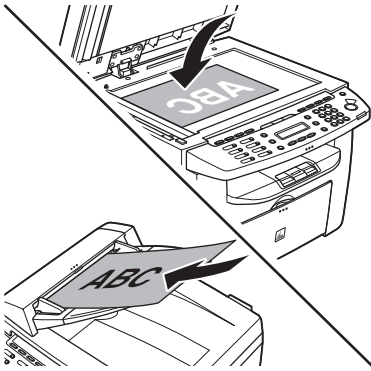

Place the document on the platen glass or load it in the ADF.

For documents you can fax, see “Document Requirements,” on p. 2-1.

2 Enter the Fax Mode

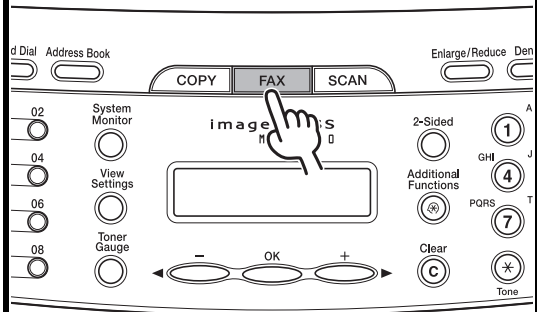

Press [FAX].

The FAX indicator lights and the machine enters the fax standby mode.

What if...

- **You want to adjust the resolution and density:**

See “Scan Settings,” on p. 4-3.

3 Enter the Fax Number

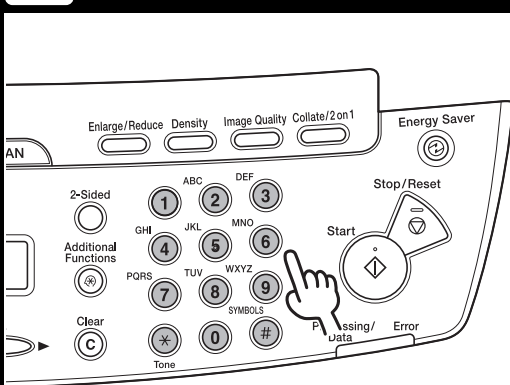

Dial the recipient's fax number with the numeric keys.

Ex.

☎ = 0 1 2 X X X X X X X _

What if...

- **You enter a wrong number:**
Go back to the wrong digit with [←], then press [Clear] to delete it. Or press and hold [Clear] to delete the entire entry. Then try again.

4 Send the Document

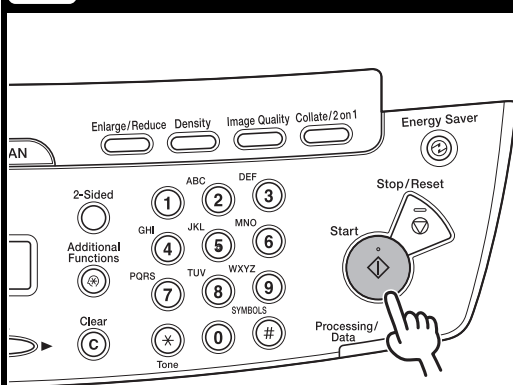

Press [Start].

When you set the document on the platen glass, press [Start] for each document. When scanning is complete, press [OK].
If <CONFIRM NEW DEST.> is set to <ON> in the <TX SETTINGS> of the <FAX SETTINGS> menu, you need to enter the fax number again after pressing [Start].

What if...

- **You press [Stop/Reset] to cancel a job during scanning documents or after scanning documents:**
The <CANCEL DURING TX/RX?> message appears. Press [←] to select <Yes>.

Scan Settings

You can adjust the image quality and density of the document you send. The higher image quality you set, the better the output will be, but the longer the transmission will take. Adjust the scan settings according to the type of document you are sending.

Image Quality

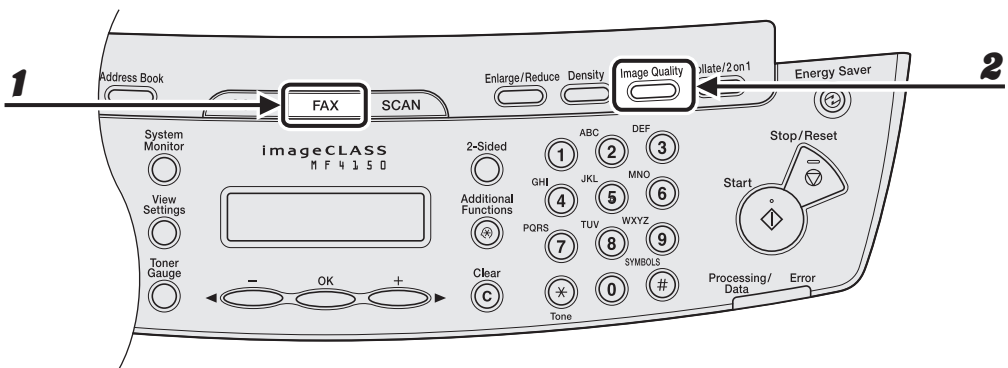

1 Press [FAX].

2 Press [Image Quality].

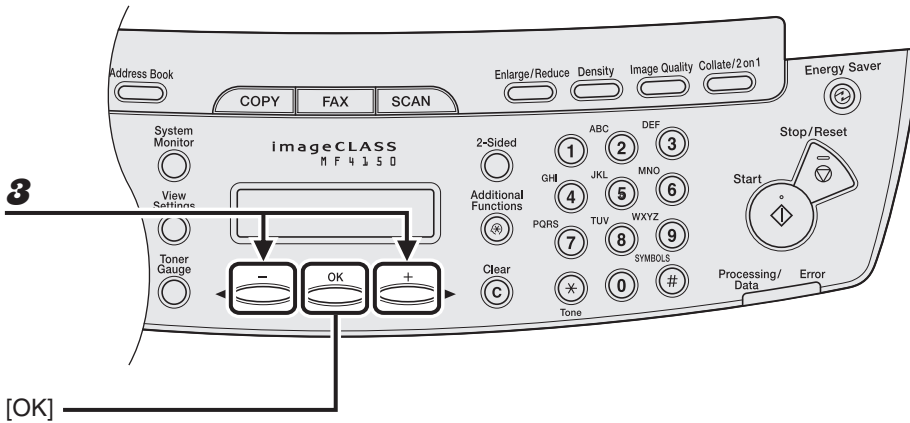

3 Press [←] or [→] to select the resolution, then press [OK].

- <STANDARD> for most text-only documents. (200 x 100 dpi)
- <FINE> for fine-print documents (the resolution is twice that of <STANDARD>). (200 x 200 dpi)
- <PHOTO> for documents that contain photographs (the resolution is twice that of <STANDARD>). (200 x 200 dpi)
- <SUPER FINE> for documents that contain fine print and images (the resolution is four times that of <STANDARD>). (200 x 400 dpi)

Density

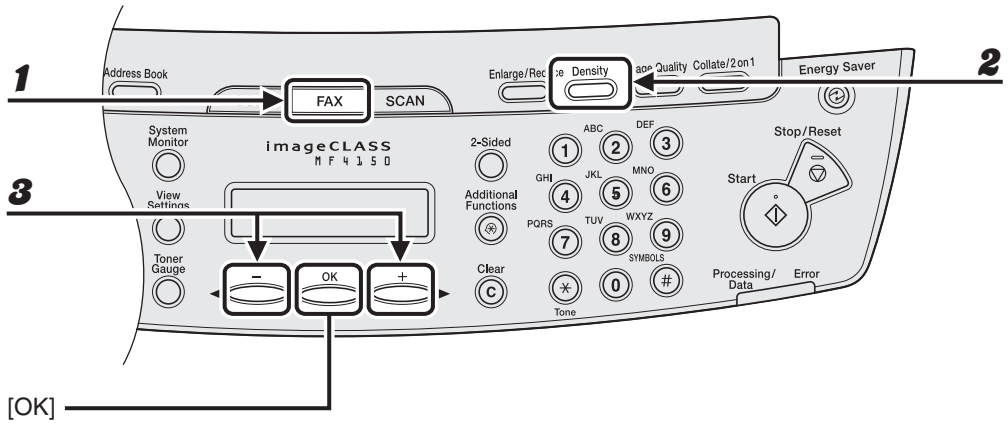

1 Press [FAX].

2 Press [Density].

Ex.

```
DENSITY  
-LT ████■█████ DK+
```

3 Press [◀] or [▶] to adjust the density, then press [OK].

[▶]: to make light documents darker

[◀]: to make dark documents lighter

Speed Dialing

Speed dialing allows you to dial fax/telephone numbers by simply pressing one or a few keys. The following speed dialing methods are available:

- **One-Touch Speed Dialing (p. 4-7)**
 - Register a fax/telephone number for one-touch speed dialing, then to dial the number, simply press the one-touch speed dialing key assigned to that number. You can register up to 8 one-touch speed dialing keys, including group dialing.
- **Coded Dialing (p. 4-14)**
 - Register a fax/telephone number for coded dialing, then to dial the number, simply press [Coded Dial] and enter the two-digit code assigned to that number. You can register up to 100 coded dialing codes.
- **Group Dialing (p. 4-21)**
 - Register a group of fax numbers (must be registered for one-touch speed dialing and/or coded dialing) for group dialing, then to send a document to all numbers in that group, simply press the one-touch speed dialing key assigned to that group. You can register up to 50 destinations into a one-touch speed dialing key as a group.

Registering Recipients for Speed Dialing

For each recipient, you can register:

- Name
- Fax number (required)

● Registering One-Touch Speed Dialing

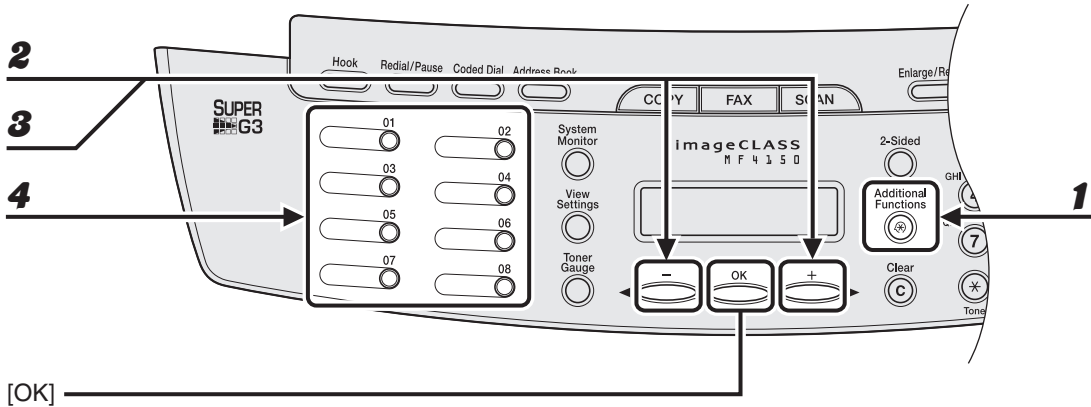

- 1** Press [Additional Functions].
- 2** Press [◀] or [▶] to select <ADDRESS BOOK SET.>, then press [OK].
- 3** Press [◀] or [▶] to select <1-TOUCH SPD DIAL>, then press [OK].
- 4** Press a one-touch speed dialing key (01 to 08) for which you want to register the fax number, then press [OK].

You can also select a one-touch speed dialing number with [◀] or [▶].

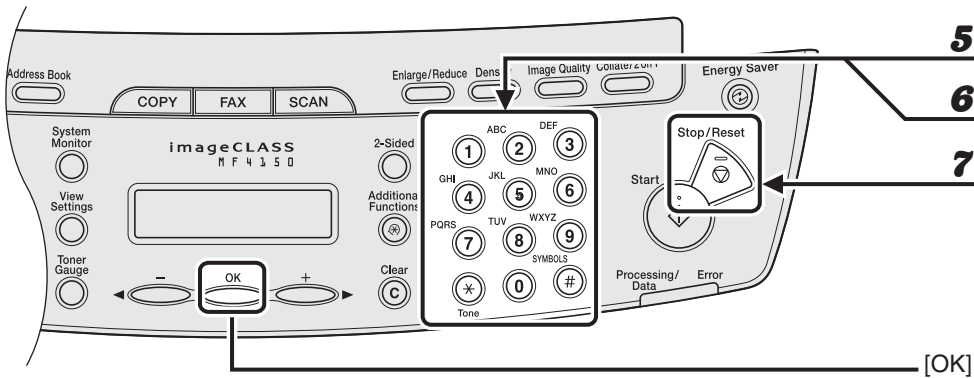

5 Enter the destination name (max. 20 characters, including spaces) with the numeric keys, then press [OK].

Ex.

NAME	[A]
CAN	

6 Enter the fax number you register (max. 50 digits, including spaces and pauses) with the numeric keys, then press [OK].

Ex.

TEL NUMBER ENTRY
0 1 2 X X X X X X X X _

To register another one-touch speed dialing key, repeat the procedure from step 4.

7 Press [Stop/Reset] to return to the standby mode.

● Editing One-Touch Speed Dialing

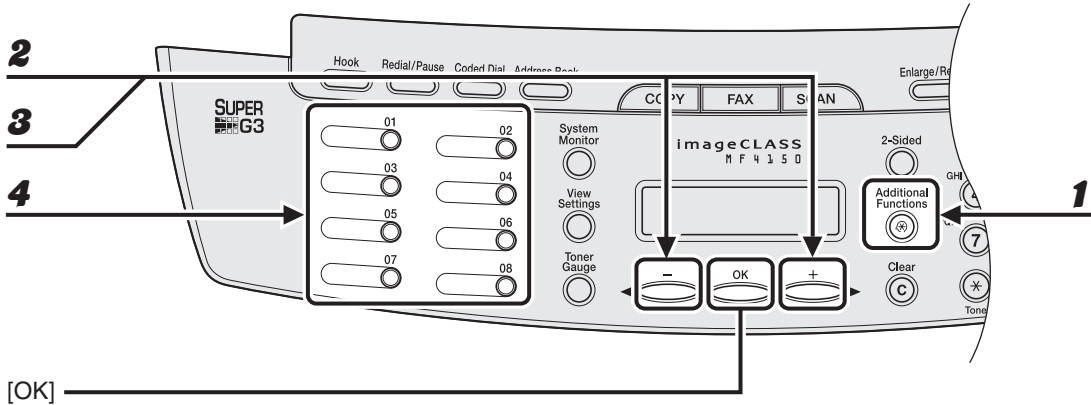

- 1** Press [Additional Functions].
- 2** Press [◀] or [▶] to select <ADDRESS BOOK SET.>, then press [OK].
- 3** Press [◀] or [▶] to select <1-TOUCH SPD DIAL>, then press [OK].
- 4** Press the one-touch speed dialing key (01 to 08) you want to edit, then press [OK].

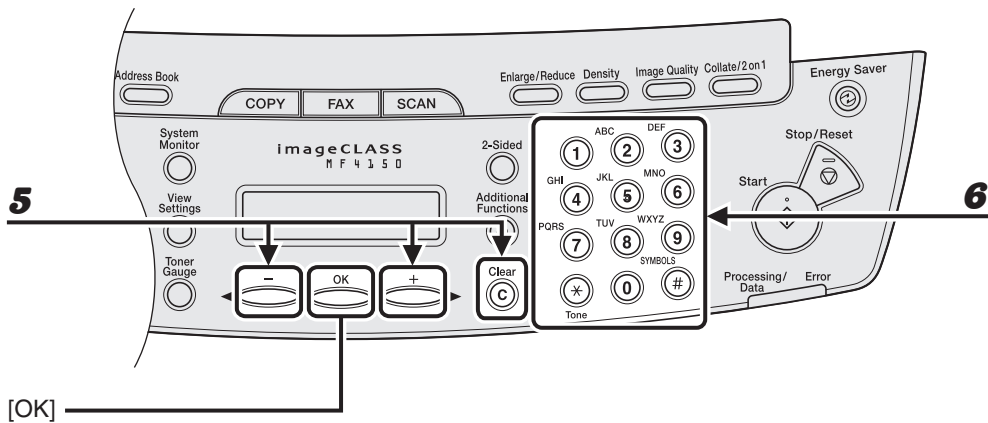

- 5** Press [**←**] or [**→**] repeatedly to go to the wrong character, then press [**Clear**] to delete it.

To delete the entire name, press and hold [**Clear**].

- 6** Enter a new character with the numeric keypad, then press [**OK**].



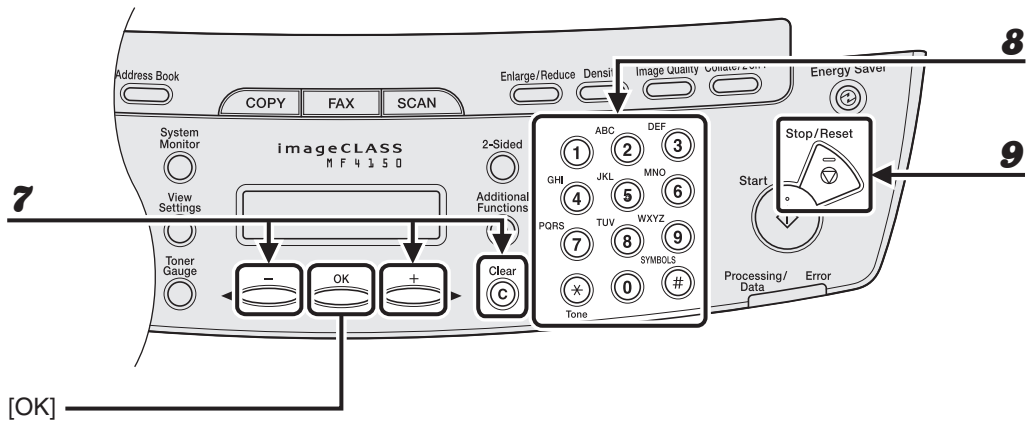

7 Press [←] or [→] repeatedly to go to the wrong number, then press [Clear] to delete it.

To delete all numbers, press and hold [Clear].

8 Enter a new number with the numeric keys, then press [OK].

9 Press [Stop/Reset] to return to the standby mode.

● Deleting One-Touch Speed Dialing

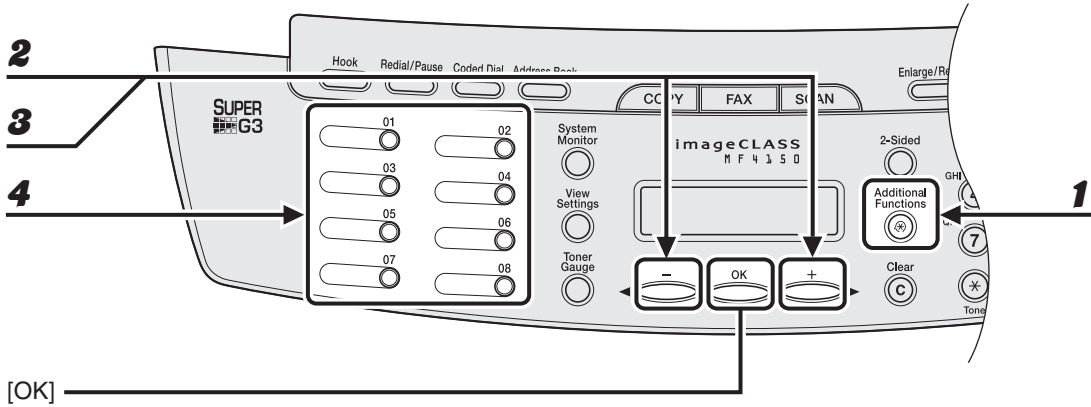

- 1** Press [Additional Functions].
- 2** Press [◀] or [▶] to select <ADDRESS BOOK SET.>, then press [OK].
- 3** Press [◀] or [▶] to select <1-TOUCH SPD DIAL>, then press [OK].
- 4** Press the one-touch speed dialing key (01 to 08) you want to delete, then press [OK].

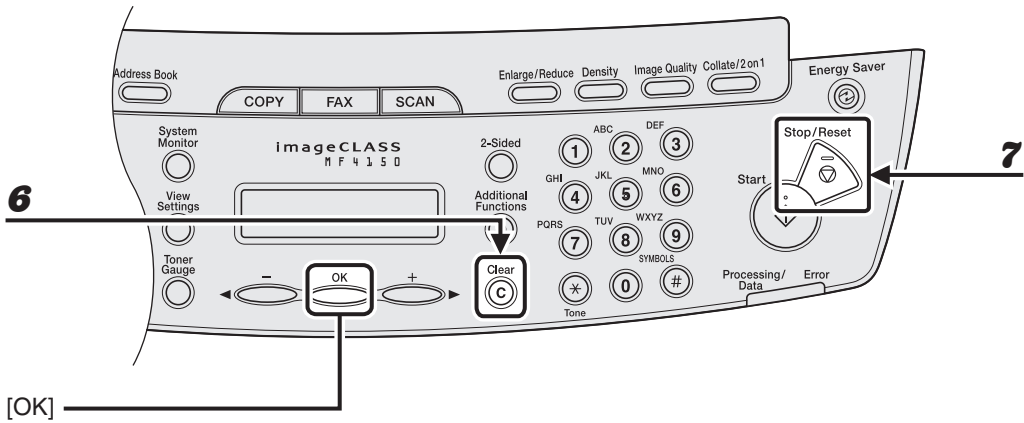

- 5** Press [OK].
 - 6** Press and hold [Clear] to delete all numbers, then press [OK].
-  **NOTE**
When deleting all numbers, the registered name is cleared automatically.
- 7** Press [Stop/Reset] to return to the standby mode.

● Registering Coded Dialing

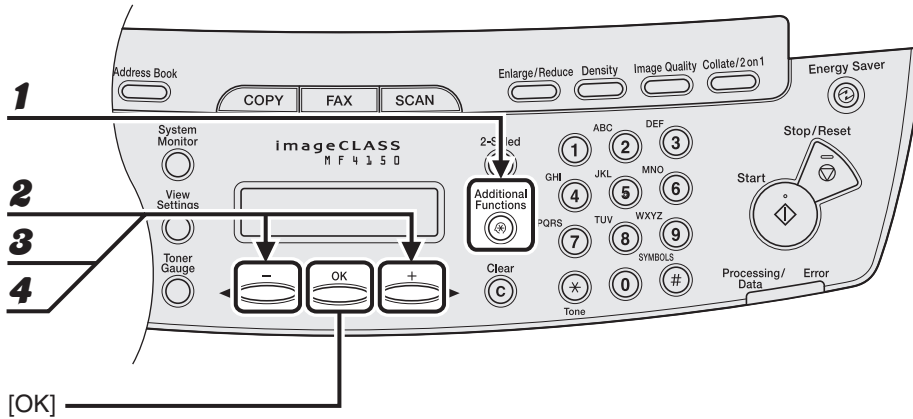

- 1** Press [Additional Functions].
- 2** Press [◀] or [▶] to select <ADDRESS BOOK SET.>, then press [OK].
- 3** Press [◀] or [▶] to select <CODED DIAL>, then press [OK].
- 4** Press [◀] or [▶] to select a coded dialing code (00 to 99), then press [OK].

You can also enter a coded dialing code with the numeric keys after pressing [Coded Dial].



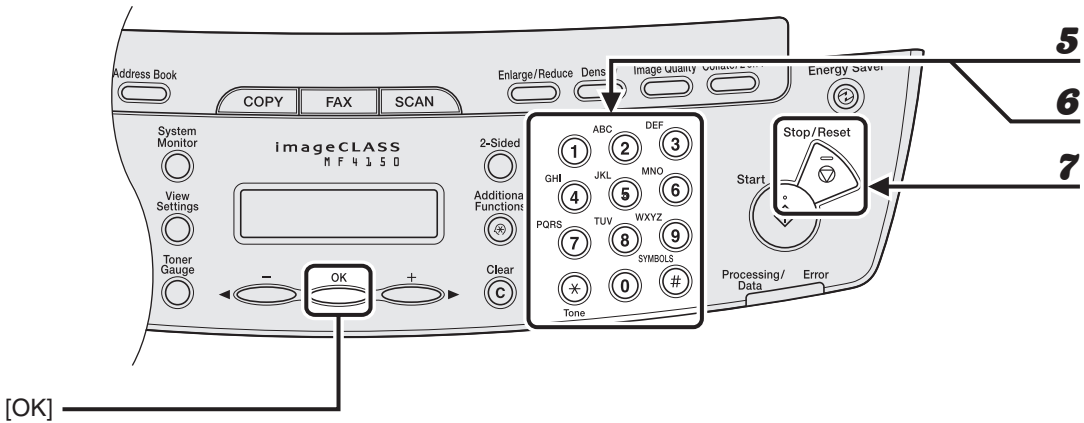

- 5** Enter the destination name (max. 20 characters, including spaces) with the numeric keys, then press [OK].

Ex.

NAME	[A]
CAN	

- 6** Enter the fax number you register (max. 50 digits, including spaces and pauses) with the numeric keys, then press [OK].

Ex.

TEL NUMBER ENTRY
012XXXXXXXXX_

If you register another coded dialing number, repeat the procedure from step 4.

- 7** Press [Stop/Reset] to return to the standby mode.

● Editing Coded Dialing

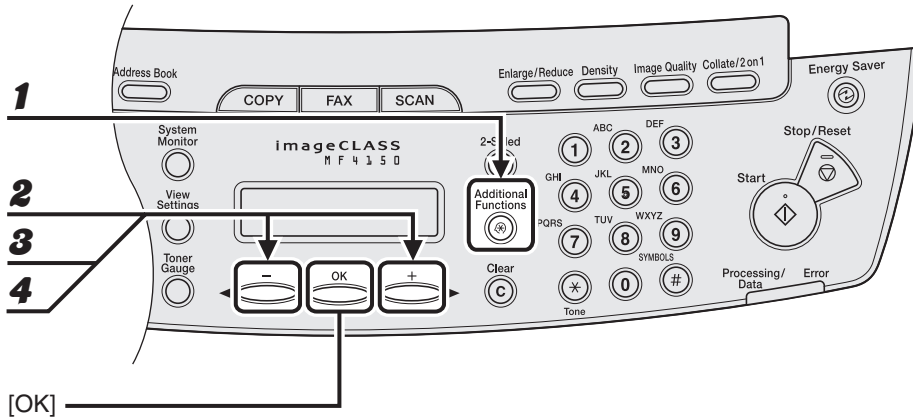

- 1** Press [Additional Functions].
- 2** Press [◀] or [▶] to select <ADDRESS BOOK SET.>, then press [OK].
- 3** Press [◀] or [▶] to select <CODED DIAL>, then press [OK].
- 4** Press [◀] or [▶] to select the coded dialing code (00 to 99) that you want to edit, then press [OK].

You can also enter a coded dialing code with the numeric keys after pressing [Coded Dial].



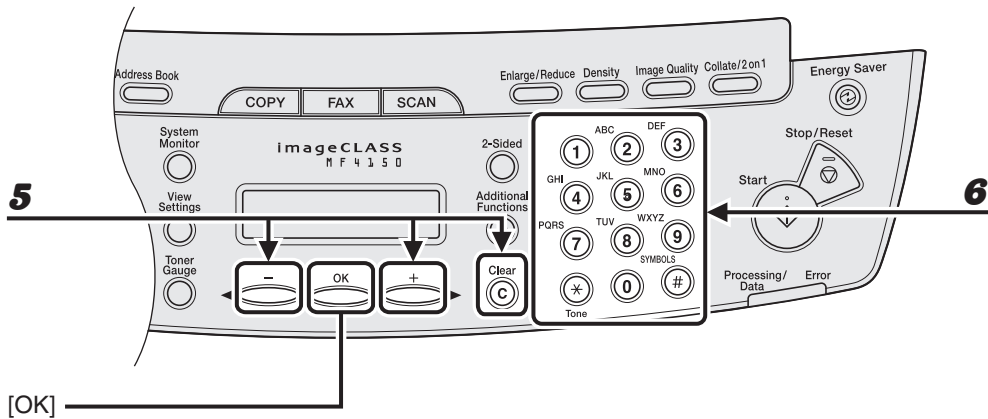

- 5** Press [**←**] or [**→**] repeatedly to go to the wrong character, then press [**Clear**] to delete it.

To delete the entire name, press and hold [**Clear**].

- 6** Enter a new character with the numeric keypad, then press [**OK**].

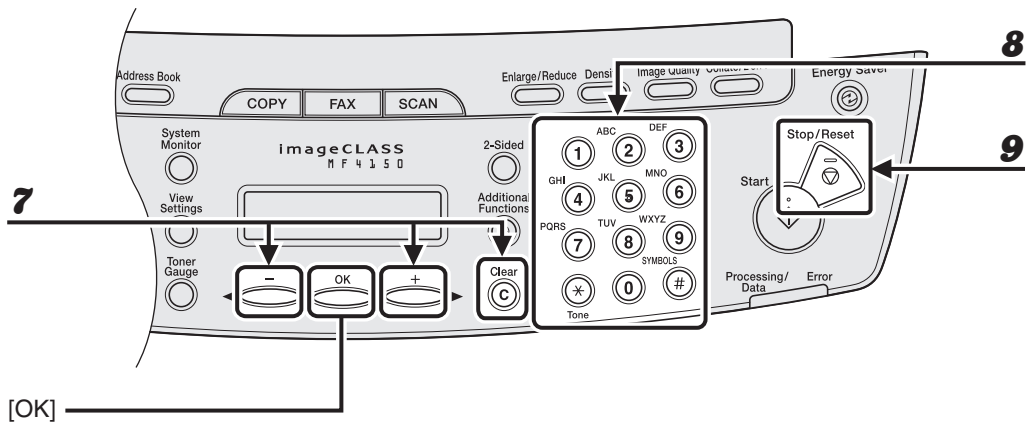

- 7** Press [**←**] or [**→**] repeatedly to go to the wrong number, then press [**Clear**] to delete it.
To delete all numbers, press and hold [**Clear**].
- 8** Enter a new number with the numeric keys, then press [**OK**].
- 9** Press [**Stop/Reset**] to return to the standby mode.

● Deleting Coded Dialing

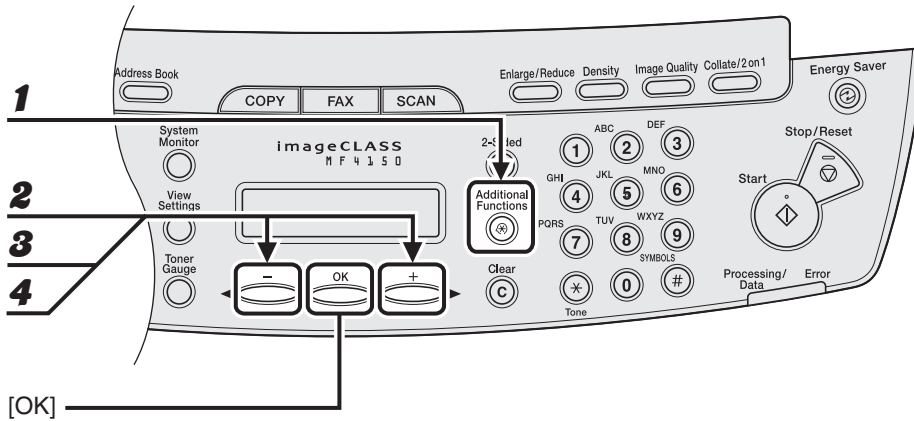

- 1** Press [Additional Functions].
- 2** Press [◀] or [▶] to select <ADDRESS BOOK SET.>, then press [OK].
- 3** Press [◀] or [▶] to select <CODED DIAL>, then press [OK].
- 4** Press [◀] or [▶] to select the coded dialing code (00 to 99) that you want to delete, then press [OK].

You can also enter a coded dialing code with the numeric keys after pressing [Coded Dial].

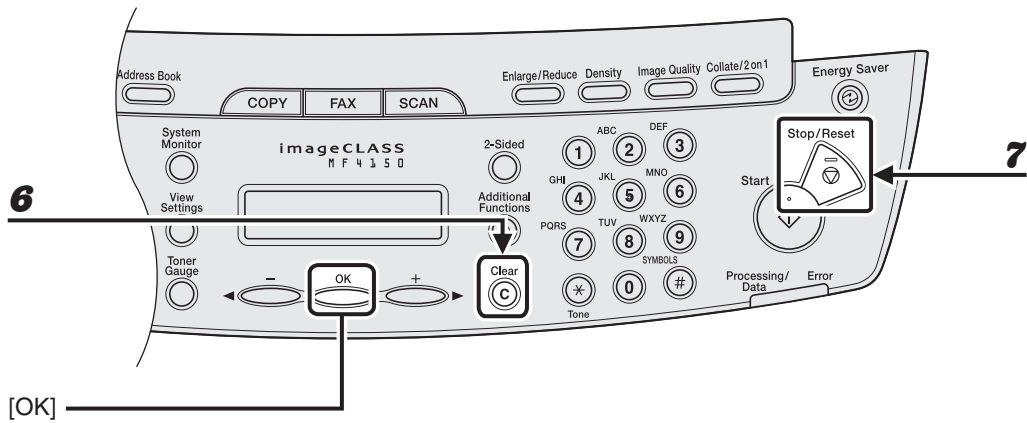

- 5** Press [OK].
- 6** Press and hold [Clear] to delete all numbers, then press [OK].
 -  **NOTE**
When deleting all numbers, the registered name is cleared automatically.
- 7** Press [Stop/Reset] to return to the standby mode.

● Registering Group Dialing

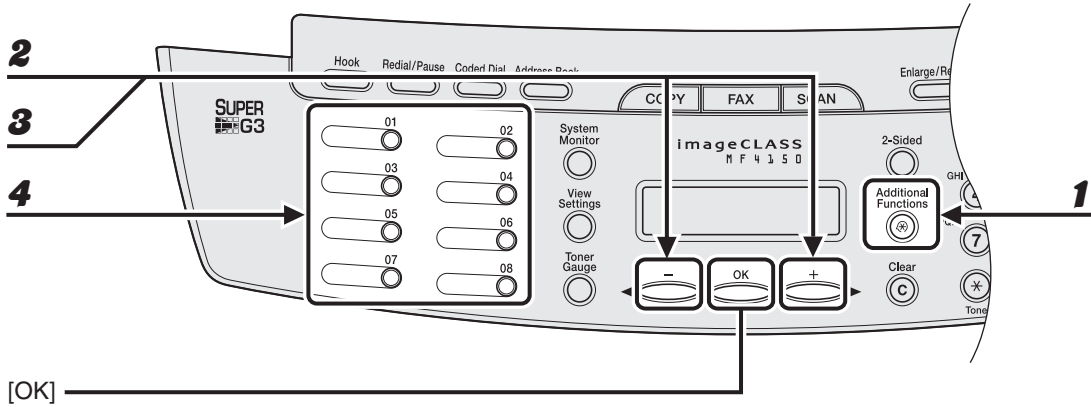

- 1** Press [Additional Functions].
- 2** Press [◀] or [▶] to select <ADDRESS BOOK SET.>, then press [OK].
- 3** Press [◀] or [▶] to select <GROUP DIAL>, then press [OK].
- 4** Specify an empty one-touch speed dialing key that you want to set as the group dial, then press [OK].

For details on selecting a one-touch speed dialing key, see “Registering One-Touch Speed Dialing,” on p. 4-7.

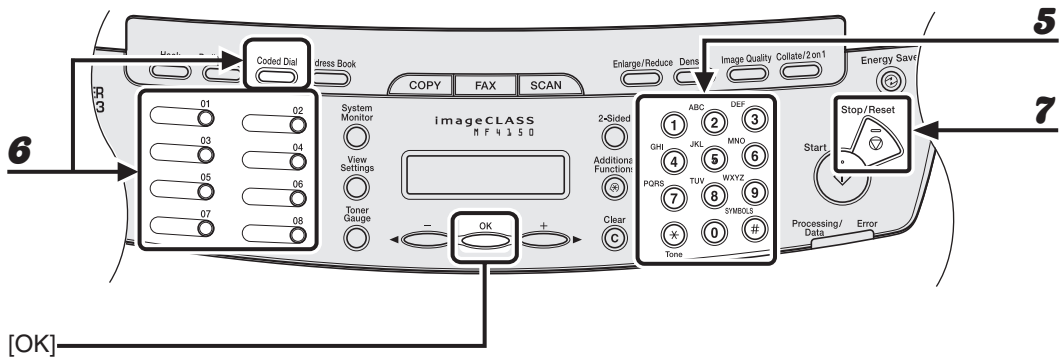

- 5** Enter the group name (max. 20 characters, including spaces) with the numeric keys, then press [OK].

Ex.

NAME [A] C A N O N G R O U P

- 6** Select the speed dialing numbers you want to register in the group (max. 50 destinations) until all destinations are registered, then press [OK].

The speed dialing number refers to the one-touch dialing number or coded dialing code under which the fax/telephone number is registered.

To enter a number stored under a one-touch speed dialing key, press the desired one-touch speed dialing key(s).

To enter a number stored under a coded dialing code, press [Coded Dial], then enter the two-digit code for the number with the numeric keys. For multiple entries, press [Coded Dial] between each entry.

NOTE

You can review the destinations which have been already entered with [←] or [→].

- 7** Press [Stop/Reset] to return to the standby mode.

● Adding New Destination to Group

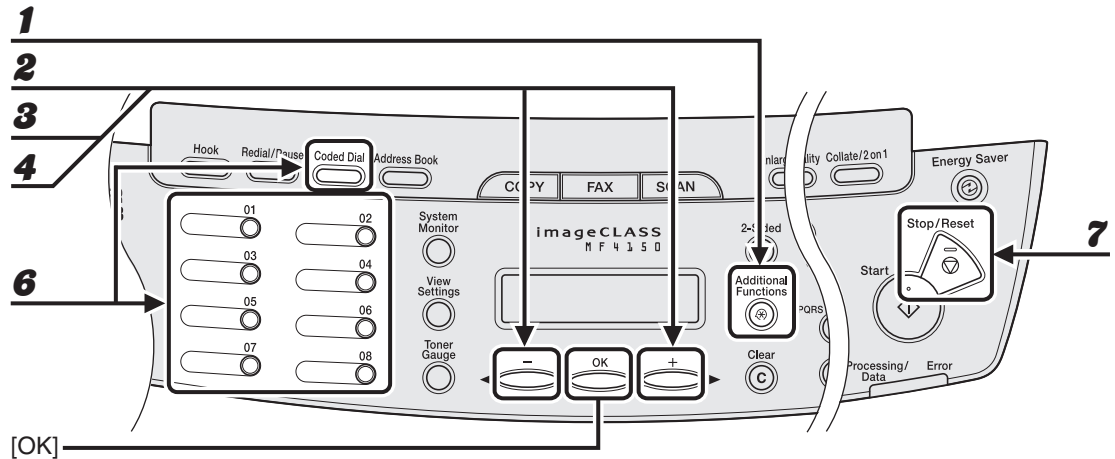

- 1** Press [Additional Functions].
- 2** Press [◀] or [▶] to select <ADDRESS BOOK SET.>, then press [OK].
- 3** Press [◀] or [▶] to select <GROUP DIAL>, then press [OK].
- 4** Press [◀] or [▶] to select a group dial to edit, then press [OK].
The group name appears.
- 5** Press [OK].
- 6** Select the speed dialing number you want to add to the group, then press [OK].
For details on entering the speed dialing number, see “Registering Group Dialing,” on p. 4-21.
- 7** Press [Stop/Reset] to return to the standby mode.

● Deleting Destination from Group

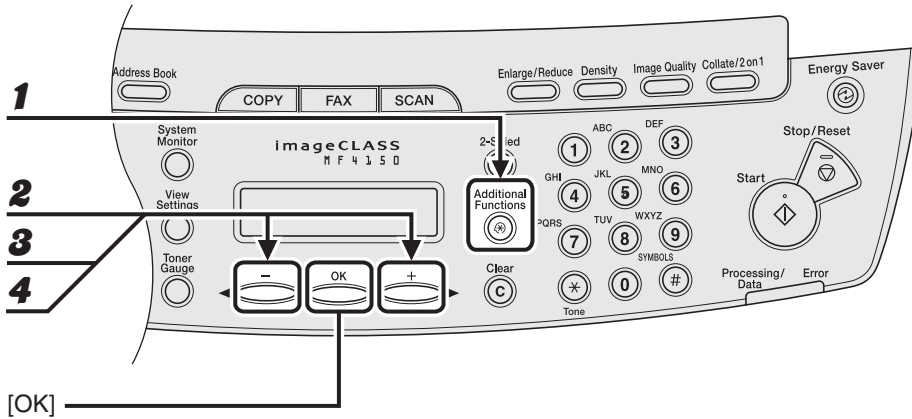

- 1** Press [Additional Functions].
- 2** Press [◀] or [▶] to select <ADDRESS BOOK SET.>, then press [OK].
- 3** Press [◀] or [▶] to select <GROUP DIAL>, then press [OK].
- 4** Press [◀] or [▶] to select a group dial to delete, then press [OK].
The group name appears.
- 5** Press [OK].



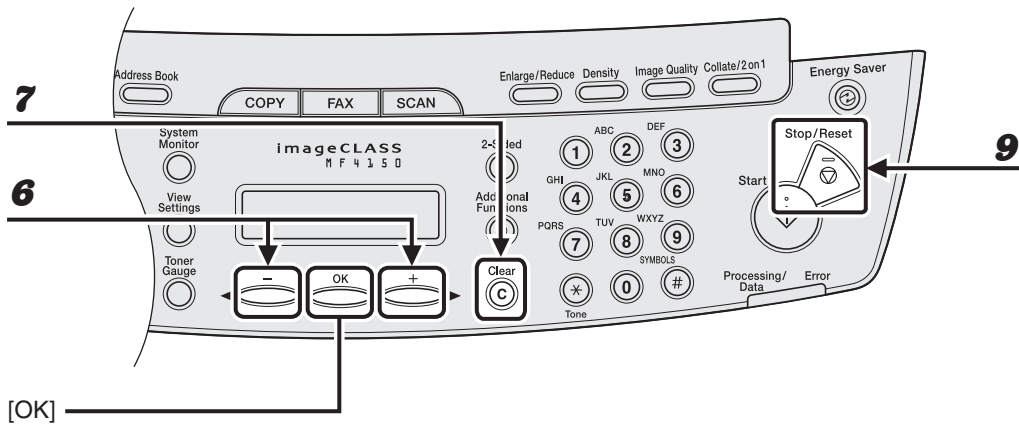

[OK]

- 6** Press [**←**] or [**→**] to display the speed dial number you want to delete from the group.
- 7** Press [Clear].
- 8** Repeat steps 6 and 7 if you want to delete another speed dialing number, then press [OK].
- 9** Press [Stop/Reset] to return to the standby mode.

● Changing Group Name

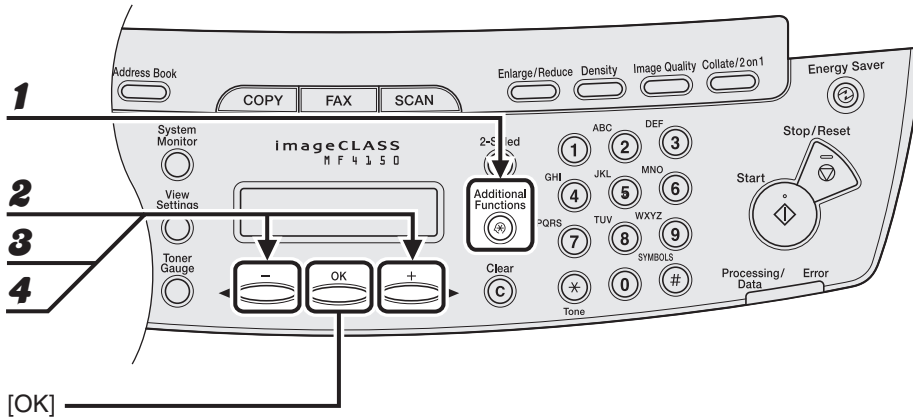

- 1** Press [Additional Functions].
- 2** Press [◀] or [▶] to select <ADDRESS BOOK SET.>, then press [OK].
- 3** Press [◀] or [▶] to select <GROUP DIAL>, then press [OK].
- 4** Press [◀] or [▶] to select a group dial to edit, then press [OK].



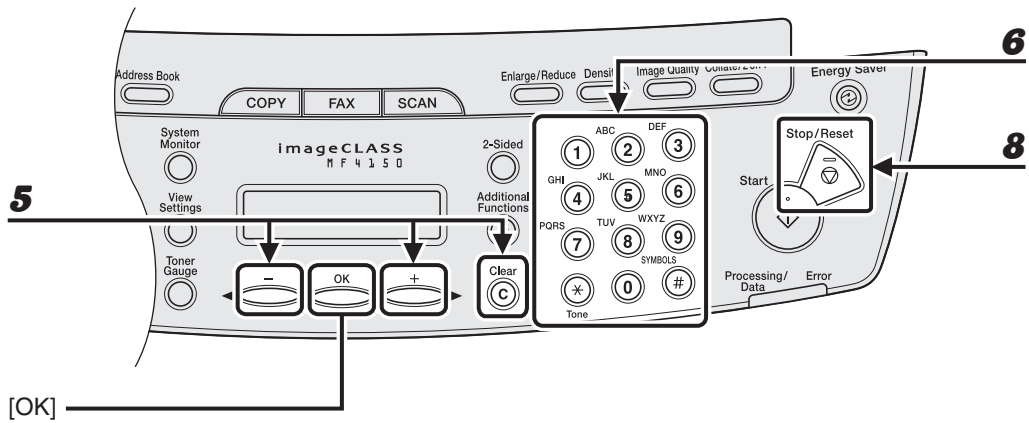

- 5** Press [**←**] or [**→**] repeatedly to go to the wrong character, then press [**Clear**] to delete it.
To delete the entire character, press and hold [**Clear**].
- 6** Enter a new name with the numeric keys, then press [**OK**].
- 7** Press [**OK**].
- 8** Press [**Stop/Reset**] to return to the standby mode.

● Deleting Group Dialing

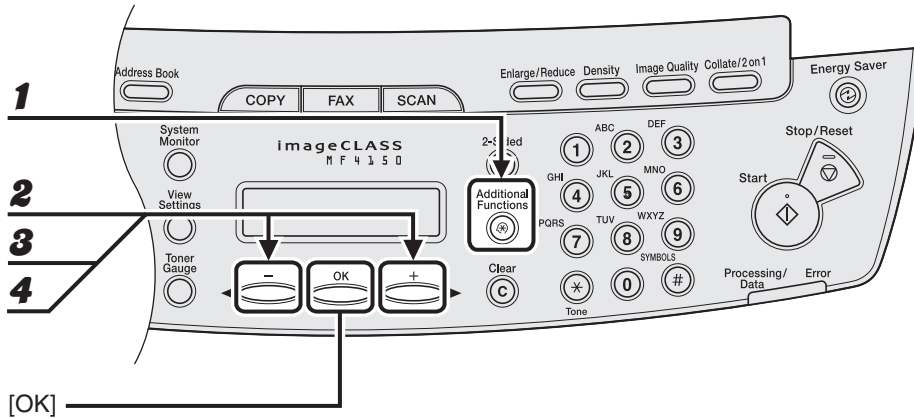

- 1** Press [Additional Functions].
- 2** Press [◀] or [▶] to select <ADDRESS BOOK SET.>, then press [OK].
- 3** Press [◀] or [▶] to select <GROUP DIAL>, then press [OK].
- 4** Press [◀] or [▶] to select a group dial to delete, then press [OK].
The group name appears.
- 5** Press [OK].



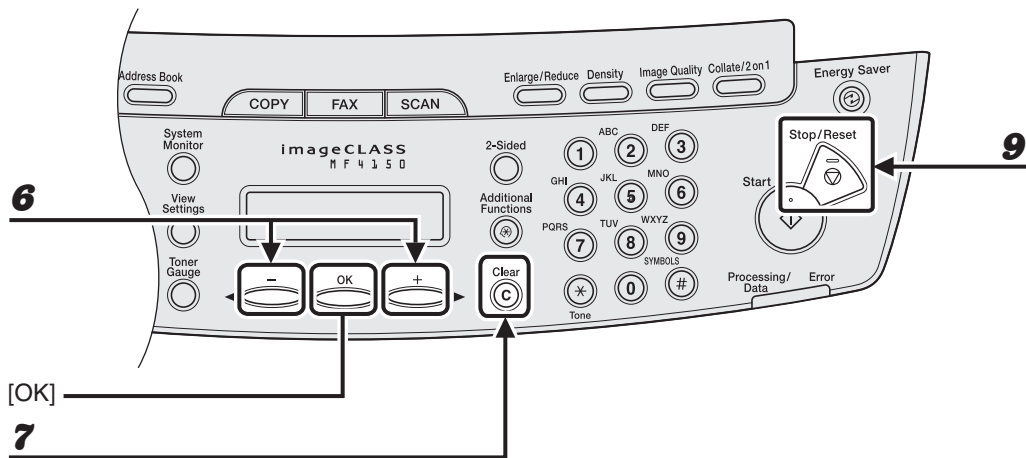

- 6** Press [**←**] or [**→**] to display a speed dial number.
 - 7** Press [**OK**].
 - 8** Repeat steps 6 and 7 until all speed dial numbers are deleted, then press [**OK**].
-  **NOTE**
When deleting all speed dial numbers, the group name is cleared automatically.
- 9** Press [**Stop/Reset**] to return to the standby mode.

Using Speed Dialing

Follow the procedure below to send faxes to registered recipients using speed dialing. For easy reference, print out the list of recipients registered for speed dialing. (See Chapter 4, “Reports and Lists,” in the Advanced Guide.)

● Using One-Touch Speed/Group Dialing

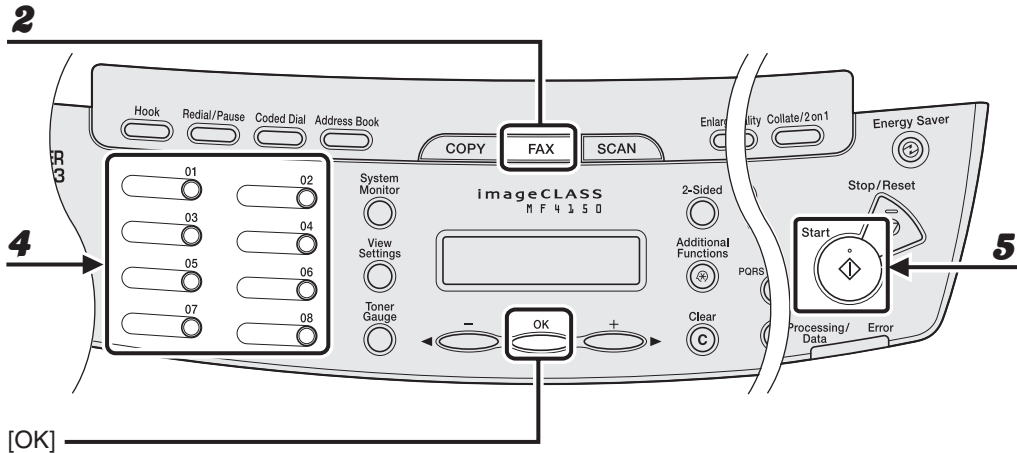

- 1** Place the document on the platen glass or load it in the ADF.
- 2** Press **[FAX]**.
- 3** Adjust any necessary settings for your document.
For details, see “Scan Settings,” on p. 4-3.
- 4** Press the desired one-touch speed or group dialing key (01 to 08).
- 5** Press **[Start]**.

When you set the document on the platen glass, press **[Start]** for each document. When scanning is complete, press **[OK]**.

● Using Coded Dialing

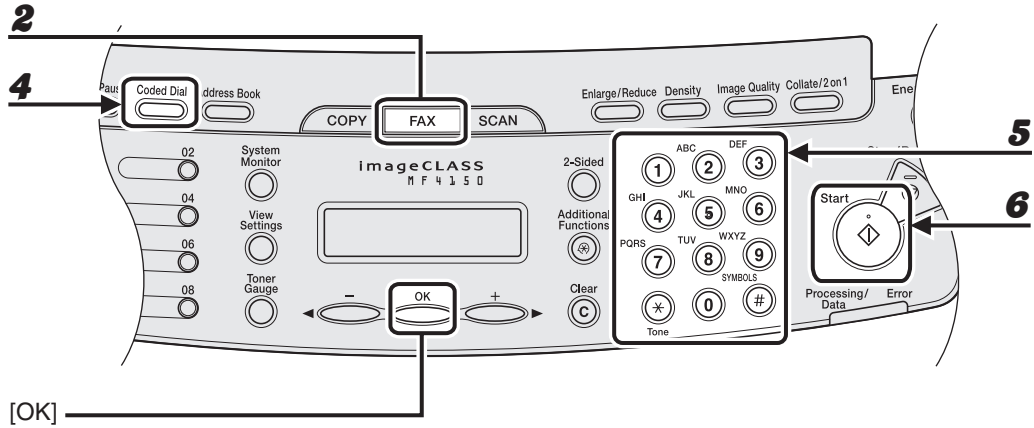

- 1** Place the document on the platen glass or load it in the ADF.
- 2** Press [FAX].
- 3** Adjust any necessary settings for your document.
For details, see “Scan Settings,” on p. 4-3.
- 4** Press [Coded Dial].
- 5** Enter the desired two-digit code (00 to 99) with the numeric keys.

Ex.

```
☎ = 0 1 2 X X X X X X X  
[ * 0 1 ] CANON
```

- 6** Press [Start].

When you set the document on the platen glass, press [Start] for each document. When scanning is complete, press [OK].

Manual Sending

Use manual sending when you want to talk to the recipient before sending a document, or if the recipient does not have a fax machine that can receive automatically.

NOTE

- You cannot use the platen glass for manual sending.
- You cannot use group dialing for manual sending.

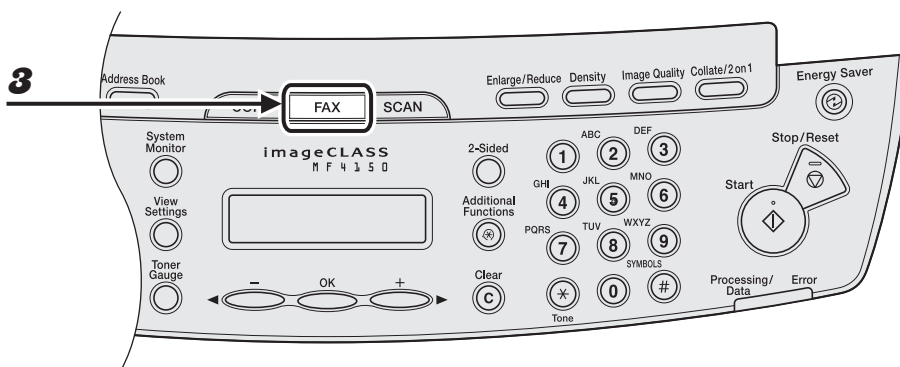

1 Connect an external telephone to the machine if you want to talk to the recipient before sending a document.

For details on how to connect an external telephone to the machine, see “Connect Telephone Cables,” in the Starter Guide.

2 Load the document in the ADF.

3 Press [FAX].

4 Adjust any necessary settings for your document.

For details, see “Scan Settings,” on p. 4-3.



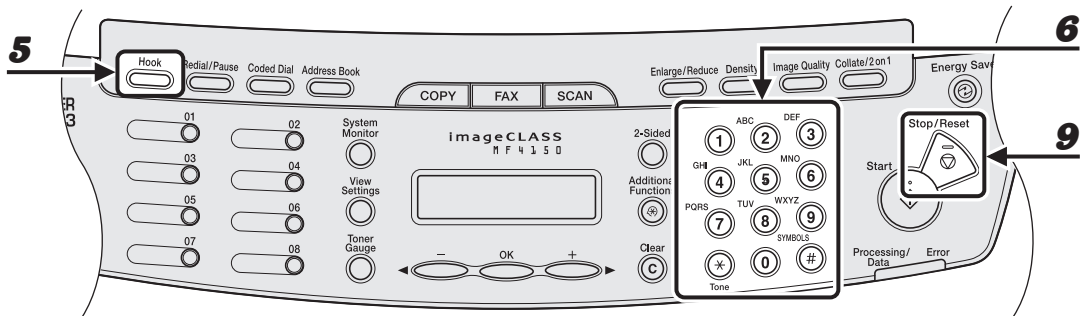

5 Press [Hook] or pick up the handset of your external telephone.

6 Dial the recipient's fax/telephone number.

 **NOTE**

Make sure to confirm the dial tone before entering a fax number. If you enter the number before the dial tone can be heard, the call may not connect, or the wrong number may be dialed.

7 Talk through the handset to the recipient.

If you press [Hook] in step 5, you can pick up the handset when you hear the recipient's voice. If you hear a high-pitched signal instead of the recipient's voice, go to step 9.

8 Ask the recipient to set their fax machine to receive faxes.

9 When you hear a high-pitched signal, press [Start], then hang up the handset.

5 Receiving Faxes

Follow this procedure to set the machine for receiving faxes.

For advanced receiving features, see Chapter 1, “Advanced Fax Features,” in the Advanced Guide.

1 Enter the Setting Menu

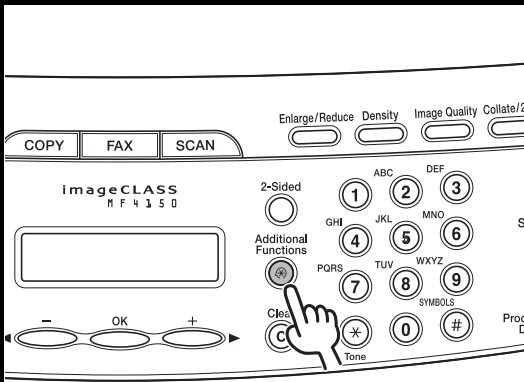

The diagram shows the control panel of an imageCLASS machine. At the top, there are buttons for 'COPY', 'FAX', and 'SCAN'. Below these are 'Enlarge/Reduce', 'Density', 'Image Quality', and 'Collate/2'. The main display area shows 'imageCLASS' and 'MF 4 1 5 0'. A hand is pointing to the 'Additional Functions' button, which is represented by a circle with a square inside. Other buttons include '2-Sided', 'Clear' (C), and a numeric keypad.

Press [Additional Functions].

2 Enter the Receive Mode

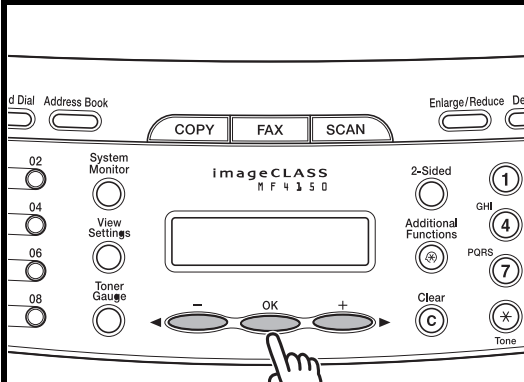

The diagram shows the control panel with the 'Additional Functions' menu open. A hand is pointing to the 'FAX SETTINGS' option, which is represented by a circle with a square inside. Other options include 'System Monitor', 'View Settings', and 'Toner Gauge'. The numeric keypad is also visible.

Select <FAX SETTINGS> with [◀—] or [+▶], then press [OK].

Select <RX SETTINGS> with [◀—] or [+▶], then press [OK].

Select <RX MODE> with [◀—] or [+▶], then press [OK].

3 Select the Receive Mode

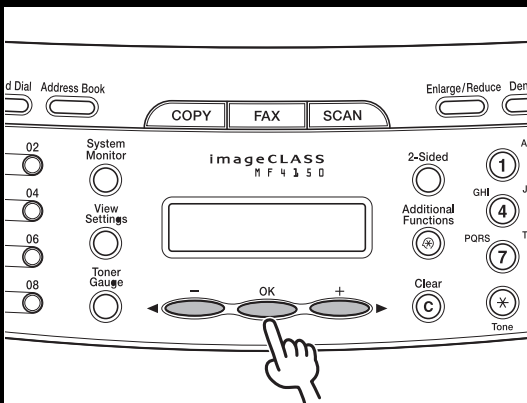

Select the receive mode with [**←**] or [**+ ▶**], then press [**OK**].

- <FaxOnly>: Answers all calls as faxes.
 - <AnsMode>: Receives faxes automatically and records voice messages.
 - <DRPD>: Distinguishes between fax and voice calls if you want to use an external telephone.
 - <FAX/TEL>: Switches between fax and voice calls automatically if an external telephone is connected to the machine.
 - <MANUAL>: Does not answer any calls. You have to manually receive faxes.
- For details on these settings, see Chapter 1, "Advanced Fax Features," in the Advanced Guide.

NOTE

- For <AnsMode>, make sure an answering machine is connected to the machine.
- For <DRPD>, subscription to a DRPD service is required.

4 Exit the Setting Menu

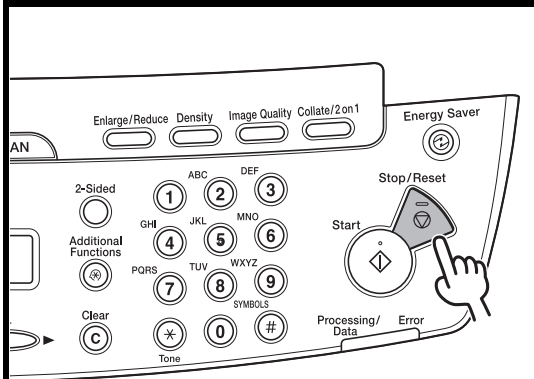

Press [**Stop/Reset**] to return to the standby display.

What if...

- **You press [**Stop/Reset**] to cancel a job:**
The <CANCEL DURING TX/RX?> message appears. Press [**←**] to select <Yes>. The job is canceled, and the display returns to the standby mode.
- **The <OUT OF TONER/CHANGE TONER> message appears:**
The toner cartridge is almost empty. Replace the toner cartridge. For details on this error message, see "LCD Messages," on p. 11-9.

6 Copying

Follow this procedure to make a copy.

For advanced copying features, see Chapter 2, “Advanced Copy Features,” in the Advanced Guide.

1 Set a Document

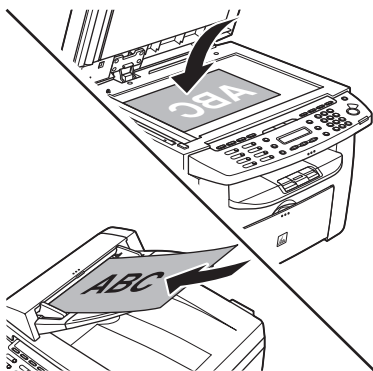

Place the document on the platen glass or load it in the ADF.

For documents you can copy, see “Document Requirements,” on p. 2-1.

2 Enter the Copy Mode

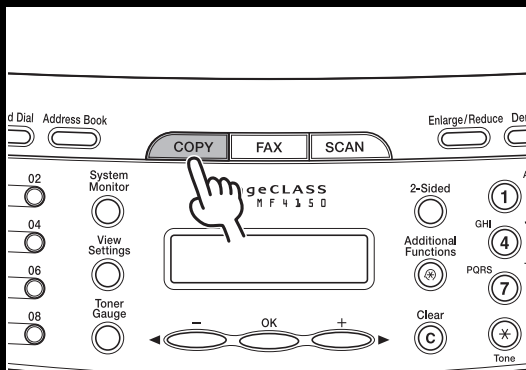

Press [COPY].

The COPY indicator lights and the machine enters the copy standby mode.

What if...

- **You want to adjust the resolution and density:**
See “Scan Settings,” on p. 6-3.

3 Enter the Copy Quantity

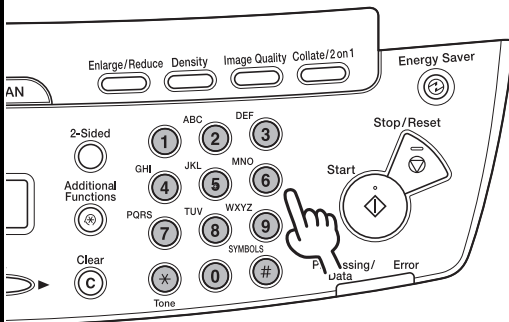

Enter the copy quantity (1 to 99) with the numeric key.

Ex.

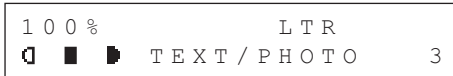

What if...

- **You enter a wrong number:**
Press [Clear] and enter a new number.

4 Start Copying

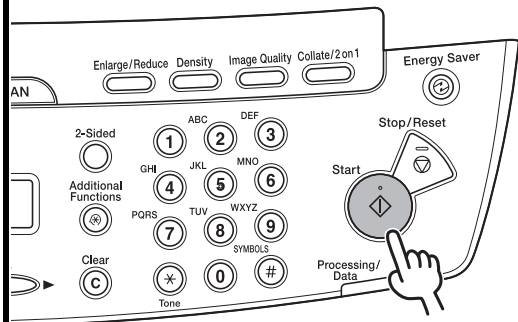

Press [Start].

What if...

- **You press [Stop/Reset] to cancel a job while scanning documents:**
The job is canceled immediately, and the copy quantity is reset.
- **You press [Stop/Reset] to cancel a job while printing:**
The <CANCEL COPYING?> message appears. Press [←] to select <YES>.

Scan Settings

Before pressing [Start] to begin copying, you can adjust scan settings to better suit the document to be scanned. These settings return to the default values if Auto Clear function is activated or if you press [Stop/Reset].

Image Quality

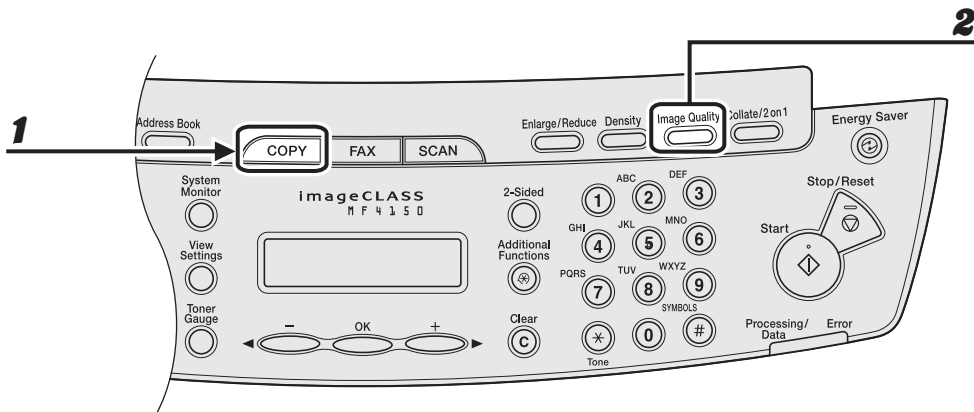

1 Press [COPY].

2 Press [Image Quality] repeatedly to select the document type.

<TEXT/PHOTO>: For documents that contain text and photos.

<TEXT>: For text documents.

<PHOTO>: For documents that contain fine text or photos.

<TEXT/PHOTO+>: For documents that contain fine text and photos.

 **NOTE**

Copy density automatically changes to the manual mode when <TEXT/PHOTO>, <PHOTO>, or <TEXT/PHOTO+> is set.

Density

You can adjust the density to the most appropriate level for the document either automatically or manually.

● Adjusting Automatically

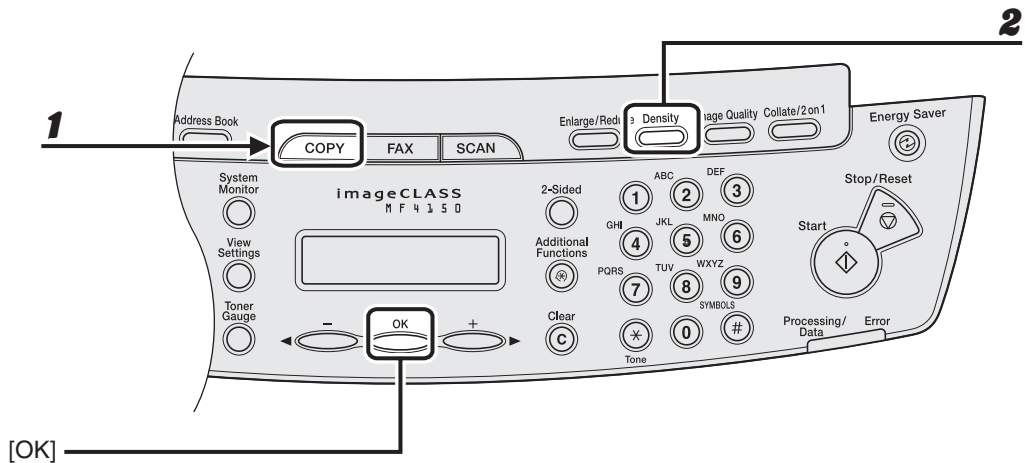

1 Press [COPY].

2 Press [Density] repeatedly until <AUTO> appears, then press [OK].

 **NOTE**

The image quality is automatically set to <TEXT>.

● Adjusting Manually

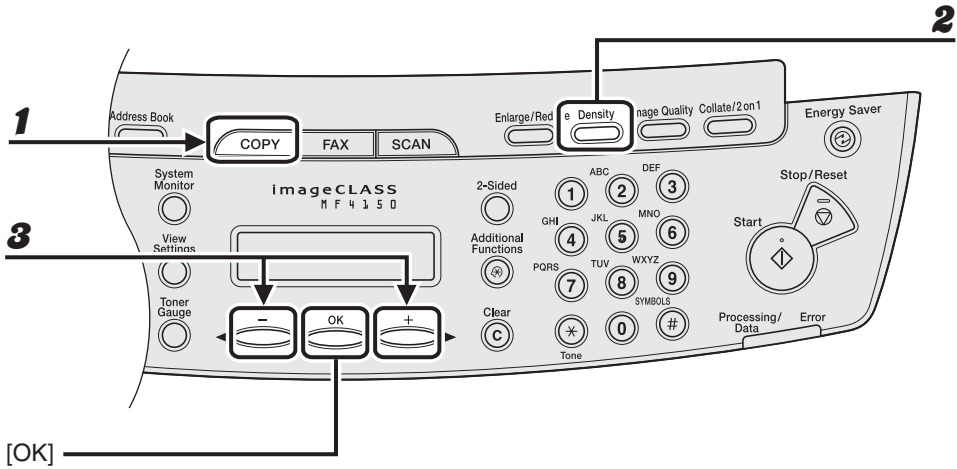

- 1** Press [COPY].
- 2** Press [Density] repeatedly to select the manual mode.

Ex.

```
DENSITY  
-LT ████■█████ DK+
```

- 3** Press [◀] or [▶] to adjust the copy density, then press [OK].
[▶]: to make light documents darker
[◀]: to make dark documents lighter

Zoom Ratio

● Preset Zoom

You can enlarge or reduce documents from one standard paper size to another.

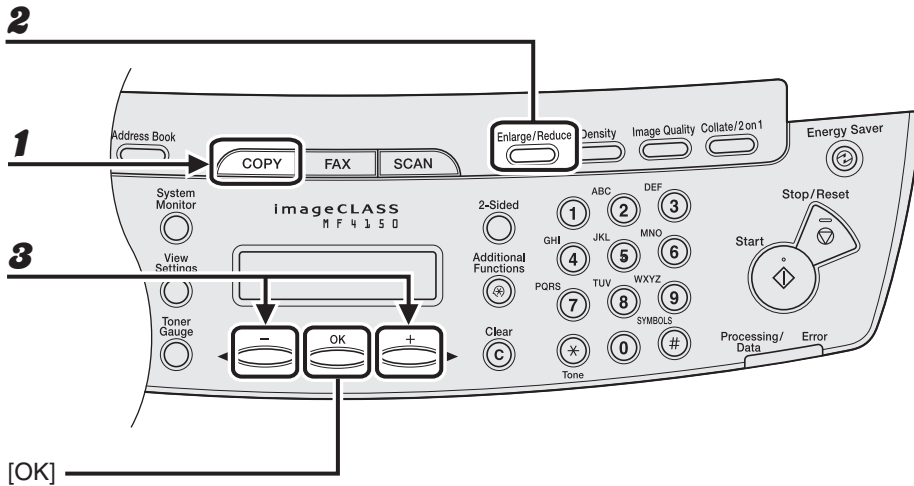

- 1** Press **[COPY]**.
- 2** Press **[Enlarge/Reduce]**.
- 3** Press **[<-]** or **[+>]** to select the copy ratio, then press **[OK]**.

- 200 % MAX.
- 129 % STMT → LTR
- 100 %
- 78 %
- 64 %
- 50 % MIN.

NOTE

When <PAPER SIZE GROUP> in the <COPY SETTINGS> menu is set to <A> or <AB>, the preset copy ratios change as follows:

A: 50%, 70%, 100%, 141%, 200%

AB: 50%, 70%, 81%, 86%, 100%, 115%, 122%, 141%, 200%

● Zoom Designation

You can reduce or enlarge images by any copy ratio, in 1 % increments. The available copy ratios are from 50 % to 200 %.

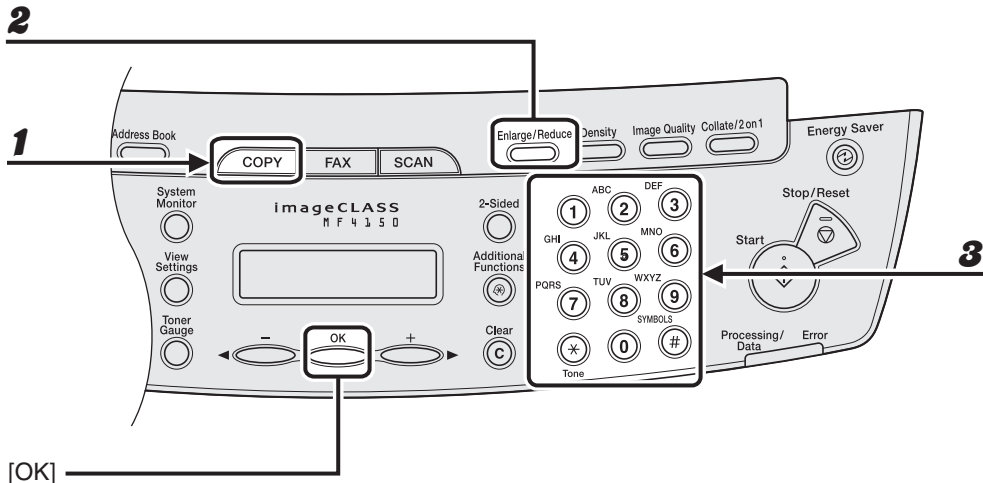

- 1** Press [COPY].
- 2** Press [Enlarge/Reduce] twice.
- 3** Enter the copy ratio with the numeric keys, then press [OK].

Ex.

ZOOM	50 - 200 %	
-	100 %	+

You can also use [◀◀] or [▶▶] to adjust the zoom ratio. To increase the zoom ratio, press [▶▶]. To decrease the copy ratio, press [◀◀].

NOTE

To return the copy ratio to 100%, press [Stop/Reset].

7

Printing

Follow this procedure to print a document from your computer.

Make sure that the printer driver is installed.

For details on printer driver settings, see Online Help.

1 Start the Print Command

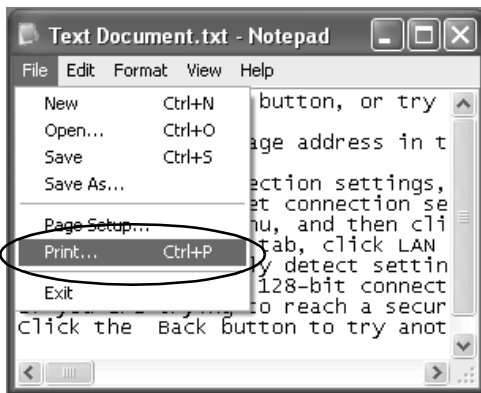

From an open document on an application, click [File] > [Print].

2 Select the Printer

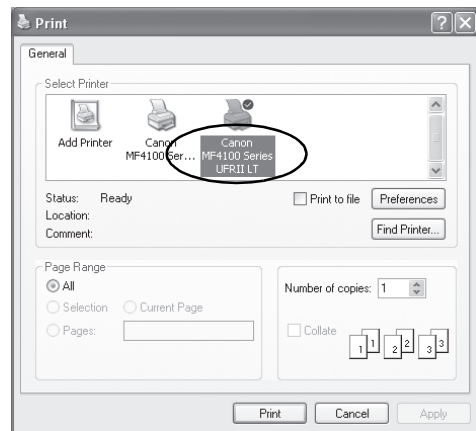

Select the printer icon for the machine ([Canon MF4100 Series UFR II LT]).

3 Adjust Preferences

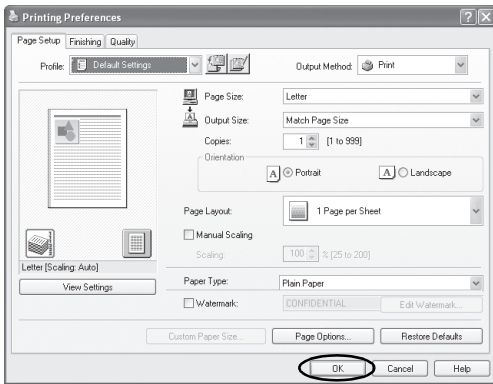

Click [Preferences] or [Properties] to open the dialog box. After finished, click [OK].

4 Print the Document

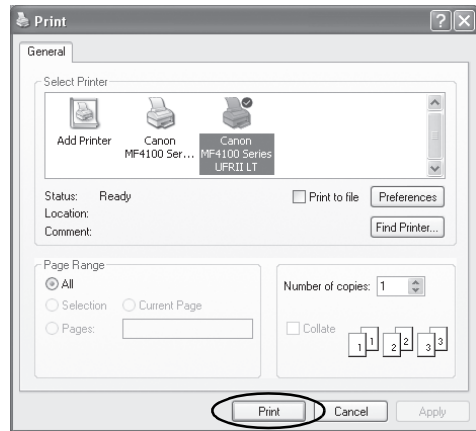

Click [Print] or [OK].

What if...

- **You want to cancel printing:**
See Chapter 3, “System Monitor,” in the Advanced Guide.

8 Scanning

Follow this procedure to scan a document to your computer.

Make sure that the scanner driver is installed.

For details on scanner driver settings, see the Scanner Driver Guide (in the User Software CD).

1 Set a Document

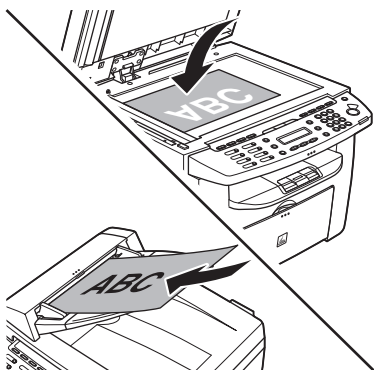

Place the document on the platen glass or load it in the ADF.

For documents you can scan, see "Document Requirements," on p. 2-1.

2 Enter the Scan Mode

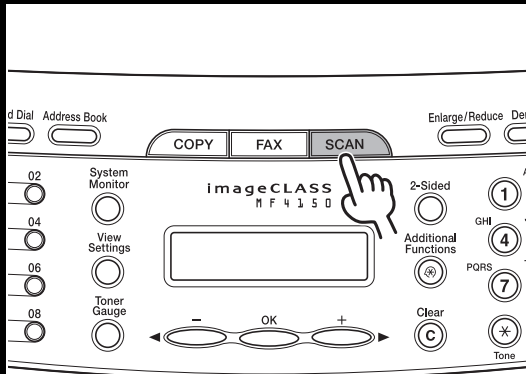

Press [SCAN].

The SCAN indicator lights up and the machine enters the scan standby mode.

3 Set Scan Function

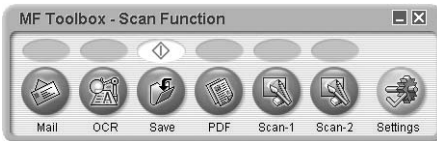

Start MF Toolbox, then set the scanning format.

The mark will be displayed above the button you select. For details on the MF Toolbox Settings, see Chapter 2, "Scanning a Document," in the Scanner Driver Guide.

4 Start Scanning

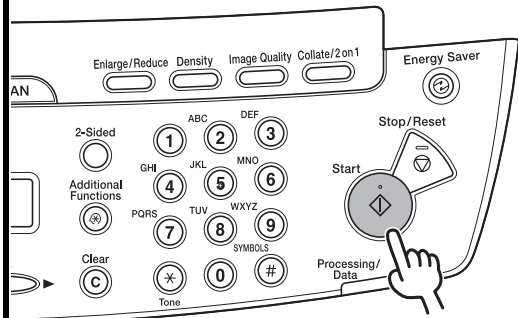

Press [Start].

What if...

- **You want to cancel scanning:**
Press [Stop/Reset] on the operation panel, then click [OK] on the computer screen.

9 PC Faxing

Follow this procedure to send a fax from your computer.
Make sure that the fax driver is installed.
For details on fax driver settings, see Online Help.

1 Start the Print Command

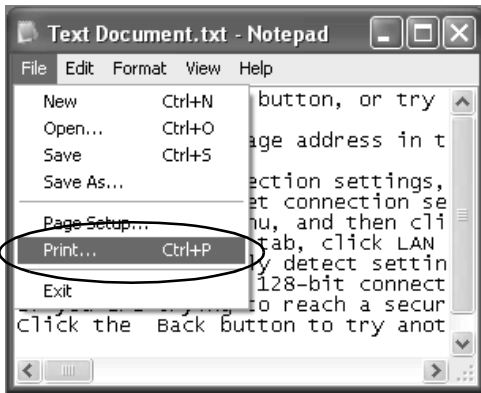

From an open document on an application, click [File] > [Print].

2 Select the Fax

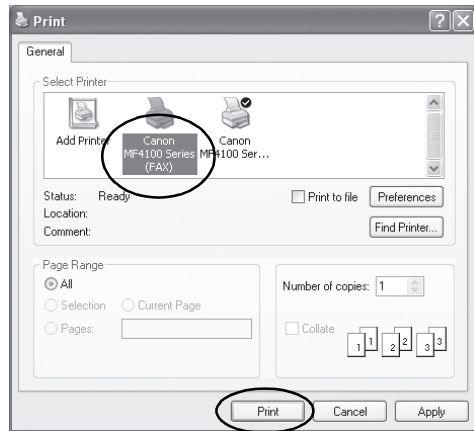

Select the fax icon ([Canon MF4100 Series(FAX)]), then click [Print] or [OK].

What if...

- You want to adjust the fax properties: Click [Preferences] or [Properties] and adjust the settings.

3 Set the Destination

Fax Sending Settings

Sending Settings | Edit Address Book | Cover Sheet

Recipient Name: CANON

Fax Number: 012345XXXX

Add to Address Book

Add to Recipient List

Recipient List:

Recipient Name	Fax Number
CANON	012345XXXX

Address Book...

Delete

Number of Recipients: 1

OK Cancel Help

Specify the name and fax number in [Sending Settings], then click [Add to Recipient List].

What if...

- You want to send a fax with the cover sheet:

Click the [Cover Sheet] tab and set the format for the cover sheet attachment.

4 Send the Document

Fax Sending Settings

Sending Settings | Edit Address Book | Cover Sheet

Recipient Name: CANON

Fax Number: 012345XXXX

Add to Address Book

Add to Recipient List

Recipient List:

Recipient Name	Fax Number
CANON	012345XXXX

Address Book...

Delete

Number of Recipients: 1

OK Cancel Help

Click [OK] in the Fax Sending Settings.

What if...

- You want to cancel sending a fax:
See Chapter 3, “System Monitor,” in the Advanced Guide.

10 Maintenance

Cleaning the Machine

Note the following before cleaning your machine:

- Make sure no document is stored in memory, then turn off the main power switch and disconnect the power cord.
- Use a soft cloth to avoid scratching the components.
- Do not use tissue paper, paper towels, or similar materials for cleaning; they can stick to the components or generate static charges.

CAUTION

Never use volatile liquids such as thinners, benzene, acetone, or any other chemical cleaner to clean the machine. These can damage the machine components.

Exterior

- 1** Turn off the main power switch and disconnect the power cord.
- 2** Wipe the machine's exterior with a clean, soft, lint-free cloth dampened with water or diluted dishwashing detergent solution.
- 3** Wait for the machine to dry, then reconnect the power cord and turn on the main power switch.

Interior

Clean the machine's print area periodically to prevent toner powder and paper dust from accumulating inside.

1 Turn off the main power switch and disconnect the power cord.

2 Lift the scanning platform until it is locked (A), and open the printer cover (B).

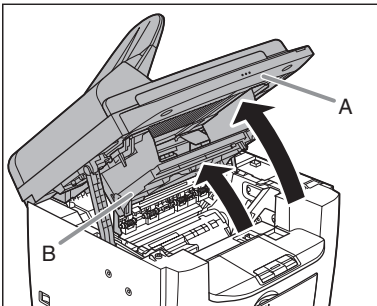

3 Remove the toner cartridge.

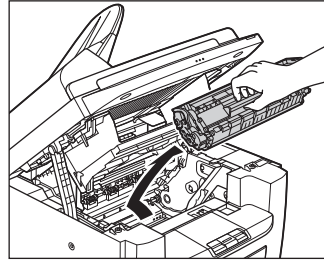

CAUTION

- To avoid exposing the toner cartridge to light, place it in its protective bag or wrap it in a thick cloth.
- Do not open the drum protective shutter on the toner cartridge. Print quality may deteriorate if the drum surface is exposed to light or is damaged.

NOTE

Always hold the toner cartridge by its handle.

4 Use a clean, soft, dry, lint-free cloth to remove any toner or paper debris from the machine's interior.



⚠ CAUTION

- Do not touch the fixing assembly (A) as it becomes very hot during use.
- Do not touch the transfer roller (B) as this can damage the machine.

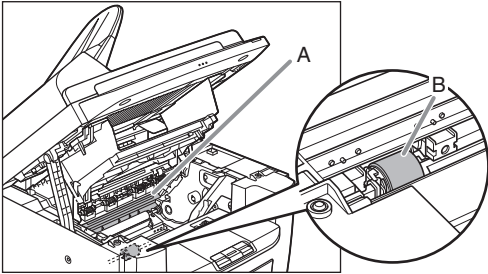

- If loose toner comes into contact with your skin or clothing, wash with cold water. Warm water will set the toner.

5 Hold the toner cartridge by its handle (A).

The arrow (A) on the toner cartridge should be facing away from you and pointing down.

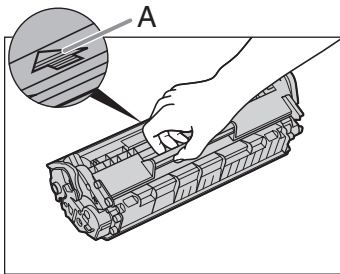

6 Insert the toner cartridge into the machine as far as it will go.

Align the guide (A) on the left side of the toner cartridge with the groove inside the machine.

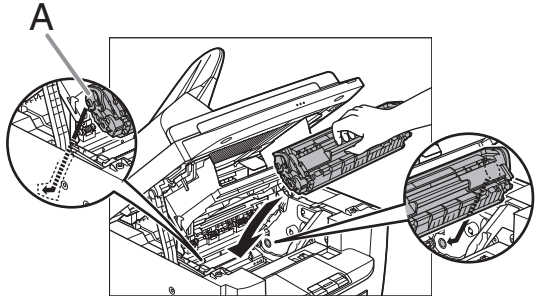

7 Push the toner cartridge to make sure it is properly set in the machine.

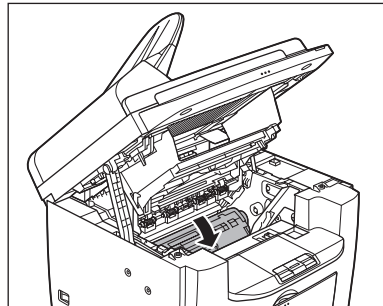

- 8** Close the printer cover and lower the scanning platform.

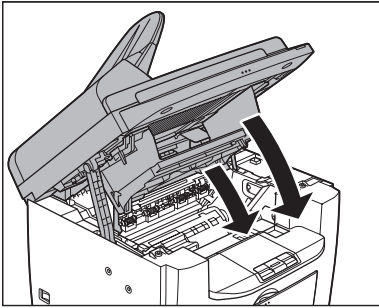

CAUTION

Be careful not to get your fingers caught.

- 9** Reconnect the power cord and turn on the main power switch.

Fuser Roller

If black streaks appear with printing, the fuser roller in the main unit may be dirty. Should this occur, clean the fusing roller in the following procedure. The roller should also be cleaned each time the toner cartridge is replaced. Load a sheet of blank LTR paper into the multi-purpose tray and start cleaning.

NOTE

Cleaning the roller takes approximately 130 seconds.

- 1** Press [Additional Functions].
- 2** Press [◀ -] or [+ ▶] to select <ADJUST./CLEANING>, then press [OK].
- 3** Load a sheet of blank LTR paper in the multi-purpose tray.

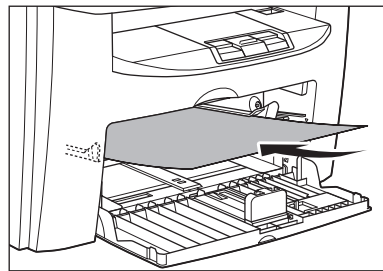

- 4** Press [**←**] or [**→**] to select **<FIX. UNIT CLEANING>**, then press [**OK**].

Cleaning starts. When finished, the display returns to the standby mode.

 **NOTE**

- Use standard paper as the cleaning paper.
- Throw away the cleaning paper after use.

Scanning area

Keep the scanning area clean to avoid dirty copies or faxes to be sent.

● Platen glass

- 1** Open the ADF.

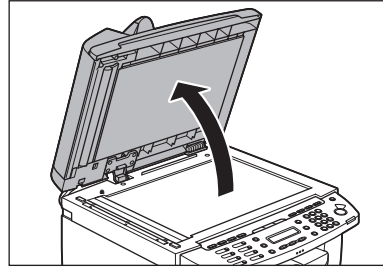

- 2** Clean the platen glass and the underside of the ADF with a cloth dampened with water. Then, wipe the area with a soft, dry cloth.

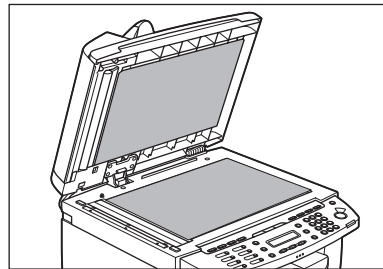

 **NOTE**

Do not dampen the cloth too much, as this may tear the document or damage the machine.

3 Close the ADF.

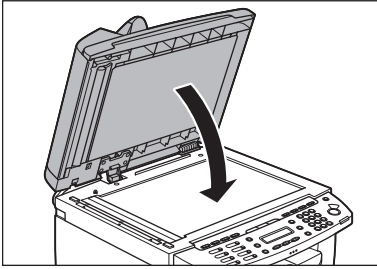

⚠ CAUTION

Be careful not to get your fingers caught.

● ADF

If your documents have black streaks or appear dirty after copying them using the ADF, this may be caused by pencil lead rubbing off the documents and onto the roller. Clean the ADF scanning area, film, and roller.

1 Turn off the main power switch and disconnect the power cord.

2 Open the ADF cover.

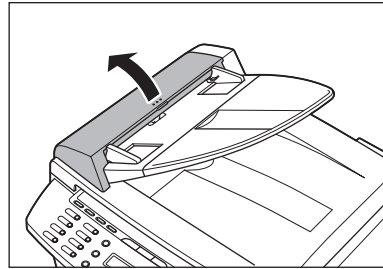

3 Clean the rollers (A) inside the ADF with a cloth dampened with water. Then wipe the area with a soft, dry cloth.

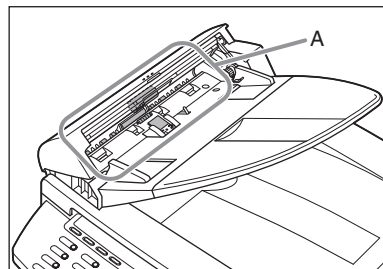

 **NOTE**

Do not dampen the cloth too much, as this may tear the document or damage the machine.

4 Close the ADF cover.

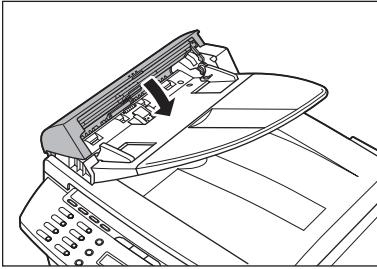

 **CAUTION**

Be careful not to get your fingers caught.

5 Open the ADF.

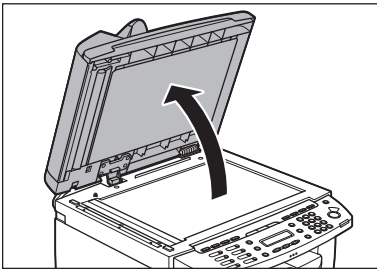

6 Clean the ADF scanning area (on the left side of the platen glass) and the document feeding roller with a cloth dampened with water. Then wipe the area with a soft, dry cloth.

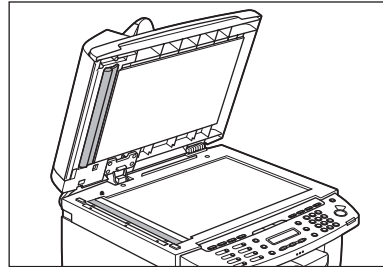

7 Close the ADF.

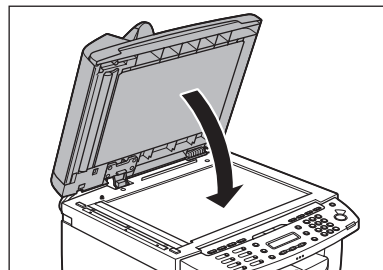

 **CAUTION**

Be careful not to get your fingers caught.

8 Reconnect the power cord and turn on the main power switch.

Replacing the Toner Cartridge

When the LCD displays <OUT OF TONER/CHANGE TONER>, or toner level is low by pressing [Toner Gauge], redistribute toner in the toner cartridge. If the message persists, replace the toner cartridge.

Redistributing Toner

- 1** Lift the scanning platform until it is locked (A), and open the printer cover (B).

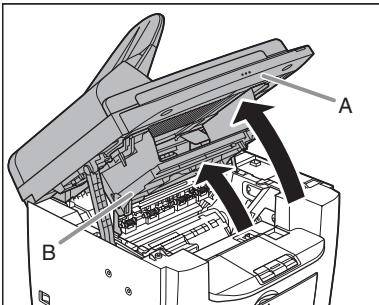

- 2** Remove the toner cartridge.

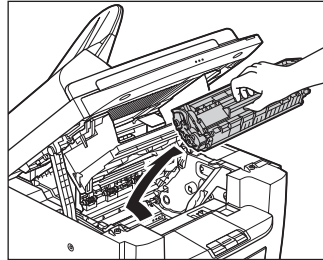

- 3** Gently rock the toner cartridge five or six times to distribute toner evenly.

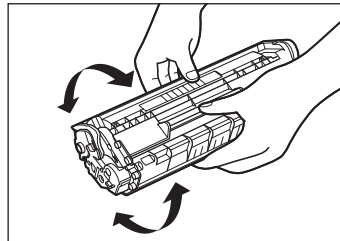

4 Hold the toner cartridge by its handle (A).

The arrow (A) on the toner cartridge should be facing away from you and pointing down.

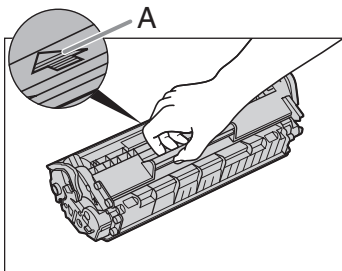

⚠ CAUTION

- Do not open the drum protective shutter on the toner cartridge. Print quality may deteriorate if the drum surface is exposed to light or is damaged.

🔧 NOTE

- Always hold the toner cartridge by its handle.

5 Insert the toner cartridge into the machine as far as it will go.

Align the guide (A) on the left side of the toner cartridge with the groove inside the machine.

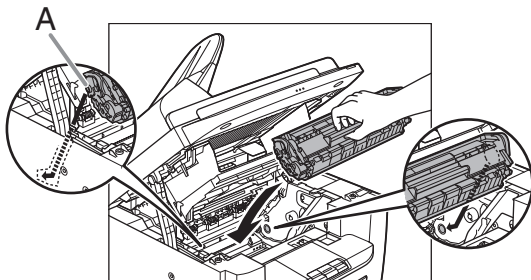

6 Push the toner cartridge to make sure it is properly set in the machine.

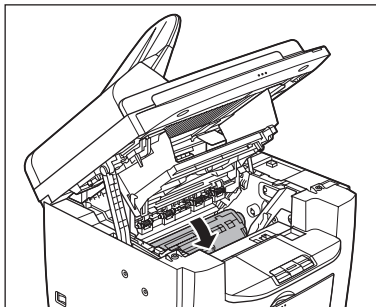

7 Close the printer cover and lower the scanning platform.

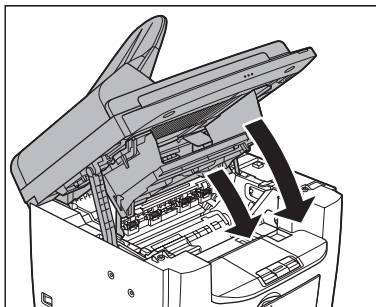

⚠ CAUTION

Be careful not to get your fingers caught.

Replacing the Toner Cartridge with a New One

- 1** Lift the scanning platform until it is locked (A), and open the printer cover (B).

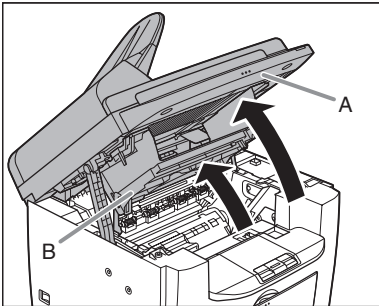

- 2** Remove the toner cartridge.

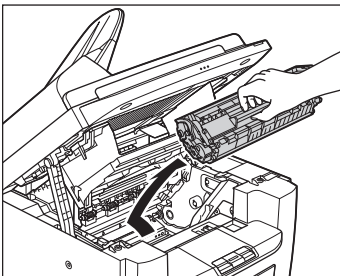

- 3** Remove the new toner cartridge from the protective bag.

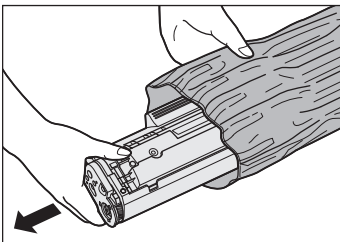

 **NOTE**

Save the protective bag. You may need it later when you remove the toner cartridge from the machine.

- 4** Gently rock the toner cartridge five or six times to distribute toner inside.

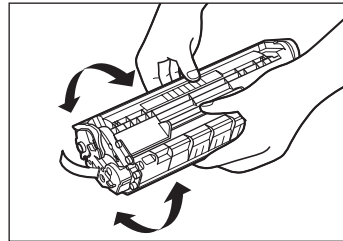

- 5** Hold the toner cartridge with one hand, and pull out the seal completely.

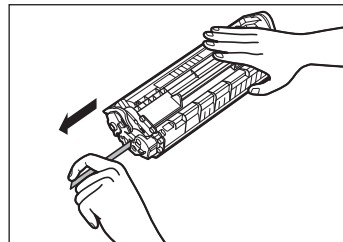

 **NOTE**

Do not pull out the seal at an angle.

6 Hold the toner cartridge by its handle.

The arrow (A) on the toner cartridge should be facing away from you and pointing down.

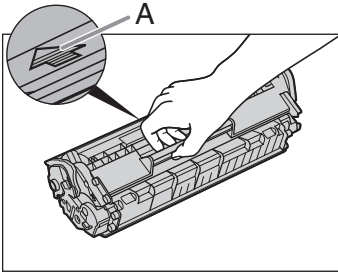

⚠ CAUTION

Do not open the drum protective shutter on the toner cartridge. Print quality may deteriorate if the drum surface is exposed to light or is damaged.

🔧 NOTE

Always hold the toner cartridge by its handle.

7 Insert the toner cartridge into the machine as far as it will go.

Align the guide (A) on the left side of the toner cartridge with the groove inside the machine.

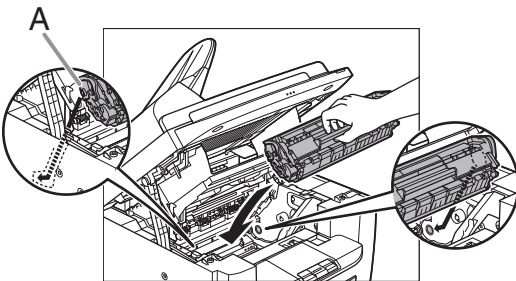

8 Push the toner cartridge to make sure it is properly set in the machine.

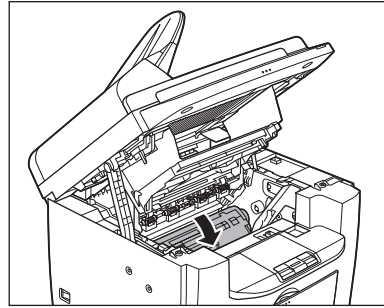

9 Close the printer cover and lower the scanning platform.

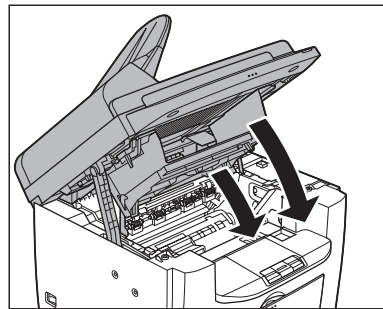

⚠ CAUTION

Be careful not to get your fingers caught.

Recycling Used Cartridges



Canon has instituted a worldwide recycling program for cartridges called “The Clean Earth Campaign.” This program preserves precious natural resources by utilizing a variety of materials found in the used cartridges that are of no further use, to remanufacture new cartridges which, at the same time, keeps the environment cleaner by reducing landfill waste. Complete details concerning this program are enclosed in each PC Cartridge box.

The Clean Earth Campaign

● THE Canon CARTRIDGE RECYCLING PROGRAM

The Canon Cartridge Recycling Program fulfills the first initiative of Canon's Clean Earth Campaign, which supports four critical environmental areas:

- Recycling in the Workplace
- Conserving Environmental Resources
- Scientific Research and Education
- Encouraging Outdoors Appreciation

The remaining “Clean Earth” initiatives are supported in the U.S. through sponsorships of the National Park Foundation, the National Wildlife Federation, and The Nature Conservancy and in Canada through donations to the World Wildlife Fund Canada and The Nature Conservancy of Canada.

Since its inception, The Canon Cartridge Recycling Program has collected millions of cartridges that otherwise would have been discarded into landfills or similar facilities. Instead, this rapidly growing program returns used cartridges to the manufacturing process, thus conserving an array of resources.

Becoming a part of this worthwhile program is easy. When your cartridge is of no further use, simply follow the instructions detailed for U.S. or Canadian residents.

We appreciate your support of The Canon Cartridge Recycling Program.

Working together we can make a significant contribution to a cleaner planet.

- Cartridges collected through this program are not refilled.
- You are not entitled to a tax deduction or rebate for the return of empty cartridges.
- This program may be modified or discontinued without notice.

The Clean Earth Campaign

Supporting Environmental Initiatives With

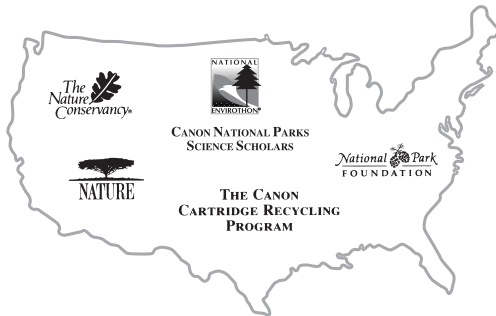

U.S.A. PROGRAM

● Packaging

■ Option A-1: Single Box Return

- Repackage the empty cartridge utilizing the wrapper and pulp mould end-blocks from the new cartridge's box.
- Place the empty cartridge in the box of your new cartridge. Seal the box.

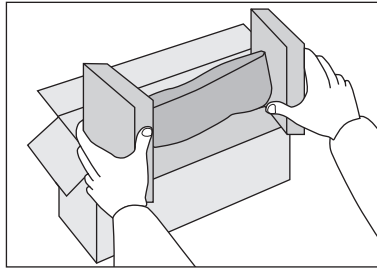

■ Option B: Volume Box Return

We encourage you to use this option as a more efficient way to ship cartridges.

- Place as many cartridges as possible into one box.
Carefully seal the box with tape;
or
- Call **1-800-OK-Canon** to receive your free eight cartridge collection box.

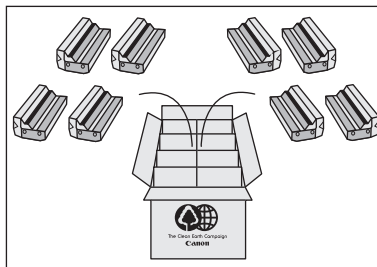

■ Option A-2: Multiple Box Return

We encourage you to use this option as a more efficient way to ship cartridges.

- Complete Option A-1.
- Bundle multiple cartridge boxes together securely with tape.

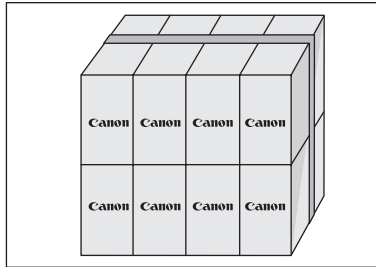

Please be sure that the shipment does not exceed UPS specifications.

Maximum weight = 70 lb. (31.8 kg)

Maximum length = 108 in. (2,743 mm)

Maximum girth (length + 2 x width + 2 x height) = 130 in. (3,302 mm)

If your shipment exceeds the above limits, please call **1-800-OK-Canon** for special shipping information.

Please Note:

Do not send defective cartridges for replacement.

Defective cartridges under warranty should be exchanged by an authorized dealer or service facility as provided in the warranty.

● Shipping

Apply the UPS authorized returning label provided in this guide.

Residents of Alaska and Hawaii: Do not use the UPS authorized returning label. For Alaska and Hawaii Canon set up alternative mail service with the U.S. Postal Service. Please call **1-800-OK-Canon** to receive U.S. Postal Service merchandise returning label.

■ Option A: UPS Pick-up

- Give the shipment to your UPS driver when you receive your next regular delivery;
or
- Take the shipment to your local UPS receiving point.



■ Option B: MBE Drop off

Take the shipment to a participating MBE (Mail Boxes, Etc.) Center. For location, please call **1-800-949-6660**.

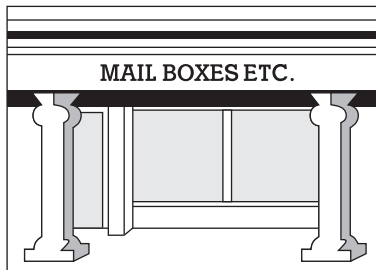

By using either of the above methods of shipment, your used cartridge(s) will be forwarded to the Canon Cartridge Collection Center at no charge to you.

For further information about the Clean Earth Campaign in the United States, please call: **1-800-OK-Canon**

CANADA PROGRAM-CANADA PROGRAMME

■ Option A: Single Box Return

- Repackage the empty cartridge utilizing the wrapper and pulp mould end-blocks from the new cartridge's box.
- Place the empty cartridge in the box of your new cartridge. Seal the box.
- Apply the Canon Canada Inc./Canada Post label provided in this brochure. Canon's labels are specially marked so that Canon pays the postage.
- Deposit your empty cartridge in any full size street mailbox or take it to your local Canada Post outlet or franchise.

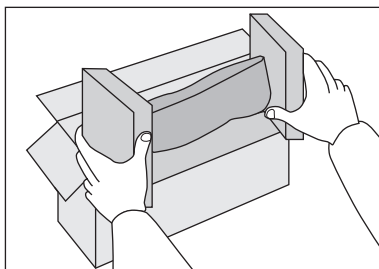

■ Option B: Volume Box Return (eight or more cartridges)

We encourage you to use this option as a more efficient way to ship cartridges.

- Call **1-800-667-2666** to receive your free Canon collection box kit.
- The collection box can accommodate eight individual cartridge boxes.
- Place your eight individually packaged boxes of empty cartridges into the Canon collection box. Seal the box.

- Apply the Canon Canada Inc./Canada Post label provided in this brochure.
- Canon's labels are specially marked so that Canon pays the postage.
- Deliver to any local Canada Post outlet or franchise. Customers who hold a Commercial pick-up agreement with Canada Post may have their collection box picked up.

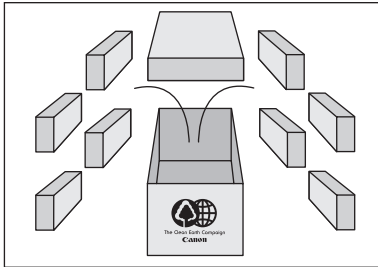

Working to preserve endangered species is a long-standing Canon interest. To this end, for every cartridge collected, Canon Canada donates \$1, shared equally between World Wildlife Fund Canada and the Nature Conservancy of Canada. This donation is utilized in Canada.

- For further information about The Clean Earth Campaign in Canada, please call or write to Canon.

1-800-667-2666

Canon Canada Inc.

Corporate Customer Relations

6390 Dixie Road

Mississauga, ON L5T 1P7

Transporting the Machine

Follow this procedure to avoid vibration damage to the machine when transporting it over a long distance.

1 Turn off the main power switch.

2 Disconnect the power cord and all the cables from the back of the machine.

3 Lift the scanning platform until it is locked (A), and open the printer cover (B).

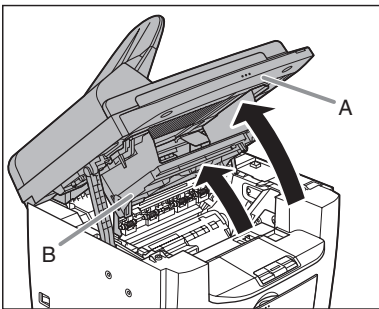

4 Remove the toner cartridge.

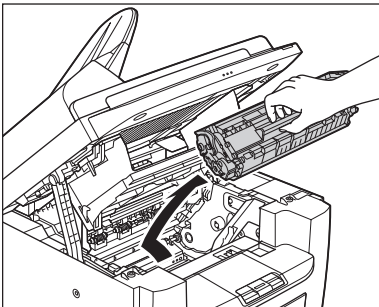

CAUTION

- To avoid exposing the toner cartridge to light, place it in its protective bag or wrap it in a thick cloth.
- Do not open the drum protective shutter on the toner cartridge. Print quality may deteriorate if the drum surface is exposed to light or is damaged.

NOTE

Always hold the toner cartridge by its handle.

5 Close the printer cover and lower the scanning platform.

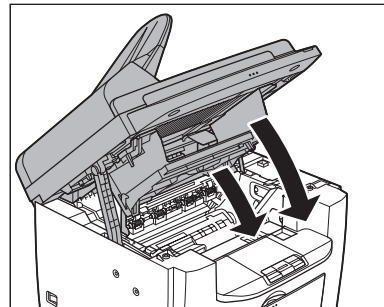

CAUTION

Be careful not to get your fingers caught.

- 6** Remove the dust cover from the paper feeding tray.

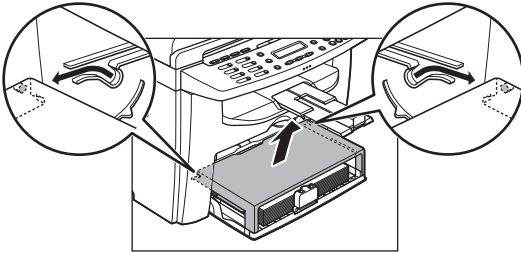

- 7** Remove the paper from the paper feeding tray.

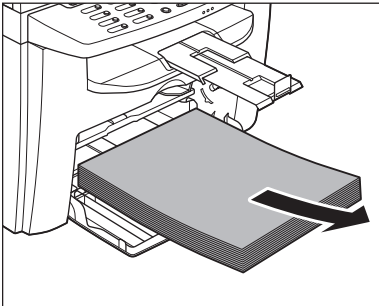

- 8** Store the dust cover inside the machine.

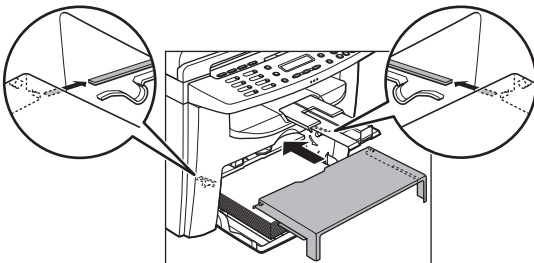

- 9** Push the paper guide rail, and then close the paper feeding tray.

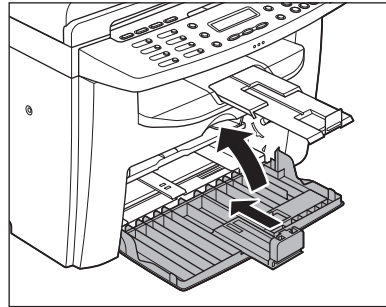

- 10** Detach the Document feeder tray.

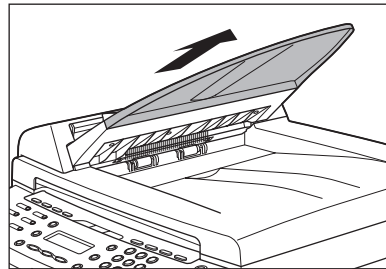

- 11** Fold the paper stopper, and then push the output tray extension into the machine.

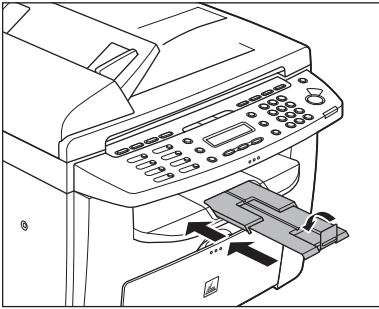

- 12** Make sure all the covers are closed.

- 13** Grip the handles on both sides of the machine and lift it carefully, as shown in the illustration below.

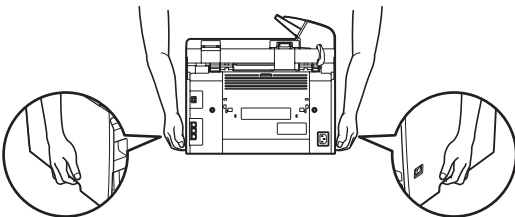

⚠ CAUTION

- Do not lift the machine by any of its attachments. Dropping the machine can cause personal injury.
- If you have a back problem, make sure to check the weight of this machine before carrying. (See “Specifications,” on p. 13-1.)

11

Troubleshooting

Clearing Jams

When <CHECK DOCUMENT>, <PAPER JAM> or <PAPER JAM/OPEN REAR COVER> appears on the LCD display, remove jammed paper from the machine first, then from the paper feeding tray or multi-purpose tray if necessary. Check the following if you experience repeated paper jams:

- Fan and tap the paper stack on a flat surface before loading it in the machine.
- Check that the paper you are using meets the requirements for use. (See “Print Media,” on p. 3-1.)
- Make sure you have removed any scraps of paper from the inside of the machine.

CAUTION

- When removing jammed documents or paper, take care not to cut your hands on the edges of the document or paper.
- When removing jammed paper or when inspecting the inside of the machine, do not allow necklaces, bracelets, or other metal objects to touch the inside of the machine, as this may result in burns or electrical shock.
- If you tear the paper, remove any torn pieces to avoid further jams.
- If loose toner comes into contact with your skin or clothing, wash with cold water. Warm water will set the toner.

NOTE

Do not force a jammed document or paper out of the machine. Contact Canon Customer Care Center if needed.

Document Jams

When <CHECK DOCUMENT> appears on the LCD display, remove a jammed document from the ADF.

- 1** Open the ADF cover.

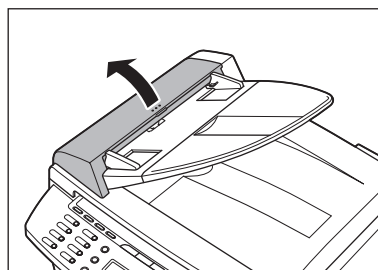

- 2** Hold both sides of any jammed documents and gently pull them out straight upward.

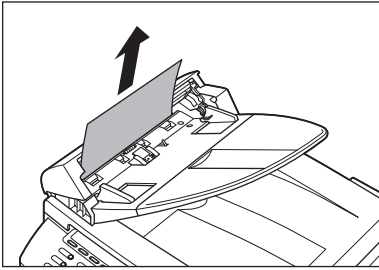

NOTE

Do not pull the document forcefully as it may tear.

- 3** Hold both sides of any jammed documents and gently pull them out.

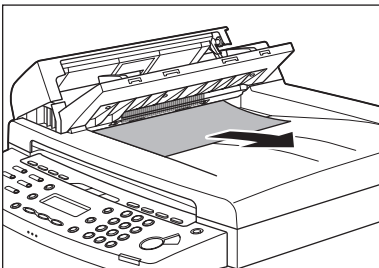

- 4** Close the ADF cover.

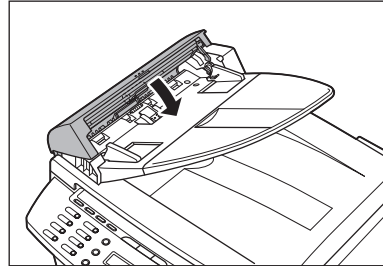

CAUTION

Be careful not to get your fingers caught.

- 5** Open the ADF and then hold both sides of any jammed documents and gently pull them out.

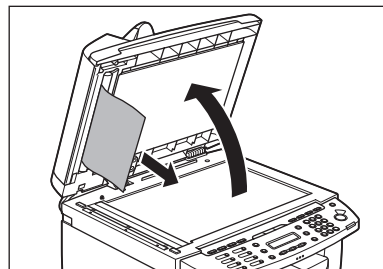

6 Close the ADF.

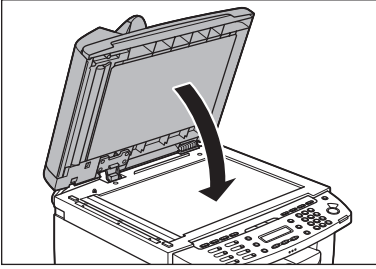

CAUTION

Be careful not to get your fingers caught.

Paper Jams

When <PAPER JAM> or <PAPER JAM/ OPEN REAR COVER> appears on the LCD display, remove jammed paper from the inside of the machine first, then from the paper feeding tray or multi-purpose tray if necessary.

1 Remove the dust cover from the paper feeding tray.

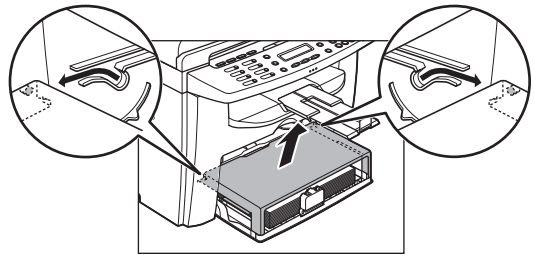

2 Remove the paper in the paper feeding tray.

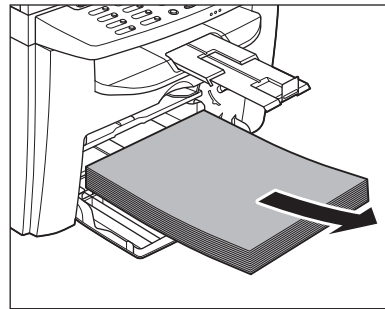

3 Open the rear cover.

This operation is required only when <PAPER JAM/OPEN REAR COVER> appears on the LCD display.

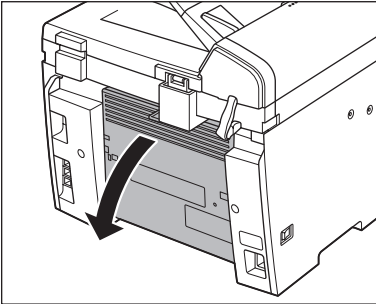

4 Lift the scanning platform until it is locked (A), and open the printer cover (B).

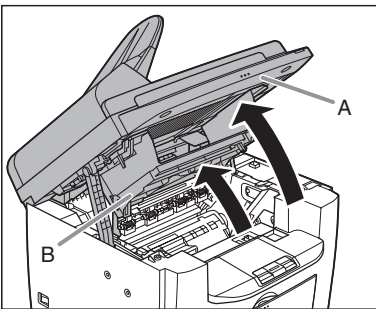

5 Remove the toner cartridge from the machine.

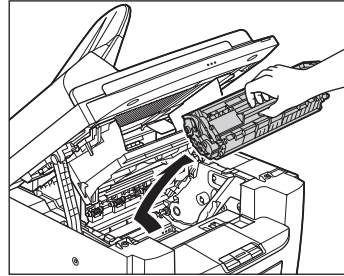

⚠ CAUTION

- Remove watches and any bracelets or rings when touching the inside of the machine. These items might be damaged if they come into contact with the parts inside of the machine.
- To avoid exposing the toner cartridge to light, place it in its protective bag or wrap it in a thick cloth.
- Do not open the drum protective shutter on the toner cartridge. Print quality may deteriorate if the drum surface is exposed to light or is damaged.

🔧 NOTE

Always hold the toner cartridge by its handle.

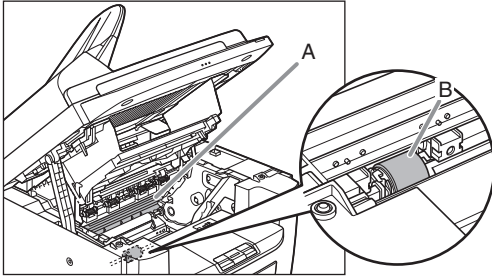

⚠ CAUTION

- Do not touch the fixing assembly (A) as it becomes very hot during use.
- Do not touch the transfer roller (B) as this can damage the machine.

6 Hold both sides of the jammed paper and gently pull it out.

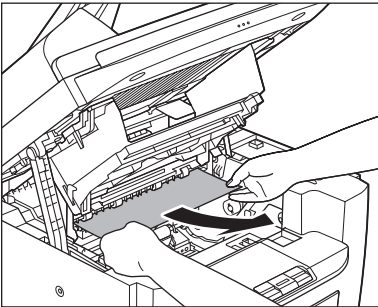

7 Gently pull the jammed paper between the fixing assembly (A) and transfer roller (B) until the leading edge emerges from the machine.

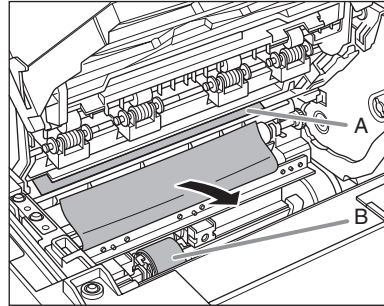

⚠ CAUTION

- Do not touch the fixing assembly (A) as it becomes very hot during use.
- Do not touch the transfer roller (B) as this can damage the machine.

8 Hold both sides of the jammed paper and carefully pull it out.

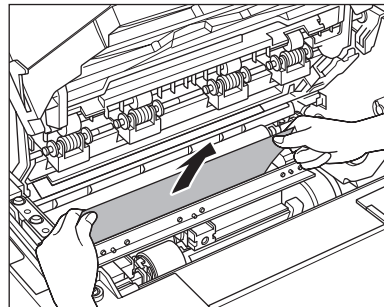

9 Hold both sides of the jammed paper and gently pull it out upward.

This operation is required only when <PAPER JAM/OPEN REAR COVER> appears on the LCD display.

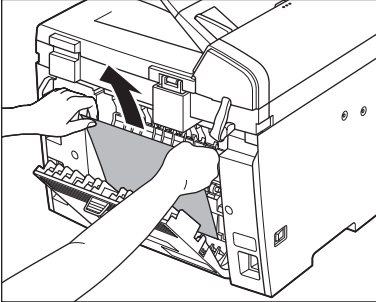

If the jammed paper is badly folded, similar to the folds of an accordion, ease the jammed paper loose and then pull it out from the machine.

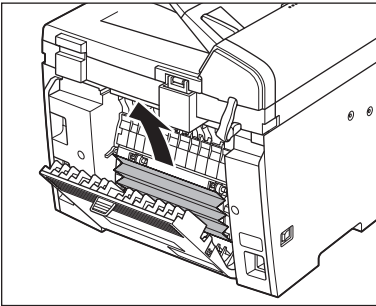

10 Hold both sides of the jammed paper and slowly pull it out in the direction of the arrow.

- When feeding paper from the paper feeding tray:

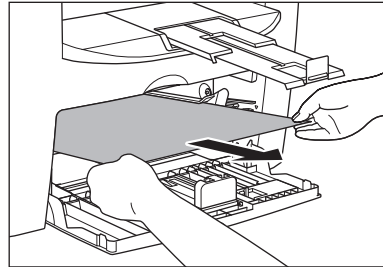

- When feeding paper from the multi-purpose tray:

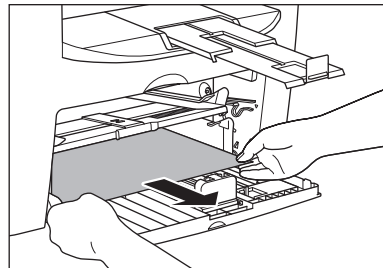

11 Hold the toner cartridge by its handle.

The arrow (A) on the toner cartridge should be facing away from you and pointing down.

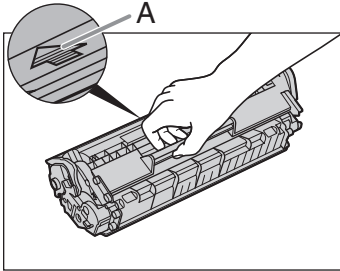

⚠ CAUTION

Do not open the drum protective shutter on the toner cartridge. Print quality may deteriorate if the drum surface is exposed to light or is damaged.

🔧 NOTE

Always hold the toner cartridge by its handle.

12 Insert the toner cartridge into the machine as far as it will go.

Align the guide (A) on the left side of the toner cartridge with the groove inside the machine.

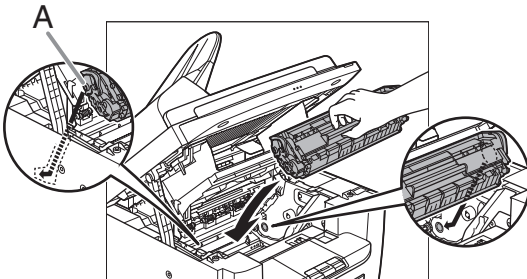

13 Push down the toner cartridge to make sure it is properly set in the machine.

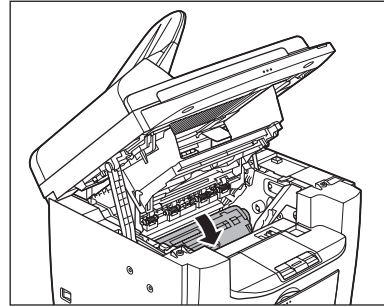

14 Close the printer cover and lower the scanning platform.

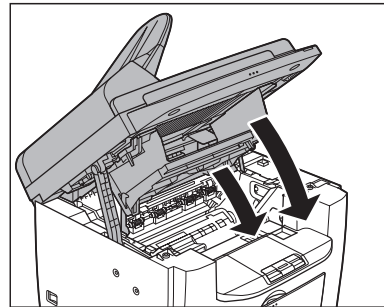

⚠ CAUTION

Be careful not to get your fingers caught.

15 Close the rear cover.

This operation is required only when <PAPER JAM/OPEN REAR COVER> appears on the LCD display.

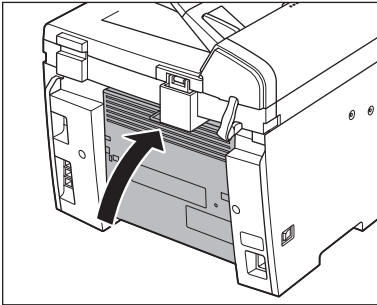

CAUTION

Be careful not to get your fingers caught.

16 Load the paper into the paper feeding tray.

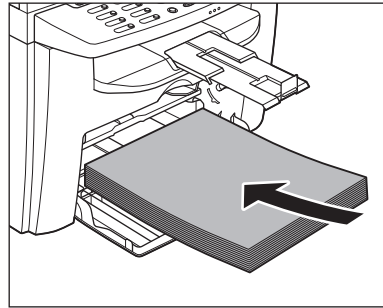

17 Set the dust cover on the paper feeding tray.

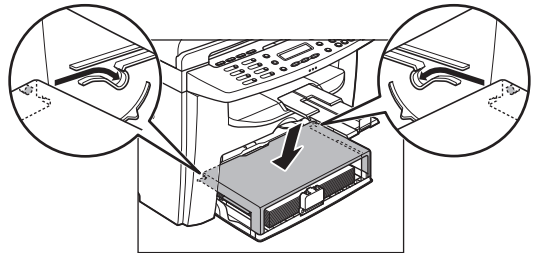

NOTE

After all the procedures are completed, the machine should be ready for operating. If the machine returns to the standby mode, troubleshooting has been successful. If the machine does not return to the standby mode, check if jammed paper is still left in the machine.

LCD Messages

See the table below when the LCD displays error messages.

Common

Message	Description	Action
CANCEL : STOP/RESET	Appears alternately with other messages.	Varies by the message that appears. For details, see the explanation for the message (i.e., <LOAD CORRECT PAPER>). To cancel copy jobs, press [Stop/Reset], then press [←].

Message	Description	Action
<p>CHANGE REG'D SIZE -> PAPER SETTINGS</p>	<p>The paper size selected in <CASSETTE> or <MP TRAY> of the <PAPER SETTINGS> menu is not correct.</p>	<ul style="list-style-type: none"> - For printing received documents, reports, or lists, set the paper size to <LTR>, <LGL>, <A4>, <OFICIO>, <BRAZIL-OFICIO>, <MEXICO-OFICIO>, <FOLIO>, <GOVERNMENT-LETTER>, <GOVERNMENT-LEGAL>, or <FOOLSCAP> in <CASSETTE> of the <PAPER SETTINGS> menu. (See "Setting Paper Size and Type," on p. 3-7.) - For the two-sided printing for faxing, set the paper size to <LTR> or <A4> in <CASSETTE> of the <PAPER SETTINGS> menu. (See "Setting Paper Size and Type," on p. 3-7.) - For the two-sided copying, set the paper size to <LTR> or <A4> in <CASSETTE> or <MP TRAY> of the <PAPER SETTINGS> menu. (See "Setting Paper Size and Type," on p. 3-7.)



Message	Description	Action
CHECK DOCUMENT	A document jam may have occurred in the ADF.	Remove the jammed document.
CLOSE COVER PRINTER COVER	The printer cover is not closed completely.	Check the printer cover, and make sure that it is completely closed.
LIFT PANEL TO OPEN OPEN PRINTER COVER	Appears alternately with other messages.	Varies by the message that appears. For details, see the explanation for the message (i.e., <OUT OF TONER/ CHANGE TONER>).
LOAD CORRECT PAPER	The size of the paper in the paper feeding tray or multi-purpose tray is different from that of the paper specified in <CASSETTE> or <MP TRAY> of the <PAPER SETTINGS> menu.	<ul style="list-style-type: none"> – Load the correct paper size or change the paper size in <CASSETTE> or <MP TRAY> of the <PAPER SETTINGS> menu. For more information, see “Setting Paper Size and Type,” on p. 3-7. – If you are trying to print a report or list, set the paper size to <LTR>, <LGL>, <A4>, <OFICIO>, <BRAZIL-OFICIO>, <MEXICO-OFICIO>, <FOLIO>, <GOVERNMENT-LETTER>, <GOVERNMENT-LEGAL> or <FOOLSCAP> and then load paper of the same size. <p>Then press [OK] to continue printing.</p>

Message	Description	Action
LOAD PAPER	No paper is loaded in the paper feeding tray or multi-purpose tray, or not inserted correctly.	<p>Load paper in the paper feeding tray or multi-purpose tray. (See “Loading Paper,” on p. 3-4.) Make sure the paper stack in the paper feeding tray does not exceed the capacity of the paper feeding tray.</p> <p>Load paper in the multi-purpose tray one by one. If you load paper while making copies, do not load a different paper size.</p> <p>On the second line in the LCD the message <CASSETTE> or <MP TRAY> and the paper size may appear. In this case, load the corresponding paper in the paper feeding tray or multi-purpose tray.</p>
LOST IMAGE	The data in memory was lost when the machine was turned on.	The error is automatically released after two seconds, and the machine automatically prints out the lost report that shows the records still existing in the activity report.



Message	Description	Action
MEMORY FULL	<ul style="list-style-type: none"> – The number of the scanned document that can be stored in memory reached the maximum. – The machine's memory is full of scanned documents when you use the sort copy function. 	Divide the document and copy each part separately.
OUT OF TONER CHANGE TONER	<ul style="list-style-type: none"> – The toner cartridge is almost empty. – If <CONT. PRINTING> is set to <OFF> in the <PRINTER SETTINGS> of the <FAX SETTINGS> menu, the Fax printing and printing reports are interrupted when the <OUT OF TONER/ CHANGE TONER> appears. 	<ul style="list-style-type: none"> – Replace with a new toner cartridge. – If you want to continue printing without replacing the toner cartridge, set <CONT. PRINTING> to <ON> in the <PRINTER SETTINGS> of the <FAX SETTINGS> menu. However, the toner cartridge is almost empty, so you should replace the toner cartridge with a new one.
PAPER JAM	Paper jams have occurred in the machine.	Clear the paper jam (See "Clearing Jams," on p. 11-1) and reload paper in the paper feeding tray or multi-purpose tray. Then reset the machine by opening the printer cover and then closing it.

Message	Description	Action
PAPER JAM OPEN REAR COVER	Paper jams have occurred in the machine when making two-sided copying or two-sided printing.	Clear the paper jam (See “Clearing Jams,” on p. 11-1.) and reload paper in the paper feeding tray or multi-purpose tray. Then reset the machine by opening the printer cover and then closing it.
PLEASE WAIT	This message appears when the main power switch is turned on or when the machine is not ready for printing.	Wait until the message disappears.
REMOVE MP PAPER	Paper is loaded in the multi-purpose tray.	Remove the paper from the multi-purpose tray. The machine will not print faxes, reports, or lists when paper is loaded in the multi-purpose tray. They will be stored in memory.
RESUME : OK	Appears alternately with other messages.	Varies by the message that appears. For details, see the explanation for the message (i.e., <LOAD PAPER>).



Message	Description	Action
SYSTEM ERROR EXXX	A system error has occurred. <XXX> will be a three-digit code that indicates a particular type of error.	Turn off the main power switch. Wait for at least five seconds, and then turn it on again. If the message persists, turn off the main power switch, disconnect the power cord, and contact Canon Customer Care Center.
TONER IS NOT SET INSERT TONER	A toner cartridge is not installed or not installed correctly.	Install the toner cartridge correctly. (See “Replacing the Toner Cartridge,” on p. 10-8.)
WRONG NUMBER ENTRY	An invalid number was entered in the <DATE&TIME SETTING> of the <TIMER SETTINGS> menu.	Enter a correct date or time.

Facsimile

Message	Description	Action
ALREADY REGISTERED	The same recipient was entered twice.	Select a different recipient.
CANNOT REGIST MORE	<ul style="list-style-type: none"> – Maximum number of recipients (124) were entered for broadcasting. – Maximum number of recipients (50) were registered for group dialing. 	<ul style="list-style-type: none"> – Resend the document to other recipients if necessary. – Register a different one-touch speed dialing key for group dialing.
CANNOT USE THIS KEY	Redialing is not available with [Redial/Pause]. This message appears when <RESTRICT REDIAL> is set to <ON> in the <TX SETTINGS> of the <FAX SETTINGS> menu.	Dial the number manually.
CHECK TEL NUMBER	The fax number entered at the second time is different from the one entered at the first time. This message appears when <CONFIRM NEW DEST.> is set to <ON> in the <TX SETTINGS> of the <FAX SETTINGS> menu.	Check if the fax number is correct, then enter the same fax number as the first one after pressing [Start].
HANG UP PHONE	External telephone is off the hook.	Hang up the phone.



Message	Description	Action
MEMORY FULL	<ul style="list-style-type: none"> - The memory becomes full during sending or receiving the fax. - The number of fax jobs that can be stored in memory reached the maximum. 	<ul style="list-style-type: none"> - When sending the document, divide it into a few parts or select a lower fax resolution. If you need more space, wait for the machine to send any remaining faxes. - The machine memory can store up to 256 fax jobs including sending and receiving jobs. (Based on the condition that the other party sends the fax by the imageCLASS MF4150 with ITU-T Standard Chart No.1, standard mode.) Wait for the machine to send any faxes in memory. Also print or delete any documents in memory.
NOT AVAILABLE	<p>You pressed the one-touch speed dialing key that has already been registered, when you specify a one-touch speed dialing key as the group dial.</p>	<p>Check the information registered under the one-touch speed dialing before using.</p>

Message	Description	Action
NOT REGISTERED	No recipient is registered in the selected speed dialing key or code.	Select a registered key or code. For more information, “Registering One-Touch Speed Dialing,” on p. 4-7 or “Registering Coded Dialing,” on p. 4-14.
RECEIVED IN MEMORY	The received fax documents or the reports are in memory because paper or toner ran out, paper jams occurred, or incorrect paper size was loaded.	Load correct paper size in the paper feeding tray, replace the toner cartridge, or clear the paper jams. For more information, see the following: <ul style="list-style-type: none"> – “Loading Documents,” on p. 2-4. – “Replacing the Toner Cartridge with a New One,” on p. 10-10. – “Clearing Jams,” on p. 11-1.
REGISTERING KEY CANNOT REGISTER	The selected one-touch speed dialing key is already used as the group dialing key it is being assigned to.	Select a different one-touch speed dialing key.

Printer

Message	Description	Action
CANCEL : SYS.MONITOR	Appears alternately with other messages.	Varies by the message that appears. For details, see the explanation for the message (i.e., <LOAD CORRECT PAPER>). To cancel printing from a computer, see Chapter 3, "System Monitor," in the Advanced Guide.
PRINTER DATA ERROR CHECK PRINTER	The data from the PC was not printed.	Check if the software is installed properly or if the printer cable is properly connected.
PRINTING	The printer is processing a print job.	No action required. Wait for printing to finish.

Error Codes

An error code is a four-digit code displayed on the LCD or in the bottom row of a TX Report or an RX Report when an error occurs.

Ex.

JOB NO.	TYPE	NO.	DESTINATION TEL/ID	DATE	TIME	PAGE	TIME USE	MODE	RESULT
0001	TX	001	WEST-1 55555555	04/10	16:00	002	02'21	ECM	NG
			00A0 TX CANCEL						

Error Code

For details on TX Report and RX Report, see Chapter 4, “Reports and Lists,” in the Advanced Guide.

See the table below for individual error codes.

Error Code	Description	Action
0001	The sender may not be using a G3 fax machine.	Make sure the sender’s machine is compatible with your machine.
0070	Reception was manually canceled on the machine.	Ask the sender to resend the document if necessary.
0071	The machine’s memory is full.	Print, send, or delete any documents stored in memory.
0080	The recipient’s machine did not respond within 35 seconds.	Resend the document. Ask the other party to check their machine. If you are making an overseas call, add a pause to the number.
008D	The recipient’s machine has run out of paper.	Ask the recipient to make sure that paper is loaded in their machine.
00A0	Transmission was manually canceled on the machine.	Resend the document if necessary.
00A1	There is a document jam.	Clear the document jam.
00FF	All redialing attempts have failed.	Check if the recipient’s number is correct or the telephone cable is properly connected, and try again.

If You Cannot Solve a Problem

Customer Support (U.S.A.)

If you cannot solve the problem after having referred to the information in this chapter, contact Canon Customer Care Center at 1-800-828-4040 between the hours of 8:00 A.M. to 8:00 P.M. EST Monday through Friday and 10:00 A.M. to 8:00 P.M. on Saturday. On-line support for 24 hours is also available at the website.
<http://www.canontechsupport.com/>

Customer Support (Canada)

Canon Canada Inc., offers a full range of customer technical support options*:

- For step-by-step troubleshooting, e-mail technical support, the latest driver or document downloads, and answers to frequently asked questions, visit <http://www.canon.ca/>
- Free live technical support 9 A.M. to 8 P.M. EST Monday through Friday (excluding holidays) for products still under warranty 1-800-652-2666
- For the location of the authorized service facility nearest you, visit <http://www.canon.ca/> or 1-800-652-2666
- If the problem cannot be corrected by using one of the above technical support options, repair options are available at the time of your call to the live technical support number above or via the website at <http://www.canon.ca/>

* Support program specifics are subject to change without notice.

Please have the following information ready when you contact Canon:

- Product name (imageCLASS MF4150)
- Serial number (On the label located at the back of the machine)
- Place of purchase
- Nature of problem
- Steps you have taken to solve the problem and the results

 **CAUTION**

If the machine makes strange noises, emits smoke or odd odor, turn off the main power switch immediately, disconnect the power cord, and contact Canon Customer Care Center. Do not attempt to disassemble or repair the machine yourself.

 **NOTE**

Attempting to repair the machine yourself may void the limited warranty.

12 Machine Settings

Machine Settings

You can adjust the machine settings from the Setting Menu to customize the way the machine works. To see the list of current settings, print out User's Data List.

Printing User's Data List

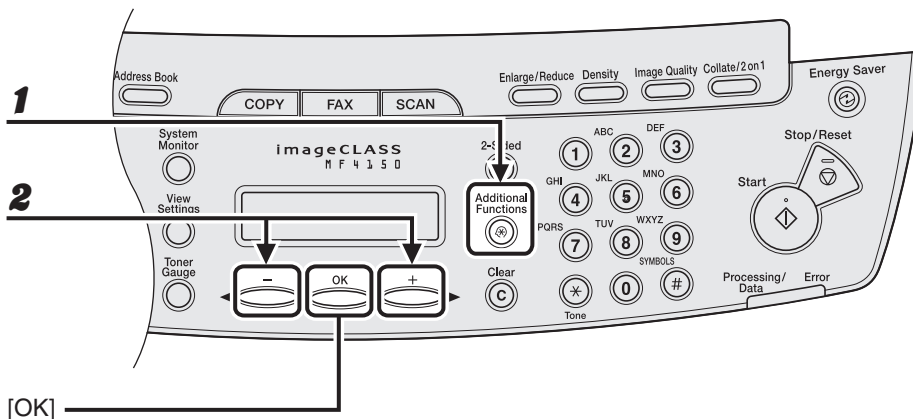

- 1** Press [Additional Functions].
- 2** Press [←] or [→] to select <REPORT SETTINGS>, then press [OK].

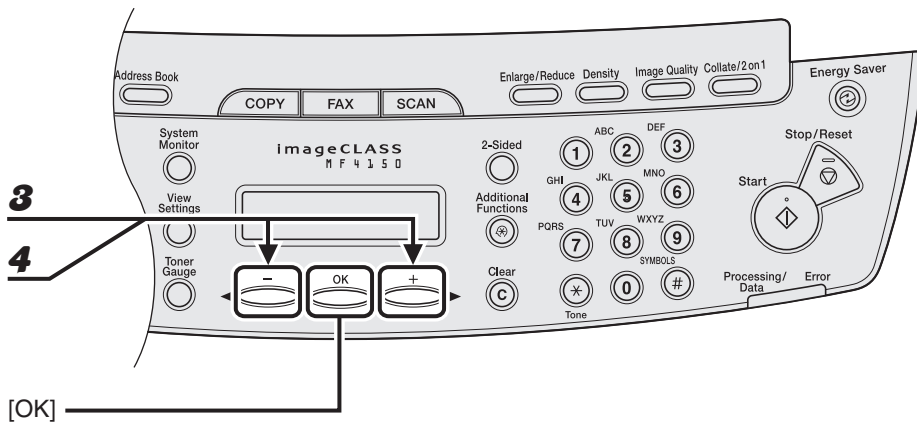

- 3** Press [◀] or [▶] to select <LIST PRINT>, then press [OK].
- 4** Press [◀] or [▶] to select <USER'S DATA LIST>, then press [OK].

Accessing the Setting Menu

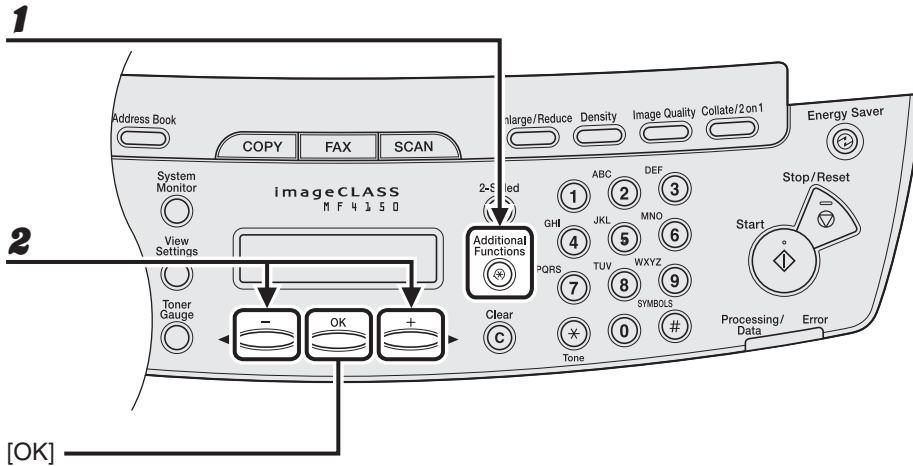

1 Press [Additional Functions].

2 Press [←] or [→] to select the menu you want to access, then press [OK].

- <PAPER SETTINGS>
- <COMMON SETTINGS>
- <COPY SETTINGS>
- <TIMER SETTINGS>
- <FAX SETTINGS>
- <BROADCAST>
- <ADDRESS BOOK SET.>
- <ADJUST./CLEANING>
- <REPORT SETTINGS>

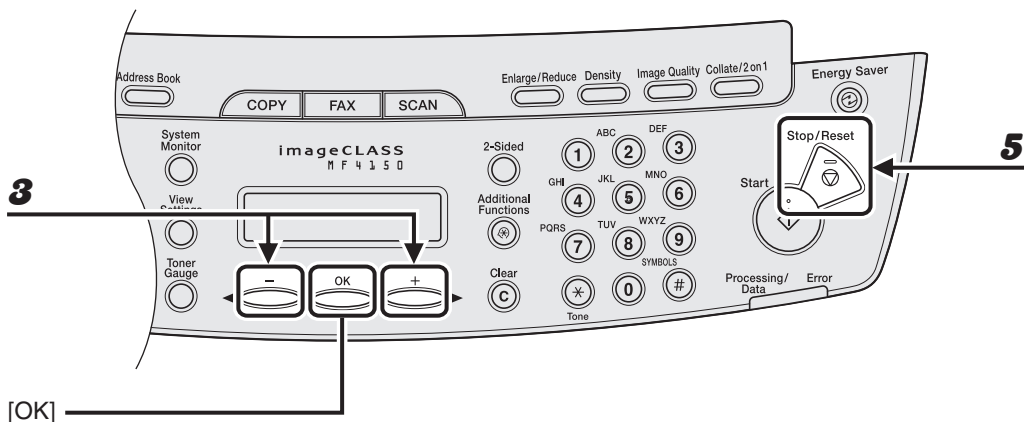

- 3** Press [◀] or [▶] to select a submenu, then press [OK].
- 4** To register the settings or go to a submenu item, press [OK].
- 5** When finished, press [Stop/Reset] to return to the standby mode.

 **NOTE**

Press [Stop/Reset] to exit from the menu. If you press [Stop/Reset] before pressing [OK], the setting will not be registered.

Setting Menu

 **NOTE**

Depending on the country of purchase, some settings may not be available.

PAPER SETTINGS	
Setting Item	Description
1 CASSETTE	Sets the paper type and size on the paper feeding tray. (See “Setting Paper Size and Type,” on p. 3-7.)
2 MP TRAY	Sets the paper type and size on the multi-purpose tray. (See “Setting Paper Size and Type,” on p. 3-7.)

COMMON SETTINGS	
Setting Item	Description
1 DEFAULT SETTINGS	Selects which standby display appears when the main power switch is turned on. <ul style="list-style-type: none">– COPY– FAX– SCAN
2 TONER SAVER MODE	Sets whether to reduce toner consumption. <ul style="list-style-type: none">– OFF– ON
3 DISPLAY LANGUAGE	Selects the language on the display. (See “Specifications,” on p. 13-1.)

COMMON SETTINGS	
4 VOLUME CONTROL	Sets volumes for machine beeps in four levels. <ul style="list-style-type: none"> – NORMAL – HIGH – OFF – LOW
CALLING TONE	Sets the calling volume.
MONITOR VOL. CTRL	Sets the line monitor volume.
ENTRY TONE	Sets the keypad volume.
ERROR TONE	Sets the alarm volume.

COPY SETTINGS	
Setting Item	Description
1 STANDARD SETTINGS	Sets the default setting for copying.
DENSITY	Sets the density for copying. <ul style="list-style-type: none"> – MANUAL (1-9) – AUTO* <p>* When <AUTO> is set, the Image Quality mode is automatically set to <TEXT>.</p>
IMAGE QUALITY	Sets the document type for copying. <ul style="list-style-type: none"> – TEXT/PHOTO* – TEXT – PHOTO* – TEXT/PHOTO+* <p>* When <TEXT/PHOTO>, <PHOTO>, or <TEXT/PHOTO+> is set, the Density mode is automatically set to <MANUAL>.</p>
AUTO COLLATE	Sets whether to collate the copies automatically. <ul style="list-style-type: none"> – OFF – ON
2 - SIDED	Sets the type of two-sided printing. <ul style="list-style-type: none"> – OFF – ON



COPY SETTINGS

2 PAPER SIZE GROUP	Selects a paper size group for your machine.* <ul style="list-style-type: none">– INCHES– A– AB * If the paper size group is changed, the available preset copy ratios will also change.
--------------------	--

TIMER SETTINGS

Setting Item	Description
1 AUTO SLEEP	Sets auto sleep when the machine remains idle for a certain period of time. (3 MIN.–30 MIN.) (See “Setting the Sleep Mode,” on p. 1-11.) <ul style="list-style-type: none">– ON– OFF
2 DATE&TIME SETTING	Sets the current date and time. (See “Connect Power Cord,” in the Starter Guide.)
3 DATE TYPE SELECT	Sets the date format. <ul style="list-style-type: none">– MM/DD/YYYY– DD/MM YYYY– YYYY MM/DD
4 DAYLIGHT SV. TIME	Sets daylight saving time mode. (See “Setting Daylight Saving Time,” on p. 1-14.) <ul style="list-style-type: none">– OFF– ON

FAX SETTINGS	
Setting Item	Description
1 BASIC SETTINGS	Registers your fax number and name.
UNIT TELEPHONE #	Registers your fax number. (See “Set the Machine for Sending Faxes,” in the Starter Guide.)
UNIT NAME	Registers your name/company name. (See “Set the Machine for Sending Faxes,” in the Starter Guide.)
STANDARD SETTINGS	Sets the default setting for faxing.
DENSITY	Sets the default density for faxing. (1-9)
IMAGE QUALITY	Sets the default image quality for faxing. – STANDARD – FINE – PHOTO – SUPER FINE
2 TX SETTINGS	Sets the transmission functions.
AUTO REDIAL	Sets whether to redial automatically when the other line is busy or a transmission error occurs. (See Chapter 1, “Advanced Fax Features,” in the Advanced Guide.)
ON	Customizes the redial operation.
REDIAL TIMES	Sets the number of retries. (1 TIMES–10 TIMES)
REDIAL INTERVAL	Sets period of time before redialing. (2 MIN.–99 MIN.)
OFF	After the first attempt at dialing fails, redialing is not attempted.
DIALING LINE CHCK	Sets whether to check the telephone line condition. – OFF – ON



FAX SETTINGS	
RESTRICT REDIAL	Sets whether to disable the redial function of the [Redial/ Pause] key. – OFF – ON
CONFIRM NEW DEST.	Sets whether to prompt you to enter the fax number again after pressing [Start] key. – OFF – ON
3 RX SETTINGS	Sets the reception functions.
INCOMING RING	Sets whether the telephone rings when it receives a voice call, enabling you to answer the call. This function is only available when the <RX MODE> is set to <FaxOnly>.
OFF	The telephone does not ring when it receives a voice call.
ON	The telephone rings when it receives a voice call if an external telephone is connected.
RING COUNT	Sets the number of incoming ring before the machine answers. (1 TIMES–16 TIMES)
RX PRINT	Sets whether to store all received pages in memory before printing them out or print each page as it is received. (See Chapter 1, “Advanced Fax Features,” in the Advanced Guide.)
MEMORY RX	Print after all the pages of the document are received.
PRINT RX	Print each page as it is received.

FAX SETTINGS	
RX MODE	<p>Selects the receive mode. (See Chapter 1, “Advanced Fax Features,” in the Advanced Guide.)</p> <ul style="list-style-type: none"> – FaxOnly – AnsMode – DRPD – FAX/TEL – MANUAL
RX TERMINAL ID	<p>Sets whether to insert the machine’s fax number and the sender information on received faxes.</p> <ul style="list-style-type: none"> – OFF – ON
RX RESTRICTION	<p>You can reject faxes from senders with no fax/telephone number in their sender information. (See Chapter 1, “Advanced Fax Features,” in the Advanced Guide.)</p>
OFF	All receptions are conducted.
ON	Receives the fax only from the sending fax machine that sends the TSI signal.
REMOTE RX	<p>Sets whether to use remote receiving. (See Chapter 1, “Advanced Fax Features,” in the Advanced Guide.)</p> <ul style="list-style-type: none"> – ON – OFF



FAX SETTINGS	
4 PRINTER SETTINGS	Sets the printer functions.
RX REDUCTION	Sets whether to reduce or truncate the image when a faxed page is larger than the size of paper loaded. (See Chapter 1, "Advanced Fax Features," in the Advanced Guide.)
ON	Reduces the image to fit on the size of paper loaded.
OFF	Retains the original size of the image.
CUT	The image that is larger than 1-page record area is cut and not recorded.
CONT. PRINTING	Sets whether to continue printing when toner has run out. This function is only for Fax printing and printing reports. (See Chapter 5, "Troubleshooting," in the Advanced Guide.) – OFF – ON
2 - SIDED PRINT	Sets the type of two-sided printing for faxing. (See Chapter 1, "Advanced Fax Features," in the Advanced Guide.) – OFF – ON
5 COMMUNICATIONS	Sets the communication setting.
TEL LINE TYPE	Selects the telephone line type. (See "Set the Machine for Sending Faxes," in the Starter Guide.)
TOUCH TONE	The telephone line is set for touch tone dialing.
ROTARY PULSE	The telephone line is set for rotary pulse dialing.

BROADCAST	
Setting Item	Description
BROADCAST	Registers destinations for broadcasting.

ADDRESS BOOK SET.	
Setting Item	Description
1 1-TOUCH SPD DIAL	Registers the information on one-touch speed dialing. Up to 8 destinations can be registered. (See “Registering One-Touch Speed Dialing,” on p. 4-7.)
NAME	Registers the recipient’s name (max. 20 characters, including spaces).
TEL NUMBER ENTRY	Registers the recipient’s fax number (max. 50 digits, including spaces).
2 CODED DIAL	Registers the information on coded dialing. Up to 100 destinations can be registered. (See “Registering Coded Dialing,” on p. 4-14.)
NAME	Registers the recipient’s name (max. 20 characters, including spaces).
TEL NUMBER ENTRY	Registers the recipient’s fax number (max. 50 digits, including spaces).
3 GROUP DIAL	Registers the information on group dialing. Up to 50 destinations can be registered. (See “Registering Group Dialing,” on p. 4-21.)
NAME	Registers the group name (max. 20 characters, including spaces).

ADJUST./CLEANING

Setting Item	Description
1 FIX.UNIT CLEANING	Cleans the fuser roller. (See "Fuser Roller," on p. 10-4.)
2 SPECIAL MODE T	Sets whether to prevent blur from appearing on the printouts. When this setting is set to <on>, the density of printouts may become light. – OFF – ON
3 SPECIAL MODE U	Select to improve print quality in high temperature and high humidity conditions or in low temperature and low humidity conditions.
OFF	Select in normal condition.
MODE1	Select to improve print quality in low temperature and low humidity conditions, or when using thick paper or an envelope.
MODE2	Select to improve print quality in high temperature and high humidity conditions.
4 SPECIAL MODE V	Sets whether to prevent small size paper (B5, A5, EXECUTIVE, etc) from being curled. – OFF – ON

REPORT SETTINGS	
Setting Item	Description
1 SETTINGS	Sets the report functions. (See Chapter 4, "Reports and Lists," in the Advanced Guide.)
TX REPORT	Sets whether the fax transmission report prints out. – PRINT ERROR ONLY – OUTPUT NO – OUTPUT YES
RX REPORT	Sets whether the fax reception report prints out. – OUTPUT NO – OUTPUT YES – PRINT ERROR ONLY
ACTIVITY REPORT	Sets whether to automatically print the fax transaction report. – OUTPUT YES – OUTPUT NO
2 LIST PRINT	Prints reports/lists.
TX REPORT	Prints the fax transmission report manually.
RX REPORT	Prints the fax reception report manually.
ACTIVITY REPORT	Prints the fax transaction report manually.
MEMORY DATA LIST	Prints the list of the reserved jobs in memory.
MEMORY IMAGE PRNT	Prints the information and image of the first page of the reserved job.
1-TOUCH LIST	Prints the list of fax/telephone numbers and names registered for one-touch speed dialing.
CODED DIAL LIST	Prints the list of fax/telephone numbers and names registered for coded dialing.
GROUP DIAL LIST	Prints the list of groups registered for group dialing.
USER'S DATA LIST	Prints the setting list registered in the menu. (See "Printing User's Data List," on p. 12-1.)

13 Appendix

Specifications

General	
● Type	Personal Desktop
● Power Source	120 - 127 V, 60 Hz (Power requirements differ depending on the country in which you purchased the product.)
● Power Consumption	Max: Less than 680 W
● Warm-up Time	Less than 9.0 sec.* (temperature: 68°F (20°C), humidity: 65%; from when the main power switch is turned on until standby display appears) * Warm-up time may differ depending on the condition and environment of the machine.
● Weight	Approx. 29.5 lb (13.4 kg) (including toner cartridge)
● Dimensions	14 ⁵ / ₈ in. (H) x 17 in. (D) x 15 ³ / ₈ in. (W) (370mm (H) x 432 mm (D) x 390 mm (W)) (with the document feeder tray attached)
● Installation Space	33 ⁵ / ₈ in. (D) x 23 ¹ / ₄ in. (W) (855 mm (D) x 590 mm (W))

General	
● Environmental Conditions	Temperature: 46°F–95°F (7.5°C–35°C) Humidity: 5%–90% RH
● Display Languages	ENGLISH/FRENCH/SPANISH/PORTUGUESE
● Acceptable Documents	» p. 2-1.
● Acceptable Paper Stock	» p. 3-1.
● Printable Area	» p. 3-2.
● Scanning Area	» p. 2-3.

Copier	
● Scanning Resolution	TEXT/PHOTO mode: 300 dpi x 300 dpi TEXT mode, PHOTO mode, TEXT/PHOTO+ mode: 600 dpi x 600 dpi
● Printing Resolution	600 dpi x 600 dpi
● Magnification	1:1 ± 1.0%, 1:2.00, 1:1.29, 1:0.78, 1:0.64, 1:0.50 Zoom 0.50–2.00, 1% increments
● First Copy Time	Platen glass: less than 9 sec. (LTR)
● Copy Speed	Direct: LTR 21 cpm
● No. of Copies	Max. 99 copies

Printer	
● Printing Method	Indirect electrostatic method (On-demand fixing)
● Paper Handling	<ul style="list-style-type: none"> – Paper feeding tray: 250 sheets (Height: max. 1" (25 mm)) – Multi-purpose tray: 1 sheet
● Paper Delivery	100 sheets (17 to 21 lb bond (64 to 80 g/m ²))
● Print Speed	See "Copy Speed," on p. 13-2.
● Printing Resolution	600 dpi x 600 dpi
● Number of Tones	256
● Toner Cartridge	» p. 1-8.

Facsimile	
● Applicable Line	Public Switched Telephone Network (PSTN)* ¹
● Compatibility	G3
● Data Compression Schemes	MH, MR, MMR
● Modem Speed	33.6 Kbps Automatic fallback
● Transmission Speed	Approx. 3 seconds/page* ² at 33.6 Kbps, ECM-MMR, transmitting from the memory
● Transmission/ Reception Memory	Maximum approx. 256 pages* ² (total pages of transmission/reception)

Facsimile	
<p>● Fax Resolution</p>	<p>STANDARD: 203 pels/in. x 98 lines/in. (8 pels/mm x 3.85 lines/mm) FINE: 203 pels/in. x 196 lines/in. (8 pels/mm x 7.7 lines/mm) PHOTO: 203 pels/in. x 196 lines/in. (8 pels/mm x 7.7 lines/mm) SUPER FINE: 203 pels/in. x 392 lines/in. (8 pels/mm x 15.4 lines/mm)</p>
<p>● Dialing</p>	<ul style="list-style-type: none"> – Speed dialing One-touch speed dialing (8 destinations) Coded dialing (100 destinations) Group dialing (50 destinations) Address Book dialing (with Address Book key) <ul style="list-style-type: none"> – Regular dialing (with numeric keys) – Automatic redialing – Manual redialing (with Redial/Pause key) – Sequential broadcast (124 destinations) – Automatic reception – Remote reception by telephone (Default ID: 25) – ACTIVITY REPORT (after every 60 transactions) – TX (Transmission)/RX (Reception) REPORT – TTI (Transmit Terminal Identification)

Telephone

● Connection

– External telephone/answering machine/data modem

*1 The Public Switched Telephone Network (PSTN) currently supports 28.8 Kbps modem speed or lower, depending on telephone line conditions.

*2 Based on ITU-T Standard Chart No. 1, MMR standard mode.



NOTE

Specifications are subject to change without notice.

Symbols & Numerics

[2-Sided] key 1-4

A

Accessing

Setting Menu 12-3

[Additional Functions] key 1-4

[Address Book] key 1-6

ADDRESS BOOK SET. 12-3, 12-12

ADF 2-6

ADF (Automatic Document Feeder) 1-1

ADJUST./CLEANING 12-3, 12-13

B

BROADCAST 12-3, 12-12

C

CHANGE TONER message 10-8

Clean Earth Campaign 10-12

Cleaning machine 10-1

Exterior 10-1

Fuser roller 10-4

Interior 10-2

Scanning area 10-5

[Clear] key 1-5

Clearing Jams 11-1

Document jams 11-1

Paper jams 11-3

[Coded Dial] key 1-6, 4-31

Coded dialing 4-6

Deleting 4-19

Editing 4-16

Registering 4-14

Using 4-31

[Collate/2 on 1] key 1-4

COMMON SETTINGS 12-3, 12-5

[COPY] key 1-4

Copy Mode 1-7

COPY SETTINGS 12-3, 12-6

Copying 6-1

Customer support

Canada xvi, 11-21

U.S.A. xvi, 11-21

D

Daylight saving time 1-14

Density

Copying 6-4

Faxes 4-5

[Density] key 1-4



Document

- Jams 11-1
- Loading 2-4
- Requirements 2-1

Document delivery tray 1-1

Document feeder tray 1-1

Dust cover 1-2

E

[Energy Saver] key 1-4

[Enlarge/Reduce] key 1-4

Error codes 11-20

Error indicator 1-5

Error messages

- Common 11-9
- Facsimile 11-16
- Printer 11-19

External device jack 1-3

F

[FAX] key 1-4

Fax Mode 1-7

FAX SETTINGS 12-3, 12-8

Faxes

- Receiving 5-1
- Sending 4-1

G

Group dialing 4-6

- Adding destination 4-23
- Changing name 4-26
- Deleting destination 4-24
- Deleting group 4-28
- Registering 4-21
- Using 4-30

H

Handling xiii

[Hook] key 1-6, 4-33

I

If You Cannot Solve a Problem 11-21

Image quality

- Copying 6-3
- Faxes 4-3

[Image Quality] key 1-4

J

Jams

- Document 11-1
- Paper 11-3

L

- LCD 1-5, 1-7
 - Messages 11-9
- Loading
 - Document 2-4
 - Envelopes 3-4
 - Paper 3-4
- Location xiv

M

- Machine Components 1-1
- Machine settings 12-1
- Main power switch 1-2
- Maintaining
 - Toner cartridge 1-9
- Maintenance xiii, 10-1
- Manual Sending 4-32
- Menu
 - Accessing 12-3
 - Setting 12-5
- Multi-purpose tray 1-2, 3-4

N

- Numeric keys 1-5

O

- [OK] key 1-5
- One-Touch Speed Dial keys 1-6

- One-touch speed dialing 4-6
 - Deleting 4-12
 - Editing 4-9
 - Registering 4-7
 - Using 4-30
- Operation panel 1-1, 1-4
- OUT OF TONER message 10-8
- Output tray 1-1
- Output tray extension 1-2

P

- Paper
 - Guidelines 3-3
 - Jams 11-3
 - Loading 3-4
 - Printable area 3-2
 - Requirements 3-1
 - Size and type 3-7
- Paper feeding tray 1-1
- Paper guide rail 1-2
- PAPER JAM message 11-3
- PAPER SETTINGS 12-3, 12-5
- Paper stopper 1-2
- PC Faxing 9-1
- Platen glass 1-2, 2-4
- Power socket 1-3
- Power supply xv
- Printing 7-1
- Processing/Data indicator 1-5



R

- Rear cover 1-3
- Receiving faxes 5-1
- Recycling cartridge 10-12
 - CANADA PROGRAM 10-17
 - U.S.A. PROGRAM 10-14
- [Redial/Pause] key 1-6
- Redistributing toner 10-8
- Registering speed dialing 4-6
- Replacing toner cartridge 10-8
- REPORT SETTINGS 12-3, 12-14
- RX SETTINGS 12-9

S

- Safety instructions xiii
- [SCAN] key 1-4
- Scan Mode 1-7
- Scan settings
 - Copying 6-3
 - Faxes 4-3
- Scanning 8-1
- Scanning area 1-2, 2-3
- Scanning platform 1-2
- Sending faxes 4-1
- Setting Menu 12-5
 - Accessing 12-3
- Sleep Mode 1-11

- Slide guides 1-1, 2-6
 - for multi-purpose tray 1-2
- Specifications 13-1
 - Copier 13-2
 - Facsimile 13-3
 - General 13-1
 - Printer 13-3
 - Telephone 13-5
- Speed dialing 4-6
- Standby mode
 - Copy 1-7
 - Fax 1-7
 - Scan 1-7
- [Start] key 1-5
- [Stop/Reset] key 1-5
- [System Monitor] key 1-4

T

- Telephone line jack 1-3
- TIMER SETTINGS 12-3, 12-7
- Timer settings 1-11
- [Tone] key 1-5
- Toner cartridge 1-8
 - Checking the toner level 1-10
 - Maintaining 1-9
 - Recycling 10-12
 - Redistributing 10-8
 - Replacing 10-10

[Toner Gauge] key 1-5
Transporting machine 10-19
Troubleshooting 11-1
TX SETTINGS 12-8

U

USB port 1-3
User's Data List 12-1
 Printing 12-1
Using speed dialing 4-30

V

[View Settings] key 1-4

Z

Zoom ratio 6-6
 Preset zoom 6-6
 Zoom designation 6-7



CANON INC.

30-2, Shimomaruko 3-chome, Ohta-ku, Tokyo 146-8501, Japan

CANON U.S.A., INC.

One Canon Plaza, Lake Success, NY 11042, U.S.A.

CANON CANADA INC.

6390 Dixie Road Mississauga, Ontario L5T 1P7, Canada

CANON EUROPA N.V.

Bovenkerkerweg 59-61 1185 XB Amstelveen, The Netherlands

CANON FRANCE S.A.S.

17, quai du Président Paul Doumer 92414 Courbevoie Cedex, France

CANON COMMUNICATION & IMAGE FRANCE S.A.S.

12, rue de l'Industrie 92414 Courbevoie Cedex, France

CANON (U.K.) LTD.

Woodhatch, Reigate, Surrey, RH2 8BF, United Kingdom

CANON DEUTSCHLAND GmbH

Europark Fichtenhain A10, 47807 Krefeld, Germany

CANON ITALIA S.p.A.

Via Milano, 8 20097 San Donato Milanese (MI) Italy

CANON ESPAÑA, S.A.

c/ Joaquín Costa 41, 28002 Madrid, Spain

CANON LATIN AMERICA, INC.

703 Waterford Way Suite 400, Miami, Florida 33126 U.S.A.

CANON AUSTRALIA PTY. LTD

1 Thomas Holt Drive, North Ryde, Sydney, N.S.W. 2113, Australia

CANON CHINA CO., LTD

15F Jinbao Building No.89 Jinbao Street, Dongcheng District, Beijing 100005, China

CANON SINGAPORE PTE. LTD.

1 HarbourFront Avenue #04-01 Keppel Bay Tower, Singapore 098632

120V



Free Manuals Download Website

<http://myh66.com>

<http://usermanuals.us>

<http://www.somanuals.com>

<http://www.4manuals.cc>

<http://www.manual-lib.com>

<http://www.404manual.com>

<http://www.luxmanual.com>

<http://aubethermostatmanual.com>

Golf course search by state

<http://golfingnear.com>

Email search by domain

<http://emailbydomain.com>

Auto manuals search

<http://auto.somanuals.com>

TV manuals search

<http://tv.somanuals.com>