

# Print/Scan System (U)

## **KM-3035/4035/5035 Network Scanner**

### **Operation Guide <Set-up Edition>**

ALWAYS read this Operation Guide thoroughly before use. After reading, maintain it in good condition and keep it together with the Operation Guide for your copier.



## Trademark Information

---

- Microsoft, Windows, Windows NT and Internet Explorer are registered trademarks of Microsoft Corporation of America and other countries.
- Windows Me and Windows XP are trademarks of Microsoft Corporation.
- Ethernet is a registered trademark of Xerox Corporation.
- IBM and IBM PC/AT are trademarks of International Business Machines Corporation of America.
- Adobe and Acrobat are registered trademarks of Adobe Systems Incorporated.
- PaperPort is a registered trademark of ScanSoft Inc. of America and other countries.

All other company and product names contained in this Operation Guide are trademarks or registered trademarks of their respective companies. The designations <sup>TM</sup> and <sup>®</sup> will not be used in this Operation Guide.

All rights reserved. No part of this material may be reproduced or transmitted in any form or by any means, electronic or mechanical, including photocopying, recording or by any information storage and retrieval system, without permission in writing from the Publisher.

### Legal Restriction On Copying

- It may be prohibited to copy copyrighted material without permission of the copyright owner.
- It is prohibited under any circumstances to copy domestic or foreign currencies.
- Copying other items may be prohibited.

## About this Operation Guide

---

This Operation Guide is meant to be read when the Scanner Interface Card is installed and your copier is to be used as a network scanner. It explains set-up procedures and other related operation on the machine.

As the required set-up in order to use the copier as a scanner may differ depending upon the environment in use in the connected computer, please read those sections related to your specific computer environment and perform the appropriate set-up procedures explained there.

This Operation Guide should also be read and used together with the appropriate Operation Guide <Functions Edition> (On-Line Manual) that is on the included [Document Library] CD-ROM. The On-Line Manual <Functions Edition> explains how to scan, various setting methods, and operation procedures from a computer.

## Using the Operation Guide <Functions Edition> (On-Line Manual)

---

The CD-ROMs included with this product contain the Operation Guide <Functions Edition> (On-Line Manual) in a PDF (Portable Document Format) file format.

The Operation Guide <Functions Edition> (On-Line Manual) explains how to use the required applications when using your copier as a network scanner. The main content of the CD-ROMs is as follows:

- Introduction of the network scanner system
- Explanation of setting procedures when using an Internet Web browser
- Explanation of setting procedures at the scanner
- Explanation of attached utilities:
  - Scanner File Utility
  - Address Book
  - Address Editor
  - TWAIN Source
  - DB Assistant

### • Opening the On-Line Manual

Carry out the following procedures in order to open and view the On-Line Manual.

1. Insert the [Document Library] CD-ROM into the CD-ROM drive of your computer. The Main Menu screen for set-up will appear automatically.
2. Click on [Scan System Operation Guides] under the [Main Menu] in order to access the desired On-Line Manual for viewing.

\* Adobe Acrobat Reader must be installed in your computer in order to access the On-Line Manual.

## **Important:**

---

- The use of scanned legally copyrighted materials, such as documents, musical scores, pictures, woodblock prints, maps, drawings and photographs, for any intent other than your own personal or home use, or other such purpose, is prohibited under the copyright law without prior permission from the legal copyright owner.

Simply scanning the following items may result in legal penalty:

- Bank notes, coins, government-issue securities, national bonds, local bonds, foreign currencies and securities, unused postage stamps, government post cards, government stamps, and securities regulated by the liquor tax law.

Other items that you should also not scan:

- It is additionally recommended that you do not attempt to scan government-issue passports, or licenses, permits, ID cards, securities, commuter tickets, passes, books of tickets and meal coupons issued by public organizations or private parties.

## Getting connected

The following procedures are required in order to use this machine as a scanner.

### Connect the scanner to your computer

<Example connection>

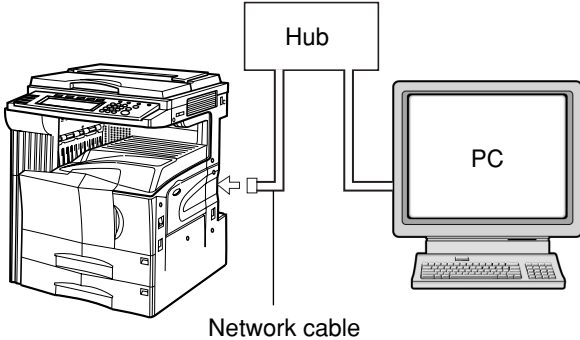

Connecting the scanner to your computer network with a network cable (100BASE-TX and 10BASE-T) ..... Page 2-2



### Perform the required operation at the scanner

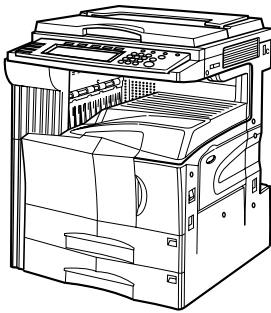

Basic scanner settings  
(register the host name and IP address, etc.) ..... Page 2-2

Registering and editing user information  
(register a new user) ..... Page 2-3



### Perform the required operation at your computer

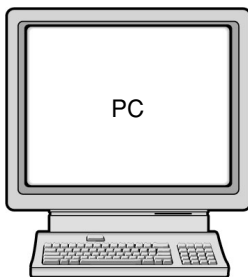

Installing the various software (included on the enclosed CD-ROM disk)

- Scanner File Utility**  
Saves the scanned image as a data file on your computer.
- TWAIN Source**  
Enables you to utilize scanned images in a TWAIN-compatible application.
- Address Book**  
A personal address book that you can access from the scanner's operation panel.
- Address Editor (Management Tool)**  
Enables you to register and edit the shared Address Book, make network-related settings and change various default settings.
- DB Assistant (Management Tool)**  
Enables you to register and make settings for data information related to scanned images.
  - Refer to the On-Line Manual <Functions Edition> for more detailed information on the included software.



You're now ready to scan!

# Table of contents

---

<b>1. Preparations .....</b>	<b>1-1</b>
1-1 Names of parts .....	1-1
• Main body .....	1-1
• Operation panel .....	1-2
1-2 Accessories .....	1-3
1-3 Utilities and other software (the main content of the included CD-ROMs) .....	1-3
1-4 Required items .....	1-3
<b>2. Set-up .....</b>	<b>2-1</b>
2-1 Setting up the scanner .....	2-1
(1) Outline and network configuration .....	2-1
(2) Connecting the scanner to your computer network .....	2-2
(3) Making settings from the touch panel .....	2-2
2-2 Setting up the scanner software .....	2-7
(1) System requirements .....	2-7
(2) Installing the software .....	2-7
(3) Installing the utilities .....	2-8
(4) Installing the TWAIN source .....	2-8
<b>3. Performing the Required Operation at the Scanner .....</b>	<b>3-1</b>
3-1 Scanning under the Scan to PC and Send E-mail functions .....	3-1
(1) Before using the Scan to PC function .....	3-1
(2) Before using the Send E-mail function .....	3-1
(3) How to scan under Scan to PC and Send E-mail .....	3-1
3-2 Scanning with TWAIN .....	3-4
• When performing the scanning operation at the scanner .....	3-4
• When performing the scanning operation at your computer .....	3-4
3-3 Setting up the Database Connection function .....	3-6
(1) Preparations .....	3-6
(2) How to set up the Database Connection function .....	3-6
<b>4. Troubleshooting .....</b>	<b>4-1</b>
4-1 Error messages .....	4-1
<b>5. Specifications .....</b>	<b>5-1</b>
5-1 Scanner specification .....	5-1

# 1. Preparations

## 1-1 Names of parts

### • Main body

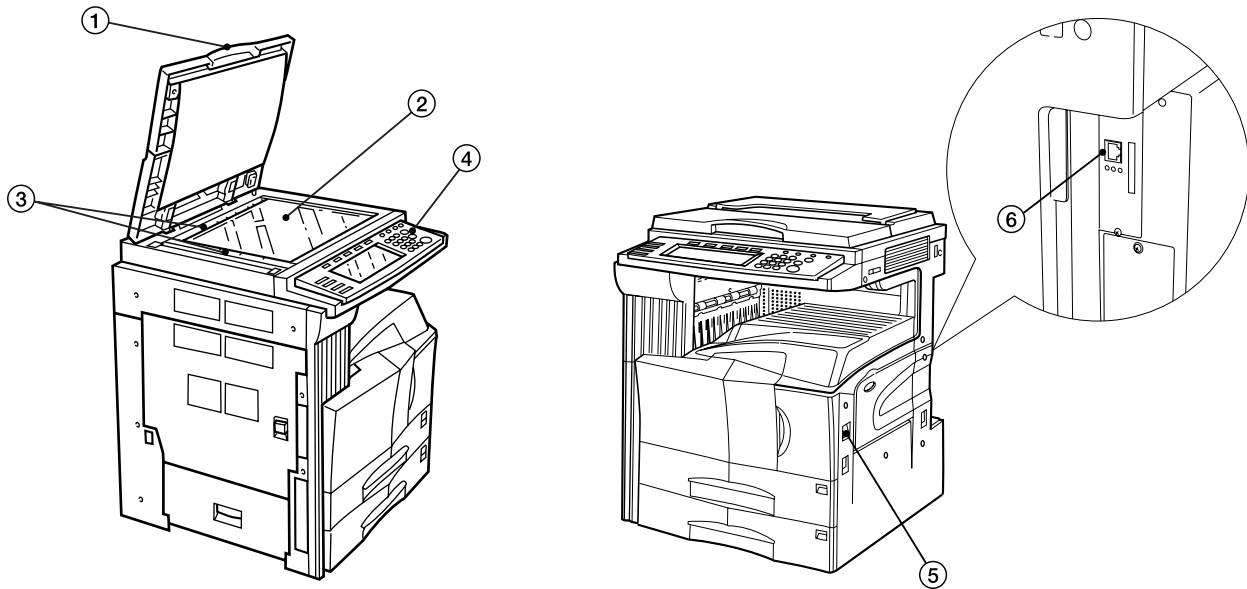

- ① Original cover  
Open and close this cover when setting an original on the platen.
- ② Platen  
Set the original to be scanned face-down in the left-rear portion of the platen.
- ③ Original size indicator lines  
Be sure to align the original with these lines when setting an original on the platen.

- ④ Operation panel  
Perform operations here.
- ⑤ Main switch  
Turn this switch ON in order to use the scanner.
- ⑥ Scanner interface connector  
Use to connect the scanner to the computer network with a 10BASE-T or 100BASE-TX cable.  
\* NEVER attempt to remove the Scanner Interface Card.



## • Operation panel

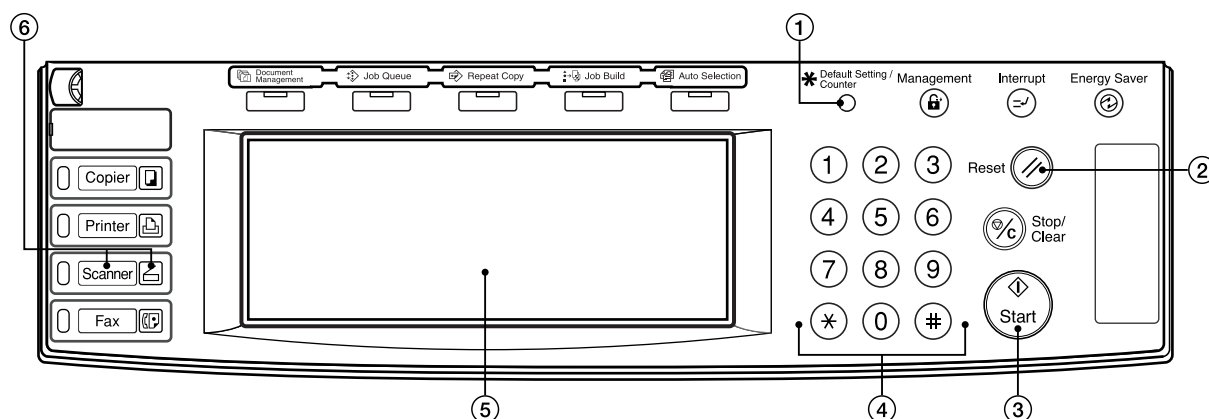

- ① **Default Setting/Counter key**  
Press this key when you want to change default settings for the scanner as well as register new users.
- ② **Reset key**  
Press this key when you want to cancel default and scan settings, as well as when you want to clear selected destination folders and computers.
- ③ **Start key**  
Press this key when you want to start, or continue, scanning originals.
- ④ **Keypad**  
Use these keys when you want to enter a desired value for one of the various settings.
- ⑤ **Touch panel**  
Indicates machine status and the values for each setting, and contains operational key. The keys which appear on the touch panel for operation procedures are indicated in this Operation Guide within double quotation marks and you will be instructed to “touch” them rather than “press” them. (Ex.: Touch the “xxx” key.)
- ⑥ **Scanner key / Scanner indicator**  
Press this key when the optional Network Scanner Kit is installed in your machine and you want to switch to the Scanner Operation mode. The Scanner indicator is lit when the machine is in the Scanner Operation mode.

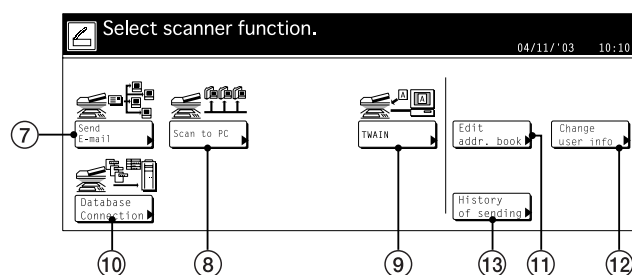

## • The touch panel in the Scanner Operation mode

- ⑦ **“Send E-mail” key**  
Touch this key when you want to send scanned image data as an attached file in an email message.
- ⑧ **“Scan to PC” key**  
Touch this key when you want to save scanned image data as a file on your computer.
- ⑨ **“TWAIN” key**  
When initiating the scanning operation from a TWAIN-compatible application, touch this key to enter the TWAIN mode and then set the original, and the connection from the application will be carried out more surely.
- ⑩ **“Database Connection” key**  
Touch this key when saving image data as a file on your computer in order to add information to that file.
- ⑪ **“Edit add. book” key**  
Touch this key when you want to edit the shared address book.
- ⑫ **“Change user Info.” key**  
Touch this key when you want to change user information.
- ⑬ **“History of Sending” key**  
Touch this key when you want to view the transmission log for the data scanned with “Send E-mail” “Scan to PC” and “Database Connection” functions.

## 1. Preparations

---

### 1-2 Accessories

Prior to using the scanner for the first time, verify that the following accessories are included with this product.

- 1 CD-ROM (Scanner Library)
- 1 CD-ROM (TWAIN-compatible application)
- Operation Guide

### 1-3 Utilities and other software (the main content of the included CD-ROMs)

- **CD-ROM (Scanner Library)**

- Scanner File Utility
- TWAIN Source
- Address Book
- Address Editor
- Configuration Tool
- DB Assistant
- Acrobat Reader
- On-Line Manual

\* Refer to the On-Line Manual <Functions Edition> of this Operation Guide for information on using the included utilities and other software.

- **CD-ROM (TWAIN-compatible application)**

- PaperPort

### 1-4 Required items

You must have on hand one of the following cables as appropriate to your computer network environment.

- 100BASE-TX cable (shielded type)
- 10BASE-T cable (shielded type)

\* Be absolutely sure that the 10BASE-T or 100BASE-TX cable that you use is a shielded cable.

# 2. Set-up

## 2-1 Setting up the scanner

### (1) Outline and network configuration

Example of transmission modes for data scanned using the Scan System and the required software

The software indicated in the thick-lined balloons is included with this product. Install the software that is appropriate to your operating environment and needs.

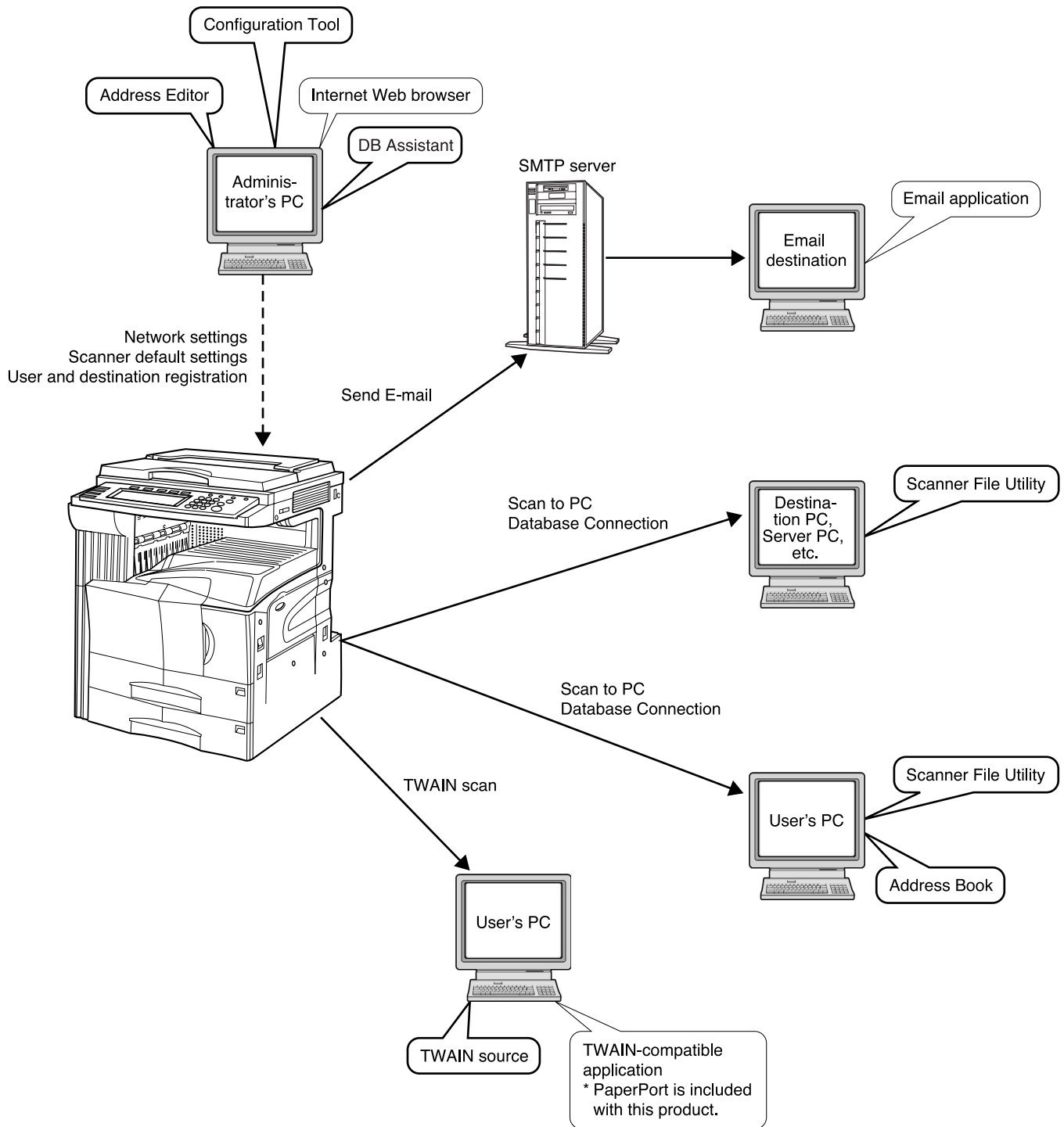

\* Image data receive through the Scan to PC and Send E-mail functions can be used as well with PaperPort.

\* Refer to the On-Line Manual <Functions Edition> for information on using the included utilities and other software.

## 2. Set-up

### (2) Connecting the scanner to your computer network

- 1 Turn the main switch located on the right side of the scanner OFF.

**CAUTION:**

ALWAYS turn the main switch to the scanner OFF BEFORE connecting the network cable.

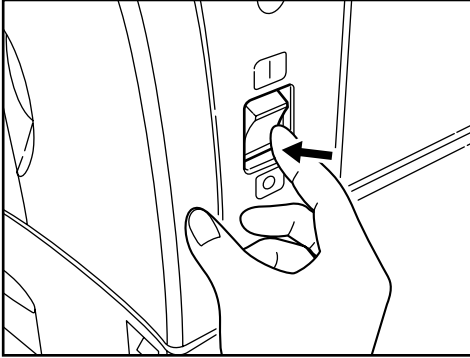

- 2 Connect a 10BASE-T or 100BASE-TX cable to the scanner interface connector located at the back of the right side of the scanner.

\* NEVER attempt to remove the Scanner Interface Card.

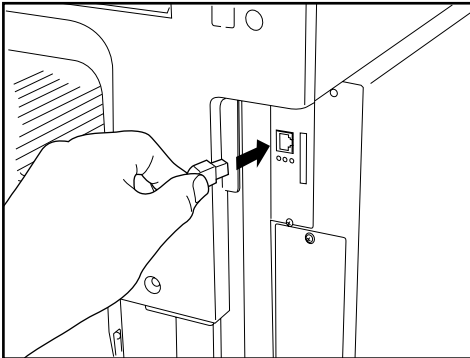

- 3 Turn the main switch to the scanner back ON.

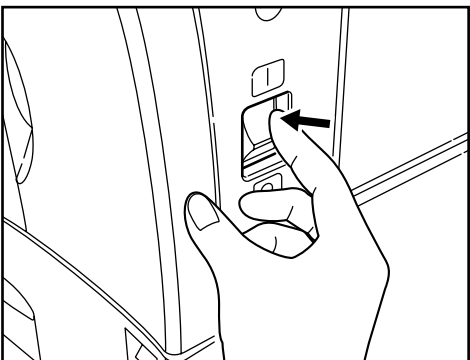

### (3) Making settings from the touch panel

This section explains the default settings as well as user registration procedures required to use the scanner. If you use the software that is included with this product, it is possible to perform the following settings from an Internet Web browser, or the Address Editor software, from a computer that is connected to the same network as the scanner. Refer to the On-Line Manual <Functions Edition> for more detailed information.

#### NOTES

- The network addresses that should be registered here will differ depending upon your network environment. Check with your network administrator BEFORE performing this setting.
- If you are using a DHCP server to automatically configure the network addresses, you will not need to change the IP address and the Subnet Mask because DHCP server configuration is already enabled as the factory default setting.

#### • Basic scanner settings

- 1 Press the Default Setting/Counter key. The Default Setting screen will appear.

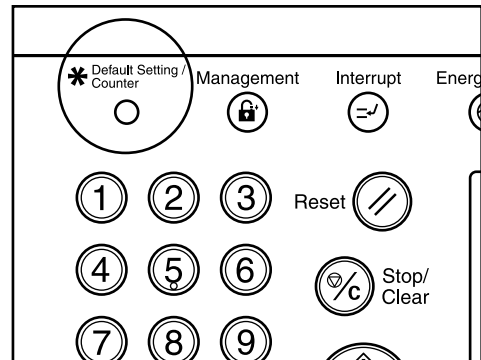

- 2 Touch the "Scanner default" key. The Password Input screen will appear.

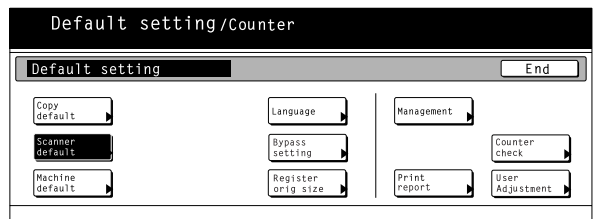

- 3** Use the numeric keys on the keypad to enter the administrator password number. The factory default setting for 30 ppm machines is "3000", for 40 ppm machines is "4000" and for 50 ppm machines is "5000".
- \* If the entered number matches the registered one, the Scanner Setting menu will appear.
  - \* It is possible for you to change the administrator password number as desired. For more information, refer to the Operation Guide for your copier.

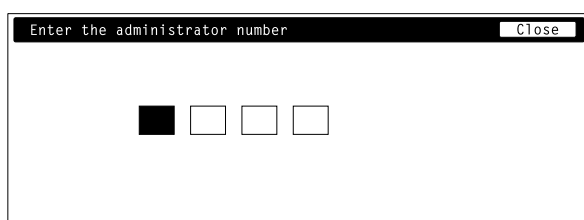

- 4** Touch the "System Basic" key. The System Basic screen will appear. If "Unable to use scanner" appears, the touch panel will return to the Default Setting screen. Wait for a while (approx. 2 minutes) and then touch the "System Basic" key again.

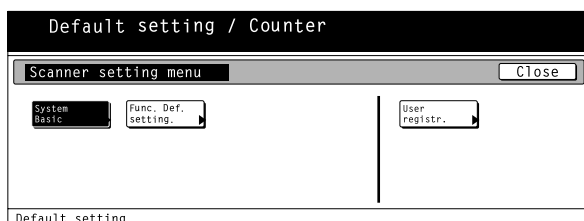

- 5** Use the "▲" and "▼" cursor keys to select the setting that you want to change and then touch the "Change #" key. The Character Input screen will appear.
- The following explains the procedure for registering the scanner's host name. Refer to this basic procedure when changing other settings.

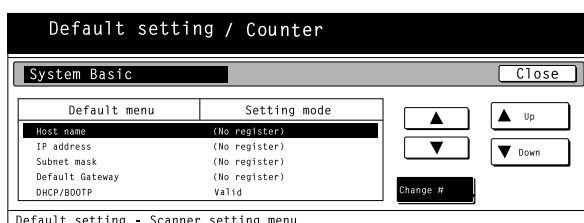

- 6** Touch the appropriate keys on the displayed keyboard in order to enter the scanner's host name. Check the entered name and, once you are certain that it is correct, touch the "End" key. The touch panel will return to the System Basic screen.

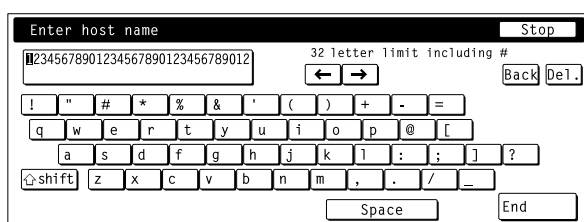

- **Registering and editing user information**  
The following explains the procedure to use the scanner's touch panel to register and edit user information. Registration of user information is also possible from an Internet Web browser as well as by using the Address Editor software.

- 7** Perform steps 1 through 3 under "Basic scanner settings" and then touch the "User registr." key in the Scanner Setting menu (shown in the screen shot in step 4). The User Register/Delete screen will appear.

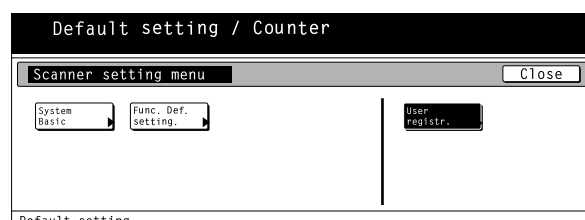

- 8** If you want to change previously registered user information, use the "▲" and "▼" cursor keys to select the name of the user that you want to edit the information for and touch the "Change user info." key. If a password (see "User registration information" on page 2-5) has been registered for that user, enter the registered password. The Edit User Info screen will appear.
- If you want to delete a registered user, use the "▲" and "▼" cursor keys to select the name of the user that you want to delete and then touch the "Delete" key.

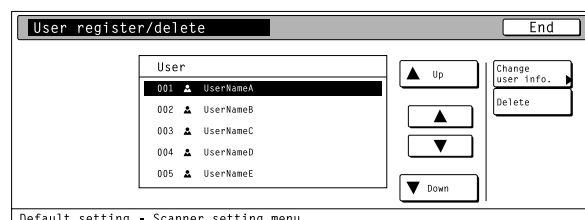

- 9** Use the "▲" and "▼" cursor keys to select the setting that you want to change and then touch the "Change #" key. The Change Settings screen will appear. Enter the corresponding information in accordance with the settings, etc., that are shown on the touch panel.
- For more information on entering characters, refer to the Operation Guide for your copier.

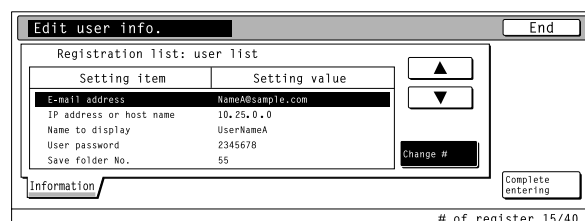

## 2. Set-up

### • Editing the shared Address Book

The following explains the procedure to use the scanner's touch panel to edit the shared Address Book.

- \* New addresses can also be registered in the Address Book using this procedure.
- \* Registration in the shared Address Book is possible from an Internet Web browser as well as the Address Editor software.

**10** Press the Scanner key to display the Select Scanner Function screen.

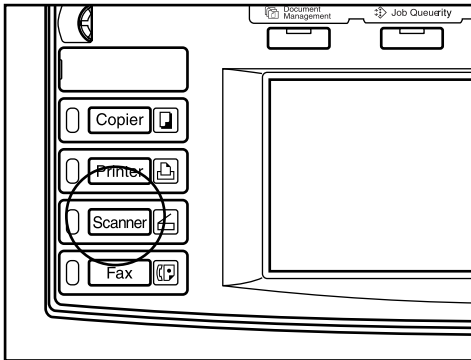

**11** Touch the "Edit addr. book" key. The User Number Input screen will appear.

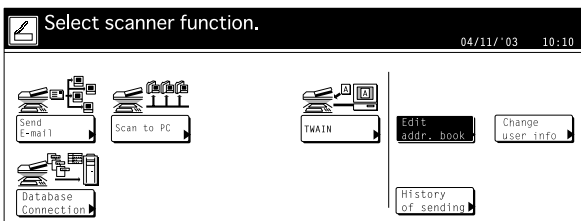

**12** Enter your user number and then touch the "Enter" key. The Edit Address Book screen will appear. (Refer to step 8 on page 2-3.)

- \* If you registered a password during user registration, enter the registered password.
- \* Your user number refers to the 3-digit number to the left of your user name as it appears in the screen when performing step 8 on page 2-3. For example, using the sample screen under step 8 on page 2-3 as an example, the user number for "UserNameA" would be "001".

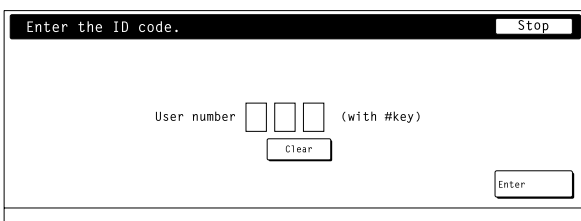

- \* If you want to change your user information, touch the "Change user Info." key in the Select Scanner Function screen under step 11 and register the information as desired. (Refer to step 9 on page 2-3.)

**13** Select the shared Address Book that you want to edit. The registration and edit screen for the Address Book will appear.

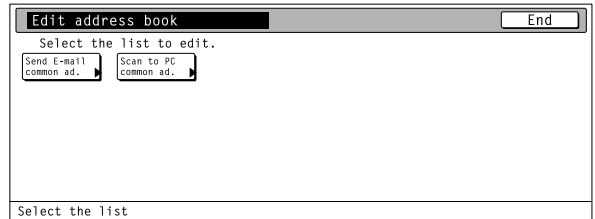

**14** If you want to register a new destination in the Address Book, touch the "Register new dest." key. If you want to register a new group of destinations, or add a destination to a previously registered group, touch the "Register new group" key. If you are registering a new destination, go to the next step.

If you are registering a new group of destinations, proceed directly to step 16.

If you want to change the information for a previously registered destination, use the "▲" and "▼" cursor keys to select the name of the destination that you want to edit the information for. Then touch the "Correct dest. info" key and change the information as desired.

If you want to delete a registered destination, use the "▲" and "▼" cursor keys to select the name of the destination that you want to delete and then touch the "Delete" key.

\* The sample screen below is the shared Address Book editing screen from the Scan to PC function.

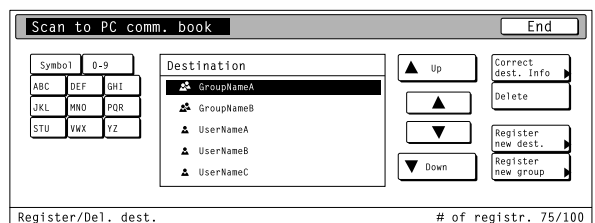

**15** Destination registration Use the "▲" and "▼" cursor keys to select the setting that you want to register information for and then touch the "Change #" key. The Change Setting screen will appear.

Enter the corresponding information in accordance with the settings, etc., that are shown on the touch panel. Once you have finished entering the corresponding information, touch the "Complete entering" key and the destination will be registered.

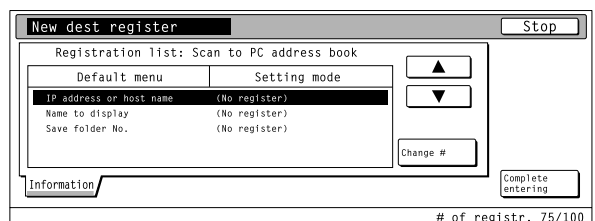

**16** Group registration  
Touch the “Information” tab and the names of the registered groups will be displayed.

If you want to change a registered name, use the “▲” and “▼” cursor keys to select the name that you want to edit and then touch the “Change #” key.

Touch the “Destination” tab and the currently registered members of that group will be displayed.

If you want to add a member to the group, touch the “Add content #” key. The Add Member screen will appear. Use the “▲” and “▼” cursor keys to select the member that you want to add to that group and then touch the “Add” key. Once you have finished adding members, touch the “Complete entering” key and the selected member(s) will be added to the group.

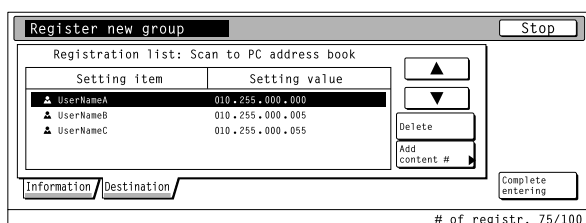

#### • User registration information

- E-mail address ..... When you use the Send E-mail function to send data by email and the person who receives it clicks on Reply in response to that message, this is the address to which that reply will be sent. If an error occurs during Scan to PC or Send E-mail, the error notice will be sent to the address registered here as well.
- IP address or host name ..... If you select “Save at user PC” when designating the destination under the Scan to PC function, the scanned image data will be sent to the computer with this IP address (or host name).
- Name to display ..... This is the name that is displayed for selecting a user. Be sure to register an appropriate name here.
- User password ..... This is the password that is entered when selecting a user. (It is not required to register a password.)  
\* The password can be up to 8 numbers long.
- Save folder No. .... This is the registered number of the destination folder when “Save at user PC” is selected. Use the Scanner File Utility to perform the appropriate settings for the folder that will be registered with this number.  
\* For the procedure to select “Save at user PC”, refer to “Scanning under the Scan to PC and Send E-mail functions” on page 3-1.  
\* The number of the destination folder can be up to 3 digits long (001 – 100).  
\* Only one destination folder can be registered in the scanner itself.

#### • Destination registration information

- E-mail address ..... When you use the Send E-mail function, the image data will be attached to an email message and sent to this address.
- IP address or host name ..... When you use the Scan to PC function, the image data will be sent to the computer with this IP address (or host name).
- Name to display ..... This is the name that is displayed in the address book.
- Save folder No. .... This is the registered number of the destination folder when you use the Scan to PC function. Use the Scanner File Utility in the destination computer to perform the appropriate settings for the folder that will be registered with this number.
- Add dest. .... When registering groups, click on this button when you want to add a destination from the shared Address Book to a selected group.

#### NOTE

In order for scanner users to create and use their own personal Address Book, it is necessary to install the Address Book software in that user’s computer. Once installed, the destination information registered and the software rebooted, the personal Address Book will be available for use.

## 2. Set-up

### • Date/Time and Time Difference

Sets the required area information for the Send E-mail function.

The time of day when email is sent from the scanner is included in the header of that email message as the transmission time. Perform the following procedure in order to set the date and time in your area, as well as the time difference to GMT (Greenwich Mean Time).

- 1 Press the Default Setting/Counter key. The Default Setting screen will appear.

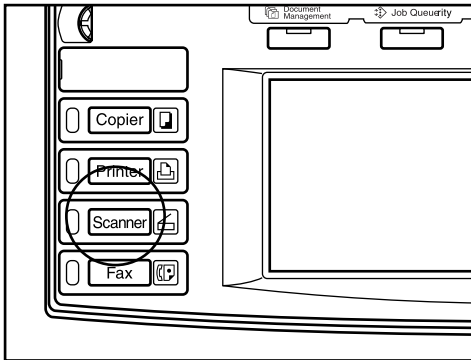

- 2 Touch the "Machine default" key. The Machine Default screen will appear.

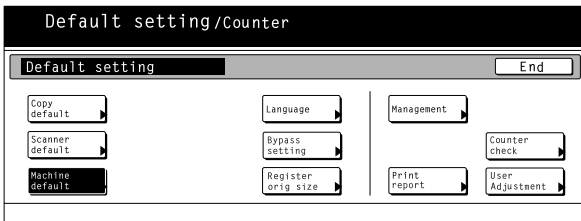

- 3 Use the numeric keys on the keypad to enter the administrator password number. The factory default setting for 30 ppm machines is "3000", for 40 ppm machines is "4000" and for 50 ppm machines is "5000".

- \* If the entered number matches the registered one, the Scanner Setting menu will appear.
- \* It is possible for you to change the administrator password number as desired. For more information, refer to the Operation Guide for your copier.

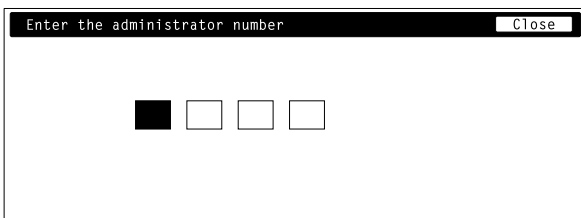

- 4 Use the "s" and "t" cursor keys to select "Time difference" and then touch the "Change #" key. The Time Difference Setting screen will appear.

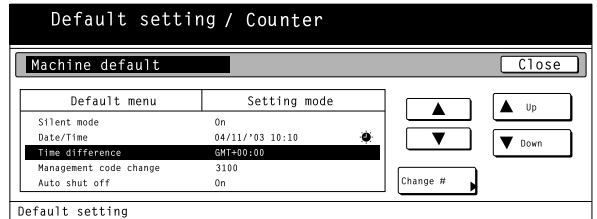

- 5 Use the "+" and "-" keys to change the setting as desired. Touch the "Close" key to register the change to that setting.

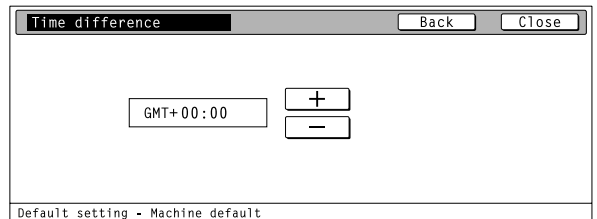

Ex.: Time difference (Washington) GMT -5:00  
(London) GMT 0:00

- 6 Use the "▲" and "▼" cursor keys to select "Date/Time" and then touch the "Change #" key. The Date/Time Setting screen will appear.

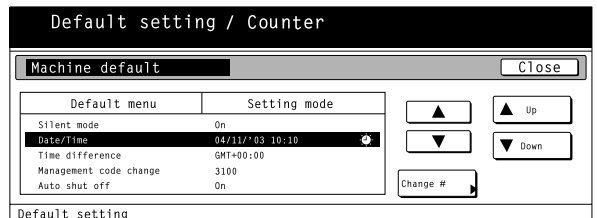

- 7 Use the "+" and "-" keys to change the setting as desired. Touch the "Close" key to register the change to that setting.

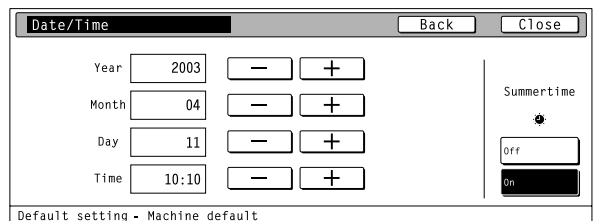

\* Be sure to set the time difference first and then the date and time.

\* If you change both of "Summertime" and "Date/Time" setting, "Summertime" setting will be invalid.



## 2-2 Setting up the scanner software

### (1) System requirements

PC		IBM PC/AT or compatible
OS		Windows 95 (OSR2), Windows 98 (Second Edition), Windows NT (Service Pack 5 or later), Windows 2000 (Service Pack 2 or later), Windows Me or Windows XP
System environment	CPU	Pentium 133 MHz or faster
	RAM	64 MB or more
	HDD	20 MB or more
Recommended environment	CPU	Celeron 266 MHz or faster
	RAM	64 MB or more
	HDD	300 MB or more
CD-ROM drive		1 drive
Ethernet cable		10BASE-T or 100BASE-TX

### (2) Installing the software

There are four main functions available with this network scanner.

Perform the following procedure in order to install into your computer the required utility that is appropriate to the application and operating system in use in your computer.

#### • Scan to PC

Stores the image data of scanned originals as a file in a desired folder on your computer. Install the Scanner File Utility into the corresponding computer in order to use this function.

\* Registration of the save folder in your computer, as well as registration in the scanner of the destination is required. For information on making settings from an Internet Web browser, as well as for each utility, refer to the On-Line Manual <Functions Edition> of this Operation Guide.

#### • Send E-mail

Sends the image data of scanned originals to the desired receiver as a file attached to an email message.

\* Registration in the scanner of the corresponding SMTP server settings is required. For information on making settings from an Internet Web browser, as well as for each utility, refer to the On-Line Manual <Functions Edition> of this Operation Guide.

#### • TWAIN

Connects to the scanner from the TWAIN-compatible application according to the procedures of that particular application. Install the TWAIN Source on the computer that contains the application in order to use this function.

#### • Database Connection

Allows you to add information to data file for scanned originals and saves the resulting file into a designated folder on your computer. The method of sending the data using this function is the same as that for the "Scan to PC" function.

\* Refer to the Functions Edition (On-Line Manual) of your Operation Guide for more detailed information on using DB Assistant, Scanner File Utility or your Web browser software in order to utilize the Database Connection (adding file information to the scanned image data file) function.

## 2. Set-up

### (3) Installing the utilities

The following utilities are contained on the [Software Library] CD-ROM that is included with this product.

\* Refer to the On-Line Manual <Functions Edition> of this Operation Guide for information on using the included utilities.

- Scanner File Utility
- Address Book
- Address Editor (Management Tool)
- DB Assistant (Management Tool)

- 1** Run Windows.  
Quit all other applications that may be open.
- 2** Insert the [Software Library] CD-ROM into the CD-ROM drive of your computer.
- 3** The License Agreement will be displayed. If you agree with the conditions contained therein, click on [Accept].  
If this screen does not appear after you insert the CD-ROM, open the CD-ROM window to access its contents and double-click on the [setup.exe] file.



- 4** Click on [Scanner Utilities] in the Main Menu.



- 5** Click on the name of the utility that you want to install. The installation window for that utility will appear. Follow the instructions on screen in order to install the selected utility.



### (4) Installing the TWAIN source

In order to scan originals using PaperPort, TWAIN Source must be installed PRIOR to installing the PaperPort application.

- 1** Run Windows.  
Quit all other applications that may be open.
- 2** Insert the [Software Library] CD-ROM the CD-ROM drive of your computer.
- 3** The License Agreement will be displayed. If you agree with the conditions contained therein, click on [Accept].  
If this screen does not appear after you insert the CD-ROM, open the CD-ROM window to access its contents and double-click on the [setup.exe] file.



- 4** Click on [Scanner Utilities] in the Main Menu.



- 5** Click on [TWAIN Source].

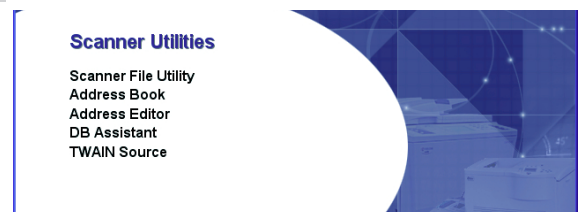

- 6** The Model Select window will appear. Select the model of the scanner that you are using.
- 7** When the installation window appears, follow the instructions on screen in order to install the TWAIN Source.

# 3. Performing the Required Operation at the Scanner

## 3-1 Scanning under the Scan to PC and Send E-mail functions

### (1) Before using the Scan to PC function

Be sure to perform the following settings in order to use the Scanner File Utility.

1. Install the Scanner File Utility in the destination computer.
2. Run the Scanner File Utility and register the destination folder for the scanned image data.
3. Register the IP address, the registration name and the destination number of the destination computer in the scanner.

\* Be sure to enter the same number in the Save folder No. field here as the save folder number (001 – 100) that was registered in the Scanner File Utility.

Refer to the On-Line Manual <Functions Edition> for more detailed information.

### (2) Before using the Send E-mail function

Be sure to register the destination name and email address.

### (3) How to scan under Scan to PC and Send E-mail

- 1 Press the Scanner key to display the Select Scanner Function screen.

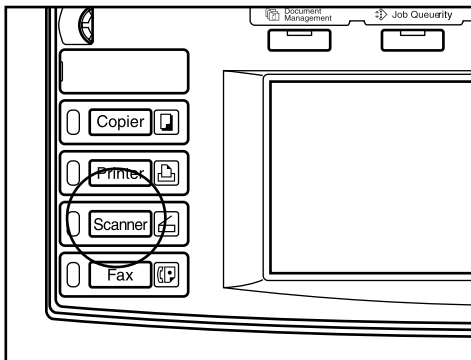

- 2 Touch the "Send E-mail" key or the "Scan to PC" key, as appropriate. The Select Sender Name screen will appear.

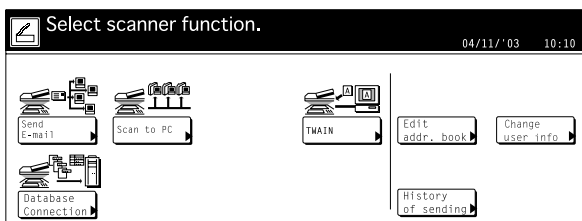

- 3 Use the "▲" and "▼" cursor keys to select your user name and then touch the "Enter" key.

The Scan to PC or Send E-mail screen, as appropriate, will appear. You can also enter your user name directly using the numeric keys on the keypad.

\* If the "Selec. of senders (users)" setting is turned ON, the user that is registered under User Number 001 will be automatically selected.

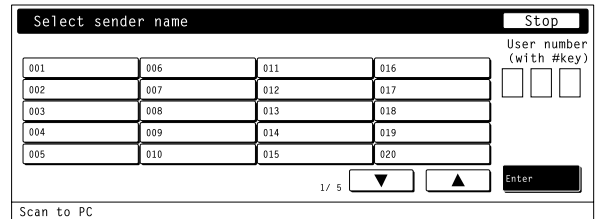

\* If a password was designated during registration of your user information, the Password Input screen will appear. After entering the appropriate password, touch the "Enter" key. If the entered password matches the registered one, the appropriate screen, Scan to PC or Send E-mail, will appear.

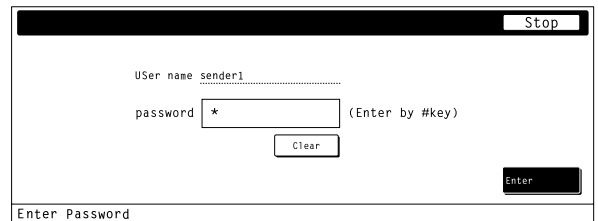

- 4 Select the destination. If you are using the Scan to PC function, go to the next step. If you are using the Send E-mail function, go directly to step 6.

- 5 Touch the "Save at user PC" if you want to save the scanned data in a user's computer. The registered user names will be displayed in the Destination field. proceed to step 9.



### 3. Performing the Required Operation at the Scanner

- 6** If you want to manually enter an email address, touch the “Enter dest.” key. The Enter E-mail Destination screen will appear.

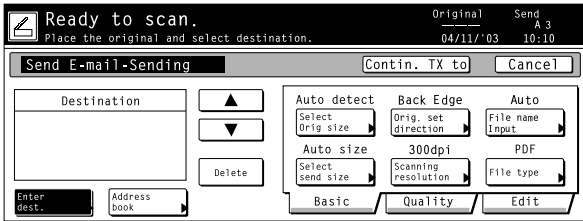

- 7** Type in the email address of the desired destination. Once you have entered the address, touch the “End” key and the Select the Kind of Receiver screen will appear.

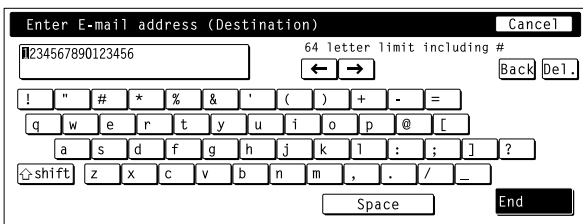

- 8** Touch the key that corresponds how you want the message to be sent to that address (“To:”, “CC:” or “BCC:”).

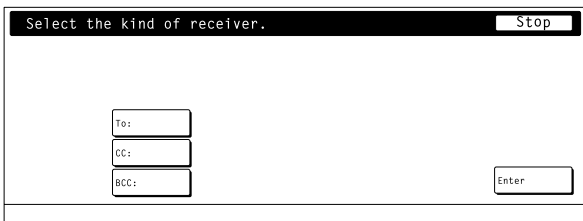

- 9** If you want to enter an email address using a personal Address Book or the shared Address Book, touch the “Address Book” key. The Address Book screen will appear.  
\* The sample screen below is from the Scan to PC function.

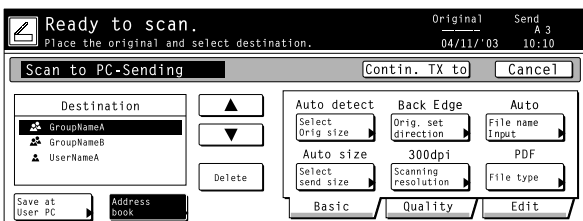

- 10** Touch the “Common book” tab or the “Private book” tab, as appropriate. The destinations registered in that Address Book will be displayed.

The following gives an example of selecting a destination from the shared Address Book. Use the “▲” and “▼” cursor keys to select the desired destination and then touch the “Add” key. If you are using the Send E-mail function, select the desired destination and then select how you want the message to be sent to that address (“To:”, “CC:” or “BCC:”).

- \* The number of selected destinations and  will appear in the upper right corner of the list.
- \* If the Address Book software is not running, the personal Address Book will not be displayed.

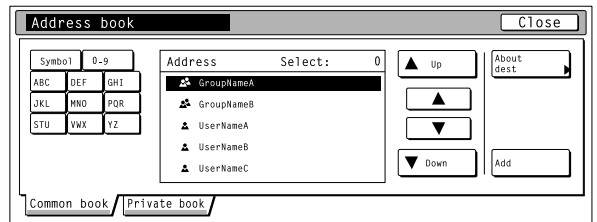

Screen from the Scan to PC function

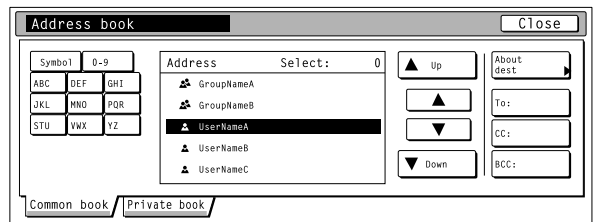

Screen from the Send E-mail function

- 11** To select other destinations, repeat the procedure from step 6. Once you have selected all of the destinations that you want to send the email to, touch the “Close” key.

- \* The sample screen below is from the Scan to PC function.

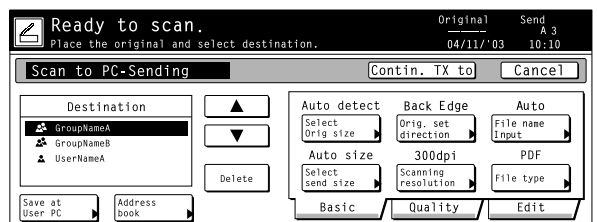

- 12** Check the selected destinations. Use the “▲” and “▼” cursor keys to make sure that all of the selected destinations are correct. If an incorrect or unnecessary destination is in the list, select it and touch the “Delete” key.

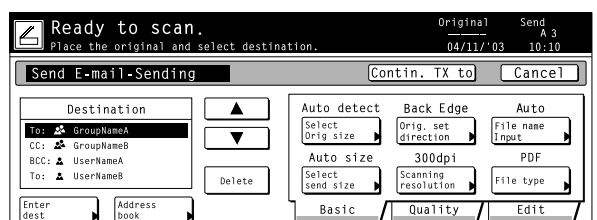

### 3. Performing the Required Operation at the Scanner

• Scan settings

**13** The Scan Settings menu is displayed in the right portion of the touch screen. If you want to change any settings, touch the key that corresponds to that setting. The following gives an example of the procedure to specify the orientation of the original. Touch the “Orig set direction” key. The Original Set Direction screen will appear.

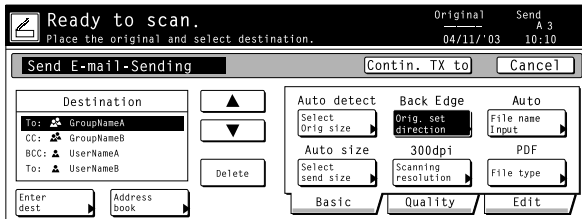

**14** If you set the original with its top edge towards the rear of the scanner, select “Back Edge”. If you set the original with its top edge towards the left of the scanner, select “Left top corner”. Touch the “Close” key to register the change to that setting or the “Back” key if you want to cancel the operation and return to the previous setting. The screen will return to that shown in step 12.

\* If the setting for the orientation of the original is not appropriate to the actual orientation, scanning may be accomplished incorrectly. Be sure to confirm the orientation of the original when making scan settings.

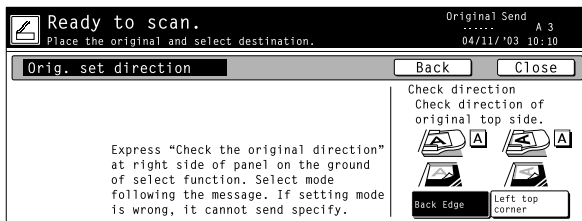

**15** Once you have checked all of the settings, set the original and press the Start key. Scanning of the original will begin.

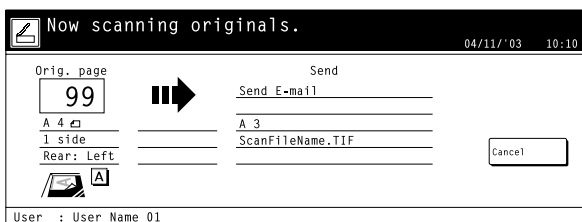

\* If you want to stop the scanning operation, touch the “Cancel” key.

**16** If you select “ON” under “Batch scanning” in the Scan Settings menu, a message that asks whether or not you want to continue scanning will appear after scanning of the original is complete.

If you DO want to continue scanning, set the next original, change any scan settings that you want, and then press the Start key.

Once you have finished scanning originals, touch the “Scanning finished” key.

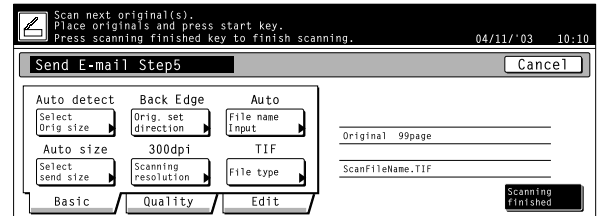

**17** If you select “On” under “Continuous sending” in the Scan to PC or Send E-mail screen, once the scanning operation is completed, the touch panel will return to the Scan to PC or Send E-mail screen, as appropriate, with the current settings unchanged.

To continue scanning more originals, set the next original, change any of the scanning settings as required, and then press the Start key.

Once you have finished scanning originals, touch the “Cancel” key.

\* If “Permit file overwrite” is selected in the computer’s Scanner File Utility when you are using the Scan to PC function, previous files saved to that computer may be overwritten if a duplicate file name is use. Be aware of this fact when designating file names for transmission, especially when the “Continuous sending” setting is turned ON.



### 3. Performing the Required Operation at the Scanner

## 3-2 Scanning with TWAIN

The following explains the settings that need to be made in the scanner in order to scan using the TWAIN function.

#### • When performing the scanning operation at the scanner

- 1 Press the Scanner key to display the Select Scanner Function screen.

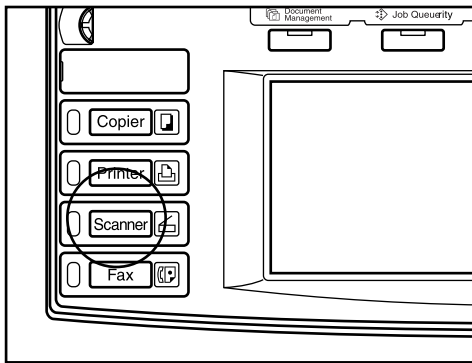

- 2 Touch the "TWAIN" key. The TWAIN Mode screen will appear.

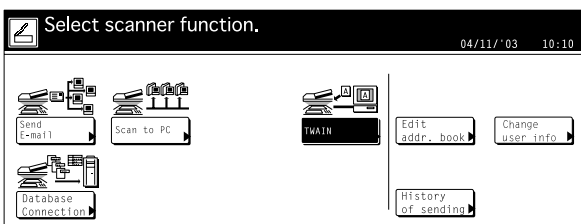

- 3 Set the original that you want to scan.

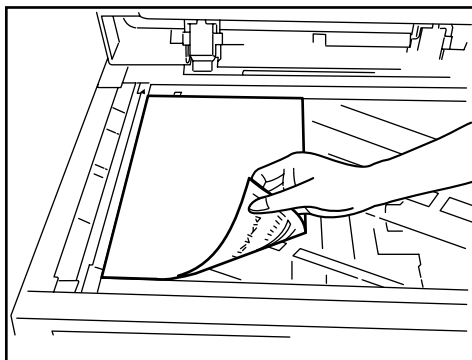

- 4 Run the TWAIN Source in the corresponding application. The main dialogue box for the TWAIN Source will appear. Make any settings that you want, click on the "Connect" button in the dialogue box and, once the connection to the scanner is made, click on the "Scan" button. Scanning will begin.

#### • When performing the scanning operation at your computer

- 1 Run the TWAIN Source in the corresponding application. The main dialogue box for the TWAIN Source will appear. Make any settings that you want, and put a check mark in the "Waiting Scan" checkbox.
- 2 Click on the "Connect" button in the main dialogue box and, once the connection to the scanner is made, click on the "Scan" button.
  - \* Putting a check mark in the "Waiting Scan" checkbox will allow you to start the actual scanning operation by pressing the Start key at the scanner.
- 3 Set the original that you want to scan in the scanner and press the Start key. Scanning will begin.
  - \* Scan settings can also be made on the operation panel of the scanner. Change any settings there that you want.
  - \* If you enter different values in your computer and in the scanner for the same setting, the settings made in the scanner will take priority.

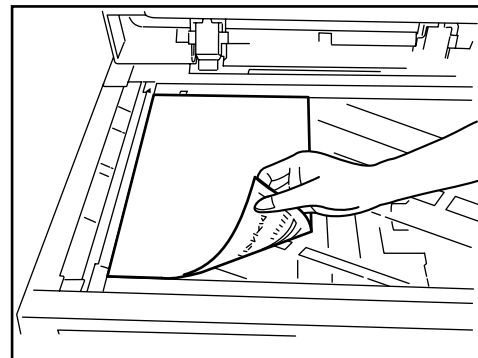



### 3. Performing the Required Operation at the Scanner

## 3-3 Setting up the Database Connection function

### (1) Preparations

First, perform the following set-up procedure in order to use the Database Connection function.

1. Install the DB Assistant into the network manager's computer.
2. Run the DB Assistant and perform the related settings for the Database Communication function.
3. Run the Scanner File Utility in the computer in which you want to save the scanned image data and perform the related settings for the Database Communication function.
  - \* The information for the computer(s) in which you installed the DB Assistant and the Scanner File Utility must be registered in advance at the scanner itself or using a Web browser.
  - \* Refer to the Functions Edition (On-Line Manual) of your Operation Guide for more detailed information.

The following section contains an explanation composed mainly of setting up the PDF Keyword Assist option (which allows you to add keywords as file information to scanned image data files).

### (2) How to set up the Database Connection function

- 1 Press the Scanner key. The "Scanner Mode Select" menu will be displayed.

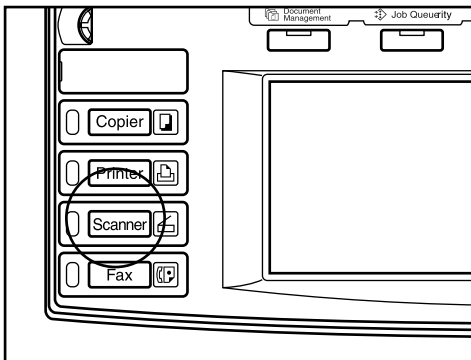

- 2 Touch the "Database Connection" key. The "Select sender name" screen will be displayed.

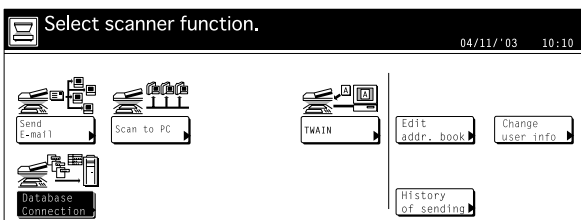

- 3 Use the ▲ or the ▼ cursor key to select your sender name and then touch the "Enter" key. The "Destination of input data" screen will be displayed.

- \* You can also select the destination by entering the corresponding user number directly using the keypad.
- \* If the "Selec. of senders (users)" setting is turned ON, the user that is registered under User Number 001 will be automatically selected.

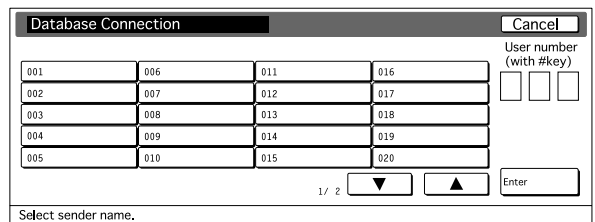

- \* If a password was designated during registration of that destination, the Password Input screen will appear first. After entering the appropriate password, touch the "Enter" key. If the entered password matches the registered one, the "Destination of input data" screen will appear.

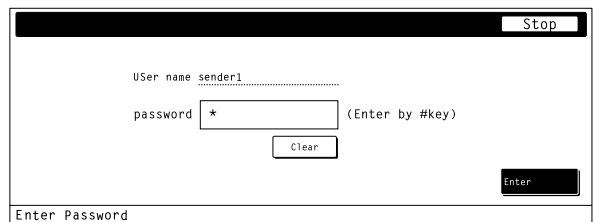

- 4 Use the ▲ or the ▼ cursor key to select the desired destination for the data and then touch the "Enter" key.

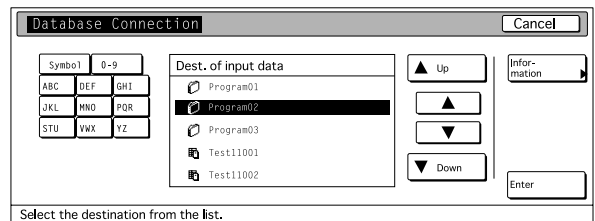

The following steps explain the procedure when you are using the PDF Keyword Assist option (which allows you to add keywords as file information to scanned image data files).

- \* To verify more detailed information related to a destination, use the s or the t cursor key to select the desired destination and then touch the "Information" key. The IP address and save folder number(s) of the destination computer can be verified.
- \* If you are using the Database Assist option (which creates a csv file of the file information for scanned image data files), and a password has been designated in the DB Assistant software, it will be necessary to enter the corresponding password.



- 5** In the “Folder select” screen, if you want to save the data into the currently highlighted folder, touch the “Enter” key. The “File Information” screen will be displayed. In this case, go to step 7. If, however, you want to save the data in a subfolder of the currently highlighted folder, touch the “Change inp. Folder” key. The contents of the currently highlighted folder will be displayed.

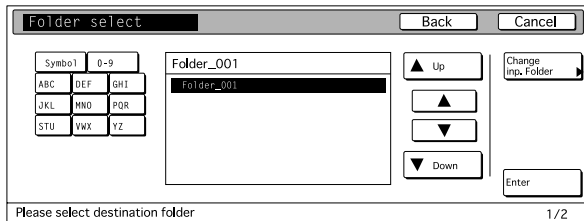

- \* If there is a period (“.”) included in the name of the destination folder, it is possible that the corresponding folder name may not be displayed properly in the “Folder select” screen.
- \* The destination can not be changed when you are using the Database Assist option.

- 6** Use the ▲ or the ▼ cursor key to select the desired destination folder and then touch the “Enter” key. The “File Information” screen will be displayed.

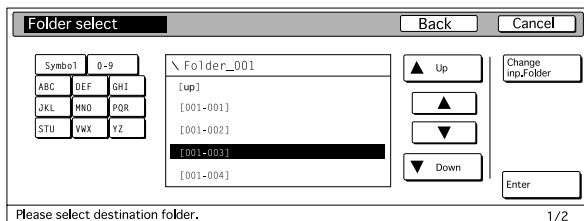

- \* To move one level back up in the folder hierarchy, touch the “Up” key.
- \* It is not possible to select a destination folder that exists at a higher level than the folder which was designated using the Scanner File Utility.

- 7** Select the item that you want to register the keyword under and then touch the “Enter” key. The input screen for the selected item will be displayed. (The following steps explain the procedure when you select the “Keyword” item.)

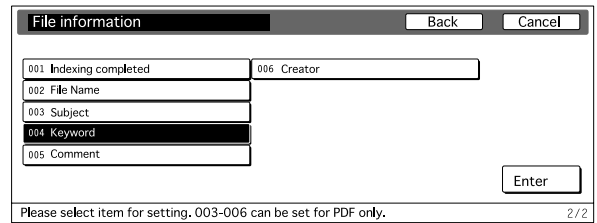

- \* You can also change the name of the file by selecting the “File Name” item.
- \* The keywords registered under the “Keyword”, “Subject”, “Creator” and “Comment” items will all be registered as keywords in the corresponding file information.
- \* If you are using the Database Assist option, the available items will differ.

- 8** Use the ▲ or the ▼ cursor key to select the keyword that you want to add for that item and then touch the “Enter” key. The touch panel will return to the “File Information” screen.

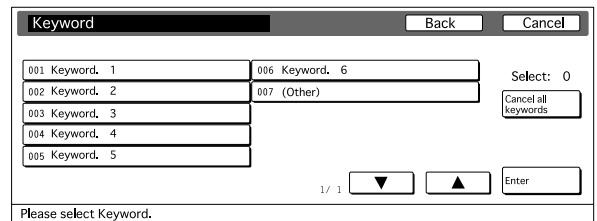

- \* If you want to enter a new keyword other than one of those that was already registered using the DB Assistant software, select the last item (“Other”), and then touch the “Enter” key. A screen to enter the new keyword will appear. To enter a new keyword, touch the “Type letter” key.

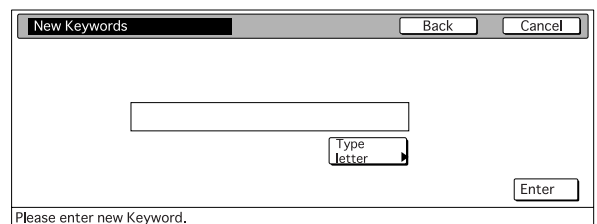

### 3. Performing the Required Operation at the Scanner

**9** An asterisk (“\*”) will be displayed next to each item that you have entered or changed the information for. Once you have finished registering information, touch the “Enter” key. The “Scan Settings” menu will be displayed.

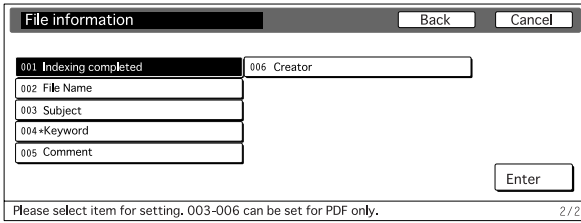

**11** Once the scanning operation is complete, the following screen will be displayed. If there are no more originals to be scanned, touch the “Input data complete” key.

- If you are using the PDF Keyword Assist option, the file information that you just registered will be added to the scanned image data file and that file will be saved into the designated folder.
- If you are using the Database Assist option, the file information that you just registered will be saved as a csv file and that file will be saved together with the scanned image data file into the designated folder.

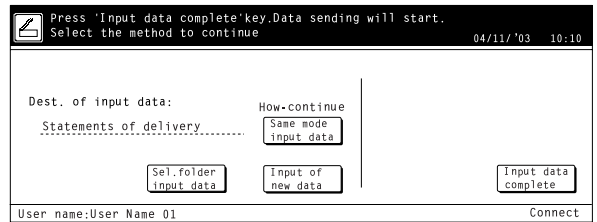

- \* If you want to use the Database Connection function once again, touch the “Sel.folder input data” key and perform the procedure from step 4 on page 3-6.
- \* If you want to use the Database Connection function once again, and at the same settings, touch the “Same made input data” key and perform the procedure from step 6 on page 3-7.
- \* If you want to use the Database Connection function once again, and under the same option (PDF Keyword Assist vs. Database Assist), touch the “Input of new data” key and perform the procedure from step 5 on page 3-7.

**10** Set the original to be scanned and press the Start key. The scanning operation will begin.

- \* You can change the scan settings as desired by simply performing the corresponding setting procedure on the scanner's operation panel.
- \* If you perform the same settings both from your computer and at the scanner itself, the specific settings made at the scanner will take priority.

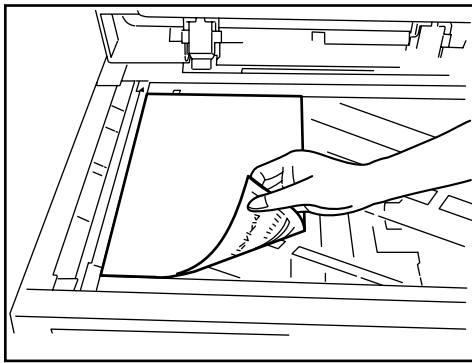

\* If you want to change any of the file information that you registered, touch the “Try again input data” key. The touch panel will return to the “File Information” screen.

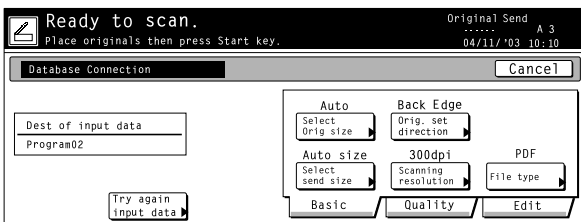

# 4. Troubleshooting

## 4-1 Error messages

If one of the following message appears during scanning, perform the corresponding procedure.

Message	Procedure
Unable to use scanner.	Check to make sure that the network cable is connected securely and properly. If this message appears immediately after turning the scanner ON, wait for awhile (approx. 2 minutes) while the scanner warms up.
Unable to find destination PC. Check the PC.	There is a problem at your computer. Check to make sure that the Scanner File Utility is running and the computer is able to receive data.
This name is already in use. Input new name again.	Register a different name.
This number is already in use. Input new number again.	Register a different number.
Registration full.	Delete any unnecessary items and try the procedure again.
E-mail size exceeds data capacity.	Reduce the number of pages being transmitted, or lower the scanning resolution, and try to transmit again.
Destination address is not being registered.	The entered number is not appropriate. Check the correct number and enter it again.
Unable to find SMTP server. Contact administrator.	Check to make sure that the network cable is connected securely and properly. If this message appears immediately after turning the scanner ON, wait for awhile (approx. 2 minutes) while the scanner warms up. In any other case, check to make sure that the SMTP server is running, or consult with your network administrator.
SMTP Authentication error. Contact administrator.	Consult with your network administrator to verify that the Login Account Name and password required for SMTP Authentication are correct.
Unable to find PC of personal address list.	If the Address Book software is not running on your computer, start it up. If it is already running, make sure that your computer is connect properly to the network and the network cable is connected properly to the Scanner Interface Card.
Network scanner system error.	Restart the scanner.
Communication error.	If you are using the Scan to PC function, check the status of the destination computer and then try the operation again. If you are using the Send E-mail function, check to make sure that the SMTP server is running, or consult with your network administrator.
Destination PC's system error.	Check the status of the destination computer and then try the operation again.

## 4. Troubleshooting

Message	Procedure
The file was not saved. Check the destination PC.	If the amount of data exceeds the maximum hard disk capacity as registered in the Scanner File Utility on the destination computer, increase the available space on your computer's hard disk and then try the operation again. If data with the same file name has been sent from more than one scanner at a time, the data can not be saved. Wait for awhile and then try the operation again, or change the file name.
Destination PC's application is out of order.	Check to make sure that the Scanner File Utility is running in the destination computer.
Destination PC is in use. Try again later.	The destination computer and the scanner are currently communicating. Wait for a while and then try the operation again.
Destination PC's version is different. Contact administrator.	The versions of the Address Book do not match. Consult with your network administrator.
PC of personal address list is in use. Try again later.	The designated Address Book and the scanner are currently communicating. Wait for awhile and then try the operation again.
Sender (user) is not registered. Contact administrator.	User Number 001 is not registered in the "Select sender name" List of this scanner. First register a user under that number or turn the "Selec. of senders (users)" setting OFF, then select another user.
No destination address being registered.	The selected destination is not registered. Register that destination or select another one.
Wrong password.	Enter the correct password.
Check domain name and host name.	The scanner's domain name and host name have not been registered properly. Check the correct domain name and host name. (Refer to "(3) Making settings from the touch panel" on page 2-2.)
Overflow of original pages. Scanned documents were sent.	The number of scanned pages exceeds 999, the maximum that can be transmitted at a time. Transmit any further pages separately. * When transmitting under settings such as "2-sided" or "booklet", there may be case where only 998 pages can be scanned and transmitted.
Check the DB Assistant PC. Contact administrator.	The DB Assistant can not be found. Make sure that the DB Assistant is running properly on the computer on which it is installed.
Communication error.	An unsupported response was received from the DB Assistant. Check the computer on which the DB Assistant is installed.
DB Assistant Server version is different. Contact administrator.	The versions of the DB Assistant do not match. Consult with your network administrator.
DB Assistant Server error. Contact administrator.	Communication could not be continued because an error occurred with the DB Assistant or with the computer on which it is installed.
DB Assistant Server is in use. Try again later.	DB Assistant is currently communicating with another scanner. Wait for a while and then try the operation again.

# 5. Specifications

---

## 5-1 Scanner specification

Operating Environment .....	IBM PC/AT or compatible OS: Windows 95 (OSR2), Windows 98 (Second Edition), Windows NT (Service Pack 5 or later), Windows 2000 (Service Pack 2 or later), Windows Me or Windows XP CPU: 133 MHz Pentium or faster (266 MHz Celeron recommended) RAM: 64 MB or more recommended Available hard disk space: 20 MB or more (300 MB or more recommended) CD-ROM drive: One
Ethernet Port .....	100BASE-TX and 10BASE-T (automatic switching)
Network Protocol .....	TCP/IP
Transfer Protocol .....	Proprietary system (for sending image data and making settings in the utilities), SMTP (for the Send E-mail function) and HTTP (for making settings from a Web browser)



**QUALITY  
CERTIFICATE**

This machine has passed  
all quality controls and  
final inspection.





## Free Manuals Download Website

<http://myh66.com>

<http://usermanuals.us>

<http://www.somanuals.com>

<http://www.4manuals.cc>

<http://www.manual-lib.com>

<http://www.404manual.com>

<http://www.luxmanual.com>

<http://aubethermostatmanual.com>

Golf course search by state

<http://golfingnear.com>

Email search by domain

<http://emailbydomain.com>

Auto manuals search

<http://auto.somanuals.com>

TV manuals search

<http://tv.somanuals.com>