

E

DIGITAL VIDEO CAMCORDER

Instruction Manual

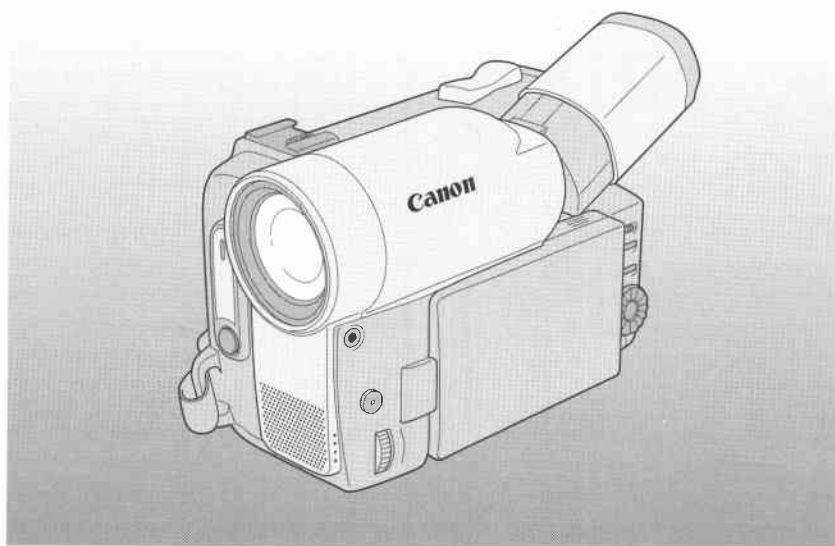

Canon

Mini DV Digital
Video
Cassette

MV10/MV10i

This instruction book explains the use of the MV10 and MV10i camcorders. The main difference between these models is that the MV10i includes a DV Recording function. The MV10i is only available in some areas. Please note that illustrations and explanations in this instruction book refer mainly to the MV10 model.

E (PAL)

Introduction

Mastering
the BasicsUsing the Full
Range of Features

Editing

Additional
Information

Important Usage Instructions

E

CAUTION:



TO REDUCE THE RISK OF ELECTRIC SHOCK, DO NOT REMOVE COVER (OR BACK). NO USER SERVICEABLE PARTS INSIDE. REFER SERVICING TO QUALIFIED SERVICE PERSONNEL.

WARNING:



TO REDUCE THE RISK OF FIRE OR ELECTRIC SHOCK, DO NOT EXPOSE THIS PRODUCT TO RAIN OR MOISTURE.

CAUTION:

TO REDUCE THE RISK OF ELECTRIC SHOCK AND TO REDUCE ANNOYING INTERFERENCE, USE THE RECOMMENDED ACCESSORIES ONLY.

Introduction

Contents

Introduction

Important Usage Instructions	2
Thank you for Choosing a Canon Camcorder	4
Introducing the MV10/MV10i	5

Mastering the Basics

Attaching the Ferrite Cores	6
Powering Your Camcorder	7
Loading a Cassette	9
Basic Recording	11
Zooming	14
Using the LCD Screen	15
Playing Back a Cassette	17
Connections for Playback on a TV Screen	20
Tips for Making Better Videos	24

Using the Full Range of Features

~ General ... ~	
Turning the Optical Image Stabilizer On/Off	26
Selecting from the Menus	27
Using the Wireless Controller/Tally Lamp	30
~ For Recording ...~	
Setting the Date and Time	32
Displaying Data Code	35
Taking Still Pictures (Photo Mode) ...	36
Searching the Tape (Photo Search/ Date Search)	37
Searching and Reviewing While Recording	38
Using the Various Recording Programs ..	39
Using Digital Effects	43
Audio Recording	46
Setting the Self-Timer	48
Using a Canon Speedlite for Flash Photography (optional)	49

~ When Making Manual Adjustments ...~	
Adjusting Focus Manually	50
Adjusting Exposure Manually	52
Setting the White Balance	55
Returning to a Pre-Marked Position	57

Editing

The Auto Editing Function	58
Preparing for Editing	59
Using the Editing Function for the First Time	60
Choosing a scene (SET Function)	62
Preview and recording	63
Cut-In and Cut-Out Adjustments	65
Deleting scenes and clearing the program	67
Reordering Scenes	68
Simple Editing to a VCR	69

Additional Information

Preparing the Camera	73
Notes on Using the Batteries	74
Setting the Audio Mix	77
Maintenance	78
Troubleshooting	82
The MV10/MV10i System Diagram ..	85
Optional Accessories	86
Finding Your Way Around MV10/ MV10i	90
Screen Displays	93
Specifications	97
Index	98

Thank you for Choosing a Canon Camcorder

E

First, we'd like to thank you for purchasing this Canon camcorder. Its advanced technology makes it very easy to use — you will soon be making high-quality videos which will give you pleasure for years to come.

Introduction

To get the most out of your new camcorder, we recommend that you read this manual thoroughly — there are many sophisticated features which will add to your recording enjoyment.

Getting started











To get started we suggest that you master the basic operations of the camcorder first, before moving on to use its full range of features.

For quick reference (in addition to the contents and index) please refer to:

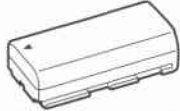
- Finding your way around the camcorder (p. 90)
- Screen displays (p. 93)
- Troubleshooting — in case you run into any problems (p. 82)

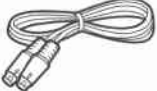
Note that capital letters are used to refer to settings displayed in the menus and buttons labelled on the camcorder itself e.g. Press the EJECT button.

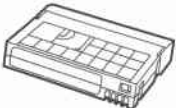
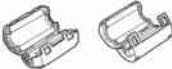
Your camcorder is supplied with the following accessories:

WL-D70 Wireless Controller 	Two AA batteries 
SS-200 Shoulder Strap 	Lens cap and lens cap cord 
BP-915 Battery Pack 	CA-500 Compact Power Adapter 
Lithium button battery 	S-150 S-video Cable 
STV-250 Stereo Video Cable 	Digital Video Cassette 
Two Ferrite Cores 	PC-A10 SCART Adaptor (Europe, Asia) 

Introducing the MV10/MV10i

Digital Video



MV10/MV10i is a next generation digital video camcorder that conforms to the new digital video **Mini DV** standard to give you outstanding picture quality.

2.8" LCD Screen



An LCD screen makes it easy for you to shoot colorful, well composed video. It is also great for playback.

Optical Image Stabilizer



Optical technology stabilizes your recordings even at the furthest reaches of the zoom range.

16× lens and 64× digital zoom



From wide-angle to 16× telephoto — with unparalleled optical quality. The digital zoom more than doubles this magnification for even more dramatic results.

Photo mode



An advanced Clear Still function allows you to take high quality still pictures.

FlexiZone Control



Easier than manual operation and more flexible than automatic functions, Canon's FlexiZone Control is a completely new way to use a video camera.

Auto editing function

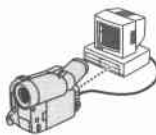

A complete set of editing functions is built-in — turn your recordings into finished productions, with no extra equipment required.

Digital effects



Advanced digital technology allows you to add special effects and varied scene transitions to your recordings.

PCM Digital Sound



Offers you stunning digital sound — 16 bit for greater than CD-quality sound, and 12 bit for the playback of audio-dubbed cassettes.

Lithium ion power supply



MV10/MV10i features the latest in portable power technology.

DV Terminal (IEEE1394)

MV10/MV10i is equipped with DV terminal that conforms to IEEE 1394. By connecting the MV10/MV10i to your computer, you can capture still or motion images on your computer (optional IEEE1394 computer interface board required).

Attaching the Ferrite Cores

E

Attach the enclosed ferrite cores before you use the CA-500 Compact Power Adapter and S-150 S-video Cable.

Attach the ferrite core to the cable about 4 cm from the plug end (the plug to be connected to the camcorder) of the CA-500 Compact Power Adapter and S-150 S-video Cable.

- Pass the cable through the centre of the core and wrap it around the core once, then close the unit until it clicks shut.
- There are two kinds of ferrite cores; attach the appropriate one as shown.

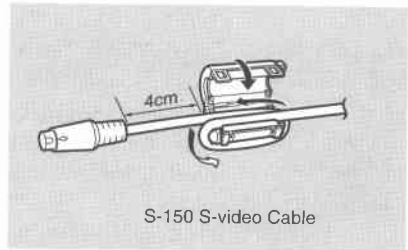
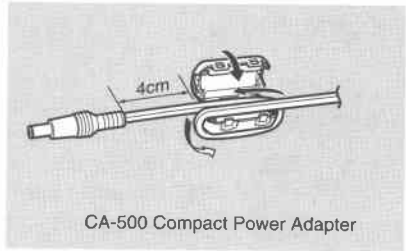

Note:

- When using the camcorder connected to the computer to capture still pictures, it may cause noise interference on other peripheral devices connected to the computer. If this occurs, disable the attached device.

Powering Your Camcorder

Before operating your camera, you will need to use the power adapter to:

Provide power from an AC outlet

or

Charge a battery pack

Notes:

- The power adapter converts current from a household power socket (100–240 V AC, 50/60 Hz) to the DC current used by your camera.
- If the adapter is used next to a TV, it may cause noise bars to appear on the TV— move the adapter away from the TV or the antenna cable.

Connecting the camera to an AC outlet

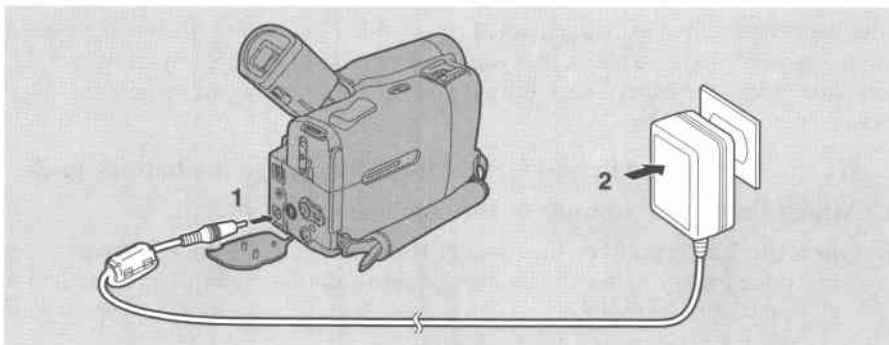

Use the power adapter to provide your camera with instant power from an AC outlet.

1. Connect the power adapter to the camera's DC IN terminal.

2. Plug the adapter into a mains outlet.

3. Remove the power adapter after use.

- Always turn the camera off before connecting/removing the power source.

CA-500 Compact power adapter

Specifications

Power supply	100–240V AC, 50/60Hz
Power consumption	12 W
Rated output	9.5V, 0.8A DC
Operating temperature range	32°–104°F (0°–40°C)
Dimensions	65 × 31 × 49 mm (2 9/16 × 1 1/4 × 1 15/16 in)
Weight	130g (4 9/16 oz), UK Model: 155g (5 7/16 oz)

Weight and dimensions are approximate. Errors and omissions excepted.
Subject to change without notice.

Charging and attaching the battery pack

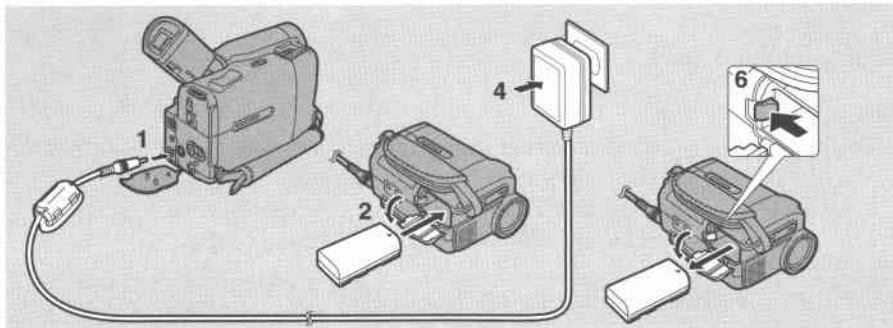

Your battery pack was partially charged before it left the factory. It should have enough power for you to check that your camera is working properly. However, you must charge the battery pack fully if you want it to power the camera for more than a few minutes.

- 1. Set the POWER switch to OFF before you charge the battery pack.**
- 2. Attach the power adapter to the camera.**
- 3. Open the battery cover and insert the battery into the camera.**
 - Insert the battery in the direction of the arrow until it clicks into place, then close the battery cover.
- 4. Plug the adapter into a mains outlet.**
 - The charge indicator flashes red to show that charging is in progress. Single flashes mean that the battery pack is less than 50% charged. Double flashes mean that it is between 50% and 75% charged. Triple flashes mean that it is more than 75% charged. The indicator glows steadily when the battery pack is fully charged.
 - Charging will also take place when the camera is in stop mode during PLAY (MV10i:VCR) mode, and the power is off in camera mode. This charging will take longer than when the POWER switch is set to OFF (the charge indicator also flashes/grows steadily).
- 5. When charging is complete, disconnect the power adapter.**
 - The charge indicator glows steadily.
- 6. Remove the battery pack after use.**
 - Place the camera on its side before removing the battery pack, since the battery pack may drop out when you press the battery release button.
 - Press the battery release button to the left.
 - Always turn the camera off before removing the power source.

Note:

- You can find detailed notes for using the batteries in the “Notes on Using the Batteries” on p. 74. These notes include charging and recording times and how to install the back-up battery.

Loading a Cassette

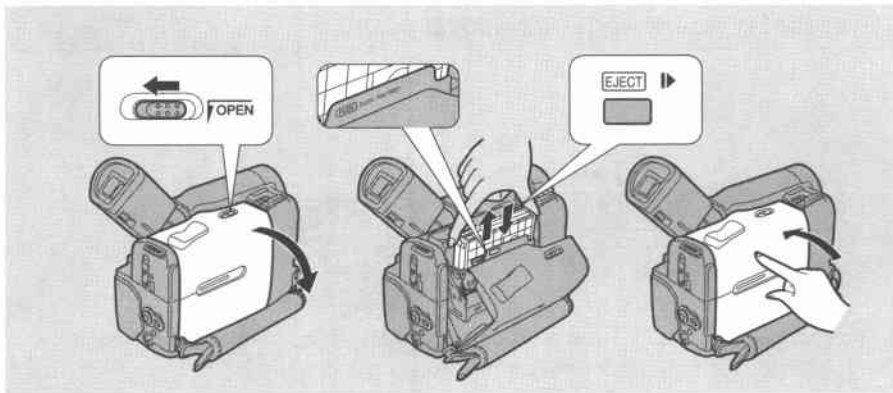

Only use videocassettes marked with the **Mini DV** logo.*

Loading and unloading

1. Make sure that you have inserted a power source.
2. Slide the **OPEN** button to release the cover (the camera's grip).
 - Pull the cover fully open.
3. Press the **EJECT** ► button and wait for the cassette compartment to open.
4. Load or unload the cassette.
 - Insert the cassette gently with the window facing out.
 - Remove the cassette by pulling it straight out.
5. Press the **(PUSH)** mark on the compartment until it clicks, and wait for it to close.
6. Click the cover back into place.

* **Mini DV** is a trade mark

Notes:

- After loading a cassette, use record search (p. 38) to find the point where you want to start recording.
- Do not interfere with the cassette compartment while it is opening or closing automatically, or attempt to close the cover.
- Do not leave the cassette in the camera after use — return it to its case and store it in a cool, clean, dry place.
- The holes in the back of the cassette are used for transferring information — do not cover them.
- When a cassette is not loaded,  flashes in the display.

Protecting tapes from accidental erasure

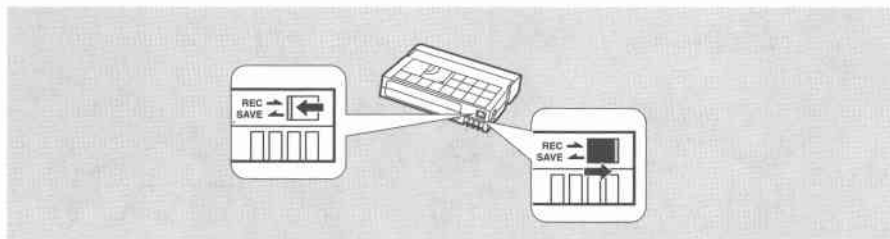

To protect your recording from accidental erasure, slide the tab on the cassette so that it exposes the hole. (This switch position is usually labeled SAVE or ERASE OFF.)

If you load this cassette and put the camera in record pause mode (p. 11), “THE TAPE IS SET FOR ERASURE PREVENTION” is displayed for approx. 4 seconds and then the  mark flashes in the display. The camera also shows the above phrase if you accidentally press the DV REC button with the camera switched to PLAY (MV10i:VCR) mode.

If you want to record on the cassette again, slide the tab back so the hole is closed.

Handling cassettes

- To protect the tape heads, transfer cassettes directly from the tape case to the camcorder — do not open the tape protect cover or touch the tape itself.
- Do not use cassettes where the tape has been damaged or spliced — they may damage the camcorder.
- Do not insert anything into the small holes on the cassette or cover them with cellophane tape.
- Handle cassettes with care — dropping them or exposing them to external shocks may cause internal damage.
- Store cassettes in the provided case, first rewinding them to the start of the tape, and then storing them upright.
- A cassette with metal plated terminals may become dirty with use, affecting information transfer. Therefore, after using a tape around ten times, be sure to clean the terminals with a cotton wool bud.

Cassette Memory

You cannot use the cassette memory function with this camcorder.

Basic Recording

E

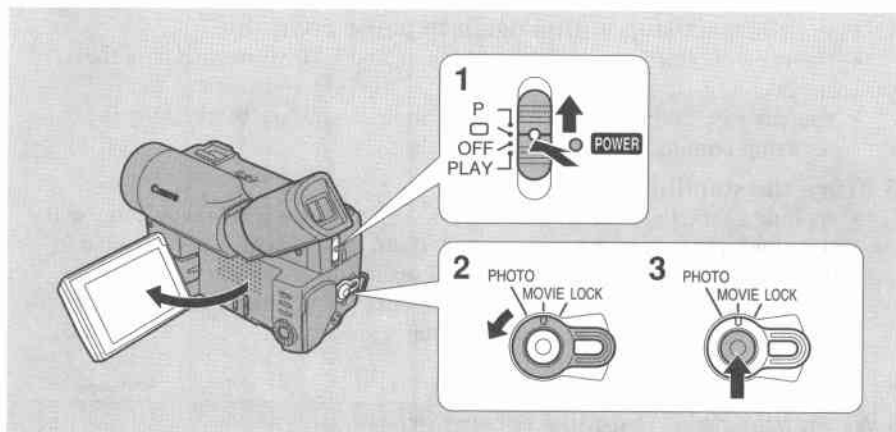

Before you start recording

Have you completed the following steps?

- Attached a power source (p. 7).
- Loaded a cassette (p. 9).
- Removed the lens cap and fastened the grip belt (p. 73).
- Chosen the display: viewfinder or LCD screen (p. 15)
- Adjusted the viewfinder (as applicable, p. 73).

You may also want to install the backup battery (p. 75) in order to set the date and time display (p. 32).

To record

- 1. Press down and slide the POWER switch to .**
 - The camera power indicator lights up red.
 - This selects the camera's Easy Recording program. It allows you to simply point and shoot without making any manual adjustments (see p. 40).
- 2. Turn the standby lever to MOVIE.**
 - PAUSE appears in the display — the camera is now in "record pause mode."
 - The camera will turn itself off if you leave it in record pause mode for more than about five minutes. To return to record pause mode, turn the standby lever to LOCK and back again, or set the POWER switch to OFF and then back to .
- 3. Press the start/stop button to begin recording.**
 - The tally lamp flashes rapidly and REC appears in the display.
 - It is convenient to use the start/stop button on the front cover when you shoot low angle recordings.

4. Press the start/stop button again to pause recording.

- The camera returns to record pause mode and PAUSE reappears in the display.
- You can stop and restart recording as often as you like by pressing the start/stop button.

5. Turn the standby lever to LOCK.

- As long as the POWER switch is set to or P (see p. 11), you can use the standby lever to turn the camera on and off. This makes it easy to save battery power, and prevents accidental operation of the start/stop button. It is also useful when you want the camera to remember your manual settings, such as white balance and shutter speed.

When you have finished recording

- Replace the lens cap.
- Return the LCD screen flush to the camera body.
- Unload the cassette.
- Set the POWER switch to OFF.
- Disconnect the power source.

Notes:

- In addition to (Easy Recording), the camera has six other recording programs. Turn the POWER switch to the P position to give you access to these recording programs (p. 39) and also to the digital effects (p. 43).
- To check that the camera is recording correctly, make a test recording first.
- Before making important recordings, clean the video heads using a Canon DVM-CL Digital Video Head Cleaning Cassette or a commercially available digital video head cleaning cassette.
- You cannot monitor the sound from the speaker when recording, you can use headphones instead.
- For tips on how to make better videos, see page 24.

Changing the recording mode (SP/LP)

E

You can record and play back a tape in SP (standard play) and LP (long play) modes. LP extends tape usage by 1.5 times.

To switch to LP mode, select REC MODE from the camera or PLAY (MV10i:VCR) menu, select LP and then close the menu (for instructions on how to use the menus, refer to page 27).



Notes:

- When recording and playing back tapes in LP mode, the nature of the tape and usage conditions may affect recording, Mosaic-like noise may appear in the image and the sound may be distorted during playback of tapes recorded in LP mode. For important recordings, therefore, set the camera to SP mode.
- If you record in both modes on the same tape, the picture may become distorted during playback and the time code may not be written correctly.
- A tape recorded in LP mode on other digital equipment may produce mosaic-like noise and the sound may become distorted when played back on this camcorder, and vice versa.

Zooming

E

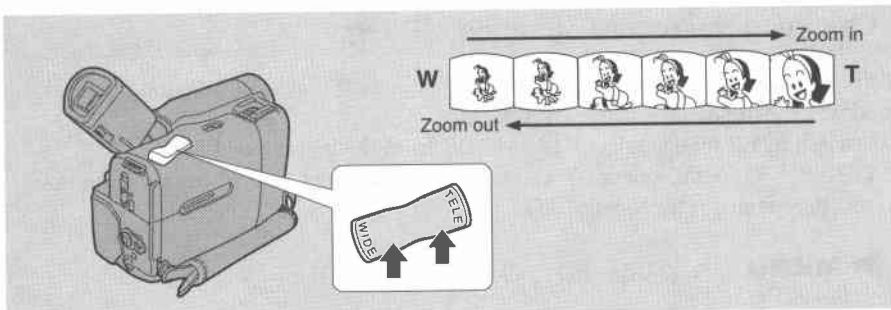

16× optical zoom

The camera's 16× zoom lens allows you to choose the best picture angle for each scene:

- Press the zoom control towards WIDE to zoom out to wide-angle.
- Press it towards TELE to zoom in to telephoto.

You can also control the speed of zooming:

- Press the control slightly to zoom slowly.
- Press it further to zoom more quickly. (The further you press the zoom control, the faster the zoom speed.)

The T and W buttons on the wireless controller adjust the picture angle, but not the zoom speed.

64× digital zoom

Turn the digital zoom on by choosing D. ZOOM from the camera menu, to more than double the camera's zoom range.



▶D. ZOOM.....ON

(For an explanation of how to use the camera menu see page 27)

The zoom control continues to work as usual. You can freely zoom in and out between 1× and 64× magnification — the camera automatically switches between optical zooming (up to 16×) and digital zooming (16× to 64×).

Notes:

- When you want to get as close as possible to your subject, keep the zoom at the wide-angle position. You can focus on a subject as close as 1 cm (3/8 in).
- Image resolution is slightly lower when the magnification is greater than 16× optical zoom.
- When the zoom enters the digital area, the zoom indication will be longer and the digital area will be light blue.

Using the LCD Screen

Switching between displays

When you open the LCD screen, it turns on. When you close it, the viewfinder turns on instead. When the LCD screen is closed with its screen side facing up, the LCD screen remains on.

Changing the angle of the LCD screen

You can choose the angle of the screen that suits you best by opening and rotating the screen, also you can rotate the LCD screen so that faces backwards. This is very convenient for playback.

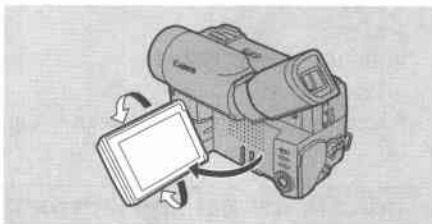

Notes:

- Avoid touching the LCD screen.
- Do not hold the camcorder by the LCD panel.
- Bright light falling on the LCD screen may cause glare that makes it difficult for you to view the image. In this case, switch to using the viewfinder.
- When you turn on the camera, the display always appears on the LCD screen in PLAY (MV10i:VCR) mode.

The display may appear in the viewfinder in camera mode, if you were using the viewfinder when the camera was turned off.

About the LCD Viewfinder/Screen

The LCD screen built into this camcorder is a high precision product. However, small black dots or bright points of light (red, blue or green) may appear on the LCD screen. This is not a malfunction of the LCD screen and they are not recorded on the tape. (Effective dots: more than 99.99%)

Allowing the subject to monitor recording

When you turn the LCD panel so that it faces the opposite direction (see diagram opposite), you can watch yourself during recording or let your subject monitor recording.

- During this “monitor recording”, you can choose the display style, reversed (mirror on) or not (mirror off) from the camera menu.

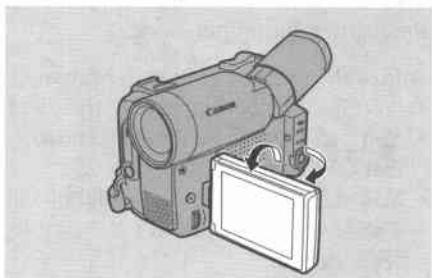

MENU
(see p. 27)

▶ MIRROR ON

(For an explanation of how to use the camera menu see page 27)

If you choose the mirror-on, the recording itself is unaffected.

- During “monitor recording”, the time code and remaining tape indicators disappear.

Note:

- During “mirror mode recording”, you cannot operate the following functions;
 - Volume control of built-in speaker and headphones
 - LCD screen brightness adjustment
 - Digital effects*
 - Menu*
 - Shutter speed*
 - Program AE*

* Except when the LCD screen is closed with its screen side facing up.

Indications that appear when “mirror” is selected:

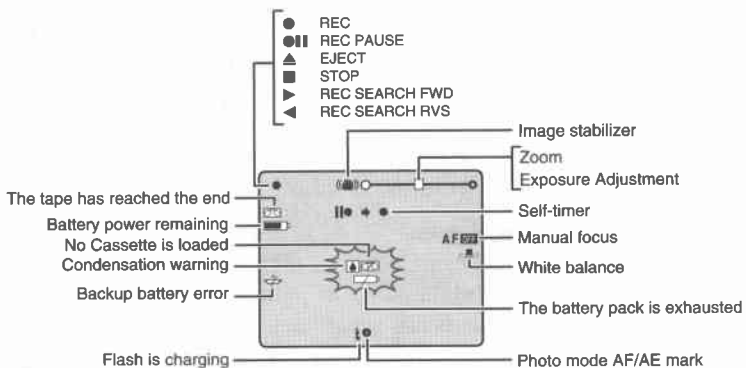

Built-in speaker

The camcorder has a built-in speaker so you can review the sound track alongside the picture during playback.

Adjust the speaker volume by pressing the volume control buttons.

- A VOLUME bar appears in the display to indicate the current volume.
- You can turn off the built-in speaker completely by pressing the ▼ button so that OFF appears.
- You can also adjust the headphones volume separately from the built-in speaker.
- The levels you adjusted for the built-in speaker and headphones are memorized separately.

Note:

- The speaker turns off when the camera is set to camera mode or when you use headphones.

Playing Back a Cassette

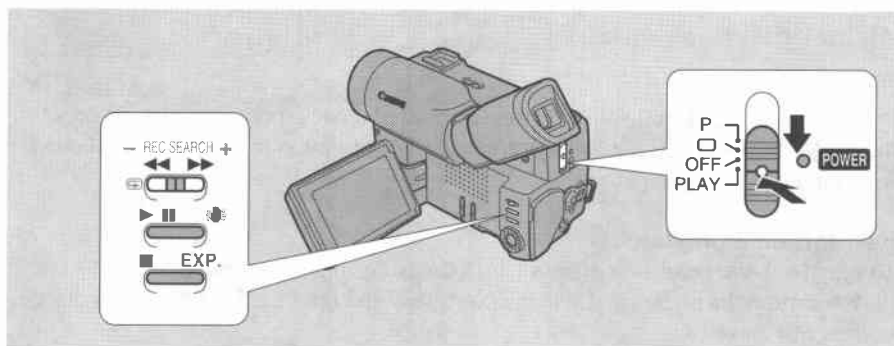

You can use the LCD screen for instant, on-the-spot playback. The camera also plays back the sound track via the built-in speaker (p. 16).

- When you play back a tape, it is convenient to close the LCD screen with its screen side facing up.
- When the LCD screen is closed, you can monitor the playback using the viewfinder. However, you can only monitor the sound track using headphones.

To play back your recordings on a TV, see p. 20.

To use the wireless controller, see p. 30.

Note:

- To avoid accidental recording, make sure that you slide the tab on the cassette so that it exposes the hole (the switch position is usually labelled SAVE or ERASE OFF).

1. Attach a power source and slide the **POWER** switch to **PLAY** (MV10i:VCR).

- The power indicator lights up green.

2. Load the cassette.

3. Press the **PLAY** ► button to start playback.

- To end playback, press the **STOP** ■ button.
- To wind the tape forwards, stop playback and press the **FF** ►► button.
- To wind the tape backwards, stop playback and press the **REW** ◀◀ button.
- If the playback picture is distorted (mosaic-like noise), clean the video heads using a Canon DVM-CL Digital Video Head Cleaning Cassette or a commercially available digital video head cleaning cassette.

Other playback modes

Playback pause

Press the PAUSE **||** button. To resume normal playback, press it again, or press the PLAY **▶** button. The camera automatically goes into stop mode after about five minutes' playback pause.

Fast forward playback

To play back the recording at about 11.5 times normal speed, press and hold the FF **▶▶** button during normal playback or press and hold the FF **▶▶** button during normal fast forward.

Rewind playback

For reverse playback at about 11.5 times normal speed, press and hold the REW **◀◀** button during normal playback or press and hold the REW **◀◀** button during normal rewind.

Special playback

These can only be operated from the wireless controller (p. 30).

Frame Advance

To play back frame by frame, press the +/▶▶▶ button or turn the command dial clockwise repeatedly during playback pause.

Press and hold +/▶▶▶ to play back frame by frame continuously.

Frame Reverse

To play back on reverse frame by frame, press the -/◀◀◀ button or the command dial counter-clockwise repeatedly during playback pause.

Press and hold -/◀◀◀ to play back frame by frame in reverse continuously.

Slow Forward Playback

To play back at about 1/5 normal speed, press the SLOW ▶▶ button during normal playback.

Press the PLAY ▶ button to return to normal playback.

- The camera automatically returns to playback after about 30 seconds of slow playback.

Slow Reverse Playback

To play back in reverse at about 1/5 normal speed, press the -/◀◀◀ button and then the SLOW ▶▶ button during normal playback.

Press PLAY ▶ to return to normal playback.

- The camera automatically returns to ×1 reverse playback after about 30 seconds of slow playback.

Reverse Playback

To play back in reverse at normal speed, press the -/◀◀◀ button during normal forward playback.

Press the PLAY ▶ button to return to normal forward playback.

Forward ×2 Playback

Press the ×2 button during normal playback.

Press the PLAY ▶ button to return to normal playback.

Reverse ×2 Playback

Press the -/◀◀◀ button and then the ×2 button during normal playback.

Press the PLAY ▶ button to return to normal playback.

Note:

- Mosaic-like noise appears on the screen during some of the PLAY (MV10i:VCR) modes and the sound track cannot be heard.

Connections for Playback on a TV Screen

E

You can connect the camera to a TV or VCR in order to play back your recordings. You will need to attach a power source to the camera (see p. 7).

See your TV or VCR instruction manual for further details.

If your TV (or VCR) has a SCART terminal (without S-video)

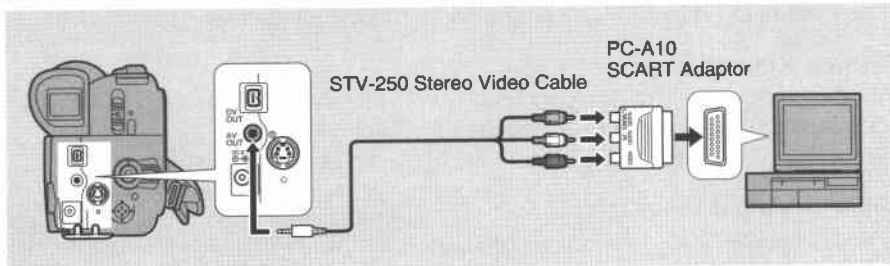

- Connect the PC-A10 SCART adaptor to the TV or VCR's SCART terminal.
- Connect the camera to the adaptor. Connect the camera using the STV-250 Stereo Video Cable. Connect the white plug to the white audio terminal **L** (left). Connect the red plug to the red audio terminal **R** (right). Connect the yellow plug to the yellow video terminal **V**.
- Set the TV/VIDEO selector on the television to VIDEO.
- If you are connecting the camera to a VCR, set the input selector on the VCR to LINE.

If your TV (or VCR) has an S-video input terminal

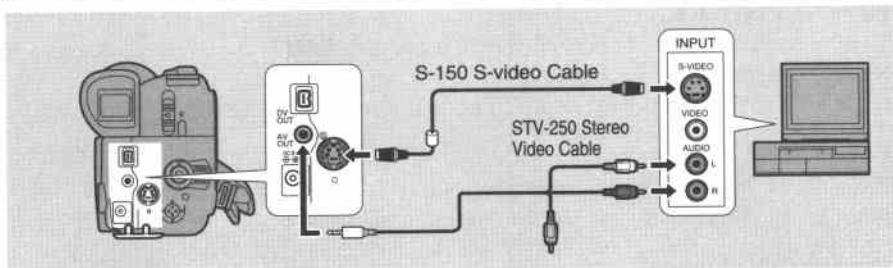

- Use the S-150 S-video Cable to connect the S-video terminal **S**. Use the STV-250 Stereo Video Cable, to connect the AUDIO terminals. Connect the white plug to the white AUDIO terminal **L** (left). Connect the red plug to the red AUDIO terminal **R** (right). Do not connect the yellow plug.
- Set the TV/VIDEO selector on the television to VIDEO.
- If you are connecting the camera to a VCR, set the input selector on the VCR to LINE.

If your TV (or VCR) has audio/video input terminals

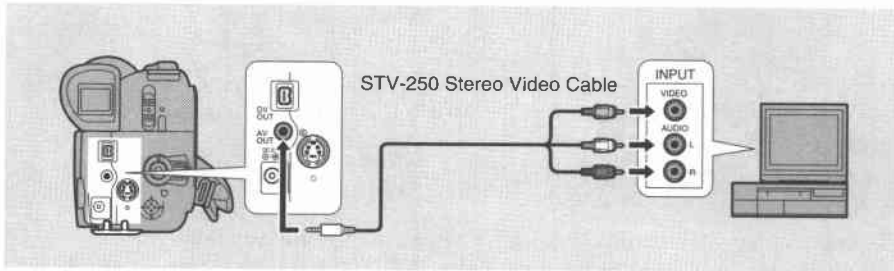

- Connect the camera using the STV-250 Stereo Video Cable. Connect the white plug to the white audio terminal (L) (left). Connect the red plug to the red audio terminal (R) (right). Connect the yellow plug to the yellow video terminal (V).
- Set the TV/VIDEO selector on the television to VIDEO.
- If you are connecting the camera to a VCR, set the input selector on the VCR to LINE.

Note:

- If you are going to use the TV as a monitor while you are shooting, remember to keep the TV volume turned down as long as the camera's audio terminals are connected. If the sound from the TV speakers is picked up by the microphone, an unpleasant high-pitched squeal, called feedback, may be produced.

If your TV is already hooked up to a VCR, you can connect the camera to the VCR instead of the TV. Follow the instructions on the previous page.

If your TV does not have audio/video input terminals

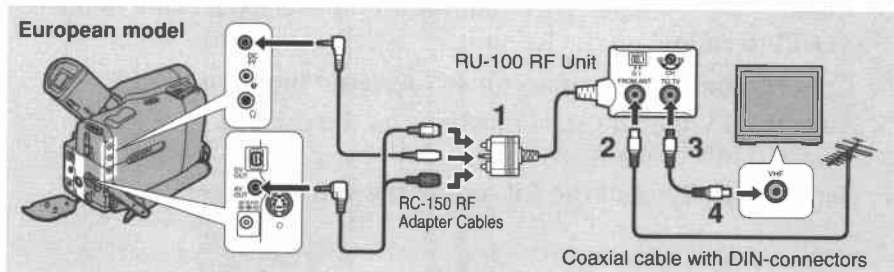

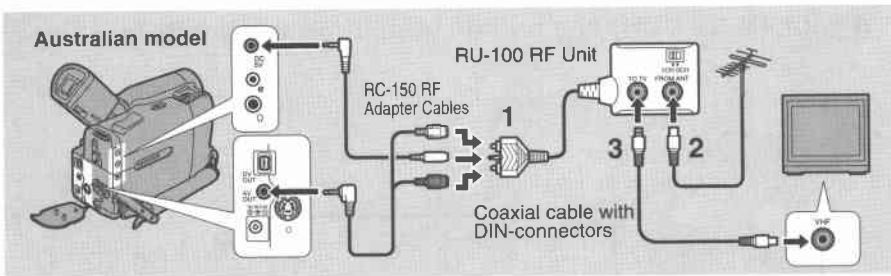

To connect the camera directly to a TV which does not have audio/video terminals, you will need to use the optional RU-100 RF Unit together with the optional RC-150 RF cables.

The soundtrack will be in mono. There are two different models, one for Australia, and one for Europe and other areas.

Connecting the RF unit/adaptor cables

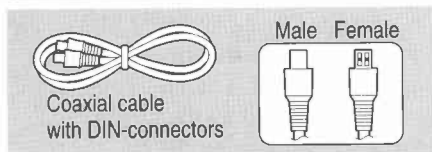

1. **Connect the RF unit to the camera, using the RC-150 RF adaptor cables.**
 - The RF unit and RF adaptor cables are available optionally.
2. **Connect the aerial cable to the FROM ANT. terminal on the RF unit.**
3. **Connect the “female” DIN-connector on the coaxial cable to the TO TV terminal on the RF unit.**
4. **Connect the “male” connector to the aerial input on the TV.**
5. **Turn the TV on, and start playback on the camera.**
 - See p. 17 for playback.
6. **Set both the TV and the RF unit to the video channel.**

Selecting the video channel

The video channel is the channel which is not used by a broadcasting station in your area and can be used for cassette playback.

European model

First set the G/I selector on the RF unit.

- In continental Europe, set it to G.
- In the UK, Hong Kong and South Africa, set it to I.

If it is not set properly, you will be able to see the picture, but not hear the sound.

Next, set the TV and the CH selector on the RF unit to the video channel. The selector is factory-set to channel 32.

Adjust it by turning until the picture is clear.

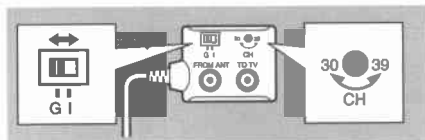

Australian model

Set the TV and the RF unit to channel 0 or 1.

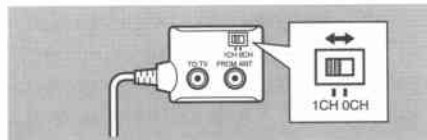

Note:

- Turn the camera off or disconnect it from the RF unit when you want to watch a broadcast programme. If you leave the camera connected and turned on, the RF unit will automatically select the camera signal instead of the broadcast signal.

Tips for Making Better Videos

E

Holding the camera

For maximum stability, grip the camera firmly with your right hand and keep your right elbow pressed against your body. Support the camera under the lens with your left hand. With practice, you will be able to operate the controls by touch, without taking your eye off the action.



Using a tripod

To prevent any unwanted movement, you can mount the camera on a tripod, (or any flat surface at a suitable height.) and operate it with the wireless controller.

- When you are using a tripod, be careful not to leave the viewfinder exposed to bright sunlight or it may melt. (The light is concentrated by the viewfinder lens.)
- Make sure that the fastening screw of the tripod is no longer than 5.5 mm (3/16 inch), or it will damage the camera.



Composition

The most important element in the scene does not have to be in the center. For a more interesting picture, try to position your subject so it is slightly to one side. Leave some space on the side of the frame that the subject is facing or moving towards.



Don't cut off the top of the subject's head, and don't cut people off at the neck, hips or knees (move a little bit above or below).



Watch out for distracting objects in the background.



Picture angle

Instead of zooming while recording, try to choose your picture angle before you begin. A good way to tell a story with video is to begin with a long shot that establishes the situation, and then move in with medium shots and close-ups to show the details. Remember to change your viewpoint for each shot.

Remember that any camera movement or change in picture angle should have a definite purpose. Avoid unnecessary or half-hearted movements.



Long shot



Medium shot



Close-up

Camera moves

Use pans to record a landscape or follow a moving subject. Decide the area you want to cover and stand facing the end of your panning angle. Without moving your feet, turn your waist to the starting position. Start recording, and after a few seconds begin to turn slowly from the waist. Hold the final image for a few seconds before you stop recording.

Tilt the camera up to exaggerate the height of the subject. Tilt down from the top of a building, for example, as an introduction to subjects at the bottom.

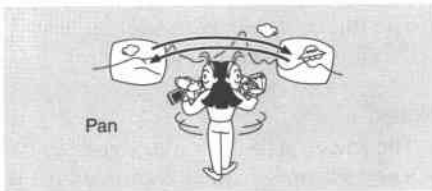

Turning the Optical Image Stabilizer On/Off

E

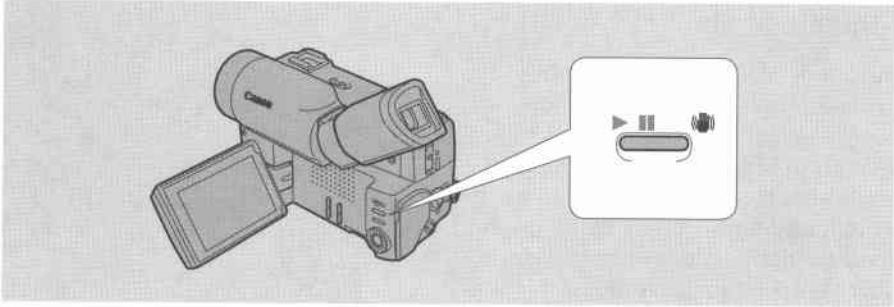

With most camcorders, even the slightest hand movements will be noticeable during telephoto recording. However, the MV10/MV10i's Optical Image Stabilizer allows you to obtain steady recordings even at 16× or 64× magnification. Unlike electronic image stabilizers, it causes no loss of picture quality. The Optical Image Stabilizer can compensate for a wide range of camera movement — you can record stable images even if you are shooting from a moving car.

Before you start recording, push the (👤) on/off button to turn the image stabilizer on or off.

- The (👤) mark appears in the display when the stabilizer is on.
- The image stabilizer cannot be turned off when the POWER switch is set to the (Easy Recording) position.

Notes:

- The image stabilizer is designed to deal with a normal degree of camera shake.
- Keep the image stabilizer turned off when the camera is mounted on a tripod.
- The image stabilizer is not as effective as usual when the tele-converter (optional) is attached.
- The new Canon Optical Image Stabilizer system shifts an internal lens to remove camera shake. When the camcorder is turned off, the lens moves freely. This may produce a clicking sound when the camera is moved. This is not malfunction.

Selecting from the Menu

Many of the camera's advanced functions are selected from menus which appear in the display.

There are four main menus:

1. **Camera menu (when the camera is in record pause mode: the POWER switch set to or P and the standby lever set to MOVIE or PHOTO)**
2. **PLAY (MV10i:VCR) menu (when the POWER switch is set to PLAY (MV10i:VCR))**
3. **Edit menu (when the POWER switch is set to PLAY (MV10i:VCR) and you select the \blacktriangleright EDIT MODE from the PLAY (MV10i:VCR) menu)**
4. **Set up menu (when you select the \blacktriangleright SET UP from the Edit menu)**

Camera menu (CAM. MENU)

- ① Digital zoomp. 14
- ② 16:9 modep. 45
- ③ White balancep. 55
- ④ Wireless controlp. 31
- ⑤ Tally lampp. 31
- ⑥ Record mode.....p. 13
- ⑦ Audio modep. 46
- ⑧ Wind screenp. 47
- ⑨ Self view recording.....p. 15
- ⑩ Time zone/Daylight saving timep. 32
- ⑪ Date and time setp. 34

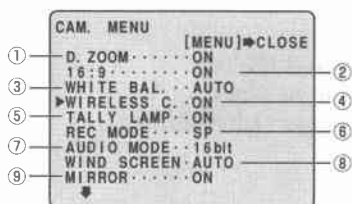

PLAY (MV10i:VCR) menu

- ① Select edit modep. 59
- ② Wireless controlp. 31
- ③ Record mode.....p. 13
- ④ Audio monitorp. 77
- ⑤ Select data code displayp. 34
- ⑥ Select date and time displayp. 34
- ⑦ Information displaysp. 93

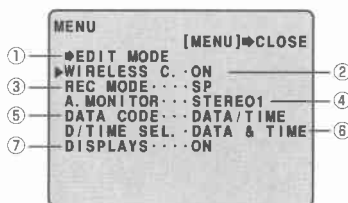

Turn to the appropriate page for a detailed explanation of each function.

Edit menu (EDIT MODE)

- ① Setp. 62
- ② Relocatep. 68
- ③ Deletep. 67
- ④ Previewp. 63
- ⑤ Start.....p. 64
- ⑥ Clear allp. 67
- ⑦ Select set upp. 60

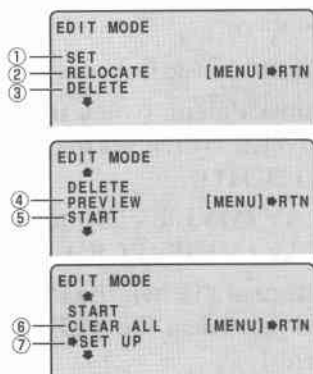
**Set up menu (SET UP)**

- ① Wireless controlp. 31
- ② Select recorderp. 60
- ③ Cut-in adjustmentsp. 65
- ④ Cut-out adjustmentsp. 65

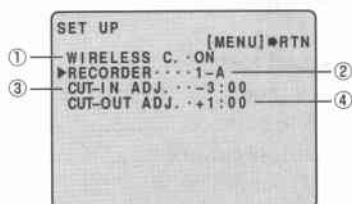

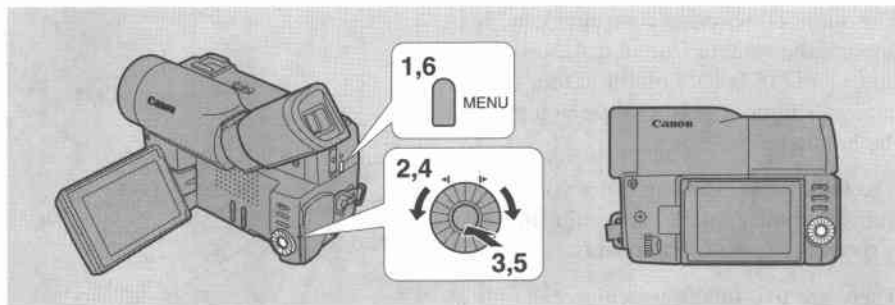

It is convenient to close the LCD screen with its screen side facing up when you select items from the menus. Press the screen until it clicks into place.

1. Press the MENU button to open the menu.
2. Turn the command dial to move the arrow up or down the display.
3. Press the execute button to select your chosen option from the menu.
 - Your selected option remains on the screen and all other options are removed.
4. Turn the command dial to choose the option setting.
5. Press the execute button to select the option setting.
6. Press the MENU button once more to close the menu.

Notes:

- You can only see nine options on the screen at the same time. Pointers at the top/bottom of the screen indicate that there are more options that you can scroll through.
- You may often find it convenient to use the wireless controller to move around the menus. Press its MENU button to enter/leave the menu and use the cursor keys in place of the command dial.
- You can display the menus on a connected TV screen using the wireless controller's TV SCREEN button.

Using the Wireless Controller/Tally Lamp

E

The supplied wireless controller can operate the camera from a distance of up to 5 m (16 feet). Point it at the camera's remote sensor while you press the buttons.

The tally lamp lights up to let you know that the camera is in range and responding to your commands.

There are five functions which can only be operated using the wireless controller:

- Special playback (p. 19)
- TV-screen displays (p. 93)
- Data code on/off (p. 35)
- Photo/Date search (p. 37)
- 12 bit Audio output (p. 77)

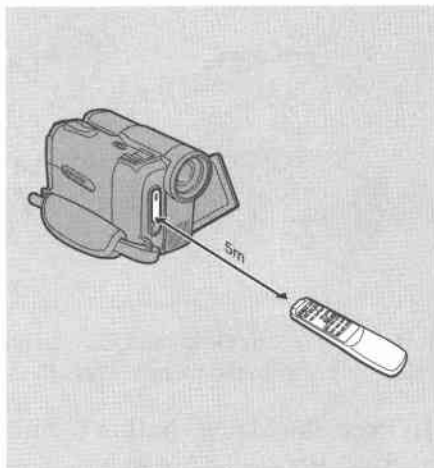

Inserting batteries

Insert two AA batteries, following the \oplus and \ominus markings. Be careful not to reverse the polarity of the batteries.

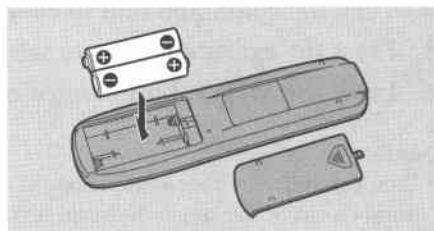

Notes:

- When using the wireless controller in brightly lit places or outdoors, the effective range will be less.
- The camera may have difficulty picking up the remote control signals at extremely close range.
- Do not leave the controller exposed to direct sunlight, or in hot or humid places.
- When the batteries run out, replace both batteries at the same time.

Turning off the wireless controller

The wireless controller can be turned off to prevent inference from other Canon wireless controllers being used nearby.



MENU

(see p. 27)

▶WIRELESS C.·OFF

1. Open either the camera, PLAY (MV10i:VCR) or set up menu, and point the arrow at WIRELESS C.
2. Select the OFF setting and close the menu.
 - C OFF appears in the display.

Turning off the tally lamp

The tally lamp lets you know that the camera is recording. However, its flashing may be reflected into the lens during close-up recording, or when recording through glass.

You may therefore decide to turn it off.

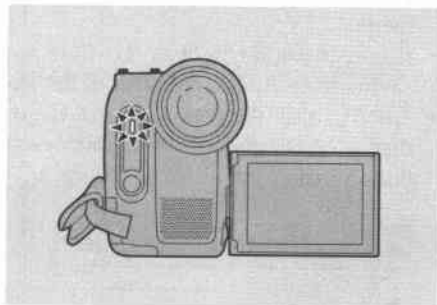

MENU

(see p. 27)

▶TALLY LAMP·OFF

1. Open the camera menu, and point the arrow at TALLY LAMP.
2. Select the OFF setting and close the menu.
 - The tally lamp no longer flashes during recording, but it will still light up when the camera receives a signal from the wireless controller.

Setting the Date and Time

E

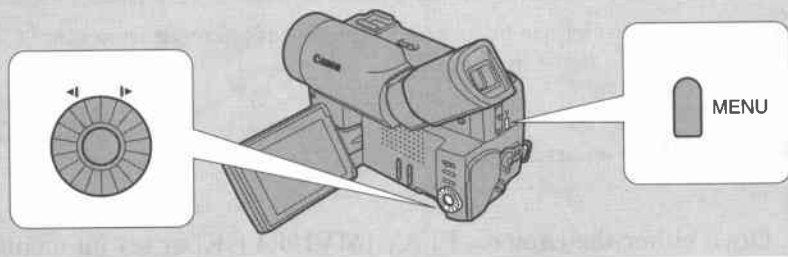

The date and/or time display forms part of the data code. You can choose to display or hide it during playback (see p. 34).

Set the date and time display when you first start using your camera. Install the backup battery before you begin (see p. 75).

- Before you start setting the date and time, select your home time zone from the menu.
- If you are on daylight saving time now, you should set the camera to daylight saving time. You can do this at the same time as selecting your home time zone.
- After you set the date and time, the date/time and home time zone will be displayed for about four seconds each time you turn the power on. Pressing any button makes this display disappear.

Setting the time zone/daylight saving time

 **MENU**
(see p. 27)

▶ T. ZONE / DST .. PARIS

- 1. Set the camera to record pause mode.**
 - PAUSE appears in the display (see p. 11).
- 2. Open the menu and select T. ZONE/DST.**
- 3. Press the execute button.**
 - The time zone display appears on the screen.
 - Your camcorder's time zone is factory-preset to Paris. If you are at another time zone, select your time zone first and daylight saving time (DST) setting if necessary.
- 4. Move up or down the list of time zones by turning the command dial and press the execute button to select the option that represents your time zone.**
 - If you are now in daylight saving time, select the time zone with the daylight saving time mark  next to the area.
- 5. Press the execute button.**
- 6. Press the MENU button.**

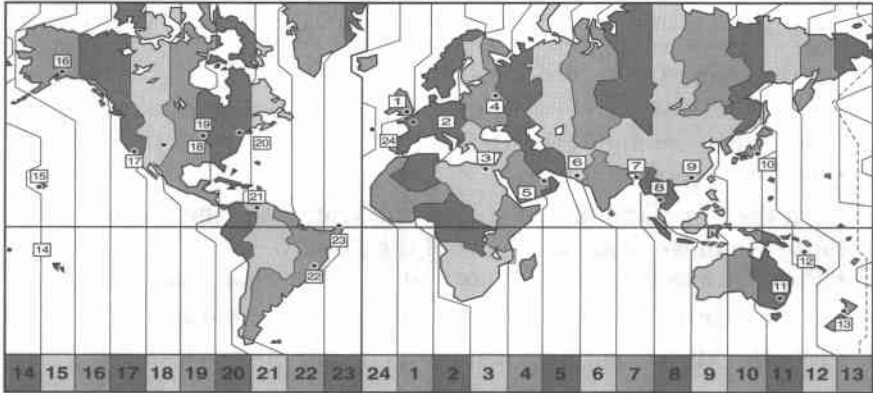

No.	Time zone	No.	Time zone
1	LONDON	13	WELLGTON (Wellington)
2	PARIS	14	SAMOA
3	CAIRO	15	HONOLU (Honolulu)
4	MOSCOW	16	ANCHOR (Anchorage)
5	DUBAI	17	L.A. (Los Angeles)
6	KARACHI	18	DENVER
7	DACCA	19	CHICAGO
8	BANGKOK	20	N.Y. (New York)
9	H. KONG (Hong Kong)	21	CARACAS
10	TOKYO	22	RIO (Rio de Janeiro)
11	SYDNEY	23	FERNAN. (Fernando de Noronha)
12	SOLOMON	24	AZORES

Note:

- After you selected your time zone and set the date and time, when you travel to another time zone, there is no need to reset the data and time. The camera's clock will automatically change to display the correct time for your destination.

Setting the clock

1. **Set the camera to record pause mode.**
 - PAUSE appears in the display (see p. 11).
2. **Open the menu and select D/TIME SET.**
 - The year display starts to flash.
3. **Turn the command dial to change the year. Press the execute button to move to another part of the display.**
 - Once you move from the year, the next part of the display starts flashing.
4. **Set the month, day, hour, and minute in the same way.**
5. **Press the MENU button when finished, and the clock starts.**
 - The date can be set to any year between 1998 and 2020.
 - If you press the MENU button in the middle of setting the date and time the seconds are set to zero, you leave the menu, and the clock starts.
 - If you press the execute button after setting the minutes you can set the date and time again from the start.

Setting the display style



1. **Press down and slide the POWER switch to PLAY (MV10i:VCR).**
2. **Open the PLAY (MV10i:VCR) menu and select D/TIME SEL.**
3. **Choose between DATE, TIME and DATE & TIME.**
4. **Press the MENU button to close the menu.**

Displaying Data Code

A data code, containing the date and time the recording was made and other camera data (shutter speed and exposure settings) is automatically recorded on a special data section of the tape.

During PLAY (MV10i:VCR) mode, the date code can be displayed or hidden while the camera is in play, slow or still mode.

Camera data may be displayed as “— — —” during fast forward, rewind, reverse playback, forward and reverse x2 playback.

Press the wireless controller's DATA CODE button or the camcorder's DIGITAL EFFECTS button.

- Press it once to display the data, press once more to hide it.

You can also choose which type of data code to display — either the date/time, camera data or both.



1. Select **DATA CODE** from the **PLAY (MV10i:VCR)** menu.
2. Choose between **DATE/TIME**, **CAMERA DATA** and **CAM. & D/T**.
3. Press the **MENU** button once more to close the menu.

Notes:

- To avoid accidental recording, make sure that you slide the tab on the cassette so that it exposes the hole (the switch position is usually labelled **SAVE** or **ERASE OFF**).
- The data code will read “— — —” in the following situations:
 - During playback of a blank section of tape.
 - If the tape was recorded before entering the date and time in the camera's memory.
 - If the tape was recorded on a camera without a data code function.
 - If noise or tape damage prevents the data code from being read.
- Data code is not displayed during high speed playback modes.
- If a recording made on MV10/MV10i is played back on a different DV camcorder, the data code may not be displayed correctly.

Taking Still Pictures (Photo Mode)

E

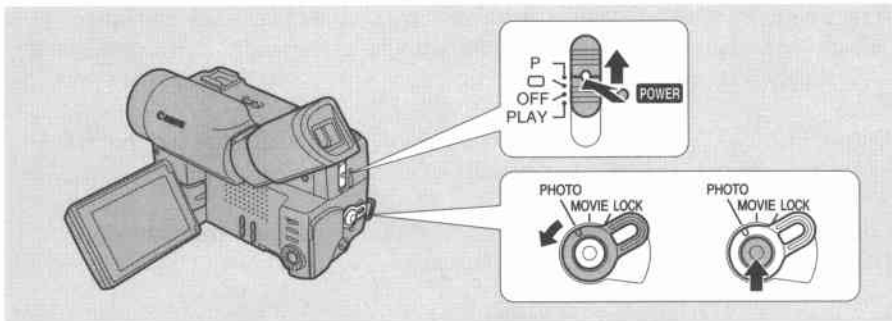

You can record still pictures like a photograph. The camera records the picture to tape for approximately 6 seconds. The exposure is automatically adjusted. You can capture the still images on your computer, enhance or retouch the images and print the images out. (Optional IEEE1394 computer interface board required.)

1. Set the camera to photo standby mode (slide the **POWER** switch to (Easy recording) or **P**, turn the standby lever to **PHOTO**).

- “PHOTO” is shown at the bottom right of the display.

2. Press the start/stop button lightly.

- **●** flashes white in the display as the camcorder adjusts the focus and exposure and it is displayed continuously as a green mark when the camera is ready to take the still picture. (The focus, exposure, and zoom are now locked. Also, you cannot turn the image stabilizer on /off.)
- To change the still picture before recording: release the button, select a new picture and then press down the start/stop button lightly once more.
- If the subject is unsuitable for autofocus (p. 83), the camera may not be in focus, despite displaying the green mark. In this case: release the start/stop button, adjust the focus manually (p. 52) and retry.

3. Press the start/stop button fully down to take the still picture.

- The camera takes the image almost immediately, and then records the “photo” to the tape for approximately 6 seconds. During this time the camera also records the sound, and the display also shows the still picture.
- A counter display is shown, that counts up to 6 secs as the camcorder records the picture. **●** disappears from the display.

Notes:

- While the camera records the still, you cannot use the camera functions (when a cassette is loaded, standby lever/power off do not cut the power until recording is complete).
- You cannot use digital effects while the camera is set to photo mode.
- You cannot use FlexiZone in photo mode. If the FlexiZone mode is already selected, the camera switches to Auto mode automatically.
- For even greater versatility attach a Canon Speedlite for flash photography (available as an optional accessory, see page 49).
- Only take “photos” where it is bright enough to see the image in the display.
- Depending on the subject (fast moving subject, for example), the picture may be blurred.

Searching the Tape (Photo Search/Date Search)

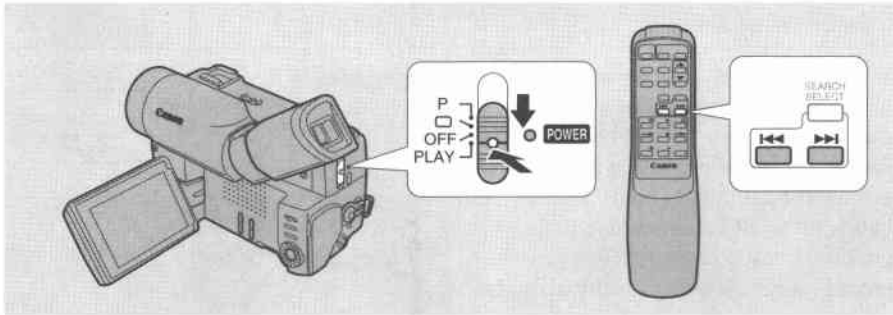

E

This allows you to move quickly through still pictures recorded anywhere on a tape (photo search) or between different days or areas of recording (date search).

• You can only use this function from the wireless controller.

1. Press down and slide the POWER switch to PLAY (MV10i:VCR).

- Press the SEARCH SELECT button to choose between photo/date search.
- PHOTO SEARCH or DATE SEARCH is shown in the display for a few seconds.

2. Press the ◀◀ and ▶▶ buttons to move backwards or forwards through the still pictures or between different days of recording.

- Press once to move to the start of the previous/next still picture or day on the tape.
- You can press more than once to move to the corresponding still picture or day (up to a maximum of 10 times), e.g. press the ▶▶ button 5 times to move forward 5 still pictures or days.
- PHOTO SEARCH/DATE SEARCH appears in the middle of the display alongside the ◀◀ or ▶▶/◀ or ▶ mark and number search through. The recording mode is also shown (SP/LP).

Notes:

- Press the ■ (stop) to end your search.
- If you begin a search very close to the start of a recorded still picture during photo search, the camera may skip straight past it.
- When you have set the area for the World Clock, date search also looks for the change in date based on the adjusted time.
- A date/area cannot be identified if the total recording time on that day/area was less than one minute.
- Date search playback may start just before or after the beginning of the located section.
- If the data code is not displayed correctly you will not be able to operate the date search correctly.

Searching and Reviewing While Recording

E

Record search

When the camera is in record pause mode, you can use record search to play the tape forwards or backwards to find the point where you want to start or restart recording. This is useful when you want to add a new scene to a previously used cassette. By using record search, you can ensure a smooth, noise-free join between the new scene and the old one.

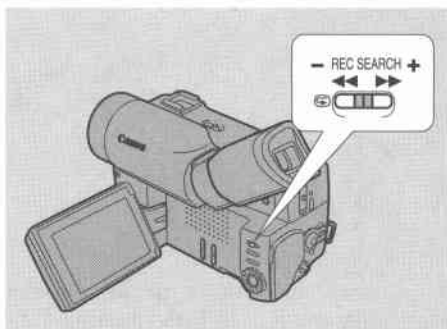

- 1. Make sure the camera is in record pause mode.**
 - PAUSE appears in the display (see p. 11).
- 2. Press and hold the REC SEARCH + or – button while you check the picture in the display.**
 - The + button plays the recording forwards and the – button plays it backwards.
- 3. Release the button when you find the point where you want to start recording.**
 - The camera returns to record pause mode.

Record review

When the camera is in record pause mode, you can use record review to play back the last few seconds of your recording and then return automatically to record pause mode. You can quickly make sure that a scene has recorded properly and then go on to shoot the next scene, without producing any noise in the picture.

- 1. Make sure the camera is in record pause mode.**
- 2. Press and release the  (record review) button while you check the picture in the display.**
 - The camera rewinds the tape, plays back the last few seconds, and returns to record pause mode.

Note:

- Noise (mosaic like noise) may appear on the screen during record search and record review.

Using the Various Recording Programs

E

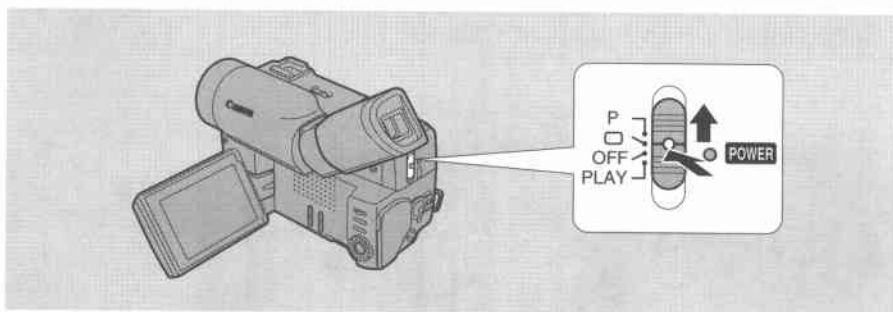

The camera provides you with a choice of eight recording programs. They use different combinations of camera settings in order to adjust the exposure and other functions to match the recording situation.

- For simple point-and-shoot operation, select the Easy Recording program. Slide the POWER switch to the position.
- For normal shooting conditions, set the selector to Auto or FlexiZone.
- For various other recording conditions, the camera has five more specialized AE (auto exposure) programs.

The name of your selected recording program appears constantly on the left of the display, with the exception of the Auto which is displayed and then disappears after 4 seconds.

Notes:

- Avoid changing programs during recording as the brightness of the image may change suddenly.
- The specialized AE programs are not suitable for all kinds of lighting. The image may flicker, or a bright line may appear on the screen if you use them in the wrong lighting conditions.

Selecting from the program menu

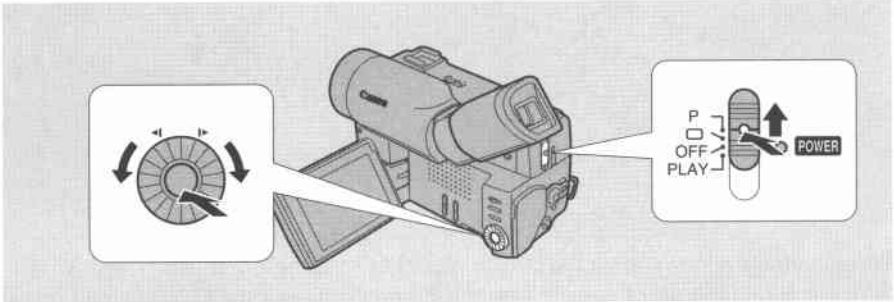

1. Set the camera to record pause mode, with the POWER switch set to the P position.
2. Press the execute button to open the program menu.
3. Turn the command dial to move the arrow up or down the display.
4. Press the execute button.
 - The name of a recording program appear in the display

Note:

- The recording program is reset to AUTO when you turn the camera off using the POWER switch.

Easy Recording

The simplest way to use the camera is with the POWER switch set to the position. The camera will take care of focus, exposure and other adjustments, leaving you free to point and shoot.



If you select this Easy Recording program, you cannot use:

- Exposure lock or compensation
- Different shutter speeds
- White balance set/indoor/outdoor modes
- 16:9 mode
- Digital Effects

Also, autofocus and image stabilization cannot be turned off.

Auto

In normal recording conditions, set the POWER switch to P, and choose AUTO from the program menu. This is the same as the Easy Recording program, except that you now have the option of using any of the camera's manual functions — you can adjust focus and exposure, set the white balance, and so on. You can adjust shutter speeds in the Auto Recording program.



FlexiZone

The FlexiZone is the same as the Auto mode except that you can use FlexiZone AF and FlexiZone AE. You can also adjust shutter speeds in this program.

- You cannot use FlexiZone in photo mode.



Sports

This program is useful for recording high-speed sports scenes in brightly lit conditions. Normal playback will be slightly jerky, but you will get clear images which can be analyzed frame by frame during slow or paused playback.



Portrait

Use this program outdoors to make subjects stand out from a softened foreground and background. It works well for still-lives and close-ups. The effect is most noticeable when the zoom position is between the middle range and the telephoto end. Focus manually for maximum accuracy, and be careful when recording action scenes, as this program may cause fast moving objects to shudder.



Spotlight

This program is designed for recording spotlit scenes, such as on a stage. The exposure is automatically adjusted for glare-free recordings of subjects lit by a concentrated light source.



Sand & Snow

Use this program in places where the background is so bright that the subject appears underexposed in the display — a sunny beach or ski resort, for example. You may notice some shudder when recording moving subjects.



Low Light

This program allows you to record in dimly lit places. It is generally best used for close-ups of slow or stationary subjects, as moving subjects may leave a trailing after-image. However, you can take advantage of this to create special effects, by rapid zooming or by panning along with a moving subject. Picture quality will not be as good as in normal lighting conditions, and autofocus may not work as well as usual. When you take still pictures in LOW LIGHT mode, the Clear Still function will not work.



Using Digital Effects

Fade Trigger

When you start recording, the scene gradually fades in from a black screen. When you stop recording, it gradually fades out.

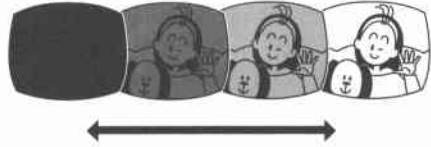

Wipe

When you start recording, the picture begins as a thin vertical line in the center of the screen which gradually expands sideways until it fills the whole of the screen. When you end a scene, the image is wiped from both sides of the screen.

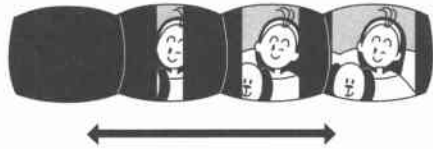

Scroll

When you start recording the picture appears from the right hand side of the screen and expands sideways until it fills the whole screen. When you end a scene, the image is wiped back off.

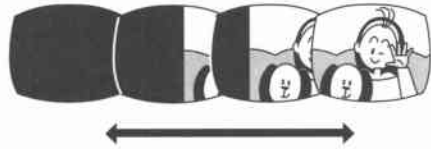

Art

Adds a paint-like effect, called solarization, to the image.

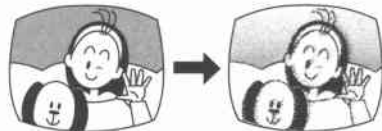

Black and White

Records the image in black and white.

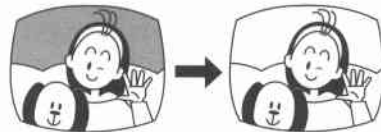
**E**

Sepia

Records a monochrome image with a sepia tint.

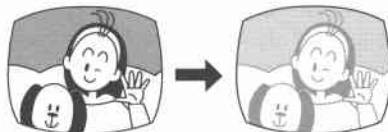

Strobe

This effect converts on-screen action to a series of still images, giving an effect similar to slow-motion.



Selecting the effect

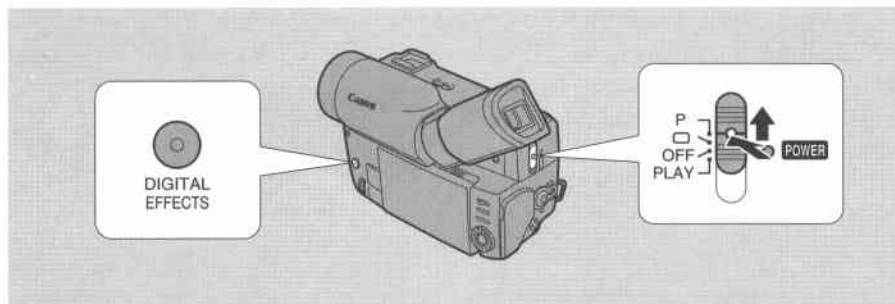

1. Set the camera to record pause mode, with the **POWER** switch set to the **P** position.
2. Press the **DIGITAL EFFECTS** button for more than two seconds to make appear the digital effects menu.
3. By pressing the **DIGITAL EFFECTS** button, choose one of the digital effects from the list.
 - As for the Art, Black and White, Sepia and Strobe effects, when you release the **DIGITAL EFFECTS** button, chosen effect is activated and you can see the effect on the display. Each time you press the **DIGITAL EFFECTS** button, chosen effect is activated or deactivated.
 - To turn the digital effects off completely, choose the **EFFECT OFF** option.

Reactivating the Fade, Scroll and Wipe Effects

You need to activate the fade trigger, scroll and wipe effects each time you wish to use them.

- When you start or stop recording, the scene will begin or end with the effect. (Sound and image fade together).
- The display will start to flash again. If you wish to activate it again, press the DIGITAL EFFECTS button.

Notes:

- You cannot use digital effects when the camera is set to the (Easy Recording) program.
- You cannot use the fade trigger, scroll and wipe effects when the standby lever is set to PHOTO (its name flashes purple in the display).
- When you activate the Fade, Scroll or Wipe effect at the beginning of recording a scene, the camera first clears the screen and then applies the effect.
- The camera remembers your chosen effect until you change it, but when you switch the POWER switch to (Easy Recording) the digital effect is deactivated.

16:9 mode (Widescreen TV recording)

Produces images in the 16:9 format for playback on widescreen TVs.

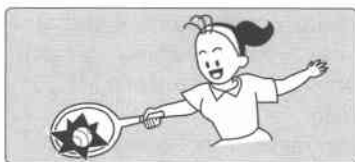

1. Select 16:9 from the camera menu and turn the effect ON/OFF.
2. Press the MENU button once more to close the menu.

Notes:

- “16:9” is shown in the display when you switch the 16:9 effect on.
- You cannot use the 16:9 mode with the Easy Recording program.
- If you play back a recording made for 16:9 on a normal TV screen, the image will appear to be vertically “squashed” (compressed).
- When you take still pictures with the 16:9 effect on, the Clear Still function will not work.

Audio Recording

E

Selecting the audio mode



▶AUDIO MODE..16bit

MV10/MV10i can record sound in two audio modes — 16 bit (48kHz, 2 channel) and 12 bit (32 kHz, 4 channel). The 16 bit mode produces the higher sound quality (slightly superior to CD) while the 12 bit mode records on two channels (stereo 1), leaving two channels free (stereo 2) for you to add new sound at a later date.

1. To switch to the 12 bit mode open the camera menu and select **AUDIO MODE**.
2. Select “12 bit” and close the menu.
 - “12 bit” is shown in the display for approximately 4 seconds.

Notes:

- You cannot add new sound to a tape using this camcorder.
- For details of playing back a tape that has new sound on stereo 2, see page 77.

Headphones and external microphone

Using the Full
Range of Features

For greater creative control over audio recording, you can connect an external microphone to the camera's MIC terminal.

You can monitor the sound while recording by attaching stereo headphones to the camera's  terminal.

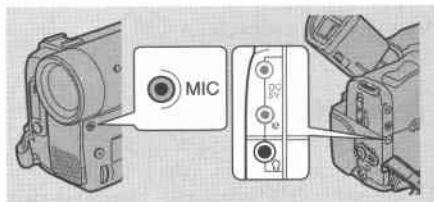

You can adjust the volume of attached headphones by pressing the volume control buttons.

- A **VOLUME** bar appears in the display to indicate the current volume.
- The volume control buttons also adjust the speaker volume once you remove the headphones from the headphones socket when the camera is in **PLAY** (MV10i:VCR) mode.

Wind screen

E



MENU

(see p. 27)

▶WIND SCREEN·AUTO

The camera has an automatic wind screen to prevent wind noise from interfering with the sound track. (It does not operate with an external microphone: WS **OFF** is displayed.) Turn it off when you want the microphone to be as sensitive as possible.

1. **Open the camera menu and point the arrow at WIND SCREEN.**
2. **Select the OFF setting and close the menu.**
 - WS **OFF** is shown in the display.

Setting the Self-Timer

E

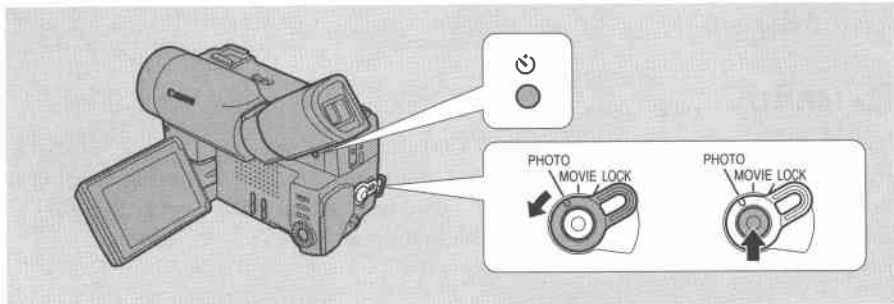

This is useful when you want to include yourself in the picture when recording.

1. Press the self-timer button.

- SELF T. appears in the display.

2. Press the start/stop button.

- The camera starts to record after a 10 second countdown period (or after 2 seconds when you use the remote control). The time remaining counts down in the display (e.g. "5 sec").
- SELF T. disappears from the display when recording begins.

3. Press the start/stop button once more to end recording.

Notes:

- Initially the tally lamp flashes once a second, then just before recording starts it flashes more quickly for a few seconds before the camera starts to record.
- To cancel the self-timer press the self-timer button once more before recording. Once the countdown has begun, press the self-timer button to turn it off.
- Cancel the self-timer at any stage by switching the power off or turning the standby lever to LOCK.
- In photo mode, set the self-timer in exactly the same way. The camera automatically adjusts the focus and exposure 2 seconds before the countdown is complete. The green ● mark is also displayed at this time.

Using a Canon Speedlite for Flash Photography (optional)

For SLR-style flash photography, use a Canon Speedlite 220EX or 380EX with the camera. Use the camera in exactly the same way as you would normally in photo mode (p. 36). Turn on the Speedlite using its main switch, and wait for it to charge. When you press the start/stop button halfway down, the camera sets the autofocus and the zoom is locked. Pressing the start/stop button fully down releases a pre-exposure flash burst that sets the flash intensity, exposure and white balance. The main flash is then emitted.

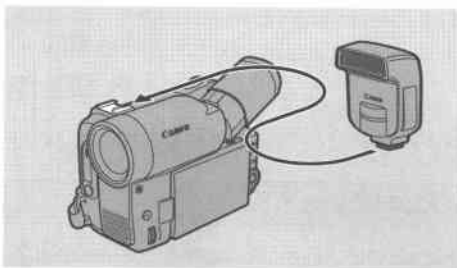

E

- Be sure to turn off the camera and the Speedlite, when you attach the Speedlite.

Flash Charging

While the flash is charging, a white \downarrow flashes in the display.

When the flash is fully charged a green \downarrow lights up constantly in the display.

- Although it is possible to record a still image while the Speedlite is still charging, the flash will not go off. In addition, the Speedlite cannot charge while you are holding the start/stop button halfway down.
- \downarrow disappears from the display while the camera records the still picture.
- If the flashing white \downarrow does not change to green \downarrow , remove and attach the Speedlite again (with both the camera and the Speedlite turned off), or replace the batteries in the Speedlite.

Notes:

- For full details of how to use the Speedlite, refer to its instruction manual.
- If you use the Speedlite in the Auto and FlexiZone mode, you can choose any shutter speed between 1/50 and 1/2000, but a shutter speed of 1/120 gives the best results.
- You cannot use the Speedlite with the:
 - Exposure Lock. (\downarrow goes out if you press the EXP. button. It reappears when you turn the lock off, by pressing the EXP. button once more).
- Turn the Speedlite unit off when you do not require the flash.
- You can use the Speedlite's internal automatic zoom function.
- You cannot use the Speedlite 380EX's bounce flash with MV10/MV10i.

Adjusting Focus Manually

E

The camera can focus automatically. All you have to do is point it, and whatever is in the center of the display will usually be in sharp focus. If it does not seem to be focusing well, it may be because the subject is not suitable for autofocus.

It also has two functions which give you more control over focusing.

FlexiZone AF

FlexiZone AF makes autofocus much more powerful. Using the FlexiZone controller, you can select any object that appears in the display, and the camera will bring it into focus.

FlexiZone AF is useful in the following situations:

When your main subject is not in the center of the display.



When you want to shoot a moving subject.



It also makes it easy to use “focus shift” techniques. You can direct the viewer’s attention by focusing first on one part of the scene, and then on another.



1. Choose the FlexiZone recording program.

- The FlexiZone control frame appears in the display.

2. Use the FlexiZone controller to move the frame over the subject.

- The controller can be moved in any direction. Press it repeatedly to move the frame little by little. Press and hold to move the frame quickly.
- The camera adjust the focus to suit the area inside the frame.

Focus lock

Press the FOCUS wheel to turn off autofocus. The focus remains locked at the point set by autofocus.

(AF OFF appears in the display.) You can now adjust the focus manually. Press the FOCUS wheel again when you want to return to autofocus.

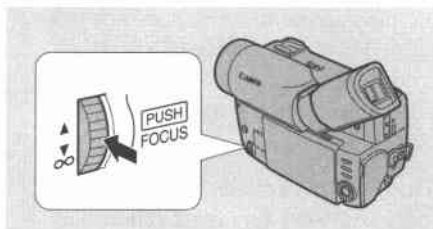

Manual focus

Use the FOCUS wheel to set the focus.

- Turn it downwards (towards ∞) to move the focus further away.
- Turn it upwards to bring the focus nearer.
- If you zoom in on your subject after turning off autofocus, it may not stay in focus. It is generally best to adjust the zoom first, and then the focus.

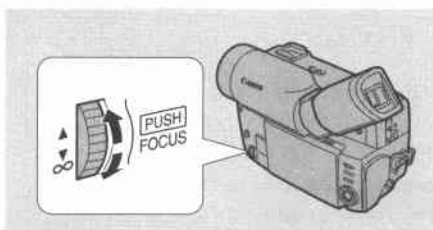

You can also adjust the focus temporarily without turning autofocus off — in this case turn the manual focus wheel to set the focus (without pressing it down) and autofocus will start again as soon as you release the FOCUS wheel.

Notes:

- The manual focus setting is canceled if you:
 - Slide the POWER switch to PLAY (MV10i:VCR) or OFF.
 - Select the (Easy Recording) program.
- When you are using the Easy Recording program, autofocus cannot be turned off, but you can override it temporarily by turning the FOCUS wheel.
- See “Troubleshooting” on p. 82 for a list of subjects which may not be suitable for autofocus.
- You cannot use FlexiZone AF in photo mode.

Adjusting Exposure Manually

E

The camera adjusts the exposure automatically, making sure that your pictures are neither too dark nor too light. There is a choice of eight recording programs to deal with different recording conditions (see p. 40).

This section explains how to use three more exposure functions. These will give you added control over your recordings.

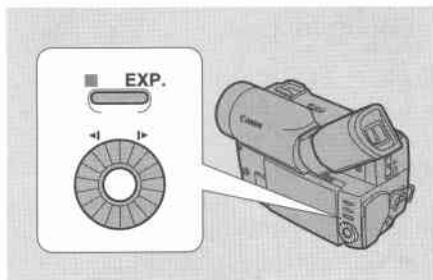

FlexiZone AE

The camera attempts to balance exposure for the whole scene. With FlexiZone AE you can choose which area of the scene to base exposure on, to ensure your subject is properly exposed — whether very dark or bright and wherever it is in the frame.



- 1. Choose the FlexiZone recording program.**
 - The FlexiZone control frame appears in the display.
- 2. Use the FlexiZone controller to move the frame over the subject.**
 - The controller can be moved in any direction.
- 3. Press the EXP. button to lock the exposure.**
 - The camera adjusts the exposure to suit the area that is currently inside the frame. You can move the frame to focus on something else, but the exposure area will not move with it.
 - E. LOCK appears in the display.
- 4. Press the button again when you want to cancel FlexiZone AE.**
 - The exposure is now adjusted to suit the centre of the screen again.
 - Press the button once more if you want to adjust the exposure for the frame's new position.

Exposure lock

When you are recording in situations where the lighting may change suddenly, you can lock the exposure at the current level in order to control the brightness of the image.

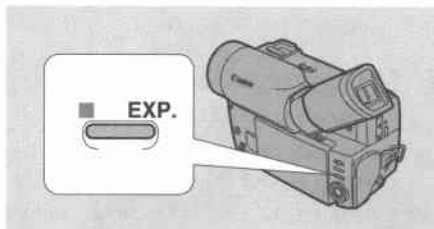

To lock the exposure, press the EXP. button. Press it again to return to the automatically set exposure level.

Exposure adjustment

When the exposure is locked, you can adjust it manually, making the picture brighter or darker in order to deal with difficult lighting conditions, or to manipulate the mood of the scene. The camera's iris can be manually set to any position from fully closed to fully open.

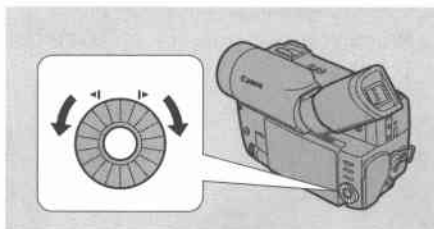

To make the recorded image brighter, turn the command dial clockwise (to a maximum of +11). This may be necessary if the background is very bright, or if the subject is lit from behind.

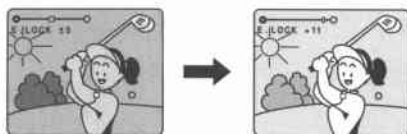

To make the recorded image darker, turn the command dial counter-clockwise (to a maximum of -11). This may be necessary if the background is very dark, or if the subject is spotlighted.



Notes:

- The standard exposure level depends on which recording program you have selected.
- Exposure lock is canceled if you change recording programs.
- You cannot use exposure lock or adjustment when the program selector is set to the (Easy Recording) position.

Shutter speed adjustment

You can increase or decrease the shutter speed before you record a scene.

- 1. Make sure the camera is set to record pause mode, in the Auto or FlexiZone program.**
- 2. Turn the command dial to select the shutter speed.**
 - The selected shutter speed flashes in the display.
 - The indication "1/*" means auto setting.
- 3. Press the execute button.**
 - The shutter speed lights steadily and the camera goes to the shutter speed.



Notes:

- The camera returns to the auto shutter setting when you slide the POWER switch away from the P setting, or change the recording program.
- When you take still pictures with the Speedlite, the maximum shutter speed is 1/2000sec.

Setting the White Balance

The camera's auto white balance system compensates for a wide range of lighting conditions. Although slight variations are unavoidable, colors will appear natural in virtually every situation.

In some cases, you will get better results by setting the white balance yourself, or using one of the two preset modes:

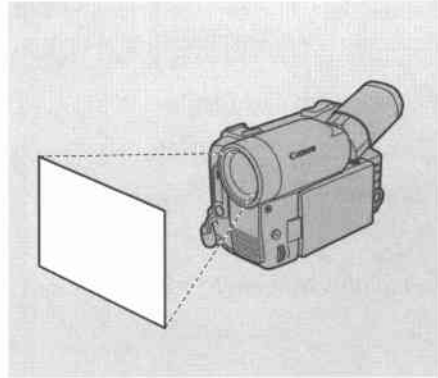

-  Indoor Mode
 - Under halogen or studio/video lighting
 - Subject is of one dominant color
 - Close ups
-  Outdoor mode
 - In daylight, especially for close-ups and where the subject is of one dominant color.



E

 **MENU**
(see p. 27)

▶WHITE BAL...SET

1. **Open the camera menu and point the arrow at WHITE BAL.**
 2. a) **For the indoor, outdoor or auto settings simply choose the setting.**
 -  appears in the display when you set the white balance to indoor/outdoor mode.
 - b) **To set the white balance yourself, point the camera at a white object (such as a sheet of paper) and zoom in until it fills the display, then select SET.**
 - The  display flashes then remains lit.
 - Depending on the light source, the flashing may at times continue. The result will remain better than with the auto setting and you can continue recording.
3. **Close the menu.**

Setting the white balance manually will probably work better than auto white balance when shooting:

Subjects with one dominant color, such as sky, sea or forest.



Close-ups



In rapidly changing lighting conditions



In places lit by certain types of fluorescent or mercury vapor lights.



Notes:

- Turn the digital zoom off (if necessary) to set a more accurate white balance.
- If the lighting conditions change, reset the white balance by first returning to the AUTO setting, and then reselecting SET.
- Try to record with light from a single source. Correct white balance cannot be obtained for two types of lighting at once.
- You cannot set the white balance or choose the indoor/outdoor mode when the program selector is set to the (Easy Recording) program. The camera returns to the AUTO setting when you slide the POWER switch away from the P setting.
- When the standby lever is set to LOCK, the current white balance setting remains in the memory.
- If you shoot with studio/video lighting, use the  (indoor) mode.
- During normal outdoor shooting, setting to AUTO may provide better results.

Returning to a Pre-Marked Position

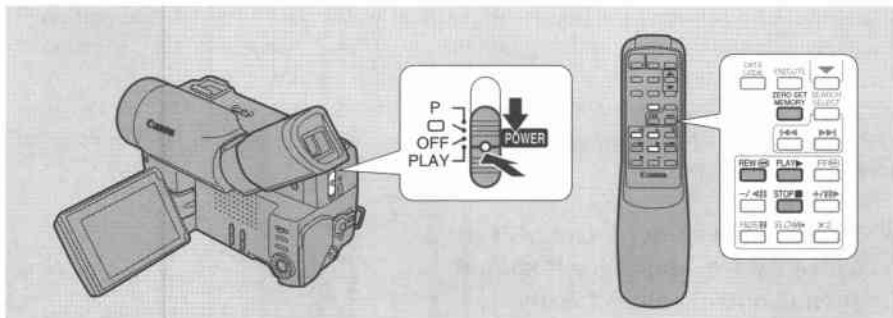

Use the wireless controller to go back to a pre-determined point on a tape following playback.

- 1. Press the ZERO SET MEMORY button during playback at a point you want to return to later.**
 - The time code is replaced by a tape counter that is set to zero with the **M** indication.
- 2. When you have finished playback, fast forward or rewind the tape. The tape stops automatically when it reaches the zero set position.**
 - The tape counter with **M** indication disappears from the display and the time code reappears.

Notes:

- Press the ZERO SET MEMORY button once more to cancel the zero set memory before you forward/rewind the tape.
- The zero set memory may not function correctly where there is a break between recordings on the tape.
- You can also use zero set memory to mark a position on a tape in record pause mode. When you then play back the tape, pressing rewind will take you back to the pre-marked position.
- If you remove the tape while the zero set memory is set, the memory is canceled and the tape counter reverts to timecode.

The Auto Editing Function

E

Using the Auto Editing Function is simple. Just watch your original tape and press the execute button at the beginning and the end of each scene you want to record. This creates an editing program. Start the program, and the camcorder automatically records the scenes you selected onto the tape in your VCR. Before you record, you can preview everything (p. 63), and even delete (p. 67) or re-order scenes (p. 68).

1. Prepare the camera. Connect the video cables, and place it so that it can control your VCR by remote control.
2. Play back the video. When a section of the video you want to keep starts, press the execute button. Press the button again at the end of the section you want to keep. You can choose up to 20 scenes this way.

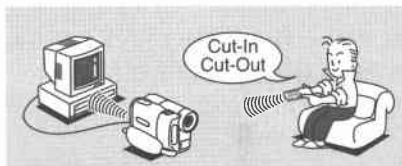

Original tape in Camera

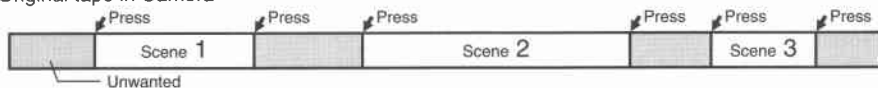

3. If you wish, preview the video. You can also re-order scenes, or even delete them.
4. When everything is perfect, automatically record it to the VCR. Choose START in the menu, then press the execute button.

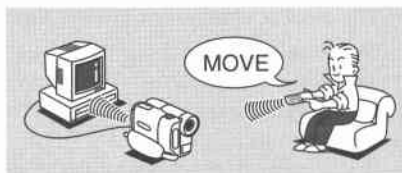

Final tape in VCR



Preparing for Editing

The Auto Editing Function enables you to smoothly rerecord scenes from an original tape in any order. You can then view the entire finished product and make all the fine adjustments you want before the final recording. It is easy to reorder, to make your videos perfect.

- 1. Connect the camera to the VCR.**
 - See the “Connection for playback on a TV” instructions on page 20.
- 2. Turn the TV on.**
 - Be sure to set it to the video channel, or set the TV/Video selector to Video.
- 3. Turn on the VCR and load a blank cassette.**
 - See your VCR instruction manual.
- 4. Open the PLAY (MV10i:VCR) menu and select \rightarrow EDIT MODE.**
 - When you select the edit menu all the displayed informations are also displayed on the screen of the TV connected your VCR. However, these informations will not be recorded onto the tape in the VCR.

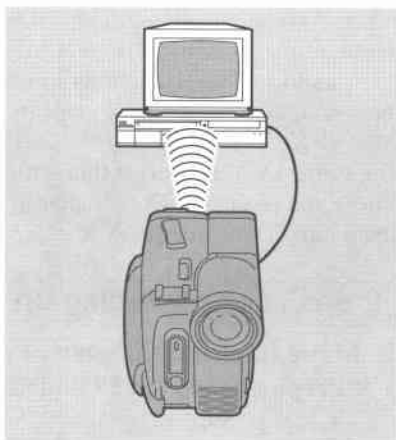

Setting the Camera to Control your VCR

The camcorder's Auto Editing Function controls your VCR by using the same infra-red signals as the VCR's remote control.

Make sure the camera is in a spot where it can remotely control your VCR.

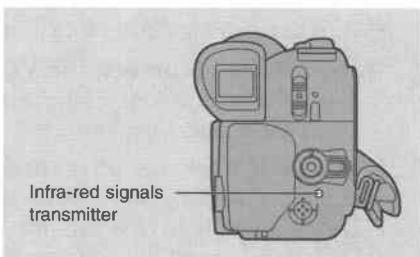

- 1. Check where the remote control sensor is on your VCR using its normal remote control.**
- 2. Place the camera pointing directly at the sensor, not more 50cm (20 inches) away.**
 - Check that the sensor will pick up signals easily from this spot using the VCR's normal remote control.
 - Make sure that the cables and the camera strap do not obstruct the signals.
- 3. Make sure that the VCR is in record-pause mode.**
- 4. Make sure that all the other video equipments are turned off to avoid accidental recording.**

Using the Editing Function for the First Time

E

When you use the editing function for the first time, or with a different VCR, you should set your camcorder to send the correct remote control signals to your VCR.

The camera will not forget this setting unless you change it. Do not alter it again unless you change VCR.

```
SET UP [MENU] RTN
WIRELESS C. . . ON
▶ RECORDER . . . 1-A
CUT-IN ADJ. . . -3:00
CUT-OUT ADJ. . . +1:00
```

Preparations & Setting Up

1. **Make sure that the camera and VCR are set up as in “Preparations,” p. 59 and “Setting the Camera to Control your VCR,” p. 59.**
2. **Open the set up menu and point the arrow to RECORDER .**
 - It is easiest to view the menu on the TV screen.

Setting RECORDER

Use the chart on p. 61 to find the RECORDER settings for your brand of VCR. Make sure the camcorder's infra-red control signals can reach the VCR, and the VCR is in record pause mode. (Ready to record and on pause.)

1. **Set RECORDER to the first setting for your brand of VCR.**
 - For example, 7-A if you have a JVC VCR.
 - Turn the command dial clockwise to change the setting.
2. **If the setting is correct, the VCR will start recording automatically.**
 - This will occur as long as the camera is pointing at the VCR's remote sensor while you change the setting.
3. **If the VCR does not start recording, try the next setting.**
 - Turn the command dial (to 7-B in the above example).
 - Try each setting in turn until the VCR starts to record.
 - During this operation, you cannot operate the wireless controller.
4. **Once the VCR starts to record, check that the setting is right. Set the VCR to record-pause again, then press the camera's start/stop button.**
 - The VCR should start to record for a few seconds, and REC appears in the display and on the TV screen. Then it will automatically pause and PAUSE appears in the display and on screen.
 - During these REC, PAUSE operations, the VCR records digital timer, which you will use later for Cut-In and Cut-Out Adjustments. For more accurate adjustments, we recommend you to repeat pressing the start/stop button to record couple of times.
 - If not, then the setting is still not right. Try the next setting.

RECORDER

The camera's Auto Editing Function can remotely control almost all brands and models of VCR. VCR remote control signals vary depending on model and brand. First, choose the right RECORDER setting for your VCR. The number indicates the VCR brand. The letter indicates the set of signals.

Brand	Settings	Brand	Settings	Brand	Settings
Canon	1-A to 1-B	Pioneer	11	Thomson	18-A to 18-C
Aiwa	2-A to 2-C	Sanyo	12-A to 12-C	Saba	
Akai	3-A to 3-C	Fisher			
Fujitsu	4	Sharp	13-A to 13-C	Ferguson	19-A to 19-C
Funai	5	Sony	14-A to 14-F	Grundig	20-A to 20-C
Hitachi	6-A to 6-B	Toshiba	15-A to 15-B	Nokia	21-A to 21-C
JVC	7-A to 7-C	GE	16-A to 16-B	Telefunken	22-A to 22-B
Mitsubishi	8-A to 8-D	RCA			Zenith
NEC	9-A to 9-D	Magnavox	17-A to 17-B	Samsung	24-A to 24-B
Panasonic	10-A to 10-G	Philips	18-A to 18-C	GoldStar	25
Blaupunkt		Seleco			
Quasar			Rex		

as of Aug 1998

Notes:

- If your brand of VCR is not on the chart, or you cannot find the correct setting, try all the numbers by pressing the execute button until the VCR starts to record.
- Once you find the correct setting, remember this and do not change it unless you change VCR.
- See p. 65 for details of the “cut-in” and “cut-out” adjustments.
- If you try all the numbers and letters, but the VCR has still not started to record:
 - Check the VCR is ready to record, and on pause.
 - Check the VCR can receive signals from where the camera is, and that nothing is blocking the signals.
 - Go back and try to set it again.
 - It is unlikely, but you may have a VCR the Auto Editing Function cannot control. If so use the Simple Editing method on p. 69.

Choosing a Scene (SET Function)

E

You can put a scene into the editing program by pressing the execute button at the point where you want the scene to start and at the point where you want it to end. (The “cut-in” and the “cut-out” points.)

Instead of using the controls on the camcorder body, you can use the wireless controller. The ▼ button corresponds to turning the command dial clockwise and the ▲ button to turning it counter-clockwise.

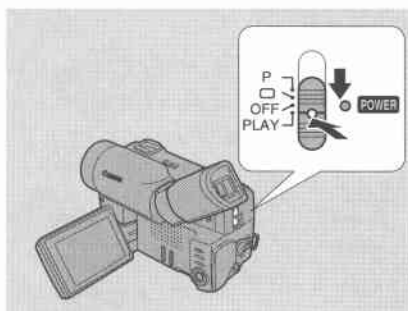

1. Make sure you are opening the edit menu.
2. Choose SET from the edit menu.
3. Start the tape with the “PLAY” button: ►.
 - You can use the ►, ◀◀, ▶▶, ||, and ■ buttons or special playbacks in the same way as in playback mode.
4. At the start of a scene you want to record, press the execute button.
5. Press it again at the end of the scene.
 - The beginning and end of the scene according to the counter (the “cut-in” and “cut-out” points) are displayed on the display.
 - The programmed number becomes “highlighted”.
 - The camera will not let you put in a “cut-in” point later than its “cut-out” point, nor a “cut-out” point earlier than its “cut-in” point.
 - You will not be able to make scenes shorter than about two seconds in length.
 - You can program only when the counter displays ---:---:---
6. You can program the Auto Editing Function to remember up to twenty different scenes in the same way.

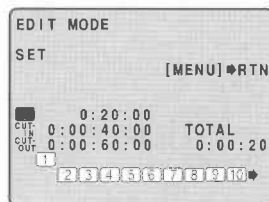

Notes:

- TOTAL at the lower right corner of the screen tells you the total running time of all the scenes you have selected.
- For best results, when editing from the start of the tape, let the tape run for about 20 seconds according to the counter. Set the first cut-in point after that. Also, avoid setting the last cut-out point in the last three minutes of the tape.
- When you only programmed cut-in, editing will continue tape end and then, the camera and VCR stops automatically.
- Editing a tape recorded in both SP and LP modes may be less accurate.
- Avoid setting the cut-in/cut-out point before the non-recorded portion.
- Avoid making the program leaving non-recorded portion between the cuts.
- When editing the still picture part (recorded in Photo mode), with the tape edited that cut-in point is set at just the photo search starting point, the photo search may malfunction.

Preview and recording

E

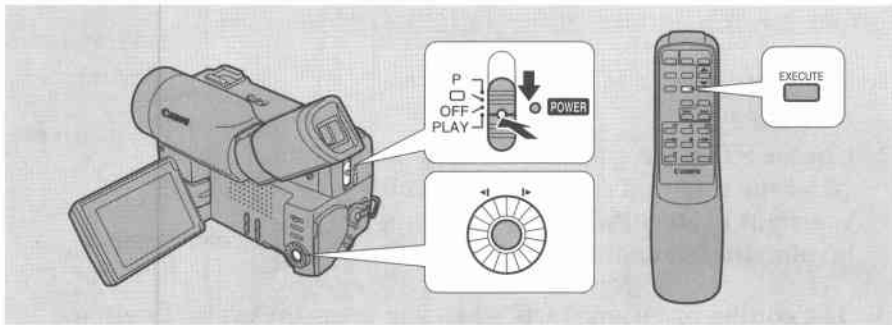

Preview function

You can preview the editing program. The PREVIEW function plays the whole program, automatically pausing at the “cut-in” and “cut-out” of each scene to help editing.

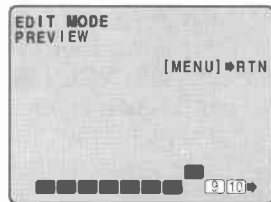

1. Choose the PREVIEW from the edit menu and select the program number from which the preview starts by turning the command dial.

2. Press the execute button.

- The camera will now play all the scenes from the program number you selected in the order you have programmed them.
- In PREVIEW mode the tape starts a little before each “cut-in” point. It will pause for 2 seconds precisely at the “cut-in” point. It pauses again at the “cut-out” point.
- The program number being previewed is moved up one line.
- When you want to stop the PREVIEW function, press the ■ (stop) button.

Running the editing program (START function)

1. Make sure the VCR is ready to record and on pause.
2. Choose START from the edit menu and select the program number from which you want to start the editing program by turning the command dial.

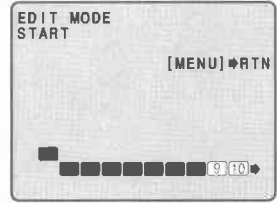

3. The editing program starts when you press the execute button.
 - The camera automatically records the scenes you selected onto the tape in the VCR.
 - The Auto Editing Function carries out some operations, such as frame advance at the cut-in/cut-out points, to ensure editing accuracy.
 - When you want to stop editing, press the ■ (stop) button. For the VCR, press the VCR's ■ (stop) button.
 - If the Auto Editing Function does not work well, start again from "Choosing a scene".

Cut-In and Cut-Out Adjustments

Setting the Cut-In and Cut-Out Adjustments

E

The point where a scene starts is called the “cut-in” point, and the point where it ends is called the “cut-out” point.

Some VCR models take a second or more to actually start recording after they receive the command signal. If this happens you could lose the beginning of the scene. CUT-IN ADJ. prevents this by sending the command a little early.

Similarly, some models take some time to react to the command to stop recording. Some models also rewind slightly after they stop. You could therefore record more than you wanted, or lose the end of the scene. CUT-OUT ADJ. prevents this, by sending the command a little early or late.

If you have these problems with your VCR, reset these adjustments.

Use the set up menu to set the “cut-in” and “cut-out” adjustments.



(see p. 28)

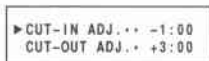

1. Open the set up menu and point the arrow at CUT-IN ADJ.

- Point it at “CUT-OUT ADJ.” to set the cut out adjustment.

2. Adjust the setting.

- CUT-IN ADJ. can be set up to 5 seconds early. (–5:00)
- CUT-OUT ADJ. can be set from one second early to five seconds late. (–1:00 to +5:00)
- This can be set to an accuracy of one frame.

How to calculate the best adjustment for the “cut-in” and “cut-out” points

The tape you recorded the digital timer in “Setting RECORDER” is used for calculating the adjustment value.

1. Rewind the tape and play back the recorded digital timer.

- Look at the time the CUT-OUT timer stops and CUT-IN timer starts. These times are what the CUT-OUT ADJ. and CUT-IN ADJ. settings should be.
- For maximum accuracy, take an average of at least three readings.
- If your VCR has a frame advance function or a jog dial, you can use it to find the precise starting times more conveniently.

2. Set the CUT-OUT ADJ. and CUT-IN ADJ. settings to the center of the three readings.

Note:

- The camcorder will remember the cut-in and cut-out adjustment settings until you change them.

Deleting scenes and clearing the program

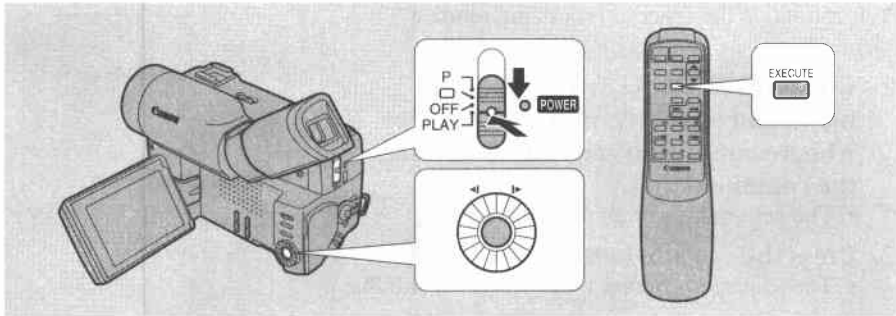

E

Clearing the whole display (CLEAR ALL function)

This deletes the whole program.

1. Choose the **CLEAR ALL** from the edit menu.
2. Press the execute button.
 - All the program number indications will return to normal. All data is deleted.
 - Please do not do this by mistake, or you will have to start again from the beginning.

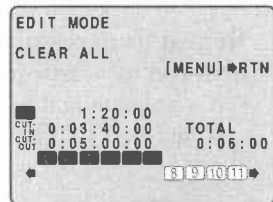

Deleting a scene (DELETE function)

You can delete a scene from the program.

1. Choose the **DELETE** from the edit menu and select the program number you want to delete by turning the command dial.
2. Press the execute button.
 - The scene is deleted and that program number indication will return to normal.
 - You can insert a new scene here if you wish, using the SET function as described in "Choosing a scene" on p. 62.
 - If this program number is left unprogrammed, the editing function stops at this point (the VCR also stops automatically).

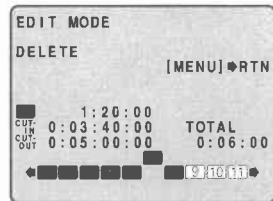

Editing

Reordering Scenes

E

You can move the scenes around and reorder them.

- 1. Choose RELOCATE from the edit menu and select the program number which you want to relocate by turning the command dial.**
 - The selected program number flashes.
- 2. Press the execute button.**
 - The selected program number moves one line up.
- 3. Turn the command dial to select the new position.**
- 4. Press the execute button.**
 - The program is relocated at the point.
- 5. Repeat as necessary with the other scenes until the program is ordered as you want it.**
 - If a program number is left unprogrammed, the editing function stops at that point (the VCR also stops automatically).

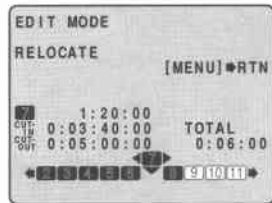

Simple Editing to a VCR

If you cannot find the appropriate remote control setting for the camcorder to control your VCR, you still can edit a tape to the VCR as follows.

E

Preparations

- 1. Connect the camera to the VCR.**
 - See “Playback Connection” on p. 20.
- 2. Prepare the TV and VCR.**
 - Turn on the TV and set it to the video channel, or set the TV/VIDEO selector to VIDEO.
 - Turn on the VCR, and set its input selector to LINE. Load a blank cassette, and put the VCR in record pause mode.
 - See your TV and VCR instruction manuals for details.
- 3. Slide the camera’s POWER switch to PLAY (MV10i:VCR), and load your recorded cassette.**

Basic editing

- 1. Find a point on your recorded cassette slightly ahead of the section you want to copy.**
- 2. Start to play it back while you monitor the picture on the TV.**
- 3. Start recording on the VCR as soon as the section you want to copy appears on the screen.**
- 4. Pause the VCR at the end of the section you want to copy, then stop playback on the camera.**
- 5. Repeat steps 1 to 4 until your edited recording is complete.**

Note:

- The quality of the edited tape will be slightly lower than that of the original.

REMOTE terminal

The REMOTE terminal allows you to connect the camera to equipment. Some buttons on editing equipment may operate differently from those on the camera.

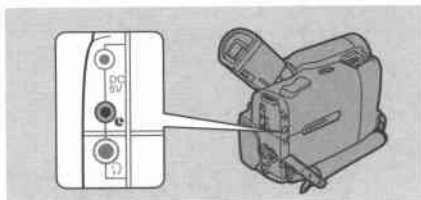

Notes:

- (L) (LANC) is a trademark. It stands for Local Application Control Bus System.
- We cannot guarantee the results when connecting to equipment not bearing the LANC (L) symbol.

MV10

E

DV terminal/connections

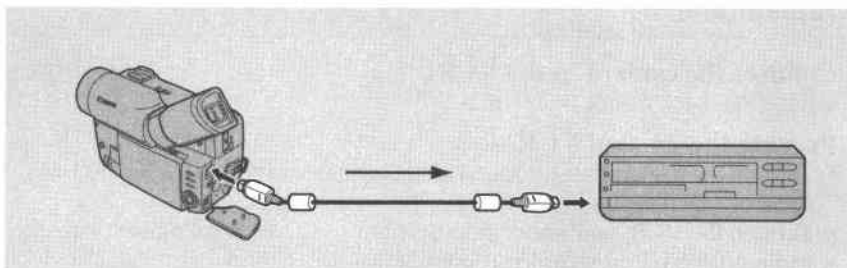

Digital video equipment fitted with this terminal lets you edit, copy and transfer data digitally, with imperceptible loss in image and sound quality.

Use a Canon CV-150F DV cable to connect two digital devices together. When you are recording, make sure you connect the cable to the MV10 before connecting the other end of the cable to the recording device.

- When operating the camcorder with the DV cable connected (between MV10 and another device) do not turn the camcorder off.

MV10i

The MV10i is equipped with the DV Recording function. The MV10i is only available in certain areas.

DV terminal/connections

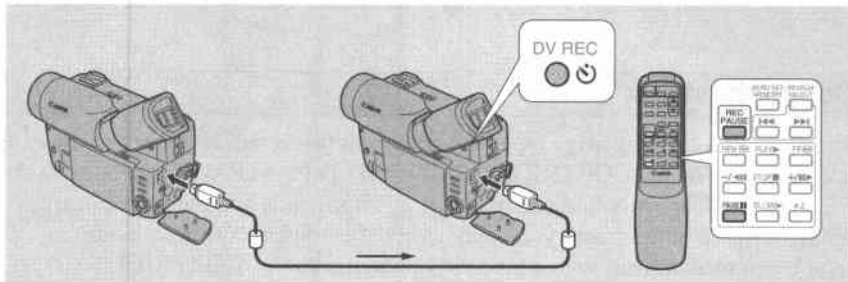

Digital video equipment fitted with this terminal lets you edit, copy and transfer data digitally, with imperceptible loss in image and sound quality. The DV terminal is for both line-in and line-out, since a single DV cable can handle data in both directions.

- If the Canon digital video camcorder is connected, the Auto Editing Function can be used for digital-to-digital editing (i.e. with imperceptible loss in image editing).

Use a Canon CV-150F DV cable to connect two digital devices together. When you are recording, make sure you connect the cable to the MV10i before connecting the other end of the cable to the recording device. When you are recording to the MV10i, slide the POWER switch to VCR and press the DV REC button on the MV10i or the wireless controller's REC PAUSE button ("DV IN" appears in the display when you press "play" on the playback device). Then press its pause button to start/pause recording. If the cables are not connected properly, the camera displays the caution "CHECK THE DV INPUT".

- The image displayed by the camcorder that is being recorded to (for example on its LCD screen, an attached TV, or in its viewfinder) may become distorted during digital dubbing. The actual recording on the tape, however, is not affected.
- If you press the DV REC button with the DV cable unconnected, the camera displays the caution "CHECK THE DV INPUT". An anomalous image may also flash onto the screen.
- Blanks between recordings on the playback tape are recorded as anomalous images on the tape that is being recorded to.
- Do not turn the power off when operating either camcorder with the DV cable connected.

DK-1 DV Capture kit

With the optional DK-1 kit, you can download high quality beautiful still pictures for making cards, calendars, a digital photo album, use on internet home pages, and so on. For full details of how to use the DK-1 DV Capture Kit, refer the DK-1's and computer's instruction manual.

Copyright signal

Certain pre-recorded software tapes are copyright protected. If you try to play back such a cassette, "COPYRIGHT PROTECTED PLAYBACK IS RESTRICTED" appears in the display for a few seconds and then the camera displays a blank blue screen; you cannot view the contents of the cassette. If you try to record from such a tape via the digital cable "COPYRIGHT PROTECTED DUBBING RESTRICTED" appears in the display; you cannot record the contents of the tape.

Preparing the Camera

Adjust the viewfinder

- In record pause mode, turn the viewfinder focusing wheel (focusing the display) to suit your eyesight.
- The viewfinder rotates to give a choice of shooting positions.
- When you use the viewfinder, pull the viewfinder out straight until it stops and then rotate it.

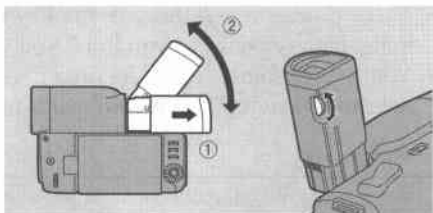

Prepare the lens cap

- Attach the cord to the lens cap, and pass the grip belt through the loop on the cord.
- Hook the lens cap on to the grip belt while you are recording, and place it over the lens when you have finished.

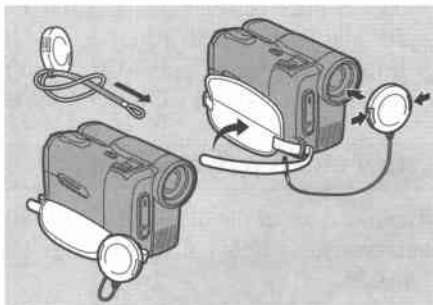

Fasten the grip belt

- Release the Velcro fastening and hold the camera with your right hand while you adjust the belt with your left.



Attach the shoulder strap

- For extra security and portability, attach the shoulder strap before using the camera.
- Pass the ends through the attachment bars and adjust the length as shown.

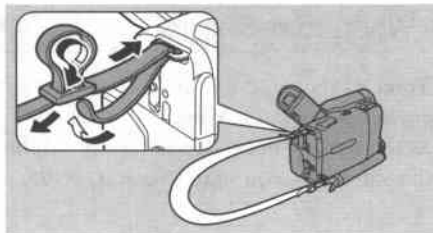

Note:

- Be careful not to leave the viewfinder exposed to bright sunlight, or it will melt. (The light is concentrated by the viewfinder lens.)

Notes on Using the Batteries

E

Charging and recording times

- These times vary — the safest policy is always to have two or three times as many battery packs as you think you will need.
- You will get more recording time if you turn the camera off between shots, instead of leaving it in record pause mode.

Battery pack	BP-915
Time needed for full recharge	2 hr. 40 mins
Maximum recording time	Using the viewfinder: 1 hr. 35 mins Using the LCD screen: 1 hr. 20 mins

- Recording time will be shorter than usual at low temperatures. You can use the battery pack between 32° and 104°F (0° to 40°C), but it works best between 50° and 86°F (10° to 30°C).
- If the battery pack starts to give you much less recording time than usual, it has reached the end of its life and must be replaced.

How much power is left?

The indicator in the display shows you approximately how much charge the battery pack has left:

Notes:

- “CHANGE THE BATTERY PACK ” appears in the display for 4 seconds when the power is completely exhausted. The empty battery mark then appears and starts to flash. The power indicator light also flashes.
- The indicator is not constant — different levels will be shown when you subject the battery pack and camcorder to different conditions.

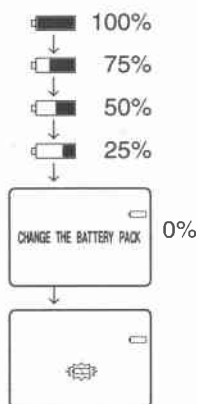

When to recharge

You can recharge a lithium ion battery pack whenever it is convenient. Unlike a conventional battery pack, it does not have to be fully discharged first. However, as the battery pack will naturally discharge itself over time, it is best to charge it the same day you plan to use it, or the day before.

Taking care of the battery pack

Always attach the terminal cover.

- Do not allow any metal objects to touch the terminals, as this can cause a short circuit and damage the battery pack. Attach the terminal cover whenever the battery pack is not being used.

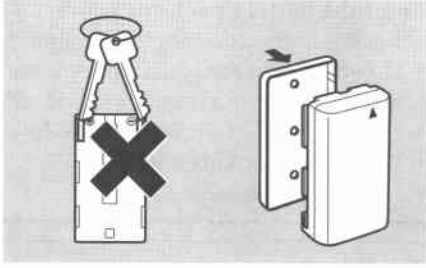

Keep the terminals clean.

- The camera, adapter or battery pack will not work properly if the terminals are dirty. Check them before use, and wipe them with a dry cloth or tissue if necessary.

Storing the battery pack

- If you do not use a battery pack for a period of more than a few months any remaining charge may cause damage to the battery pack, and reduce usage time. To prevent damage therefore, aim to use a battery pack's complete charge before storage.

Installing the backup battery

Pull out the battery holder from the base of the camera, and insert the CR2025 lithium battery with the + side facing upwards. Click the holder back into place.

- You may find it useful to use a small screwdriver to ease out the battery holder.

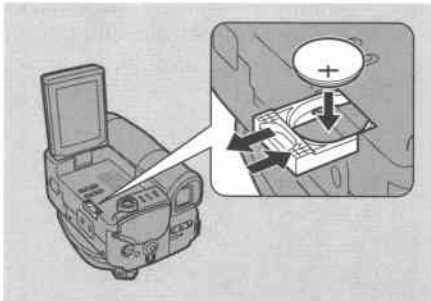

This backup battery allows the camera to remember the date and time and other settings when the main power source is removed. It has a life span of about a year.

When it needs replacing (or if it has not been installed), the  mark flashes in the display. Remove the old battery by pushing it down and pulling it out from the left side. Make sure to attach a power source to the camera first, and turn it off using the standby lever. This way it will remember your chosen settings when you change the battery.

DANGER!**Treat the battery pack with care.**

- Keep it away from fire (or it might explode).
- Do not expose the battery pack to temperatures greater than 60°C (140°F). Do not leave it near a heater, or inside a car in hot weather, for example.
- Do not try to disassemble or modify it.
- Do not drop or knock it.
- Do not get it wet.

WARNING!

- The battery used in this device may present a fire or chemical burn hazard if mistreated. Do not recharge, disassemble, heat above 100°C (212°F) or incinerate.
- Replace the battery with a Sony, Sanyo or Panasonic CR2025, or Duracell DL2025. Use of another battery may present a risk of fire or explosion.
- The used battery should be handed back to the supplier for safe disposal.

Cautions:

- Do not pick up the battery using tweezers or other metal tools — this will cause a short circuit.
- Wipe the battery with a clean, dry cloth to ensure proper contact.
- Keep the battery pack out of reach of children — if it is swallowed, contact a physician immediately, as the battery case may break down and the battery fluids damage the stomach and intestines.
- Do not disassemble, heat, or immerse the battery in water, to avoid the risk of explosion.

Setting the Audio Mix

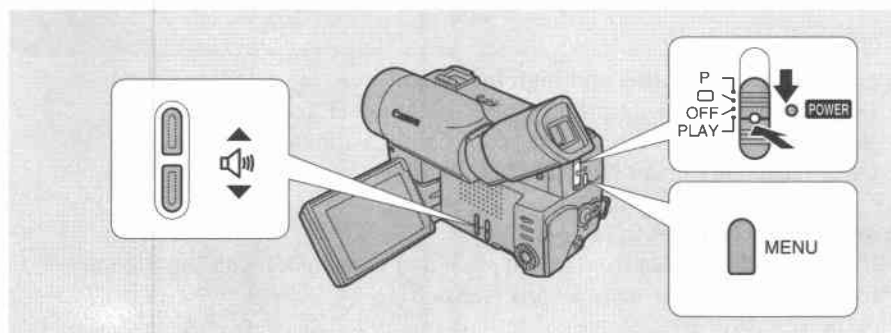

E

When you play back a tape that was recorded in 12 bit mode, you can set the audio output: stereo 1 (the original sound), stereo 2 (any new sound, dubbed to the tape after recording), or a mixture of the two.

- Audio from the 16 bit mode only contains stereo 1 sound and so you cannot/do not need to select the audio mix. The same is true for the 12 bit stereo 1 mode, unless new sound has been added post-recording.

MENU
(see p. 27)

▶ A.MONITOR...MIX/VARI.

1. Set the camera to **PLAY (MV10i:VCR) mode.**

2. Choose the output.

- Open the **PLAY (MV10i:VCR)** menu and point the arrow at **A.MONITOR**.
- Select the output and return to the main menu:
 - **STEREO1** for just stereo 1.
 - **STEREO2** for just stereo 2.
 - **MIX/FIXED** when you want an equal mix of stereo 1 and 2.
 - **MIX/VARI.** when you wish to mix the balance between stereo 1 and 2.

3. Mix the balance.

- If you chose **MIX/VARI.** (above) you can now select the mix balance option from the menu and adjust the mix between stereo 1 and 2. A bar showing the mix appears on the screen as a guide.

Note:

- When you have chosen the output, **FIXED** or **VARIABLE** is shown in the top left of the display for a few seconds. If you turn the power off the output (and display) is set to “**STEREO1**”.

Maintenance

E

Cautions

Avoid high temperatures and high humidity.

- Do not leave the camera inside a car in hot weather, for example.
- Be careful of heat radiating from video lighting equipment.
- Do not take the camera into a humid room.

Avoid sudden changes in temperature.

- If you take the camera from a cold place to a warm place, condensation may form on the lens and internal parts (see p. 81).

Do not point the lens or viewfinder at strong light sources.

- Never point it at the sun, and do not leave it aimed at a bright subject.
- Be especially careful when leaving the camera on a tripod.

Avoid magnetic or electric fields.

- Do not use the camera close to TV transmitters, portable communication devices or other sources of electric or magnetic radiation. They may cause picture interference, or permanently damage the camera.

Do not expose the camera to water.

- Cover the camera when you are recording in rain or mist.
- There is a risk of electric shock if water gets inside the camera — contact qualified service personnel as soon as possible.

Protect the lens.

- Sand and dust can damage the lens — be especially careful on windy days.

Handle the camera gently.

- Vibration or shock can cause damage.
- Do not use the viewfinder or LCD screen as a carrying handle.

Do not disassemble the camera.

- This is very dangerous as there is a risk of electric shock — if the camera does not function properly, take it to qualified service personnel.

Storage

If you do not intend to use the camera for some time, store it in an area which is free of dust and moisture, and where the temperature is no higher than 30°C (86°F). After storage, check each part and function of your camera to make sure everything is still working properly.

Note:

- These cautions also apply to accessories such as battery packs and cassettes.

Maintenance

LCD screen brightness

- Adjust the brightness of the display if necessary.
- Pressing the ▲ button makes the display lighter, and pressing the ▼ button makes it darker.

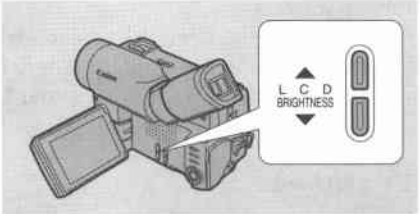

Viewfinder

- Clean the viewfinder screen using a blower brush. First, pull the viewfinder out until it stops. Then, press and hold the release switch and pull the viewfinder all the way out. To reattach the viewfinder, first position the base horizontally and align it with the viewfinder's base. Then press it until it clicks back into place.

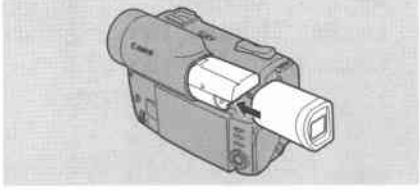

LCD

- Clean the LCD screen using a commercially available glass cleaner.
- Where there is a big change in temperature, moisture may form on the surface of the screen. Wipe clean with a soft, dry cloth.
- At low temperatures the display may appear to be much darker than usual. This is not a fault, and as the screen warms up the display will return to normal.

Camera body and lens

- Use a soft, dry cloth to clean the camera body or lens. Never use chemically treated cloth or volatile solvents such as paint thinner.

Video heads

- When mosaic-like noise appears on the playback picture, the video heads may be dirty. When the video heads are badly contaminated, the camera may show a blank blue screen.
- Clean the video heads using Canon's DVM-CL Digital Video Head Cleaning Cassette. If the "noise" remains, repeat the cleaning (up to maximum of five times).
- Do not use a wet-type cleaning cassette, as this can cause damage.



Using the camera abroad

Power sources

- You can use the compact power adapter to operate your camera and charge battery packs in any country where the electricity supply is between 100 and 240 V AC, 50/60 Hz. Contact your Canon dealer for information about plug adapters for overseas use.

TV playback

- Although you can always play back your recordings on the LCD screen, your camera can only be connected to TVs which use its PAL system. This TV system is used in the following countries:
Algeria, Australia, Austria, Bangladesh, Belgium, Brunei, China, Denmark, Finland, Germany, HongKong, Iceland, India, Indonesia, Ireland, Italy, Jordan, Kenya, Kuwait, Liberia, Malaysia, Malta, Mozambique, the Netherlands, New Zealand, North Korea, Norway, Oman, Pakistan, Portugal, Qatar, Sierra Leone, Singapore, South Africa, Spain, Sri Lanka, Swaziland, Sweden, Switzerland, Tanzania, Thailand, Turkey, Uganda, United Arab Emirates, United Kingdom, Yemen, former Yugoslavia, Zambia.

Condensation

E

Condensation may form on the camera when it is moved from a cold place to a warm place. Using the camera while condensation is present can damage both the tape and the camera.

Condensation may become a problem:

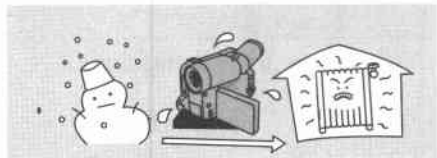

When you bring the camera from a cold place to a warm room

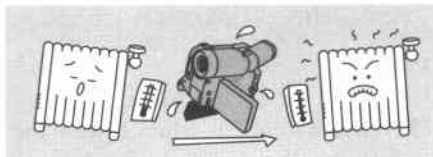

When a cold room is heated rapidly



When the camera is left in a humid room

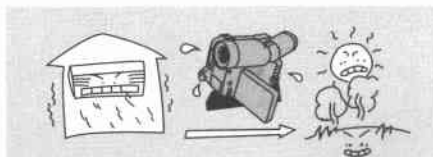



When the camera is taken from an air-conditioned room to a warm, humid place

Protecting the camera from condensation

- Before you bring the camera to a warm or humid place where condensation is likely to be a problem, unload the cassette and put the camera in a plastic bag. Wait until the camera reaches room temperature before you take it out of the bag.

What happens when condensation is detected

- “CONDENSATION HAS BEEN DETECTED” is displayed for approximately 4 seconds. Then, the power indicator flashes and the  mark flashes in the display. If there is a cassette in the camera, it stops automatically and “REMOVE THE CASSETTE” is displayed for approximately 4 seconds and then  flashes in the display.
- The camera may not detect the condensation immediately — the condensation warning may not start flashing for 10 to 15 minutes.
- You cannot load a cassette when condensation is detected.

What you should do

- Remove the cassette, leave the cassette compartment open, and turn the camera off.
- Leave it in a dry place until the condensation evaporates. After the condensation warning stops flashing, wait at least another hour before trying to use the camera.

Troubleshooting

E

Refer to this checklist first if you have any problems with your camcorder. Possible explanations are given for each problem on the list — turn to the page numbers in brackets for more information.

Make sure that the camera is properly connected if you are using it with a TV or VCR. Consult your dealer or service outlet if problems persist.

Recording/Playback

Problem

Cause and/or what to do about it

- | | |
|---|--|
| <p>? Nothing happens when I press the buttons</p> | <ul style="list-style-type: none">• The camera is not switched on (p. 11, 17).• The cassette is not loaded or is set for erasure prevention (p. 9-10).• The tape has reached the end.• The battery pack is exhausted or not properly attached (p. 7, 8, 74).• The function cannot be used in that recording program (p. 39). |
| <p>? The camera turned itself off.</p> | <ul style="list-style-type: none">• The camera was in record pause mode for more than about five minutes (p. 11).• The battery pack is exhausted (p. 8). |
| <p>? The start/stop button doesn't work.</p> | <ul style="list-style-type: none">• The POWER switch is not set to CAMERA (p. 11).• The standby lever is set to LOCK (p. 11).• The cassette is not loaded or is set for erasure prevention (p. 9-10).• The tape has reached the end. |
| <p>? There's no picture in the display.</p> | <ul style="list-style-type: none">• The POWER switch is not set to CAMERA (p. 11).• The standby lever is set to LOCK (p. 11). |
| <p>? There's a blank blue screen in the display.</p> | <ul style="list-style-type: none">• You are attempting to play back or record from a copyright protected cassette (p. 72).• The tape heads are very dirty (p. 79). |

❓ The camera won't focus.

- The camera is on manual focus (p. 50).
- The viewfinder lens needs adjusting (p. 73)
- The lens is dirty (p. 79).

Note:

Some subjects are not suitable for autofocus. In these situations, you will often get better results using manual focus (see p. 50). Focus on something which is about the same distance away, lock the focus, and then point the camera at your original, hard-to-focus subject.

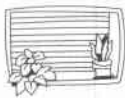

Horizontal stripes



Many subjects at different distances



Behind glass



Without much contrast (e.g. a white wall)



Reflective surfaces (e.g. shiny car surfaces)



Fast moving objects



Slanted subjects



Dark subjects



Night scenes

Recording/Playback (Contd.)

Problem

Cause and/or what to do about it

❓ The digital effects don't work

- There are a number of restrictions on using the digital effects. Refer to the notes on p. 43.

❓ The ► (play) button doesn't work

- The POWER switch is not set to PLAY (MV10i:VCR) (p. 11).
- The cassette is not loaded (p. 9).
- The tape has reached the end.

Problem

- ❓ **There's a bright stripe on the screen.**
- ❓ **The playback picture is rough (with mosaic-like noise)**
- ❓ **There's no picture on the TV screen, even though the tape is moving.**
- ❓ **There's no sound coming from the speaker during playback.**

Cause and/or what to do about it

- When recording in dark places a bright light in the scene may cause a vertical light bar ("smear") to appear. This is a normal feature of camcorders.
- The video heads need cleaning (p. 79).
- The video heads need cleaning (p. 79).
- The TV/VIDEO selector on the TV isn't set to VIDEO (p. 20)
- If connected using the optional RF unit the video channel has not been selected.
- The volume control is switched off (p. 16).
- Headphones are being used.

Miscellaneous**Problem**

- ❓ **The wireless controller doesn't work.**
- ❓ **The tally lamp doesn't flash**
- ❓ **The power indicator is flashing.**
- ❓ **The camera malfunctions.**
- ❓ **The DV cable is connected correctly, but there's nothing in the display.**

Cause and/or what to do about it

- The remote sensor is turned off (p. 31).
- The batteries are dead or not inserted.
- It is turned off (p. 31).
- Check the screen displays (p. 74).
- External interference may cause the camera's microprocessor to malfunction temporarily. If random letters appear in the display or if normal operation is interrupted, remove and then replace the power source (and if necessary, the back-up battery).
- Remove the cable and then reconnect it or turn the power off and back on again.

The MV10/MV10i System Diagram (Availability differs from area to area)

E

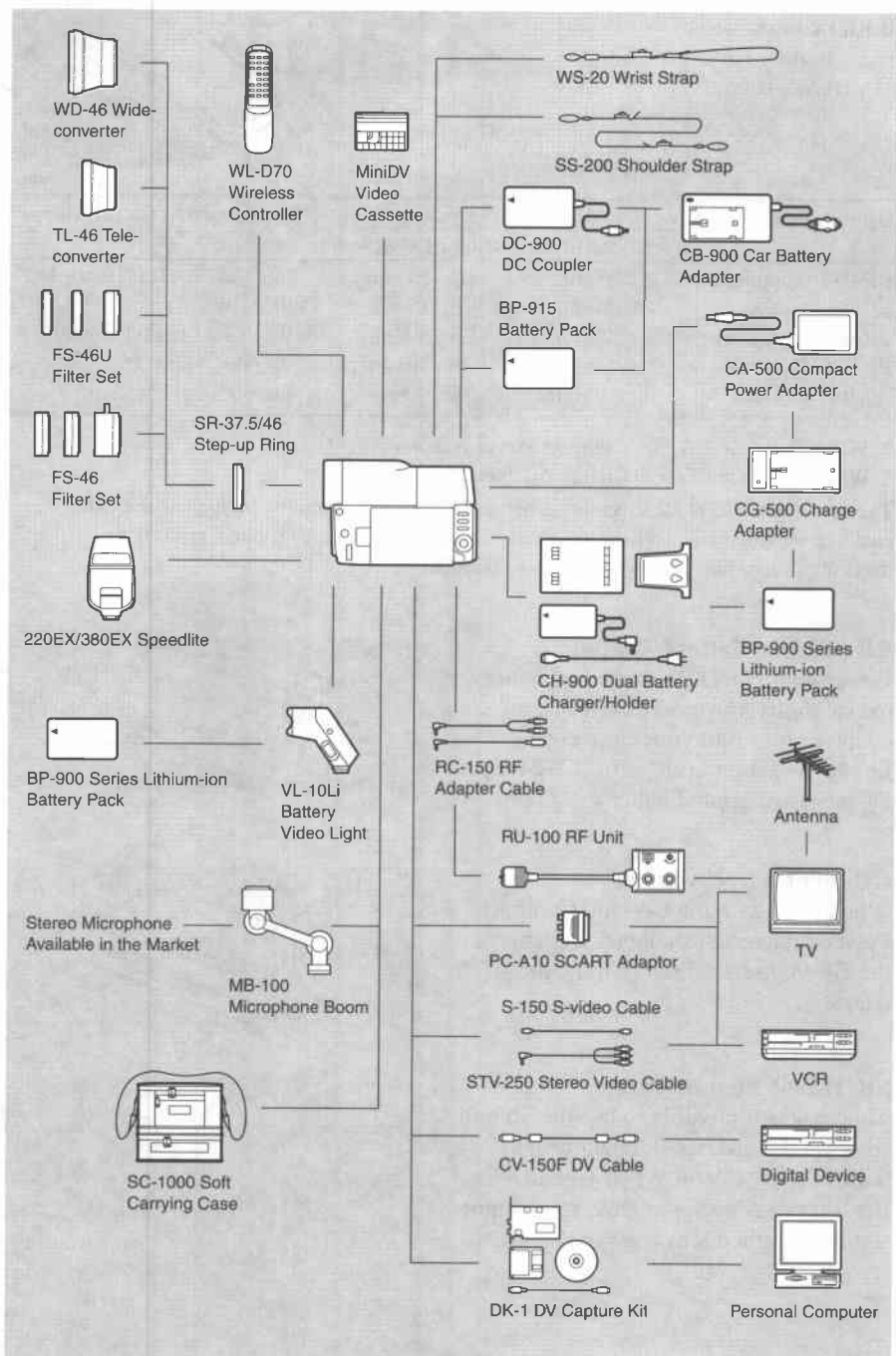

Additional Information

Optional Accessories

E

Battery pack

Extra battery for use with the MV10/MV10i.

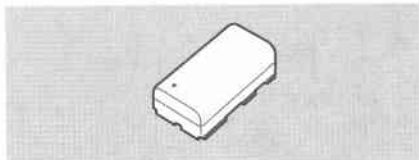

Battery pack	Maximum recording		Time required for full charge
	using viewfinder	using LCD screen	
BP-915 (supplied)	1hr. 35min.	1hr. 20 min.	2hr. 40min.* / 3hr. 10min.**
BP-914 (optional)	1hr. 25min.	1hr. 15min.	2hr.* / 3hr. 10min.**
BP-927 (optional)	2hr. 50min.	2hr. 30min.	3hr. 50min. / 5hr. 20min.**
BP-930 (optional)	3hr. 10min.	2hr. 40min.	4hr. / 5hr. 40min.**
BP-941 (optional)	4hr. 10min.	3hr. 40min.	6hr. 30min. / 8hr. 50min.**

* When using the CA-500 Compact Power Adapter

**When using the CG-500 Charge Adapter

The optional CH-900 Dual Battery Charger/Holder is required to charge/use the battery packs in a shaded area. When you attach the two battery packs to the CH-900, the maximum recording time will be almost doubled.

CB-900 Car Battery Adapter

Power your camera, or recharge battery packs on the move. The car battery adapter plugs into your car's cigarette lighter socket and runs off a 12–24 V DC negative ground battery.

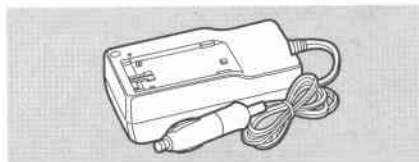

CG-500 Charge Adapter

When used with the CA-500 Compact Power Adapter, this adapter can charge the BP-900 series lithium ion battery packs.

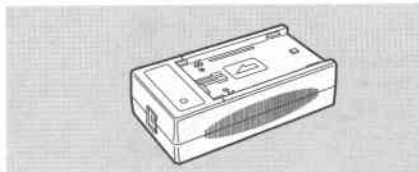

SR-37.5/46 Step-up ring

This makes it possible to use the 46 mm filters and converters (shown below) with MV10/MV10i. When you attach the filter or conversion lens, you cannot use the supplied lens cap.

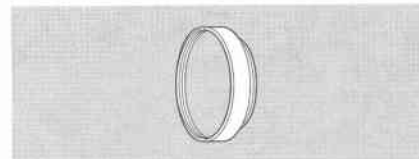

TL-46 Tele-converter

This tele-converter lens increases the focal length of the camera lens by a factor of 1.4. The zoom and autofocus operate as usual, so you can take full advantage of the extra range.

- The image stabilizer is not as effective as usual when the tele-converter is attached.

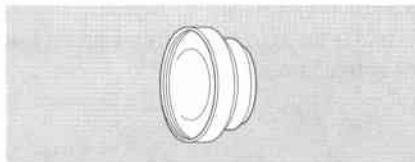

WD-46 Wide-converter

This lens decreases focal length by a factor of 0.7, giving you a wide perspective for indoor shots or panoramic views.

- There may be some vignetting at the extreme wide angle position.

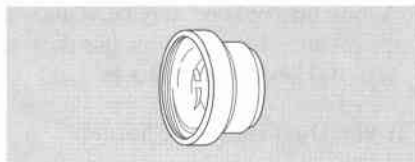

FS-46 Filter Set

Three special effects filters to add a creative touch to your recordings: multiple-image, R-cross and zoom-spot.

- Focus manually when using special effects filters.
- There may be some vignetting when using special effect filters.

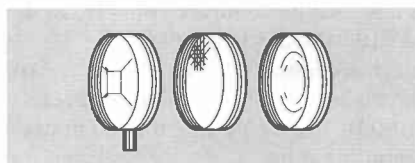

FS-46U Filter Set

Ultraviolet, neutral density and circular polarizing filters to help you take control of difficult lighting conditions.

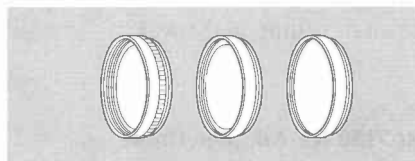

VL-10Li Battery Video Light

This compact yet powerful video light can be used for both indoor and outdoor shooting.

- Lithium ion battery packs can be used to power the light. Approximate usage times are as follows:

BP-914	50 min	BP-927	100 min
BP-915	60 min	BP-930	120 min
BP-941	160 min		



WS-20 Wrist Strap

Provides an extra measure of protection for active shooting.

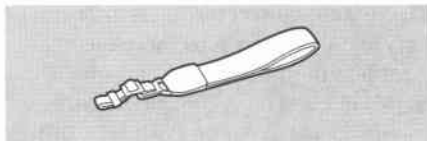
**MB-100 Microphone Boom**

Provides a firm, flexible support for the microphone, so you can take full advantage of the sound quality and creative control it offers.

- A long microphone may be visible in the picture. To avoid this, use the MB-100 Microphone Boom.

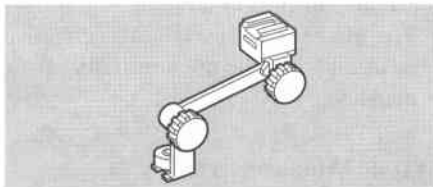
**CH-900 Dual Battery Charger/Holder**

This holds two battery packs and can charge them both consecutively. It can then be connected directly to the MV10/MV10i to give twice the playback time. It can also make use of the higher performance battery pack BP-941, to give up to 4 hrs. 10 mins. recording time.

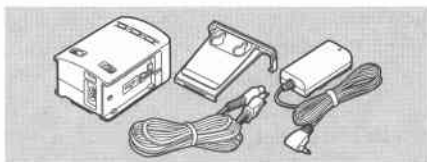
**SC-1000 Soft Carrying Case**

This lightweight bag keeps the camera within easy reach without weighing you down or getting in the way.

**RC-150 RF Adapter Cable**

This makes it possible to use the RU-100 RF Unit with MV10/MV10i.

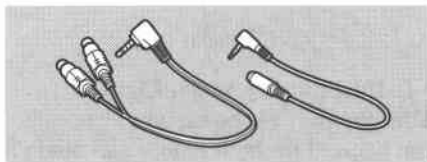
**RU-100 RF Unit**

This optional converter allows the camera to be connected to the antenna terminal of any TV. It can be a useful accessory while traveling, as you may need it if you want to connect the camera to a TV in your hotel room.

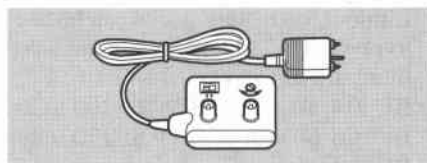

220EX Speedlite/380EX Speedlite

Attaches to the MV10/MV10i's accessory shoe to give SLR-style flash photography.

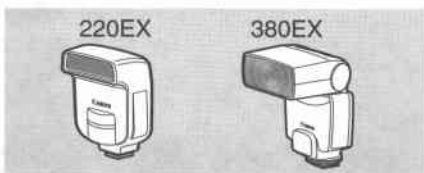

E

DK-1 DV Capture Kit

It contains Adaptec IEEE 1394 interface board AHA8940, Adaptec IEEE 1394 Software, Canon DV Commander, Canon DV TWAIN Driver and MGI PhotoSuite. You can capture the still pictures from the MV10/MV10i on your computer. For use with Windows 95.

- Adaptec, AHA are trademark of Adaptec, Inc./MGI PhotoSuite is a trademark of MGI Software Corp./Windows is a registered trademark of Microsoft Corporation.

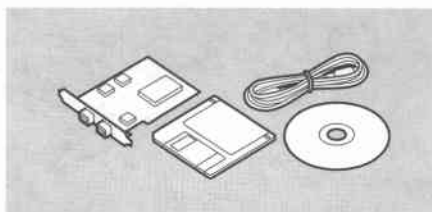

This mark identifies genuine Canon video accessories. When you use Canon video equipment, we recommend Canon-brand accessories or products bearing the same mark.

Finding Your Way Around MV10/MV10i

E

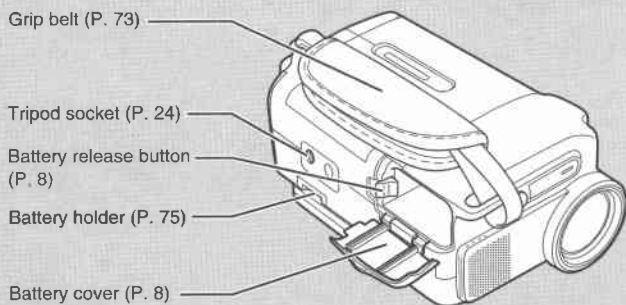
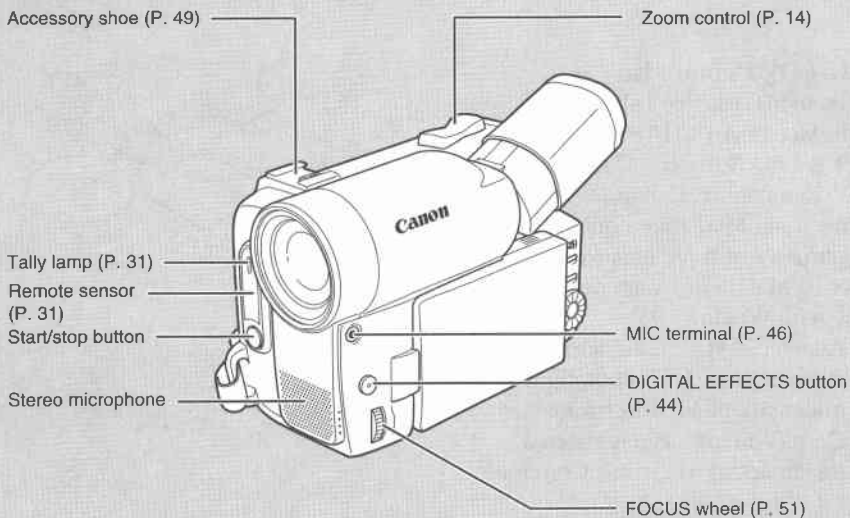

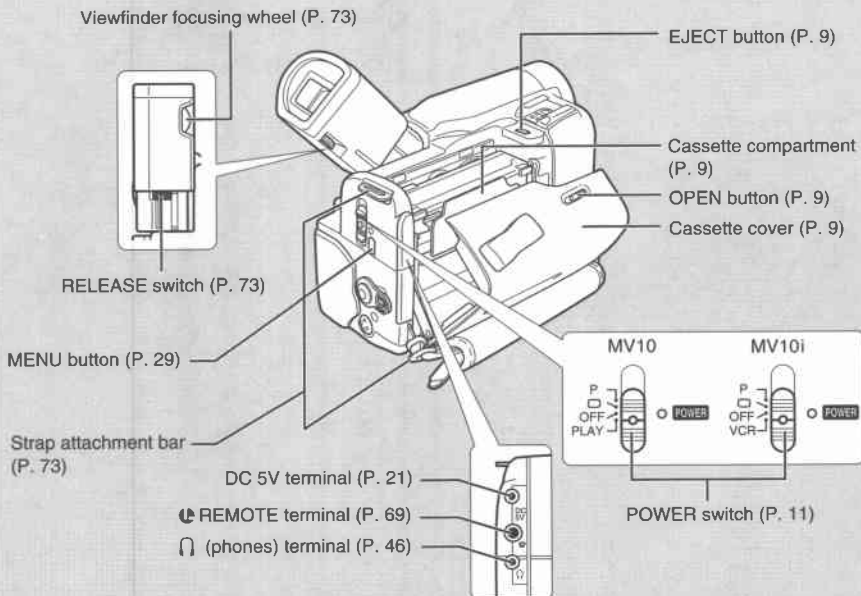
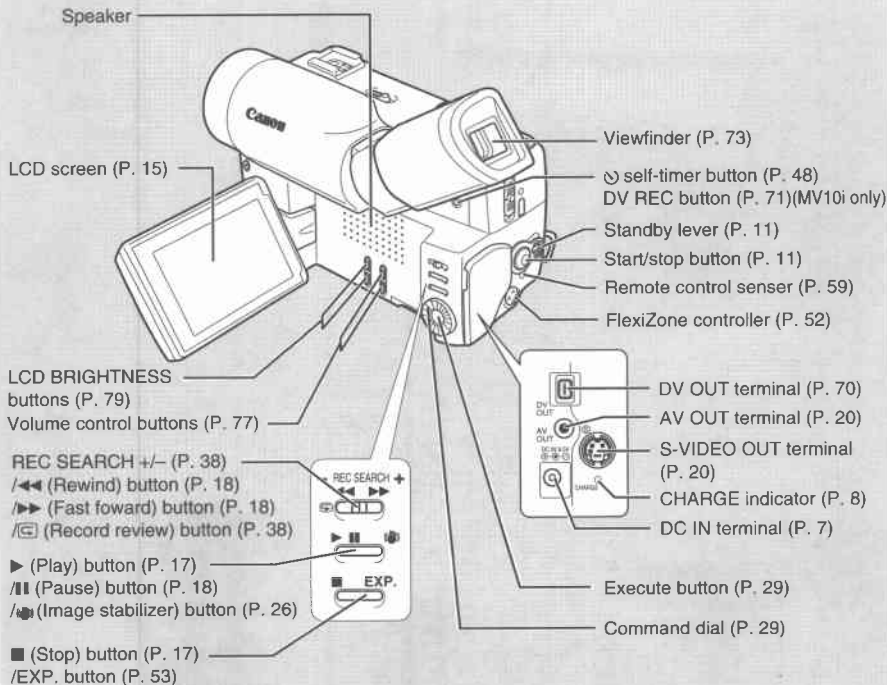

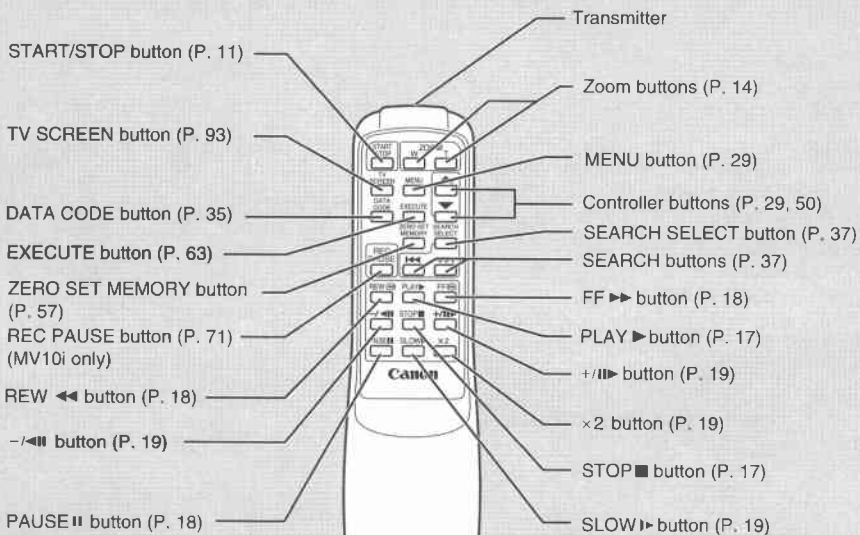

Screen Displays

To display the date and time on a connected TV, press the wireless controller's DATA CODE button.

Press the wireless controller's TV SCREEN button to see the other displays on the TV screen. (The displays appear white on-screen.) They will not be added to any recordings you make with the camera.

 indicates a flashing display.

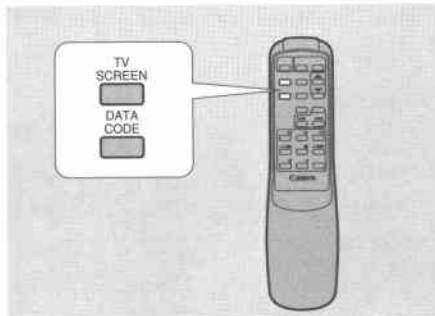

E

Turning off the LCD screen displays

You can turn off the displays to give you a clear screen for playback. Set the camera to PLAY (MV10i:VCR) mode, open the PLAY (MV10i:VCR) menu (page 27) and choose the DISPLAYS option. Set the displays to OFF and then close the menu.

- The LCD screen will now be completely blank, but the camera will continue to show warning/caution displays when necessary.

Record pause mode
(p. 11)



Recording (p. 11)



The backup battery is not properly installed, or needs replacing
(p. 75).



Shows how much battery power remains
(p. 74).



The battery pack is exhausted (p. 8, 74).



No cassette is loaded, or it is set for erasure prevention (p. 10).



Remaining tape
(Green: more than 5 mins.
Yellow: less than 5 mins.
Red: final few secs).



...finally, it tells you when you have completely run out of tape.

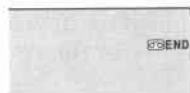

The camera is ejecting the tape (p. 9).



The safety mechanism is activated. Unload the cassette and turn the camera off. Turn it on again and reload the cassette.



Recording mode
(p. 13)



Playback is stopped
(p. 17).



Normal playback
(p. 17)



Fast forward (p. 17)



Rewind (p. 17)



Fast forward playback
(p. 18)



Rewind playback
(p. 18)



Frame advance
playback (p. 19)



Frame reverse
playback (p. 19)



Playback pause
(forward and reverse)
(p. 19)



Slow playback
(forward and reverse)
(p. 19)



×2 playback (forward
and reverse) (p. 19)



×1 playback (forward
and reverse) (p. 19)



Photo Search
(p. 37)

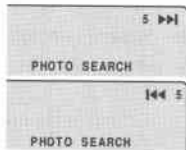

Zoom display (p. 14):
Optical zoom



Optical plus digital
zoom



Zoom in



Zoom out



The image stabilizer is
turned on (p. 26).



Camera menu (p. 27)

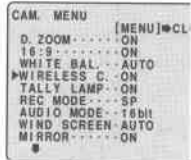

PLAY (MV10i:VCR)
menu (p. 27)

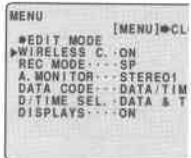

Edit menu (p. 28)

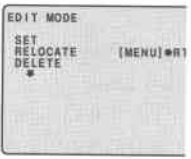

Set up menu (p. 28)

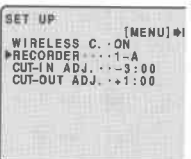

The remote sensor is
turned off (p. 31).



Self-timer countdown
(p. 48)



Audio mode (p. 46)



Data code (p. 35)



Volume level (p. 77)

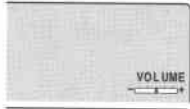

Screen brightness
(p. 79)



DV input (p. 70)



Photo mode (p. 36)



Setting the AF/AE mark flashes white



AF/AE locked mark lights up green



Recording programs (p. 40)

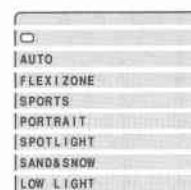

Flash is charging mark flashes white (p. 49) or charged



Flash mark lights up green (p. 49)



Manual exposure display (p. 52): Exposure locked



Brighter than standard exposure level

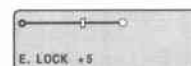

Darker than standard exposure level

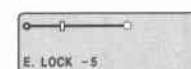

Manual focus is selected (p. 51).

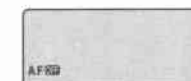

White balance is (p. 55).

Set Outdoor Indoor

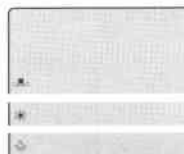

The 16:9 effects: the display flashes when the effect is being selected, and appears steadily when it is activated (p. 45).



Digital effects functions. The display flashes when the function is being selected and appears steadily when it is activated (p. 43).



The wind screen is turned off (p. 47).



Audio output (p. 77)

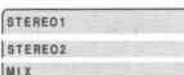

Mix balance (p. 77)

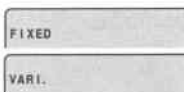

Condensation warning (p. 81)



E

Time Code

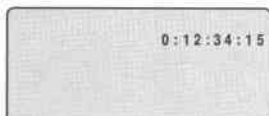

This records counter information, including hour, minute, second, and frame number on a special data code area on the tape itself. It is reset automatically when a new tape is loaded.

Recording reminder

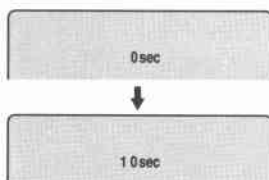

When you start recording, the camera counts from 0SEC to 10SEC. Shots which are shorter than 10 seconds may be difficult to edit later. On the other hand, if you are not planning to edit the recording, remember that a shot which does not contain action should generally last no longer than 10 seconds.

Caution phrases

The camera displays various caution phrases — they appear for 4 seconds before disappearing.

Appears each time you turn the power on, until you set the date and time (p. 34).

SET THE TIME ZONE,
DATE AND TIME

Appears when the battery pack is exhausted (p. 8, 74).

CHANGE THE BATTERY PACK

Appears when the tape has reached the end.

TAPE END

Refer to page 10.

THE TAPE IS SET FOR
ERASURE PREVENTION

Refer to page 81.

CONDENSATION
HAS BEEN DETECTED

Appears as a warning to protect the tape and also when condensation is detected. Remove the tape as soon as possible after the camera has displayed the caution.

REMOVE THE CASSETTE

Refer to page 72.

COPYRIGHT PROTECTED
PLAYBACK IS RESTRICTED

Refer to page 72.

COPYRIGHT PROTECTED
DUBBING RESTRICTED

MV10i only

Appears when you press the DV REC button if the DV cable is not connected properly (p. 71).

CHECK THE DV INPUT

Specifications

MV10/MV10i

- Power Supply (rated):** 7.2 V DC
- Power Consumption (while recording with the AF turned on):** 5.4 W (Using viewfinder), 6.2 W (Using LCD screen)
- Television system:**
CCIR standard (625 lines, 50 fields)
PAL colour signal
- Video recording system:**
2 rotary heads, helical scanning
DV system (Consumer digital VCR SD system)
Digital component recording
- Audio recording system:** PCM digital sound: 16 bit (48kHz/2ch), 12 bit (32kHz/4ch)
- Image sensor:** 1/4" CCD (charge coupled device) 460,000 pixels (420,000 effective pixels)
- Tape format:** Videocassettes bearing the ^{Mini}DV mark.
- Tape speed:**
SP: 18.83 mm/s
LP: 12.57 mm/s
- Maximum recording time:**
SP: 60 minutes (with a 60 min. cassette);
LP: 90 minutes (with a 60 min. cassette)
- Fast forward/rewind time:**
Approx. 2 min. 50 sec. (with a 60 min. cassette)
- Lens:** F/1.8–2.6, 16× power zoom, 3.9–62.4mm
- Focusing system:** TTL autofocus, manual focusing possible
- Minimum focusing distance:** 80 cm (2 5/8 feet) (1 cm (3/8 inch) on maximum wide angle)
- Maximum shutter speed:** 1/8,000 sec
- Minimum illumination:** 2 lx (using the Low Light program)

- Recommended illumination:**
More than 100 lx
- Filter diameter:** 37.5 mm
- Viewfinder:** 0.55-inch, color LCD (approx. 113,000 pixels)
- LCD screen:** 2.8 inch measured diagonally, 190,000 pixels (approx.)
- Microphone:** Stereo electret condenser microphone
- DV Terminal:** Special 4-pin connector (conforms to IEEE1394)
- Output level:**
Video terminal: 1 Vp-p/75 ohms unbalanced
S-video terminal: 1 Vp-p (Y signal), 0.286 Vp-p (C signal)
Audio terminal: -10dBV, less than 3 kohms, unbalanced
- Operating temperature range:**
0–40 °C (32–104 °F)
- Dimensions:** 73 × 100 × 146mm (2 7/8 × 3 7/8 × 5 3/4 in)
- Weight:** 720g (1lbs 9 3/8 oz approx.)

BP-915 Battery Pack

- Battery type:** Rechargeable lithium ion battery
- Rated voltage:** 7.2 V DC
- Operating temperature:** 32°–104°F (0°–40°C)
- Battery capacity:** 1,500 mAh
- Dimensions:** 38.2 × 20.5 × 70.5 mm (1 1/2 × 3/4 × 2 3/4 in)
- Weight:** 96 g (3 3/8 oz)

Weight and dimensions are approximate
Errors and omissions excepted.
Subject to change without notice.

Index

E

A

Abroad, Using the Camera, 80
Accessories, 4, 86
Adapter, AC, 7
AE Programs, 40
Art, 43
Audio Output, 77
Audio Recording and Playback, 46
Audio/Video Terminals, 20
Auto, 41
Auto Editig, 58
Autofocus, 50

B

Backup Battery, 73
Basic Recording, 11
Battery Pack, 8
Black and White, 43

C

Cables, 4, 20
Cassettes, 9
Charging the Battery Pack, 8
Choosing a Recording Program, 40
Cleaning the Camera, 79
Condensation, 81
Connection to TV or VCR, 20

D

Date and Time, 34
Displaying Data Code, 35
DC Coupler, 7
Digital Effects, 43
Digital Video, 5
Digital Zoom, 14
DV terminal, 70

E

Easy Recording, 40
Editing, 69
Exposure, 52
External Microphone, 46

F

Fade, 43
Fast Forward, 18
Feedback, 21
Finding Your Way Around the
MV10/MV10i, 90
Flash photography, 49
FlexiZone, 41
FlexiZone control, 50
Focusing, 50

H

Head Cleaning, 79
Headphones, 46

I

Image Stabilizer, 26
Introducing the MV10/MV10i, 5

L

LANC, 69
LCD Screen, 15
Lens Cap, 73
Loading Cassettes, 9
Low Light, 42
LP Modes, 13

M

Maintenance, 78
Making Better Videos, 24
Manual Exposure Control, 52
Manual Focus, 51
Menus, 27, 28
Monitor recording, 15

O

Optical Image Stabilizer, 26
Optional Accessories, 86

P

Pause, Record, 11
 Photo Mode, 36
 Photo Search, 37
 Playback, 17
 Playback Connection, 20
 Playback pause, 18
 Portrait, 41
 Power Adapter, 7
 Powering your camcorder, 7
 Pre- Marked Position, 57
 Preparing the Camera, 73
 Problems, 82

R

Recharging the Battery Pack, 74
 Recorder, 60
 Recording, 11
 Recording Programs, 40
 Record Pause Mode, 11
 Record Review, 38
 Record Search, 38
 Remote Control, 30
 Remote Sensor, 30
 Rewind, 18

S

Sand & Snow, 42
 Screen Displays, 93
 Scroll, 43
 Self-Timer, 48
 Sepia, 44
 Shoulder Strap, 73
 16:9, 45
 Specifications, 97
 Speedlite, 49, 89
 Spotlight, 42
 Sports, 41
 SP Modes, 13
 Storage, 78
 Strobe, 44
 S-video, 20
 System Diagram, 85

T

Tally Lamp, 31
 Tape Protection, 10
 Telephoto, 14
 Temperature, 74, 78
 Time Code, 96
 Time Zone, 32
 Tripod, 24
 Troubleshooting, 82
 TV, 20, 93

U

Using the Camera Abroad, 80
 Using the Menus, 27, 28

V

VCR, 20
 Videocassettes, 9
 Video Channel, 23
 Video heads, 79
 Viewfinder, 73, 79

W

Wide-angle, 14
 Wind Screen, 47
 Wipe, 43
 Wireless Controller, 31
 White Balance, 55

Z

Zooming, 14

E

Canon

CANON INC.

Canon Europa N.V.

P.O. Box 2262, 1180 EG Amstelveen, the Netherlands

Canon UK Ltd

Camera Division, Units 4 & 5, Brent Trading Centre, North Circular Road, Neasden, London
NW10 0JF, United Kingdom
Telephone 081-459-1266

Canon Australia Pty. Ltd

1 Thomas Holt Drive, North Ryde, N.S.W. 2113, Australia
Telephone 805-2000, Fax 887-4484

Canon New Zealand Ltd

Fred Thomas Drive, Takapuna, P.O. Box 33-336, Auckland, New Zealand
Telephone 486-1570, Fax 486-6420

Canon Singapore Pte. Ltd

79 Anson Road #09-01/06, Singapore 079906
Telephone (65)-532-4400, Fax (65)-221-2939

Canon Hongkong Company Ltd

10/F., Lippo Sun Plaza, 28 Canton Road, Tsimshatsui, Kowloon, Hong Kong

Canon Latin America, Inc.

Sales & Enquiries: 6505 Blue Lagoon Drive Suite 325 Miami FL 33126 USA

Free Manuals Download Website

<http://myh66.com>

<http://usermanuals.us>

<http://www.somanuals.com>

<http://www.4manuals.cc>

<http://www.manual-lib.com>

<http://www.404manual.com>

<http://www.luxmanual.com>

<http://aubethermostatmanual.com>

Golf course search by state

<http://golfingnear.com>

Email search by domain

<http://emailbydomain.com>

Auto manuals search

<http://auto.somanuals.com>

TV manuals search

<http://tv.somanuals.com>