

DIGITAL VIDEO CAMCORDER

Instruction Manual

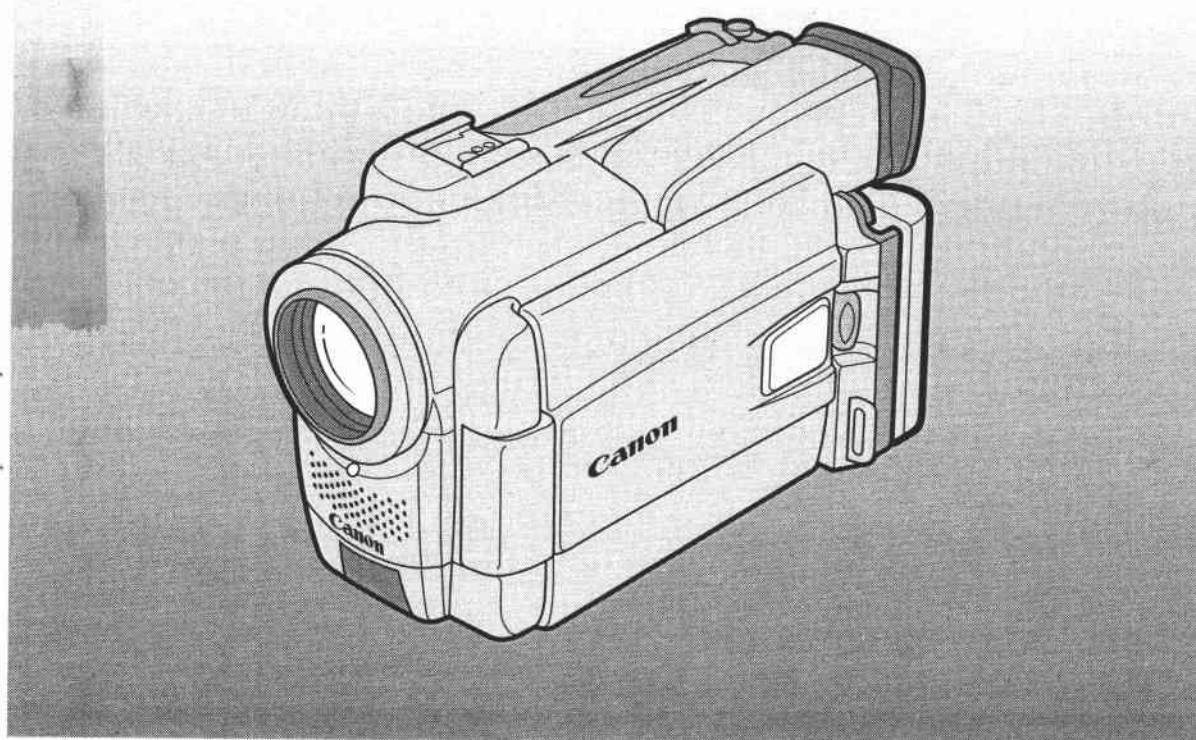

Canon

MV30/MV30i

Mini **DV** Digital
Video
Cassette

This instruction book explains the use of the MV30 and MV30i camcorders. The main difference between these models is that the MV30i includes a DV Recording function. The MV30i is only available in some areas. Please note that illustrations and explanations in this instruction book refer mainly to the MV30 model.

PAL



E

Introduction

Quick Overview

Using the Full
Range of Features

Editing

Additional
Information

Important Usage Instructions

WARNING:



TO REDUCE THE RISK OF ELECTRIC SHOCK, DO NOT REMOVE COVER (OR BACK). NO USER SERVICEABLE PARTS INSIDE. REFER SERVICING TO QUALIFIED SERVICE PERSONNEL.

WARNING:



TO REDUCE THE RISK OF FIRE OR ELECTRIC SHOCK, DO NOT EXPOSE THIS PRODUCT TO RAIN OR MOISTURE.

CAUTION:

TO REDUCE THE RISK OF ELECTRIC SHOCK AND TO REDUCE ANNOYING INTERFERENCE, USE THE RECOMMENDED ACCESSORIES ONLY.

CAUTION:

DISCONNECT THE MAINS PLUG FROM THE SUPPLY SOCKET WHEN NOT IN USE.

For Users in the UK

When replacing the fuse only a correctly rated approved type should be used and be sure to re-fit the fuse cover.

CAUTION:

CUSTOMERS IN THE U.K. SHOULD READ THIS BEFORE USING THIS PRODUCT.

CHANGING THE FUSE

THE MAINS LEAD ON THIS PRODUCT IS FITTED WITH A NON-REWIREABLE (MOULDED) PLUG, INCORPORATING A 3 AMP FUSE. SHOULD THE FUSE NEED TO BE REPLACED AN ASTA OR BSI APPROVED BS1362 FUSE OF THE SAME RATING MUST BE USED.

ALWAYS REFIT THE FUSE COVER AFTER REPLACING THE FUSE. NEVER USE THE PLUG WITH THE FUSE COVER OMITTED.

CHANGING THE PLUG

IF THE FITTED PLUG IS NOT SUITABLE FOR YOUR SOCKET OUTLETS, IT SHOULD BE CUT OFF AND AN APPROPRIATE PLUG FITTED IN ITS PLACE. IF POSSIBLE FIT AN APPROPRIATE 3 AMP FUSE. IF THE NEW PLUG HAS NO FUSE, THEN FIT A 5 AMP FUSE AT THE DISTRIBUTION BOARD.

AC POWER CORD CONNECTION (CA-560B only)

The wires in the mains lead of this apparatus are coloured in accordance with the following cord:

(IMPORTANT)

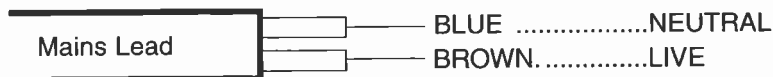

As the colours of the wires in the mains lead may not correspond with the coloured markings identifying the terminals in your plug, proceed as follows: The wire which is coloured BLUE must be connected to the terminal which is marked with the letter N or coloured black. The wire which is coloured BROWN must be connected to the terminal which is marked with the letter L or coloured red. Neither Blue wire or Brown wire is to be connected to the Earth pin of a 3 pin plug.

THE SEVERED PLUG MUST BE DESTROYED IMMEDIATELY TO AVOID ANY POSSIBLE ELECTRIC SHOCK HAZARD.

CA-560 identification plate is located on the bottom.

- This equipment has been tested in a typical system to comply with the technical requirements of EMC Directive.
- Use of CV-150F DV cable is necessary to comply with the technical requirement of EMC Directive.

Contents

Introduction

Important Usage Instructions	2
Thank you for Choosing a Canon	4

Quick Overview

Introducing the MV30/MV30i	5
Finding Your Way Around MV30/MV30i	6
Powering Your Camcorder	9
Loading a Cassette.....	14
Basic Recording	16
Zooming	20
Using the LCD Screen.....	21
Playing Back a Cassette	25
Connections for Playback on a TV Screen	28
Tips for Making Better Videos	31

Using the Full Range of Features

~ General ... ~

Turning the Optical Image Stabilizer Off	33
Selecting from the Menus	34
Using the Wireless Controller/Tally Lamp	37

~ For Recording ...~

Setting the Date and Time	40
Recording in Progressive Scan Mode ..	43
Taking Still Pictures	45
Using a Canon Speedlite for Flash Photography (optional)	47
Using the VL-3 Video Light (optional).....	48
Using the DM-50 Microphone (optional).....	49
Searching and Reviewing While Recording	50
Using the Various Recording Programs	51

Using Digital Effects	55
Using the Multi-Image Screen.....	61
Audio Recording	63
Setting the Self-Timer	65
~ When Making Manual Adjustments ...~	
Adjusting Exposure Manually	67
Adjusting Focus Manually	70
Setting the White Balance	71

~ For Playback ...~

Displaying Date, Time and Camera Data (Data Code)	73
Searching the Tape (Photo Search/ Date Search)	76
Returning to a Pre-Marked Position ...	77

Editing

The Dubbing Function.....	78
Using the Dubbing Function for the First Time	80
Cut-In and Cut-Out Adjustments	84
Simple Editing to a VCR	86
Dubbing with Digital Video Equipment.....	87
Recording Over Existing Scenes– A/V Insert Editing (MV30i only)	90
Audio Dubbing	93
Setting the Audio Mix	96

Additional Information

Preparing the Camera	98
Notes on Using the Batteries	100
Maintenance.....	103
Troubleshooting	107
The MV30/MV30i System Diagram ..	110
Optional Accessories	111
Screen Displays	115
Specifications.....	120
Index	121

Thank you for Choosing a Canon

E

First, we'd like to thank you for purchasing this Canon camcorder. Its advanced technology makes it very easy to use — you will soon be making high-quality videos which will give you pleasure for years to come.

Introduction

To get the most out of your new camcorder, we recommend that you read this manual thoroughly — there are many sophisticated features which will add to your recording enjoyment.

Getting started

To get started we suggest that you master the basic operations of the camcorder first, before moving on to use its full range of features.

For quick reference (in addition to the contents and index) please refer to:

- Finding your way around MV30/MV30i (6)
- Screen displays (115)
- Troubleshooting — in case you run into any problems (107)

Symbols used in this Instruction Manual:



📖 : Reference page numbers

🏠 : Supplementary notes for camcorder operation

🎵 : Operation confirmation beeps (19)

- Capital letters are used to refer to settings displayed in the menus and buttons labelled on the camcorder itself, e.g. Press the MENU button.

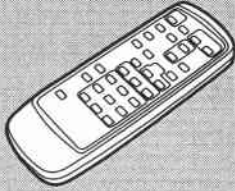
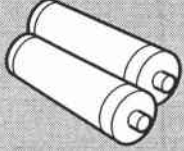
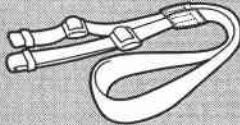
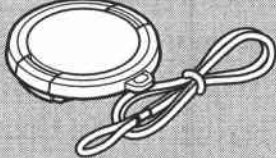
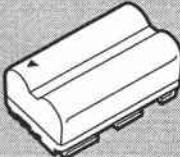
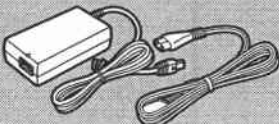
Your camcorder is supplied with the following accessories:

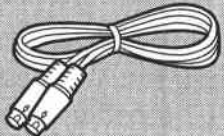
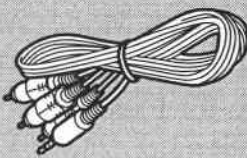
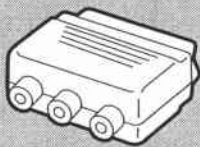
WL-D74 Wireless Controller 	Two AA batteries 
SS-600 Shoulder Strap 	Lens cap and lens cap cord 
BP-511 Battery Pack 	CA-560 Compact Power Adapter (including AC power cable) 
Lithium button battery 	S-150 S-video Cable 
STV-250N Stereo Video Cable 	PC-A10 SCART Adapter (Europe, Asia) 

Introducing the MV30/MV30i

Digital Video



MV30/MV30i is a next generation digital video camcorder that conforms to the digital video **Mini DV** standard and is equipped with the IEEE 1394 DV terminal to give you outstanding picture quality.

Progressive Scan CCD



Shoot both superb quality video and beautifully clear still pictures. Choose your favourite scenes from videos (taken using progressive scan) and display them as blur-free still pictures too!

3.5" LCD Screen



A big LCD screen makes it easy for you to shoot colourful, well composed video. It is also great for playback.

Optical Image Stabilizer



Optical technology stabilizes your recordings even in long telephoto shots.

12× Lens and 48× Digital Zoom

Still Photos

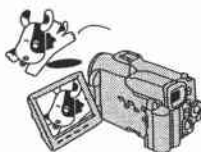

The MV30/MV30i has the technology to capture crisp, clear, digital still pictures.

Advanced Accessory Shoe

Allows the Canon Video Light VL-3 or the Directional Stereo Microphone DM-50 (both optional) to be easily attached and powered by the camera's own power source. Also attach the Speedlite 550EX, 380EX or 220EX for EOS cameras (all optional).

Dubbing Function

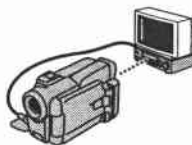

MV30/MV30i's dubbing function is easy to use. You can add digital effects during dubbing.

Digital Effects



Advanced digital technology allows you to add special effects during recording or playback. Display 4, 9 or 16 still images at once with the multi-image screen.

Audio Dubbing



Add new sound to original sound on a prerecorded tape.

AV Insert Editing (MV30i only)

Replace original sound and images on a prerecorded tape with the DV in terminal.

PCM Digital Sound

E

Quick Overview

Finding Your Way Around MV30/MV30i

E

Quick Overview

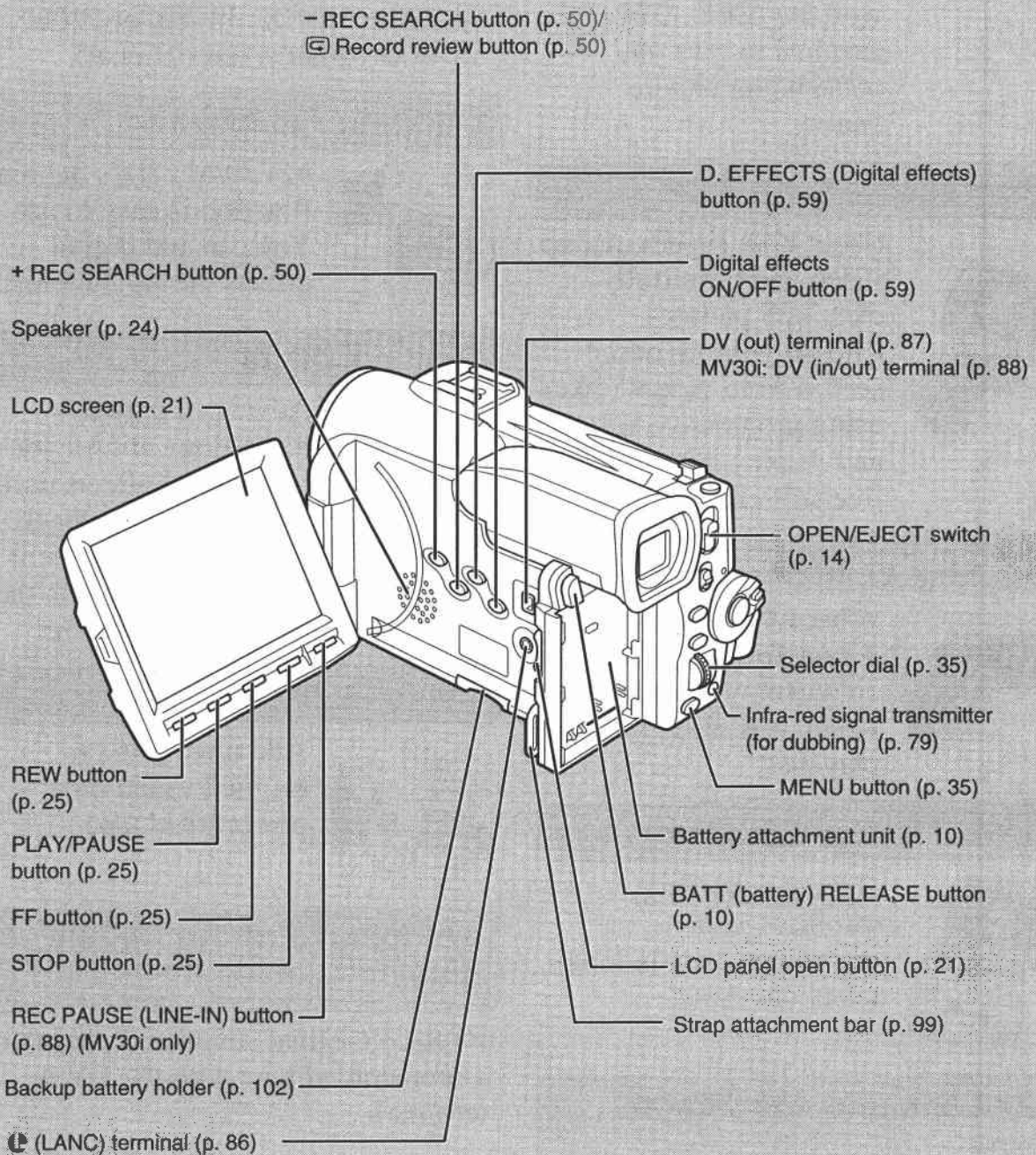

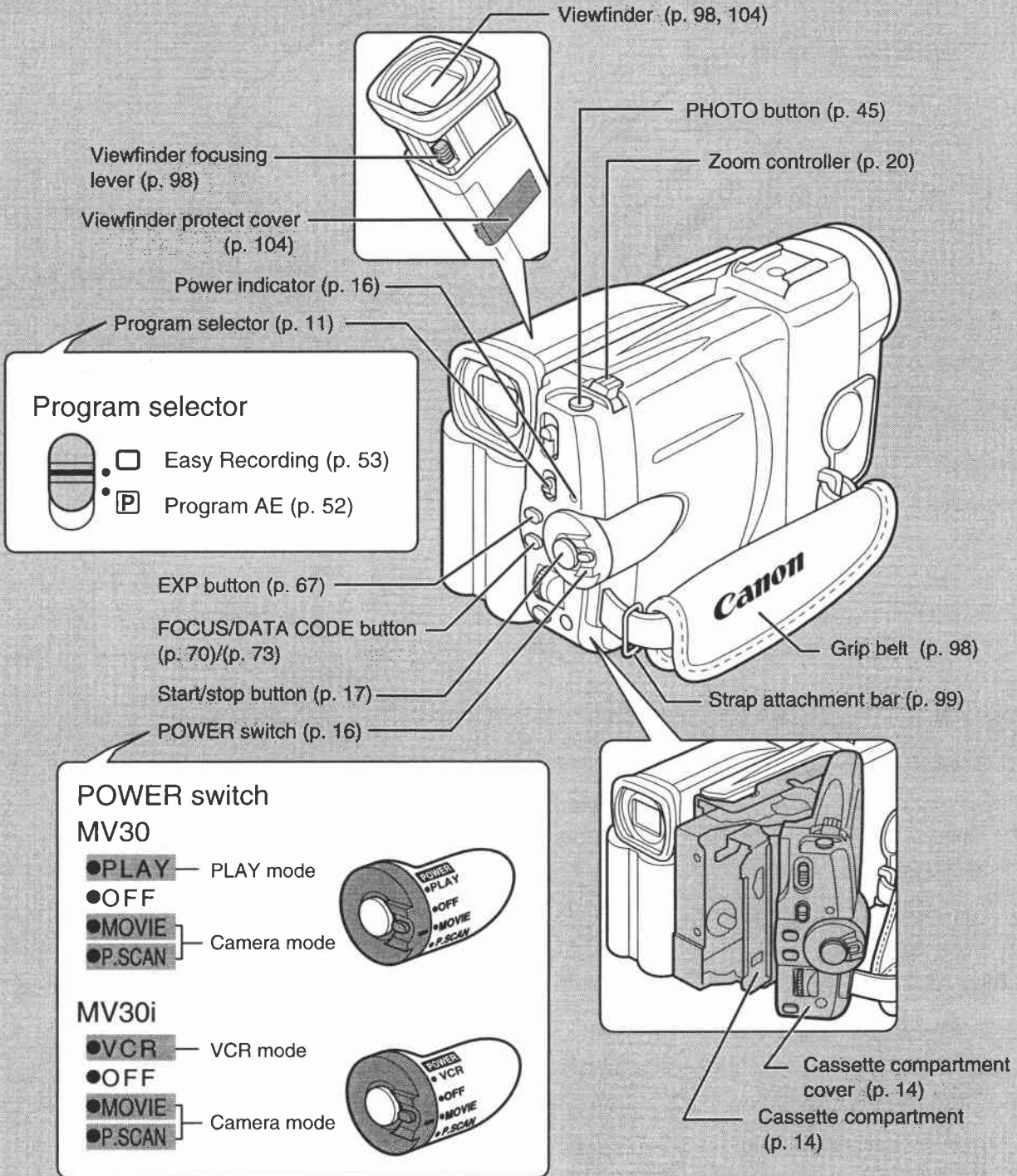

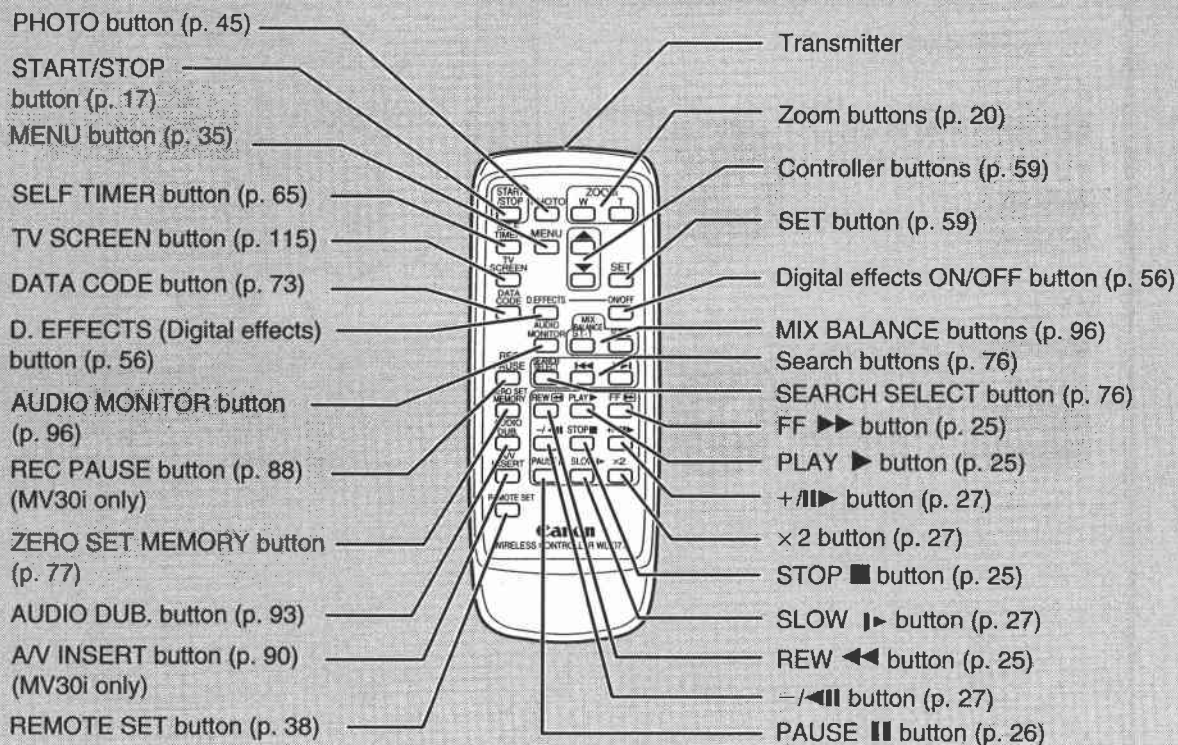
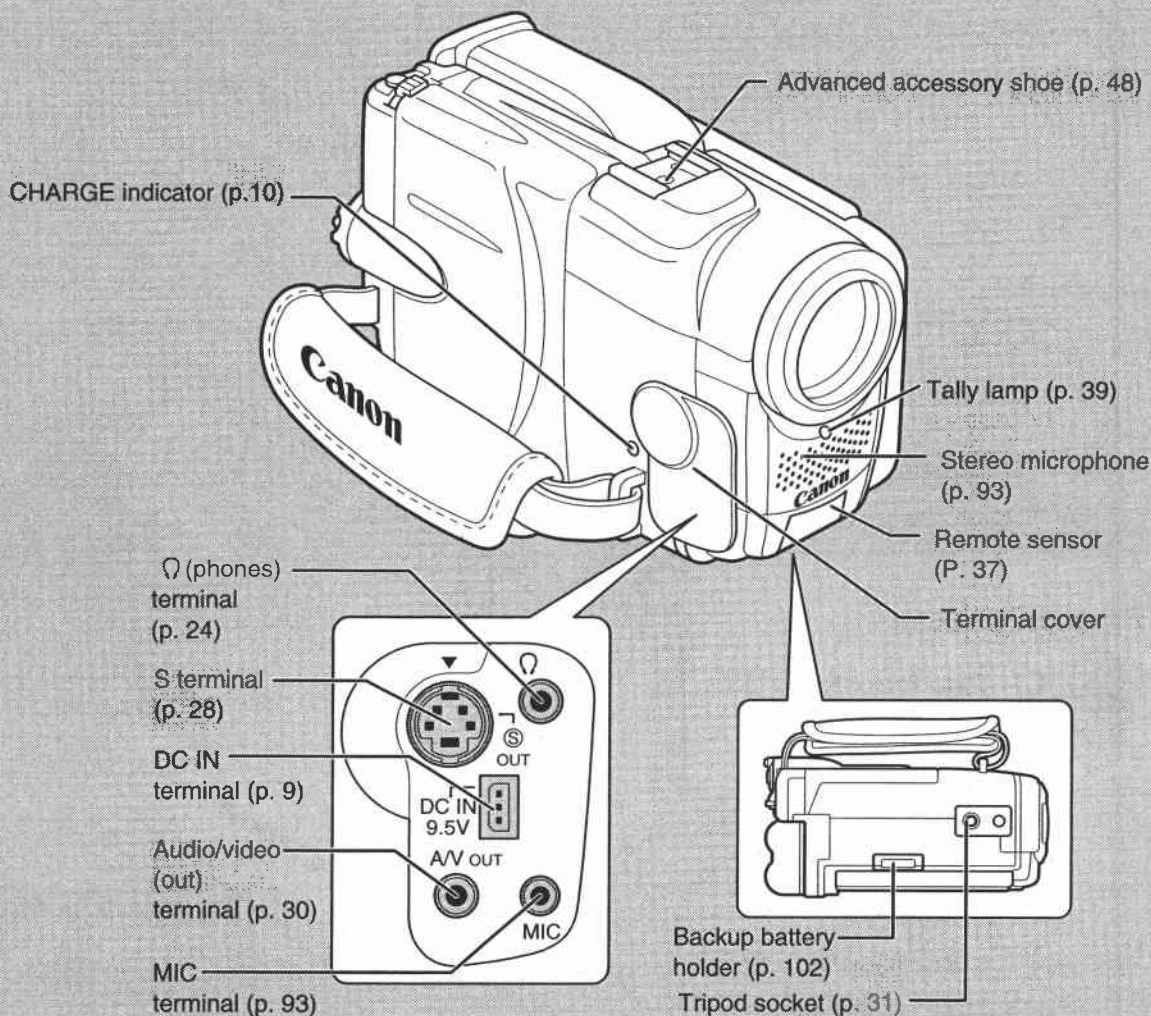

Powering Your Camcorder

Before operating your camera, you will need to use the power adapter to:

- Provide power from a mains outlet
- or
- Charge a battery pack



- The power adapter converts current from a household power socket (100–240 V AC, 50/60 Hz) to the DC current used by your camera.
- If the adapter is used next to a TV, it may cause bars to appear on the TV — move the adapter away from the TV or the aerial cable.

Connecting the camera to a mains outlet

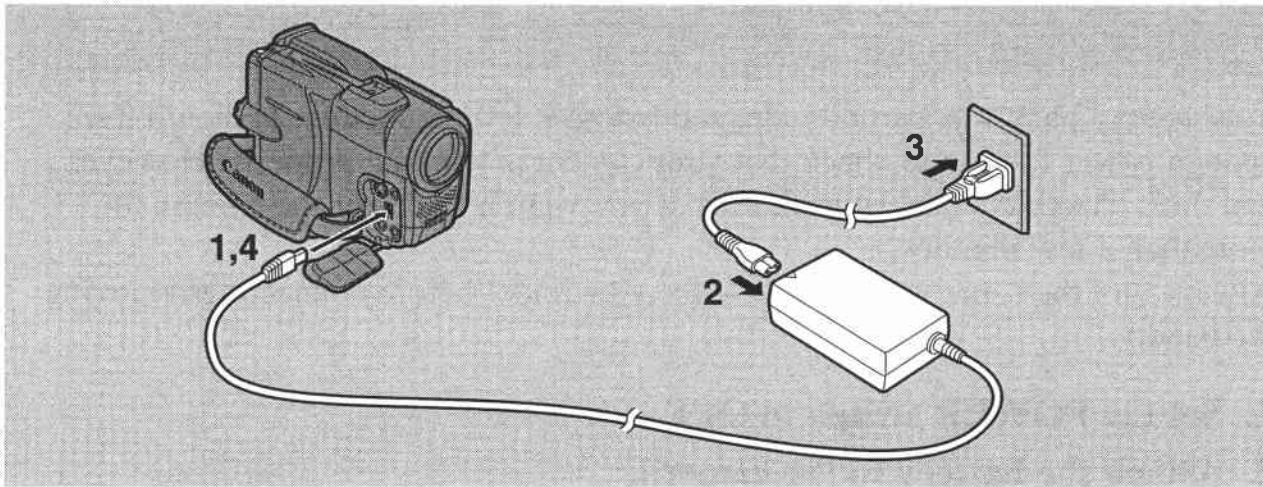

Use the power adapter to provide your camera with instant power from a mains outlet. Always turn the camera off before connecting/removing the power source.

1. Connect the power adapter to the camera's DC IN terminal.
2. Connect the power cable to the power adapter.
3. Plug the adapter into a mains outlet.
4. Disconnect the power adapter after use.

E

Quick Overview

Attaching and charging the battery packs

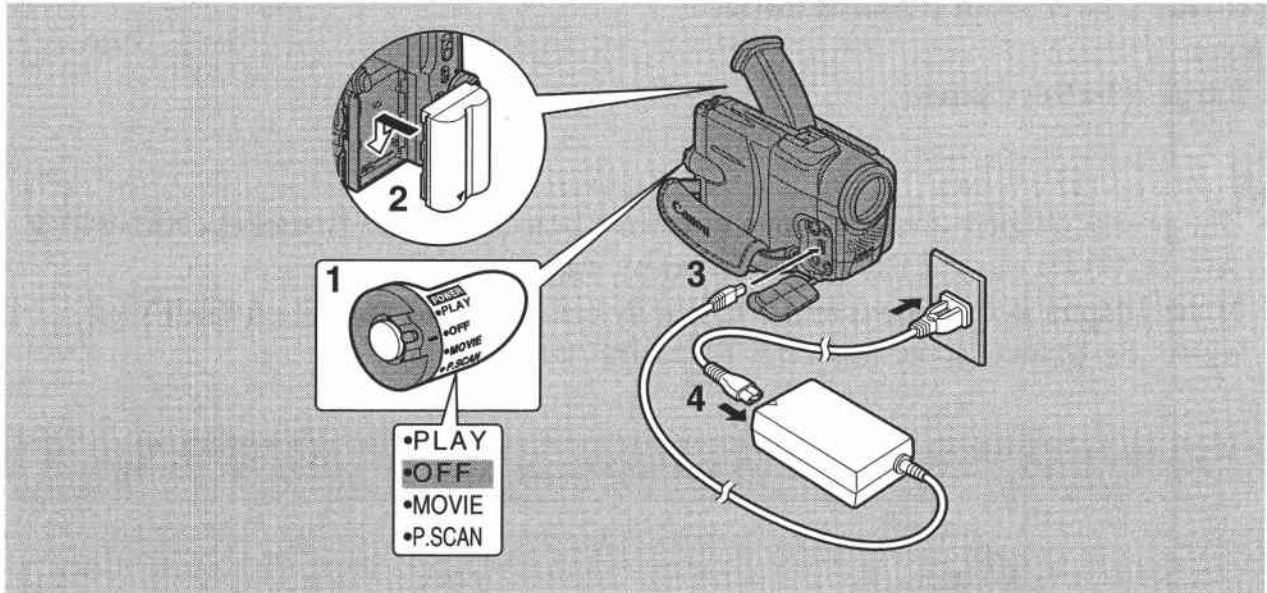

Your battery pack was partially charged before it left the factory. It should have enough power for you to check that your camera is working properly. However, you must charge the battery pack fully if you want it to power the camera for more than a few minutes.

Always turn the camera off and raise the viewfinder before connecting/removing the battery.

1. Set the POWER switch to OFF.

2. Attach the battery to the camera.

- Remove the battery pack's terminal cover.
- Rotate the viewfinder upwards.
- With the triangle on the battery pack pointing downwards, align the edge of the battery pack with the line on the camera, press lightly and slide the battery down until it clicks into place.

3. Connect the power adapter to the camera.

4. Connect the power cable to the adapter and plug it into a mains outlet.

- The charge indicator flashes red to show that charging is in progress. Single flashes mean that the battery pack is less than 50% charged. Double flashes mean that it is between 50% and 75% charged. Triple flashes mean that it is more than 75% charged. The indicator glows steadily when the battery pack is fully charged. If the indicator blinks twice a second, there is something wrong with the battery pack.
- Charging will also take place when the camera is in stop mode during PLAY (MV30i: VCR) mode, or the camera has turned itself off after being left in record pause mode for more than about 5 minutes.

5. When charging is complete, disconnect the power adapter.
6. Remove the battery pack after use.
 - Press and hold the BATT. RELEASE button while you slide the battery up.



- Never connect an unspecified product to the camera's DC terminal. Likewise, do not connect the power adapter to an unspecified product.
- You can find detailed notes for using the batteries in the "Notes on Using the Batteries" (100). These notes include charging and recording times and how to install the backup battery.

CA-560 Compact Power Adapter

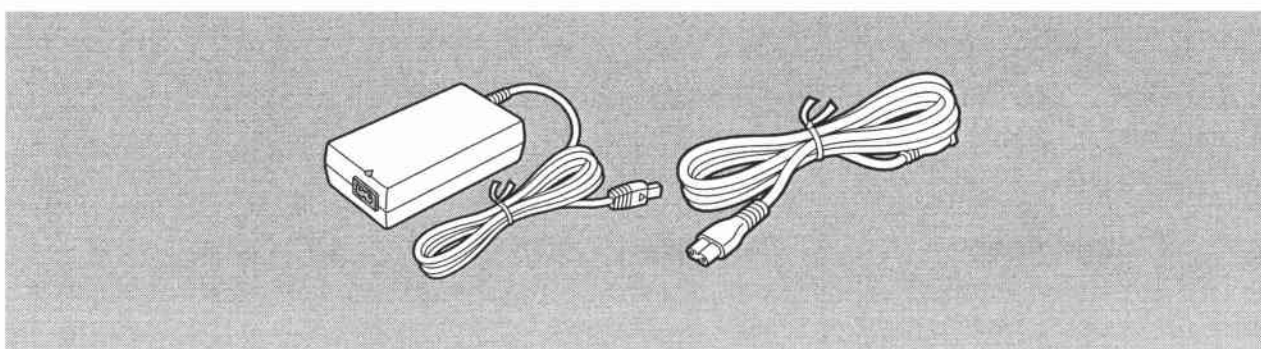

Specifications

Power supply	100–240 V AC, 50/60 Hz
Power consumption	34 W
Rated output	9.5 V, 2.7 A DC
Operating temperature range	0°C–40°C (32°F–104°F)
Dimensions	57 × 28 × 104 mm (2 1/4 × 1 1/8 × 4 1/8 in)
Weight	180 g (6 3/8 oz) (without power cable)

Weight and dimensions are approximate.
 Errors and omissions excepted.
 Subject to change without notice.

Using the Charge Adapter CR-560 Kit (optional)

The Compact Power Adapter CA-560 included with the camera can be used along with the CR-560 Kit for 3 different ways to power the camera or charge battery packs:

1. Charge the BP-500 Series battery packs with power from your car battery.
2. Operate the camera with power from your car battery.
3. Charge BP-500 Series battery packs from a household mains outlet.

Also refer to the CR-560 instructions.

The Charge Adapter/Car Battery Cable Kit CR-560 includes the following:

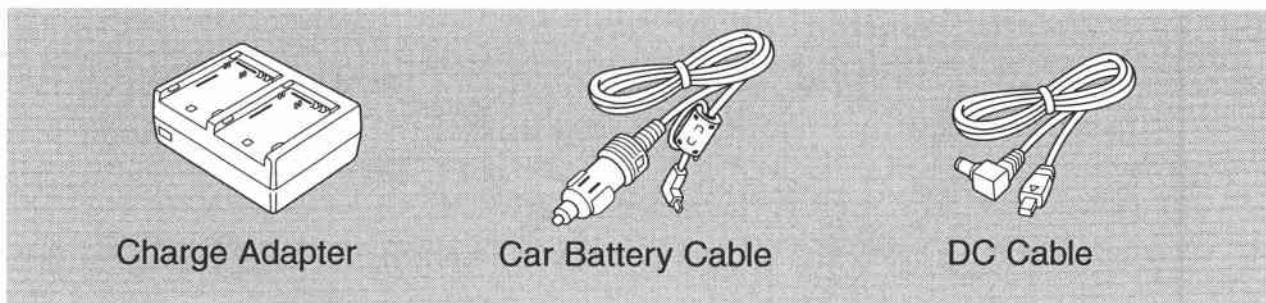

Charge Adapter

Car Battery Cable

DC Cable

1. Charge the BP-500 Series battery packs with power from your car battery.

1 or 2 BP-500 Series battery pack(s) + Charge Adapter + Car Battery Cable → your cigarette lighter

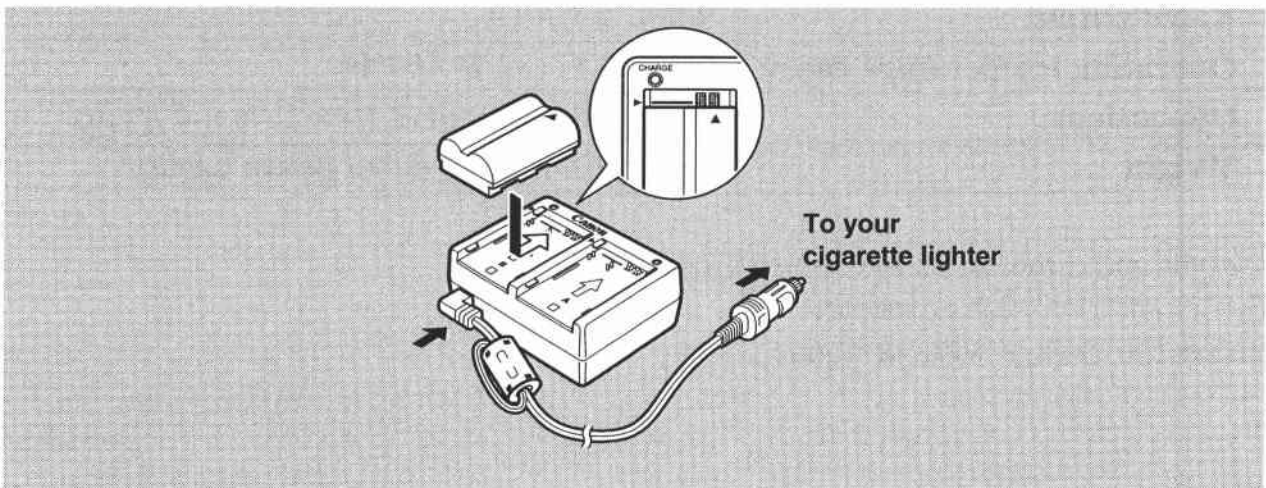

- Fast charging for the high-capacity BP-522 (optional). Fifteen minutes of charging gives 60 minutes of recording (using the viewfinder).

	Time required for full charge from car battery or household outlet
BP-511	1 hr. 20 min.
BP-522 (optional)	1 hr. 40 min.

2. Operate the camera with power from your car battery.

Camera + DC Cable + Charge Adapter + Car Battery Cable → your cigarette lighter

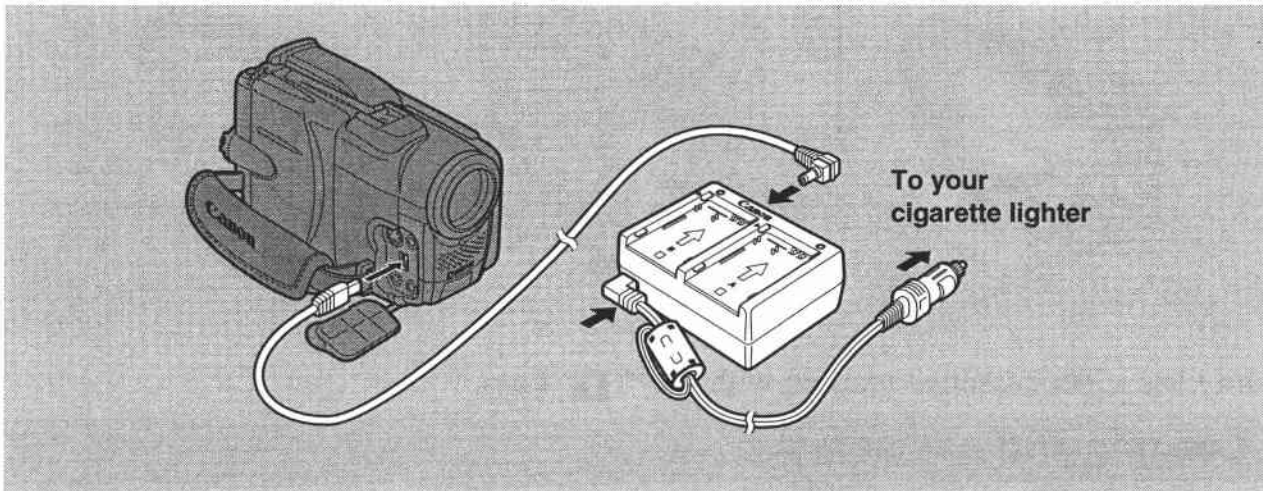

3. Charge battery packs from a household mains outlet.

Charge Adapter + Compact Power Adapter

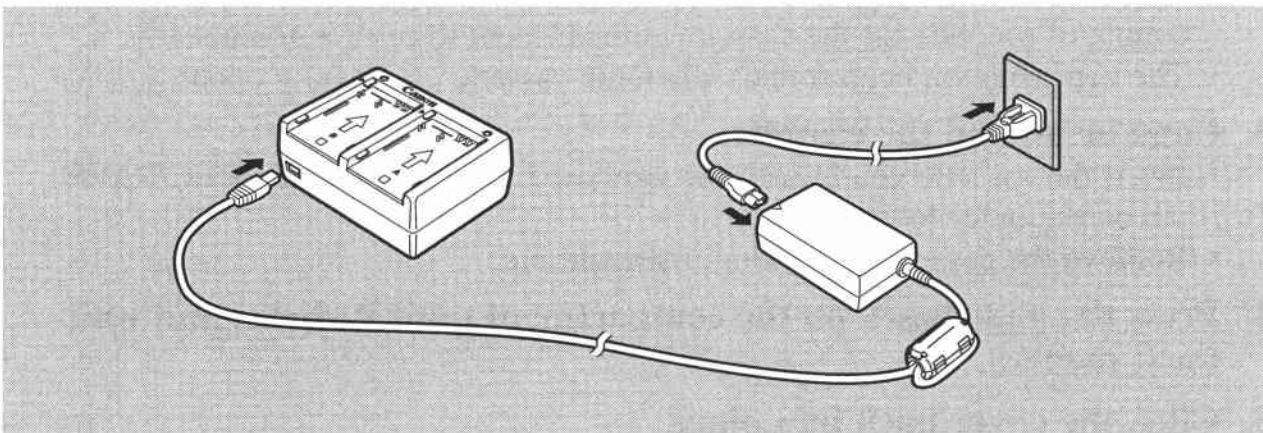

- Fast charging for the high-capacity BP-522 (optional). Fifteen minutes of charging gives 60 minutes of recording (using the viewfinder).

Loading a Cassette

E

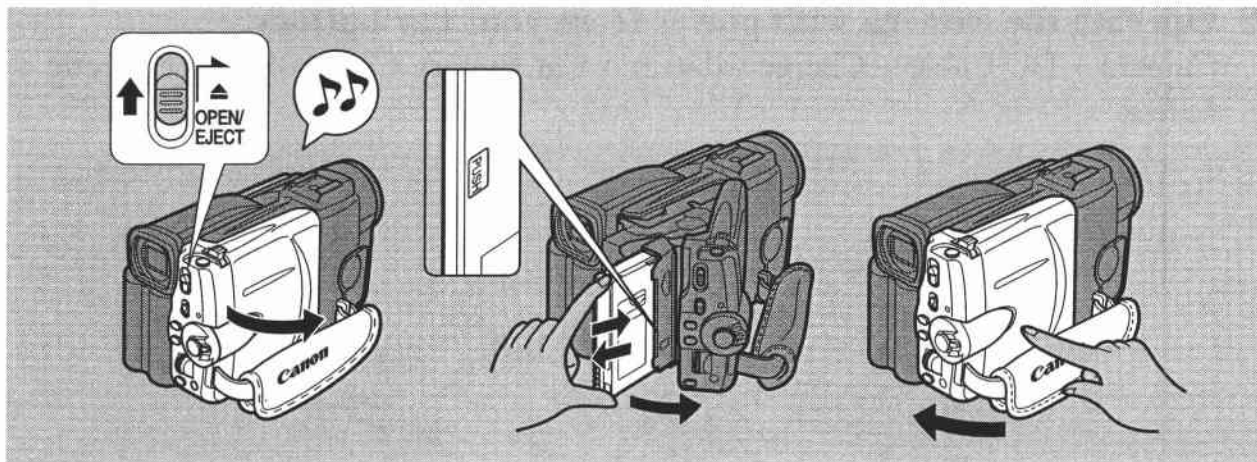

Only use videocassettes marked with the ^{Mini} DV logo.*

Loading and unloading

Quick Overview

1. Make sure that you have attached a power source.
2. Slide the **OPEN / EJECT** ▲ switch upwards to release the cassette compartment cover.
 - Pull the cover fully open (while holding the button upwards) and wait a couple of seconds for the cassette compartment to open automatically.
 - The confirmation beep sounds when the cassette cover fully opens.
3. Load or unload the cassette.
 - Insert the cassette gently with the window facing out, and the REC/SAVE tab on the outer lower corner.
 - Remove the cassette by pulling it straight out.
4. Press the **(PUSH)** mark on the compartment until it clicks, and wait for it to close.
5. Click the cover back into place.

* Mini DV is a trade mark.





- After loading a cassette, use record search (□ 50) to find the point where you want to start recording.
- Do not interfere with the cassette compartment while it is opening or closing automatically, or attempt to close the cover.
- Be careful not to get your fingers caught in the cassette compartment cover.
- Do not leave the cassette in the camera after use — return it to its case and store it in a cool, clean, dry place.
- When you turn the camera's power on, ☒ flashes in the display until you load a cassette.
- With some types of tapes, the remaining tape display may not give an accurate reading (□ 115).

Protecting tapes from accidental erasure

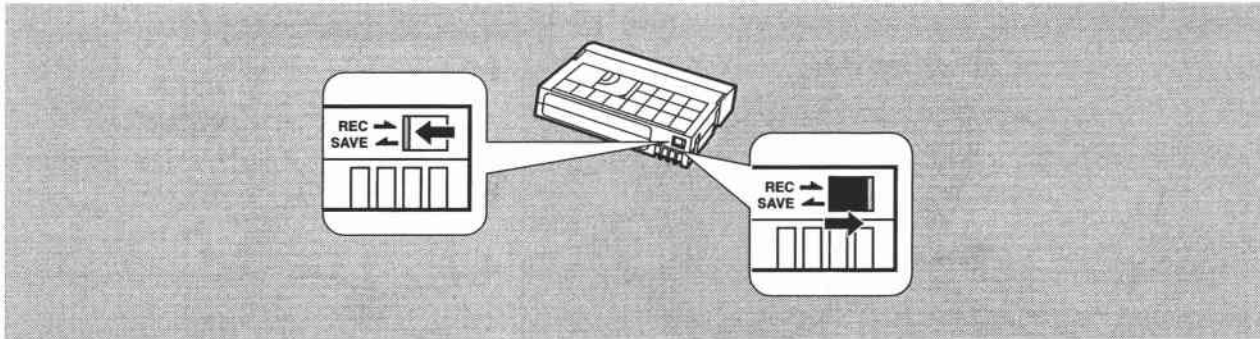
E



To protect your recording from accidental erasure, slide the tab on the cassette so that it exposes the hole. (This switch position is usually labelled SAVE or ERASE OFF.)

If you load this cassette and put the camera in record pause mode ( 16), “THE TAPE IS SET FOR ERASURE PREVENTION” is displayed for approx. four seconds and then the  mark flashes in the display. (The MV30i also shows the above phrase if you accidentally press the REC PAUSE button on the camera or the wireless controller with the camera switched to VCR mode.)

If you want to record on the cassette again, slide the tab back so the hole is closed.

Quick Overview

Handling cassettes

- To protect the tape heads, transfer cassettes directly from the tape case to the camcorder — do not open the tape protect cover or touch the tape itself.
- Do not use cassettes where the tape has been damaged or spliced — they may damage the camcorder.
- Do not insert anything into the small holes on the cassette or cover them with cellophane tape.
- Handle cassettes with care — dropping them or exposing them to external shocks may cause internal damage.
- Store cassettes in the provided case, first rewinding them to the start of the tape and then storing them upright.
- A cassette with metal plated terminals may become dirty with use, affecting information transfer. Therefore, after using a tape about ten times, be sure to clean the terminals with a cotton bud.

Cassette Memory

You are unable to use the cassette memory function with this camcorder.

Basic Recording

E

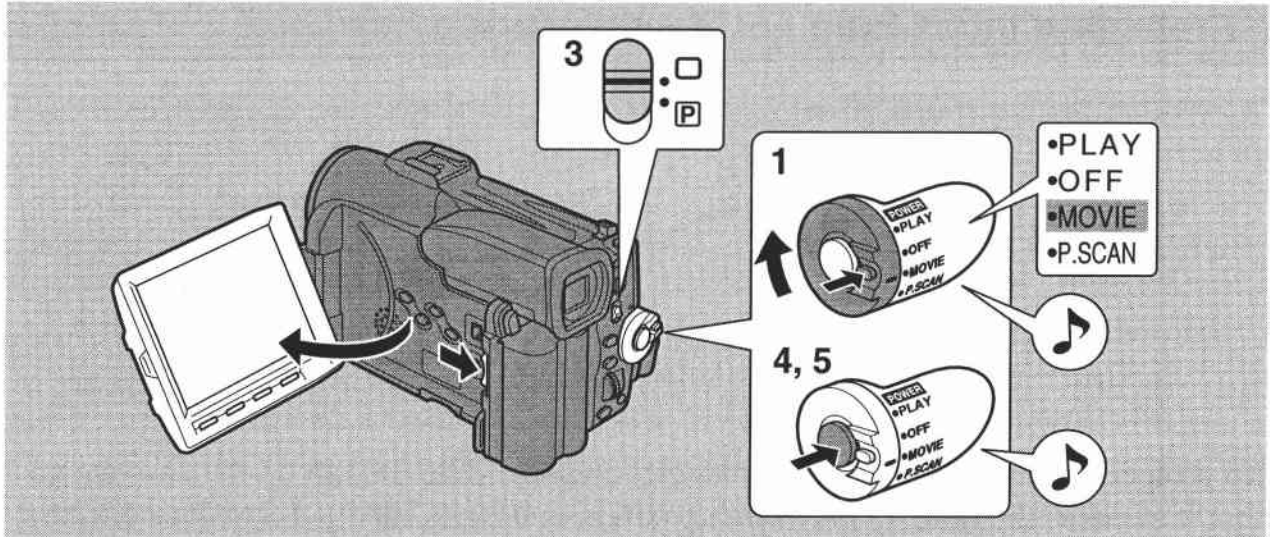

Before you start recording

Have you completed the following steps?

- Attached a power source (9).
- Removed the lens cap and fastened the shoulder strap (98).
- Chosen the display: viewfinder (98) or LCD screen (21)



- When you're using the viewfinder, fully close the LCD or rotate the LCD so that it faces the same direction as the lens (23).
- When using the viewfinder with the BP-522 Battery Pack (optional) attached, extend the viewfinder.



You may also want to install the backup battery (102) in order to set the date and time display (40).

To record

1. Push the small button on the POWER switch and hold, turn the POWER switch to MOVIE.

- The camera automatically sets to record pause mode. PAUSE appears in the display.
- The camera power indicator lights up.
- The confirmation beep sounds.
- The camera will turn itself off if you leave it in record pause mode for more than about five minutes. To return to record pause mode, set the POWER switch to OFF and then back to MOVIE.

2. Load a cassette (14).

3. **Slide the program selector to .**
 - This selects the camera's Easy Recording program. It allows you to simply point and shoot without making any manual adjustments ( 53).
4. **Press and release the start/stop button once to begin recording.**
 - The tally lamp flashes and REC appears in the display.
 - To take still photographs, see p.45.
5. **Press and release the start/stop button again to pause recording.**
 - The camera returns to record pause mode and PAUSE reappears in the display.
 - You can stop and restart recording as often as you like by pressing the start/stop button.





- After loading a cassette, start recording when the tape counter has stopped.

When you have finished recording

- Replace the lens cap.
- Return the viewfinder to its retracted position.
- Return the LCD screen flush to the camera body.
- Unload the cassette.
- Set the POWER switch to OFF.
- Disconnect the power source.



- To check that the camera is recording correctly, make a test recording first.
- Before making important recordings, clean the video heads using a Canon DVM-CL Digital Video Head Cleaning Cassette or a commercially available digital video head cleaning cassette.
- To close the LCD panel, rotate it vertically until the screen faces you, then push it in flat against the side of the camera until it clicks securely.
- You cannot monitor the sound from the speaker when recording.
- For tips on how to make better videos, see p. 31.
- For extra recording time, set REC MODE in the camera menu to LP ( 18).
- The flashing of the tally lamp may be reflected into the lens during close-up recording, or when recording through glass. You may therefore decide to turn it off ( 39).

Changing the recording mode (SP/LP)

You can record and play back a tape in SP (standard play) and LP (long play) modes. LP extends tape usage by 1.5 times.

To switch to LP mode, select REC MODE from the camera (or VCR (MV30i)) menu, select LP and then close the menu (for instructions on how to use the menus, see p. 34).

You can't add sound (audio dubbing) or images (A/V insert: MV30i only) to a tape that has been recorded in LP mode. If you plan to use either of these functions later, record in SP mode.



▶REC MODE.....SP



- When recording and playing back tapes in LP mode, the nature of the tape and usage conditions may affect recording, mosaic-like noise may appear in the image and the sound may be distorted during playback of tapes recorded in LP mode. For important recordings, therefore, set the camera to SP mode.
- If you record in both modes on the same tape, the picture may become distorted during playback and the time code may not be written correctly.
- A tape recorded in LP mode on other digital equipment may produce mosaic-like noise and the sound may become distorted when played back on this camcorder, and vice versa.

16:9 (Widescreen TV recording)

Produces images in the 16:9 format for playback on widescreen TVs.



▶16:9.....OFF

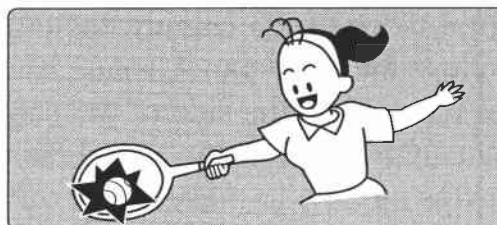

1. Select 16:9 from the camera menu and turn it ON/OFF.
2. Press the MENU button once more to close the menu.



- "16:9" is shown in the display when you switch the 16:9 effect on.
- You cannot use the 16:9 digital effect with the Easy Recording program.
- If you play back a recording made for 16:9 on a normal TV screen, the image will appear to be vertically "squashed" (compressed).

Confirmation/Warning beeps

E

- The camera's short operation confirmation beeps are indicated by  in the illustrations. Beeps sound upon certain camera operations such as when you turn the camera on, during the self-timer countdown, right before the camera's automatic shut-off, and also upon any unusual condition of the camera. Beeps are not recorded on the tape. You can turn them OFF through the menu.



MENU

( 34, 35)

▶BEEP.....ON

Demonstration mode

To see a demonstration of the camera's main features, before loading the cassette, go to the DEMO MODE option in the camera menu. Select the ON setting and close the menu. The demo also starts automatically if the power has been on for 5 minutes without a cassette loaded into the cassette compartment. (You can avoid this by turning the DEMO MODE to OFF through the camera menu.) To cancel the demo mode once it has begun: press any button other than the ones below the LCD screen, turn off the power, or load a cassette.

Quick Overview



MENU

( 34)

▶DEMO MODE...OFF

Zooming

E

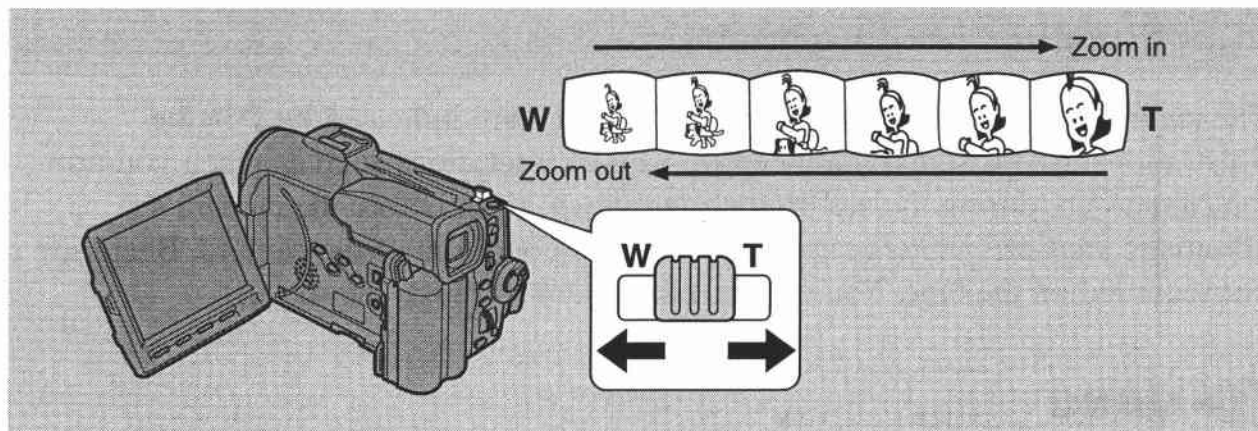

12× optical zoom

The camera's 12× zoom lens allows you to choose the best picture angle for each scene:

- Move the zoom control towards W to zoom out to wide-angle.
- Move it towards T to zoom in to telephoto.

You can also control the speed of zooming:

- Move the control slightly to zoom slowly.
- Move it farther to zoom more quickly. (The farther you move the zoom control, the faster the zoom speed.)

The T and W buttons on the wireless controller adjust the picture angle, but not the zoom speed.

48× digital zoom

Turn the digital zoom on by choosing D.ZOOM from the camera menu, to magnify the camera's zoom range by 4×.



▶D.ZOOM.....ON

The zoom control continues to work as usual. You can freely zoom in and out between 1× and 48× magnification — the camera automatically switches between optical zooming (up to 12×) and digital zooming (12× to 48×). A zoom bar shows up in the display. The digital zoom area is in blue.



- When zooming, as a rule, keep at least 1 m (3 ft 3³/₈ in) between you and your subject. However when the zoom is at the wide-angle position, you can focus on a subject as close as 1 cm (³/₈ in).
- Image resolution is slightly lower when the magnification is greater than 12×.
- You cannot use the digital zoom with the multi-image screen.
- When digital zoom is turned off, the zoom bar shortens to optical zoom length.

Using the LCD Screen

Open the LCD screen

Push the LCD panel open button and open the panel by pulling it away from the camera. This automatically switches the LCD screen on and the viewfinder off. When you close the LCD panel, the LCD screen automatically switches off and the viewfinder switches back on.

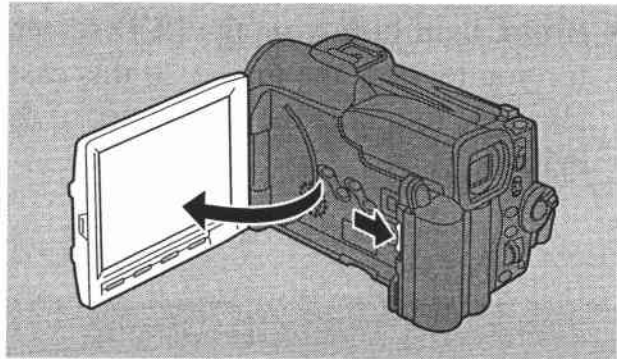

E

Quick Overview

Changing the angle of the LCD screen

You can choose the angle of the screen that suits you best by opening and rotating the screen, also you can rotate the LCD screen so that faces in the direction of the lens (23).

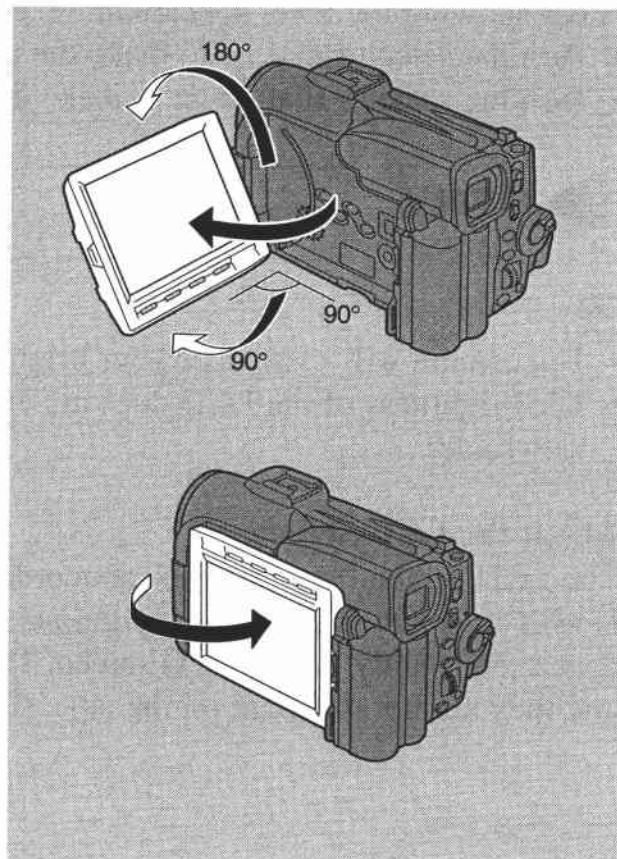

You can also push the panel flat against the camera until it is flush with the side, with the screen facing outwards.



- Avoid touching the LCD screen when moving the LCD panel.
- Do not hold the camera by the LCD panel or the viewfinder.
- Make sure you open the LCD panel at 90°, before attempting to rotate it.
- Always rotate the LCD panel vertically into place, before closing it or pushing it flat against the side of the camera.
- Always fully close the LCD panel until it clicks securely.

- Be careful not to leave the LCD, viewfinder or lens exposed to direct sunlight outdoors or in a window. Doing so could cause damage.
- Bright light falling on the LCD screen may cause glare that makes it difficult for you to view the image. In this case, switch to using the viewfinder. You are also able to adjust the brightness of the screen (see “Adjusting the LCD screen” below).

Adjusting the LCD screen

You can adjust the brightness of the LCD screen. Adjust the level by choosing BRIGHTNESS from the menu.

A bar showing the level appears in the display for 4 seconds.

- Turn the selector dial up to make the display brighter.
- Turn the selector dial down to make the display darker.



- The camera will remember your brightness setting even after you turn it off.
- The brightness of the LCD does not effect that of the recorded images or the viewfinder.

About the LCD Screen

The LCD screen built into this camcorder is a high precision product.

However, small black dots or bright points of light (red, blue or green) may appear constantly on the LCD screen. This is not a malfunction of the LCD screen and they are not recorded on the tape. (Effective dots: more than 99.99%)

Allowing the subject to monitor recording

E

When you turn the LCD panel so that it faces the same direction as the lens, you can watch yourself during recording or let your subject monitor recording. The viewfinder is also activated when the panel is in this position.

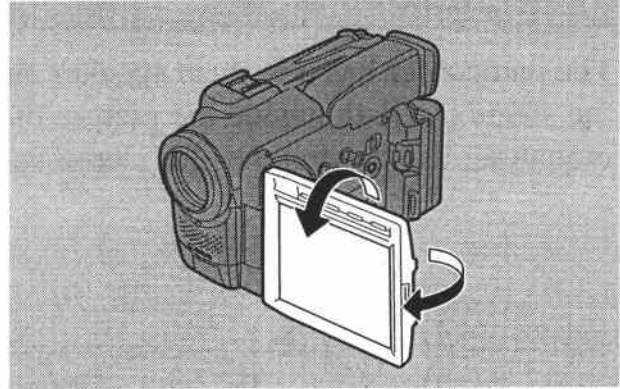

- You can choose the display style, reversed (mirror on) or not (mirror off). The recording itself is unaffected regardless of which one you choose.



1. Open the camera menu and point the arrow at MIRROR.
2. Select the OFF setting and close the menu.

Quick Overview

Indicators that appear when “mirror” is selected:

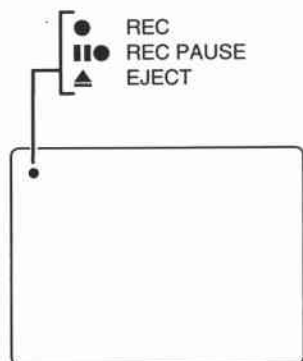

- These and all other indicators appear normally in the viewfinder.

E

Built-in speaker and headphone terminal

The camcorder has a built-in speaker and a headphone terminal so you can review the sound track alongside the picture during playback. The built-in speaker is monaural; use headphones for stereo sound.

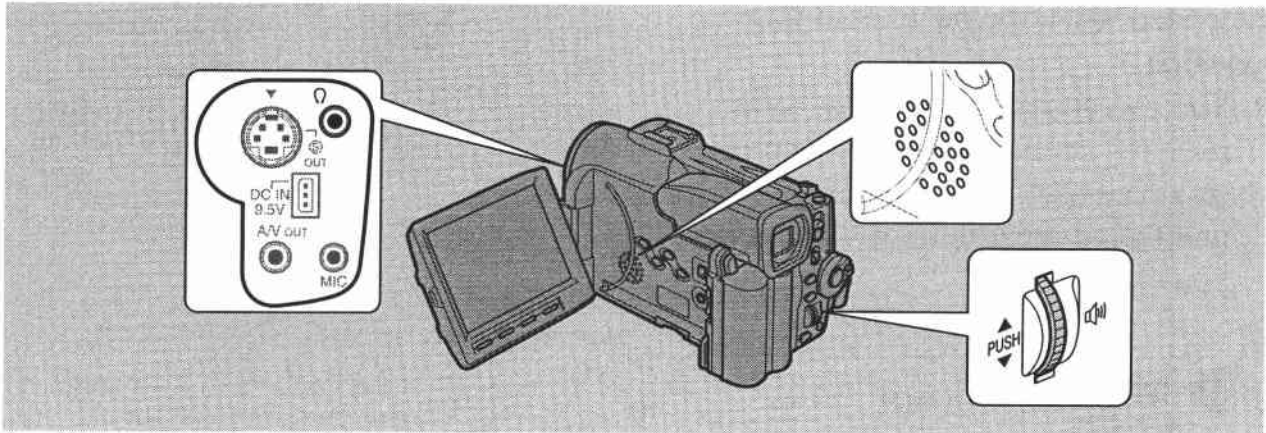

Quick Overview

Adjust the speaker and headphone volume by turning the selector dial.

- Turn the selector dial up to increase the volume, and down to lower the volume.
- A VOLUME bar appears in the display to indicate the current volume. It disappears in four seconds.
- You can turn off the volume completely by turning the selector dial down until OFF appears.
- You can also adjust the headphone volume separately from the built-in speaker, either during PLAY (MV30i: VCR) mode or camera mode. The volume level is the same regardless of mode.
- The levels you adjust for the built-in speaker and headphones are memorized separately. The camera remembers your levels even if you turn the camera off and back on again.



- The speaker turns off when the camera is set to camera mode or when you use headphones.
- Sometimes audio may sound distorted when the volume is turned up high. If this happens, turn down the volume.

Playing Back a Cassette

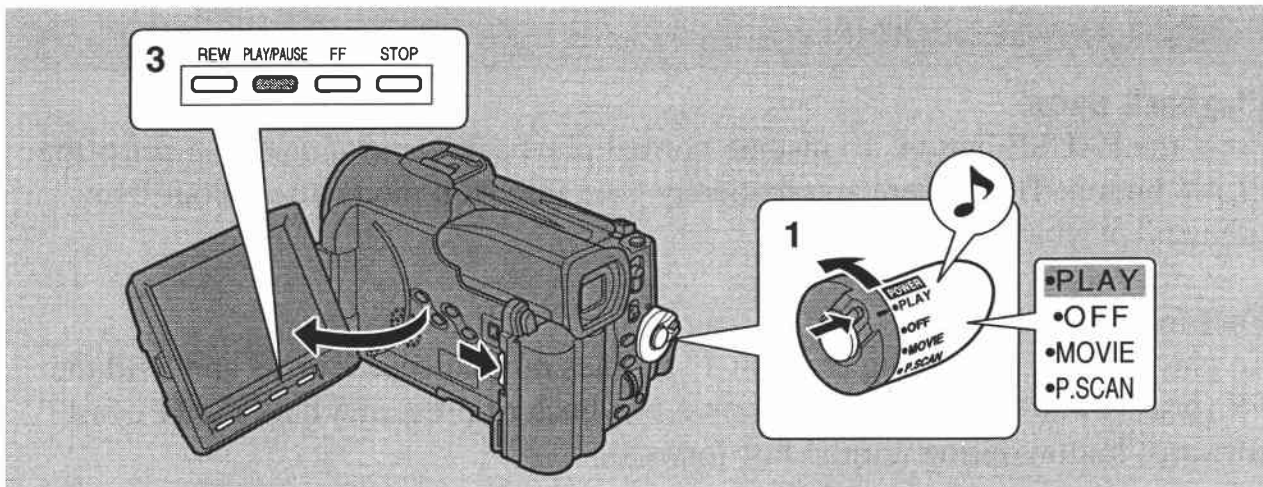

You can use the LCD screen for instant, on-the-spot playback. The camera also plays back the sound track via the built-in speaker ( 24).

- When you play back a tape, you can also close the LCD panel with its screen side facing up.
- When you're using the viewfinder to view playback, close the LCD panel.

To play back your recordings on a TV, see p. 28.

To use the wireless controller, see p. 37.



- To avoid accidental recording, make sure that you slide the tab on the cassette so that it exposes the hole (the switch position is usually labelled SAVE or ERASE OFF).

1. Attach a power source and turn the POWER switch to PLAY (MV30i: VCR).

- The power indicator lights up.

2. Load the cassette.

3. Press the PLAY button to start playback.

- To end playback, press the STOP button.
- To wind the tape forwards, stop playback and press the FF (fast forward) button.
- To wind the tape backwards, stop playback and press the REW (rewind) button.
- If the playback picture is rough (mosaic-like noise), clean the video heads using a Canon DVM-CL Digital Video Head Cleaning Cassette or a commercially available digital video head cleaning cassette.

Other playback modes

Playback pause

Press the PAUSE button. To resume normal playback, press it again, or press the PLAY button. The camera automatically goes into stop mode after about five minutes' playback pause.

Fast forward playback

To play back the recording at about 11.5 times normal speed, press and hold the FF (fast forward) button during normal playback or press and hold the FF (fast forward) button during normal fast forward.

Rewind playback

For reverse playback at about 11.5 times normal speed, press and hold the REW (rewind) button during normal playback or press and hold the REW (rewind) button during normal rewind.

Special playback

These can only be operated from the wireless controller (37).

Frame Advance

To play back frame by frame, press the +/ **▶▶▶** button repeatedly during playback pause. Press and hold to play back continuous frame advance.

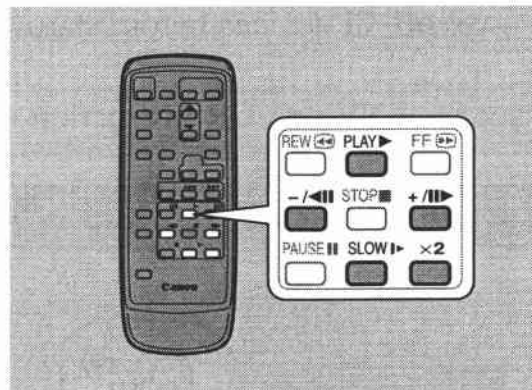

Frame Reverse

To play back in reverse frame by frame, press the -/ **◀◀◀** button repeatedly during playback pause. Press and hold to play back continuous frame reverse.

Slow Forward Playback

To play back at about 1/5 normal speed, press the SLOW **▶** button during normal playback.

Press the PLAY **▶** button to return to normal playback.

- The camera automatically returns to playback after about 30 seconds of slow playback.

Slow Reverse Playback

To play back in reverse at about 1/5 normal speed, press the -/ **◀◀◀** button and then the SLOW **▶** button during normal playback.

Press PLAY **▶** to return to normal playback.

- The camera automatically returns to $\times 1$ reverse playback after about 30 seconds of slow playback.

Reverse Playback

To play back in reverse at normal speed, press the -/ **◀◀◀** button during normal forward playback.

Press the PLAY **▶** button to return to normal forward playback.

Forward $\times 2$ Playback

Press the $\times 2$ button during normal playback.

Press the PLAY **▶** button to return to normal playback.

Reverse $\times 2$ Playback

Press the -/ **◀◀◀** button and then the $\times 2$ button during normal playback.

Press the PLAY **▶** button to return to normal playback.



- Mosaic-like noise appears on the screen during some of the special playback modes.
- There's no audio during special playback.

Connections for Playback on a TV Screen

E

You can connect the camera to a TV or VCR in order to play back your recordings. You will need to attach a power source to the camera ( 9). Power off all devices before starting the connections.

See your TV or VCR instruction manual for further details.

If your TV (or VCR) has a SCART terminal (without S (S1)-video)

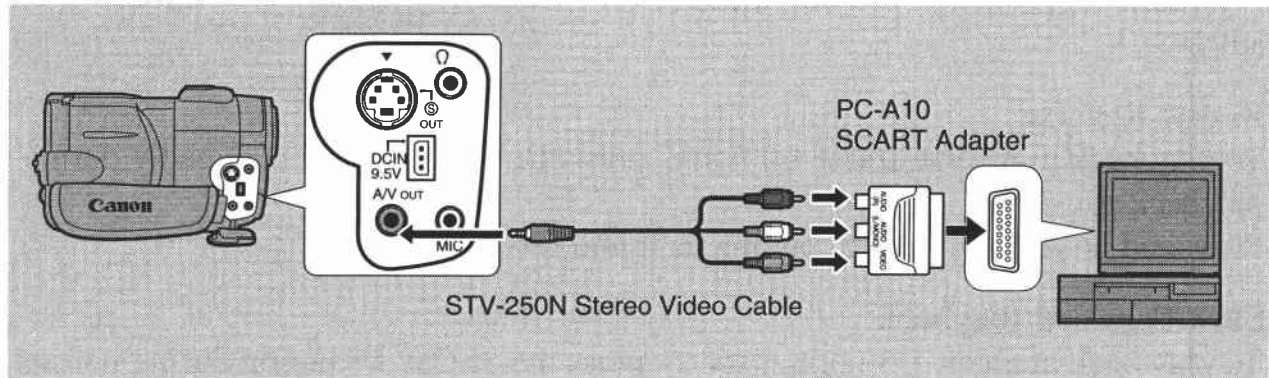

Quick Overview

- Connect the PC-A10 SCART adapter to the TV or VCR's SCART terminal.
- Connect the camera to the adapter. Connect the camera using the STV-250N Stereo Video Cable. Connect the white plug to the white audio terminal **L** (left). Connect the red plug to the red audio terminal **R** (right). Connect the yellow plug to the yellow video terminal **VIDEO**.
- Set the TV/VIDEO selector on the television to VIDEO.
- If you are connecting the camera to a VCR, set the input selector on the VCR to LINE.

If your TV (or VCR) has an S (S1) -video input terminal

E

For higher picture quality, we recommend playing back recordings on a TV with an S (S1) terminal.

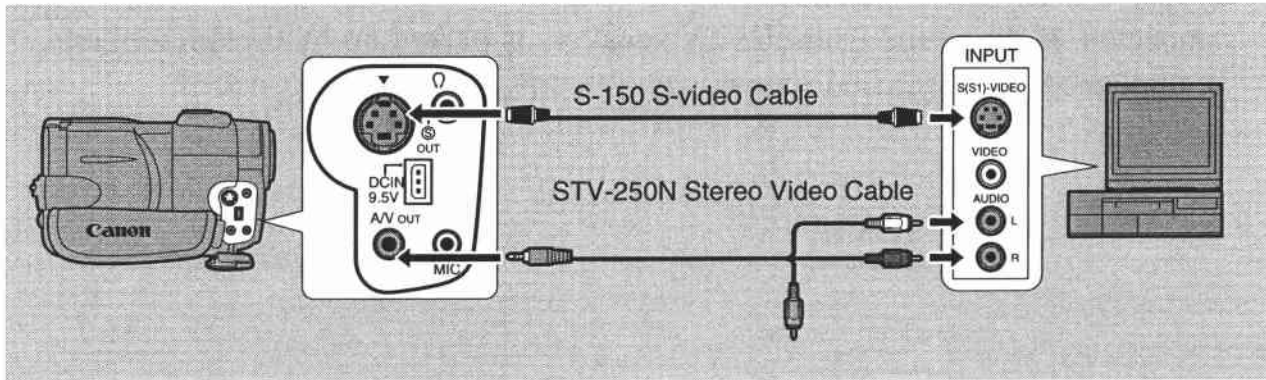

- Use the S-150 S-video Cable to connect the S-video terminals. Use the STV-250N Stereo Video Cable to connect the AUDIO terminals. Connect the white plug to the white AUDIO terminal **L** (left). Connect the red plug to the red AUDIO terminal **R** (right). Do not connect the yellow plug.
- Set the TV/VIDEO selector on the television to VIDEO.
- If you are connecting the camera to a VCR, set the input selector on the VCR to LINE.

Quick Overview

If your TV (or VCR) has audio/video input terminals

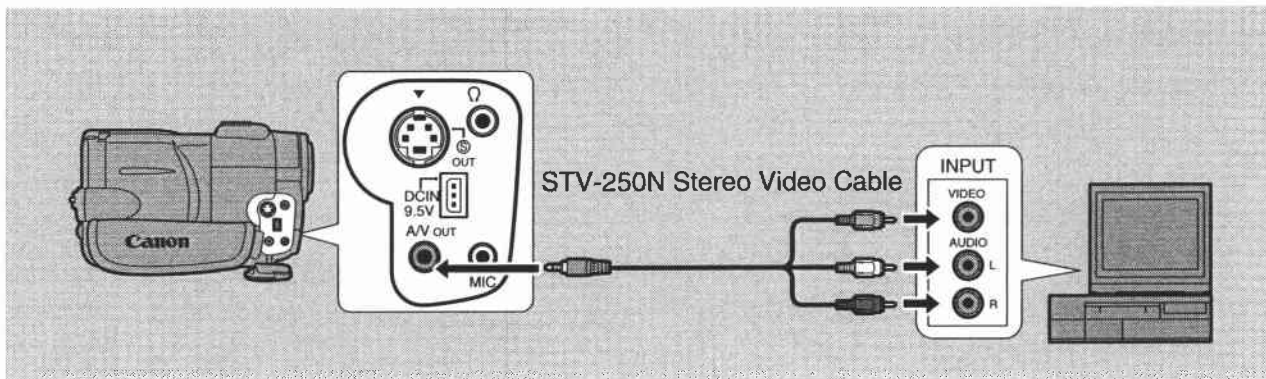

- Connect the camera using the STV-250N Stereo Video Cable. Connect the white plug to the white audio terminal **L** (left). Connect the red plug to the red audio terminal **R** (right). Connect the yellow plug to the yellow video terminal **VIDEO**.
- Set the TV/VIDEO selector on the television to VIDEO.
- If you are connecting the camera to a VCR, set the input selector on the VCR to LINE.

E



- If you are going to use the TV as a monitor while you are shooting, remember to keep the TV volume turned down as long as the camera's audio terminals are connected. If the sound from the TV speakers is picked up by the microphone, an unpleasant high-pitched squeal, called feedback, may be produced.

Tips for Making Better Videos

Holding the camera

- For maximum stability, grip the camera in your right hand and keep your right elbow pressed against your body.
- If necessary support the camera with your left hand. With practice, you will be able to operate the controls by touch, without taking your eye off the action.

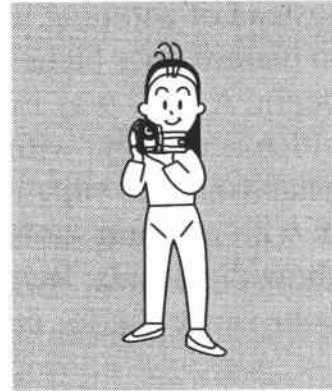

Using a tripod

To prevent any unwanted movement, you can mount the camera on a tripod, (or any flat surface at a suitable height) and operate it with the wireless controller.

- When you are using a tripod, be careful not to leave the viewfinder exposed to bright sunlight or it may melt. (The light is concentrated by the viewfinder lens.)
- Make sure that the fastening screw of the tripod is no longer than 5.5 mm (1/4 inch), or it will damage the camera.

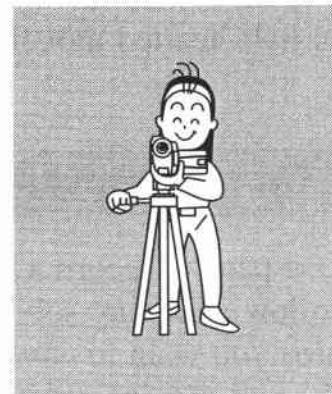

Quick Overview

Composition

The most important element in the scene does not have to be in the centre. For a more interesting picture, try to position your subject so it is slightly to one side. Leave some space on the side of the frame that the subject is facing or moving towards.

Don't cut off the top of the subject's head, and don't cut people off at the neck, hips or knees (move a little bit above or below).

Watch out for distracting objects in the background.

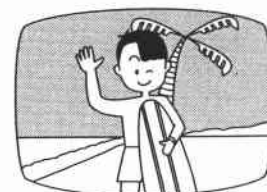
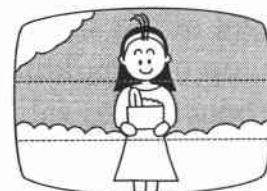

E**Picture angle**

Instead of zooming while recording, try to choose your picture angle before you begin. A good way to tell a story with video is to begin with a long shot that establishes the situation, and then move in with medium shots and close-ups to show the details. Remember to change your viewpoint for each shot.



Long shot



Medium shot



Close-up

Remember that any camera movement or change in picture angle should have a definite purpose. Avoid unnecessary or half-hearted movements.

Quick Overview**Camera moves**

Use pans to record a landscape or follow a moving subject. Decide the area you want to cover and stand facing the end of your panning angle. Without moving your feet, turn your waist to the starting position. Start recording, and after a few seconds begin to turn slowly from the waist. Hold the final image for a few seconds before you stop recording.

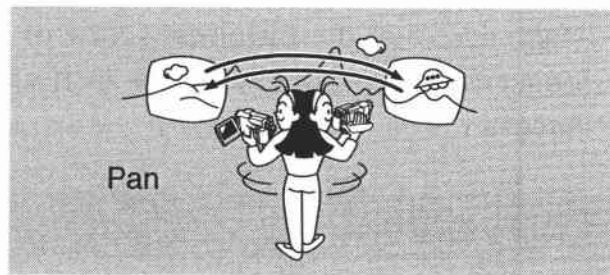

Pan

Tilt the camera up to exaggerate the height of the subject. Tilt down from the top of a building, for example, as an introduction to subjects at the bottom.

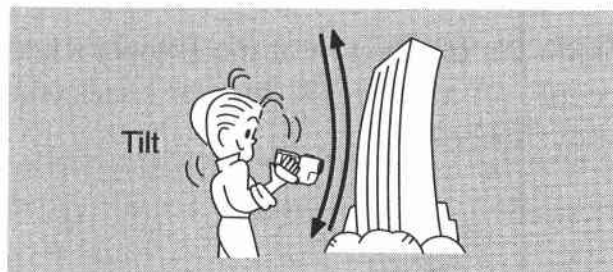

Tilt

Turning the Optical Image Stabilizer Off

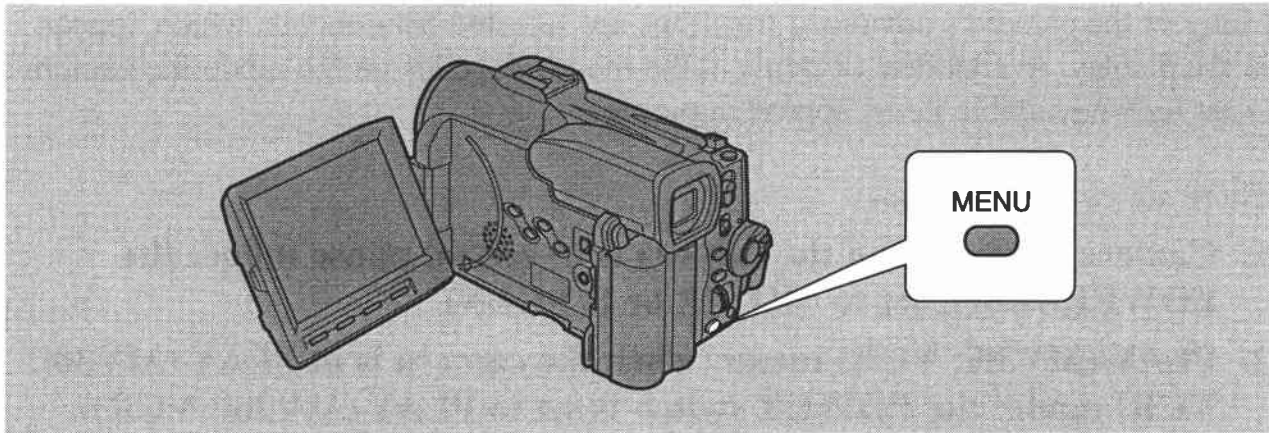

E

With most camcorders, even the slightest hand movements will be noticeable during telephoto recording. However, the MV30/MV30i's Optical Image Stabilizer allows you to obtain steady recordings even at high magnification. Unlike electronic image stabilizers, it causes no loss of picture quality. The Optical Image Stabilizer can compensate for a wide range of camera movement — you can record stable images even if you are shooting from a moving car.



1. To turn the Optical Image Stabilizer off, open the camera menu and point the arrow at **IMAGE S. (()))**.
2. Select the **OFF** setting and close the menu.
 - The (())) mark disappears from the display when the stabilizer is off.
 - The image stabilizer cannot be turned off when the program selector is set to the (Easy Recording) position.



- The image stabilizer is designed to deal with a normal degree of camera shake.
- Keep the image stabilizer turned off when the camera is mounted on a tripod.
- The image stabilizer is not as effective as usual when the tele-converter (optional) is attached.

Using the Full
Range of Features

Selecting from the Menus

E

Many of the camera's advanced functions are selected from menus which appear in the display. Availability of items in the menu depends on the mode the camera is set to. Unavailable items appear in purple.

There are two main menus:

1. **Camera menu (when the camera is in record pause mode: the POWER switch set to MOVIE or P. SCAN)**
2. **PLAY (MV30i: VCR) menu (when the camera is in PLAY (MV30i: VCR) mode: the POWER switch is set to PLAY (MV30i: VCR))**

Camera menu (CAM. MENU)

①	Shutter speed.....	68
②	Digital zoom	20
③	Image stabilizer.....	33
④	16:9 effect	18
⑤	White balance	71
⑥	Self-timer	65
⑦	Wireless controller.....	38
⑧	Tally lamp	39
⑨	Record mode.....	18
⑩	Beep	19
⑪	Wind screen	64
⑫	Audio mode	63
⑬	Brightness	22
⑭	Mirror mode.....	23
⑮	TV Screen	115
⑯	Demo mode.....	19
⑰	Date/time display	42
⑱	Time zone/ Daylight saving time.....	40
⑲	Date/time set	42

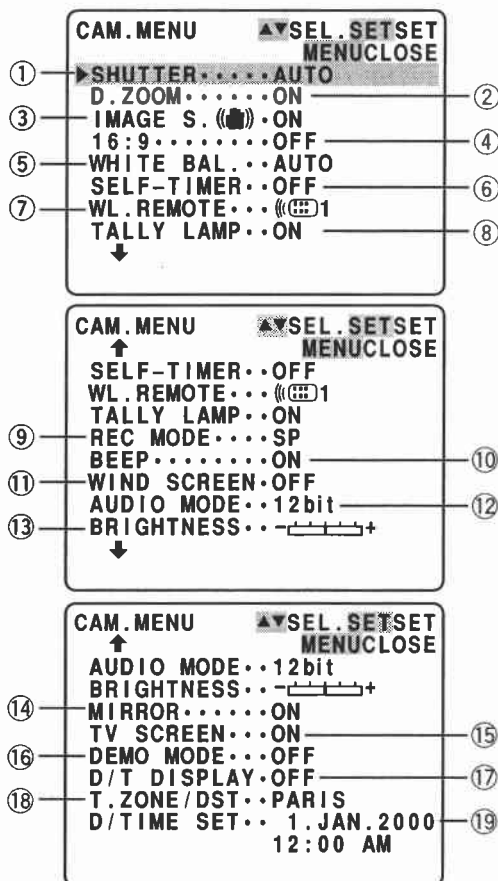

Using the Full Range of Features

PLAY (MV30i: VCR) menu

- ① To dub mode 78
- ② To recorder set up 80
- ③ Wireless controller 38
- ④ Record mode (MV30i only) . 18
- ⑤ Data code 74
- ⑥ Date/time select 73
- ⑦ Brightness 22
- ⑧ Displays 115
- ⑨ 6-second auto date 75
- ⑩ Output channel 97
- ⑪ Wind screen 64
- ⑫ Beep 19

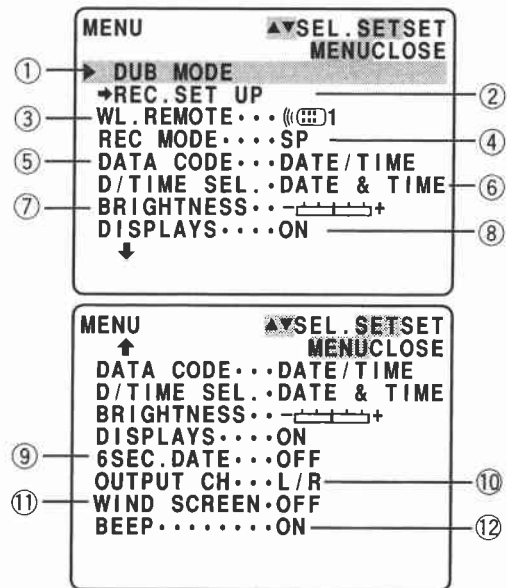

Turn to the appropriate page for a detailed explanation of each function.

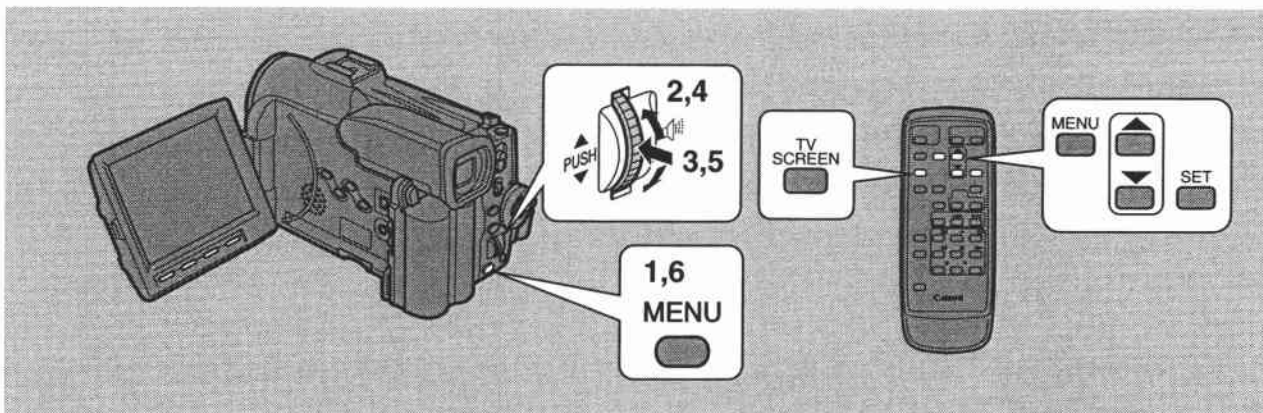

1. Press the **MENU** button to open the menu.
2. Turn the selector dial to move the arrow up or down the display.
3. Press the selector dial in to select your chosen option from the menu.
 - Your selected option remains on the screen and all other options are removed.
4. Turn the selector dial up or down to choose its setting.
5. Press the selector dial in.
 - However, if you are setting anything other than the white balance or the shutter speed, you can skip this step.

6. Press the MENU button to close the menu.









- You can only see eight options on the screen at one time. Pointers at the top/bottom of the screen indicate that there are more options that you can scroll through.
- You may often find it convenient to use the wireless controller to move around the menus. Press its MENU button to enter/leave the menu and use the arrow keys in place of turning the selector dial. Push the SET button to select.
- Pressing the start/stop button or the PHOTO button will close the menu and start recording.
- You can display the menus on a connected TV screen by turning TV SCREEN on through the camera menu or using the wireless controller's TV SCREEN button. See p. 28 for TV hookup instructions.

Using the Wireless Controller/Tally Lamp

The supplied wireless controller can operate the camera from a distance of up to 5 m (16 feet). Point it at the camera's remote sensor while you press the buttons.

The tally lamp lights up to let you know that the camera is in range and responding to your commands.

There are six functions that cannot be operated without the wireless controller:

- Special playback ( 27)
- Photo/date search ( 76)
- Zero set memory ( 77)
- Audio mix ( 96)
- A/V insert ( 90: MV30i only)
- Audio dubbing ( 93)

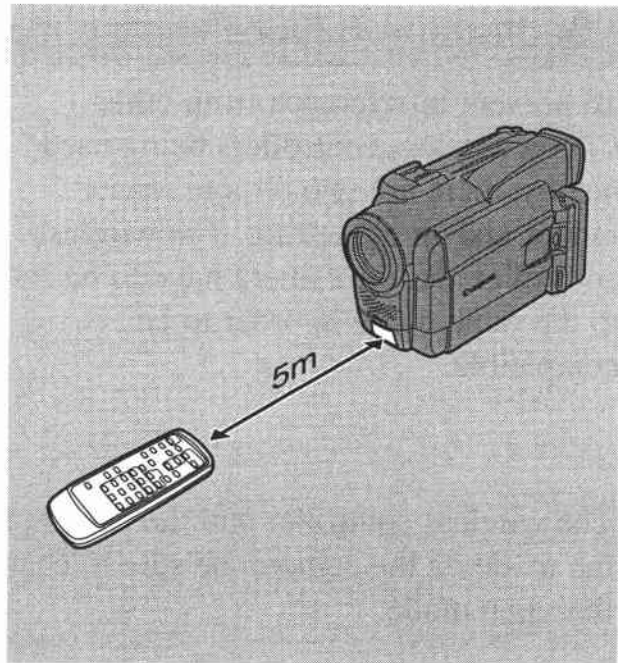

E

Inserting batteries

Insert two AA batteries, following the \oplus and \ominus markings. Be careful not to reverse the polarity of the batteries.

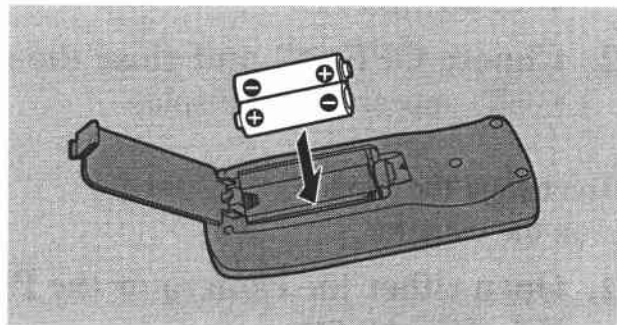

Using the Full
Range of Features



- When using the wireless controller in brightly lit places or outdoors, the effective range will be less.
- The camera may have difficulty picking up the remote control signals at extremely close range.
- Do not leave the controller exposed to direct sunlight, or in hot or humid places.
- When the batteries run out, replace them both together.
- If the wireless controller doesn't work, see p. 39 Notes.

Setting the remote sensor mode

To prevent interference from other Canon wireless controllers being used nearby, there are two remote sensor modes and an off setting. The wireless controller and the camera have to be set to the same mode in order to be compatible.

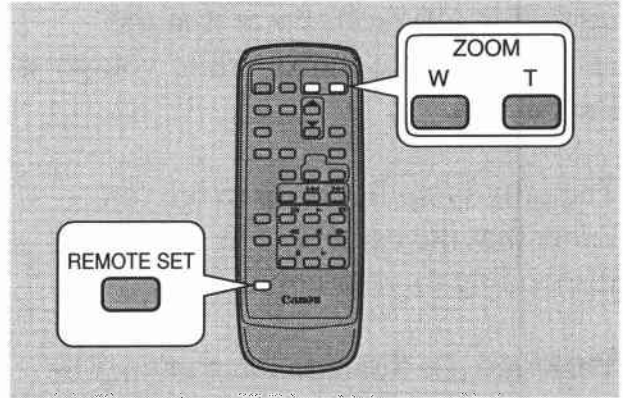

The wireless controller and the camera have been preset to mode 1. If you change the mode on the camera, be sure to change the mode on the wireless controller to the same mode.

MENU
(34, 35)

▶WL. REMOTE... 1

1 : Mode 1
2 : Mode 2
OFF : Sensor off

To turn the remote sensor off:

1. Open either the camera or the **PLAY (MV30i: VCR)** menu and select **WL. REMOTE**.
2. Choose **OFF** and close the menu.
 - OFF appears in the display.

To change the mode...
...on the camera:

1. Open either the camera or the **PLAY (MV30i: VCR)** menu and select **WL. REMOTE**.
2. Choose 1 or 2 and close the menu.
 - The selected mode will appear on the display for four seconds.

...on the wireless controller:

Press and hold the REMOTE SET button on the wireless controller. Simultaneously press the ZOOM W button for mode 1 or the ZOOM T button for mode 2. Continue to press simultaneously for over two seconds.

- Be sure to set the wireless controller to the same mode as the camera.

If your wireless controller isn't working:

Make sure the camera and the wireless controller are both set to the same mode. Check the mode the camera is set to by pushing any button other than the REMOTE SET button on the wireless controller. The camera's mode appears in purple for about four seconds. Set the wireless controller's mode accordingly by pressing the aforementioned button combinations. If the wireless controller still doesn't work, change the batteries.



- The mode the camera is set to also appears for four seconds when you turn the power on.

Turning off the tally lamp

The tally lamp lets you know that the camera is recording. However, its flashing may be reflected into the lens during close-up recording, or when recording through glass.

You may therefore decide to turn it off.



MENU

(34)

▶ TALLY LAMP · · ON

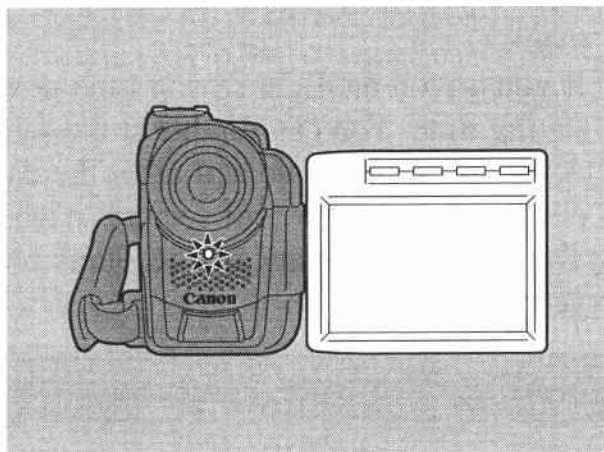

1. Open the camera menu, and point the arrow at TALLY LAMP.

2. Select the OFF setting and close the menu.

- The tally lamp no longer flashes during recording, but it will still light up when the camera receives a signal from the wireless controller.

Setting the Date and Time

E

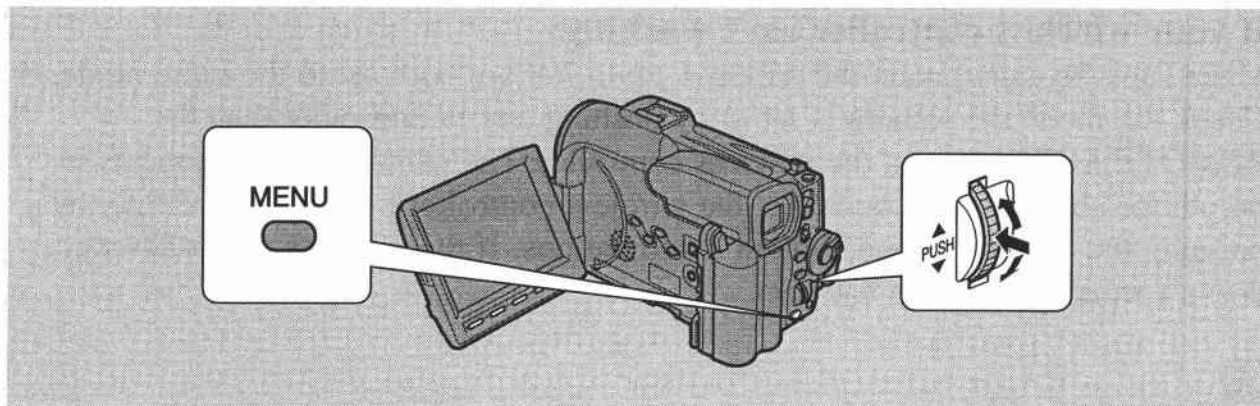

The date and/or time display forms part of the data code. You can choose to display or hide it during playback (73).

Set the date and time display when you first start using your camera. Install the backup battery before you begin (102).

- Before you start setting the date and time, select your home time zone from the menu.
- If you are on daylight saving time now, you should set the camera to daylight saving time. You can do this at the same time you select your home time zone.
- After you set the date and time, the date/time and home time zone will be displayed for about four seconds each time you turn the power on.
- The camera automatically accounts for the number of days in a month and leap year.

Setting the time zone/daylight saving time

MENU
(34)

T. ZONE/DST •• PARIS

- 1. Set the camera to record pause mode.**
 - PAUSE appears in the display.
- 2. Open the menu and move the arrow to T. ZONE/DST with the selector dial.**
- 3. Press the selector dial in.**
 - The time zone display appears on the screen.
 - Your camcorder's time zone is factory-preset to Paris. If you are at another time zone, select your time zone first and daylight saving time (DST) setting if necessary.
- 4. Move up or down the list of time zones by turning the selector dial. Press the selector dial in to select the option that represents your time zone.**
 - If you are now in daylight saving time, select the time zone with the daylight saving time mark next to the area.
- 5. Press the MENU button.**

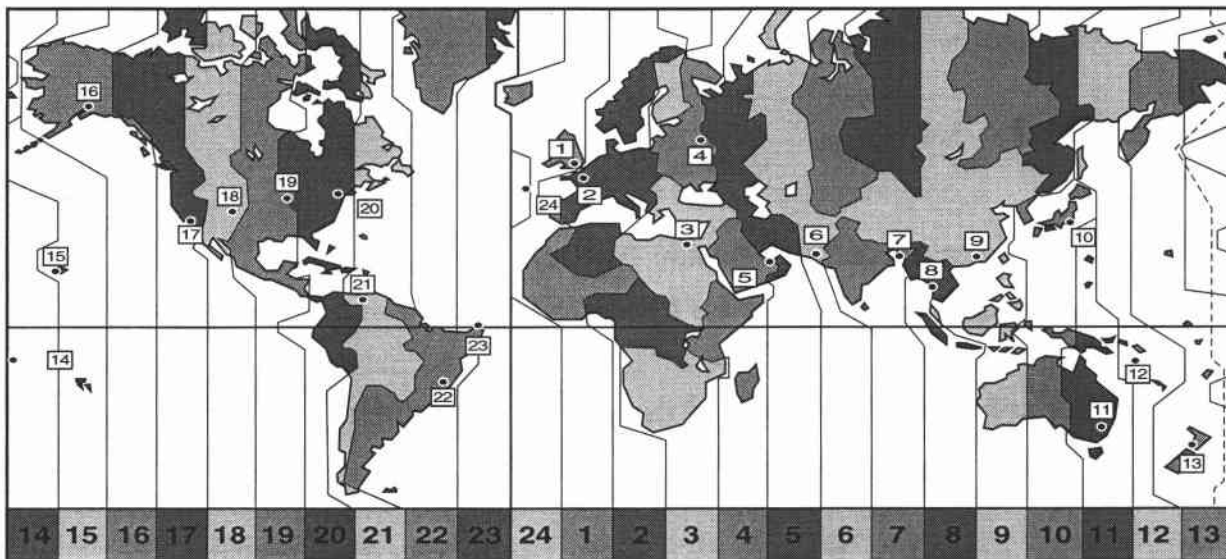

No.	Time zone	No.	Time zone
1	LONDON	13	WELLGTN (Wellington)
2	PARIS	14	SAMOA
3	CAIRO	15	HONOLU (Honolulu)
4	MOSCOW	16	ANCHOR (Anchorage)
5	DUBAI	17	L.A. (Los Angeles)
6	KARACHI	18	DENVER
7	DACCA	19	CHICAGO
8	BANGKOK	20	N.Y. (New York)
9	H. KONG (Hong Kong)	21	CARACAS
10	TOKYO	22	RIO (Rio de Janeiro)
11	SYDNEY	23	FERNAN. (Fernando de Noronha)
12	SOLOMON	24	AZORES



- After you have selected your time zone and set the date and time, when you travel to another time zone, there is no need to reset the date and time. Just set the time zone to your destination and the camera's clock will automatically change to display the correct time for your destination.

Setting the clock



▶D/TIME SET.. 1.JAN.2000
12:00 AM

1. **Set the camera to record pause mode.**
2. **Open the menu and select D/TIME SET.**
 - The year display starts to flash.
3. **Turn the selector dial up and down to change the year. Press the dial in to move to another part of the display.**
 - Once you move from the year, the next part of the display starts flashing.
4. **Set the month, day, hours, and minutes in the same way.**
5. **Press the MENU button when finished, and to start the clock.**
 - The date can be set to any year between 2000 and 2020.
 - If you press the MENU button in the middle of setting the date and time the seconds are set to zero, you leave the menu, and the clock starts.
 - If you press the selector dial in after setting the minutes you can set the date and time again from the start.

Date and time display

You can choose to display or hide the date and time display during recording. When the date and time display is set to ON, the date and time show in the lower left-hand corner of the display but the time zone disappears in about four seconds. The large, four-second display will no longer appear when you turn on the power. It is not recorded onto your tape.



▶D/T DISPLAY·OFF

1. **Set the camera to record pause mode.**
2. **Open the menu and select D/T DISPLAY.**
3. **Select ON and close the menu.**

Recording in Progressive Scan Mode

In Progressive Scan Mode, the MV30/MV30i records 25 full frame images per second, continuously, for superior quality frames. Use Progressive Scan Mode for fast moving scenes and moments that are hard to capture just taking a still photo. Check your tennis or golf swing, for example, or capture the smile of a baby. You can then record selected still images onto a floppy disk with the Floppy Disk Still Image Recorder FR-100 (optional) and easily transfer them to a personal computer for print out, making personalized postcards, calendars, etc.

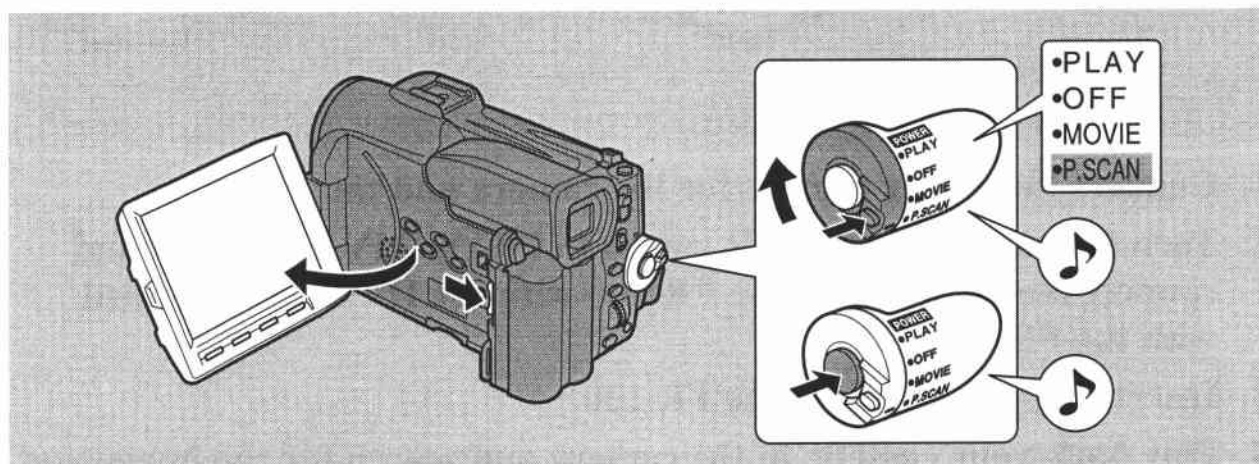

1. Turn the **POWER** switch, set to **P. SCAN** (progressive scan).

- The power indicator lights up.
- PRO.SCAN appears in the display.

2. Press the start/stop button to begin recording.



- Progressive scan video may appear slightly jerky during normal playback. Some recording conditions may be more suitable for MOVIE than P. SCAN.
- The camera will turn itself off if you leave it in record pause mode for more than about five minutes. To return to record pause mode, set the POWER switch to OFF and then back to P. SCAN.

E

Using the Full
Range of Features

E**Using the Floppy Disk Still Image Recorder FR-100 (optional)**

The FR-100 captures images taken with the camera, compressing them in JPEG format and recording them as still images onto a floppy disk. Also refer to the FR-100 instruction manual for further details.

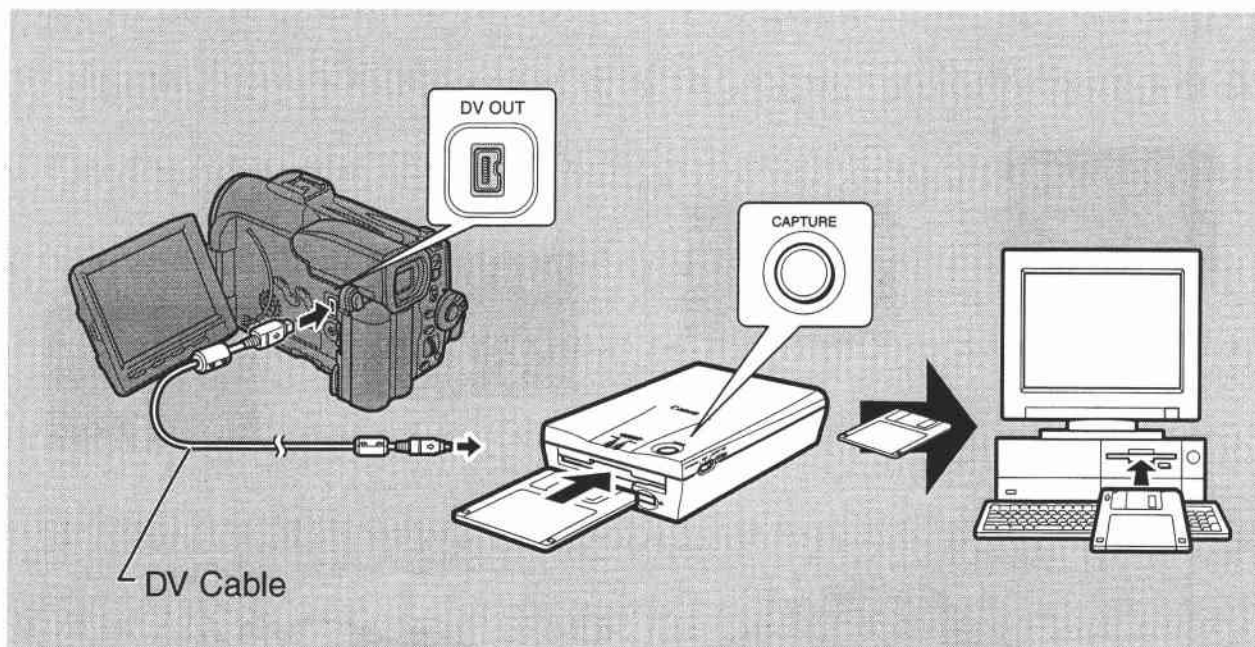

Using the Full
Range of Features

1. Connect the power sources for the camera and the FR-100.
2. Turn the camera's POWER switch to PLAY (MV30i: VCR), and connect the camera and the FR-100 with the DV cable (supplied with the FR-100).
3. Insert a floppy disk into the FR-100.
4. Play back your cassette in the camera and search for the image you want to capture. Find exactly the frame you want by using frame advance/reverse (□ 27).
5. Press the FR-100's CAPTURE button to record the image onto the floppy disk.
6. After you have finished recording images, remove the floppy disk and insert it into your personal computer's disk drive.

Taking Still Pictures

E

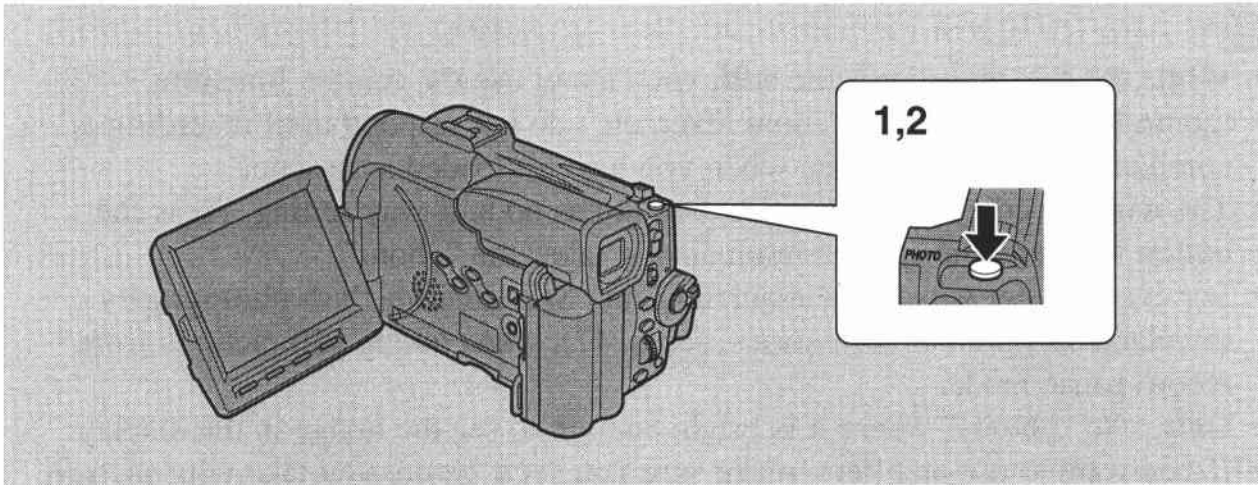

Take still photos that you can record onto a floppy disk with the optional Floppy Disk Still Image Recorder FR-100 (44) and transfer to a PC for image enhancement and printout. Also, starting your shooting with a still photo makes it easy to find the beginning again later with the Photo Search function(76). You can record still pictures like a photograph. The camera records the picture and sound to tape for approximately 6 seconds. The exposure is automatically adjusted.

Take still pictures from the body of the camera or from the wireless controller. You can take a still picture at any time during regular video recording, or you can put the camcorder into record pause mode first, then take a still picture.

During record mode

Press the button fully down and the still picture will be taken immediately.

During record pause mode

1. Press the button halfway down and hold it:

- "PHOTO" flashes at the bottom right of display.
- Exposure is locked the instant the photo button is pressed halfway down.
- During autofocus ● flashes white in the display as the camcorder adjusts the focus and it is displayed continuously as a green mark when the camera is ready to take the still picture.
- If the subject is unsuitable for autofocus (108), the camera may not be able to focus, and ● may continue to flash white in the display. Adjust the focus manually with the selector dial.
- If you are using manual focus (70), the ● mark starts as a continuous green mark. Focus with the selector dial.

2. Press the PHOTO button fully down to take the still picture.

- The camera takes the image immediately, and then records the "photo" to the tape for approximately six seconds. During this time the camera also records the sound, and the display also shows the still picture.
- A counter display appears, and counts up to six secs as the camcorder records the picture. ● disappears from the display.

Using the Full
Range of Features

**E**

- While the camera records the still, you cannot use the camera functions (controls, POWER switch/zoom lever, etc., do not respond until recording is complete). This applies even when you haven't loaded a cassette.
- The wireless controller's PHOTO button has no half-way setting. Press the button fully and the camera immediately takes the "photo".
- For even greater versatility attach a Canon Speedlite for flash photography (available as optional accessories, see p. 47), when taking still pictures from record pause mode.
- Only take "photos" where it is bright enough to see the image in the display.
- If you want to use an effect, make sure you set it before you take your picture.
- Depending on the subject (fast moving subject, for example), the picture may be blurred.

Using a Canon Speedlite for Flash Photography (optional)

For SLR-style flash photography, attach a Canon Speedlite 220EX, 380EX or 550EX to the camcorder's accessory shoe.

Attach/remove the Speedlite 380EX and 550EX with their locking collars as in the illustration. Attach/remove the Speedlite 220EX with its hot shoe lock release.

Set the camera to record pause mode. Turn on the Speedlite using its main switch, and wait for it to charge. When you press the PHOTO button halfway down, the camera sets the autofocus and the exposure is locked. Pressing the PHOTO button fully down releases a pre-exposure flash that sets the flash intensity, exposure and white balance. The main flash is then sent out.

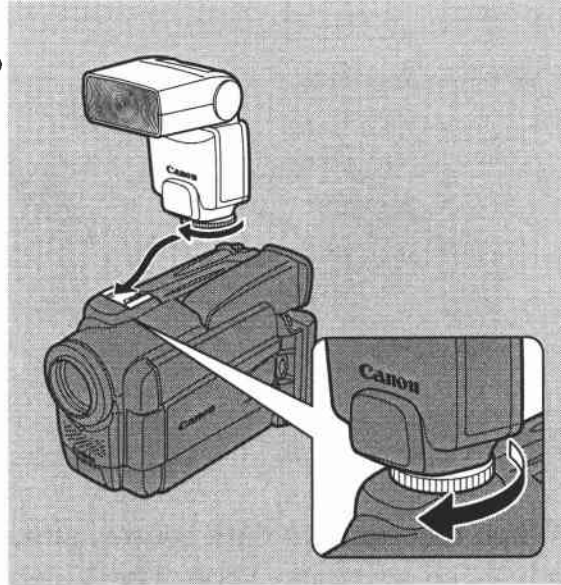

E

- In dark recording situations during autofocus, a supplementary light beam is sent out by the Speedlite for approx. eight seconds to illuminate the subject while you hold the camera's PHOTO button halfway down.

Flash Charging

While the Speedlite is charging, a white ⚡ flashes in the display.

When the Speedlite is fully charged a green ⚡ lights up constantly in the display.

- Although it is possible to record a still image while the Speedlite is still charging, the flash will not go off. In addition, the Speedlite cannot charge while you are holding the PHOTO button halfway down.
- ⚡ disappears from the display while the camera records the still picture.
- If the ⚡ mark does not appear in the display when you turn the Speedlite on, make sure that the Speedlite unit is slid fully onto the accessory shoe.



- For full details of how to use the Speedlite, refer to its instruction manual.
- Set the shutter speed (in the camera menu) to any speed between 1/50 and 1/2000.
- You cannot use the Speedlite with the exposure lock. (⚡ goes out if you press the EXP button. It reappears when you turn the lock off, by pressing the EXP button again.)
- Turn the Speedlite unit off when you do not require a flash.
- You are unable to use the bounce flash on the 380EX and 550EX Speedlites with the MV30/MV30i.
- You cannot use the Speedlite Transmitter ST-E2 for the 550EX.
- You cannot use the 550EX's multiple speedlite control.

Using the Full
Range of Features

Using the VL-3 Video Light (optional)

E

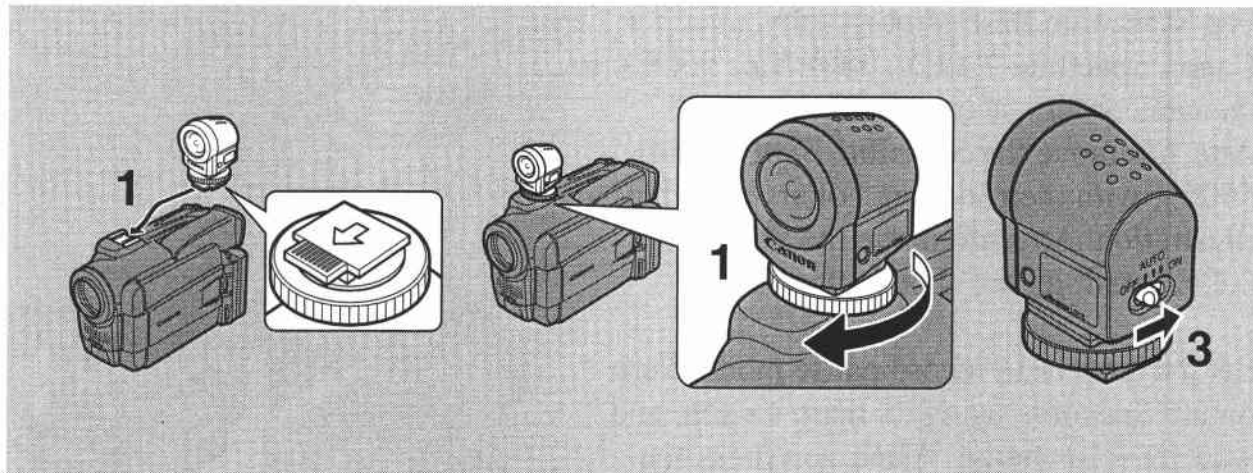

When recording in dark rooms, attach the Video Light to the camera's "S" advanced accessory shoe. The Video Light is powered by the same power source as the camcorder.

Also refer to the VL-3 Video Light instructions.

Turn the camcorder's power off before attaching/removing the Video Light.

1. Slide the Video Light onto the camcorder's accessory shoe and tighten with the shoe lock.

- Slide in the direction of the arrow on the bottom of the Video Light until it clicks securely into place.
- Make sure that the light does not come disconnected when turning the shoe lock.

2. Turn the camcorder's POWER switch to camera mode.

3. Turn the Video Light's power switch to AUTO or ON.

- **C** (Connection) appears in the display.
- **ON**: The Video Light stays on.
- **AUTO**: The Video Light turns on/off automatically according to the level of brightness of the shooting conditions.
 - When the Video Light is set to AUTO, it will not turn itself on/off during exposure lock or while the camera is recording a still picture, even if the brightness of the surroundings changes.

Caution:

- Be careful not to touch the bulb or the surrounding area during or immediately after use; it becomes very hot. Keep the Video Light away from flammable or plastic materials.
- Do not look directly at the bulb while the Video Light is on.
- Never carry the camera holding the Video Light.

Using the DM-50 Microphone (optional)

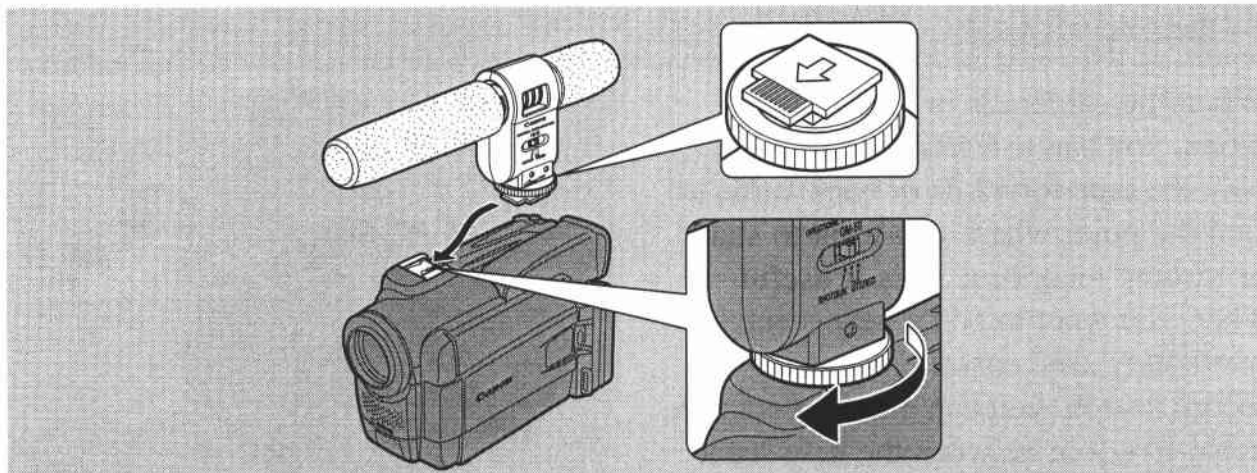

The highly sensitive Directional Stereo Microphone DM-50 has been designed exclusively for camcorders equipped with an advanced accessory shoe „S“. It is powered by the camcorder's power supply. Use during recording or audio dubbing (93).

Refer to the DM-50's instructions for further details.

Turn the camcorder's power off before attaching/removing the microphone.

- 1. Slide the microphone onto the accessory shoe and tighten with the shoe lock.**
 - Slide in the direction of the arrow on the bottom of the microphone until it clicks securely into place.
 - Make sure that the microphone does not come disconnected when turning the shoe lock.
- 2. Turn the camcorder's POWER switch to camera mode.**
 - **C** (Connection) appears in the display.
- 3. Set the microphone's directivity switch.**

SHOTGUN: Clearly picks up sound arriving from the front of the microphone (monaural).

STEREO1: Picks up sound arriving from the front of, as well as sound surrounding the microphone.

STEREO2: Picks up sound surrounding the microphone in a wider range than STEREO 1.



- Never carry the camera holding the microphone.
- The DM-50 will not pick up any sound if another microphone is attached to the camcorder's microphone terminal.

Searching and Reviewing While Recording

E

Record search

When the camera is in record pause mode, you can use record search to play the tape forwards or backwards to find the point where you want to start or resume recording. This is useful when you want to add a new scene to a previously used cassette. By using record search, you can ensure a smooth, noise-free join between the new scene and the old one.

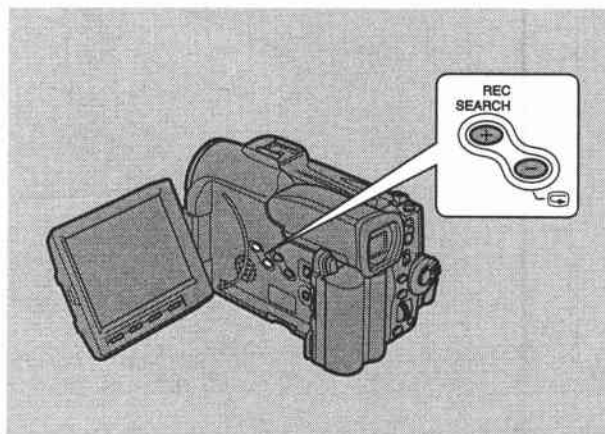

1. **Make sure the camera is in record pause mode.**
2. **Press and hold the REC SEARCH + or – button on the camera while you check the picture in the display.**
 - The + button plays the recording forwards and the – button plays it backwards.
3. **Release the button when you find the point where you want to start recording.**
 - The camera returns to record pause mode.

Record review

When the camera is in record pause mode, you can use record review to play back the last few seconds of your recording and then return automatically to record pause mode. You can quickly make sure that a scene has recorded properly and then go on to shoot the next scene, without producing any noise in the picture.

1. **Make sure the camera is in record pause mode.**
2. **Press and release the  (record review) button while you check the picture in the display.**
 - The camera rewinds the tape, plays back the last few seconds, and returns to record pause mode.



- Noise may appear on the screen when you play the tape backwards.

Using the Various Recording Programs

E

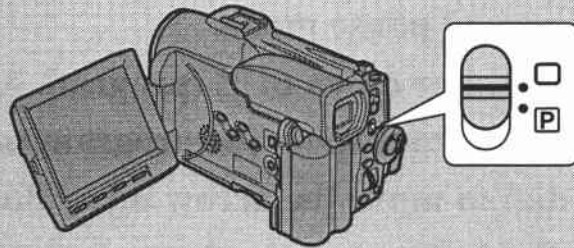

The camera provides you with a choice of seven recording programs. They use different combinations of camera settings in order to adjust the exposure and other functions to match the recording situation.

- For simple point-and-shoot operation, select the Easy Recording program. Slide the program selector to the □ position.
- For normal shooting conditions, slide the program selector down to P (program AE) mode. Open the program menu and select AUTO (52).
- For various other recording conditions, the camera has five more specialized AE (auto exposure) programs.

Availability of functions in each recording program

Position of program selector							
Recording Program	□ (Easy Recording)	Auto	Sports	Portrait	Spotlight	Sand & Snow	Low Light
Shutter Speed		○	A				
Focus	A	○					
Exposure		○					
White balance		○					
Image stabilizer (ON/OFF)		ON	○				
Digital effects	×	○					
16:9	×	○					

○ : Available × : Not available A : Automatic function only

Using the Full
Range of Features

Setting the program AE mode

1. Set the camera to record pause mode.
2. Slide the program selector down to **P** (program AE) mode.
3. Push the selector dial in to display the program menu.
4. Turn the selector dial to move the arrow up or down the display.
5. Push the selector dial in to select the desired program.
 - The program will appear in the display.
6. Press the start/stop button to begin recording.



- The name of your selected recording program appears constantly on the left of the display, with the exception of the Auto, which is displayed and then disappears after 4 seconds.
- Avoid changing programs during recording as the brightness of the image may change suddenly.
- The specialized AE programs are not suitable for all kinds of lighting. The image may flicker, or a bright line may appear on the screen if you use them in the wrong lighting conditions.
- If you switch the camera from the program to the **P** program, the camera returns to the Auto mode.

Easy Recording

The simplest way to use the camera is with the program selector set to the  position. The camera will take care of focus, exposure and other adjustments, leaving you free to point and shoot.



Auto

This is the same as the Easy Recording program, except that you now have the option of using any of the camera's manual functions.

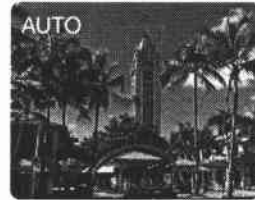

Sports

This program is useful for recording high-speed sports scenes in brightly lit conditions. Normal playback will be slightly jerky, but you will get clear images which can be analysed frame by frame during slow or paused playback.



Portrait

Use this program outdoors to make subjects stand out from a softened foreground and background. It works well for still-lives and close-ups. The effect is most noticeable when the zoom position is between the middle range and the telephoto end. Focus manually for maximum accuracy, and be careful when recording action scenes, as this program may cause fast moving objects to shudder.



E

Using the Full
Range of Features

E

Spotlight

This program is designed for recording spotlit scenes, such as on a stage. The exposure is automatically adjusted for glare-free recordings of subjects lit by a concentrated light source.



Sand & Snow

Use this program in places where the background is so bright that the subject appears underexposed in the display — a sunny beach or ski resort, for example. You may notice some shudder when recording moving subjects.



Low Light

This program allows you to record in dimly lit places. It is generally best used for close-ups of slow or stationary subjects, as moving subjects may leave a trailing after-image. However, you can take advantage of this to create special effects, by rapid zooming or by panning along with a moving subject. Picture quality will not be as good as in normal lighting conditions, and autofocus may not work as well as usual.



Using Digital Effects

Use the camera's 3 types of digital effects for more interesting productions.

- **Faders:** Start or end scenes with a fade to or from black (☐ 57).
Fade Trigger, Wipe, Scroll, Mosaic Fade
- **Effects:** Add flavour to your recordings (☐ 58).
Art, Black and White, Sepia, Mosaic
- **Multi-Image Screen:** Divides the display to show 4, 9 or 16 still photos. Has 4 transition speed options: fast, moderate, slow and manual (☐ 61).



Availability of digital effects in camera modes

Recording Program		☐ (Easy Recording)			☑ (Program AE)		
		MOVIE	P. SCAN	PHOTO	MOVIE	P. SCAN	PHOTO
Faders	FADE-T.						
	WIPE						
Effects	SCROLL		×		○		×
	M. FADE						
	ART						
Multi-Image Screen	BLK&WHT		×		○		○
	SEPIA						
	MOSAIC						
	FAST, MOD, SLOW						
TR. SPEEDS	MANUAL		×		○		△
	TR. SPEED						

○ : Available × : Not available

△ : You can't record a multi-image screen using the PHOTO button until all the images are captured.

- You cannot use the multi-image screen with digital zoom or the 16:9 effect.

Using the Full
Range of Features

Availability of digital effects in PLAY (MV30i: VCR) playback modes

		Play	Reverse Playback	Still picture playback	Slow forward/reverse playback	Forward/reverse x2 playback
Faders	FADE-T.	○	Set only	○	Set only	
	WIPE SCROLL M. FADE	(Press PAUSE to fade out)		(Press PLAY or PAUSE to fade in)		
Effects	ART	○	○	○	○	○
	BLK&WHT SEPIA MOSAIC					
Multi-Image Screen	FAST, MOD, SLOW	×	×	○	×	×
	TR. SPEEDS				○	
	MANUAL				○	
	TR. SPEED					

○ : Available × : Not available

Using the Full Range of Features



- When you do not want to use digital effects, press the D.EFFECTS button and select D.EFFECT **OFF** from the digital effects menu. Press the D.EFFECTS button to close the menu.
- The camera remembers your chosen digital effect setting until you change it.
- Digital effects cannot be operated on a blank blue screen (appears during playback). The display continues to flash.
- Digital effects operated during PLAY (MV30i: VCR) mode are not recorded onto the original tape.
- Digital effects can be added to another tape when dubbing using the A/V out terminal (PLAY (MV30i: VCR) mode), but not the DV out terminal.
- You cannot operate digital effects while photo/date searching.
- If you slide the program selector to (Easy Recording) while the digital effect display is flashing, it will disappear from the display and reappear when you return to (program AE) mode.
- The digital effect display will flash for two seconds after setting, even if DISPLAYS is set to OFF in the PLAY (MV30i: VCR) menu.

● Faders

Fade Trigger (FADE-T)

When you start recording, the scene gradually fades in from a black screen. When you stop recording, it gradually fades out.

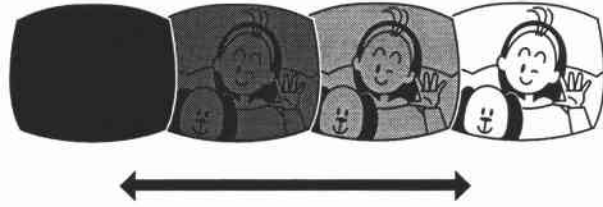

Wipe (WIPE)

When you start recording, the picture begins as a thin vertical line in the centre of the screen which gradually expands sideways until it fills the whole of the screen. When you end a scene, the image is wiped from both sides of the screen.

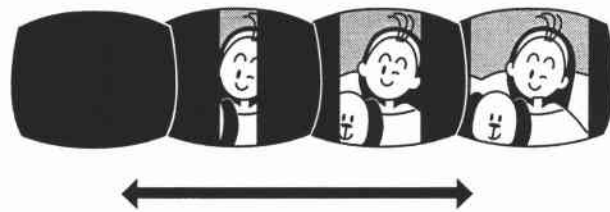

Scroll (SCROLL)

When you start recording the picture appears from the right hand side of the screen and expands sideways until it fills the whole screen. When you end a scene, the image is wiped back off.

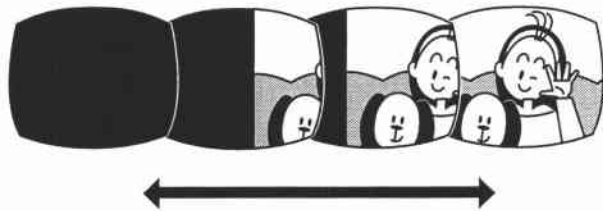

Mosaic Fade (M. FADE)

Blurs the image by enlarging the size of some pixels. The image appears as increasingly large squares of colour as it fades out, and smaller squares when it fades in.

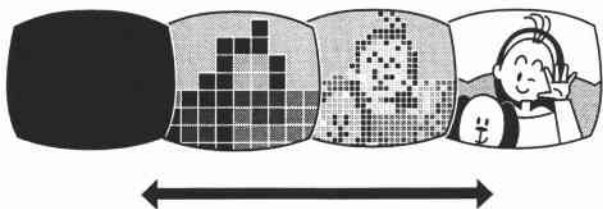

● Effects

Art (ART)

Adds a paint-like effect, called solarization, to the image.

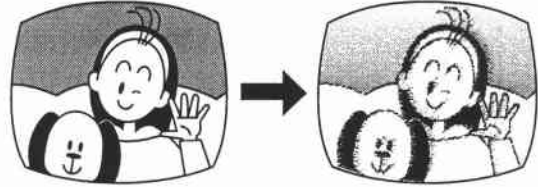

Black and White (BLK & WHT)

Records the image in black and white.

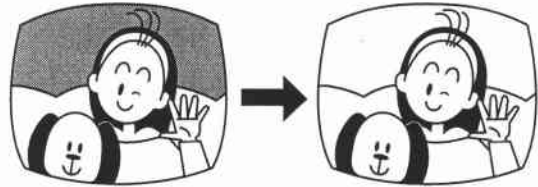

Sepia (SEPIA)

Records a monochrome image with a brownish tint.

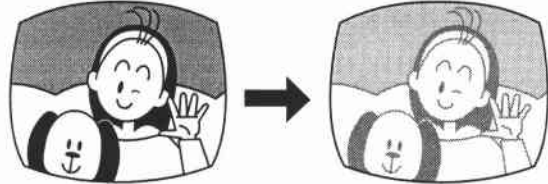

Mosaic (MOSAIC)

Blurs the image by enlarging the size of some pixels.

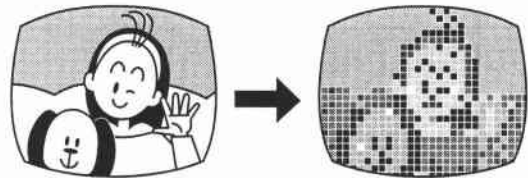

Digital effects can be set with the controls on the body of the camera or the wireless controller. Pressing the ▲/▼ buttons on the wireless controller correspond to turning the selector dial up and down, and pressing the SET button corresponds to pressing the selector dial in.

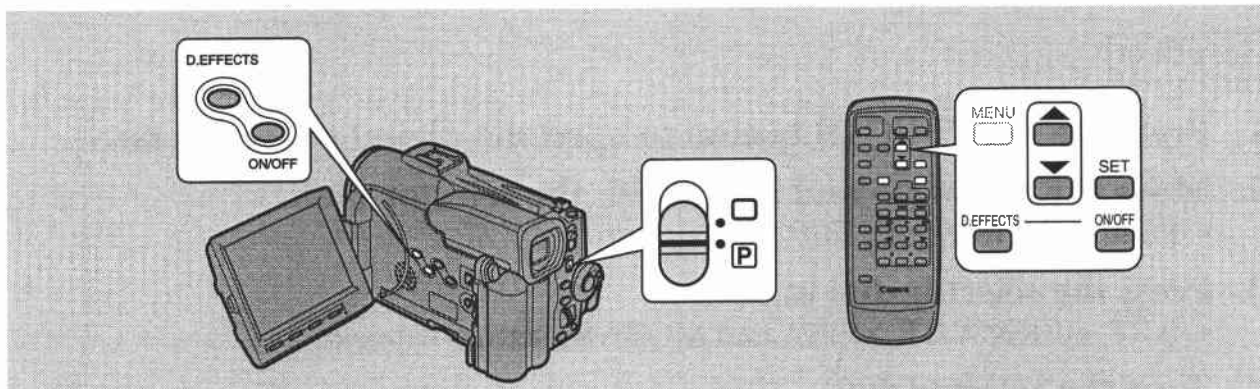

Operating faders

Sound and image fade together.

When operating faders while recording, make sure the program selector is set to **P**.

Set fader

1. Press the **D.EFFECTS** button to open the digital effects menu.
2. Move the arrow up and down with the selector dial.
 - Point the arrow at **FADER**.
3. Press the selector dial in.
 - **FADE-T, WIPE, SCROLL, M.FADE** settings appear.
4. Turn the selector dial.
 - Point the arrow at your selected setting.
5. Press the **D.EFFECTS** button.
 - The menu disappears and your selected setting flashes in the display.

Fader on/off

6. Press the **ON/OFF** button.
 - Your selection stops flashing.
 - Each time you press the **ON/OFF** button, the chosen fader is activated (display lights continuously) or deactivated (display flashes).
 7. If you're in camera mode:
 - Fade in-** Press the start/stop button.
 - Fade out-** Press the start/stop button.
- If you're in **PLAY**
(MV30i:VCR) mode:
- Fade in-** Press the **PLAY** button.
 - Fade out-** Press the **PAUSE** button.

Using the Full
Range of Features

Operating effects

Sound records/plays back normally.

When operating effects while recording, make sure the program selector is set to **P**.

Set effect

1. **Press the D.EFFECTS button to open the digital effects menu.**
2. **Move the arrow up and down with the selector dial.**
 - Point the arrow at EFFECT.
3. **Press the selector dial in.**
 - ART, BLK&WHT, SEPIA and MOSAIC settings appear.
4. **Turn the selector dial.**
 - Point the arrow at your selected setting.
5. **Press the D.EFFECTS button.**
 - The menu disappears and your selected setting flashes in the display.

Effect on/off

6. **If you're playing back, press the PLAY button.**
7. **Press the ON/OFF button.**
 - Your selection stops flashing and takes effect on the display.
 - Each time you press the ON/OFF button, the chosen effect is activated or deactivated.

Using the Multi-Image Screen

E

Divides your display image into four, nine or sixteen smaller images with the Image Capture feature. With this feature, the camera captures the current scene being shot or replayed. Choose the transition speed — manual, fast (every 4 frames), moderate (every 6 frames) or slow (every 8 frames) (in Low Light mode, every 4, 8 or 12 frames) — at which to capture a moving subject, such as a person playing tennis or golf. Sound is recorded normally.

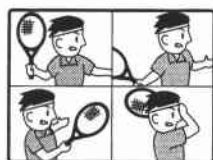

4 images



9 images



16 images

Operating the multi-image screen (55,56)

When operating effects while recording, make sure the program selector is set to **P**.

Set multi-image screen

- 1. Press the D.EFFECTS button.**
 - The digital effects menu appears.
- 2. Move the arrow up and down with the selector dial.**
 - Point the arrow at MULTI-S.
- 3. Press the selector dial in.**
 - TR. SPEED (transition speed) and SPLIT TO settings appear.
 - Point the arrow at TR. SPEED and press the selector dial in.
 - TR. SPEED settings appear: MANUAL, FAST, MOD (moderate), or SLOW.
 - Point the arrow at your desired setting and press the selector dial in again.
 - The display returns to the digital effects menu.
 - Set SPLIT TO in the same way.
 - SPLIT TO settings are: 4, 9 and 16.
- 4. Push the D.EFFECTS button.**
 - The digital effects menu disappears.
 - MULTI-S flashes in the display.

Multi-image screen on/off

- 5. Push the ON/OFF button.**
 - Manual: As you press the ON/OFF button, scenes will be captured one after another the indicated number of times. If you push and hold the ON/OFF button for more than a second, the last image captured will be erased.
 - Automatic: The camera will capture the indicated number of images at the indicated speed.
 - The currently recording image is framed in blue. The frame disappears after the last image is captured.

E**6. If you're in record pause mode, push the start/stop button to begin recording.**

- The multi-image screen is recorded to the tape.



- You can operate the multi-image screen from record or record pause mode.
- After all the images have been captured, push the ON/OFF button to cancel the multi-image screen.
- If you are operating the multi-image screen in PLAY (MV30i: VCR) mode and you stop or pause the tape, or press any other playback button, the multi-image screen will be cancelled.

Audio Recording

Selecting the audio mode

E

MV30/MV30i can record sound in two audio modes — 16-bit and 12-bit. The 16-bit mode produces the higher sound quality (slightly superior to CD) while the 12-bit mode records on two channels (stereo 1), leaving two channels free (stereo 2) for you to add new sound at a later date.



1. To switch to the 16-bit mode, open the menu and select **AUDIO MODE**.
2. Select “16 bit” and close the menu.
 - “16 bit” is shown in the display for approximately four seconds.



- For details on adding new sound, see p. 93.
- For details of playing back a tape that has new sound on stereo 2, see p. 96.

External microphone

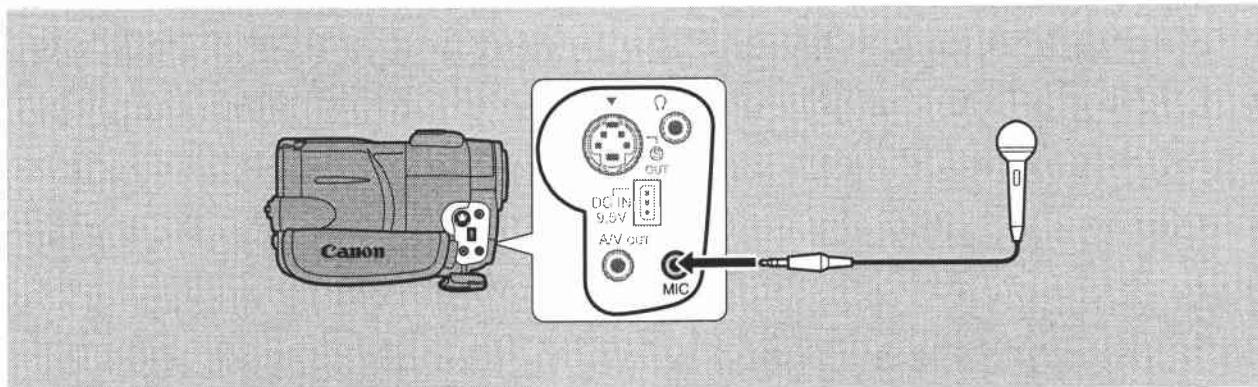

For greater creative control over audio recording, you can connect an external microphone to the camera via the MIC terminal. When using the MIC terminal, use a microphone with a built-in power supply (condenser microphone). It is possible to connect almost any stereo microphone with a plug diameter of 3.5 mm ($\frac{1}{8}$ in), however, their audio levels will be different from that of the built-in microphone.



- Use the Microphone Boom MB-100 (optional) to keep long microphones out of the frame.
- You can monitor the sound while recording by attaching stereo headphones to the  terminal.

Using the Full
Range of Features

Wind screen

The camera has an automatic wind screen to prevent wind noise from interfering with the sound track. It can be turned on to operate with the internal microphone, an external microphone connected to the MIC terminal or the DM-50 Directional Stereo Microphone (optional) attached to the advanced accessory shoe. Make sure it's off when you want the microphone to be as sensitive as possible. Use the wind screen when recording in windy places such as the beach or near buildings. The wind screen can be used for audio dubbing as well as recording.



1. **Open the camera menu and point the arrow at WIND SCREEN.**
2. **Select the ON setting and close the menu.**
 - WS **ON** is shown in the display.

Setting the Self-Timer

E

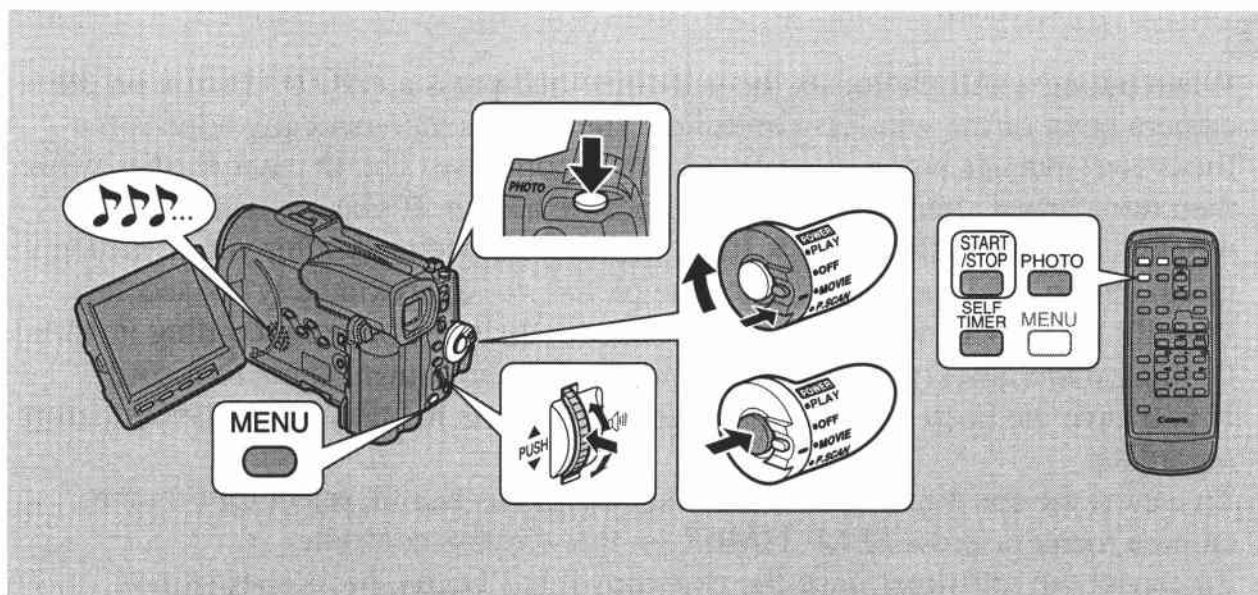

This is useful when you want to include yourself in the picture when recording movies or still photographs.



For movie

1. Set the camera to record pause mode.
2. Select **SELF TIMER** from the menu and set it to **ON**
or
Push the SELF TIMER button on the wireless controller.
 - SELF T. appears in the display.
 - To have the subject monitor recording, rotate the LCD panel 180° (23).
3. **Press the start/stop button.**
 - The camera starts to record after a 10-second countdown period (or after two seconds when you use the wireless controller). The time remaining counts down in the display (e.g. "5 SEC").
 - SELF T. disappears from the display when recording begins.
 - The tally lamp starts flashing.
4. **Press the start/stop button to end recording.**
 - After recording a still picture for about six seconds, the camera automatically goes into record pause mode.

Using the Full
Range of Features

**E**

- When taking a still photo, set the self-timer and press a PHOTO button on the camera body or the wireless controller. The camera automatically adjusts the focus two seconds before the countdown is complete. The ● mark flashes white then turns green after the focus and exposure are set. If you are using the wireless controller, the ● mark starts flashing immediately after you press the photo button. The camcorder takes the picture for approximately six seconds.
- Initially the tally lamp flashes once a second, then just before recording it starts flashing more quickly for a few seconds before the camera starts to record.
- If you have the beep turned on, it sounds each time the tally lamp flashes before recording.
- To cancel the self-timer before the countdown has begun, select OFF in the camera menu or press SELF TIMER on the wireless controller.
- To cancel the self-timer once the countdown has begun, press start/stop if you're shooting movies, PHOTO if you're taking a still photograph, or SELF TIMER on the wireless controller.

Adjusting Exposure Manually

Exposure lock

When you are recording in situations where the lighting may change suddenly, you can lock the exposure at the current level in order to control the brightness of the image.

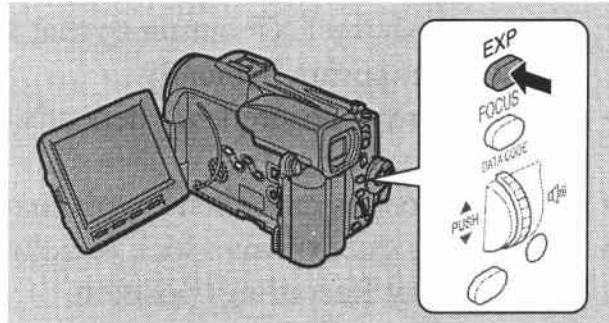

To lock the exposure, press the EXP button. Press it again to return to the automatically set exposure level.

Exposure adjustment

When the exposure is locked, you can adjust it manually, making the picture brighter or darker in order to deal with difficult lighting conditions. The camera's iris can be manually set to any position from fully closed to fully open.

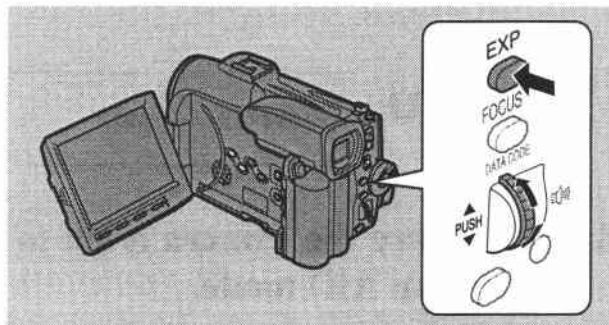

To make the recorded image brighter, turn the selector dial upwards (to a maximum of +11). This may be necessary if the background is very bright, or if the subject is lit from behind.

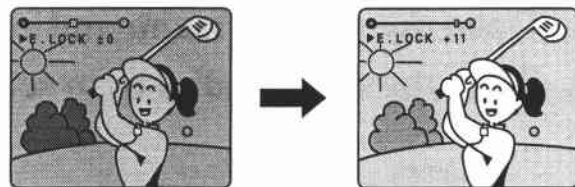

To make the recorded image darker, turn the selector dial downwards (to a minimum of -11). This may be necessary if the background is very dark, or if the subject is spotlighted.

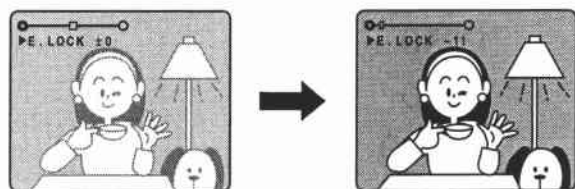

E

Using the Full
Range of Features

E



- You cannot adjust the exposure without the ► mark before E.LOCK in the display. Push the EXP button so that ► appears before E.LOCK. Then you can adjust the exposure manually.
- The standard exposure level depends on which recording program you have selected.
- Exposure lock is cancelled if you change recording programs.
- You cannot use exposure lock or adjustment when the program selector is set to the □ (Easy Recording) position.
- If you zoom while the exposure is locked, the brightness of the scene may change.

Shutter speed

Set the shutter speed manually to take stable shots of quickly moving subjects.



1. Make sure the camera is set to record pause mode in the **P** (program AE) mode.
2. Press the selector dial in and choose **AUTO** from the program menu.
3. Open the camera menu and select **SHUTTER**.
4. Press the selector dial in to select the desired shutter speed.

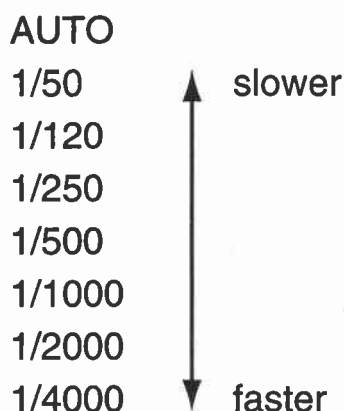

- You are unable to use the 1/4000 shutter speed when a Speedlite is attached.
5. Close the menu.

- The camera returns to the auto shutter setting when you slide the program selector to □ (Easy Recording), or change the recording program.



Guidelines for shooting using high shutter speeds

- When shooting with a shutter speed of 1/1000 or higher, do not shoot the sun directly.

Recommended shutter speeds when shooting:

- People doing outdoor sports such as golf or tennis



1/2000 or 1/4000

- Moving cars or trains or other rapidly moving vehicles such as roller coasters



1/1000, 1/500 or 1/250

- People doing indoor sports such as basketball



1/120



- You are unable to set the shutter speed when exposure lock is set in any recording mode other than AUTO. The SHUTTER display becomes set to “_ _ _.”
- The image may not appear smooth when a high shutter speed is set.



Using the Full
Range of Features

Adjusting Focus Manually

E

The camera can focus automatically. All you have to do is point it, and whatever is in the centre of the display will usually be in sharp focus. If it does not seem to be focusing well, it may be because the subject is not suitable for autofocus.

You can use the manual focusing function for more control over focusing.

Focus lock

Press the FOCUS button to turn off autofocus. The focus remains locked at the point set by autofocus.

(▶M.FOCUS appears in the display.)

You can now adjust the focus manually with the selector dial. Press the FOCUS button again when you want to return to autofocus.

- If you zoom in on your subject after turning off autofocus, it may not stay in focus. It is generally best to adjust the zoom first, and then the focus.

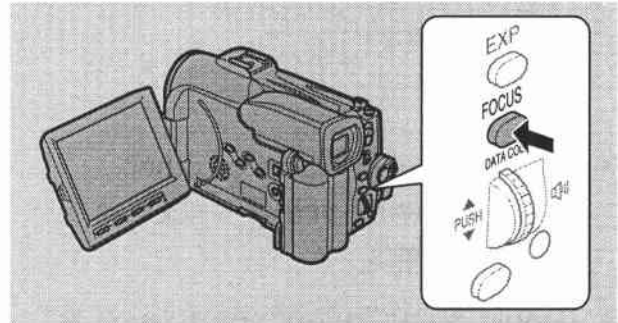

Manual focus

Use the selector dial to set the focus.

- Turn the selector dial downward to move the focus farther away.
- Turn the selector dial upwards to bring the focus nearer.

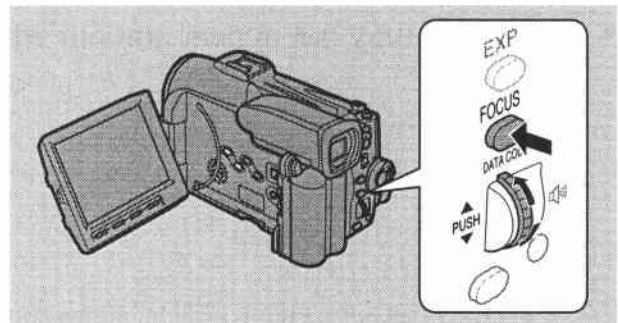

- You cannot adjust the focus without the ▶ mark before M.FOCUS in the display. Push the FOCUS button so that ▶ appears before M.FOCUS. Then you can adjust the focus manually.
- The manual focus setting is cancelled if you select the (Easy Recording) program.
- When you are using the (Easy Recording) program, autofocus cannot be turned off.
- See “Troubleshooting” on p. 107 for a list of subjects which may not be suitable for autofocus.

Setting the White Balance

The camera's auto white balance system compensates for a wide range of lighting conditions. Although slight variations are unavoidable, colours will appear natural in virtually every situation.

In some cases, you will get better results by setting the white balance yourself, or using one of the two preset modes:

 Indoor Mode

- Under halogen or studio/video lighting
- Subject is of one dominant colour
- Close ups

 Outdoor mode

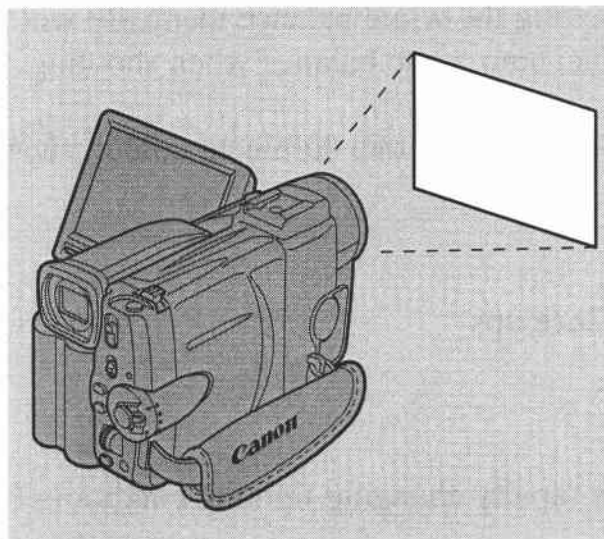

- In daylight, especially for close-ups and where the subject is of one dominant colour



E



▶WHITE BAL...AUTO

1. Open the camera menu and point the arrow at WHITE BAL.
2. a) For the indoor, outdoor or auto settings, press the selector dial in to choose the setting.
 -  appears in the display when you set the white balance to indoor/outdoor mode.b) To set the white balance yourself, point the camera at a white object (such as a sheet of paper) and zoom in until it fills the display. Then press the selector dial in to select SET.
 - The  display flashes then remains lit.
 - Depending on the light source, the flashing may at times continue. The result will remain better than with the auto setting and you can continue recording.
3. Close the menu.

Using the Full
Range of Features

E

Setting the white balance manually will probably work better than auto white balance when shooting:

Subjects with one dominant colour, such as sky, sea or forest



Close-ups



In rapidly changing lighting conditions



In places lit by certain types of fluorescent or mercury vapour lights



- Turn the digital zoom off (if necessary) to set a more accurate white balance.
- If you have set the white balance and lighting conditions change, reset the white balance.
- Try to record with light from a single source. Correct white balance cannot be obtained for two types of lighting at once.
- You cannot set the white balance or choose the indoor/outdoor mode when the program selector is set to the (Easy Recording) program.
- The white balance returns to the AUTO setting when you slide the program selector to (Easy Recording).
- When you turn the camera on, the white balance returns to AUTO. If you then switch the white balance to SET, the camera will remember your last setting.
- During normal outdoor shooting, setting to AUTO may provide better results.

Displaying Date, Time and Camera Data (Data Code)

A data code, containing the date and time the recording was made and other camera data (shutter speed and exposure settings) is automatically recorded on a special data section of the tape.

E

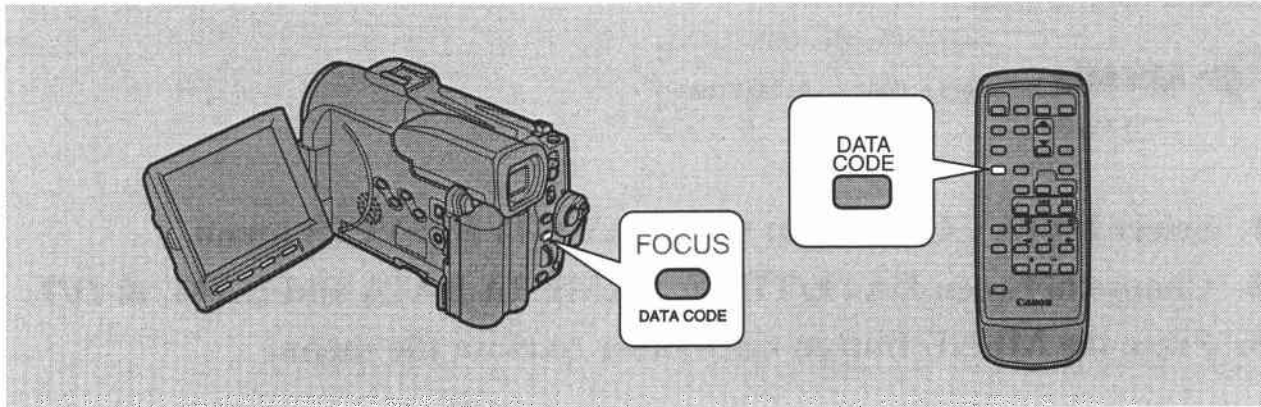

During PLAY (MV30i: VCR) mode, the data code can be displayed or hidden while the camera is in play, slow or still mode.

Camera data may be displayed as “- - -” during fast forward, rewind, reverse playback, forward and reverse $\times 2$ playback.

Press the DATA CODE button on the wireless controller or the camera.

- Press it once to display, once more to hide it.

Selecting date/time

Select whether you want the date, the time, or both to show up on your data code display (74).



▶D/TIME SEL.·DATE & TIME

1. Turn the POWER switch to PLAY (MV30i: VCR).
2. Open the menu and select D/TIME SEL.
3. Choose between DATE, TIME and DATE & TIME.
4. Press the MENU button to close the menu.

Using the Full
Range of Features

Setting the data code

You can also choose which type of data code to display — either the date/time, camera data or both.



▶DATA CODE...DATE/TIME

1. Select **DATA CODE** from the **PLAY (MV30i: VCR)** menu.
2. Choose between **DATE/TIME**, **CAMERA DATA** and **CAM. & D/T**.
3. Press the **MENU** button once more to close the menu.

Possible data code combinations:

DATA CODE D/TIME SEL.	Date/Time	Camera data	Date/Time & Camera data
Date	1. JAN. 2000	F32 1/2000	F32 1/2000 1. JAN. 2000
Time	12:00:00 AM	F32 1/2000	F32 1/2000 12:00:00 AM
Date & Time	12:00 AM 1. JAN. 2000	F32 1/2000	F32 1/2000 12:00 AM 1. JAN. 2000



- To avoid accidental recording, make sure that you slide the tab on the cassette so that it exposes the hole (the switch position is usually labelled **SAVE** or **ERASE OFF**).
- The data code will read “- - -” in the following situations:
 - During playback of a blank section of tape.
 - If the tape was recorded before entering the date and time in the camera’s memory.
 - If the tape was recorded on a camera without a data code function.
 - If noise or tape damage prevents the data code from being read.
- If a recording made on MV30/MV30i is played back on a different DV camcorder, the data code may not be displayed correctly.
- The data code will appear in the display even if **DISPLAYS** (115) has been set to **OFF** through the **PLAY (MV30i: VCR)** menu.

Six-second auto date

E

The six-second auto date appears for six seconds to mark the changeover of a day if the tape was being recorded at 12:00 midnight. It also appears for six seconds when you start playback and have the data code turned off. The six-second auto date will adjust for any time zone changes you have indicated.



You can turn the six-second auto date on:

1. Turn the **POWER** switch to **PLAY (MV30i: VCR)**.
2. Open the menu and select **6SEC.DATE**.
3. Select **ON** and close the menu.



- When **6SEC.DATE** is turned on but **DISPLAYS (115)** is turned off, the six-second auto date will still appear for six seconds.

Searching the Tape (Photo Search/Date Search)

E

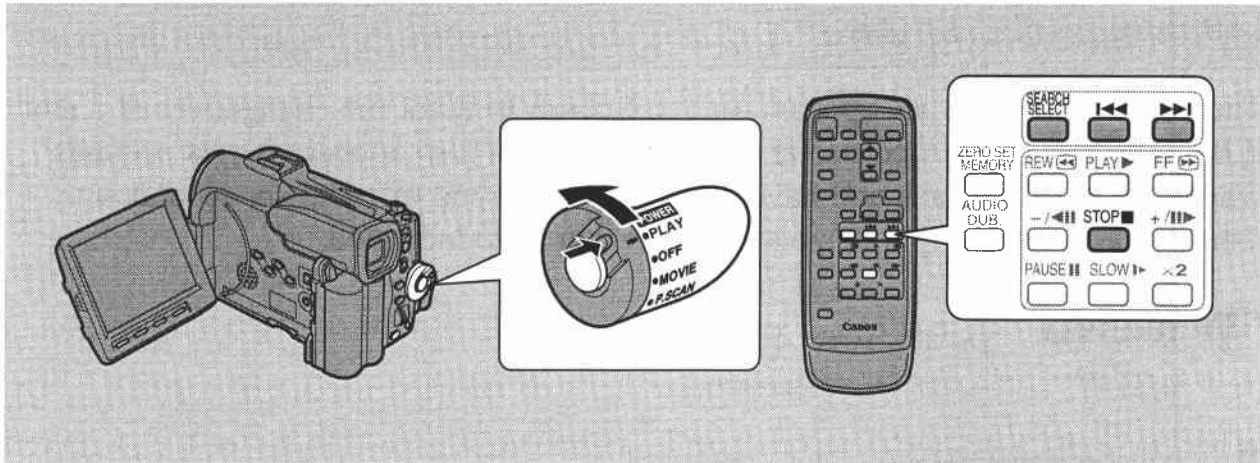

This allows you to move quickly through still pictures recorded anywhere on a tape (photo search) or between different days or areas of recording (date search).

- You can only use this function from the wireless controller.

1. Turn the **POWER** switch to **PLAY** (MV30i: VCR).
2. Press the **SEARCH SELECT** button to choose between photo/date search.
 - PHOTO SEARCH or DATE SEARCH is shown in the display for four seconds.
3. Press the **◀◀** and **▶▶** buttons to move backwards or forwards through the still pictures or between different days of recording.
 - Press once to move to the start of the previous/next still picture or day on the tape.
 - You can press more than once to move to the corresponding still picture or day (up to a maximum of ten times), e.g. press the **▶▶** button five times to move forward five still pictures or days.
 - PHOTO SEARCH/DATE SEARCH appears in the middle of the display alongside the **◀◀** or **▶▶** mark and number to search through. The recording mode is also shown (SP/LP).



- Press **■** (stop) to stop mid-search.
- If you begin a search very close to the start of a recorded still picture during photo search, the camera may skip straight past it.
- When you have set the area for the World Clock, date search also looks for the change in date based on the adjusted time.
- A date/area cannot be identified if the total recording time on that day/area was less than one minute.
- Date search playback may start just before or after the beginning of the located section.
- If the data code is not displayed correctly you will not be able to operate the date search correctly.

Returning to a Pre-Marked Position

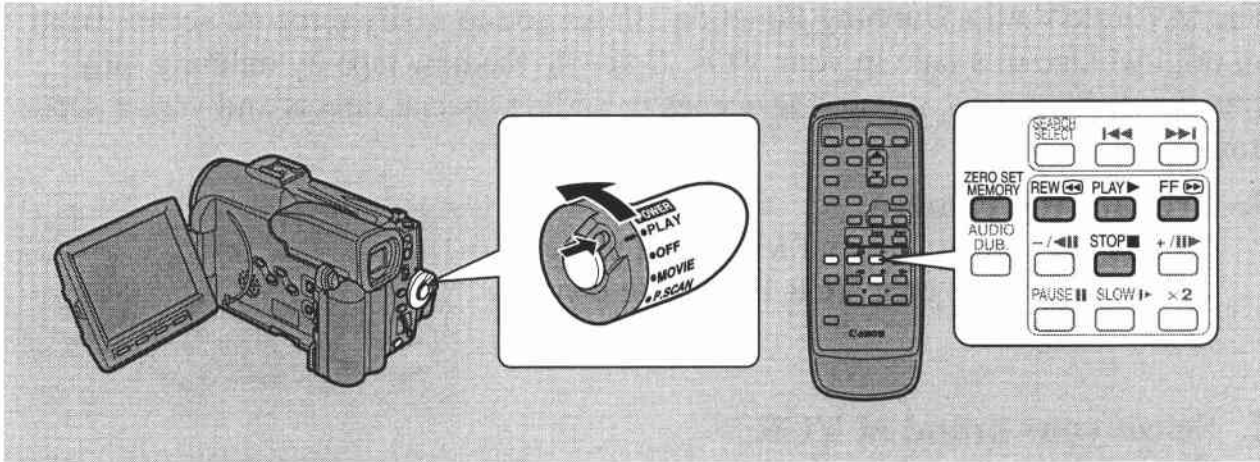

Use the wireless controller to mark a point on a tape that you want to return to following playback.

- You will need the wireless controller to be able to set zero set memory.

1. Press the ZERO SET MEMORY button on the wireless controller during playback at a point you want to return to later.

- The time code is replaced by a tape counter that is set to zero with the **M** indication.
- Press the ZERO SET MEMORY button once more to cancel the zero set memory.

2. When you have finished playback, fast forward or rewind the tape. The tape stops automatically when it reaches the zero set position.

- **RTN** or **RTN** appears in the display.
- The tape counter with **M** indication disappears from the display and the time code reappears.



- The zero set memory may not function correctly where there is a break between recordings on the tape.
- You can also use zero set memory to mark a position on a tape in camera mode. When you then play back the tape, pressing rewind will take you back to the pre-marked position.
- If you remove the tape while the zero set memory is set, the memory is cancelled and the tape counter reverts to timecode.
- The camera remembers your setting even if you turn it off and back on again or move the program selector.

The Dubbing Function

E

The MV30/MV30i's Dubbing Function allows you to easily rerecord scenes from an original tape to a tape in your VCR. Spice up the new tape by dubbing only your favourite scenes, reordering scenes or adding special effects and varied scene transitions.

1. Prepare the camera.

Connect the camera to your VCR, and place it so that it can control your VCR by remote control.

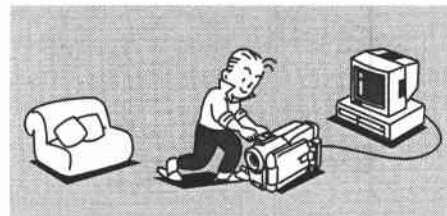

2. Select your brand of VCR.

The camera can send the remote control signals of almost any brand and model of VCR. Just choose your brand of VCR, and the camera commands it when to start and pause recording.

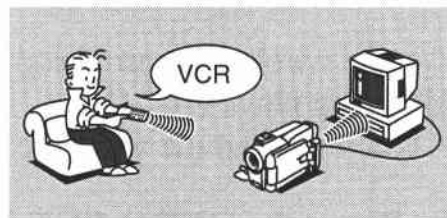

3. Start dubbing.

If desired, select a fader or effect, then play back the tape from the beginning of the scene you want to dub. The scene is automatically recorded to the tape in the VCR with the selected fader or effect.

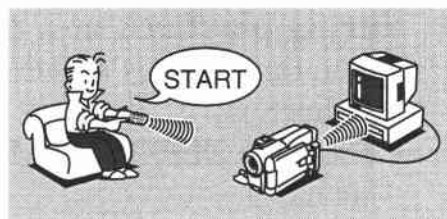

Preparing for dubbing

See your TV or VCR instruction manual for further details.

1. Connect the camera to the VCR.

- See the "Connections for Playback on a TV Screen" instructions on p. 28.

2. Turn the TV on.

- Set the TV/Video selector on the television to Video.

3. Turn on the VCR and load a blank cassette.

- See your VCR instruction manual.

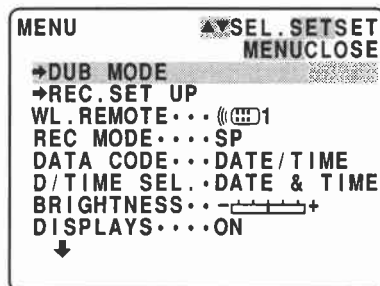

- 4. Open the PLAY (MV30i: VCR) menu and select →DUB MODE.**
- When you select the DUB MODE menu all the displayed information is also displayed on the screen of the TV connected your VCR. However, this information will not be recorded onto the tape in the VCR.

Setting the camera to control your VCR

The camcorder's Dubbing Function controls your VCR by using the same infra-red signals as the VCR's remote control.

Make sure the camera is in a spot where it can remotely control your VCR.

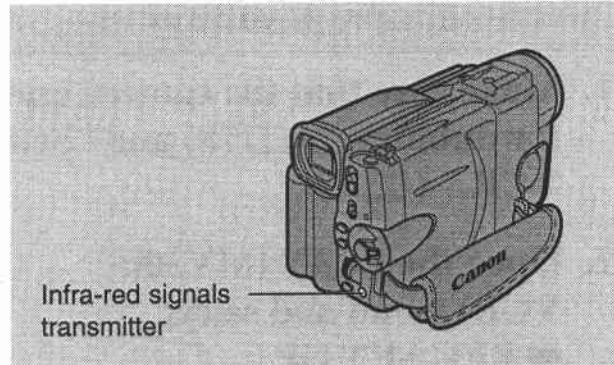

- 1. Check where the remote control sensor is on your VCR using its normal remote control.**
- 2. Place the camera pointing directly at the sensor, not more than 50 cm (20 inches) away.**
 - Check that the sensor will pick up signals easily from this spot using the VCR's normal remote control.
 - Make sure that the cables and the camera's shoulder strap do not obstruct the signals.
- 3. Make sure that the VCR is in record pause mode.**
- 4. Make sure that all other video equipment is turned off to avoid accidental recording.**

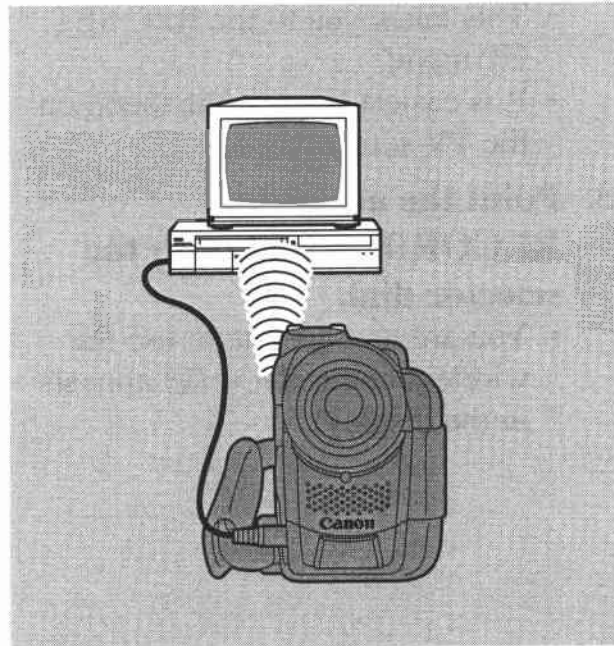

Using the Dubbing Function for the First Time

E

When you use the dubbing function for the first time, or with a different VCR, you should set your camcorder to send the correct remote control signals to your VCR.

The camera will not forget this setting unless you change it. Do not alter it again unless you change VCRs.

Preparations & setting up

1. Make sure that the camera and VCR are set up as in “Preparing for dubbing,” (□ 78) and “Setting the camera to control your VCR,” (□ 79).
2. Open the PLAY (MV30i: VCR) menu and select →REC.SET UP.
 - This takes you to the REC.SET UP menu.
 - It is easiest to view the menu on the TV screen.
3. Point the arrow to RECORDER and push the selector dial.
 - You are now unable to use the wireless controller (Ⓜ appears in the display).

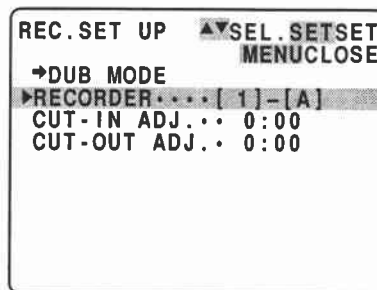
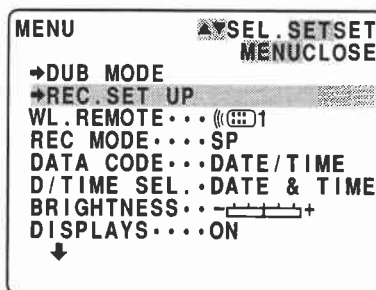

Setting RECORDER

E

Use the chart on the next page to find the RECORDER settings for your brand of VCR. Make sure the camcorder's infra-red control signals can reach the VCR, and the VCR is in record pause mode. (Ready to record and on pause.)

1. Set RECORDER to the first setting for your brand of VCR.

- For example, 7-A if you have a JVC VCR.
- Turn the selector dial to scan the numbers.

RECORDER ▶ [7] - [A]

- Press the selector dial in to select the number corresponding your brand of VCR.

RECORDER ▶ [7] - [A]

- Turn the selector dial to scan the letters. TRANSMITTING DATA appears in the display each time you turn the selector dial.

2. If the setting is correct, the VCR will start recording automatically.

- This will occur as long as the camera is pointing at the VCR's remote sensor while you change the setting.

3. If the VCR does not start recording, try the next setting.

- Turn the selector dial (to 7-B in the above example).
- Try each setting in turn until the VCR starts to record.

4. Depending on the brand of VCR, the signals to start and pause recording may differ. Once the VCR starts to record, check that the setting is right.

Set the VCR to record pause again, then press the camera's start/stop button.

- The VCR should start to record for a few seconds, and REC appears in the display and on the TV screen. Then it will automatically pause and PAUSE appears in the display and on screen.
- During these REC, PAUSE operations, START/STOP TIMING ADJ appears in the display and the VCR records a digital timer, which you will use later for Cut-In and Cut-Out Adjustments. For more accurate adjustments, we recommend that you repeat pressing the start/stop button to record a couple of times.
- If not, then the setting is still not right. Try the next setting.

Editing

RECORDER

The camera's Dubbing Function can remotely control almost all brands and models of VCR. VCR remote control signals vary depending on model and brand. First, choose the right RECORDER setting for your VCR. The number indicates the VCR brand. The letter indicates the set of signals.

Brand	Settings	Brand	Settings	Brand	Settings
Canon	1-A to 1-C	Pioneer	11-A	Thomson	18-A to 18-C
Aiwa	2-A to 2-C	Sanyo	12-A to 12-C	Saba	
Akai	3-A to 3-C	Fisher		Nordmende	
Fujitsu	4-A	Sharp	13-A to 13-C	Ferguson	19-A to 19-C
Funai	5-A	Sony	14-A to 14-F	Grundig	20-A to 20-C
Hitachi	6-A to 6-B	Toshiba	15-A to 15-B	Nokia	21-A to 21-C
JVC	7-A to 7-C	GE	16-A to 16-B	Telefunken	22-A to 22-B
Mitsubishi	8-A to 8-D	RCA		Zenith	23-A
NEC	9-A to 9-D	Magnavox	17-A to 17-B	Samsung	24-A to 24-B
Panasonic	10-A to 10-G	Philips	18-A to 18-C	GoldStar	25-A
Blaupunkt		Seleco			
Quasar		Rex			

as of January 2000



- Once you find the correct setting, remember this and do not change it unless you change VCRs.
- See p. 84 for details of the “cut-in” and “cut-out” adjustments.
- If you try all the numbers and letters, but the VCR has still not started to record:
 - Check the VCR is ready to record, and on pause.
 - Check the VCR can receive signals from where the camera is, and that nothing is blocking the signals.
 - Go back and try to set it again.

- If your brand of VCR is not on the chart, or you cannot find the correct setting, try all the numbers with the selector dial until the VCR starts to record.
- It is unlikely, but you may have a VCR the Dubbing Function cannot control. If so use the Simple Editing method, on p. 86.

Dubbing to a VCR

E

1. Make sure you are in the DUB MODE menu.

- If you choose not to set a fader or effect, move the arrow to DUB STANDBY, and each of the options will be automatically set to OFF.

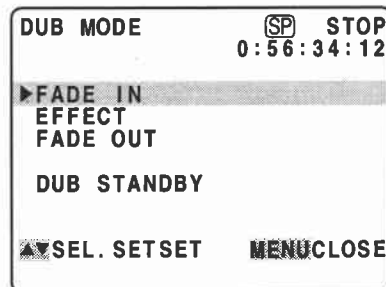

2. Select FADE IN, EFFECT or FADE OUT.

- Point the arrow at “FADE IN” and press the selector dial in.
- Fade in settings appear.
- Point the arrow at your desired setting and press the selector dial in again.
- The display returns to DUB MODE menu.
- Set “EFFECT” or “FADE OUT” in the same way.
- See also “Using Digital Effects” starting on p. 55 for more information on digital effects.

3. Move the arrow to DUB STANDBY.

- WIND THE TAPES AND PAUSE → SET appears in the display.

4. Set the tape in the VCR to the point where you want to start recording, set it to record pause mode.

Set the tape in the camera to the point where you want to start dubbing, set the camera to playback pause mode.

- You can use the playback buttons on the LCD panel or the special playback functions on the wireless controller in the same way as in playback mode.

5. Press the selector dial in.

- START PRESS PLAY/PAUSE TO START DUB appears in the display.
- Now you are unable to use the wireless controller.

6. Press PLAY on the body of the camera.

- Recording starts.
- NOW DUBBING appears in the display.

7. When you reach the end of the scene you want to record, press PAUSE on the body of the camera.

- The camera returns to playback pause mode and the VCR automatically switches to record pause mode.
- The camera returns to the DUB MODE menu.
- When you finish dubbing, press the MENU button. The camera returns to PLAY (MV30i: VCR) mode.
- If you set the zero set memory at the position on the tape where you want to stop dubbing, every time you return to that point, the camera will cancel its dubbing and enter playback pause mode, and the VCR, record pause mode.



- To cancel during dubbing, push STOP on the body of the camera.

Cut-In and Cut-Out Adjustments

E

Setting the Cut-In and Cut-Out Adjustments

The point where a scene starts is called the “cut-in” point, and the point where it ends is called the “cut-out” point.

Some VCR models take a second or more to actually start recording after they receive the command signal. If this happens you could lose the beginning of the scene. CUT-IN ADJ. prevents this by sending the command a little early.

Similarly, some models take some time to react to the command to stop recording. Some models also rewind slightly after they stop. You could therefore record more than you wanted, or lose the end of the scene. CUT-OUT ADJ. prevents this, by sending the command a little early or late.

If you have these problems with your VCR, reset these adjustments.

Use the REC.SET UP menu to set the “cut-in” and “cut-out” adjustments.

1. Open the REC.SET UP menu and select CUT-IN ADJ.

- Point it at “CUT-OUT ADJ.” to set the cut out adjustment.

2. Adjust the setting.

- CUT-IN ADJ. can be set up to five seconds early. (-5:00)
- CUT-OUT ADJ. can be set from one second early to five seconds late. (-1:00 to +5:00)
- This can be set to an accuracy of one frame.

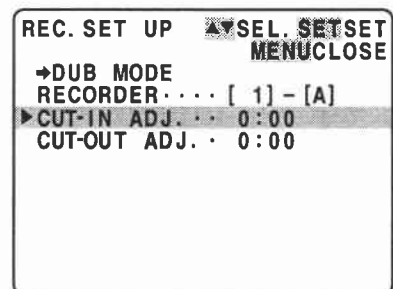

How to calculate the best adjustment for the “cut-in” and “cut-out” points

E

Use the tape on which you recorded the digital timer in “Setting RECORDER” to calculate the cut-in and cut-out adjustment values.

1. Rewind the tape in the VCR and play back the recorded digital timer.

- Look at the time the CUT-OUT timer stops and CUT-IN timer starts. These times are what the CUT-OUT ADJ. and CUT-IN ADJ. settings should be.
- For maximum accuracy, take an average of at least three readings.
- If your VCR has a frame advance function or a jog dial, you can use it to find the precise starting times more conveniently.

2. Set the CUT-OUT ADJ. and CUT-IN ADJ. settings to the centre of the three readings.



- The camcorder will remember the cut-in and cut-out adjustment settings until you change them.



Editing

Simple Editing to a VCR

E

If you cannot find the appropriate remote control setting for the camcorder to control your VCR, you still can edit a tape to the VCR as follows.

Preparations

1. **Connect the camera to the VCR.**
 - See “Connections for Playback on a TV Screen” on p. 28.
2. **Prepare the TV and VCR.**
 - Turn on the TV and set it to the video channel, or set the TV/VIDEO selector to VIDEO.
 - Turn on the VCR, and set its input selector to LINE. Load a blank cassette, and put the VCR in record pause mode.
 - See your TV and VCR instruction manuals for details.
3. **Turn the camera’s POWER switch to PLAY (MV30i: VCR), and load your recorded cassette.**

Basic editing

1. Find a point on your recorded cassette slightly before the section you want to copy.
2. Start to play it back while you monitor the picture on the TV.
3. Start recording on the VCR as soon as the section you want to copy appears on the screen.
4. Pause the VCR at the end of the section you want to copy, then stop playback on the camera.
5. Repeat steps 1 to 4 until your edited recording is complete.





- The quality of the edited tape will be slightly lower than that of the original.

(LANC) terminal

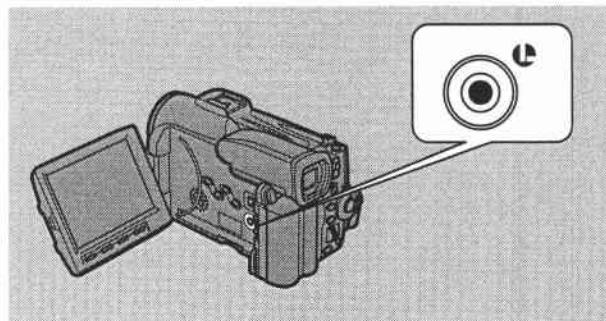
The  terminal allows you to connect the camera to equipment. Some buttons on editing equipment may operate differently from those on the camera.



-  (LANC) is a trademark. It stands for Local Application Control Bus System.
- We cannot guarantee the results when connecting to equipment not bearing the LANC  symbol.

Dubbing with Digital Video Equipment

MV30

E

DV terminal/connections

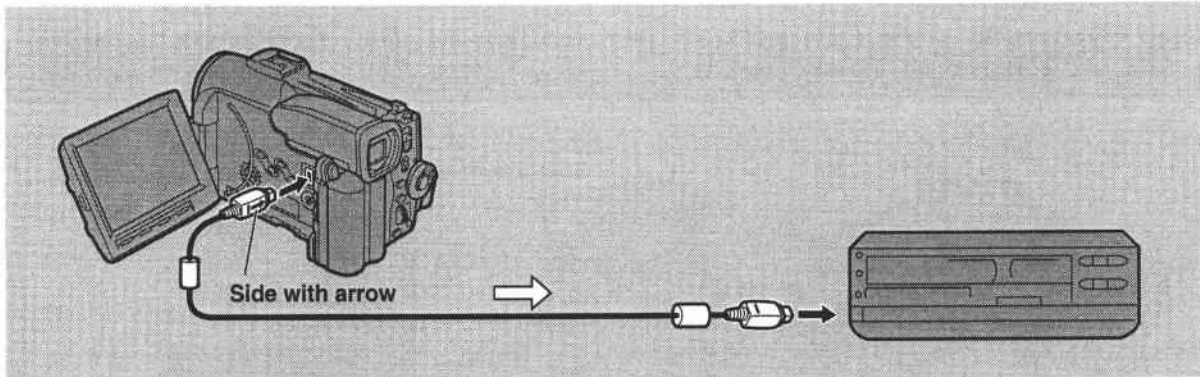

Digital video equipment fitted with this terminal lets you edit, copy and transfer data digitally, with virtually no generation loss in image and sound quality.

Use the optional CV-150F DV cable to connect two digital devices together. Make sure you connect the cable to the MV30 before connecting the other end of the cable to the recording device.



Editing

MV30i

The MV30i is equipped with the DV Recording function. The MV30i is only available in certain areas.

DV terminal/connections

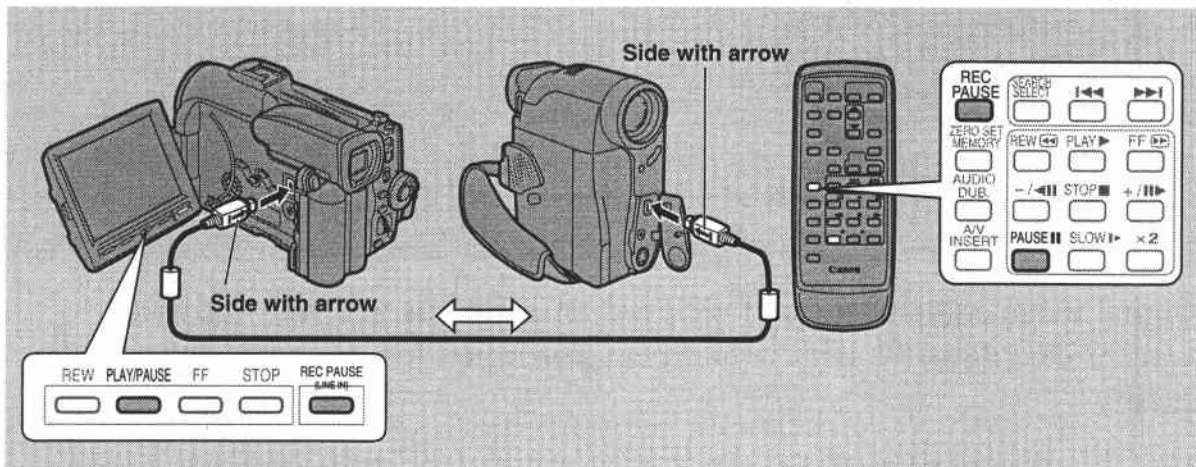

Digital video equipment fitted with this terminal lets you edit, copy and transfer data digitally, with virtually no generation loss in image and sound quality. The DV terminal is for both line-in and line-out, since a single DV cable can handle data in both directions.

- If another Canon digital video camcorder is connected, the Dubbing Function can be used for digital-to-digital dubbing (i.e. with virtually no generation loss in image quality).
- If a VCR is connected and an anomalous signal is sent from the VCR, the images recorded on the tape may also be anomalous (although it may not appear so on the TV image), or not recorded at all.
- You are unable to dub tapes recorded with the copyright protective signal.

Dubbing to the camera:

Operate from the controls on the LCD panel or the wireless controller.

1. Use a Canon CV-150F DV cable (optional) to connect two digital devices together. Load a blank tape into the camera and a recorded tape into the other digital device.

- Connect the DV cable with the sides of the plugs marked with the arrows facing as shown above.
- Make sure the REC/SAVE tab on the blank tape has been slid to REC (closed position).

2. Turn the POWER switch to VCR.

3. Press the camera's REC PAUSE button and start playback on the other digital device.

- The camera enters record pause mode.
- DV IN appears in the display when the playback device starts playback.

4. To start/pause dubbing, press the PAUSE button.

- You can monitor the image in the display as you dub.
- Press STOP to finish dubbing.



- If the cable is not connected properly, or if the cable is unconnected when you press REC PAUSE, the camera displays the caution "CHECK THE DV INPUT." An anomalous image may also flash onto the screen.
- When you are recording from the MV30i, make sure you connect the cable to the MV30i before connecting the other end of the cable to the recording device.
- Blanks between recordings on the playback tape are recorded as anomalous images on the tape that is being recorded to.
- During DV dubbing, you cannot add digital effects or faders or set the cut-in and cut-out adjustments using the built-in digital timer.

Copyright signal

Certain pre-recorded software tapes are copyright protected. If you try to play back such a cassette, "COPYRIGHT PROTECTED PLAYBACK IS RESTRICTED" appears in the display for a few seconds and then the camera displays a blank blue screen; you cannot view the contents of the cassette. If you try to record from such a tape via the digital cable "COPYRIGHT PROTECTED DUBBING RESTRICTED" appears in the display; you cannot record the contents of the tape.

Recording Over Existing Scenes — A/V Insert Editing (MV30i only)

E

You can insert new scenes from another DV camcorder onto your pre-recorded tape. Original video and audio will be replaced with the new video and audio.

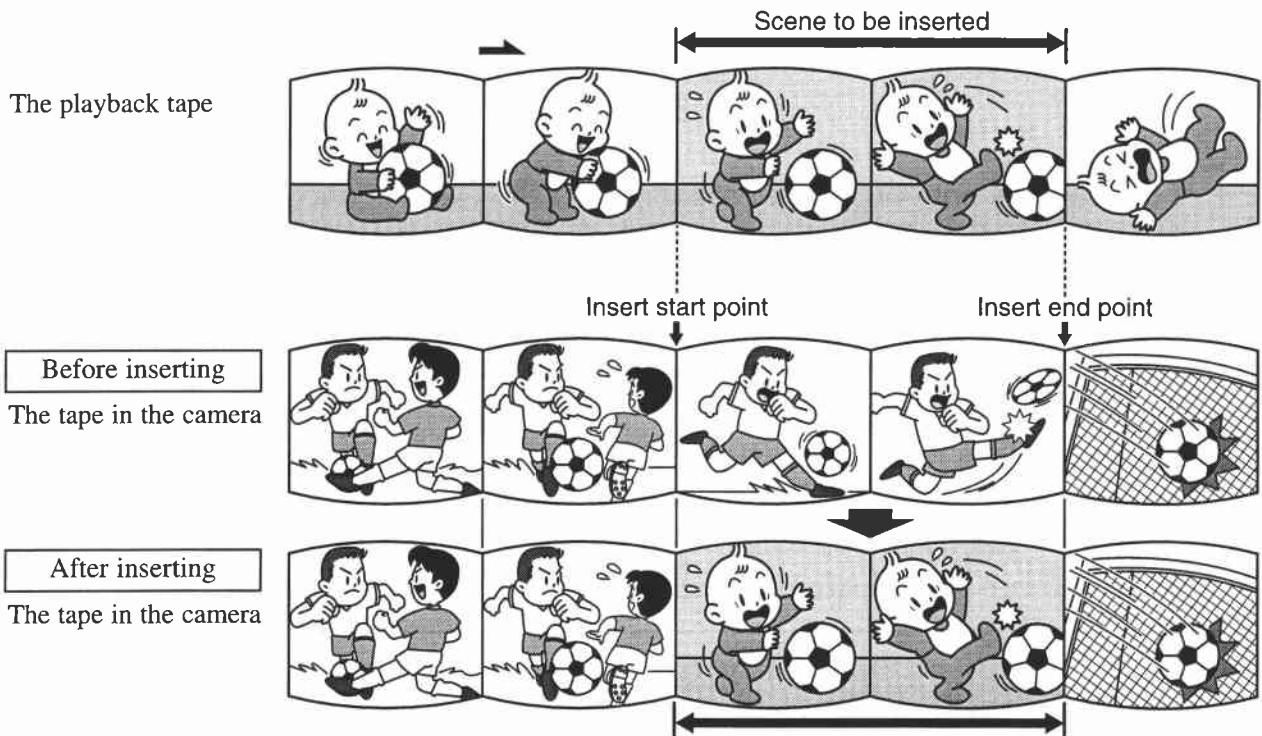

The video and audio of the new scene replace that of the old.

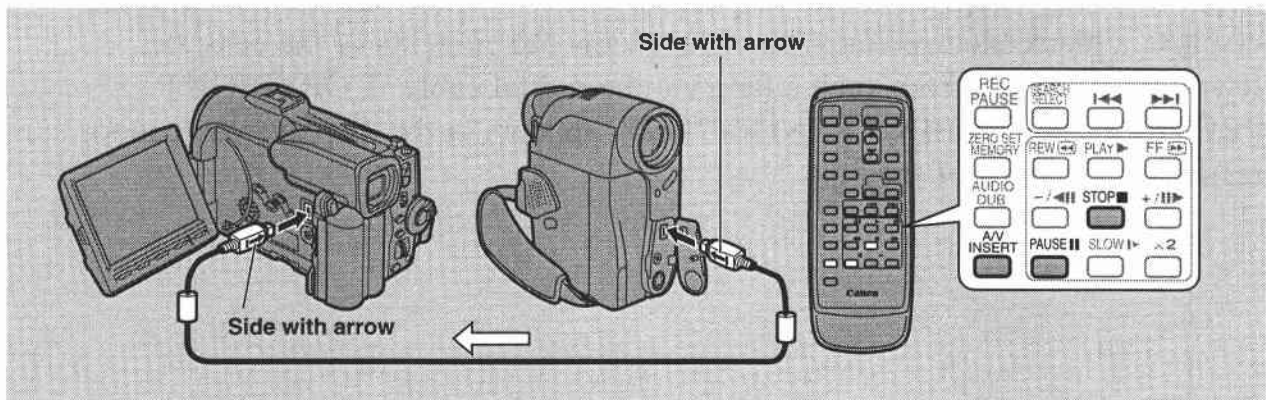

Editing

The tape in the MV30i:

When using the MV30i's A/V insert function, only record to tapes recorded in SP mode with continuously recorded time codes.

If there are non-recorded portions or portions recorded in LP mode on the tape, recording will stop.

The playback tape:

Use only tapes without non-recorded portions.

If there are non-recorded portions or changes in the recording mode, you may not be able to insert A/V correctly.

You cannot insert A/V in the following case:

- The playback tape has been poorly recorded.

Use the wireless controller to operate A/V insert.

- 1. Connect the MV30i to another camcorder, load recorded tapes into both the camcorders.**
 - Make sure the REC/SAVE tab on the tape has been slid to REC (closed position).
- 2. Turn the MV30i's POWER switch to VCR.**
- 3. On the other camcorder, locate a point three seconds before the scene to be inserted. Set it to playback pause mode.**
- 4. On the MV30i, locate the recording start point. Set it to playback pause mode.**
 - You can use the playback buttons on the LCD panel or the special playback functions on the wireless controller in the same way as in playback mode.
- 5. Press the A/V INSERT button on the MV30i's wireless controller.**
 - A/V INSERT and ●■■ appear in the display.
- 6. On the other camcorder, playback the tape.**
- 7. When you get to the starting point of the scene to be inserted on the tape, push the PAUSE button on the MV30i.**
 - A/V insert starts.
 - ●■■ changes to ●.

**E**

8. When you get to the point where you want to stop inserting, press the STOP button of the MV30i.

- Inserting stops and A/V INSERT disappears from the display. The camera returns to stop mode.
- If instead of pressing stop you press pause, the camera returns to the A/V insert pause mode.
- If you set the zero set memory at the position on the tape where you want to stop inserting, every time you return to that point, the camera will cancel its A/V inserting and enter stop mode.

9. Press the STOP button of the other camcorder.

Audio Dubbing

You can add sound to the original sound on a prerecorded tape recorded in the SP mode with 12-bit sound. Use the internal or an external microphone. The original sound will not be erased.

For best results, add sound to tapes that have been recorded with this camera in SP mode with 12-bit sound. If there are non-recorded portions on the tape, or portions recorded in LP mode, or with 16-bit or 12-bit, 4-channel sound, dubbing will stop. You cannot dub audio onto a tape recorded with 12-bit and 16-bit sound intermingled.

To connect an external microphone:

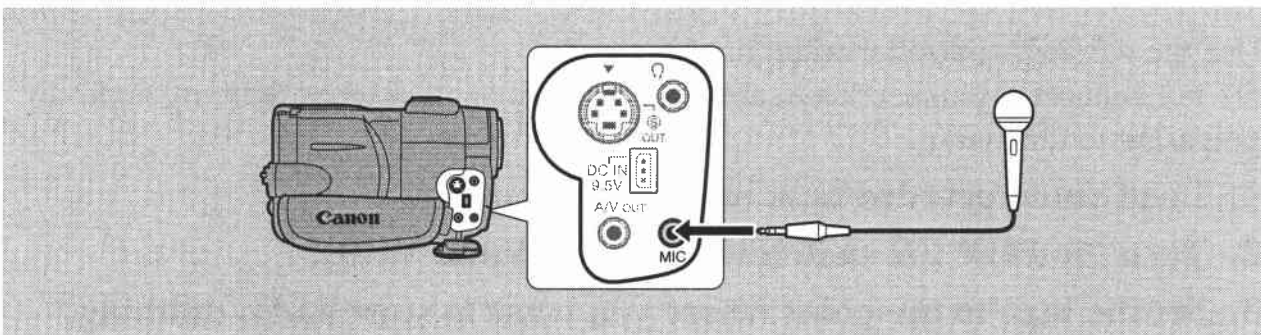



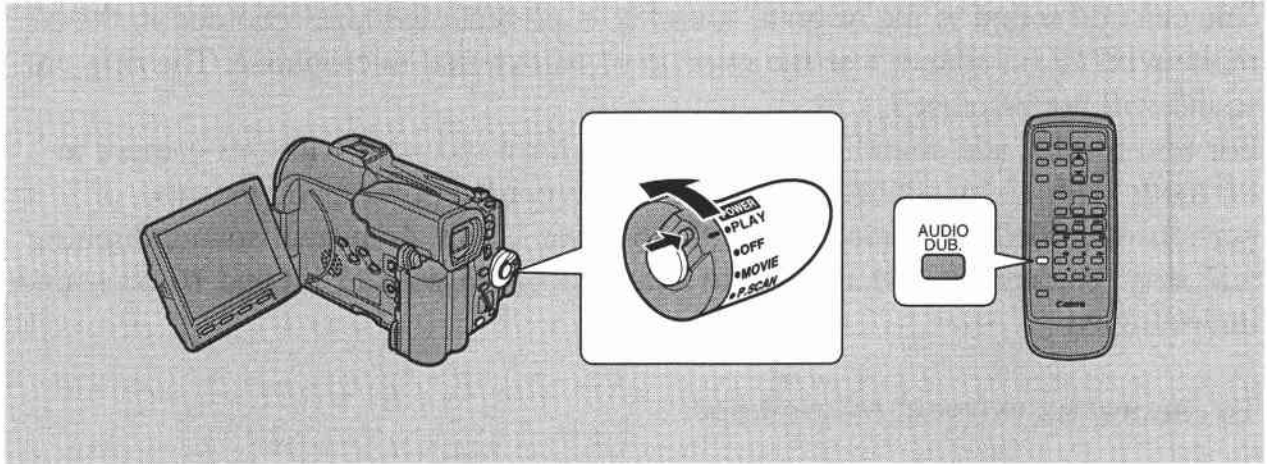

- When using an external microphone → Connect it to the microphone terminal.
(It works even if the DM-50 microphone (optional) is connected to the accessory shoe.)
- When using the DM-50 microphone → Make sure nothing is connected to the microphone terminal.
- When using the built-in microphone → Make sure nothing is connected to either the microphone terminal or the accessory shoe.
- To use your TV to monitor video, connect the S-video terminal or the A/V terminal (use only the video plug) to your TV. You can monitor the sound with headphones.



Use the wireless controller when dubbing audio.

Do not connect/disconnect any cables to/from the camera when dubbing audio or preparing to dub audio.

1. **Load your recorded tape into the camcorder.**
2. **Turn the POWER switch to PLAY (MV30i: VCR).**
3. **Set the tape to the point where you want to start audio dubbing.**
 - You can use the playback buttons on the LCD panel or the special playback functions on the wireless controller in the same way as in playback mode.
4. **Press the PAUSE button.**
 - The camera becomes set to playback pause mode.
5. **Press AUDIO DUB. on the wireless controller.**
 - AUDIO DUB. and  appear on the display.
 - If you have the DM-50 microphone (optional) attached,  (Connection) appears in the display.
6. **Press the PAUSE button.**
 - Audio dubbing starts.
 - Direct your voice into the microphone.
 -  changes to .
7. **When you get to the point where you want to stop dubbing, press the STOP button.**
 - Audio dubbing stops and AUDIO DUB. disappears from the display.
 - The camera returns to stop mode.
 - You can also set zero set memory ( 77) at the place you want to stop audio dubbing, then every time you return to that position, audio dubbing will cancel.
 - If instead of pressing STOP you press PAUSE, the camera will return to the playback pause mode.



- You can not use the DV terminal while adding sound.
- You might want to adjust the audio mix ( 96) when playing back a tape with added sound.
- There may be a loss of sound quality if you add sound to a tape recorded on a camcorder other than the MV30/MV30i.
- After adding sound three or more times to the same place on a tape, there may be some loss in sound quality.

Setting the Audio Mix

E

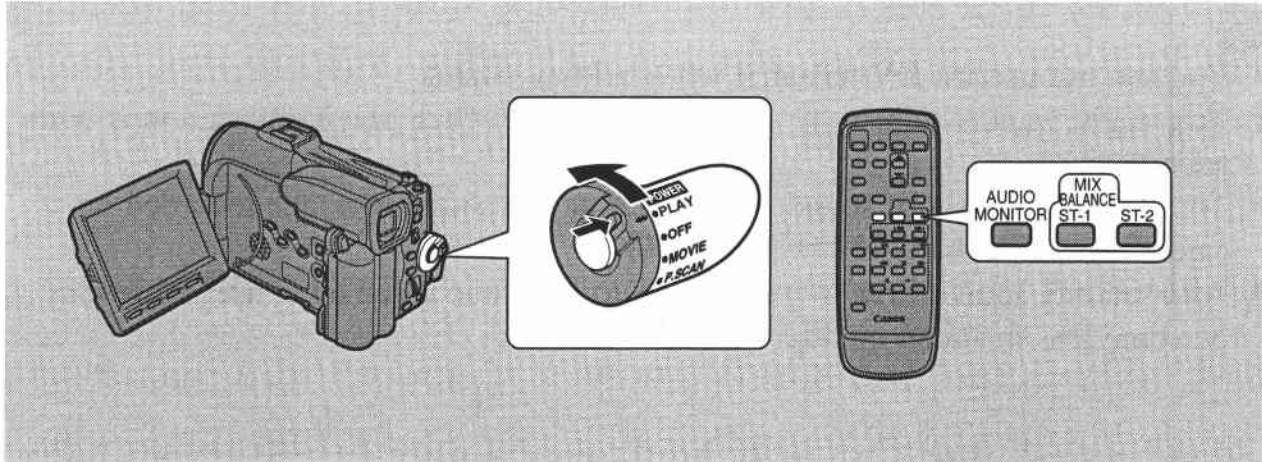

When you play back a tape that was recorded in 12-bit mode, you can set the audio output to play: stereo 1 (the original sound), stereo 2 (any new sound, dubbed to the tape after recording), or mix the balance between the two.

- Audio from the 16-bit mode only contains stereo 1 sound and so you cannot/do not need to select the audio mix. The same is true for the 12-bit stereo 1 mode, unless new sound has been added post-recording.
- You can choose the output using the wireless controller only.

1. Turn the POWER switch to PLAY (MV30i: VCR).

2. Choose the output.

- Press AUDIO MONITOR on the wireless controller.
- Starting with the last selected setting, four settings appear as you push the button:
 - STEREO1 for just stereo 1.
 - STEREO2 for just stereo 2.
 - MIX/FIXED for an equal mix of stereo 1 and 2.
 - MIX/VARI. (mix variable) for when you want to mix the balance between stereo 1 and 2.
- To simply choose STEREO1, STEREO2 or MIX/FIXED, make sure your choice appears on the display.
- If you choose MIX/VARI., you can go on to mix the balance.
- Use the ST-1/ST-2 keys to mix the balance. A bar showing the mix appears on the screen for four seconds.



- When you have chosen the output, STEREO1, STEREO2, MIX/FIXED or MIX/VARI. is shown in the top left of the display for a few seconds. If you turn the power off the output is set to STEREO1.

Selecting audio output channels

E

When you play back a tape whose audio has been recorded on multiple channels, you can change the output channels of that sound.



▶OUTPUT CH...L/R

1. Turn the **POWER** switch to **PLAY** (MV30i: VCR), load a tape recorded with multiple-channel audio.
2. Open the **PLAY** (MV30i: VCR) menu and select **OUTPUT CH**.
3. Select the output channel.
 - Refer to the following list.

OUTPUT CH setting	Played back sound	
	Tape recorded with stereo sound	Tape recorded on multiple channels
L/R	L+R channels	main + sub
L/L	L channel only	main only
R/R	R channel only	sub only

Preparing the Camera

E

Adjust the viewfinder

- Turn the POWER on and set the camera to record pause mode. Extend the viewfinder straight out, then adjust the viewfinder focusing lever to suit your eyesight.
- Rotate the viewfinder to an angle that allows you to view comfortably. Store the camera with the viewfinder flush with the body of the camera.
- To view with the viewfinder, make sure the LCD panel is either turned so that the subject can monitor viewing, or totally closed with the screen facing inwards.

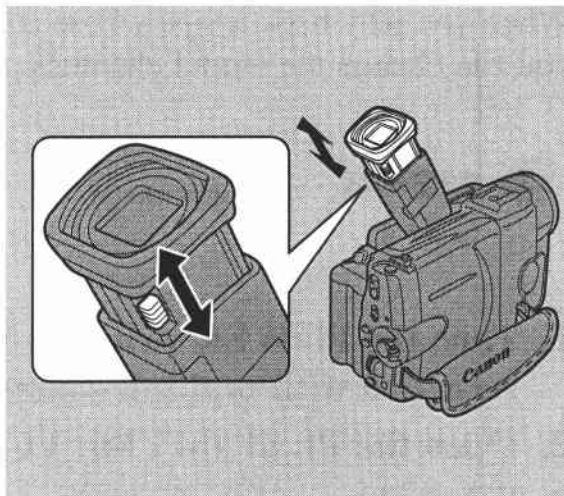

Prepare the lens cap

- Attach the cord to the lens cap, and pass the grip belt through the loop on the cord.
- Hook the lens cap on to the grip belt while you are recording, and place it over the lens when you have finished.

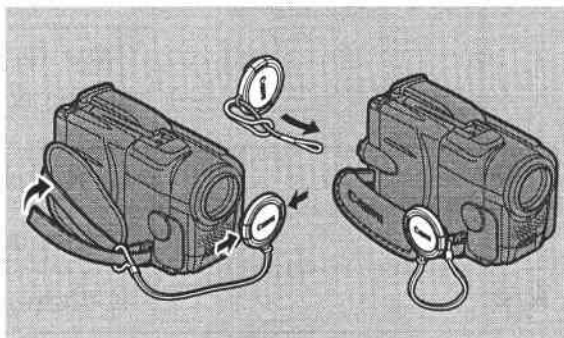

Fasten the grip belt

- Release the Velcro fastening and hold the camera with your right hand while you adjust the belt with your left. Your index finger should reach the zoom lever and photo button, and your thumb should reach the start/stop button comfortably.

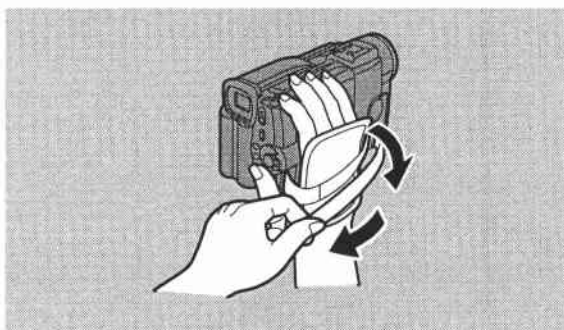

Attach the shoulder strap

- For extra security and portability, attach the shoulder strap before using the camera.
- Pass the ends through the attachment bars and adjust the length as shown.

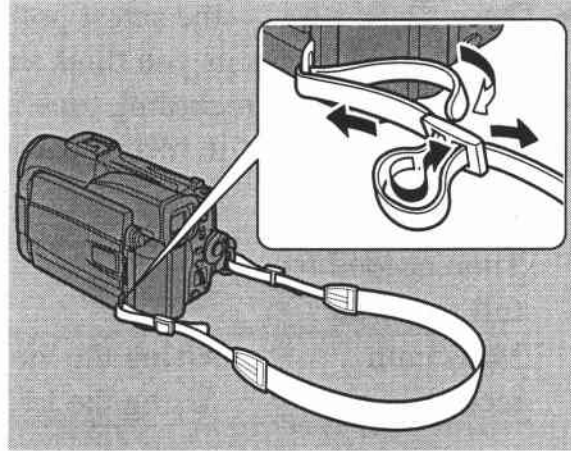

- Be careful not to leave the viewfinder exposed to bright sunlight, or it will melt. (The light is concentrated by the viewfinder lens.) Adjust the angle of the viewfinder to prevent sunlight from entering.

Notes on Using the Batteries

E

Charging and recording times

- These times vary — the safest policy is always to have two or three times as many battery packs as you think you will need.
- You will get more recording time if you turn the camera off between shots, instead of leaving it in record pause mode.

Battery pack	BP-511	BP-522 (optional)
Time needed for full recharge	1 hr. 35 min.	2 hr. 35 min.
Maximum recording time	Using the viewfinder: 1 hr. 40 min. Using the LCD screen: 1 hr. 30 min.	3 hr. 40 min. 3 hr. 10 min.

- Recording time will be shorter than usual at low temperatures. You can use the battery pack between 0° to 40°C (32° and 104°F), but it works best between 10° to 30°C (50° and 86°F).
- If the battery pack starts to give you much less recording time than usual, it has reached the end of its life and must be replaced.



- These figures show how long you can view playback with the LCD, after attaching a fully-charged battery pack. Playback time will be shortened at low temperatures.

Battery pack	Playback time (using the LCD screen)
BP-511	1 hr. 45 min.
BP-522	3 hr. 35 min.

How much power is left?

The indicator in the display shows you approximately how much charge the battery pack has left:

100%

75%

50%

25%

0%
CHANGE THE BATTERY PACK

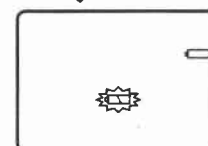

- “CHANGE THE BATTERY PACK” appears in the display for four seconds when the power is completely exhausted. The empty battery mark then appears and starts to flash. The power indicator light also flashes.
- The indicator is not constant — different levels will be shown when you subject the battery pack and camcorder to different conditions.

When to recharge

E

You can recharge a lithium ion battery pack whenever it is convenient. Unlike a conventional battery pack, it does not have to be fully discharged first. However, as the battery pack will naturally discharge itself over time, it is best to charge it the same day you plan to use it, or the day before.

Taking care of the battery pack

Always attach the terminal cover.

- Do not allow any metal objects to touch the terminals, as this can cause a short circuit and damage the battery pack. Attach the terminal cover whenever the battery pack is not being used.
- Remember to remove the terminal cover before using or charging the battery pack.

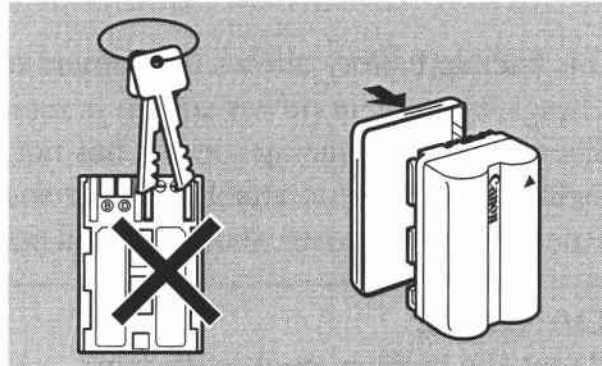

Keep the terminals clean.

- The camera, adapter or battery pack will not work properly if the terminals are dirty. Check them before use, and wipe them with a dry cloth or tissue if necessary.

Storing the battery pack

- If you do not use a battery pack for a period of more than a few months any remaining charge may cause damage to the battery pack, and reduce usage time. To prevent damage therefore, aim to use a battery pack's complete charge before storage. See the BP-511 and BP-522 instructions for further details.

Installing the backup battery

Pull out the battery holder from the base of the camera, and insert the CR2025 lithium battery with the + side facing upwards. Click the holder back into place.

- You may find it useful to use a small screwdriver to ease out the battery holder.

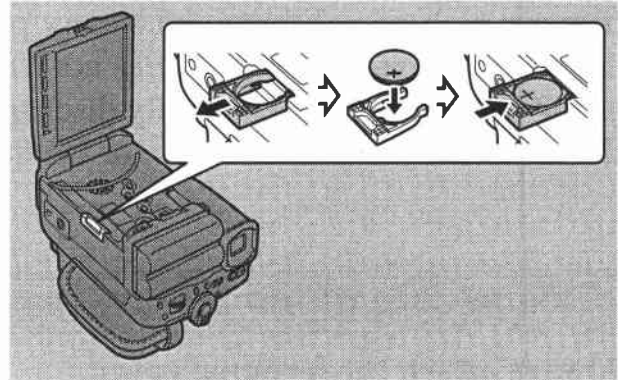

This backup battery allows the camera to remember the date and time and other settings when main power source is removed. It has a life span of about a year. When it needs replacing (or if it has not been installed), the  mark flashes in the display. Make sure to attach a power source to the camera first, so it will remember your chosen settings when you change the battery.

DANGER!

Treat the battery pack with care.

- Keep it away from fire (or it might explode).
- Do not expose the battery pack to temperatures greater than 60°C (140°F). Do not leave it near a heater, or inside a car in hot weather, for example.
- Do not try to disassemble or modify it.
- Do not drop or knock it.
- Do not get it wet.

WARNING!

- The battery used in this device may present a fire or chemical burn hazard if mistreated. Do not recharge, disassemble, heat above 100°C (212°F) or incinerate.
- Replace the battery with a Sony, Sanyo or Panasonic CR2025, or Duracell DL2025. Use of another battery may present a risk of fire or explosion.
- The used battery should be returned to the supplier for safe disposal.

Cautions:

- Do not pick up the battery using tweezers or other metal tools — this will cause a short circuit.
- Wipe the battery with a clean, dry cloth to ensure proper contact.
- Keep the battery pack out of reach of children — if it is swallowed, contact a physician immediately, as the battery case may break down and the battery fluids damage the stomach and intestines.
- Do not disassemble, heat or immerse the battery in water, to avoid the risk of explosion.

Maintenance

E

Cautions

Avoid high temperatures and high humidity.

- Do not leave the camera inside a car in hot weather, for example.
- Be careful of heat radiating from video lighting equipment.
- Do not take the camera into a humid room.

Avoid sudden changes in temperature.

- If you take the camera from a cold place to a warm place, condensation may form on the lens and internal parts ( 106).

Do not point the lens or viewfinder at strong light sources.

- Never point it at the sun, and do not leave it aimed at a bright subject.
- Be especially careful when leaving the camera on a tripod.

Avoid magnetic or electric fields.

- Do not use the camera close to TV transmitters, portable communication devices or other sources of electric or magnetic radiation. They may cause picture interference, or permanently damage the camera.

Do not expose the camera to water.

- Cover the camera when you are recording in rain or mist.
- There is a risk of electric shock if water gets inside the camera — contact qualified service personnel as soon as possible.

Protect the lens.

- Sand and dust can damage the lens — be especially careful on windy days.

Handle the camera gently.

- Vibration or shock can cause damage.
- Do not use the viewfinder or LCD panel as a carrying handle.

Do not disassemble the camera.

- This is very dangerous as there is a risk of electric shock — if the camera does not function properly, take it to qualified service personnel.

Storage

If you do not intend to use the camera for some time, store it in an area which is free of dust and moisture, and where the temperature is no higher than 30°C (86°F). After storage, check each part and function of your camera to make sure everything is still working properly.



- These cautions also apply to accessories such as battery packs and cassettes.

Maintenance

Viewfinder

- Clean the viewfinder screen. Rotate the viewfinder upwards. Remove the viewfinder protect cover and clean by inserting a cotton bud. When finished, return it flush with the camera.
- The viewfinder screen scratches easily. Take care when cleaning.

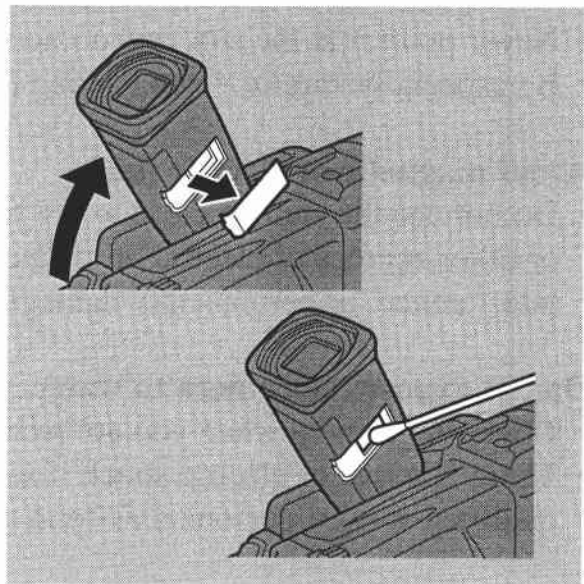

LCD

- Clean the LCD screen using a commercially available glass cleaner.
- Where there is a big change in temperature, moisture may form on the surface of the screen. Wipe clean with a soft, dry cloth.
- At low temperatures the display may appear to be much darker than usual. This is not a fault, and as the screen warms up the display will return to normal.

Camera body and lens

- Use a soft, dry cloth to clean the camera body or lens. Never use chemically treated cloth or volatile solvents such as paint thinner.

Video heads

- When mosaic-like noise appears on the playback picture, the video heads may be dirty. When the video heads are badly contaminated, the camera may show a blank blue screen.
- For the best picture possible, after using the camera for approximately 20 hours, clean the video heads using Canon's DVM-CL Digital Video Head Cleaning Cassette. If the "noise" remains, repeat the cleaning (up to maximum of five times).
- Do not use a wet-type cleaning cassette, as this can cause damage.

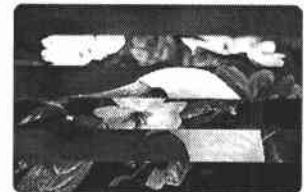

Using the camera abroad

E

Power sources

- You can use the compact power adapter to operate your camera and charge battery packs in any country where the electricity supply is between 100 and 240 V AC, 50/60 Hz. Contact your Canon dealer for information about plug adapters for overseas use.

TV playback

- Although you can always play back your recordings on the LCD screen, your camera can only be connected to TVs which use its PAL system. This TV system is used in the following countries:

Algeria, Australia, Austria, Bangladesh, Belgium, Brunei, China, Denmark, Finland, Germany, HongKong, Iceland, India, Indonesia, Ireland, Italy, Jordan, Kenya, Kuwait, Liberia, Malaysia, Malta, Mozambique, the Netherlands, New Zealand, North Korea, Norway, Oman, Pakistan, Portugal, Qatar, Sierra Leone, Singapore, South Africa, Spain, Sri Lanka, Swaziland, Sweden, Switzerland, Tanzania, Thailand, Turkey, Uganda, United Arab Emirates, United Kingdom, Yemen, former Yugoslavia, Zambia.

Condensation

Condensation may form on the camera when it is moved from a cold place to a warm place. Using the camera while condensation is present can damage both the tape and the camera.

Condensation may become a problem:

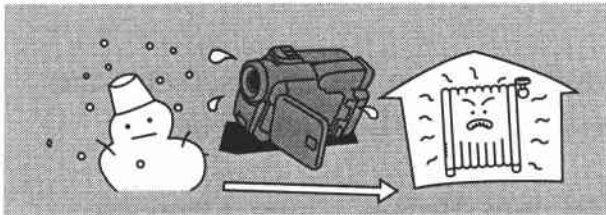

When you take the camera from a cold place to a warm room

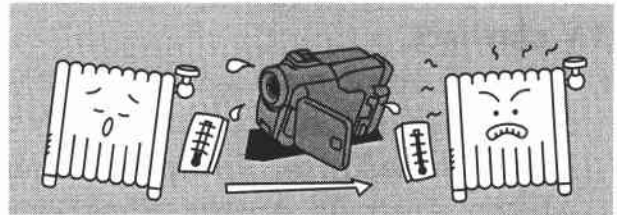

When a cold room is heated rapidly

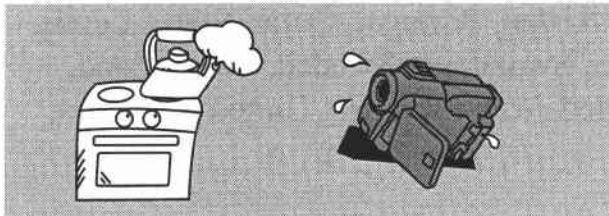

When the camera is left in a humid room

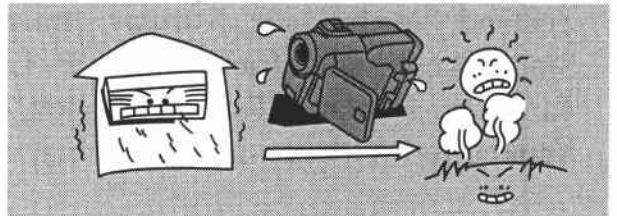



When the camera is taken from an air-conditioned room to a warm, humid place

Protecting the camera from condensation

- Before you take the camera to a warm or humid place where condensation is likely to be a problem, unload the cassette and put the camera in a plastic bag. Wait until the camera reaches room temperature before you take it out of the bag.

What happens when condensation is detected

- “CONDENSATION HAS BEEN DETECTED” is displayed for approximately four seconds. Then, the power indicator flashes and the  mark flashes in the display. If there is a cassette in the camera, it stops automatically and “REMOVE THE CASSETTE” is displayed for approximately four seconds and then  flashes in the display. If you have the beep turned on, it will sound.
- The camera may not detect the condensation immediately — the condensation warning may not start flashing for 10 to 15 minutes.
- You cannot load a cassette when condensation is detected.

What you should do

- Remove the cassette, leave the cassette compartment open, and turn the camera off.
- Leave it in a dry place until the condensation evaporates. After the condensation warning stops flashing, wait at least another hour before trying to use the camera.

Troubleshooting

Refer to this checklist first if you have any problems with your camcorder. Possible explanations are given for each problem on the list — turn to the page numbers in parentheses for more information.

Make sure that the camera is properly connected if you are using it with a TV or VCR. Consult your dealer or service outlet if problems persist.

E

Recording/Playback

Problem

? Nothing happens when I press the buttons.

Cause and/or what to do about it

- The camera is not switched on (16, 25).
- The cassette is not loaded or is set for erasure prevention (14-15).
- The tape has reached the end.
- The power source is not properly connected, or the battery pack is exhausted or not properly attached (9-13, 100).
- The function cannot be used in that recording program (51).

? The camera turned itself off.

- The camera was in record pause mode for more than about five minutes (16).
- The battery pack is exhausted (10-11, 100).

? The cassette compartment stopped mid-operation while loading/unloading a cassette.

- The battery pack's power is exhausted. Recharge or change to a new battery pack (10).
- The camera has malfunctioned. Consult your dealer or service outlet.

? The start/stop button doesn't work.

- The cassette is not loaded or is set for erasure prevention (14-15).
- The tape has reached the end.

? There's no picture in the display.

- The POWER switch is not set to camera mode (16).

? There's a blank blue screen in the display.

- You are attempting to play back or record from a copyright protected cassette (89).
- The video heads are badly contaminated (104).

? The camera won't focus.

- The camera is on manual focus (70).
- The viewfinder lens needs adjusting (98).
- The lens is dirty (104).



- Some subjects are not suitable for autofocus. In these situations, you will often get better results using manual focus (70). Focus on something which is about the same distance away, lock the focus, and then point the camera at your original, hard-to-focus subject.



Horizontal stripes



Many subjects at different distances



Behind glass

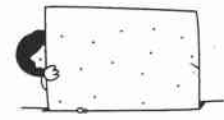

Without much contrast (e.g. a white wall)

Reflective surfaces
(e.g. shiny car surfaces)

Fast moving objects



Slanted subjects



Dark subjects



Night scenes

Recording/Playback (Contd.)

Problem

- ❓ Some/all of the digital effects don't work.
- ❓ The PLAY button doesn't work.
- ❓ There's a bright stripe on the screen.

Cause and/or what to do about it

- There are a number of restrictions on using the digital effects (55-60).
- The POWER switch is not set to PLAY (MV30i: VCR) (25).
- The cassette is not loaded (14).
- The tape has reached the end.
- When recording in dark places a bright light in the scene may cause a vertical light bar ("smear") to appear. This is a normal feature of camcorders.

- ❓ **The playback picture is rough (with mosaic-like noise).**
 - ❓ **There's no picture on the TV screen, even though the tape is moving.**
 - ❓ **There's no sound coming from the speaker during playback.**
- The video heads need cleaning (📖 104).
 - The video heads need cleaning (📖 104).
 - The TV/VIDEO selector on the TV isn't set to VIDEO (📖 28).
 - The speaker has been turned off with the selector dial (📖 24).
 - Headphones are being used.

Miscellaneous

Problem

- ❓ **The wireless controller doesn't work.**
- ❓ **The tally lamp doesn't flash.**
- ❓ **The power indicator is flashing.**
- ❓ **The camera malfunctions.**
- ❓ **The DV cable is connected correctly, but there's nothing in the display.**
- ❓ **The camera becomes warm during use.**

Cause and/or what to do about it

- The remote sensor mode is set to OFF (📖) in the menu (📖 38).
- The remote sensor modes of the wireless controller and the camera itself are different (📖 38).
- The batteries are dead or not inserted.
- It is turned off (📖 39).
- Check the screen displays (📖 115).
- External interference may cause the camera's microprocessor to malfunction temporarily. If random letters appear in the display or if normal operation is interrupted, remove and then replace the power source.
- Remove the cable and then reconnect it or turn the power off and back on again.
- This is not a malfunction.

The MV30/MV30i System Diagram (Availability differs from area to area)

E

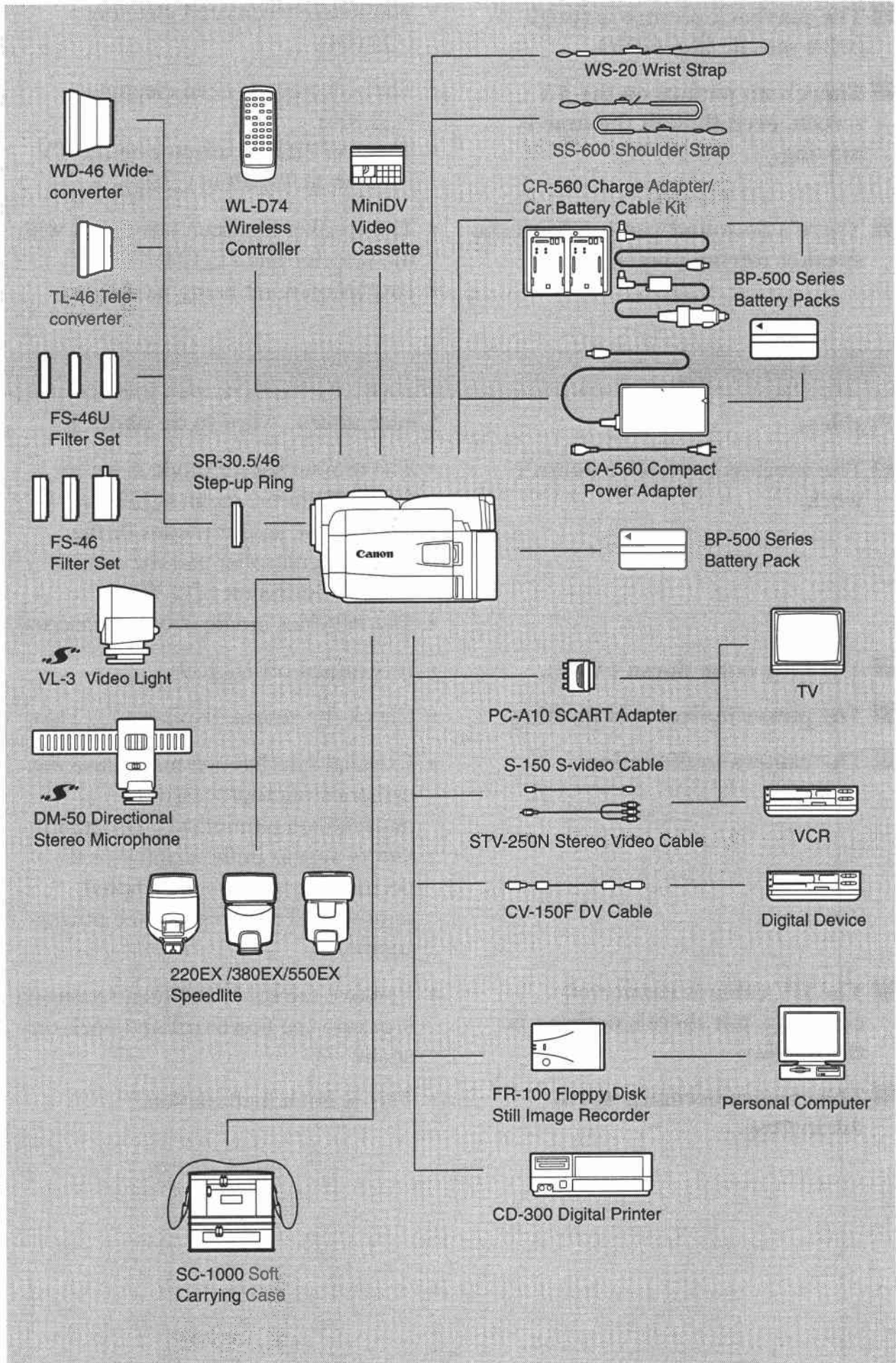

Additional Information

Optional Accessories

Battery packs

Extra batteries for use with the MV30/MV30i.

BP-511

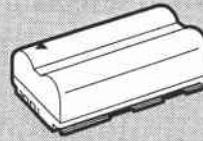

BP-522

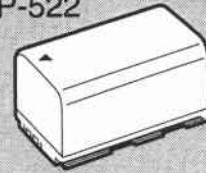

E

CR-560 Charge Adapter/Car Battery Cable Kit

Connect the car battery cable to power your camera or recharge battery packs on the move. The car battery cable plugs into your car's cigarette lighter socket and runs off a 12-24 V DC negative ground battery. Also, when used with the CA-560 Compact Power Adapter, this charge adapter can charge the BP-500 series lithium ion battery packs from a mains outlet.

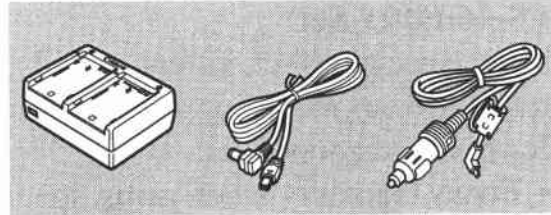

SR-30.5/46 Step-up Ring

This makes it possible to use the 46 mm filters and converters (shown below) with MV30/MV30i. When you attach the filter or conversion lens, you cannot use the supplied lens cap.

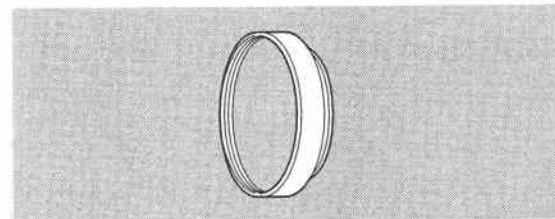

TL-46 Tele-converter

This tele-converter lens increases the focal length of the camera lens by a factor of 1.4.

- The image stabilizer is not as effective as usual when the tele-converter is attached.
- If you have a "professional-type" monitor, there may be some vignetting.

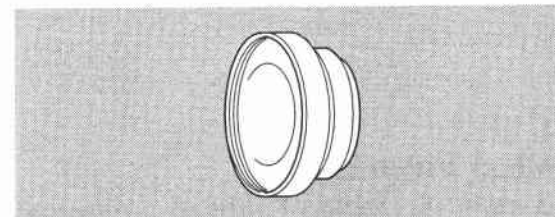

WD-46 Wide-converter

This lens decreases focal length by a factor of 0.7, giving you a wide perspective for indoor shots or panoramic views.

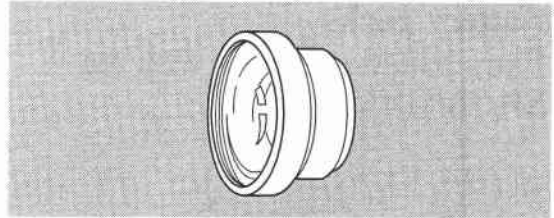
**FS-46 Filter Set**

Three special effects filters to add a creative touch to your recordings: multiple-image, R-cross and zoom-spot.

- Focus manually when using special effects filters.
- If you have a “professional-type” monitor, there may be some vignetting.

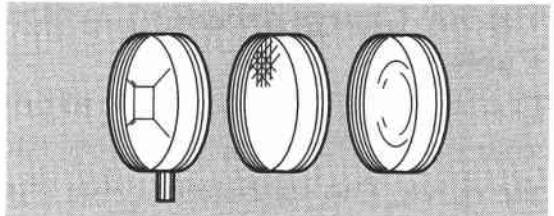
**FS-46U Filter Set**

Ultraviolet, neutral density and circular polarizing filters to help you take control of difficult lighting conditions.

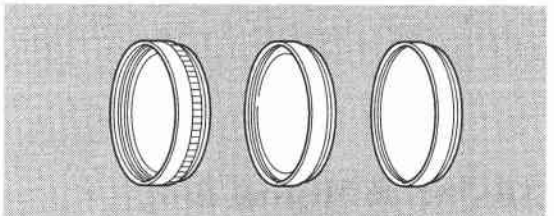
**220EX Speedlite****380EX Speedlite****550EX Speedlite**

Attach to the MV30/MV30i to give SLR- style flash photography.

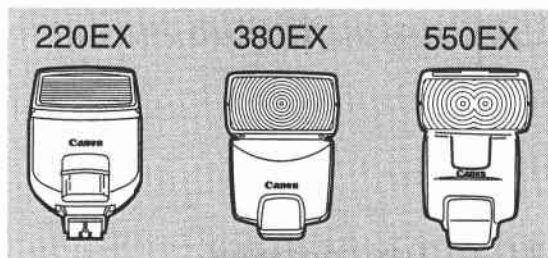
**VL-3 Video Light**

Attach the Video Light to a camcorder when recording in dark rooms. When on its automatic setting, the Video Light turns on/off automatically according to the brightness level of shooting conditions.



DM-50 Directional Stereo Microphone

This highly sensitive, super-directional microphone attaches to a camcorder's advanced accessory shoe. It is a highly sensitive microphone that can be switched between functioning as a directional microphone (monaural) or a stereo microphone that also clearly picks up sounds arriving from the front of the microphone, for full recorded sound.

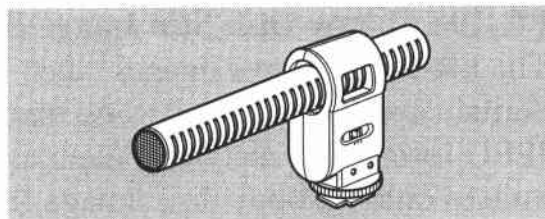

E

WS-20 Wrist Strap

Provides an extra measure of protection for active shooting.

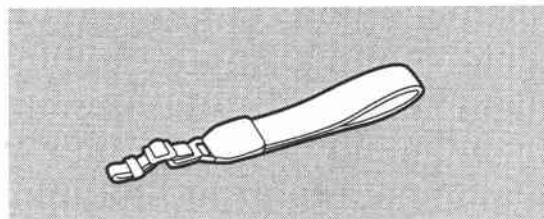

SC-1000 Soft Carrying Case

A handy camera bag with padded compartments and plenty of space for accessories.

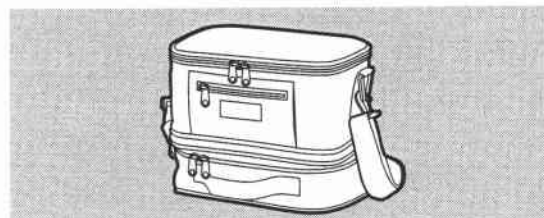

CD-300 Digital Printer

This 300 dpi resolution printer is perfect for printing out the high quality images taken with digital camcorders. Print out panorama prints, pictures without a white border, multiple-picture index cards, and add titles to pictures. A clear overcoat adds luster to your prints and reduces colour fading.

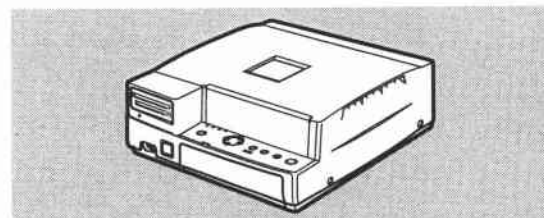

**Additional
Information**

E

FR-100 Floppy Disk Still Image Recorder

The FR-100 captures images taken with your digital camcorder, compressing them in JPEG format and recording them as still images onto a floppy disk. Image files can then be easily opened and viewed on your computer.

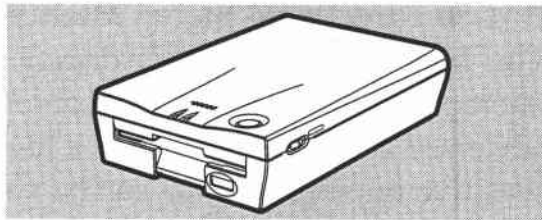

This mark identifies genuine Canon video accessories. When you use Canon video equipment, we recommend Canon-brand accessories or products bearing the same mark.

Screen Displays

To display the date and time, press the wireless controller's DATA CODE button.

Press the wireless controller's TV SCREEN button or turn TV SCREEN on through the camera menu to see the other displays on the TV screen. (The displays appear white on-screen.) They will not be added to any recordings you make with the camera. For instructions on how to hook the camera up to your TV, see p. 28.

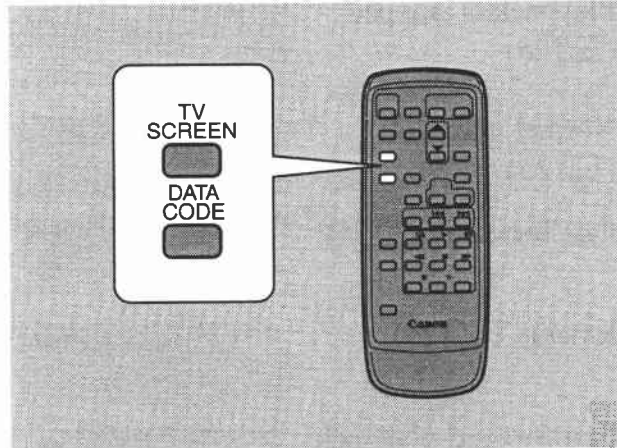

 indicates a flashing display.

E

Turning off the LCD screen displays

You can turn off the displays to give you a clear screen for playback. Set the camera to PLAY (MV30i: VCR) mode, open the PLAY (MV30i: VCR) menu and choose the DISPLAYS option. Set the displays to OFF and then close the menu.

- The LCD screen will now be completely blank, but the camera will continue to show warning/caution displays when necessary.

Record pause mode
( 16)



Remaining tape
(Green: more than five minutes.

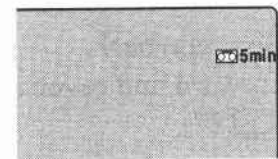

Recording ( 17)



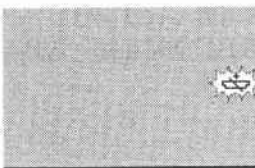

Yellow: less than five minutes.
Red: final few seconds.)

The backup battery is not properly installed, or needs replacing
( 102).

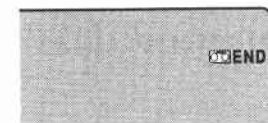

...finally, it tells you when you have completely run out of tape.



Shows how much battery power remains
( 100).



The camera is ejecting the tape ( 14).



The battery pack is exhausted ( 100).

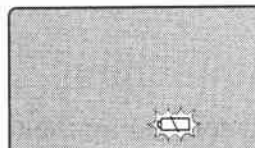

The safety mechanism is activated. Unload the cassette and turn the camera off. Turn it on again and reload the cassette.

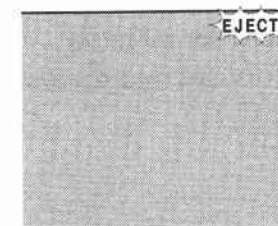

No cassette is loaded, or it is set for erasure prevention
( 14, 15).



Recording mode
( 18)



E

Playback is stopped
(25).



Normal playback
(25)



Fast forward (25)



Rewind (25)



Fast forward playback
(26)



Rewind playback
(26)



Frame advance
playback (27)



Frame reverse
playback (27)



Playback pause
(forward and reverse)
(26)



Slow playback
(forward and reverse)
(27)



x2 playback (forward
and reverse) (27)



x1 playback (forward
and reverse) (27)

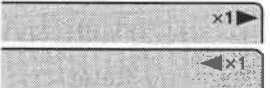
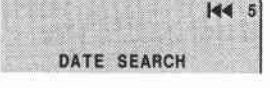

Photo Search (76)



Date Search (76)



Zero set memory
(forward and reverse)
(77)



Photo/Date search
(76)

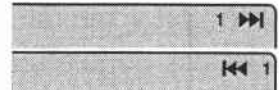

A/V Insert Editing
(90) (MV30i
only)



Audio Dubbing
(93)



Zoom display (20):
Optical zoom



Optical plus digital
zoom

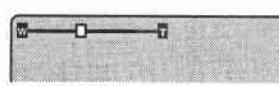

Zoom in

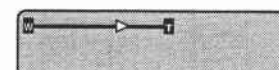

Zoom out



The image stabilizer
is turned on (33).



Camera menu
(34)

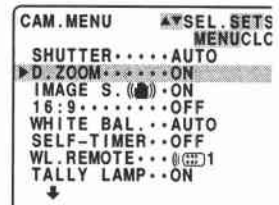

PLAY (MV30i: VCR)
menu (35)
(REC MODE : MV30i
only)

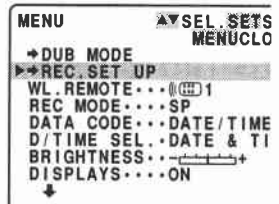

Dubbing mode menu
(78)

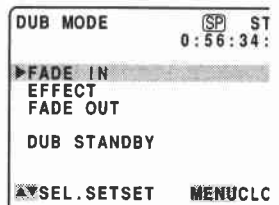

Record set up menu
(80)

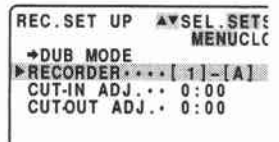

The remote sensor is turned off (38).



Self-timer countdown (65)

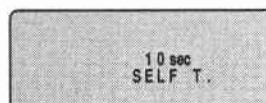

Zero set memory (77)



Audio mode (63)



Data code (74)

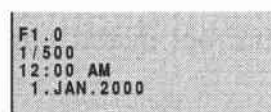

Progressive scan mode (43)



Photo mode (45)



- Setting the AF/AE. mark flashes white
- AF/AE locked. mark lights up green
- Timer

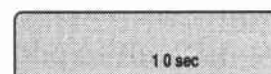

Recording programs (51).

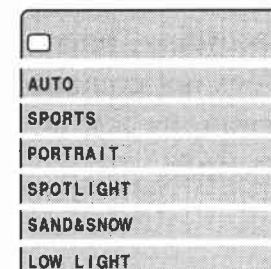

Flash is charging ⚡ mark flashes white (47).



Flash is charged ⚡ mark lights up green (47).



Accessory attached to accessory shoe has connected (48,49).

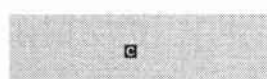

Manual exposure display (68): Exposure locked

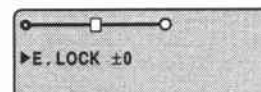

Brighter than standard exposure level

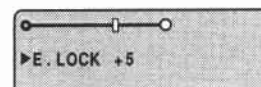

Darker than standard exposure level

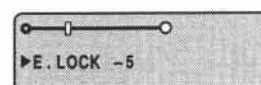

Manual focus is selected (70).

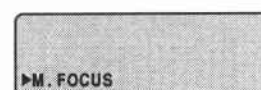

Shutter speed (68)



White balance is (71)

- Set
- Indoor
 - Outdoor

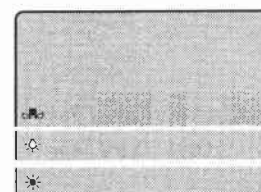

The 16:9 effect: the display flashes when the effect is being selected, and appears steadily when it is activated (18).



Digital effects. The display flashes when the function is being selected and appears steadily when it is activated (55).



E

The wind screen is turned on ( 64).



Volume level ( 24)

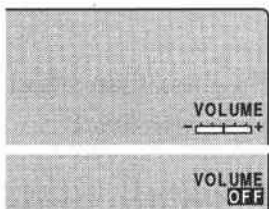

Audio output ( 96)

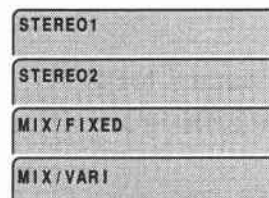

Mix balance ( 96)

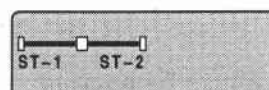

Audio/visual insert ( 90) (MV30i only)

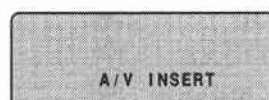

Audio dubbing ( 93)

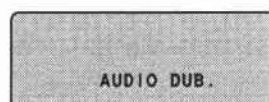

DV input ( 87) (MV30i only)



Condensation warning ( 106)

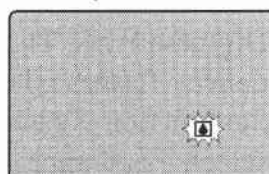

Time Code

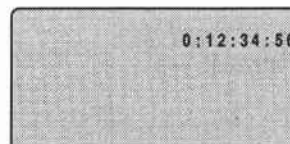

This records counter information, including hour, minute, second, and frame number on a special data code area on the tape itself. It is reset automatically when a new tape is loaded. In camera mode, the frame number doesn't appear in the display.

Recording reminder

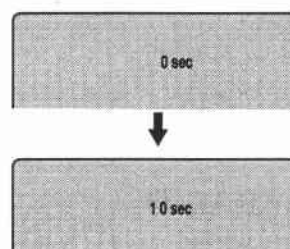

When you start recording, the camera counts from 0SEC to 10SEC. Shots which are shorter than ten seconds may be difficult to edit later. On the other hand, if you are not planning to edit the recording, remember that a shot which does not contain action should generally last no longer than ten seconds.

Caution phrases

E

The camera displays various caution phrases — they appear for four seconds before disappearing.

Refer to p.89

COPYRIGHT PROTECTED
DUBBING RESTRICTED

Appears each time you turn the power on, until you set the time zone, date and time ( 40).

SET THE TIME ZONE,
DATE AND TIME

Appears when you try to do audio dubbing or A/V insert (MV30i only) on a tape recorded in LP mode ( 90-92).

CHECK THE CASSETTE
[LP MODE]

Appears when the battery pack is exhausted ( 10, 100).

CHANGE THE BATTERY PACK

Appears when you try to do audio dubbing on a tape recorded in 16-bit audio or 12-bit, 4-channel mode ( 93-95).

CHECK THE CASSETTE
[AUDIO MODE]

Appears when the tape has reached the end.

TAPE END

Refer to p.15

THE TAPE IS SET FOR
ERASURE PREVENTION

Appears when the camera detects a blank section of a tape during audio dubbing or A/V insert (MV30i only) ( 90-92).

CHECK THE CASSETTE
[BLANK]

Appears when you press the REC PAUSE button if the DV cable is not connected properly ( 87) (MV30i only).

CHECK THE DV INPUT

Refer to p.106

CONDENSATION
HAS BEEN DETECTED

Appears as a warning to protect the tape and also when condensation is detected. Remove the tape as soon as possible after the camera has displayed the caution.

REMOVE THE CASSETTE

Refer to p.89

COPYRIGHT PROTECTED
PLAYBACK IS RESTRICTED

Specifications

MV30/MV30i

E

Power Supply (rated): 7.4 V DC

Power Consumption (while recording with the AF turned on): 4.7 W (Using viewfinder),
5.5 W (Using LCD screen)

Television system:

CCIR standard (625 lines, 50 fields)
PAL colour signal

Video recording system:

2 rotary heads, helical scanning
DV system (Consumer digital VCR SD system)
Digital component recording

Audio recording system: PCM digital sound: 16 bit (48kHz/2ch),
12 bit (32kHz/4ch)

Image sensor: 1/4" Progressive Scan CCD (charge coupled device) 450,000 pixels (420,000 effective pixels)

Tape format: Videocassettes bearing the MiniDV mark.

Tape speed:

SP: 18.83 mm/s;
LP: 12.57 mm/s

Maximum recording time:

SP: 80 minutes (with a 80 min. cassette);
LP: 120 minutes (with a 80 min. cassette)

Fast forward/rewind time:

Approx. 2 min. 30 sec. (with a 60 min. cassette)

Lens: F/1.6–2.5, 12× power zoom, 4.1–49.2 mm

Focusing system: TTL autofocus, manual focusing possible

Minimum focusing distance: 1 m (3 ft 3 3/8 in), (1 cm (3/8 in) on maximum wide angle)

Maximum shutter speed:

1/4,000 sec

Minimum illumination: 1.5 lx (using the low light program)

Recommended illumination:

More than 100 lx

Filter diameter: 30.5 mm

Viewfinder: 0.44-inch, TFT colour LCD (approx. 113,000 pixels)

LCD screen: 3.5 in measured diagonally, TFT colour, 200,000 pixels (approx.)

Microphone: Stereo electret condenser microphone

DV Terminal: Special 4-pin connector (conforms to IEEE1394) (MV30: Output only. MV30i: Input/output)

Output level:

Video terminal: 1 Vp-p/75 ohms unbalanced
S-video terminal: 1 Vp-p (Y signal), 0.3 Vp-p (C signal)
Audio terminal: -10dBV, less than 3 kohms, unbalanced

Input level:

Microphone terminal: ø 3.5 mm stereo mini-jack, -61 dBV (with 600 Ω mic)/ at least 5 kΩ

Operating temperature range:

0°–40 °C (32°–104 °F)

Dimensions: 68 × 87 × 148mm (2 5/8 × 3 3/8 × 5 7/8 in)

Weight: 650 g (1lb 6 7/8 oz approx.)

BP-511 Battery Pack

Battery type: Rechargeable lithium ion battery

Rated voltage: 7.4 V DC

Operating temperature: 0°–40°C (32°–104°F)

Battery capacity: 1100 mAh

Dimensions: 38 × 21 × 55 mm (1 1/2 × 7/8 × 2 1/8 in)

Weight: 70 g (2 1/2 oz)

Weight and dimensions are approximate
Errors and omissions excepted.
Subject to change without notice.

Index

16:9, 18

A

Abroad, Using the Camera, 105
Accessories, 4, 111
Adapter, AC, 9
AE Programs, 51
Art, 58
Audio Dubbing, 93
Audio Mix, 96
Audio Mode, 63
Audio Output, 97
Audio Recording
 and Playback, 24, 63
Audio/Video Terminals, 29
Auto, 53
Autofocus, 70
A/V Insert, 90

B

Backup Battery, 102
Basic Recording, 16
Battery Charger, 12
Battery Pack, 10, 12, 13, 101
Beep, 19
Black and White, 58

C

Cables, 4, 28
Cassettes, 14
Charging the Battery Pack,
 10-15, 100
Choosing a Recording Program, 51
Cleaning the Camera, 104
Clock, 42
Condensation, 106
Connection to TV or VCR, 28
Cut-in and Cut-out, 84

D

Data Code, 73
Date and Time, 40
Date Search, 76
Demo mode, 19
Digital Effects, 55
Digital Video, 5
Digital Zoom, 20

Dubbing Function, 78
DV Dubbing, 87

E

Easy Recording, 53
Effects, 58
Exposure, 67
External Microphone, 93

F

Fade Trigger, 57
Faders, 57
Fast Forward, 25
Feedback, 30
Finding Your Way Around
 the MV30/MV30i, 6
Flash Photography, 47
Floppy Disk Still Image Recorder, 44
Focusing, 70

H

Head Cleaning, 104
Headphones, 24

I

Image Stabilizer, 33
Introducing the MV30/MV30i, 5

L

LANC, 86
LCD Screen, 21
Lens Cap, 98
Loading Cassettes, 14
Low Light, 54
LP Mode, 18

M

Maintenance, 103
Making Better Videos, 31
Manual Exposure Control, 67
Manual Focus, 70
Menus, 34
Microphone, 49, 93
Monitor Recording, 23
Mosaic, 58
Mosaic Fade, 57
Multi-image Screen, 61

E

E**O**

Optical Image Stabilizer, 33
Optional Accessories, 111

P

Pause, Record, 16
Photo Search, 76
Playback, 25
Playback Connection, 28
Playback Pause, 26
Portrait, 53
Power Adapter, 9, 11
Powering Your Camcorder, 9
Pre-Marked Position, 77
Preparing the Camera, 98
Problems, 107
Progressive Scan Mode, 43

R

Recharging the Battery Pack, 101
Recorder, 81
Recording, 16
Recording Programs, 51
Record Pause Mode, 16
Record Review, 50
Record Search, 50
Remote Control, 37
Remote Sensor, 38
Rewind, 25

S

S1 video input terminal, 29
Sand & Snow, 54
Screen Displays, 115
Scroll, 57
Self-Timer, 65
Sepia, 58
Shoulder Strap, 99
Shutter Speed, 68
Speaker, 24
Specifications, 120
Speedlite, 47
SP Mode, 18
Sports, 53

Spotlight, 54
Still Picture, 45
Storage, 104
S-video, 28
System Diagram, 110

T

Tally Lamp, 39
Tape Protection, 15
Telephoto, 20
Temperature, 102, 104
Time Code, 118
Time Zone, 40
Tips for Making Better Videos, 31
Tripod, 31
Troubleshooting, 107
TV, 28, 115

U

Using the Camera Abroad, 105
Using the Menus, 34

V

VCR, 28
Videocassettes, 14
Video Heads, 104
Video Light, 48
Viewfinder, 98, 104

W

White Balance, 71
Wide-angle, 20
Widescreen TV, 18
Wind Screen, 64
Wipe, 57
Wireless Controller, 37

Z

Zero Set Memory, 77
Zooming, 20

Free Manuals Download Website

<http://myh66.com>

<http://usermanuals.us>

<http://www.somanuals.com>

<http://www.4manuals.cc>

<http://www.manual-lib.com>

<http://www.404manual.com>

<http://www.luxmanual.com>

<http://aubethermostatmanual.com>

Golf course search by state

<http://golfingnear.com>

Email search by domain

<http://emailbydomain.com>

Auto manuals search

<http://auto.somanuals.com>

TV manuals search

<http://tv.somanuals.com>