

# Setup Guide

This guide provides information for setting up a network connection for the printer.

---

## Network Connection

---

### Wireless Connection

Preparation for Connection

Printer Setup

Setup Procedure Selection

- Push Button Method

- Standard setup

- WPS

- Other setup (Advanced setup)

  - Disable

  - WEP

  - WPA/WPA2

### Wired Connection

Preparation for Connection

Cable Connection

Printer Setup

### Character Entry

### Troubleshooting

# Network Connection

## Wireless Connection

### 1 Preparation for Connection

#### Before Starting Wireless Connection Setup

1. Make sure that the printer is turned on.  
If the power is on, the lamp on one of the mode buttons (A) will be lit.

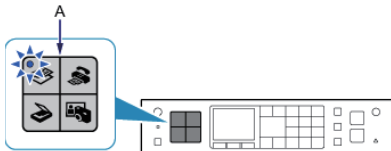

#### Notes on Wireless Connection

- Make sure that the computer is connected to the access point (A) (or wireless network router) you want to connect your printer to.

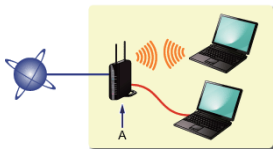

- The configuration, router functions, setup procedures and security settings of the network device vary depending on your system environment. For details, refer to the manual of your network device or contact its manufacturer.
- Check if your device supports IEEE802.11n, 802.11g or 802.11b.
- If your device is set to the "IEEE802.11 n only" mode, WEP or TKIP cannot be used as a security protocol. Change the security protocol for your device to something other than WEP and TKIP or change the setting to something other than "IEEE802.11 n only."
- For office use, consult your network administrator.
- Take added care when connecting to a network that is not protected with security measures, as there is a risk of disclosing data such as your personal information to a third party.
- This printer cannot be used over wireless and wired connections at the same time.
- An "Ad-hoc connection," which establishes a direct connection to the computer over a wireless connection without an access point, is not supported. Be sure to prepare an access point.

### 2 Printer Setup

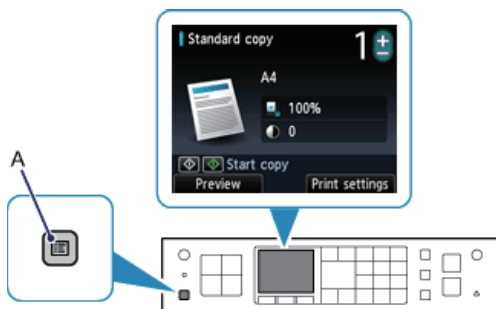

1. Press the MENU button (A) on the printer.

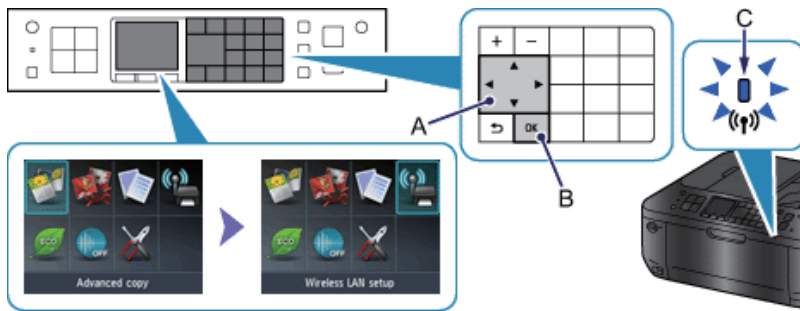

2. Use the ▲▼◀▶ buttons (A) to select the Wireless LAN setup icon.
3. Press the OK button (B).

The (blue) Wi-Fi lamp (C) lights up when wireless connection is enabled.

### 3 Setup Procedure Selection

The printer will automatically search for access points supporting WPS (Wi-Fi Protected Setup).

If the Push Button Method screen is displayed on the printer but you are unsure if your access point or router supports this technology, press the Stop button and choose Standard setup.

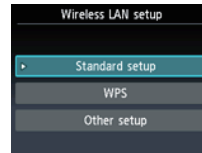

Push Button Method → 4-A Select the most suitable connection method from the following.

- Standard setup → 4-B  
Connect to Access Point by entering the Network Password
- WPS → 4-C  
Connect to WPS-compatible Access Point
- Other setup (Advanced setup) → 4-D  
Connecting to the Network by Entering the Access Point's Settings Directly on the Printer

When using WEP key number WEP key 2 to WEP key 4, select "Advanced setup".

## 4-A Push Button Method

---

### 4 Connection Using WPS

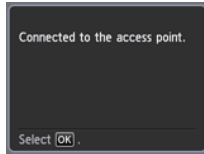
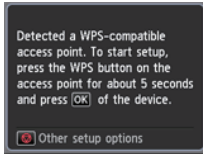

1. Press and hold the WPS button on the access point (for about 5 seconds).  
For details on pressing the WPS button, refer to the access point manual.
2. Press the OK button on the printer within 2 minutes.  
The (blue) Wi-Fi lamp on the printer flashes while searching for or connecting to the access point.

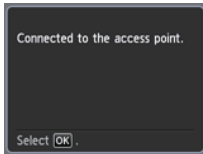

3. When the left screen appears, press the OK button.

**The network connection setup is now complete.**

## 4-B Standard setup

---

### 4 Connection via Standard setup

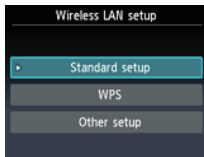

1. Select Standard setup.
2. Press the OK button.

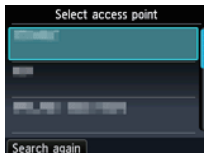

3. Select your access point, then press the OK button.

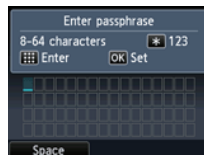

4. One of the screens above will be displayed on the printer.



5. Enter the network password (WEP key or passphrase) of your access point or router into the printer.
6. Press the OK button.

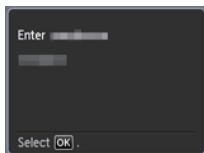

7. Make sure that the network password is correct.  
Character entry is case-sensitive.
8. Press the OK button.

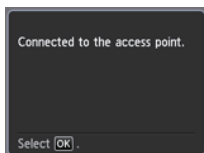

9. When the left screen appears, press the OK button.

**The network connection setup is now complete.**

## 4-C WPS

### 4 Connection Using WPS

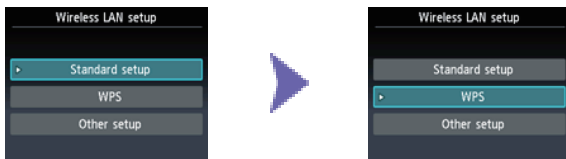

1. Select WPS.
2. Press the OK button.

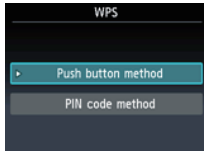

3. Select Push button method.
4. Press the OK button.

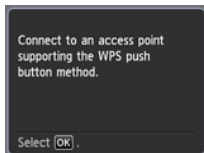

5. Press the OK button.

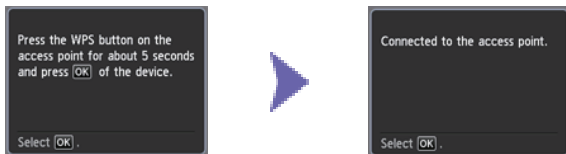

6. Press and hold the WPS button on the access point (for about 5 seconds).  
For details on pressing the WPS button, refer to the access point manual.
7. Press the OK button on the printer within 2 minutes.  
The (blue) Wi-Fi lamp on the printer flashes while searching for or connecting to the access point.

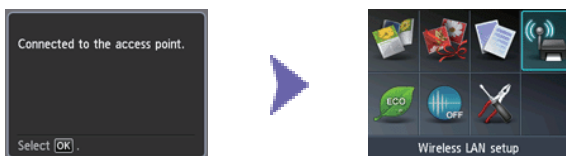

8. When the left screen appears, press the OK button.

**The network connection setup is now complete.**

## 4-D Other setup (Advanced setup)

### 4 Connection via Advanced setup

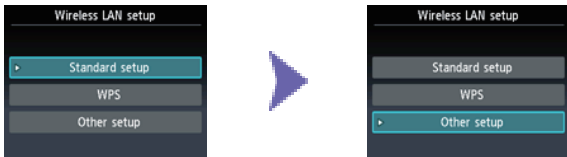

1. Select Other setup.
2. Press the OK button.



3. Select Advanced setup.
4. Press the OK button.

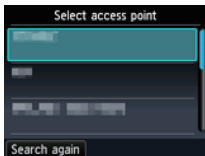

5. Select your access point, then press the OK button.

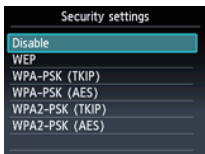

6. Select a security protocol for the access point, then press the OK button.

### Disable



7. When the left screen appears, press the OK button.

**The network connection setup is now complete.**

### WEP



7. Select the WEP key number you want to use.
8. Press the OK button.

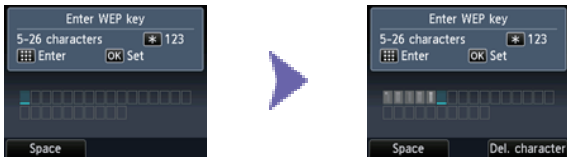

9. Enter the WEP key of your access point or router.
10. Press the OK button.

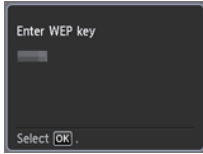

11. Make sure that the WEP key is correct.
12. Press the OK button.



13. When the left screen appears, press the OK button.

**The network connection setup is now complete.**

## ■ WPA/WPA2

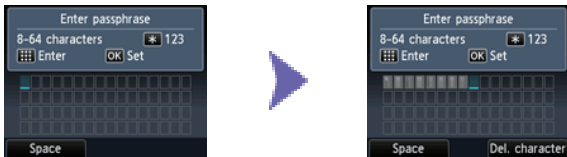

7. Enter the passphrase of your access point or router.
8. Press the OK button.

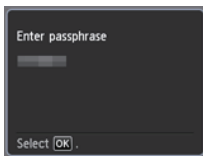

9. Make sure that the passphrase is correct.
10. Press the OK button.

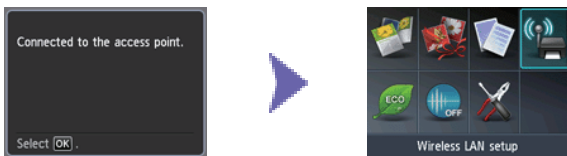

11. When the left screen appears, press the OK button.

**The network connection setup is now complete.**



## Wired Connection

### 1 Preparation for Connection

#### Before Starting Wired Connection Setup

1. Make sure that the printer is turned on.  
If the power is on, the lamp on one of the mode buttons (A) will be lit.

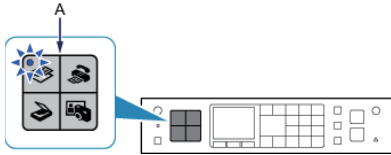

#### Notes on Wired Connection

- Make sure that the computer and router (A) (or access point) are connected.

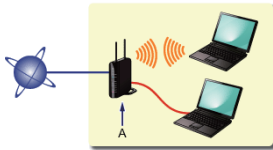

- The configuration, router functions, setup procedures and security settings of the network device vary depending on your system environment. For details, refer to the manual of your network device or contact its manufacturer.
- For office use, consult your network administrator.
- Take added care when connecting to a network that is not protected with security measures, as there is a risk of disclosing data such as your personal information to a third party.
- This printer cannot be used over wireless and wired connections at the same time.
- When using a router, connect the printer and computer to the LAN side (same network segment).

### 2 Cable Connection

You will need an Ethernet cable (sold separately).

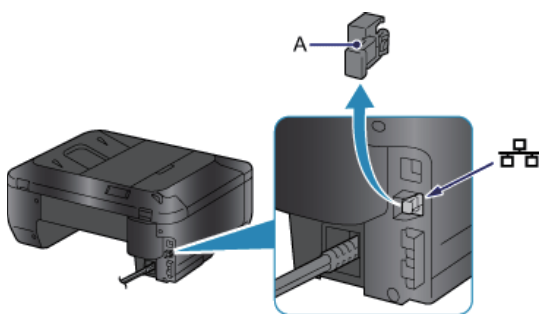
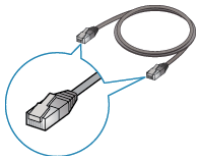

1. Remove the Cap (A) of the second port from the top located on the left side at the back of the printer.

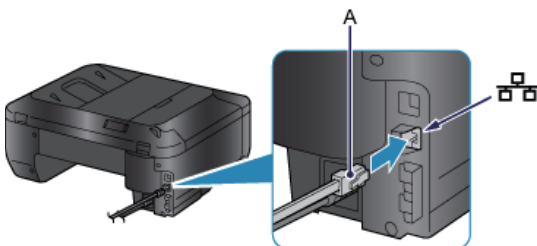

2. Connect the printer and a network device (router, etc.) with an Ethernet cable (A).

### 3 Printer Setup

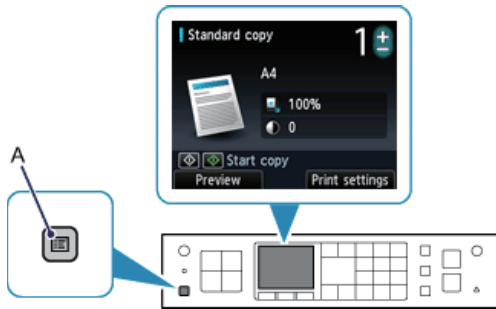

1. Press the MENU button (A) on the printer.

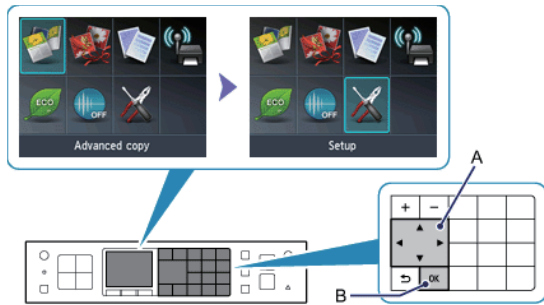

2. Use the ▲▼◀▶ buttons (A) to select the Setup icon.

3. Press the OK button (B).



4. Select Device settings.

5. Press the OK button.

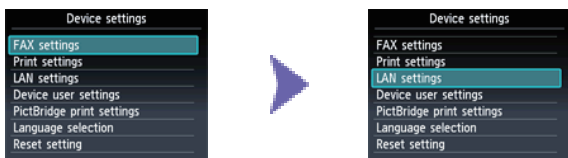

6. Select LAN settings.

7. Press the OK button.

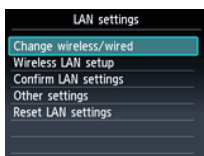

8. Select Change wireless/wired.

9. Press the OK button.

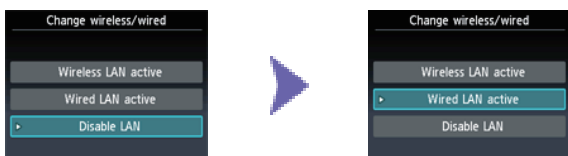

10. Select Wired LAN active.

11. Press the OK button.

12. Press the MENU button.

**The network connection setup is now complete.**

## Character Entry

You can enter the characters using the Numeric buttons (A) on the printer. Follow the procedure below.

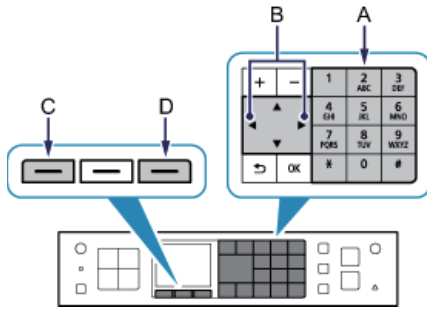

1. Press the **X** button of the Numeric buttons to switch to the character entry mode you want to use. Three character entry modes (numeric, upper case and lower case) are available. Each time you press the **X** button, the entry mode displayed on the upper right of the screen changes between numeric 123, upper case ABC and lower case abc.
2. Enter characters using the Numeric buttons. Multiple characters are assigned to each key. Press a key to toggle character options for that key. For details on assigned characters, refer to "Key Assignments" below.
3. Repeat 1 and 2 to enter more characters.

### <Key Assignments>

Button	Numeric mode 123	Upper case mode ABC	Lower case mode abc
1	1		
2	2	ABC	abc
3	3	DEF	def
4	4	GHI	ghi
5	5	JKL	jkl
6	6	MNO	mno
7	7	PQRS	pqrs
8	8	TUV	tuv
9	9	WXYZ	wxyz
0	0		
#	- . SP * # ! " , ; : ^ ` _ = /   ' ? \$ @ % & + ( ) [ ] { } < > \ ~		
<b>X</b>	Each time you press this button, the entry mode changes between numeric mode 123, upper case mode ABC and lower case mode abc.		

SP: Indicates a single space.

## Standard setup

### ■ The Target Access Point is Not Detected

Check the access point name/network name and network password of your access point or router.

- Are the computer and network device configured?
- Is the network device turned on? If the network device is already turned on, turn it off, then turn it back on.
- Are the access point and printer installed in an open space where wireless communications are possible?
- Is the access point operating in IEEE802.11n (2.4 GHz), IEEE802.11g or IEEE802.11b?

After checking the above points, press the left Function button (A) on the printer to search for the access point again.

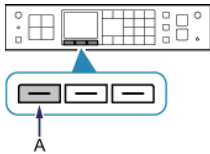

**If the problem is not resolved, there may be other causes.**

**See also the sections below:**

Turn off the access point, turn it back on, then press the left Function button on the printer to search for the access point again.

If SSID broadcast (connection via "ANY" SSID, etc.) is disabled or the stealth mode is enabled on the access point, enable SSID broadcast (connection via "ANY" SSID, etc.) or disable the stealth mode, then press the left Function button on the printer to search for the access point again.

Select Directly enter the access point name in the Select access point screen. Wireless connection settings of the access point can be entered on the printer directly.

If "WPA/WPA2 Enterprise" is set as the security protocol (encryption standard) on the access point, change the security protocol (encryption standard) and configure wireless connection settings again. "WPA/WPA2 Enterprise" is not supported on this printer.

For details on how to change the security protocol (encryption standard) for the access point, refer to the manual supplied with the access point or contact its manufacturer.

### ■ Multiple access points with the same name exist. Do you want to use multiple access points?

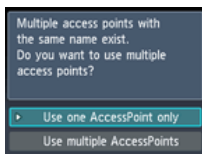

The message appears when multiple access points with the same name are found.

When you have only one access point.

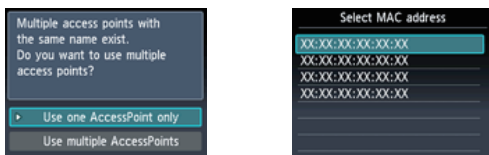

Select Use one AccessPoint only, then press the OK button. Select the MAC address of the target access point on the displayed screen, then press the OK button.

For details on how to check the MAC address of the access point, refer to the manual supplied with the access point or contact its manufacturer.

When using multiple access points.

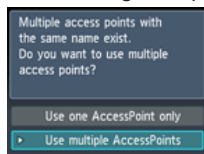

Select Use multiple AccessPoints, then press the OK button.

### ■ An Unknown Access Point is Displayed

Access points in use nearby may also be detected.

### ■ The Access Point Name is Not Displayed Properly

Access point names with double-byte characters are not displayed properly. However, they can be selected.

### ■ The Access Point Name is Not Displayed Automatically

Refer to the manual supplied with the access point or contact its manufacturer.

### ■ The Network Password is Not Displayed Automatically

Refer to the manual supplied with the access point or contact its manufacturer.

## ■ WPA/WPA2

### ■ Failed to connect to the access point. Check the access point settings and try again.

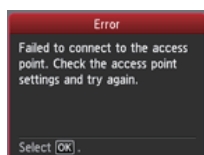

Make sure that the passphrase entered for the access point is correct.

**If the problem is not resolved, there may be other causes.**

**See also the sections below:**

If the DHCP function of the access point is inactive, enable the DHCP function and configure wireless connection settings again.

For details on how to check or change the settings of the access point, refer to the manual supplied with the access point or contact its manufacturer.

### ■ WLAN setting list

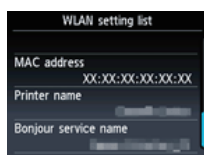

If the MAC address filtering is enabled on the access point, change settings so that the MAC address of the printer will be accepted.

Follow the procedure below to check the MAC address of the printer.

1. Press the MENU button.
2. Select Setup, then press the OK button.
3. Select Device settings, then press the OK button.
4. Select LAN settings > Confirm LAN settings > WLAN setting list to check MAC address.

For details on how to change the settings of the access point, refer to the manual supplied with the access point or contact its manufacturer.

**If the problem is not resolved, there may be other causes.**

**See also the sections below:**

If the access point is configured to communicate using IEEE802.11n standard only and encryption is set to TKIP, change the encryption to something other than TKIP or change the communication standard to something other than IEEE802.11n, then configure wireless connection settings again.

If encryption is set to TKIP, IEEE802.11n cannot be used as the communication standard.

For details on how to change the settings of the access point, refer to the manual supplied with the access point or contact its manufacturer.

## ■ WEP

■ **Failed to connect to the access point. Check the access point settings and try again.**

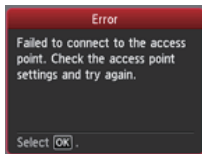

Make sure that the WEP key entered for the access point is correct. In addition, when using WEP key number 2, 3 or 4 of the access point, set to use WEP key number 1, or select a WEP key number by entering wireless connection settings of the printer directly.

For details on how to change the WEP key number of the access point, refer to the manual supplied with the access point or contact its manufacturer.

**If the problem is not resolved, there may be other causes.**

**See also the sections below:**

If the DHCP function of the access point is inactive, enable the DHCP function and configure wireless connection settings again.

For details on how to check or change the settings of the access point, refer to the manual supplied with the access point or contact its manufacturer.

If using an access point that automatically creates WEP keys, check the WEP key (hexadecimal) created automatically on the access point, then enter it on the printer.

For details on how to check the specifications of the access point, refer to the manual supplied with the access point or contact its manufacturer.

■ **WLAN setting list**



If the MAC address filtering is enabled on the access point, change settings so that the MAC address of the printer will be accepted.

Follow the procedure below to check the MAC address of the printer.

1. Press the MENU button.
2. Select Setup, then press the OK button.
3. Select Device settings, then press the OK button.
4. Select LAN settings > Confirm LAN settings > WLAN setting list to check MAC address.

For details on how to change the settings of the access point, refer to the manual supplied with the access point or contact its manufacturer.

■ To perform Standard setup again

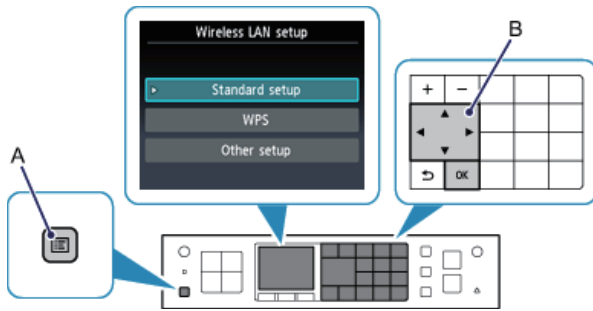

1. Press the MENU button (A).
2. Use the ▲▼◀▶ buttons (B) to select Wireless LAN setup, then press the OK button.



■ **Cannot connect. Multiple access points are enabled.**

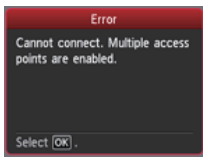

The screen appears when multiple access points are detected. Wait for a while, then configure WPS settings again. Press the WPS button on only one access point.

■ **Connection failed. See the manual.**

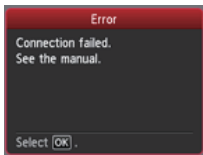

The screen appears when an error occurs.

Check the access point settings, then configure WPS settings again.

For details on how to check the settings of the access point, refer to the manual supplied with the access point or contact its manufacturer.

■ **Timeout error. Check the access point. See the access point manual.**

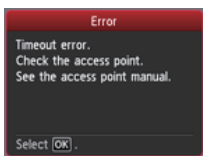

The screen appears when WPS setup was not completed within a specified time. Complete the setup within the specified time.

## Advanced setup

### ■ The Target Access Point is Not Detected

Check the access point name/network name and network password of your access point or router.

- Are the computer and network device configured?
- Is the network device turned on? If the network device is already turned on, turn it off, then turn it back on.
- Are the access point and printer installed in an open space where wireless communications are possible?
- Is the access point operating in IEEE802.11n (2.4 GHz), IEEE802.11g or IEEE802.11b?

After checking the above points, press the left Function button (A) on the printer to search for the access point again.

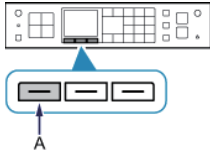

**If the problem is not resolved, there may be other causes.**

**See also the sections below:**

Turn off the access point, turn it back on, then press the left Function button on the printer to search for the access point again.

If SSID broadcast (connection via "ANY" SSID, etc.) is disabled or the stealth mode is enabled on the access point, enable SSID broadcast (connection via "ANY" SSID, etc.) or disable the stealth mode, then press the left Function button on the printer to search for the access point again.

Select Directly enter the access point name in the Select access point screen. Wireless connection settings of the access point can be entered on the printer directly.

If "WPA/WPA2 Enterprise" is set as the security protocol (encryption standard) on the access point, change the security protocol (encryption standard) and configure wireless connection settings again. "WPA/WPA2 Enterprise" is not supported on this printer.

For details on how to change the security protocol (encryption standard) for the access point, refer to the manual supplied with the access point or contact its manufacturer.

### ■ Multiple access points with the same name exist. Do you want to use multiple access points?

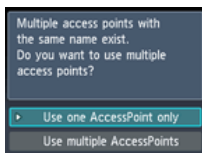

The message appears when multiple access points with the same name are found.

When you have only one access point.

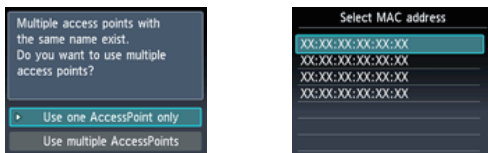

Select Use one AccessPoint only, then press the OK button. Select the MAC address of the target access point on the displayed screen, then press the OK button.

For details on how to check the MAC address of the access point, refer to the manual supplied with the access point or contact its manufacturer.

When using multiple access points.

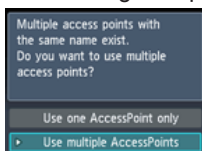

Select Use multiple AccessPoints, then press the OK button.

## ■ An Unknown Access Point is Displayed

Access points in use nearby may also be detected.

## ■ The Access Point Name is Not Displayed Properly

Access point names with double-byte characters are not displayed properly. However, they can be selected.

## ■ The Access Point Name is Not Displayed Automatically

Refer to the manual supplied with the access point or contact its manufacturer.

## ■ WPA/WPA2

### ■ Failed to connect to the access point. Check the access point settings and try again.

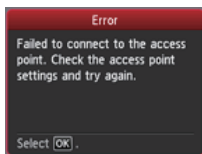

Make sure that the passphrase entered for the access point is correct.

**If the problem is not resolved, there may be other causes.**

**See also the sections below:**

If the DHCP function of the access point is inactive, enable the DHCP function and configure wireless connection settings again.

For details on how to check or change the settings of the access point, refer to the manual supplied with the access point or contact its manufacturer.

### ■ WLAN setting list

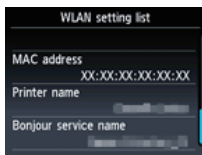

If the MAC address filtering is enabled on the access point, change settings so that the MAC address of the printer will be accepted.

Follow the procedure below to check the MAC address of the printer.

1. Press the MENU button.
2. Select Setup, then press the OK button.
3. Select Device settings, then press the OK button.
4. Select LAN settings > Confirm LAN settings > WLAN setting list to check MAC address.

For details on how to change the settings of the access point, refer to the manual supplied with the access point or contact its manufacturer.

**If the problem is not resolved, there may be other causes.**

**See also the sections below:**

If the access point is configured to communicate using IEEE802.11n standard only and TKIP is set as the encryption standard, change the encryption standard to something other than TKIP or change the communication standard to something other than IEEE802.11n, then configure wireless connection settings again.

If the encryption standard is set to TKIP, IEEE802.11n cannot be used as the communication standard.

For details on how to change the settings of the access point, refer to the manual supplied with the access point or contact its manufacturer.

### ■ The Passphrase is Not Displayed Automatically

Refer to the manual supplied with the access point or contact its manufacturer.

## WEP

### Failed to connect to the access point. Check the access point settings and try again.

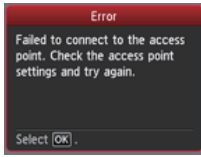

Make sure that the WEP key entered for the access point is correct. In addition, when using WEP key number 2, 3 or 4 of the access point, set to use WEP key number 1, or select a WEP key number by entering wireless connection settings of the printer directly.

For details on how to change the WEP key number of the access point, refer to the manual supplied with the access point or contact its manufacturer.

### If the problem is not resolved, there may be other causes.

#### See also the sections below:

If the DHCP function of the access point is inactive, enable the DHCP function and configure wireless connection settings again.

For details on how to check or change the settings of the access point, refer to the manual supplied with the access point or contact its manufacturer.

If using an access point that automatically creates WEP keys, check the WEP key (hexadecimal) created automatically on the access point, then enter it on the printer.

For details on how to check the specifications of the access point, refer to the manual supplied with the access point or contact its manufacturer.

### WLAN setting list



If the MAC address filtering is enabled on the access point, change settings so that the MAC address of the printer will be accepted.

Follow the procedure below to check the MAC address of the printer.

1. Press the MENU button.
2. Select Setup, then press the OK button.
3. Select Device settings, then press the OK button.
4. Select LAN settings > Confirm LAN settings > WLAN setting list to check MAC address.

For details on how to change the settings of the access point, refer to the manual supplied with the access point or contact its manufacturer.

Select Directly enter the access point name in the Select access point screen. Wireless connection settings of the access point can be entered on the printer directly.

### The WEP Key is Not Displayed Automatically

Refer to the manual supplied with the access point or contact its manufacturer.

■ **The device may not be able to connect to the network in the following cases:**

If the DHCP function of the access point is inactive, enable the DHCP function or specify the IP address (IPv4 only) of the printer and configure wireless connection settings again. In addition, make sure that the selected WEP key number and entered WEP key are correct.

For details on how to check or change the settings of the access point, refer to the manual supplied with the access point or contact its manufacturer.

To specify the IP address of the printer, follow the procedure below.

1. Press the MENU button.
2. Select Setup, then press the OK button.
3. Select Device settings, then press the OK button.
4. Select LAN settings, then press the OK button.
5. Select Other setup, then press the OK button.
6. Select TCP/IP settings, then press the OK button.
7. Select IPv4, then press the OK button.
8. Select Yes, then press the OK button.
9. Select IP address, then press the OK button.
10. Select Manual setup, then press the OK button.

Follow the on-screen instructions to proceed with settings.

When the setup is complete, press the MENU button.

■ **To perform Advanced setup again**

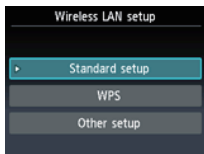

1. Press the MENU button (A).
2. Use the ▲▼◀▶ buttons (B) to select Wireless LAN setup, then press the OK button.

## Free Manuals Download Website

<http://myh66.com>

<http://usermanuals.us>

<http://www.somanuals.com>

<http://www.4manuals.cc>

<http://www.manual-lib.com>

<http://www.404manual.com>

<http://www.luxmanual.com>

<http://aubethermostatmanual.com>

Golf course search by state

<http://golfingnear.com>

Email search by domain

<http://emailbydomain.com>

Auto manuals search

<http://auto.somanuals.com>

TV manuals search

<http://tv.somanuals.com>