

Canon

CANON INC. — 30-2, Shimomaruko 3-chome, Ohta-ku, Tokyo 146-8501, Japan

U.S.A. — **CANON U.S.A.,INC. NEW JERSEY OFFICE**
100 Jamesburg Road, Jamesburg, NJ 08831 USA

CANON U.S.A.,INC. CHICAGO OFFICE
100 Park Blvd., Itasca, IL 60143 USA

CANON U.S.A.,INC. LOS ANGELES OFFICE
15955 Alton Parkway, Irvine, CA 92618 USA

CANON U.S.A.,INC. HONOLULU OFFICE
210 Ward Avenue, Suite 200 Honolulu, HI 96814 USA

● If you have any questions, call the Canon U.S.A. Information Center toll-free at 1-800-828-4040(U.S.A.only)

CANADA — **CANON CANADA INC.NATIONAL HEADQUARTERS**
6390 Dixie Road, Mississauga, Ontario L5T 1P7

CANON CANADA INC. CALGARY
2828, 16th Street, N.E., Calgary, Alberta T2E 7K7

CANON CANADA INC. MONTRÉAL
5990 Côte-de-Liesse, Montréal, Québec H4T 1V7

● If you have any questions, call the CANON CANADA Customer Information Centre toll-free at 1-800-OK-CANON (652-2666) (Canada only)

MEXICO — **CANON MEXICANA, S. DE R.L.DE C.V.**
Periferco Sur No. 4124, Col. Ex-Rancho de Anzaldo, C.P. 01900 México, D.F., México

CENTROY SURAMERICA — **CANON LATIN AMERICA, INC.**
6505 Blue Lagoon Drive, Suite 325, Miami, FL 33126, USA

ASIA — **CANON SINGAPORE PTE. LTD.**
79 Anson Road, #09-01/06, Singapore 079906 Republic of Singapore

CANON HONGKONG CO., LTD.
9/F., The Hong Kong Club Building, 3A, Chater Road, Central, Hong Kong

OCEANIA — **CANON AUSTRALIA PTY.LTD.**
1 Thomas Holt Drive, North Ryde, Sydney, N.S.W. 2113, Australia

EUROPE — **CANON EUROPA N.V.**
P.O.Box 2262, 1180 EG Amstelveen, The Netherlands
CANON EUROPE LTD.
6 Roundwood Avenue, Stockley Park, Uxbridge Middlesex, UB11 1JA, United Kingdom

Canon

NETWORK CAMERA

VB-C10/VB-C10R

User's Manual

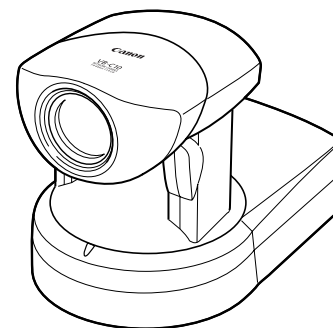

VB-C10

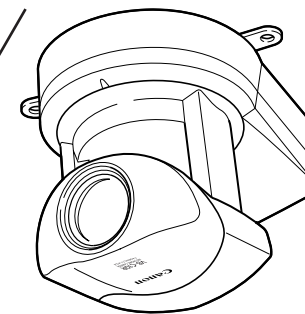

VB-C10R

Please read this instruction manual carefully before operation. Be sure to read the "△ Safe Use of Equipment" section before using this equipment. Store this manual in a readily accessible location for future reference.



ENGLISH

Introduction

Thank you for purchasing the Canon Network Camera VB-C10/VB-C10R (referred to hereafter as the VB-C10/VB-C10R).

This manual describes how to set up and use the VB-C10/VB-C10R. Read this manual carefully before using the VB-C10/VB-C10R to ensure effective operation. In particular make sure that you read the "△ Safe Use of Equipment" in this manual, as well as the supplied CD-ROM Readme file.

Exclusion of Liability

If the Product is connected to a recording device (for example a VCR), Canon Inc. accepts no responsibility whatsoever for any financial losses that may be incurred as a result of the loss of recorded information or images, regardless of the internal or external cause of the loss.

Copyright Information

Video or still pictures recorded using your VB-C10/VB-C10R cannot be used in ways that infringe copyright laws or without the consent of the owner, unless intended for personal use only.

Notes

1. The unauthorized transfer of all or any part of the contents of this Manual is forbidden.
2. The contents of this Manual are subject to change without notice.
3. Every effort has been made to ensure that this Manual is flawless. However, if you find any oversights, please let us know.
4. Item 3. notwithstanding, Canon accepts no responsibility for any effects resulting from the use of this Manual.

Trademark Notices

- Canon and Canon logo are registered trademarks of Canon Inc.
- Microsoft and Windows are registered trademarks of Microsoft Corporation in the United States and other countries.
- Windows is legally recognized as Microsoft Windows Operating System.
- Other brand or product names in this manual may be trademarks or registered trademarks of their respective companies.
- This product uses Linux kernel, gcc-libs, readline, init, sftpd, net-tools, mactool, telnetd, syslogd and boa under license of GNU General Public License (GPL); glibc and termcap under license of GNU Lesser General Public License (LGPL); and ash, sh and ping under license of modified BSD License.

Documents of Linux kernel COPYING, GPL, LGPL, and modified BSD License are stored as the files of COPYING.txt, GPL.txt, LGPL.txt and mBSD.txt respectively within LICENSE folder of accompanied CD rom with the package.

If you (customer) need program source codes under the terms and conditions of GPL and/or LGPL, please access

<http://www.canon.com/webview/webview-tech/>

Request concerning disclosure of live videos

With respect to the disclosure of live videos, we request that sufficient consideration be given to matters of privacy and rights not to be photographed. Canon considers the following points concerning such matters when it operates camera sites for which it has been responsible to install and operate:

- We take measures such as adding limitations on zoom magnifications so that people cannot make special specifications.
- When videos are taken of specific buildings, interiors and the like, we install the camera only after receiving approval from the administrator.

Please note that the operator of the camera site and not Canon has full responsibility regarding the disclosure of live videos.

© Copyright 2002 CANON INC.

ALL RIGHTS RESERVED

Contents

Introduction	ii
---------------------------	-----------

⚠ Safe Use of Equipment	vii
Maintenance	xii

Chapter 1 Before Using the VB-C10/VB-C10R

Features of the VB-C10/VB-C10R	1-2
System Configuration	1-4
Hardware and Software Requirements	1-6
Webview Livescope Viewer Software	1-6
VB Administration Tools	1-6
VBCollector	1-7
Webview Livescope MV version 2.0/LE	1-7
Package Contents	1-8
System Components and Their Operation	1-9

Chapter 2 Installation

Before Using the VB-C10/VB-C10R	2-2
Installing the VB-C10/VB-C10R	2-2
Connecting the Components	2-4
Turning the Power ON and OFF	2-4
Sample Network Configurations	2-5
Sample LAN Environment Configuration	2-5
Sample Configuration in an ISP Environment	2-5

Chapter 3 Setup Procedures

Preparations for Initial Setup	3-2
Initial Setup	3-3
Checking Operation	3-6
Detail Settings	3-7
Accessing the Settings Title Page	3-7
Settings Title Page	3-8
System/Network Settings Page	3-9
Date/Time Settings Page	3-10
Camera Settings Page	3-11
Preset Settings Page	3-15
Picture Recording and External Device I/O Settings Page	3-16
Access Control Settings Page	3-19
WebView Livescope Setting Settings Page	3-20
Miscellaneous Settings Page	3-21
Administration Tools Settings Page	3-22

Chapter 4 VB Administration Tools

Overview of VB Administration Tools	4-2
VBAdmin Startup Panel	4-2
Panorama Creation Tool	4-2
View Restriction Tool	4-3
Preset Setting Tool	4-3
Log Viewer	4-3
Admin Viewer	4-3
Installing VB Administration Tools	4-4
Starting Up VB Administration Tools	4-5
Panorama Creation Tool	4-7
About the Panorama Creation Tool Display Screen	4-8
Capturing Panorama Pictures	4-9
Updating/Deleting Panorama Pictures	4-10
Reconnecting	4-11
Opening/Saving Pictures	4-11
Displaying Connection Information	4-11
View Restriction Tool	4-12
The View Restriction Tool Display Screen	4-13
Setting View Restrictions	4-15
Preset Setting Tool	4-17
Preset Setting Tool Display Screen	4-18
Setting Presets	4-20
Log Viewer	4-22
Viewing Logs	4-22
Admin Viewer	4-24
Starting Up Admin Viewer	4-24
Operating External Device	4-25
Enabling/Disabling View Restrictions	4-26

Chapter 5 Creating Web Pages

Web Pages for Video Distribution	5-2
Features of the Java Viewers	5-3
Features of the Helper Viewer	5-5
Viewing Sample Pages	5-6
Using the Java Viewer to Distribute Videos	5-7
Using the Java Viewer to Create a Web Page	5-7
Saving Web Page Data	5-8
Example of Using the Java Viewer to Create a Web Page	5-9
Java Viewer Parameters	5-17

Using the Helper Viewer to Distribute Videos 5-21
 Example of a Web page Using the Helper Viewer 5-23
Distributing Videos Using a Browser Only 5-24
Example of Video Distribution Using One Fixed Global Address 5-26

Chapter 6 Using the Picture Recording Function

Using the Still Picture Recording Function Linked to an External Device ... 6-2
 Sample Application Combining a Door-opening Sensor 6-2
Using the Still Picture Recording Function with a Predetermined Schedule 6-4
 Sample Application Using Sequential Mode 6-4
Viewing Recorded Pictures 6-6
 Installing VBCollector 6-7
 Starting Up VBCollector 6-8
 Registering a Server 6-8
 Registering Tasks 6-10
 Executing and Canceling Tasks 6-12
 Details Displayed on the Task View 6-13
 Starting/Stopping the Service 6-14
 Viewing Recorded Images 6-14
 Viewing Logs 6-16
 Setting Download Capacity 6-18

Chapter 7 Troubleshooting

Troubleshooting 7-2
Log Messages 7-4

Chapter 8 Appendix

Specifications 8-2
 External Device I/O Terminals 8-3
Restoring the Factory Default Settings 8-4
 Restoring the Factory Default Settings from the Administration Tools Page via a Web Browser 8-4
 If the IP Address and Password are Unknown 8-5
Factory Default Setting 8-6
Index 8-8

Safe Use of Equipment



An exclamation point, within a triangle, is intended to alert the user to the presence of important operating and maintenance (servicing) instructions in the literature accompanying the equipment.

Important Warnings

CAUTION:

TO REDUCE THE RISK OF ELECTRIC SHOCK, DO NOT REMOVE COVER (OR BACK). NO USER-SERVICEABLE PARTS INSIDE. REFER SERVICING TO QUALIFIED SERVICE PERSONNEL.

The serial number of this equipment may be found on the bottom of the VB-C10/ VB-C10R. No others have the same serial number as yours.

You should record the number and other vital information here and retain this book as a permanent record of your purchase to aid identification in case of theft.

Date of Purchase

Dealer Purchased from

Dealer Address

Dealer Phone No.

Model No. VB-C10 or VB-C10R

Serial No.

Important Operational Instructions

WARNING:

TO REDUCE THE RISK OF ELECTRIC SHOCK, DO NOT EXPOSE THIS EQUIPMENT TO RAIN OR MOISTURE.

CAUTION:

TO REDUCE THE RISK OF ELECTRIC SHOCK AND TO REDUCE ANNOYING INTERFERENCE, USE THE RECOMMENDED ACCESSORIES ONLY.

FDA regulation

This Network Camera has not been evaluated by the Food and Drug Administration (FDA) for use as a medical device. When incorporated into a system with medical applications, FDA regulations may apply. Therefore, please consult your legal advisor to determine whether FDA regulations apply.

FCC NOTICE

Network Camera VB-C10/VB-C10R

This device complies with Part 15 of the FCC Rules. Operation is subject to the following two conditions: (1) This device may not cause harmful interference, and (2) this device must accept any interference received, including interference that may cause undesired operation.

Note: This equipment has been tested and found to comply with the limits for a Class B digital device, pursuant to Part 15 of the FCC Rules. These limits are designed to provide reasonable protection against harmful interference in a residential installation. This equipment generates, uses and can radiate radio frequency energy and, if not installed and used in accordance with the instructions, may cause harmful interference to radio communications.

However, there is no guarantee that interference will not occur in a particular installation. If this equipment does cause harmful interference to radio or television reception, which can be determined by turning the equipment off and on, the user is encouraged to try to correct the interference by one or more of the following measures:

- Reorient or relocate the receiving antenna.
- Increase the separation between the equipment and receiver.
- Connect the equipment into an outlet on a circuit different from that to which the receiver is connected.
- Consult the dealer or an experienced radio/TV technician for help.

Use of shielded cable is required to comply with class B limits in Subpart B of Part 15 of FCC Rules.

Do not make any changes or modifications to the equipment unless otherwise specified in the manual. If such changes or modifications should be made, you could be required to stop operation of the equipment.

Canon U.S.A. Inc.

One Canon Plaza, Lake Success, NY 11042, U.S.A.

Tel No. (516) 328-5600

IC NOTICE

This product does not exceed the Class B limits for radio noise emissions from digital apparatus as set out in the Interference-causing equipment standard entitled 'Digital Apparatus', ICES-003 of the Industry Canada.

NOTIFICATION IC

Cet appareil numérique respecte les limites de bruits radioélectriques applicables aux appareils numériques de Classe B prescrites dans la norme sur le matériel brouilleur: "Appareils Numériques", NMB-003 édictées par l'Industrie Canada.

Dieses Produkt ist zum Gebrauch im Wohnbereich, Geschäfts- und Gewerbebereich sowie in Kleinbetrieben vorgesehen.

△ IMPORTANT SAFETY INSTRUCTIONS

In these safety instructions, the word “equipment” refers to the Canon Network Camera VB-C10/VB-C10R and all its accessories.

1. **Read Instructions** - All the safety and operating instructions should be read before the equipment is operated.
2. **Retain Instructions** - The safety and operating instruction should be retained for future reference.
3. **Heed Warnings** - All warnings on the equipment and in the operating instructions should be adhered to.
4. **Follow Instructions** - All operating and maintenance instructions should be followed.
5. **Cleaning** - Unplug this equipment from the wall outlet before cleaning.
Wipe the equipment with a clean soft cloth. If necessary, put a cloth in diluted neutral detergent and wring it well before wiping the equipment with it. Finally, clean the equipment with a clean dry cloth. Do not use benzene, thinner or other volatile liquids or pesticides as they may damage the product's finish. When using chemically-treated cleaning cloths, observe those precautions accordingly.
6. **Accessories** - Do not use accessories not recommended in this manual as they may be hazardous. Always use specified connection cables. Connect devices correctly.
7. **Water and Moisture** - Hazard of electric shock - Do not use the equipment near water or in rainy/moist situations. Do not put a heater near this equipment.
8. **Placing or Moving** - Do not place on an unstable cart, stand, tripod, bracket or table. The equipment may fall, causing serious injury to a child or adult, and serious damage to the equipment. An equipment and cart combination should be moved with care.

9. **Power Sources** - The PA-V16 AC adapter should be operated only from the type of power source indicated on the marking label. If you are not sure of the type of power supply to your home, consult your equipment dealer or local power company.
10. **Polarization** - The PA-V16 AC adapter is equipped with a polarized 2-prong plug (a plug having one blade wider than the other). The 2-prong polarized plug will fit into the power outlet only one way. This is a safety feature. If you are unable to insert the plug fully into the outlet, try reversing the plug. If the plug still fails to fit, contact your electrician to replace your obsolete outlet. Do not defeat the safety purpose of the polarized plug.
11. **Power Cord Protection** - Power cords should be routed so that they are not likely to be walked on or pinched by items placed upon or against them. Pay particular attention to plugs and the point from which the cords exit the equipment.
12. **Outdoor Antenna Grounding** - If an outside antenna is connected to the equipment, be sure the antenna is grounded so as to provide some protection against voltage surges and built-up static charges. Section 810 of the National Electrical Code, ANSI/NFPA No.70-1984, provides information with respect to proper grounding of the mast and supporting structure, grounding of the lead-in wire to an antenna discharge unit, size of grounding conductors, location of antenna antenna discharge unit, connection to grounding electrodes, and requirements for the grounding electrode. See figure 1.

fig-1

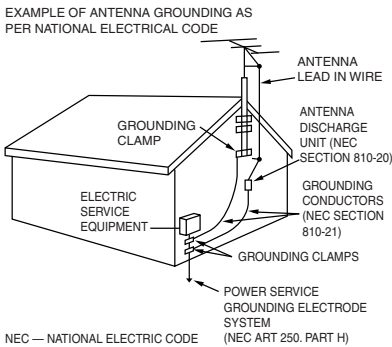

13. **Lightning** - For added protection of this equipment during a lightning storm, or when it is left unattended and unused for long periods of time, disconnect it from the wall outlet and disconnect the antenna. This will prevent damage to the equipment due to lightning and power-line surges.
14. **Power Lines** - An outside antenna system should not be located in the vicinity of overhead power lines or other electric light or power circuits, or where it can fall into such power lines or circuits. When installing an outside antenna system, extreme care should be taken to keep from touching such power lines or circuits as contact with them might be fatal.
15. **Overloading** - Do not overload wall outlets and extension cords as this can result in a risk of fire or electric shock.
16. **Object and Liquid Entry** - Never push objects of any kind into this equipment through openings as they may touch dangerous voltage points or short out parts that could result in a fire or electric shock. Be careful not to spill liquid of any kind onto the equipment.
17. **Servicing** - Do not attempt to service this equipment yourself as opening or removing covers may expose you to dangerous voltage or other hazards. Refer all servicing to qualified personnel.
18. **Damage Requiring Service** - Disconnect this equipment from the wall outlet and all power sources including batteries, and refer servicing to qualified service personnel under the following conditions.
 - a. When the power-supply cord or plug is damaged.
 - b. If any liquid has been spilled onto, or objects have fallen into, the equipment.
 - c. If the equipment has been exposed to rain or water.
 - d. If the equipment does not operate normally even if you follow the operating instructions. Adjust only those controls that are covered by the operation instructions. Improper adjustment of other controls may result in damage and will often require extensive work by a qualified technician to restore the equipment to its normal operation.
 - e. If the equipment has been dropped or the cabinet has been damaged.
 - f. When the equipment exhibits a distinct change in performance. This indicates a need for service.
19. **Replacement Parts** - When replacement parts are required, be sure the service technician has used replacement parts that are specified by Canon or that have the same characteristics as the original part. Unauthorized substitutions may result in fire, electric shock or other hazards.
20. **Safety Check** - Upon completion of any service or repairs to this equipment, ask the service technician to perform safety checks to determine that the equipment is in safe operating order.
21. Do not install the equipment in the following locations as this can cause a fire or electric shock:
 - Hot locations
 - Close to a fire
 - Very humid or dusty locations

- Locations exposed to direct sunlight
- Locations exposed to salt spray
- Close to flammable solvents (alcohol, thinners, etc.)

22. When any of the following occurs, immediately switch OFF the equipment, unplug it from the main power supply and contact your nearest Canon supplier. Do not continue to use the equipment as this can cause a fire or electric shock.

- The equipment emits any smoke, heat, abnormal noise, or unusual odor.
- A metal object falls into the equipment.
- The equipment is damaged in some way.

23. Please observe the following when using the equipment. Failure to do so can result in a fire or electric shock.

- Do not use flammable sprays near the equipment.
- Do not subject the equipment to strong impacts.

Maintenance

Cleaning the Equipment

1. Unplug the AC adapter from the wall outlet.
2. Carefully wipe the equipment with a soft cloth that has been moistened with water or a mild detergent.

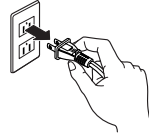

WARNING:

Do not use flammable solvents such as alcohol, benzene or thinners.
The use of such substances can cause a fire or electric shock.

3. Wipe with a dry cloth.
4. When you have finished, plug the AC adapter back in to the wall outlet.

Cleaning the Lens

Use a commercially available lens cleaner to remove any soiling from the lens.

- The auto-focus may not function correctly if the surface of the lens is dirty.
- Scratches on the surface of the lens will cause image defects.

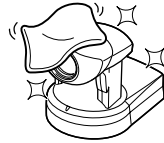

Icons Used in This Instruction Manual



Note

Indicates important information that must be observed or actions that are prohibited during an operation. These notes must be read to prevent possible faults or damage to the equipment.



Tip

Indicates supplementary information or a reference to an operation. Users are advised to read these memos.

Chapter **1**

Before Using the VB-C10/VB-C10R

This chapter contains information that you should read before using the VB-C10/VB-C10R. It also describes the features of the VB-C10/VB-C10R, the system configuration, the hardware and software requirements, and the name and functions of the system components.

Features of the VB-C10/VB-C10R

The VB-C10/VB-C10R is a system that distributes live videos via the Internet or an Intranet. It can be used in a wide range of applications, such as distributing live videos from a Web site or monitoring. The system is configured of the VB-C10/VB-C10R and viewer software. Please use the supplied viewer software for viewing videos distributed by the VB-C10/VB-C10R and controlling cameras.

■ Broadband Video Distribution Function

The VB-C10/VB-C10R is capable of capturing videos at up to 30 fps. Motion-JPEG is used to compress video images. For networking, auto-negotiation between Ethernet 100Base-TX/10Base-T is provided and a leased line or ADSL can also be used through a router. Since video quality (in 5 levels) and the frame rate (from 0.1 to 30 fps) can be freely set, videos can be distributed under conditions that best suit the network bandwidth.

■ Concurrent video is distributed up to 20 clients

Up to 20 clients can view video at the same time from a single VB-C10/VB-C10R.

■ Camera and video distribution server functions housed in a single unit

The camera capable of full pan, tilt, and zoom functions and its server functions for distributing videos through a network are compactly housed in a single unit. By simply connecting a LAN cable and a power supply, the unit can distribute live videos from any location* where it is installed.

* The unit cannot be installed in locations subject to direct sunlight, high temperatures, high humidity, or other adverse conditions (→ P.ix).

■ High-performance 16x zoom and wide angle photographic range

The camera section is equipped with a 16x zoom lens. Furthermore, since the VB-C10 provides a pan angle of 200 degrees (100 degrees each to the left and right) and a tilt angle of 120 degrees (90 degrees up and 30 degrees down), and the VB-C10R provides a pan angle of 340 degrees (170 degrees each to the left and right) and a tilt angle of 100 degrees (10 degrees up and 90 degrees down), the VB-C10/VB-C10R are capable of recording wide areas.

■ Can be mounted on ceilings, etc. (VB-C10R)

The VB-C10R includes mounting plate, enabling it to be mounted in a variety of locations including ceilings. The shape of the camera head has been designed so that pan and tilt operations are still possible when mounted upside down.

■ Remote camera control from the viewer

The VB-C10/VB-C10R come with two types of viewer software: the Helper Viewer and the Java Viewer. The viewers give you full remote control of the camera's angle (pan and tilt) and zoom magnification, allowing you to view videos with plenty of ambiance.

■ Panorama picture creation functions and settings

The entire photographic range of the camera can be created and saved as a panorama picture. The saved panorama pictures can then be easily used to visually set view restrictions and presets.

■ Camera Position Preset function

If often-used camera angles (camera head aim and zoom position) and related items are saved in advance as presets, the camera can be controlled from the viewer by simply selecting a desired preset. Up to 8 presets can be stored.

■ View Restriction function

You can set restrictions on camera angle specifications and zoom magnifications to prevent viewers from seeing certain camera angles. For example, if the VB-C10/VB-C10R is being used to operate a fixed point camera connected to the Internet, it is possible to distribute videos while protecting privacy (→ P.iii, "Request concerning disclosure of live videos").

■ Built-in Web server and FTP server

The VB-C10/VB-C10R is equipped with built-in Web server functions that enable both Web pages and videos to be distributed through the Web by a single unit. Since it also has a built-in FTP server, Web page data file transfers (FTP) can be performed from remote locations.

■ Simple set up and management

By accessing a Settings page provided on the Web, you can use the Web browser on your PC to set up and manage the VB-C10/VB-C10R from a remote location without ever visiting the place where the VB-C10/VB-C10R is actually installed.

■ More powerful security functions

The destinations for video distributions can be restricted based on passwords. Up to 20 clients can be registered.

■ Recording videos via preset schedules or links with external devices

Still pictures can be recorded based on schedules set in advance or on ON/OFF events from an external device. If VBCollector is used, still pictures recorded by the VB-C10/VB-C10R can be automatically collected by a PC and viewed there.

System Configuration

Example of Basic System Configuration - Viewing Videos Using a Viewer

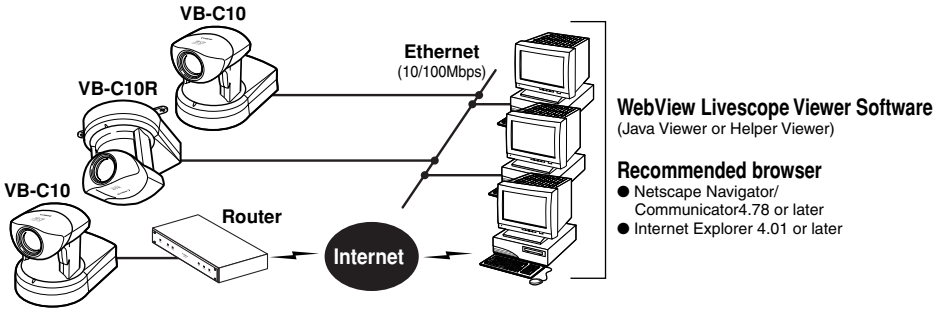

This system configuration consists of the VB-C10/VB-C10R with **WebView Livescope Viewer Software** (→ P.1-6). The WebView Livescope Viewer Software consists of the **Helper Viewer** and the **Java Viewer**.

Helper Viewer must be installed in advance from the supplied CD-ROM, while Java Viewer is not installed in advance but automatically downloaded from the VB-C10/VB-C10R. Since Java Viewer is downloaded each time you want to view videos, it is useful when viewing videos for the first time. Helper Viewer, however, is more convenient when you want to view videos frequently.

If you want to distribute live videos of places such as popular tourist destinations from Web pages, it is best for your Web page visitors to use the Java Viewer that does not need to be installed in advance.

■ Viewer Software Functions

Viewer Software	Functions
Java Viewer	<ul style="list-style-type: none"> • Videos from the VB-C10/VB-C10R can be displayed by a Web browser that can run Java applet. • Because the Java Viewer is automatically downloaded and does not need to be pre-installed, unlike the Helper Viewer, it is compatible with any platform that supports Java-capable environments. • Because it uses the HTTP protocol, the Java Viewer penetrates firewalls. However, it may not run stably on some platforms or browser types. Also, because the Viewer is downloaded when the Web page loads, start-up times and execution speeds are slower than the Helper Viewer.
Helper Viewer	<ul style="list-style-type: none"> • A helper application for viewing videos from the VB-C10/VB-C10R that is launched from a Web browser. • The Helper Viewer must be pre-installed. • Install Helper Viewer from the supplied CD-ROM. • Compared with the Java Viewer, start-up is faster because the Viewer does not need to be downloaded. This Viewer is recommended for users who use the viewer frequently. • Because it supports the HTTP protocol, the Helper Viewer penetrates firewalls unscathed.



Note

- Install the Helper Viewer from the “MonSetup.exe” file on the supplied CD-ROM.
- The manual for the WebView Livescope software is provided on the supplied CD-ROM (Mon-E.pdf).
- To connect the VB-C10/VB-C10R to the Internet, you require a leased line connection to an Internet service provider or a LAN-type dialup IP connection. If you are using a LAN-type dialup connection, check that the connection supports bidirectional calling.

Example of System Configuration with WebView Livescope MV - Optional

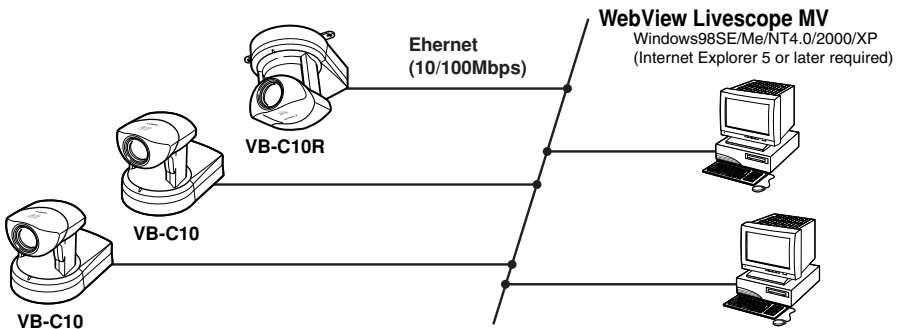

The WebView Livescope MV software (→ P.1-7) is convenient if there are several VB-C10/VB-C10R installed on a LAN and you wish to concentrate on monitoring videos from them.

The WebView Livescope MV software consists of MV Manager and MV Station. MV Manager lets you uniformly manage VB-C10/VB-C10R operating status. It also lets you select and create a monitoring screen best suited to the number of VB-C10/VB-C10Rs on the LAN from among a rich variety of examples. MV Station lets you use the monitoring screen created in MV Manager to view videos from multiple points where VB-C10/VB-C10R units are installed while also remote controlling cameras and external devices.

■ Optional Products

- Webview Livescope MV version 2.0
- Webview Livescope MV version 2.0 LE

■ Products sold separately

- Wide-angle Converter WL-37 (for VB-C10)
- Sensor
- Relay

Hardware and Software Requirements

Webview Livescope Viewer Software (→ P.1-4)

The viewer software that are supplied with the VB-C10/VB-C10R. They lets you view the VB-C10/VB-C10R's videos and control the camera.

Java Viewer version 3.20

PC	IBM PC/AT Compatible
Operating System	Windows 98SE/Me or Windows NT 4.0 (IE4.0 or later required)/Windows 2000/Windows XP
Web Browser	Netscape Navigator/Communicator 4.78 or later (excluding 6.01 and 6.1),or Microsoft Internet Explorer 4.01 or later recommended

- * This viewer is installed on the VB-C10/VB-C10R and is automatically downloaded by the client at access.
- * This software may not run stably on operating systems and Web browsers other than those listed above.

Helper Viewer version 3.20

PC	IBM PC/AT Compatible
Operating System	Windows 98SE/Me or Windows NT 4.0 (IE4.0 or later required)/Windows 2000/Windows XP
Web Browser	Netscape Navigator/Communicator 4.78 or later,or Microsoft Internet Explorer 4.01 or later recommended

- * Must be installed in advance from the supplied CD-ROM (→ P.1-4).



- Although the Helper Viewer ver. 3.10 or before, or Plug-in Viewer can be used, some of the features are different.
On Macintosh computers, some of the functions of the Helper Viewer ver. 1.20 are not available.
- The manual for the viewer software is on the supplied CD-ROM (Mon-E.pdf).

VB Administration Tools (→ P.4-2)

This tool lets you create panorama pictures from the VB-C10/VB-C10R and then easily use them to visually set view restrictions and presets.

PC	IBM PC/AT Compatible
Operating System	Windows 98SE/Me or Windows NT 4.0/Windows 2000/Windows XP
Web Browser	Microsoft Internet Explorer 5 or later required

- * Must be installed in advance from the supplied CD-ROM (→ P.4-4).

VBCollector (→ P.6-6)

This tool is for viewing still pictures recorded by the VB-C10/VB-C10R.

PC	IBM PC/AT Compatible
Operating System	Windows 98SE/Me or Windows NT 4.0/Windows 2000/Windows XP
Web Browser	Microsoft Internet Explorer 5 or later required

* Must be installed in advance from the supplied CD-ROM.

Webview Livescope MV version 2.0/LE (→ P.1-5)

This is optional viewer software for monitoring.

PC	IBM PC/AT Compatible CPU: Pentium III 600 MHz or better recommended, RAM: 128 Mbytes or better, Hard disk capacity: 50 Mbytes or better (LE: 20 Mbytes or better)
Operating System	Windows 98SE/Me or Windows NT 4.0 (SP6.0a or later)/Windows 2000 (SP1 or later)/ Windows XP
Web Browser	Microsoft Internet Explorer 5 or later required

Package Contents

The VB-C10/VB-C10R package contains the following items. If any of these items is missing, please contact the retailer from which you purchased the product.

1. VB-C10 main unit (or VB-C10R main unit)

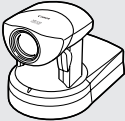

VB-C10

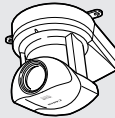

VB-C10R

2. AC Adapter PA-V16

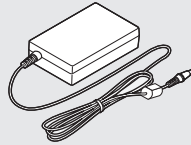

3. AC cable (1 meter 3 ft. $\frac{3}{32}$ in.)

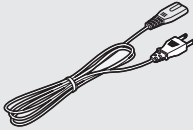

4. Plug for external device

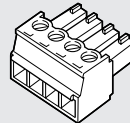

* The cable length may differ depending on the country in which the product was purchased.

5. CD-ROM



CD-ROM contents

- ReadMe (Notes not included in the User's Manual)
- VBIP1.exe (IP address setting tool)
- MonSetup.exe (Helper Viewer version 3.20 Installer)
- AdmSetup.exe (VB Administration Tools Installer)
- CltSetup.exe (VBCollector Installer)
- VB-C10-E.pdf (User's Manual in PDF format)
- Mon-E.pdf (Viewer Software User's Manual)
- Sample Folder (Set of files of sample pages)
- License Folder (License documents for software in the main unit)

6. User's Manual (This document)

7. Warranty Card

System Components and Their Operation

VB-C10

1

Before Using the VB-C10/VB-C10R

Front

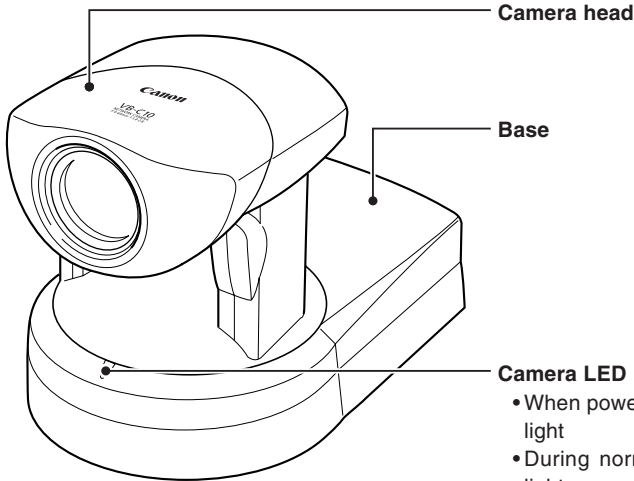

Camera head

Base

Camera LED

- When power is turned on: Flashing Green light
- During normal operation: Steady Green light

Rear

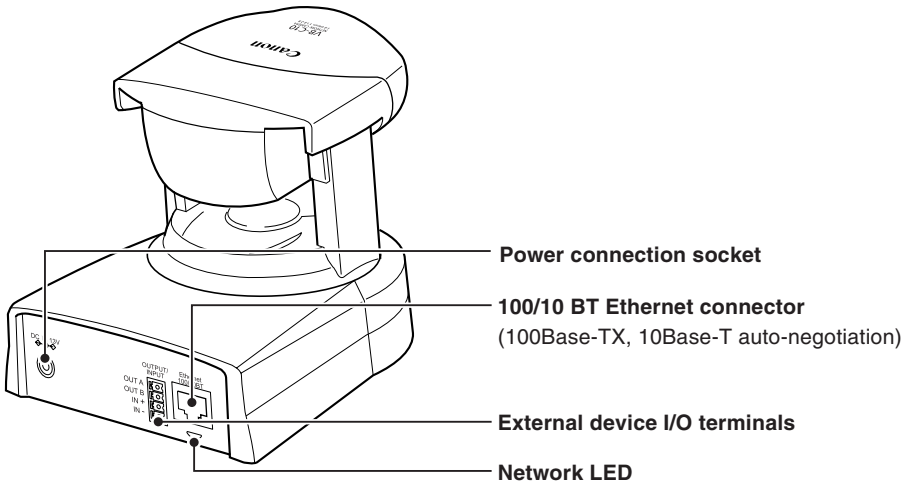

Power connection socket

100/10 BT Ethernet connector
(100Base-TX, 10Base-T auto-negotiation)

External device I/O terminals

Network LED

- When connected to network : Off
- When disconnected from network: Steady Orange light
- During communication:
 - Flashing Green light at 100Base-TX
 - Flashing Yellow light at 10Base-T

VB-C10R

Front

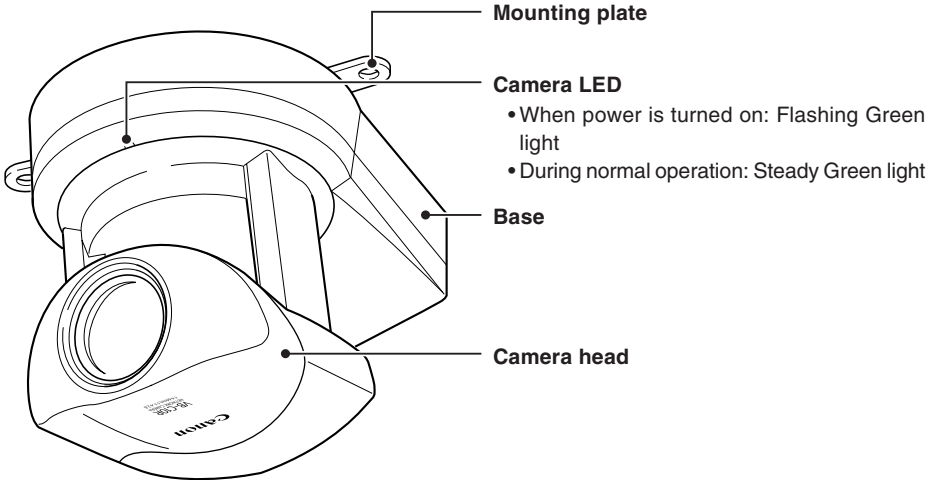

Rear

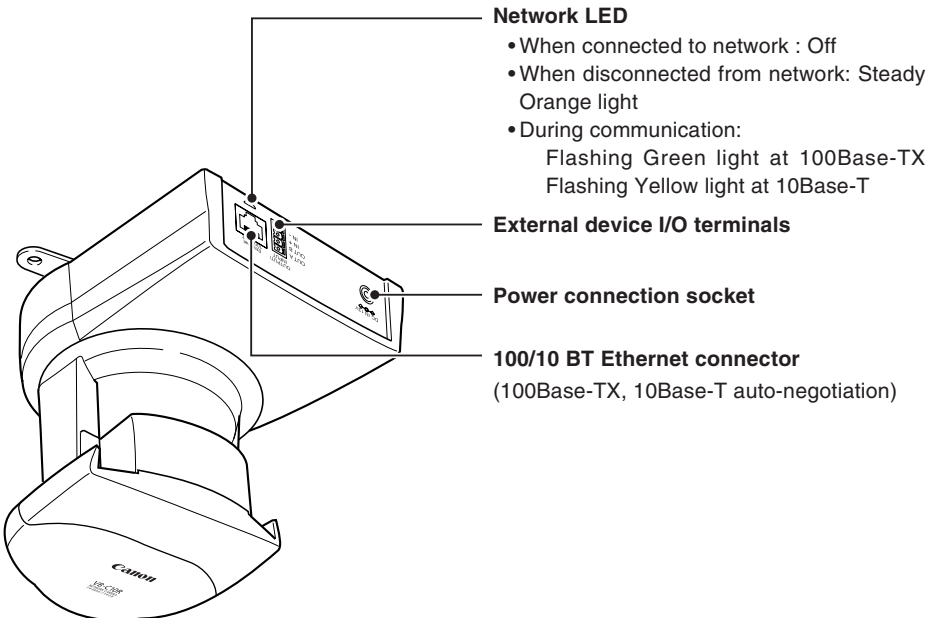

Bottom

On the bottom of the VB-C10/VB-C10R are the MAC address required for network settings, a Reset switch that returns the factory default settings, and the serial number.

VB-C10

Screw hole for tripod mounting

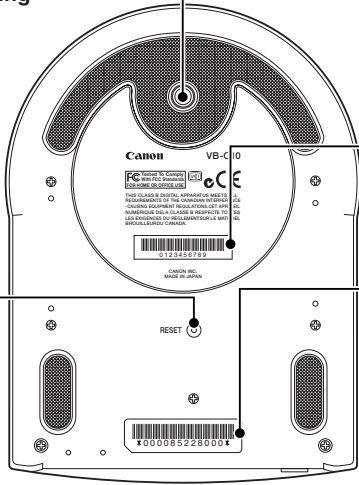

Serial No.
The serial number for this unit is shown here.

Reset switch
You can return all settings on the VB-C10 to the factory default settings by holding this button with a thin tipped object and turning on the power switch (→ P.8-5).

MAC address
The MAC address is required when setting the IP address and making other network settings. Please make a note of it before installing this unit (→ P.3-3).

VB-C10R

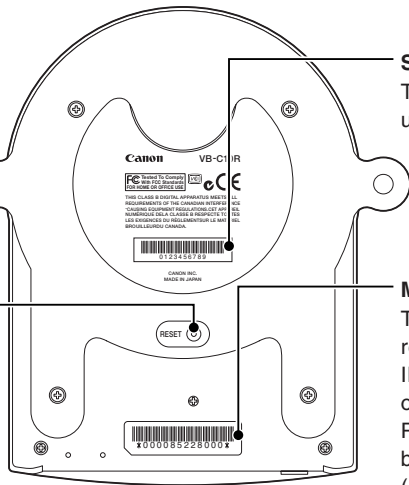

Serial No.
The serial number for this unit is shown here.

Reset switch
You can return all settings on the VB-C10R to the factory default settings by holding this button with a thin tipped object and turning on the power switch (→ P.8-5).

MAC address
The MAC address is required when setting the IP address and making other network settings. Please make a note of it before installing this unit (→ P.3-3).

Chapter



Installation

This chapter explains how to connect the system components and describes a sample network configuration.

Before Using the VB-C10/VB-C10R

Installing the VB-C10/VB-C10R

VB-C10 Installation

Install in a flat and stable location.

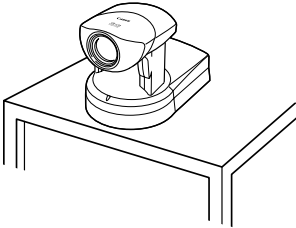

VB-C10R Installation

Firmly tighten the 2 screws (not supplied).

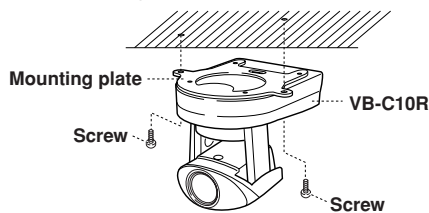

(Installation)

- Distance between tapped holes: 120 mm (4 18/25 in.)
- Tapped hole diameter: 6.0 mm (1/4 in.)
- Mounting plate thickness: 1.6 mm (1/16 in.)

⚠ WARNING:

Install the camera securely.

- When installing the VB-C10R on the ceiling, contact your Canon dealer.
- When installing the VB-C10R on the ceiling, check that the ceiling is strong enough to bear the weight of the VB-C10R including the mounting plate. Installation in a weak location could result in the VB-C10R falling and causing serious injury.
- At least once a year, check for looseness in the camera installation mount. (If the optional wide-angle converter is used, check the converter mount also.)



Note

- The permissible camera installation angles are $\pm 20^\circ$ from the horizontal. ($\pm 15^\circ$ when the optional wide-angle converter is used for the VB-C10.)
- The MAC address required when making network settings is shown on the bottom of the VB-C10/VB-C10R (\rightarrow P.1-11). Please make a note of it before installing this unit (\rightarrow P. 3-3).

Using a Tripod (VB-C10)

The screw for mounting a tripod is on the bottom of the VB-C10 toward the front.



Note

- **Do not overtighten the mounting screw.** If excessive force is used to tighten the mounting screw, camera head movement may be impeded, or other malfunctions may result.
- Always use a tripod mounting screw that is less than 6.0 mm (1/4 in.) in length. The use of screws 6.0 mm (1/4 in.) long or longer could damage the camera. Also, the tripod seat used should be at least 30 mm (1 3/16 in.) in diameter.

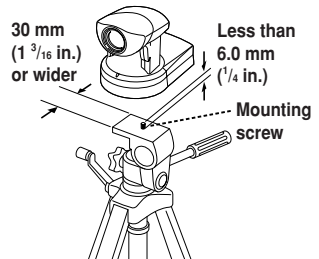

Using the Wide-angle Converter (VB-C10)

The optional Wide-angle Converter WL-37 can be used to provide wide-angle shots (approx. 0.74× the normal focal distance).

Mount the wide-angle converter correctly so that it is level and fitted securely onto the camera.

When mounted correctly, the wide-angle converter should turn roughly 3 times before stopping.

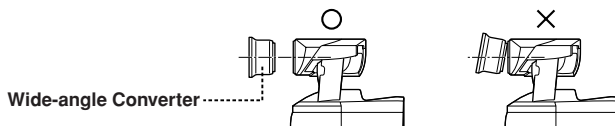

WARNING:

The Wide-angle Converter WL-37 is designed specifically for the VB-C10 and cannot be used on the VB-C10R. If the converter is used on the VB-C10R, the mount will gradually loosen and the converter will fall off the camera.



Note

- The camera may not operate correctly if a wide-angle converter other than the WL-37 is used.
- The permissible range of camera installation angles with the wide-angle converter mounted on the camera is $\pm 15^\circ$ from the horizontal.
- When the Wide-angle Converter has been set for use in “Camera Settings” (→ P.3-11), the pan and tilt values change for the three functions listed below. If the Wide-angle Converter is to be used, pan and tilt values must be determined after the use of the Wide-angle Converter has been set in “Camera Settings”.
 - Home position setting (→ P.3-12)
 - View restrictions (→ P.3-12)
 - Preset settings (→ P.3-15)

Connecting the Components

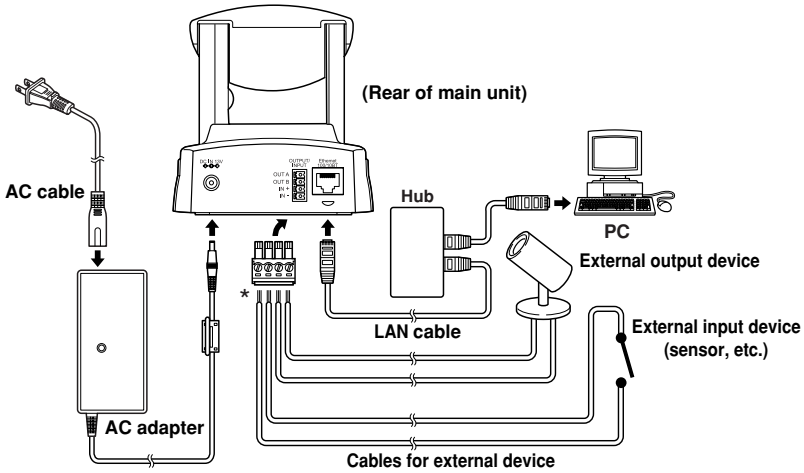

* Remove some insulation at the end of the external device cable and insert it into the plug for the external device, then secure it by tightening the screws. See page 6-2 for examples of external device connections.

Turning the Power ON and OFF

The VB-C10/VB-C10R itself does not have a power switch. You can switch the VB-C10/VB-C10R on by plugging the AC adapter into a wall outlet. When power to the VB-C10/VB-C10R is switched on, the Camera LED turns green.

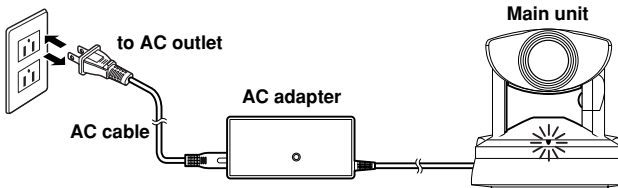

Note

- The camera head position is automatically initialized when the power supply is turned ON from OFF.
- **Never touch the camera head during initialization as this could prevent successful initialization and cause faults.**
- Wait at least five seconds before turning the power back on after shutting it off. Turning it on too quickly may result in a malfunction. Observe the precautions given in "⚠ Safe Use of Equipment/⚠ IMPORTANT SAFETY INSTRUCTIONS" (→ P.ix).
- **If the picture recording function (→ P.3-16) is being used, shutting off the power or restarting the VB-C10/VB-C10R will cause all pictures to be deleted.**

Sample Network Configurations

This section describes some typical installation modes for the VB-C10/VB-C10R.
Be sure to assign a fixed IP address to the VB-C10/VB-C10R.

Sample LAN Environment Configuration

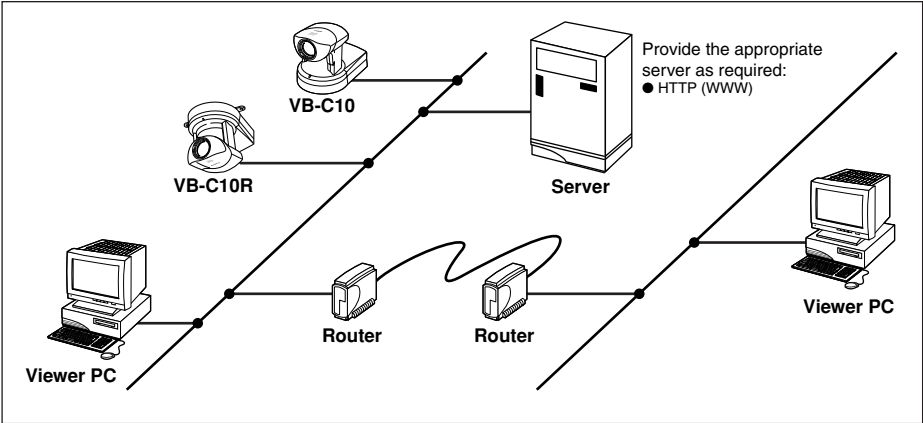

This example shows the VB-C10/VB-C10R connected to a LAN by Ethernet. In this configuration, videos can be seen by viewers in the same Ethernet segment as the VB-C10/VB-C10R and by viewers with access to that segment.

Sample Configuration in an ISP Environment

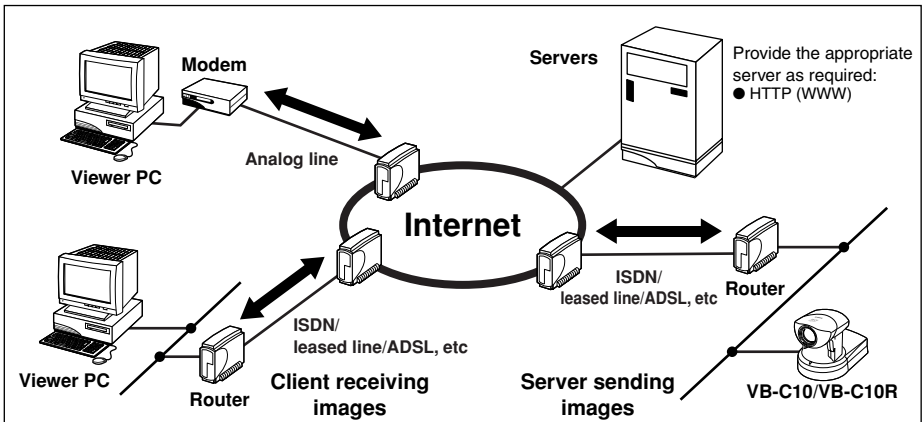

This example shows an environment in which the VB-C10/VB-C10R is connected to an ISP (Internet service provider). In this configuration, videos can be seen by viewers capable of accessing the ISP.

Bidirectional communication is required between the VB-C10/VB-C10R and the ISP, and a fixed IP address must be set for the VB-C10/VB-C10R.

Chapter

3

Setup Procedures

This chapter describes the procedures from the initial setup of the VB-C10/VB-C10R through to operation checking and the method for specifying detailed settings.

The VB Administration Tools described in Chapter 4 provide a convenient way to set view restrictions and presets.

Preparations for Initial Setup

Once the initial setup has been completed and operation has been verified, the VB-C10/VB-C10R can be used immediately. The diagram below shows an example of P2P connection between the VB-C10/VB-C10R and a PC.

Installation Example

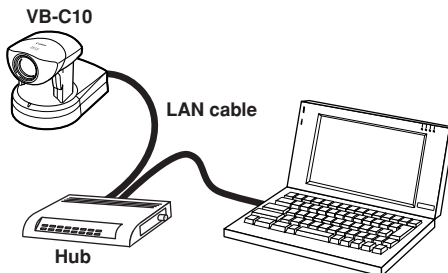

Installation Procedure

1. As shown in the diagram above, the VB-C10/VB-C10R is connected to a PC via a hub and LAN cables (10Base-T/100Base-TX).



At this stage, please do not connect the AC adapter to the VB-C10/VB-C10R yet.

2. Perform initial settings on the VB-C10/VB-C10R. (→ next page)
3. Check operation (→ P.3-6).



Check to be sure Internet Explorer 4.01 or later has been installed.

Initial Setup

1. Turn on the PC's power switch.

The AC adapter must not yet be connected to the VB-C10/VB-C10R at this stage.

2. Insert the CD-ROM that was supplied with the VB-C10/VB-C10R into the PC's CD-ROM drive, and start up the "VBIPI.exe" program as follows:

- ① Double-click My Computer on the desktop.

When using Windows XP, click on the "Start" button, then click "My Computer".

- ② When the CD-ROM icon appears, double-click this icon, then double-click "VBIPI.exe".

3. When the "VB-C10/VB-C10R IP Installer" dialog box appears, connect the AC adapter to the VB-C10/VB-C10R and turn on the power.

See "Turning the Power ON and OFF" (→ P.2-4) for how to turn on power to the VB-C10/VB-C10R.

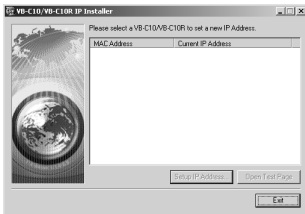

4. The VB-C10/VB-C10R's MAC address and the currently set IP address are displayed in the "VB-C10/VB-C10R IP Installer" dialog box.

Select a MAC address by clicking on it, then click the "Setup IP Address..." button.

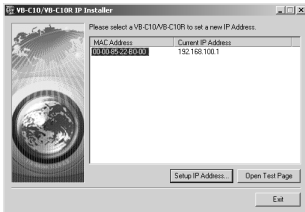

Tip

- The MAC address for this unit is shown on the bottom of the VB-C10/VB-C10R (→ P.1-11).
- The IP address **192.168.100.1** is used as the factory default setting. Please set an IP address that suits the environment in which the VB-C10/VB-C10R is to be used.
- Internet Explorer 4.01 or later is required for the IP Installer operating environment.

5. When the “Setup IP Address” dialog box appears, enter the new IP address, user name, and password. Then click the “OK” button.

New IP address: 192.168.101.7

User name: root

Password: VB-C10 (default setting)

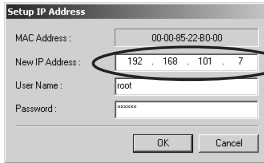

The values shown here are examples only.*

* The user name cannot be changed.

* The factory default password for both the VB-C10 and the VB-C10R is “VB-C10”.

* The password can be changed at any time on the System/Network settings page (→ P.3-9).

6. The IP address that was set is displayed.

When the IP address is successfully set, it is displayed in the “VB-C10/VB-C10R IP Installer” dialog box.

Click “Exit” to exit “VBIP1.exe.”

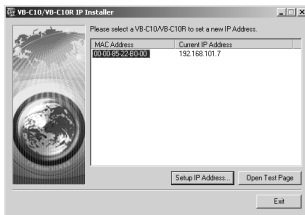

- The IP address “192.168.101.7” is given as an example. However, the actual IP address must be changed to match your system settings.
- Be careful to distinguish between lower-case and upper-case letters in order to accurately enter the user name and password.
- The user name is fixed at “**root**” for both the VB-C10 and VB-C10R. It cannot be changed.
- For reasons of system security, we recommend that you change the administrator password at regular intervals.
- If network setting values are not known, please consult with the network administrator.
- To cancel an IP address setting, click the “Cancel” button in the “Setup IP Address” dialog box.

7. Follow steps ① - ③ below to launch the browser and enter your user name and password.

① Launch the browser and enter the following URL:

http://192.168.101.7/admin/

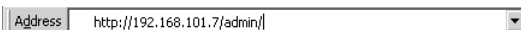

- ② Enter the user name and password.

User name: root

Password: VB-C10 (default setting)

- ③ The settings title page is displayed.

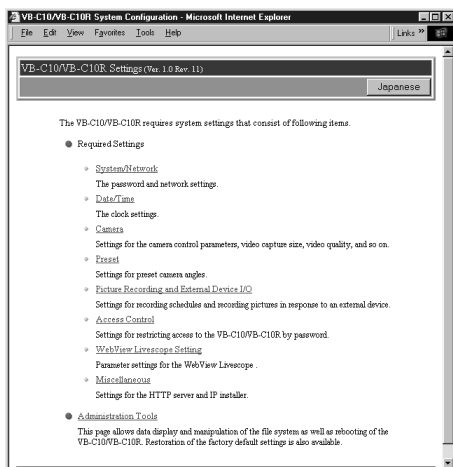

Initial settings are now complete.

Checking Operation

When you have completed the initial setup, check that the VB-C10/VB-C10R works normally. Use the sample page to simplify checking.

1. Access the sample page from the Web browser.

Example) <http://192.168.101.7/sample/>

Enter the value you have specified in the Initial Setup (→ P.3-3) as the IP address (192.168.101.7).



The IP address “192.168.101.7” is given as an example. However, the actual IP address must be changed to match your system settings.

2. Click on each sample page.

If the sample page appears and the video is displayed, the VB-C10/VB-C10R is operating normally.

* The Helper Viewer must be installed in order to appear “Helper Sample”.

Install the Helper Viewer from “MonSetup.exe” on the supplied CD-ROM.

Sample page



Example of the Java Viewer



* The picture displayed in the viewer is an example.



We recommend that you make panorama picture settings (→ P.4-7).

Detail Settings

Accessing the Settings Title Page

The various settings on the VB-C10/VB-C10R are specified by using a browser to access Web pages on the VB-C10/VB-C10R. You begin by accessing the **Settings Title Page**.



Note

This manual uses the IP address 192.168.100.1 (the factory default setting) below as an example to describe the detail settings. Please enter the actual IP address that is set in your VB-C10/VB-C10R.

1. Use the browser to access <http://192.168.100.1/admin>.

Use the IP address specified in “Initial Setup” (→ P.3-3).

2. Enter the user name and password.

You are now asked for your user name and password. In the factory default settings, the user name is “root” and the password is “VB-C10” for both the VB-C10 and VB-C10R. Enter these settings.

* The password can be changed at any time on the System/Network settings page (→ P.3-9).

Settings Title Page

Settings Title Page

The various settings on the VB-C10/VB-C10R are specified by using a browser to access Web pages on the VB-C10/VB-C10R. From this title page, you can move to each settings pages.

Settings Title Page for VB-C10/VB-C10R

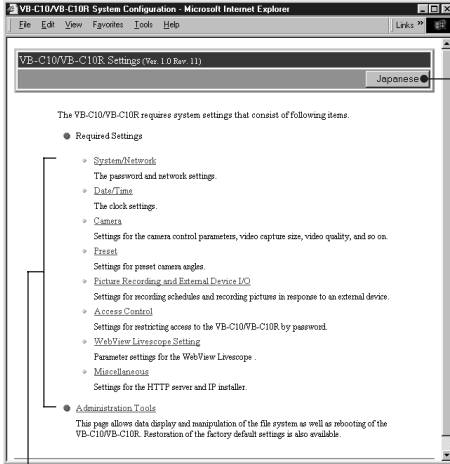

● **“Japanese” button**

Click this button to display the settings page in Japanese. The button then changes to “English” and switches the display back to English when clicked.

● Clicking on the titles displays each setting pages.



Note

- Do not open multiple browser windows at the same time to change settings in parallel.
- Do not use the “Back” and “Forward” buttons in your browser to move between settings pages. Due to the effects of caching, there are possibilities that an old settings page will appear, settings will return to their original values, or unintended changes will occur.
- Those settings that require the VB-C10/VB-C10R to be restarted for the changes to take effect are marked with a red tick.



- When using the VB-C10/VB-C10R to record pictures (→ P.3-16), all recorded still pictures are deleted when the VB-C10/VB-C10R is rebooted.

System/Network Settings Page

This page is used to make Ethernet and password settings for the administrator.

Root Account

"Password"

Set the password here. Up to 8 alphanumeric characters, including upper- and lower-case letters, hyphens and underscores, can be used.

"Confirm Password"

Enter the same password as above to confirm it.

Ethernet

"IP Address"

Enter the IP address you want to assign to VB-C10/VB-C10R.

"Subnet Mask"

Enter the subnet mask specified for the network to be connected.

"Default Gateway Address"

Set this item when you want to connect to a different segment within the Intranet or a wide area network such as the Internet.

*Contact the network administrator for the IP address, subnet mask, and default gateway address settings.



Note

- Assign a fixed IP address to the VB-C10/VB-C10R.
- For system security reasons, we recommend that you change the root account at regular intervals.
- If you have forgotten the password, press the Reset switch and restore the factory default settings (→ P.8-5).

Click the "OK" button to change the settings. To discard the changes, click the "Cancel" button. This returns you to the settings title page.

Date/Time Settings Page

This page is used to make date and time settings.

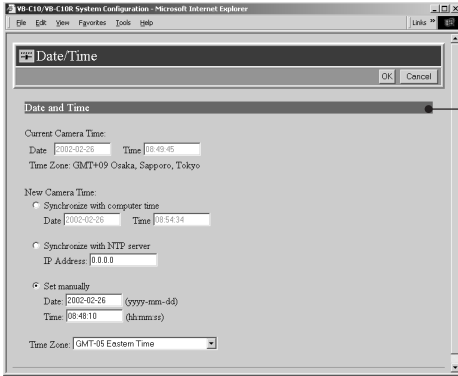

• Date and Time

“Current Camera Time”

Displays the date and time currently set on the VB-C10/VB-C10R.

“New Camera Time”

One of three methods can be selected: “Synchronize with computer time”, “Synchronize with NTP server”, or “Set manually”.

“Synchronize with computer time”

Sets to the date and time of the computer currently accessing the VB-C10/VB-C10R via a Web browser.

“Synchronize with NTP server”

Sets to the date and time of the NTP server when the IP address of an NTP server has been entered.

“Set manually”

Select this item when the date and time is to be manually entered. In the Date field, enter the year, month, and day in yyyy-mm-dd format; in the Time field, enter the time in hh:mm:ss 24-hour format.

For example, for January 1, 2002, 1:05:09 a.m., enter “2002-01-01” and “01:05:09”.

“Time Zone”

Since the factory default setting uses Japan Standard Time, please select the appropriate time zone from the list.



Note

When selecting “Synchronize with NTP server”, enter the correct NTP server IP address to be sure the date and time are changed correctly.

Click the “OK” button to change the settings. To discard the changes, click the “Cancel” button. This returns you to the settings title page.

Camera Settings Page

Use this page to set the camera control parameters and the video capture size and video quality.
Using VB Administration Tools is a convenient way to set view restrictions (→ P.4-12).

The screenshot shows a web browser window titled "VB-C10R VB-C10R System Configuration - Microsoft Internet Explorer". The main content area is titled "Camera" and contains the following settings:

- Camera Name:** Camera1 (up to 15 characters)
- Wide Converter:** Not used
- Video Capture Size:** 320x240
- Video Quality:** 1
- Home Position:** Return to Home Position when nobody has a control privilege.
- Pan:** 0.00 (range: -100.00 to 100.00)
- Tilt:** 0.00 (range: -30.04 to 90.00)
- Zoom:** 43.04 (range: 0.36 to 43.04)
- Brightness:** Standard
- Shutter Speed:** Auto
- Focus Mode:** Auto
- View Restriction:** Apply view restriction.
 - Upper value: (range: 46.18 to 106.14)
 - Lower value: (range: 46.18 to 106.14)
 - Left value: (range: 121.52 to 121.52)
 - Right value: (range: 121.52 to 121.52)
 - Telephoto: (range: 0.36 to 43.04)
 - Wide-angle: (range: 0.36 to 43.04)

Camera Settings

"Camera Name"

Used in the camera selection bar in the WebView Livescope Viewer.

"Wide Converter"

Select "Used" when a wide-angle converter is mounted on the camera.

"Video Capture Size"

The available settings are 640 × 480, 320 × 240 and 160 × 120.

"Video Quality"

Select an adjustment setting between 1 and 5. Higher values give better video quality but a slower frame rate since the amount of video data increases.

* With the VB-C10R, the displayed pan and tilt values change.

VB-C10/VR-C10R System Configuration - Microsoft Internet Explorer

File Edit View Favorites Tools Help

Camera

OK Cancel

Camera Settings

Camera Name: Camera (up to 15 characters)

Wide Converter: Not used

Video Capture Size: 1280x240

Video Quality: D

Home Position

Return to Home Position when nobody has a control privilege

Pan: 0.00 (-100.00 to 100.00)

Tilt: 0.00 (-30.04 to 90.00)

Zoom: 43.04 (3.36 to 43.04)

Brightness: Standard

Shutter Speed: Auto

Focus Mode: Auto

View Restriction

Apply view restriction

Upper value: (46.18 to 106.14)

Lower value: (46.18 to 106.14)

Left value: (-121.52 to 121.52)

Right value: (-121.52 to 121.52)

Telephoto: (3.36 to 43.04)

Wide-angle: (3.36 to 43.04)

• "View Restriction"

If you tick the "Apply view restriction" option, the settings below are enabled. Use this setting to prevent clients from seeing certain camera angles. **View restrictions are conveniently set using VB Administration Tools** (→ P.4-12).

"Upper value, Lower value, Left value, Right value"
Sets the visible range to be provided to the user.
* Set the values so that Upper value > Lower value,
and Left value < Right value.

"Telephoto, Wide-angle"
Sets the zoom angles provided to users.
* Set the values so that the Telephoto ≤ Wide-angle.

• "Home Position"

Specify the camera settings to be used at startup. The Pan, Tilt, and Zoom settings are valid when "Return to Home Position when nobody has a control privilege" is enabled.

"Pan"

Sets the pan position for the camera.

"Tilt"

Sets the tilt position for the camera.

"Zoom"

Sets the value for the camera's angle of zoom.

"Brightness"

Sets the target value for the camera's auto exposure feature. Select "Brighter" if the picture is darker due to backlight or other factor.

"Shutter Speed"

Sets the camera shutter speed. Select Auto, 1/60 or 1/100.

"Focus Mode"

Sets the focusing mode for the camera. Select "Auto", "Auto (for domes)", or "Fixed at infinity". When the VB-C10/VR-C10R is used with an outdoor housing, focusing on the wall of the outdoor housing can be avoided if the Focus mode is set to "Auto (for domes)".

Click the "OK" button to change the settings. To discard the changes, click the "Cancel" button. This returns you to the settings title page.



Note

View restrictions can be set visually and more easily from the VB Administration Tools. Please use the VB Administration Tools for making settings (→ P.4-12).

View Restriction Settings

You can set the visible range by restricting the camera pan, tilt and zoom ratio (field of view angle) settings.

■ Controllable range and Video Capture Range

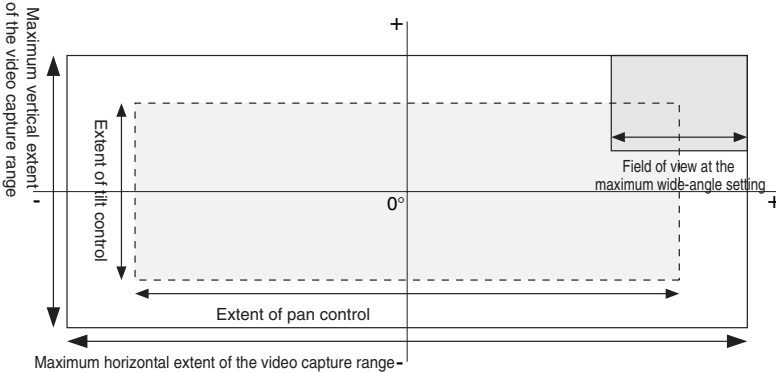

The view restriction specifies the visible range. The visible range is larger than the area in which pan and tilt can be controlled.



Note

Do not attempt to manually change the camera head angle.

If the camera head is accidentally moved by hand or other objects touching it, be sure to restart the VB-C10/VB-C10R by turning the power supply OFF then ON again. The deviation from the position that the VB-C10/VB-C10R memorizes will be corrected and the operation will be back in order.



Range of Camera Head Movement

The figures below show the range of camera head movement from a horizontal position.

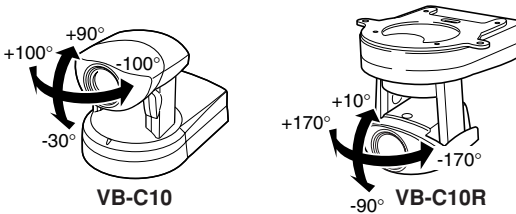



About view restriction

- Pan and tilt range varies with the zoom ratio (field of view angle).

When you set the view restriction, the angles of camera movement are automatically restricted.

If the zoom is set to wide-angle and the angle of camera movement remains the same, video capture extends beyond the permitted range. Consequently, the angle of movement is automatically reduced.

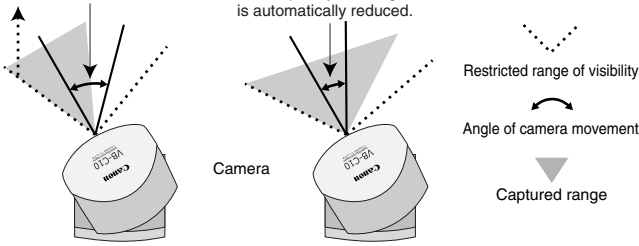

If the visible range is exceeded because the zoom is set to wide range, the camera angle (pan, tilt) will be adjusted automatically.

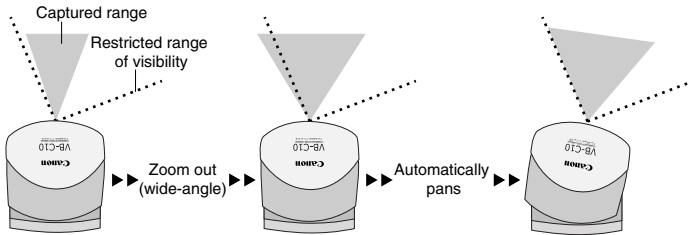

- If the visible range is restricted, the zooming range may also be restricted.

Preset Settings Page

Use this page to specify the settings for preset camera positions provided to viewers.

Using VB Administration Tools is a convenient way to set presets (→ P.4-17).

Common Settings

“Restrict Camera Control to Presets”
VB-C10/VB-C10R camera control using Helper Viewer and Java Viewer can be restricted to the preset angle only.

Presets 1-8

Up to 8 presets can be specified.

“Application”
Use these options to specify whether this preset can be used only for picture recording (→ P.3-16) or is also made available in WebView Livescope Viewer. If it is also provided in WebView Livescope Viewer, always specify the preset name.

“Preset Name”
Enter a name consisting of up to 15 alphanumeric characters.

“Camera Parameter”
Enter the center angle between the angles you want to set for Pan and Tilt. Enter the viewing angle for zoom.

“Pan”
Sets the pan position for the camera.

“Tilt”
Sets the tilt position for the camera.

“Zoom”
Sets the value for the camera’s angle of zoom.

“Brightness”
Sets the target value for the camera’s auto exposure feature. Select “Brighter” if the picture is darker due to backlight or other factor.

Click the “OK” button to change the settings. To discard the changes, click the “Cancel” button. This returns you to the settings title page.



Changes in presets are not applied in the viewer while it is connected.



Presets can be set visually and more easily from the VB Administration Tools. Please use the VB Administration Tools for making settings (→ P.4-17).

Picture Recording and External Device I/O Settings Page

Use this page to specify the operating condition for the picture recording function. Settings on this page can be used to record still pictures in response to inputs from an external device (sensor, etc.) and based on a predetermined schedule. See Chapter 6, "Using the Picture Recording Function" (→ P.6-2) for detailed operating examples.

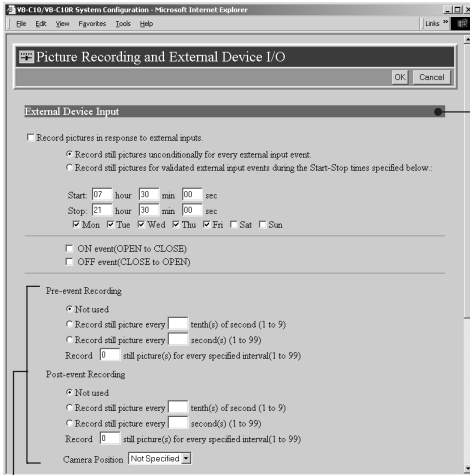

External Device Input

"Record pictures in response to external inputs"

Tick this option to record pictures when an input is detected from an external device.

"Record still pictures unconditionally for every external input event/ Record still pictures for validated external input events during the Start-Stop times specified below"

Select "Record still pictures unconditionally for every external input event" if pictures are to be recorded at any time when an input is received from an external device. If pictures are to be recorded only during specified periods, select "Record still pictures for validated external input events during the Start-Stop times specified below" and set the start time, day of the week, etc.

"Start/Stop"

Set the time when picture recording is to start and when it is to stop.

* "Start" and "Stop" cannot be set to the same time.

"Day"

Select the day of the week when pictures are to be recorded. Picture recording will occur on the selected day of the week for the period from "Start time" to "Stop time".

"ON event (OPEN to CLOSE)"

Pictures are recorded when ON events are detected from an external device.

"OFF event (CLOSE to OPEN)"

Pictures are recorded when OFF events are detected from an external device.

"Pre-event Recording"/"Post-event Recording"

Specify how pictures are to be recorded before and after an event is detected from an external device. There is "Pre-event Recording", for recording pictures prior to events from an external device, and "Post-event Recording", for recording pictures following events. Be sure to enter at least one of these.

If "Pre-event Recording" or "Post-event Recording" are used, specify the interval between picture recording in 1-sec. units or 0.1-sec. units, and enter the number of pictures to be recorded.

"Camera Position"

Select the angle to be used in Post-event Recording. Select "Not Specified" or from Preset 1 to 8 (→ P.3-15).



Note

- When recording pictures, if you turn off the VB-C10/VB-C10R's power switch and then reboot it, all recorded still pictures will be deleted.
- Depending on the operating status of the VB-C10/VB-C10R, still pictures may not be recorded according to the specified intervals and the number of pictures to be recorded. Please check the actual operation after the settings have been made.



Tip

- See "Picture Recording triggered by External Devices" (→ P.3-18).
- When recording pictures, it is convenient to do so in combination with VBCollector, which automatically collects recorded still pictures (→ P.6-6).

● Schedule

“Record pictures according to a schedule”
When this is selected, pictures are recorded at the interval set below. The interval can be set for every 1 to 59 seconds, every 1 to 59 minutes, or every 1 to 24 hours.

“Camera Position”

Select the angle to be used when recording pictures. Select “Not Specified” or from Preset 1 to 8 (→ P.3-15).

“Camera Stabilization Time”

The time set here is the time allowed for camera operation to stabilize before it starts recording pictures. Maximum setting is 10 seconds, enter an integer between 0 and 10.

● External Device Names

Set names for the external input/output devices used in WebView Livescope MV.

Be sure to enter the device name.

* “External Device Input” and “Schedule” cannot be used together.



Note

- The maximum memory capacity that can be used for recording pictures is approximately 5 MB. Available space can be checked with the Administration Tools settings page (→ P.3-22).
- **Recorded pictures are deleted when power to the VB-C10/VB-C10R is shut off or the VB-C10/VB-C10R is restarted.** Please use VBCollector to collect recorded pictures (→ P.6-6).
- Recorded pictures are not overwritten. Once the recording picture memory (approximately 5 MB) becomes full, recording stops. **Use the Administration Tools Settings Page (→ P.3-22) to delete recorded pictures.**

Click the “OK” button to change the settings. To discard the changes, click the “Cancel” button. This returns you to the settings title page.



Tip

The amount of data for a still picture varies depending on the settings for video capture size and video quality (→ P.3-11), and the subject. As a guide, approximately 5-10 KB is the standard when the video capture size is set to 320 × 240 and the video quality is set to 3 (In some cases this may be exceeded). To check the amount of data for a still picture, select “View” - “Video information” from the menu after you start up the Helper Viewer, then check the “Size” value.



Tip

Picture Recording triggered by External Devices



- Pictures can be recorded in response to ON/OFF events detected from an external device.

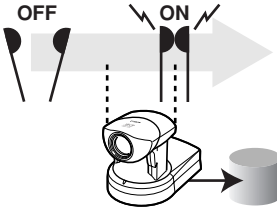

A: Pre-event recording for an ON event

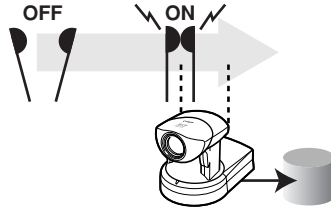

B: Post-event recording for an ON event

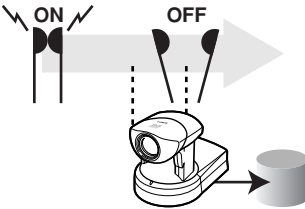

C: Pre-event recording for an OFF event

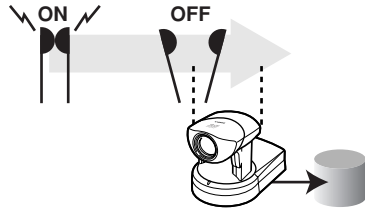

D: Post-event recording for an OFF event

- For A and C, recording is controlled to the pre-event recording time, and for B and D, it is controlled to the post-event recording time.

Access Control Settings Page

From this page, you can permit access to the VB-C10/VB-C10R to specific authorized users only. Unauthorized clients' access is prohibited.

• Authorized User Account

“Authorized User List”

Only accounts registered in this list are permitted to connect to the VB-C10/VB-C10R. **Up to 20 users can be registered.**

“Delete”

Select a user account and click the delete button to remove the user from the list.

“Add”

You can add authorized users to the list by entering their account name and password.

“Access permitted to listed users only”

When this option is ticked, only users registered in the list are permitted to connect to the VB-C10/VB-C10R.

Click the “OK” button to change the settings. To discard the changes, click the “Cancel” button. This returns you to the settings title page.

WebView Livescope Setting Settings Page

Make the various settings such as the number of simultaneous clients, frame rate, and maximum camera control time.

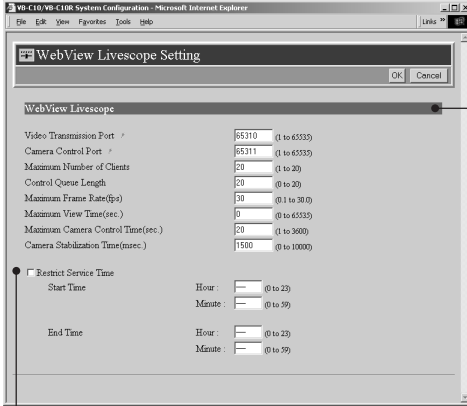

● **“Restrict Service Time”**

When you want to set a time for videos to be distributed to the WebView Livescope Viewer, select this option, and specify the Start and Stop times. With Admin Viewer, connections can also be made and videos viewed at times other than those set (→ P.4-24).

● **WebView Livescope**

“Video Transmission Port”

Set a TCP port number to be used for transmitting videos between the VB-C10/VB-C10R and the WebView Livescope Viewer. Enter an integer between 1 and 65535. The default setting is 65310.

“Camera Control Port”

Set a TCP port number to be used for controlling the camera between the VB-C10/VB-C10R and the WebView Livescope Viewer. Enter an integer between 1 and 65535. The default setting is 65311.

“Maximum Number of Clients”

Sets the maximum number of clients that can simultaneously be connected using the WebView Livescope Viewer. Enter an integer between 1 and 20.

“Control Queue Length”

Sets the length of the queue when multiple clients are waiting for control privilege under the WebView Livescope Viewer. Enter an integer between 0 and 20. The maximum number is 20. When set to “0”, only the Admin Viewer is permitted to control the camera.

“Maximum Frame Rate (fps)”

Sets the maximum number of frames captured per second. Enter a number between 0.1 and 30. The maximum frame rate is 30 fps.

“Maximum View Time (sec)”

Sets the maximum time the clients can view videos using the WebView Livescope Viewer. Enter an integer between 0 and 65535. A setting of 0 disables the time limitation (unlimited connection time).

“Maximum Camera Control Time (sec)”

Sets the maximum time one client can keep the camera control privilege using the WebView Livescope Viewer. Enter an integer between 1 and 3600. The maximum control time is 3600 seconds.

“Camera Stabilization Time (msec.)”

When the GetStillImage command (→ P.5-24) has been requested, this setting specifies the delay to allow the camera to stabilize before still picture is captured. Enter an integer between 1 and 10000. The maximum delay is 10000 milliseconds.

Click the “OK” button to change the settings. To discard the changes, click the “Cancel” button. This returns you to the settings title page.

Miscellaneous Settings Page

Use this page to specify various other settings.

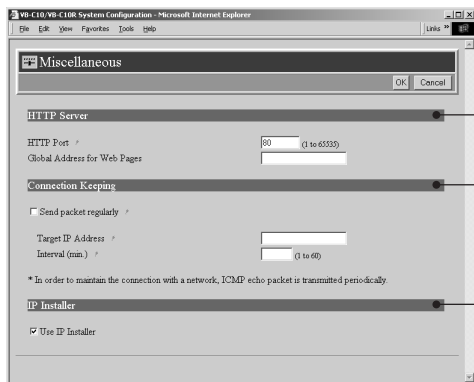

HTTP Server

"HTTP Port"

Sets the TCP port number for the HTTP. Enter an integer between 1 and 65535. The default setting is No. 80.

"Global Address for Web Pages"

If a private address has been set in the VB-C10/VB-C10R and you want to use the router's NAT function to have a fixed global address assigned to the VB-C10/VB-C10R (→ P.5-26), enter a global address here so that you can view the sample pages (→ P.5-6).

Connection Keeping

"Send packet regularly"

When this is selected, an ICMP Echo packet is transmitted periodically to a specified address in order to maintain the network connection.

"Target IP Address"

Enter the IP Address of the host to which the packet is to be sent.

"Interval (min.)"

Specify the packet transmission interval in minutes. Enter an integer between 1 and 60.

IP Installer

"Use IP Installer"

When this is selected, the VB-C10/VB-C10R's IP address can be set using the "VBIPI.exe" program contained on the supplied CD-ROM.

In the factory default settings, this item is selected.

Click the "OK" button to change the settings. To discard the changes, click the "Cancel" button. This returns you to the settings title page.



Note

For the packet target address in the connection function, we recommend that you consider the impact on traffic conditions and set the IP address that is nearest after the auto dial-up router.

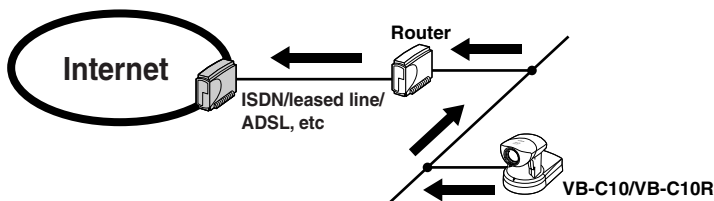

Administration Tools Settings Page

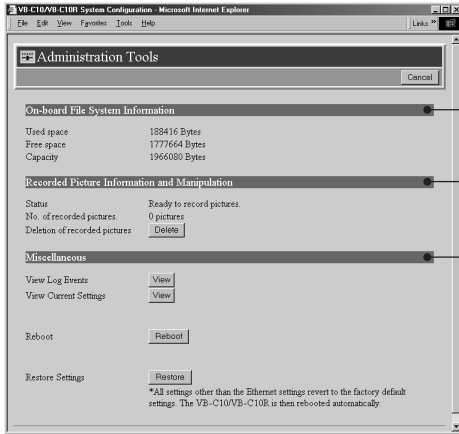

● **On-board File System Information**

The On-board File System Information displays the used space, free space and capacity (used space + free space) in bytes.

● **Recorded Picture Information and Manipulation**

The picture recording status and the number of recorded pictures are displayed. Also, all recorded still pictures can be deleted by clicking the “Delete” button.

● **Miscellaneous**

“View Log Events”

Click the “View” button to see the historical log files of the VB-C10/VB-C10R’s operation, viewers, etc.

“View Current Settings”

Displays a list of the current settings when the “View” button is clicked.

“Reboot”

The VB-C10/VB-C10R will start again when the “Reboot” button is clicked.

“Restore Settings”

When the “Restore” button is clicked, all settings on the VB-C10/VB-C10R, except for network-related settings such as the IP address, subnet mask, and default gateway address, are restored to the factory default settings.



Note

- When the Reset switch on the rear of the VB-C10/VB-C10R is pressed, all settings including the IP address are returned to the factory default settings (→ P.8-5).
- Since the work area for the VB-C10/VB-C10R is included in the free space on the on-board file system, files may not be created when the free space becomes approximately 100KB (→ P.5-8).

Click the “Cancel” button to exit from this page. This returns you to the settings title page.

Chapter **4**

VB Administration Tools

This chapter describes how to use the VB Administration Tools in order to create panoramas, set view restrictions, make presets, view logs, and use the Admin Viewer. Although view restriction and preset settings can be made following the procedures described in Chapter 3, the VB Administration Tools and their more visual environment make the settings much easier.

Overview of VB Administration Tools

VB Administration Tools is an application that simplifies the management and operation of the VB-C10/VB-C10R.

VB Administration Tools comprises “VBAAdmin Startup Panel,” “Panorama Creation Tool,” “View Restriction Tool,” “Preset Setting Tool,” “Log Viewer,” and “Admin Viewer” applications. Operations such as setting the VB-C10/VB-C10R or viewing pictures from a remote location with special privilege, checking operating status or obtaining logs are easily performed through the Internet or Intranet.

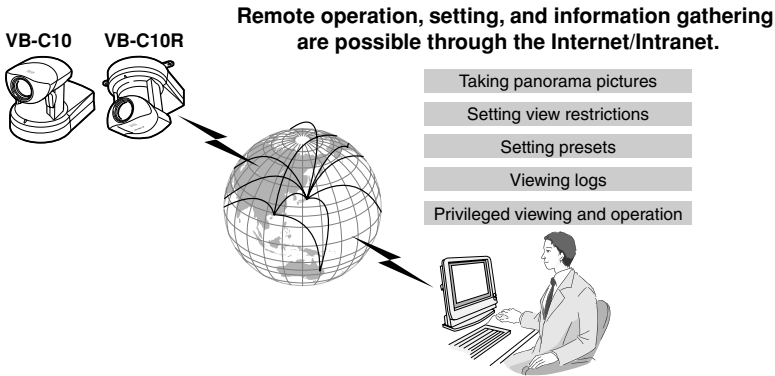

VBAAdmin Startup Panel (→ P.4-4)

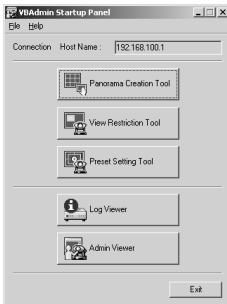

This is the main panel of VB Administration Tools. The tools are started up from this panel. Install VB Administration Tools first from the supplied CD-ROM.

Panorama Creation Tool (→ P.4-7)



This tool is used to take or create panorama pictures.

View Restriction Tool (→ P.4-12)

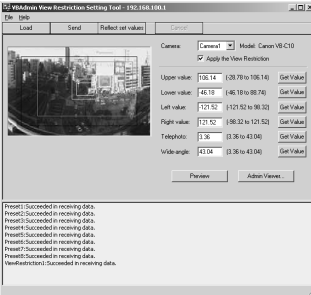

This tool enables easier, more visual setting of view restrictions. Restrictions can be set by operating the mouse while referring to panorama previews.

Preset Setting Tool (→ P.4-17)



This tool enables easier, more visual setting of camera preset positions. Presets can be set by operating the mouse while referring to panorama previews.

Log Viewer (→ P.4-22)



This tool enables viewing of operation status logs that are output to the VB-C10/VB-C10R.

Admin Viewer (→ P.4-24)

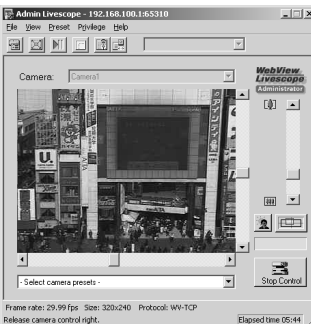

This tool has a special privilege aimed at administrators of the VB-C10/VB-C10R. Use it when setting presets, view restrictions, etc.

Installing VB Administration Tools

Install VB Administration Tools from the CD-ROM supplied with the VB-C10/VB-C10R.



VB Administration Tools require that Microsoft Internet Explorer 5 or later be installed.

1. Turn on the power to the PC.

If power to the PC is already on and Windows is running, exit all other applications before installing VB Administration Tools.

2. Insert the CD-ROM supplied with the VB-C10/VB-C10R into the PC's CD-ROM drive, and follow the procedure below.

① Double-click "My Computer" on the desktop.

When using Windows XP, click on the "Start" button, then click "My Computer".

② When the CD-ROM icon appears, double-click this icon, then double-click "AdmSetup.exe."



AdmSetup.exe

3. Perform the installation following instructions on the screen.



4. Complete installation.

When installation is complete, two icons are created on the desktop: "VB Admin Tools" and "Admin Viewer".



VB Admin
Tools



Admin Viewer

Also, When [Program]-[WebView Livescope] is selected from the Start menu, two shortcuts are created in the same way.

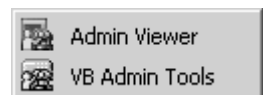

Starting Up VB Administration Tools

VB Administration Tools can be started up using the icon created on the desktop or by selecting it from the Start menu.

To Start Up...

1. If you are starting up a tool from the VBAdmin Startup Panel, either double-click the “VB Admin Tools” desktop icon or choose “VB Admin Tools” from the Start menu.



VB Admin Tools

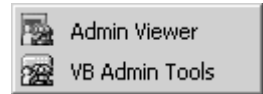

2. When VB Administration Tools starts up, the “Server Setting” dialog box appears.

To use VB Administration Tools, it must first be connected to the VB-C10/VB-C10R.

Enter the required information in the fields and click the “OK” button.

- **Host Name**

Specify the IP address or host name.

- **Administrator Account : root**

Enter “root” as the administrator account. (This cannot be changed.)

- **Administrator Password**

Enter the administrator password that has been set on page 3-9. (The default setting is “VB-C10” for both the VB-C10 and VB-C10R.)

- **HTTP Port**

Enter the HTTP port number that has been set in the VB-C10/VB-C10R. (The default setting is 80.)

- **URL for settings : admin**

Enter “admin” as the administrator URL. (This cannot be changed.)

- **Proxy**

Please consult with the network administrator for proxy settings.

- **“Use HTTP Proxy Server”**

Select this item if the connection to the VB-C10/VB-C10R is to pass through a proxy server.

- **“Host Name”**

Specify the host name or IP address of the proxy server.

- **“Port”**

Enter the port number of the proxy server. (The default setting is 8080.)

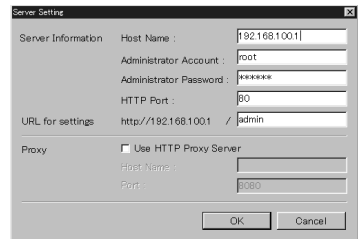

3. The VBAAdmin Startup Panel starts up.

The five tools—“Panorama Creation Tool”, “View Restriction Tool”, “Preset Setting Tool”, “Log Viewer”, and “Admin Viewer”—can be started up from the Startup Panel by clicking on the each button.

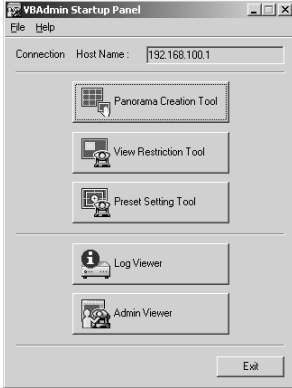

If the connection is disconnected after the VBAAdmin Startup Panel has started up, choose “Connect” from the File menu. The “Server Setting” dialog box then appears.

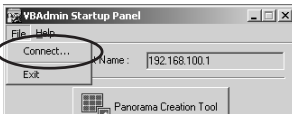

Tip

- The “Panorama Creation Tool”, “View Restriction Tool”, and “Preset Setting Tool” cannot be started up simultaneously. “Log Viewer” and “Admin Viewer” can be started up at the same time.
- If the connection to the VB-C10/VB-C10R is made through a proxy server, the “Panorama Creation Tool”, “Log Viewer”, and “Admin Viewer” cannot be used.

Panorama Creation Tool

The Panorama Creation Tool is used to take and create panorama pictures for the VB-C10/ VB-C10R. When they have been created, the panorama pictures can be viewed when accessed from the viewer.

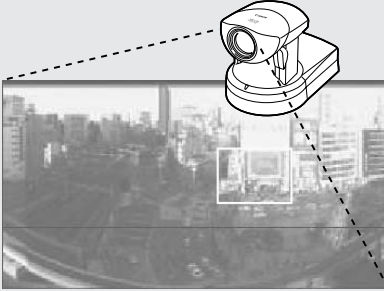

The Panorama Creation Tool is used to take and create panorama pictures and save them in the VB-C10/VB-C10R.

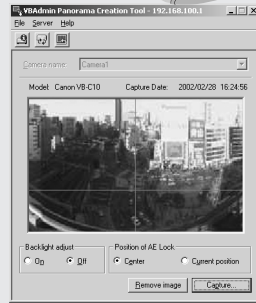

Without a panorama picture

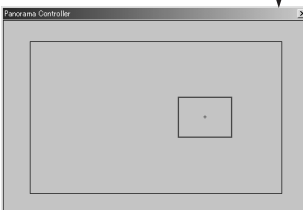
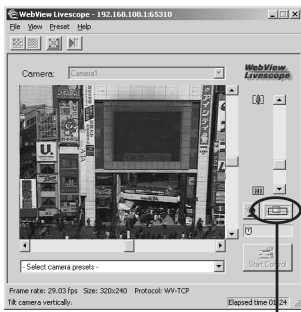

With a panorama picture

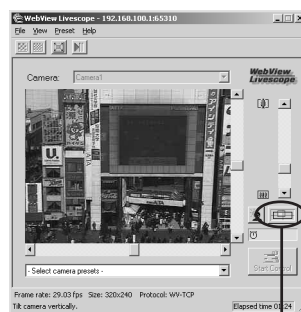

About the Panorama Creation Tool Display Screen

An overview of the functions of the GUI that is displayed after the Panorama Creation Tool starts up is described below.

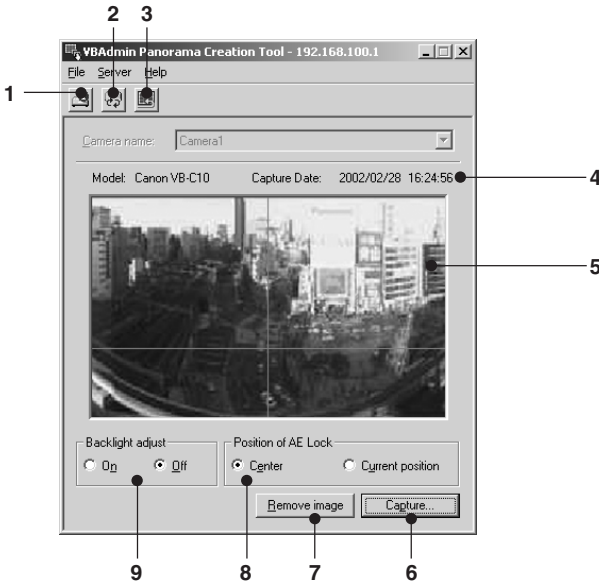

1 Display Connect Information

Displays the VB-C10/VB-C10R's connection information in a dialog box.

2 Reload Camera Information button

Recaptures camera information and panorama information. If VB-C10/VB-C10R settings were changed after this tool was started up, this button can be used to get the latest information.

3 Update Panorama Image button

Sends panorama pictures to the VB-C10/VB-C10R and reloads them.

4 Captured date display

The date the panorama picture was captured, if one was recorded, are displayed here.

5 Panorama picture display

Shows the panorama picture that was captured.

6 Capture button

Captures panorama pictures.

7 Remove image button

Deletes panorama pictures.

8 Position of AE Lock switching

Switches AE lock position between "Center" and "Current position". The AE Lock function captures pictures based on the brightness of the selected position.

9 Backlight adjust switching

This function adjusts backlight. When switched on, it is effective on images that are dark due to backlight.



Tip

Since the range that can be captured varies with the type of camera, the display ranges of the panorama pictures are different.

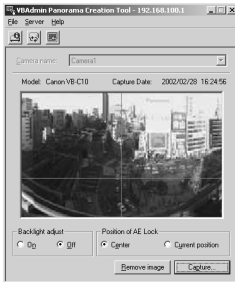

VB-C10 panorama picture

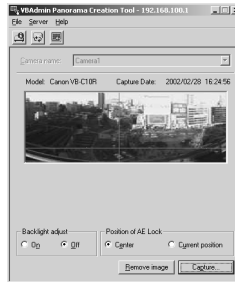

VB-C10R panorama picture

Capturing Panorama Pictures



Note

Since the entire area of panorama picture is captured and displayed during capturing, if the VB-C10/VB-C10R is accessed from the viewer and pictures are viewed, even when view restrictions (→ P.3-12) have been set, there is a possibility that third parties that were originally not intended to see the pictures may see them. Please keep this sufficiently in mind when capturing and displaying panorama pictures.

To Capture...

1. Check the AE Lock position and the backlight adjustment settings, then click the “Capture” button.

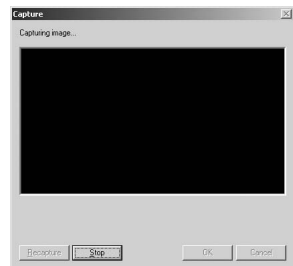

2. Capturing starts.

To stop capturing while it is in progress, click the “Stop” button.



3. When capturing ends and the picture is satisfactory, click the “OK” button.

Panorama creation can be discarded, or the AE lock position or backlight adjustment settings can be changed by clicking the “Cancel” button. When clicked, the captured picture is discarded and the initial screen returns.

To capture the picture again, click “Recapture” button. Or, a square section in the displayed grid can be captured again by double-clicking on that section.

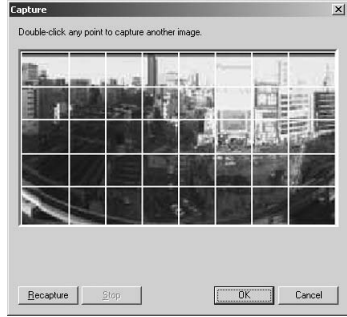

Updating/Deleting Panorama Pictures

When capturing ends, the panorama picture is reflected when it is sent to the VB-C10/VB-C10R and loaded.

To Update...

Click the “Update Panorama Image” button. Or choose “Update Panorama Image” from the Server menu.

When the panorama picture is updated, the VB-C10/VB-C10R automatically restarts and the connection with VB Administration Tools is cut. A dialog box asking whether or not to reconnect to the VB-C10/VB-C10R appears after the VB-C10/VB-C10R restarts. When the “OK” button is clicked, reconnection occurs. You can exit Panorama Creation Tool while still connected or without reconnecting to the VB-C10/VB-C10R.



To Delete...

Click the “Remove image” button, and then the “Update Panorama Image” button.

The panorama picture saved in the VB-C10/VB-C10R is deleted.



Reconnecting

Reconnections are made when a connection with the VB-C10/VB-C10R has been cut.

To make a reconnection, choose “Reconnect” from the File menu.

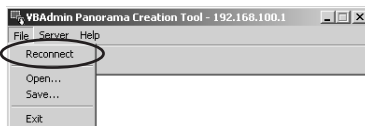

Opening/Saving Pictures

Panorama pictures can be opened from picture files or saved as picture files.

To retrieve a picture file and use it for a panorama picture, choose “Open” from the File menu. When the dialog box appears, select the file you want to use.

To save a captured panorama picture as a picture file, choose “Save” from the File menu. When the dialog box appears, select the folder where the file is to be saved and enter the file name. In both cases, only the JPEG format is supported.

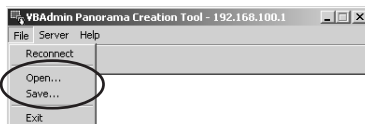

Displaying Connection Information

Connection information during connection with the VB-C10/VB-C10R can be displayed.

Choose “Connect Information” from the Server menu and a dialog box showing the connection information appears.



The IP address that was set in the VB-C10/VB-C10R is displayed in the “Host name” (→ P.3-9). The “Video transmission port” and the “Camera control port” that were set on page 3-20 and the “HTTP port” that was set on page 3-21 are all displayed.

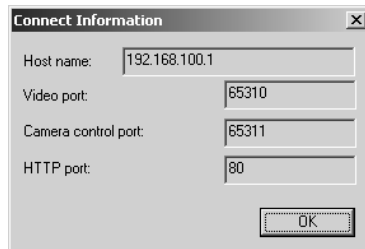

Tip

While the Panorama Creation Tool is starting up, the video capture size (→ P.3-11) automatically becomes 160 × 120. It returns to the original specified size when you exit this tool.

View Restriction Tool

The View Restriction Tool is used to set view restriction visually and more easily for the VB-C10/ VB-C10R. The viewing range is simply set using mouse operations such as dragging, while viewing the panorama picture.

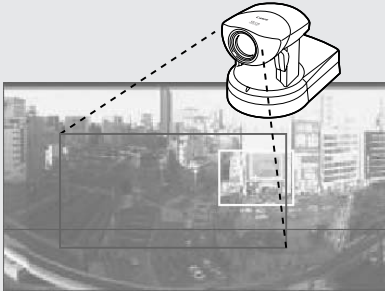

Example:
You want to distribute video of a tourist site but you want to place restrictions on the zoom.
→ Set the view restrictions using the View Restriction Tool.

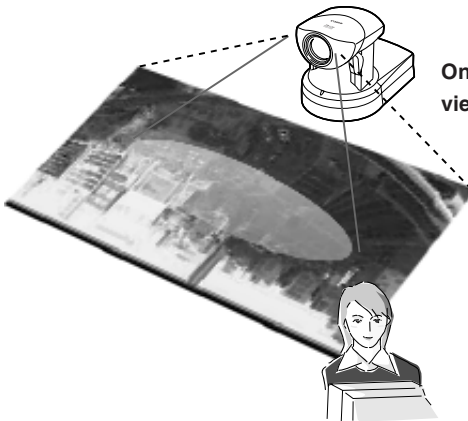

Only the range that was specified in the view restriction is displayed in the viewer.



The View Restriction Tool Display Screen

An overview of the functions of the GUI displayed when the View Restriction Tool is started up is given below.

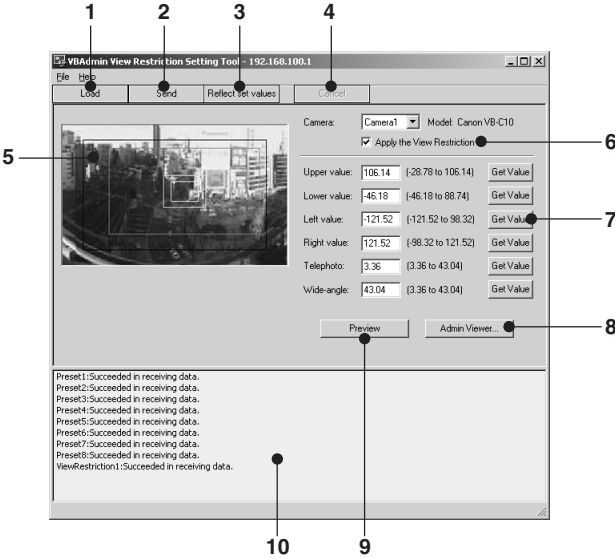

1 Load button

Loads the view restriction values currently set in the VB-C10/VB-C10R.

2 Send button

Sends to the VB-C10/VB-C10R the current view restriction values edited with this tool.

3 Reflect set values button

Reflects in the VB-C10/VB-C10R the view restriction values that were sent by clicking the “Send” button.

4 Cancel button

This button can be clicked during communication with the VB-C10/VB-C10R to cut the connection.

5 Panorama Preview

Displays panorama pictures saved in the VB-C10/VB-C10R. The frames that reproduce the values of all the view restriction settings are displayed on the panorama picture. These frames can be displayed when “Apply the View Restriction” is selected. Also, dragging operations can be used to change the shapes of the frames and reflect the changes in the setting values.

●View Restriction Preview frames

“Pan • Tilt Preview Frame (red)” Currently set Upper • Lower • Left • Right value restriction area

“Wide-angle Preview Frame (green)” Currently set wide-angle restriction area

“Telephoto Preview Frame (yellow)” Currently set telephoto restriction area

6 Apply the View Restriction

View restriction settings are applied when this item is selected.

7 View Restriction Values Entry box and Get Value button

The current view restriction settings are displayed in the View Restrictions Value Entry box, and new values can be entered to change the settings. When the “Get Value” button is clicked, the current shooting angle of the VB-C10/VB-C10R can be retrieved and reflected in the setting values.

●View restriction setting values

“Upper value” Value for the upper limit of the view restriction. The upper value of the VB-C10/VB-C10R’s shooting angle is obtained using the “Get Value” button.

“Lower value” Value for the lower limit of the view restriction. The lower value of the VB-C10/VB-C10R’s shooting angle is obtained using the “Get Value” button.

“Left value” Value for the left limit of the view restriction. The left value of the VB-C10/VB-C10R’s shooting angle is obtained using the “Get Value” button.

“Right value” Value for the right limit of the view restriction. The right value of the VB-C10/VB-C10R’s shooting angle is obtained using the “Get Value” button.

“Telephoto” Value for the telephoto limit of the view restriction. The zoom value of the VB-C10/VB-C10R’s shooting angle is obtained using the “Get Value” button.

“Wide-angle” Value for the wide-angle limit of the view restriction. The zoom value of the VB-C10/VB-C10R’s shooting angle is obtained using the “Get Value” button.

8 Admin Viewer button

This button can be used to start up Admin Viewer.

9 Preview button

Clicking this button allows checking of the set values specified in the View Restriction Values Entry box with the View Restriction Preview frame.

10 Status List

Displays the results of communication between this tool and the VB-C10/VB-C10R.



Edited content will not be reflected in the viewer accessed to the VB-C10/VB-C10R at the stage when the “Send” button is used to send edited content to the VB-C10/VB-C10R. After confirming the edited content, be sure to use the “Reflect set values” button to reflect the settings in the VB-C10/VB-C10R.

Setting View Restrictions

View Restrictions can be set in one of two ways. Use the method that suits your environment or taste.

1: Retrieving values from Admin Viewer and changing settings

To Make Settings...

Start up Admin Viewer and set the view restriction from the shooting angle of the VB-C10/VB-C10R.

- 1 Select the “Apply the View Restriction”.
Click the “Admin Viewer” button to start it up.



- 2 Use Admin Viewer to move the camera angle to the position you want to set with the Upper, Lower, Left, Right, Telephoto, and Wide-angle values, then click the “Get Value” button for each.

View restrictions set can be checked in the View Restriction Values Entry box, or with the View Restriction Preview frame. Set these values so that Upper > Lower, Left < Right, and Telephoto \leq Wide-angle.

- 3 Click the “Send” button.

Check the Status List to be sure the values were sent correctly. Then when the “Reflect set values” button is clicked, the values will be reflected in the VB-C10/VB-C10R.

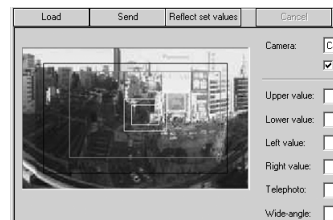

2: Changing Settings from the View Restriction Preview Frame

To Make Settings...

The View Restriction Preview frame on the panorama picture can be used to set view restrictions.

- 1 Select the “Apply the View Restriction”. Set the view restrictions by using the mouse to move or change the shape of the “Pan · Tilt Preview Frame (red)”, “Telephoto Preview Frame (yellow)”, and “Wide-angle Preview Frame (green)” displayed on the panorama picture.

When enlarging or reducing the Telephoto Preview and Wide-angle Preview frames, however, the vertical:horizontal ratio is fixed.



- 2 Click the “Send” button.

Check the Status List to be sure the values were sent correctly. Then when the “Reflect set values” button is clicked, the values will be reflected in the VB-C10/VB-C10R.

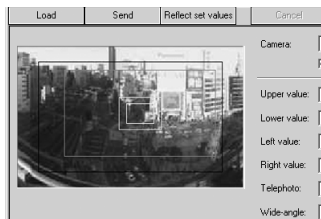

Tip

- Since previews using Panorama Preview may be slightly different from the actual pictures, after the view restrictions have been set, please check to be sure the viewer correctly reflects the view restrictions in the actual picture. In this event, since Admin Viewer normally operates the camera irrespective of the view restriction settings, please choose [View Restriction]-[ON] from the Privilege menu (→ P.4-26).
- When you want to clear the view restriction settings, remove tick from the “Apply the View Restriction” check box, click the “Send” and “Reflect set values” buttons to reflect in the VB-C10/VB-C10R.
- View restriction is not applied to the values with entry boxes left blank even the “Apply the View Restriction” is selected.
- For details on view restriction settings, see page 3-12.

Preset Setting Tool

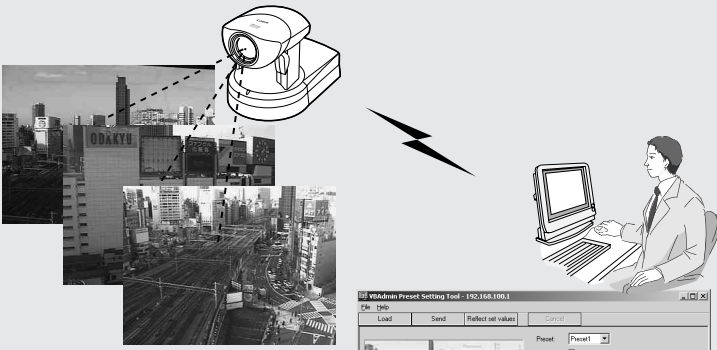

The Preset Setting Tool more easily and uniformly sets the preset function of the VB-C10/VB-C10R. Settings can be made using simple mouse operations such as clicking and dragging while referring to the panorama picture.



Setting presets using the Preset Setting Tool

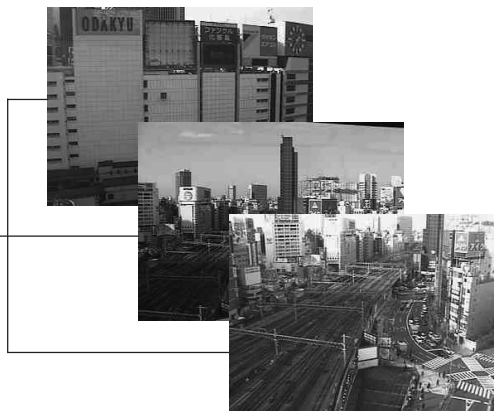

Reflecting preset settings in the viewer



Preset Setting Tool Display Screen

An overview of the functions of the GUI that is displayed after the Preset Setting Tool starts up is described below.

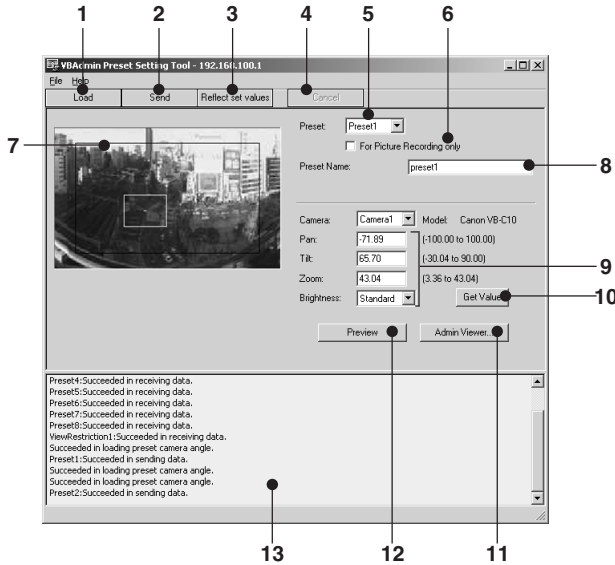

1 Load button

Loads the VB-C10/VB-C10R's current preset settings.

2 Send button

Sends to the VB-C10/VB-C10R the current preset settings edited with this tool.

3 Reflect set values button

Reflects in the VB-C10/VB-C10R the preset settings that were sent by clicking the "Send" button.

4 Cancel button

This button can be clicked during communication with the VB-C10/VB-C10R to cut the connection.

5 Preset Selection box

Select the preset to be set.

6 For Picture Recording only

Select whether or not settings are to be used with the viewer. If selected, presets are used only when recording pictures; if not selected, presets can be used not only for picture recording but for the viewer as well.

7 Panorama Preview

Displays the panorama picture saved in the VB-C10/VB-C10R. A preset preview frame (yellow) that reproduces the preset values that were set is displayed on the panorama picture. By dragging this frame to move it or change its shape, or by clicking on the panorama picture, the changes can be reflected in the setting values.

Also, when a view restriction is set for the VB-C10/VB-C10R, the view restriction frame is displayed on the panorama picture in blue or red. If the frame is red, this indicates that the entered preset values are outside the view restriction.

8 Preset Name

A name can be assigned to the presets.

9 The Preset Values Entry box and the Brightness Selection box

The current preset settings are displayed in the Preset Values Entry box. These values can be changed by entering new values.

● Preset Settings

“Pan” Sets the pan position for the camera.

“Tilt” Sets the tilt position for the camera.

“Zoom” Sets the value for the camera’s angle of zoom.

● Brightness

Sets the target value for the camera’s auto exposure feature. Select “Brighter” if the picture is darker due to backlight or other factor.

10 Get Value button

When the “Get Value” button is clicked, the current shooting angle of the VB-C10/VB-C10R is retrieved and reflected in the settings.

11 Admin Viewer button

This button can be used to start up Admin Viewer.

12 Preview button

Clicking this button allows checking of the set values specified in the Preset Values Entry box with the Preset Preview frame.

13 Status List

Displays the results of communication between this tool and the VB-C10/VB-C10R.



Note

Edited content will not be reflected in the viewer accessed to the VB-C10/VB-C10R at the stage when the “Send” button is used to send edited content to the VB-C10/VB-C10R. After confirming the edited content, be sure to use the “Reflect set values” button to reflect the settings in the VB-C10/VB-C10R.

Setting Presets

Presets can be set in one of two ways. Use the method that suits your environment or taste.

1: Retrieving values from Admin Viewer and changing settings

To Make Settings...

Start up Admin Viewer and set the shooting angle of the VB-C10/VB-C10R as a preset.

- From the Preset Selection box, select the preset to be set, and enter the Preset Name.

Click the “Admin Viewer” button to start it up.

Preset:
 For Picture Recording only
 Preset Name:



- Use Admin Viewer to move the camera angle to the position you want to set preset angle, then click the “Get Value” button.

Preset set can be checked in the Preset Values Entry box, or with the Preset Preview frame.

Camera: Model: Canon VB-C10
 Pan: (-100.00 to 100.00)
 Tilt: (-30.04 to 90.00)
 Zoom: (3.36 to 43.04)
 Brightness:

- Click the “Send” button.

Check the Status List to be sure the values were sent correctly. Then when the “Reflect set values” button is clicked, the values will be reflected in the VB-C10/VB-C10R.

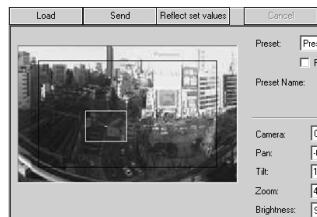

2: Changing Settings from the Preset Preview Frame

To Make Settings...

The Preset Preview frame on the panorama picture can be used to set presets.

- 1 From the Preset Selection box, select the preset to be set, and enter the Preset Name.

Set the presets by using the mouse to move or change the shape of the Preset Preview Frame displayed on the panorama picture. Also, when the mouse is clicked on the picture, the Preset Preview Frame moves so that this click point becomes the center point of the frame.

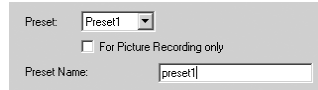

- 2 Click the "Send" button.

Check the Status List to be sure the values were sent correctly. Then when the "Reflect set values" button is clicked, the values will be reflected in the VB-C10/VB-C10R.



Tip

- If view restrictions are to be used, be sure that the Preset Preview Frame (yellow) does not protrude outside the View Restriction Frame (blue).
- Since previews using Panorama Preview may be slightly different from the actual picture, after the presets have been set, please check to be sure the viewer is correctly reflecting the presets in the actual picture.
- Once presets have been set, they cannot be deleted. If you do not want to these presets to be used, select "For Picture Recording only" so that the presets cannot be used in the Helper Viewer. In the Java Viewer, use of the presets can be disabled by changing the LiveApplet parameters and disabling the Preset Selection box display.
- For details on preset settings, see page 3-15.

Log Viewer

The VB-C10/VB-C10R includes a feature that writes operating status to a log file and saves it. Log Viewer simplifies the reading of log files and provides management and resolution of errors. Log Viewer not only displays all logs, it is also capable of filtering so that only the required information is displayed.

Viewing Logs

When Log Viewer is started up from the VBAdmin Startup Panel, it automatically retrieves the most recent log file and displays the recent logs.

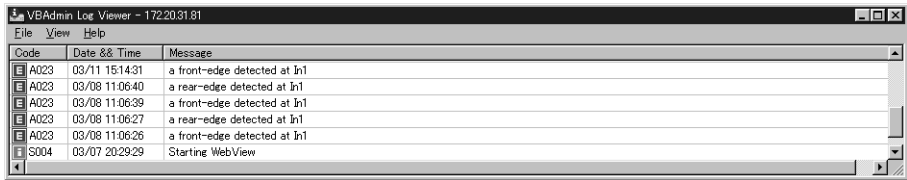

The following content is displayed in the log.

● Code

The log displays error codes. For error codes, refer to page 7-4 of the User's Manual. Error codes are displayed with one of four types of icons according to level.



"Information level"



"Error level"



"Warning level"



"Unknown"

● Date & Time

The date and time when the log was generated is displayed.

● Message

Log messages are displayed.

Using selection criteria to display logs

Logs can be filtered according to type, code, or date and time so that only the required information is displayed.

To Set Selection Criteria...

1. Choose "Filter" from the View menu.

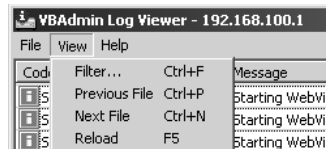

2. The Filter dialog box appears. Set the following selection criteria and click the “OK” button to display only the logs that match those criteria.

If filtering is not required, click the “Cancel” button.

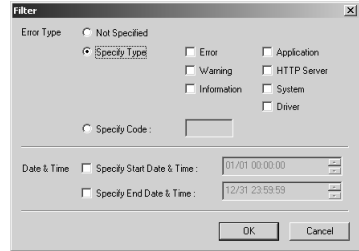

[Error Type]

If logs are to be filtered according to type of error, select the “Specify Type” or “Specify Code”; if not, select the “Not Specified”.

● Specify Type

Specifying the levels of the logs

From Error, Warning, and Information, select the error levels to be displayed.

Specifying the modules that output the logs

From Application, HTTP Sever, System, and Driver, select the output source modules to be displayed.

● Specify Code

Specify the error code of the logs. The error codes of the logs are compared to the characters that are entered and only logs with matching error codes will be displayed. For example, if “A0” is entered, logs whose error codes start with “A0” will be displayed.

[Date & Time]

● Specify Start Date & Time

Logs generated **after** the specified date and time can be displayed.

● Specify End Date & Time

Logs generated **before** the specified date and time can be displayed.



Tip

- There is no log message related to the HTTP server and the driver in the VB-C10/VB-C10R.
- “Application” and “System” correspond to the log messages list (→ P.7-4).
- Application: Log messages related to applications (→ P.7-4)
These log messages refer to applicaion such as WebView and picture recording.
- System: Log messages related to the system (→ P.7-4)

Admin Viewer

Admin Viewer is a viewer containing functions for managing the VB-C10/VB-C10R. Compared to the Helper and Java Viewers, Admin Viewer lets you perform operations such as retrieve exclusive camera control privileges, ignore view restrictions, and operate external devices.

Starting Up Admin Viewer

Click the “Admin Viewer” on the VBAdmin Startup Panel

Or double-click the “Admin Viewer” icon on the desktop.

When the Admin Livescope window appears, click the “File” then the “Connect”. The “Server Setting” dialog box appears. Enter the following items:

- Host Name (The IP address set on the VB-C10/VB-C10R, → P.3-4)
- User Name (root, → P.3-4)
- Password (→ P.3-9)

Then click the “OK” button. The video will then be displayed.

■ Special privileges of Admin Viewer

- Connections are also possible outside service times (→ P.3-20).
- Connection time is unlimited.
- Exclusive camera control privileges. Invalidates control privileges held by and requests obtained from other viewers.
- Ignore view restrictions.
- Operates external devices.



Control Button



Note

Since most operations and settings of Admin Viewer are common with the Helper Viewer, basic camera control and the like are omitted here. This chapter describes only the functions and operations that are unique to Admin Viewer.

The manual for the viewer software is provided on the supplied CD-ROM (Mon-E.pdf).

About the special privileges of administrators

Since Admin Viewer has more special privileges than the Helper and Java Viewers, please keep in mind the following points when using Admin Viewer:

- Since connection time is unlimited, please exit the Viewer after viewing.
- When a camera control privilege has been obtained, Admin Viewer forcibly continues to obtain this privilege. After viewing, be sure to exit the Viewer or click the “Control” button again to release these privileges.
- When making settings, keep in mind that images outside the view restrictions are displayed also in Java and Helper Viewers that are connected simultaneously with Admin Viewer.

Operating External Device

Setting Notification of Changes in External Device Input Status

A message box can be displayed in the event a change in the external device input status occurs due to a sensor connected to the VB-C10/VB-C10R or other factor.

To Make Settings...

1. Choose “Setup properties” from the View menu.

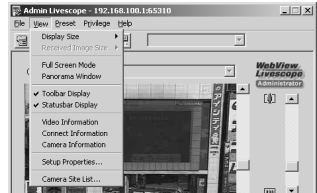

2. When the “Setup properties” dialog box appears, click the “Display option” tab.

Check to be sure the “Display notification message for external device input” check box is selected, then click the “OK” button.

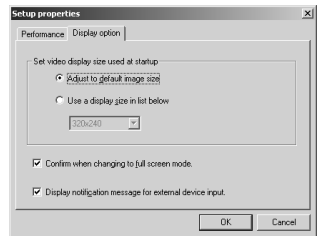

A message appears in the event a change occurs in the external device input status.



Note

If the Admin Viewer is minimized or in full screen mode, the notification message for external device input appears after the normal display is restored. Also, this message is not displayed when the “External Device Input” dialog box (→ P.4-26) is displayed.

Displaying and Saving the External Device Input Status

The external device input status can be displayed and, when required, saved as a log.

To Make Settings...

1. Choose “External Device Input” from the Privilege menu.

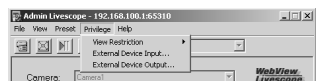

2. The “External Device Input” dialog box appears.

To save this content as a log, click the “Save” button, then specify a file name and where it should be saved.

To clear the content in the display, click the “Clear” button.

To close the dialog box, click the “Close” button.

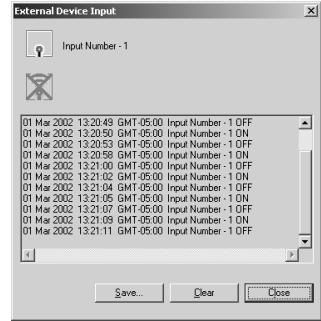

Operating External Device Output

The ON/OFF status of external device output to an external output device such as a light can be changed.

To Make Settings...

1. Click “Control” button to retrieve the camera control privileges, and choose “External Device Output” from the Privilege menu.

2. The “External Device Output” dialog box appears.

The external device output status can be changed using the ON/OFF buttons for each terminal.

To close the dialog box, click the “Close” button.

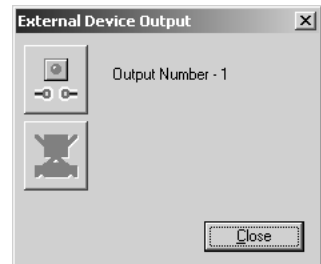
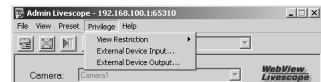

Enabling/Disabling View Restrictions

View restrictions can be enabled or disabled when controlling the camera.

To Make Settings...

Choose either “ON” or “OFF” for View Restriction in the Privilege menu.

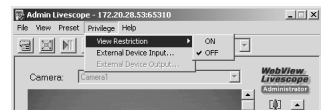

Chapter



Creating Web Pages

This chapter describes how to use the VB-C10/VB-C10R to webcast information.

Picture data can be distributed in various ways, including displaying video or still pictures and displaying multiple images on a Web page.

Web Pages for Video Distribution

To distribute picture data by VB-C10/VB-C10R, you create a dedicated Web page. The viewers that can be used with the VB-C10/VB-C10R are “Java Viewer (with or without camera control function)” and “Helper Viewer”, and detailed parameters can be specified for each of these. You need to determine which of these viewers is supported and create the Web page for the viewer.

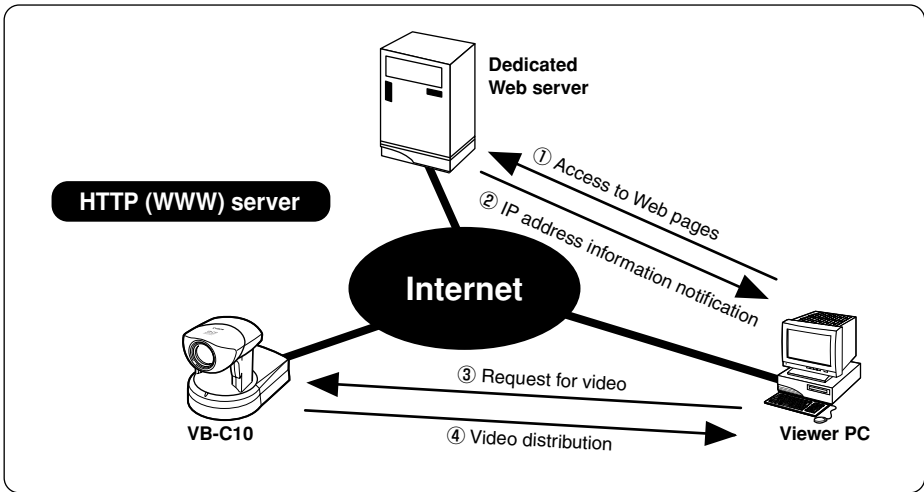

If you select a link requesting video in step ①, a file that includes the IP address information for the VB-C10/VB-C10R is sent from the Web server in step ②. If you are using the Java Viewer, the applet is downloaded to the viewer PC from the VB-C10/VB-C10R in response to the request in step ③ and the video is distributed.



Note

The VB-C10/VB-C10R includes a built-in Web server. If the content of Web pages used for distributing videos is stored onto the flash memory in the VB-C10/VB-C10R, the VB-C10/VB-C10R can be used alone for distributing Web pages and videos over the Web. Please refer to page 5-8 for procedures on how to save Web page data.



Tip

You can use the Language setting function for the Browser to create a multi-lingual Web site. For example, if you set the French-language top page as index-fr.html and the English-language top page as index.html and supply users with a URL address terminates in slash, such as `http://vb-c10/sample/`, the server will transmit a file that corresponds with the language setting for the Browser. For further information on the Language setting function for the Browser, refer to the Browser Help.

Features of the Java Viewers

These viewers are supplied as Java applets. They run on Web browsers that are Java-capable, such as the Netscape Navigator and Microsoft Internet Explorer browsers. The applets are downloaded from the camera server to the Web browser and are then run by the Web browser. The features of the Java Viewers are described below.

- **Video distribution and camera operation using the WebView-HTTP protocol.**
- **Penetrate firewalls to access external sites.**
- **Because they are automatically downloaded, the Java Viewers do not need to be pre-installed by the client.**
- **Java Viewers run on a wide variety of platforms.**



Because the Java applets are downloaded using the HTTP protocol when the viewer starts up, the start up time is longer than the Helper Viewer.

Java Viewer Types

Two Java Viewers are “LiveApplet”, which has video display and camera control functions, and “Glimpse”, which only has video display functions. Because both viewers use WebView-HTTP as the transfer protocol, they do not require special settings to penetrate firewalls.

■ Viewer Types

Viewer Name	Functions
LiveApplet	① Displays videos from the VB-C10/VB-C10R. ② Allows camera control. ③ Allows overlays and superimposition of bitmaps in the video frame. * Because video is not displayed until the viewer has finished downloading, video display takes longer than with the Helper Viewer.
Glimpse	Allows the video distribution interval to be set. * Downloading is faster than “LiveApplet” because it has only simple functions and size is small.

Java Viewer

LiveApplet

Video display function
Camera control function

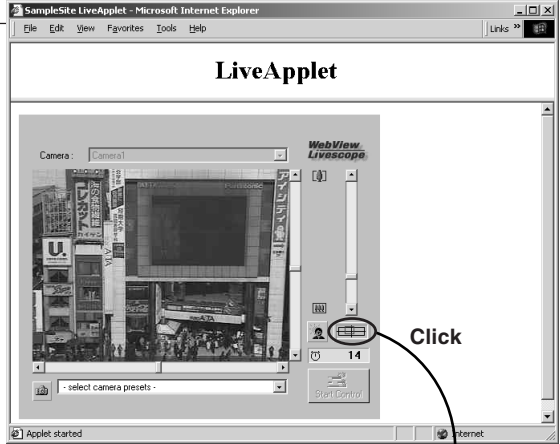

Panorama Picture

Java Viewer

Glimpse

Video display function



Features of the Helper Viewer

The Helper Viewer is an application which is launched from a Web browser. Unlike the Java Viewer, it must be pre-installed on the client's computer. The features of the Helper Viewer are described below.

- Must be pre-installed, but once installed, start-up time is quick and operation is stable.
- The Helper Viewer can use WebView-HTTP protocol and can penetrate firewalls to access external sites. However, this cannot pass through with the WebView-TCP protocol (→ P.5-22).
- Can be run as a stand-alone application.

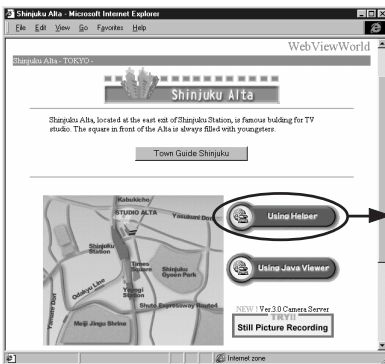

Panorama Picture

Viewing Sample Pages

Ready-made video distribution sample pages are provided with the VB-C10/VB-C10R. Follow the procedure below to view these pages. Refer to these pages when creating your own Web pages.

Viewing the Pages

1. Launch your Web browser and enter the following URL:

<http://192.168.100.1/sample/>

* The underlined portion is a sample IP address. Enter the actual IP address that was set on the VB-C10/VB-C10R.

2. The page shown below appears with links to the other sample pages. Click on the link to the sample page you want to view.



Examples of sample pages

JavaApplet sample 1

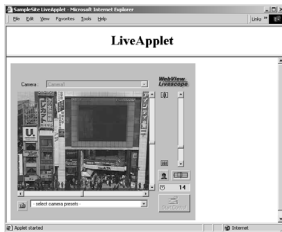

This is a LiveApplet sample page which distributes live videos and allows users to control the camera.

JavaApplet sample 2

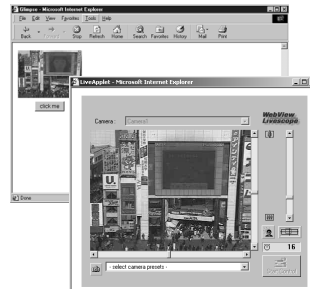

This is a sample page which combines LiveApplet and Glimpse.

Still picture request page using JavaScript

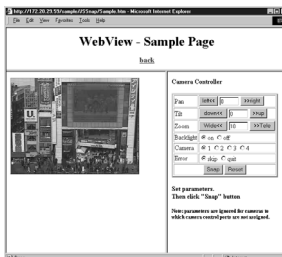

This is a sample page which displays a live still picture.

Using the Java Viewer to Distribute Videos

This section describes how to use the Java Viewers to provide videos. Application examples are also given.

Using the Java Viewer to Create a Web Page

When you use the Java Viewer, the viewer applet to be used must be incorporated into the Web page you provide. However, this is not especially difficult. The page can be created using the HTML normally used to include an applet.

LiveApplet

```
<applet codebase="http://192.168.100.1/-wvdoc-01-/LiveApplet/"
  code="LiveApplet.class" archive="LiveApplet.zip"
  width=450 height=380>
<param name=url value="http://192.168.100.1/">
<param name=cabbase value="LiveApplet.cab">
</applet>
```

Glimpse

```
<applet codebase="http://192.168.100.1/-wvdoc-01-/Glimpse/"
  code="Glimpse.class" archive="Glimpse.zip"
  width=160 height=120>
<param name=url value="http://192.168.100.1/">
<param name=cabbase value="Glimpse.cab">
</applet>
```

Enter the parameters required by the applet between the <applet> -</applet> tags. Use the <param> tag for parameters other than the common attributes for applets (codebase, code, archive, width and height).

* The underlined portion is a sample IP address. Enter the actual IP address set for the VB-C10/VB-C10R.

Saving Web Page Data

The VB-C10/VB-C10R is equipped with a Flash memory where Web page data can be saved. Data is saved by transferring the data files using FTP. The data is placed as a file under /usr/html/local.

Device	File system (accessed by an ftp client)	URL (accessed from a Web browser)
On-board flash memoly	ftp://IP address/usr/html/local	http://IP address/local/



Note

- To use a Web browser as an FTP client:
Insert "root:password@" before the IP address, as in "ftp://root:password@192.168.100.1/usr/html/local/". The VB-C10/VB-C10R does not support anonymous FTP.
- The output performance may be lowered when there is not enough free space on the on-board file system. Please be sure to place the minimum required amount of data on the on-board file system (→ P.3-22).

Example of Using the Java Viewer to Create a Web Page

This section describes an example in which the Java Viewer is used to create a Web page. Use this example to create your own original Web page.

Embed the Java Viewer, and Display a Text in a Separate Frame

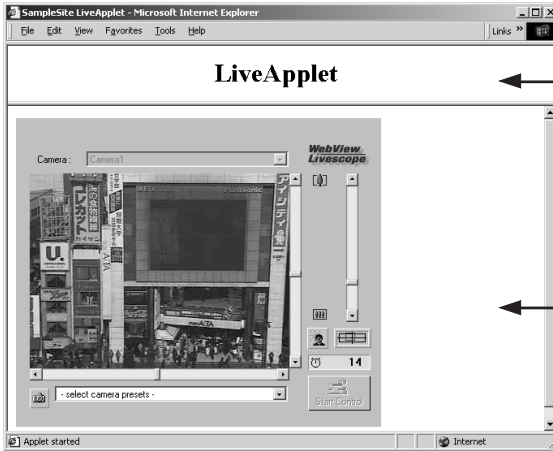

1 Frame settings

2 The text displayed in a separate frame

3 Frame with the embedded Java Viewer



Tip

Writing IP Addresses

Using the Web server functions built into the VB-C10/VB-C10R, IP addresses can be expressed as `<_I_P_A_D_D_R_>` (all upper-case characters, including the angle brackets) in the three file types (html, wvh and wvp) used by the Web server in the VB-C10/VB-C10R.

Since `<_I_P_A_D_D_R_>` is replaced with the actual address when the VB-C10/VB-C10R is accessed, the Web page does not need to be changed even when the VB-C10/VB-C10R's IP address is changed. NAT can also be supported by specifying a global address for the Web page (→ P.5-26).

1 sample.htm

```
<html>
<head>
<title>SampleSite LiveApplet</title>
</head>
<frameset rows="70,*">
<frame src="header.htm">
<frame src="lvappl.htm">
</frameset>
</html>
```

2 header.htm

```
<html>
<head>
<title>LiveApplet comment</title>
</head>
<body>
<center><h1>LiveApplet</h1></center>
</body>
</html>
```

3 lvappl.htm

```
<html>
<head>
<title>LiveApplet</title>
</head>
<body>
<applet codebase="http://192.168.100.1/-wvdoc-01-/LiveApplet/"
        code="LiveApplet.class" archive="LiveApplet.zip"
        width=450 height=380>
<param name=cabbase value="LiveApplet.cab">
<param name=url value="http://192.168.100.1/">
</applet>
</body>
</html>
```

* The underlined portion is a sample IP address. Enter the actual IP address set for the VB-C10/VB-C10R.

Using Glimpse and LiveApplet Together

This section describes how to create a Web page that allows clients to use Glimpse to download quickly and view live video at a low frame rate, and then use LiveApplet to view video at a high frame rate and control the camera when they find videos they are particularly interested in.

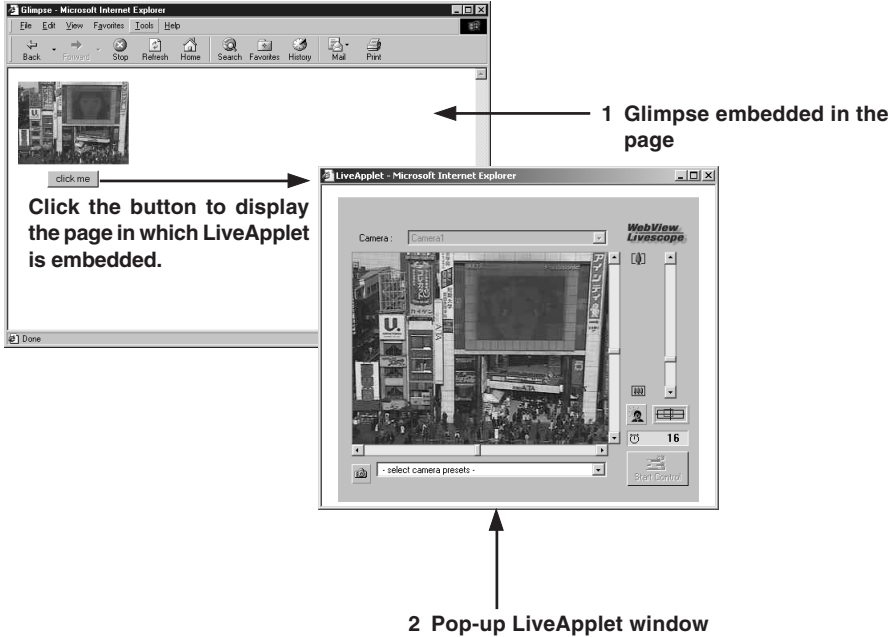

1 glimps.htm

```
<html>
<head>
<script language="JavaScript">
<!--
function clicked(btn) {
    url = btn.name
    window.open(url,"LiveApplet","width=490,height=400")
}
// -->
</script>
<title>Glimpse</title>
</head>
<body>
<table>
<form name="form">
<tr><td><center>
<applet codebase="http://192.168.100.1/-wvdoc-01-/Glimpse/"
    code="Glimpse.class" archive="Glimpse.zip"
    width=160 height=120>
<param name=cabbase value="Glimpse.cab">
<param name=url value="http://192.168.100.1/">
</applet>
</center></td></tr>
<tr><td><center>
<input type="Button" name="popup.htm" value="click me"
onClick="clicked(this)">
</center></td></tr>
</form>
</table>
</body>
</html>
```

2 popup.htm

```
<html>
<head>
<title>LiveApplet</title>
</head>
<body>
<center>
<applet codebase="http://192.168.100.1/-wvdoc-01-/LiveApplet/"
    code="LiveApplet.class" archive="LiveApplet.zip"
    width=450 height=380>
<param name=cabbase value="LiveApplet.cab">
<param name=url value="http://192.168.100.1/">
</applet>
</center>
</body>
</html>
```

* The underlined portion is a sample IP address. Enter the actual IP address set for the VB-C10/VB-C10R.

Providing “LiveApplet” without Camera Control

This section describes how to create a Web page that only displays live video and has no camera control GUI for situations where you want to prohibit camera control.



```
<applet ..... width=320 height=240>
```

```
<param name=controller_style value="none">..... ①
```

① specifies the camera control user interface.

“normal”: The usual style.

“preset_only”: Preset operation only is displayed.

“none”: Not displayed.

Modifying the Startup and Disconnection Screens

You can modify the image files (JPEG or GIF image files) shown in the startup and disconnection screens.

■ Nothing Specified

Startup screen

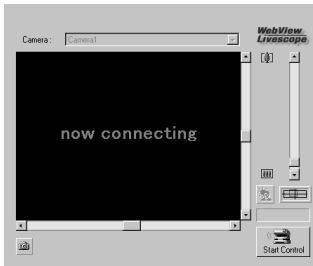

Disconnection screen



■ Certain Images Specified

Startup screen



Disconnection screen

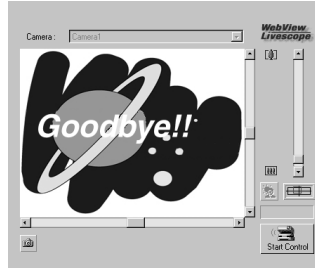

If no particular image is specified, the “connecting to hostname” (when the hostname parameter is specified) or “now connecting” animation is displayed at startup and the “disconnected hostname” (when the hostname parameter is specified) or “disconnected” is displayed at disconnection. You can modify the screens to show any image by providing images for the startup and disconnection screens and setting the parameters. The image size is automatically adjusted to the size specified in the video_width parameter. The display time for the specified screen at startup can also be specified.

```
<param name=open_image value="/local/images/opening.jpg"> ..... ①  
<param name=open_image_time value="3000"> ..... ②  
<param name=close_image value="/local/images/closing.jpg"> ..... ③
```

- ① specifies the file name for the startup image screen.
- ② specifies the display time for the startup image screen (in milliseconds).
- ③ specifies the file name for the disconnection image screen.



Note

You must use the absolute path name (name that begins with “/”) to specify the path for the image file displayed (→ P.5-8).



Tip

- At startup, the default character string that is displayed while a connection to the VB-C10/VB-C10R is being established is “now connecting”, but there is also a parameter called “connect_msg” for changing this character string. For additional parameters for changing display character strings, see page 5-17.
- If the user’s service time has been set (→ P.3-20), screen images are not displayed outside the specified time.

Displaying the Host Name, Frame Count and Other Information on the Video Screen

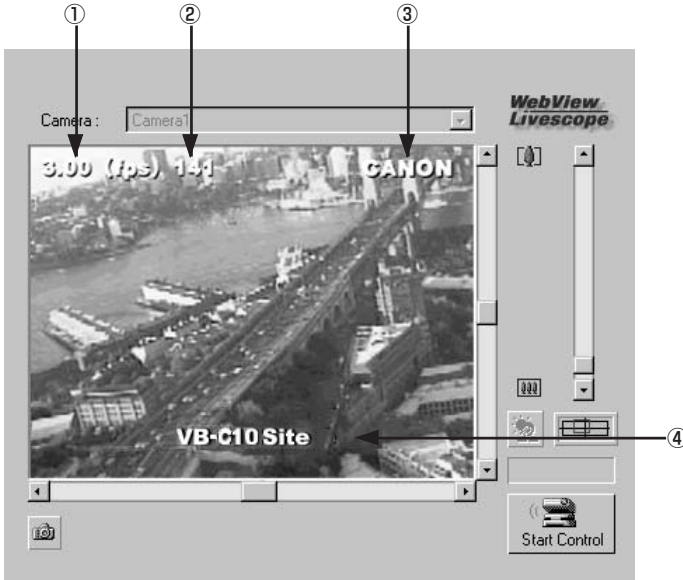

```

<param name=show_fps value="on"> _____ ①
<param name=show_counter value="on"> _____ ②
<param name=hostname value="CANON"> _____
<param name=show_hostname value="on"> _____ ③
<param name=comment value="VB-C10 site"> _____
<param name=show_comment value="on"> _____ ④

```

- ① specifies whether the frame rate is displayed on the screen.
 "on": Displayed.
 "off": Not displayed.
- ② specifies whether the frame count is displayed on the screen.
 "on": Displayed.
 "off": Not displayed.
- ③ specifies the host name (any text string) to be displayed on the screen and whether the host name is displayed.
 "on": Displayed.
 "off": Not displayed.
- ④ specifies a comment to be displayed on the screen and whether the comment is displayed.
 "on": Displayed.
 "off": Not displayed.

Displaying Bitmap Images on the Video Screen

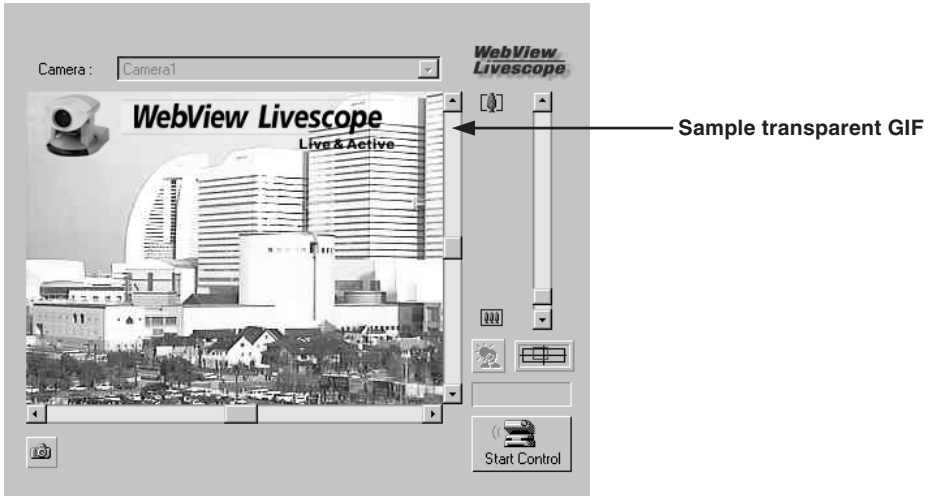

```
<param name=superimpose value="/local/logos/newlogo.gif,0,0">
```

* The underlined portion "x,y" specifies the display position. When x,y = 0,0, the image is displayed in the top left corner. If "x,y" is omitted, the image is displayed in the center of the frame.

Specifying the Background Color

```
<html>
<body bgcolor=#cccccc>
<applet codebase=http://...code="LiveApplet.class" width=450 height=380>
  <param name=url value="http://192.168.100.1">
    <param name=bg_color value="#cccccc">
</applet>
</body>
</html>
```

* The underlined portion is a sample IP address. Enter the actual IP address set for the VB-C10/VB-C10R.

Pasting a Picture to the Background

```
<param name=bg_image value="/local/images/back.gif"> ..... ①
<param name=image_offset value="0,0"> ..... ②
```

- ① specify the displayed picture file.
- ② specify to display it at x,y (underlined portion).

Java Viewer Parameters

You can specify applet parameters to provide an applet tailored to modify the behaviour or appearance of applets. Refer to the table below to ensure that you thoroughly understand the parameters.

■ LiveApplet

Parameter Name	Omissible	Description
bg_color	Yes	Use this parameter to set the background color. The parameter specification format is "#RRGGBB" (values between 0 and 255 for each component color expressed as a hexadecimal). Eg. White: "#FFFFFF", Grey: "#AAAAAA", Green: "#00FF00" If this parameter is omitted, the default background color is used.
close_image	Yes	You can use this parameter to specify the screen displayed in the video display window at the time of disconnection. Specify the name of a JPEG or GIF file. If this parameter is omitted, the default disconnection screen is displayed.
comment	Yes	This parameter specifies the comment text string displayed as an overlay on the applet. If this parameter is omitted, no comment is displayed.
gui-type	Yes	Specifies whether the panorama window should be pop-up displayed or embedded in the page. Specify "embed" for making it an embedded display. When specifying "embed", the Width and Height of the applet tags must be specified a little larger (Eg. width=500; height=660).
hostname	Yes	This parameter specifies the host name displayed in the applet. This value is used as the host name in messages displayed during connection, etc. If this parameter is omitted, no host name is displayed.
open_image	Yes	You can use this parameter to specify the screen that appears in the video display window until the first video image appears. Specify the name of a JPEG or GIF file. If this parameter is omitted, the default startup screen is displayed.
open_image_time	Yes	When a startup screen is specified in the "open_image" parameter, this parameter specifies the display time. The time is specified in milliseconds (1/1000 sec.), and the default value is 0. The image is displayed until the first video frame appears. Values from 0 to 30000 (30 seconds) can be specified.
show_capture	Yes	This function specifies whether the Snapshot button is displayed. Specify "on" or "off". The default value is "on". The button is always displayed unless "off" is explicitly specified.
show_comment	Yes	This function displays the comment as an overlay on the video image. Specify "on" or "off". The default value is "off".
show_counter	Yes	This function displays the frame count as an overlay on the video image. Specify "on" or "off". The default value is "off".
show_fps	Yes	This function displays the frame rate as an overlay on the video image. Specify "on" or "off". The default value is "off".
show_hostname	Yes	This function displays the host name as an overlay on the video image. Specify "on" or "off". The default value is "off". Note that this parameter is only valid if the "hostname" parameter is specified.
show_panobutton	Yes	Specify whether or not to display the panorama window pop-up button. The default value is "on".

Parameter Name	Omissible	Description
superimpose	Yes	This function displays a bitmap image as an overlay on the video image. Specify the image using the "bitmap-filename,x,y" format. Use the GIF format for bitmap images (transparent GIFs supported). The "x,y" parameters specify the coordinates of the bitmap image position on the video frame. If "x,y" is omitted, the image is displayed in the center of the video frame.
url	No	Specify the URL of the HTTP server for applet access. Specify the IP address and port number that match those specified in the codebase attribute.
video_width	Yes	This parameter specifies the video image display size (in pixels). Specify the width. The display sizes are 80 to 640, and any value can be set as the width. The height is calculated as 3/4 of the specified width. Eg. video_width="240" (height=240 × 3/4=180.)
auto_connect	Yes	Specifies whether or not connection to the camera server should be established at the same time that the applet starts up. Select "on" or "off". When "on" is selected, connection is established when the applet starts up and moving pictures are displayed. With "off", the connection is not established when the applet starts up and the character string that was specified with the "no_connect_msg" parameter is displayed. The "connect()" method is called up to establish connections.
bg_image	Yes	The picture displayed in the background of LiveApplet can be specified. A JPEG or GIF file can be specified. The WebView Livescope logo is not displayed if specified. If not specified, the default picture is used.
click_action	Yes	Specifies behavior when a moving picture display area is clicked. "pt" specifies pan and tilt; "none" specifies no reaction. The default is "pt".
connect_msg	Yes	Specifies the character string that is displayed while connection to the camera server is being established. The default is "now connecting".
controller_style	Yes	Specifies the GUI style for controlling the camera. "normal" specifies the usual GUI style; "preset_only" specifies preset operation only; "none" specifies that the entire GUI will not be displayed. With "preset_only", only the Control Start button, the Camera Control Status window, the Preset Selection bar, and the Snapshot button are displayed.
disconnect_msg	Yes	Specifies the character string that is displayed when the connection to the camera server is cut. The default is "disconnected".
error_msg	Yes	Specifies the character string that is displayed when connection to the camera server has failed. The default is "can't connect".
font_size	Yes	Specifies the display size for connect_msg, disconnect_msg, error_msg, no_connect_msg, and too_many_msg. The default makes size dependent on the display area.
image_offset	Yes	Specifies the display position of the picture file specified at bg_image. With the upper left coordinates of the picture at "0,0" and the right direction given as x and the down direction as y, image_offset is specified as "x,y". The default is "335,0".
no_connect_msg	Yes	Specifies the character string to be displayed following applet startup when auto_connect is "off". The default is "no connection".
overlay_font_color	Yes	Specifies the color of the character string specified for "comment" and "hostname". The color is specified at "#RRGGBB". The default is yellow.
show_logo	Yes	Specifies whether or not the WebView Livescope logo should appear in the upper right of the screen. It appears if show_logo is "on" and does not appear if it is "off".
too_many_msg	Yes	Specifies the character string that is displayed when connection to the camera server fails because the limit on the number of connections was exceeded. The default is "too many clients".

■ Glimpse

Parameter Name	Omissible	Description
comment	Yes	This parameter specifies the comment text string displayed as an overlay on the applet. If this parameter is omitted, no comment is displayed.
hostname	Yes	This parameter specifies the host name displayed in the applet (alphanumeric character only). This value is used as the host name in messages displayed during connection, etc. If this parameter is omitted, no host name is displayed.
show_counter	Yes	This function displays the frame count as an overlay on the video image. Specify "on" or "off". The default value is "off".
show_hostname	Yes	This function displays the host name as an overlay on the video image. Specify "on" or "off". The default value is "off". Note that this parameter is only valid if the "hostname" parameter is specified.
sleep	Yes	This parameter specifies the interval (in milliseconds) at which the screen is updated. If this parameter is omitted, the screen is updated at 5-second intervals. Because the Glimpse applet is designed to be used for displaying multiple sites as a list, this parameter is provided as a means of reducing the processing load. Intervals between 0 and 300,000 ms (5 minutes) can be set. If 0 is specified, the interval is not adjusted.
url	No	Specify the URL of the HTTP server for applet access. Specify the IP address and port number that match those specified in the codebase attribute.
auto_connect	Yes	Specifies whether or not connection to the camera server should be established simultaneously with applet startup. Specify either "on" or "off". When "on", a connection is established simultaneously with applet startup; when "off", no connection is established when the applet starts up and the character string specified for no_connect_msg is displayed. The connect() method is called up in order to make connections..
connect_msg	Yes	Specifies the character string to be displayed while a connection to the camera server is being established. The default is "now connecting".
disconnect_msg	Yes	Specifies the character string to be displayed when a connection to the camera server is disconnected. The default is "disconnected".
error_msg	Yes	Specifies the character string to be displayed when an attempt to connect to the camera server has failed. The default is "can't connect".
font_size	Yes	Specifies the font size for connect_msg, disconnect_msg, error_msg, and no_connect_msg when these messages are displayed. The default is to depend on the display area.
no_connect_msg	Yes	Specifies the character string to be displayed after the applet starts up, if "off" is specified for auto_connect. The default is "no connection".

Applet Tag Descriptions

Attribute Name	Omissible	Description
code	No	This parameter specifies the applet file name. Enter "LiveApplet.class" or "Glimpse.class". If this parameter is not specified correctly, the applet (LiveApplet or Glimpse) is not downloaded.
codebase	No	This parameter specifies the directory that contains the applet. http://HTTP server IP address: port number/directory/ If this parameter is not specified correctly, the applet (LiveApplet or Glimpse) is not downloaded. Directories are fixed for each applet. Directory (LiveApplet)=-wvdoc-01-/LiveApplet Directory (Glimpse)=-wvdoc-01-/Glimpse
width	No	This parameter specifies the size of the area acquired for the applet (in pixels). For LiveApplet, if the value specified is smaller than the LiveApplet drawing area, the applet may not be displayed correctly. If the camera control function GUI is to be added (controller_style=normal), add about 130 to the value. Eg. For an image size of 320 × 240, width=450. For Glimpse, because the areas used for the applet and for the video display are the same size, specify the same value as the image width. Eg. For an image size of 320 × 240, width=320.
height	No	As for width. For LiveApplet, add around 140. Eg. For an image size of 320 × 240, height=380. For Glimpse, specify the same value as the image height. Eg. For an image size of 320 × 240, height=240.
archive	Yes	Specify LiveApplet.zip or Glimpse.



Tip

When specifying an address included in the codebase attribute of the applet tag and a URL parameter of the applet, specify one that can be accessed from the client's computer. This is particular necessary when using NAT.

Using the Helper Viewer to Distribute Videos

This section describes how to use the Helper Viewer to provide videos. Application examples are also given.

If a client is using the Helper Viewer to receive videos, the video sender must set up the Web server and create the necessary wvh files.



Tip

- The settings below are not required if the VB-C10/VB-C10R's built-in Web server is used.
- See page 5-8 for saving Web page data.

Setting Up the Web Server

Set up the Web server to be used for providing Web pages. Add the MIME type to the Web server software and specify the extension. Refer to the manual for your Web server software for details.

MIME type	video/x-webview-h
Extension	wvh

For Apache

In the settings for added the MIME type in Apache, edit the "mime.types" file in the "conf" directory.

- **Use the following syntax to add the required MIME type to the computer:**

```
type/subtype extention
```

- **The settings for WebView Livescope are as follows:**

```
video/x-webview-h wvh (Helper settings)
```



Note

If the MIME setting is not specified correctly for the Web server, you may not be able to launch the Helper Viewer. Be sure to specify the setting correctly.

Creating wvh Files

This section describes how to create the wvh file required for launching the Helper Viewer application.

1. **Use a text editor or similar program to create a new text file and type the following type of code in the file:**

```
(Example) 192.168.100.1 65310
          192.168.100.1 65311
          wvhttp:192.168.100.1 80
```

- The first line gives the IP address (or host name) of the VB-C10/VB-C10R and the TCP port number used for the video transmission. The default setting is 65310 (→ P.3-20). The default setting will be used if no particular value is specified.
- The second line gives the IP address (or host name) of the VB-C10/VB-C10R and the TCP port number used for the camera control. The default setting is 65311 (→ P.3-20). The default setting will be used if no particular value is specified.
- The third line gives the setting for the Helper Viewer to use HTTP protocol. After “wvhttp:”, type in the IP address of the VB-C10/VB-C10R and “80” as the HTTP port number. As a result of this, you will be able to view video from the VB-C10/VB-C10R through firewalls.

***Type in the actual IP address (or host name) set for the VB-C10/VB-C10R.**

2. **After you save the text file and quit the text editor program, create a wvh file by changing the file name and extension. Be sure to add the “.wvh” extension, as in “WebView.wvh”.**



Tip

Helper Viewer supports WebView Livescope protocol and HTTP protocol.

- **WebView Livescope protocol:**

Cannot be viewed through firewalls. This protocol is primarily for clients who are connected directly to the Internet.

- **HTTP protocol:**

In general, this protocol is used with Web browsers. By using this protocol, clients inside firewalls can view video by penetrating fire walls. The Java Viewer also uses this protocol.

Example of a Web page Using the Helper Viewer

This section describes an sample Web page in which the Helper Viewer is used.

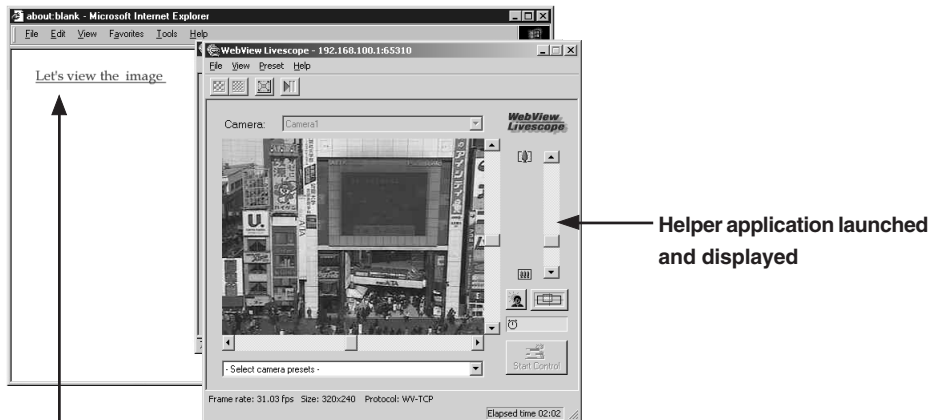

- 1 Click the link to launch the Helper application

Include the tags that link to the wvh file in the text or images in the Web page.

- 1 `Let's view the image`



Tip

To use the sample page template in the VB-C10/VB-C10R to supply videos, specify ``.

Distributing Videos Using a Browser Only

You can also use the WebView-HTTP protocol to provide videos from the VB-C10/VB-C10R directly to a Web browser. Some example of this are described in this section.

Displaying the Live Video at Access as a Still Picture



When a client accesses the Web page that provides videos, the video shot at that point can be supplied as a still picture.

```
<IMG SRC=http://192.168.100.1/wvhttp-01-/GetStillImage>  
(or)  
<IMG SRC=http://192.168.100.1/wvhttp-01-/GetOneShot>
```

* The underlined portion is a sample IP address. Enter the actual IP address set for the VB-C10/VB-C10R.

Displaying a Specified Number Of Live Video Frames As a Video at Access

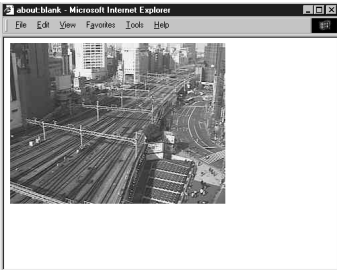

The Server Push format provided as an extended function by Netscape Communications Corp. can be used to distribute multiple-frame images. However, these images can only be displayed on Netscape Navigator. In the coding example below, 100 frames of live video are distributed when the client accesses the server.

```
<IMG SRC=http://192.168.100.1/wvhttp-01-/GetOneShot?frame_count=100>
```

* The underlined portion is a sample IP address. Enter the actual IP address set for the VB-C10/VB-C10R.



Tip

Setting `frame_count=no_limit`, removes the limits on the number of image frames.

Displaying Live Video from a Specified Angle as Still Pictures

By specifying the camera angle as a parameter in the HTML code beforehand, you can display the picture from a specified camera angle. The example below displays a still picture shot with the camera panned right by 40° and tilted down 10°.

```
<IMG SRC=http://192.168.100.1/-wvhttp-01-/GetStillImage?p=40&t=-10>
```

* The underlined portion is a sample IP address. Enter the actual IP address set for the VB-C10/VB-C10R.

■ GetStillImage Parameters

Parameter	Description
p/pan	Specifies the camera pan angle. "p" is a 1° unit, and "pan" is a 0.01° unit. For example if the camera pans right 20°, then p is 20 and pan is 2000. If this parameter is omitted, the camera pan angle is not controlled.
t/tilt	Specifies the camera tilt angle. "t" is a 1° unit, and "tilt" is a 0.01° unit. If this parameter is omitted, the camera tilt angle is not controlled.
z/zoom	Specifies camera zoom. "z" is ten times the zoom ratio of the widest angle, and "zoom" is the view angle in 0.01° units (horizontal direction). If this parameter is omitted, camera zoom is not controlled.
b/back_light	Specifies camera backlight compensation. When this parameter is set to on, the picture captured will be bright and when this parameter is set to off, the picture captured will be dark. If this parameter is omitted, camera backlight compensation is not controlled.
delay	Waiting time until camera focus is stabilized (in milliseconds). Specified in the range 0 to 10000.
option	Specifies how errors are dealt with. When "skip_on_error" is specified, the process will be continued. When "quit_on_error" is specified, the process will be aborted. The following errors can occur: failure to acquire camera control right, loss of camera control, camera selection errors and camera control errors. To omit, the default value is "quit_on_error".
seq	Allows any number (sequence number) to be specified to avoid displaying old still pictures (numeric value).
v/image_size	Specifies picture display size. This can be set to 640 × 480, 320 × 240, or 160 × 120. The formats for specifying "v" and "image_size" are different: "v" specifies the horizontal dimension only and uses the format "v=640", for instance, while "image_size" specifies both horizontal and vertical dimensions and uses the format "image_size=320 × 240", for instance.
q/quality	Specifies the picture quality of the pictures. Use an integer between 1 and 99 to specify. If omitted, the value set in the VB-C10/VB-C10R is used.



Note

If old still pictures are displayed, you can prevent this recurring by specifying a sequence number in the seq parameter.

Example of Video Distribution Using One Fixed Global Address

One fixed global address is required if the VB-C10/VB-C10R is being used to distribute live videos on the Internet. An Internet service provider (ISP) that offers a single-address fixed global address service can be used (Note: a router with NAT function is required).

Example: In this example, we use the global address 192.168.1.10 assigned by the ISP. We also set the private address 192.168.100.2 in the VB-C10/VB-C10R (and 192.168.100.1 for the router).

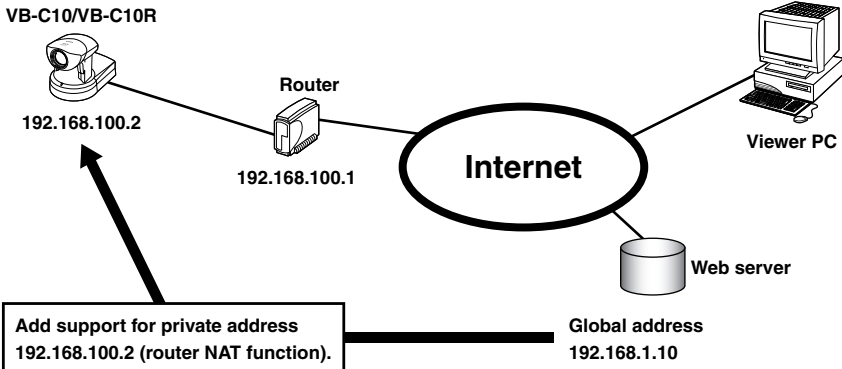

A sample page of the VB-C10/VB-C10R is automatically generated based on the IP address that was actually assigned (192.168.100.2 in this case). In this case, this page cannot be viewed in the Java Viewer or the Helper Viewer when "http://192.168.100.2/sample/" is accessed through the Internet.

Set "Global Address for Web Pages" (→ P.3-21) to 192.168.1.10. If you are not using the VB-C10/VB-C10R's Web server, describe the Web pages for distributing videos as follows:

Set the Java Viewer description (→ P.5-7) as follows:

```
<applet codebase="http:// 192.168.1.10/-wvdoc-01-/LiveApplet/"
  code="LiveApplet.class" archive="LiveApplet.zip"
  width=450 height=380>
<param name=url value="http:// 192.168.1.10/">
<param name=cabase value="LiveApplet.cab">
</applet>
```

Set the wvh file description of the Helper Viewer (→ P.5-22) as follows:

```
192.168.1.10 65310
192.168.1.10 65311
wvhttp:192.168.1.10 80
```

* The underlined portion is a sample IP address. Enter the actual IP address set for the VB-C10/VB-C10R.



Contact respective manufacturers for details on setting the router.

Chapter



Using the Picture Recording Function

This chapter describes a couple of specific examples of the Picture Recording function using the VB-C10/VB-C10R. This function can be used to automatically record still pictures according to a preset schedule or in response to inputs from an external device.

Using the Still Picture Recording Function Linked to an External Device

By combining various sensors and switches to operate according to External Device Input settings, it is possible to build a monitoring system that responds to external events. Still pictures are recorded in the VB-C10/VB-C10R's memory (→ P.3-16).

Sample Application Combining a Door-opening Sensor

This is a monitoring system in which the VB-C10R installed in the ceiling records pictures every second for 3 seconds before the doors opens and 7 seconds after the door opens between 5 p.m. and 6 a.m. The equipment shown in the figure below is connected to the terminals on the rear of the VB-C10R at installation.

Installation Example

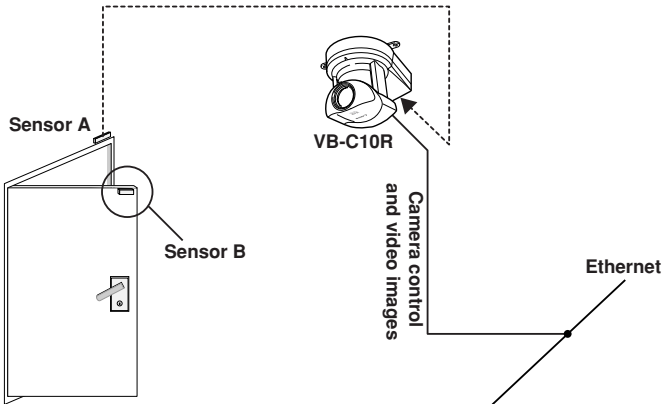

When the door opens and sensor B mounted on it separates from sensor A, an ON event occurs at external device inputs IN⁺ and IN⁻. In response to this event, the VB-C10R records pictures at the entrance and stores them.

VB-C10R Connection Example

Connector	Attached Cable
IN ⁺ , IN ⁻	Sensors mounted on the door

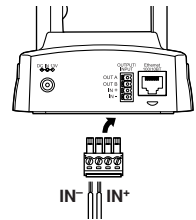

Remove some insulation at the end of the cables from the sensor and insert them into the IN⁺ and IN⁻ terminals on the plug for the external device. Then tighten the screws on the plug to secure the cables.

Insert this plug with the cable into the external device I/O jack on the rear of the VB-C10R.



Please confirm the Date and Time settings on page 3-10.

Sample Still Picture Recording Settings

Settings specified on the “Camera Settings” page (→ P.3-11)

Specify the appropriate settings for the VB-C10R being used.

Settings specified on the “Preset Settings” page (→ P.3-15)

Set a camera angle that shoots the open doorway as Preset 1.

Recording conditions to be set (→ P. 3-16)

- Select “Record pictures in response to external inputs”.
- Select “Record still pictures for validated external input events during the Start-Stop times specified below.”
- Set start time to 17:00:00 and end time to 06:00:00.
- Select all days of the week.
- Select “ON event (OPEN to CLOSE)”.
- At “Pre-event Recording”, set still pictures to be recorded every 1 second, and set “Record still picture(s) for every specified interval” to 3. With these settings, pictures will be recorded and stored every second starting 3 seconds before door opens.
 - * With “Pre-event Recording”, no picture is recorded the instant the input goes ON.
- At “Post-event recording”, set still pictures to be recorded every 1 second, and set “Record still picture(s) for every specified interval” to 8. With these settings, pictures will be recorded and stored every second for 7 seconds starting from the instant the door opens.
 - * With “Post-event Recording”, pictures are recorded from the instant the input goes ON.
- Set position of camera to be used for recording to Preset 1.

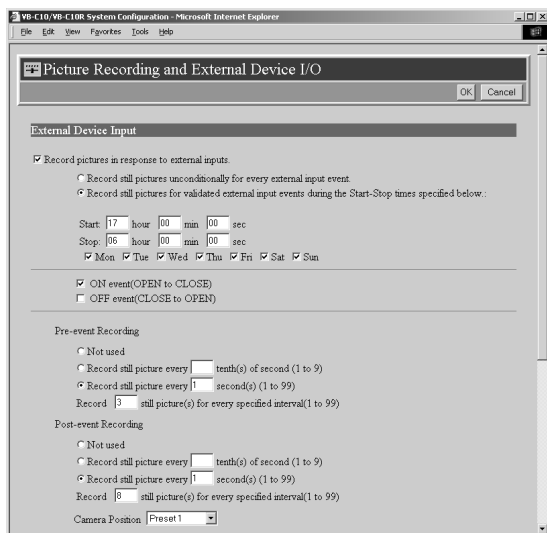

* Events occurring during the Post-event Recording are ignored.

Using the Still Picture Recording Function with a Predetermined Schedule

By using the “Schedule” setting, you can construct a monitoring system that records pictures according to a predetermined schedule. Recorded still pictures are stored in the VB-C10/VB-C10R’s memory (→ P.3-17).

Sample Application Using Sequential Mode

This is a monitoring system of the type used in art galleries and similar facilities in which the exhibits are monitored. Still pictures are captured at 10-minute intervals by a VB-C10R mounted on the ceiling.

Installation Example

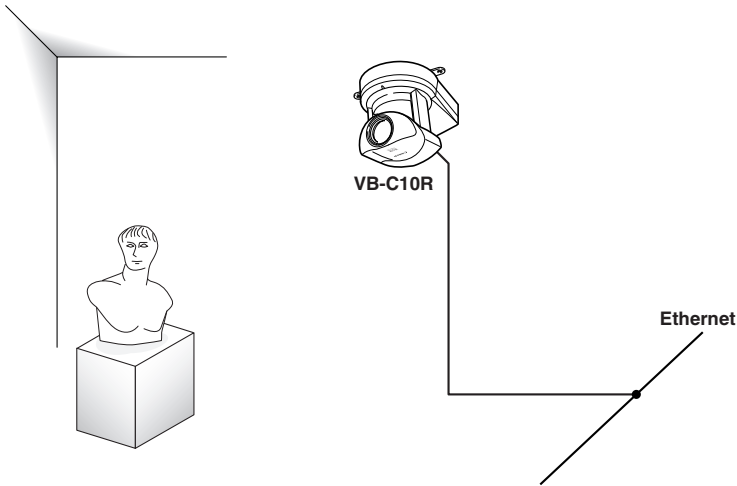

Following the schedule set in advance, the VB-C10R records and stores pictures.

Sample Still Picture Recording Settings

Settings specified on the “Camera Settings” page (→ P.3-11)

Specify the appropriate settings for the VB-C10R being used.

Settings specified on the “Preset Settings” page (→ P.3-15)

Set the camera angle focusing on the object to Preset 1.

Recording conditions to be set (→ P.3-17)

- Select “Record pictures according to a schedule”.
- Set still pictures to be recorded every 10 minutes.
- Set the camera position for recording to preset 1.
- Set “Camera Stabilization Time” to 5 seconds so that the camera can start recording pictures after it has stabilized at its recording position.

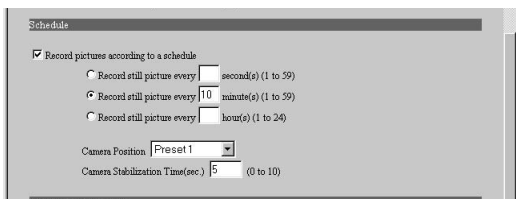

Note

- The number of still pictures that can be recorded depends on size of the pictures. Check the average file size per still picture in advance (→ P.3-17 and 3-22).
- Still pictures beyond VB-C10/VB-C10R’s capacity can be recorded if VBCollector is used to automatically download still pictures recorded by the VB-C10/VB-C10R (→ P.6-6).

Viewing Recorded Pictures

VBCollector is used to view pictures recorded by the VB-C10/VB-C10R. With VBCollector, you can collect and display still pictures recorded by the VB-C10/VB-C10R based on inputs from an external device or schedules. VBCollector accesses the VB-C10/VB-C10R at specific times expressed in units such as dates, weeks, or months, and then downloads the recorded pictures. Since the recorded pictures are saved one after another in the PC on which VBCollector is installed, pictures can still be securely saved when the allowable limit on the number of pictures that the VB-C10/VB-C10R can record and save has been exceeded. Downloaded images can also be easily viewed in the Web browser.

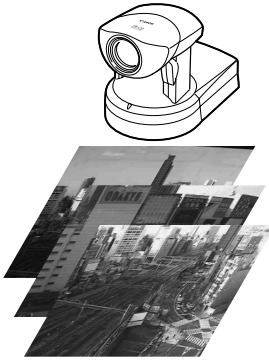

Pictures recorded with the VB-C10/
VB-C10R's picture recording function

Pictures periodically collected
according to the task

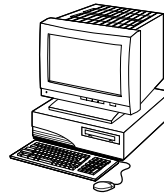

Task Name	Server Name	Next Run Time	Last Result	Schedule
Sched-1	VB-C10	2002/02/14 19:02	Succeeded:2002/02/13 19:04	Start Time:2002/02/14 19:02
Sched-2	VB-C10			Start Time:2002/02/13 21:46
Sched-3	VB-C10	2002/02/13 21:46	Succeeded:2002/02/13 19:04	Start Time:2002/02/13 21:46
Sched-4	VB-C10	2002/02/14 12:28	Succeeded:2002/02/13 19:05	Start Time:2002/02/14 12:28
Sched-5	VB-C10	2002/02/14 06:14	Succeeded:2002/02/13 19:05	Start Time:2002/02/14 06:14
Sched-6	VB-C10	2002/02/14 03:09	Succeeded:2002/02/13 19:05	Start Time:2002/02/14 03:09
Sched-7	VB-C10	2002/02/14 04:06		Start Time:2002/02/14 04:06

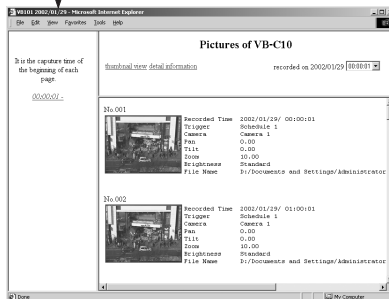
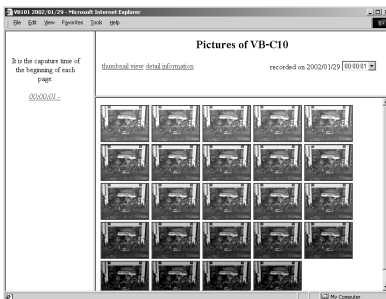

Downloaded image displays

Installing VBCollector

Install VBCollector using the CD-ROM supplied with the VB-C10/VB-C10R.



Note

VBCollector requires that Microsoft Internet Explorer 5 or later be installed.

1. Turn on the power to the PC.

If power to the PC is already on and Windows is running, exit all other applications before installing VBCollector. Please also be sure to close the Windows Service Panel.

2. Insert the CD-ROM supplied with the VB-C10/VB-C10R into the PC's CD-ROM drive, and follow the procedure below.

- ① Double-click My Computer on the desktop.

When using Windows XP, click on the Start button, then click My Computer.

- ② When the CD-ROM icon appears, double-click this icon, then double-click "CltSetup.exe".



CltSetup.exe

3. Perform the installation following instructions on the screen.

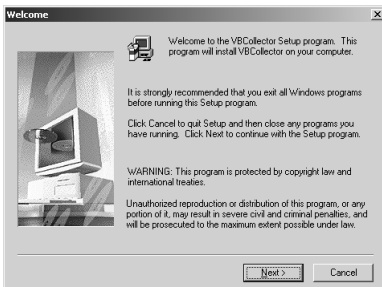

4. Complete installation.

When installation is complete, "VBCollector Task View" is added to the Start menu.

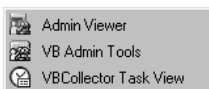

Starting Up VBCollector

VBCollector is started up by choosing it from Start menu.

To Start Up VBCollector...

Choose [Program]-[WebView Livescope]-[VBCollector Task View] from the Start menu to start up VBCollector.

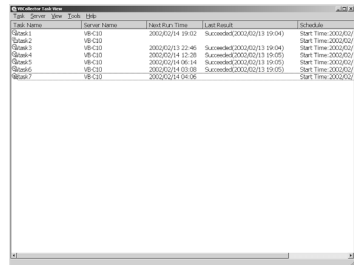
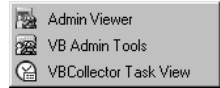

Registering a Server

To use VBCollector for downloading pictures from the VB-C10/VB-C10R (hereafter referred to as “server”), the server must first be registered.

Adding a Server

Add a new server to which VBCollector will download pictures.

To Add a New Server...

- To add a server, choose “Add” from the Server menu, or click the “Add” button on the Server List dialog box that appeared when Edit from the Server menu was selected.

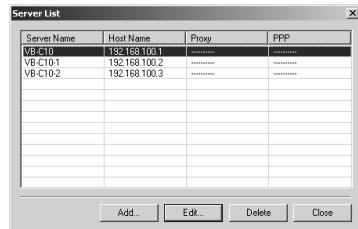

2. Enter the various fields and click the “OK” button.

● Server Name

Assign a name for recognizing the Server.

● Image Directory

Enter the name of the directory where downloaded images are to be saved, or click the “Browse” button to select a directory folder. A network path cannot be specified.

“Delete images on the server”

When this check box is selected, pictures that VBCollector downloaded from the server will also be deleted from the server.

● Server Information

“Host Name” (→ P.3-9)

Specify an IP address or a host name.

“HTTP Port” (→ P.3-21)

Enter the HTTP port number set in the server. (The default setting is 80.)

“Administrator Account” (→ P.3-9)

Enter “root”.

“Administrator Password” (→ P.3-9)

Enter the administrator password registered in the server.

● Proxy

“Use Proxy Server”

Select this if the connection is to be made via a proxy server.

“Host Name”

Specify the proxy server host name or IP address.

“Port”

Enter the proxy server port number. (The default is 8080.)

* PPP Dialup Connection cannot be used with the VB-C10/VB-C10R.



Note

If the picture recording function of the VB-C10/VB-C10R is to be used, this function is conveniently used when “Delete images on the server” is selected.

Editing Server Information

Content of the registered server information can be edited.

To Edit Server Information...

1. Choose “Edit” from the Server menu, and when the Server List dialog box appears, select the server name to be edited and click the “Edit” button.

To delete a registered server, click the “Delete” button.

2. As with the procedure for adding servers, change all desired items and click the “OK” button.

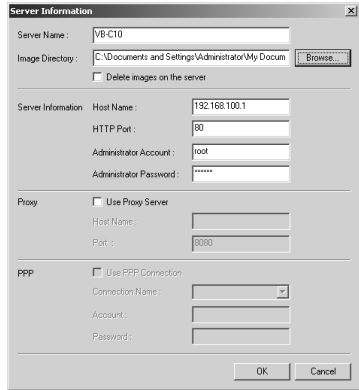
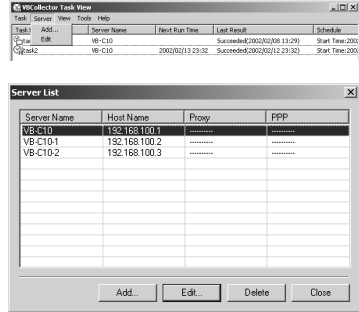

Note

Downloaded images are not deleted when a server is deleted. To delete downloaded images, first follow the procedure in “Deleting Images” (→ P.6-15) and then delete the server.

Registering Tasks

Adding a Task

Add a new task for downloading images.

To Add a New Task...

1. To add a task, choose “New Task” from the Task menu.



2. Enter the various items and click the “OK” button.

● Task Name

Assign the task a name.

“Enable this setting”

Select “Enable this setting” if the task is to be performed according to the schedule. If not selected, the added task will not be executed.

● Sever Name

Select the server from which you want VBCollector to download recorded pictures. The server will need to have been registered in advance.

● Schedule

“Start Date”

Set the date which is to be the starting point of the schedule. The task will be executed after the specified start date according to the criteria specified below.

“Start Time”

Set the time when the task is to start up (in 24-hour format).

“Once”

Select if the task is to be executed only once. The task will be executed only once at the start time on the start date.

“Daily”

Select if the task is to be executed once every certain number of days. This number of days can be specified between 1 and 31.

“Weekly”

Select if the task is to be executed every certain number of weeks on a certain day of the week. Set the number of weeks between 1 and 53, and specify the day of the week.

“Monthly”

Select if the task is to be executed every month on a certain day of the month. Set this day between 1 and 31. Or a day of the week for a certain week of the month can also be specified.

● Details

“Repeat task”

Select if task is to be executed in repetition in time units. Downloads occur in repetition only for the specified number of times at specified intervals starting from the start time specified in the schedule. If not selected, download occurs once at the start time specified in the schedule. If Repeat task has been set, the first download, which occurs at the start time, is not counted in the number of repetitions. The number of downloads to occur every certain number of hours can both be specified. Set the number of hours to a value between 1 and 23, and the number of downloads to a value between 1 and 23.

“Retry when an error occurs”

Select this item if a task is to be executed again in the event a download does not end normally after a task is executed. The task will be executed again a specified number of times at specified time intervals. During this time, if the download is completed normally, further tasks will not be repeated. Specify the number of times and the time interval at which a task is to be re-executed. For the number of times, enter a value between 1 and 10; for the interval, enter a value between 1 and 10.



Note

Up to 16 tasks can be executed by VBCollector simultaneously. Please be sure not to load a schedule with 17 or more tasks to be executed.

VBCollector is also not able to execute multiple tasks simultaneously to the same server. Please take care to ensure that multiple tasks are not executed to the same server by taking such measures as leaving a sufficient time space between the “Start Time” of each task.

Editing Tasks

The details of a registered task can be edited.

To Edit a Task...

1. In the Task View, select the task to be edited by clicking on its name, then choose “Edit Task” from the Task menu.

Or, double-click on the task to be edited.

To delete a registered task, choose “Delete Task” from the Task menu.

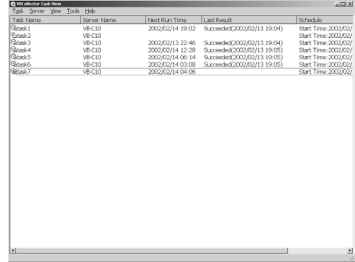

2. As with procedure to add a new task, change all desired items and click the “OK” button.

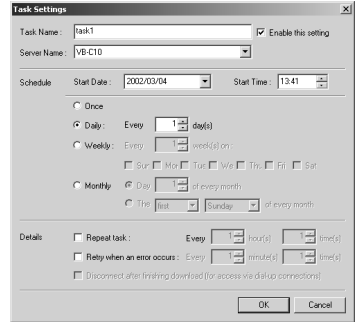

Executing and Canceling Tasks

Executing a Task

Registered tasks are executed automatically according to pre-determined schedule when “Enable this setting” is selected at Task Settings. If you want a task to be executed immediately, select the desired task on the Task View and choose “Execute now” from the Task menu.

Canceling a Task

To disable a registered task, clear “Enable this setting” at Task Settings. To abort the execution of a task, in the Task View, click on the task to be aborted, and choose Abort in the Task menu.



Details Displayed on the Task View

The execution status can be checked on the Task View.

Task Name	Server Name	Next Run Time	Last Result	Schedule
Task1	VR-C10	2002/02/14 19:02	Succeeded(2002/02/13 19:05)	Start Time: 2002/02/14 19:02
Task2	VR-C10	2002/02/13 19:46	Succeeded(2002/02/13 19:06)	Start Time: 2002/02/13 19:46
Task3	VR-C10	2002/02/14 12:38	Succeeded(2002/02/13 19:05)	Start Time: 2002/02/14 12:38
Task4	VR-C10	2002/02/14 01:08	Succeeded(2002/02/13 19:05)	Start Time: 2002/02/14 01:08
Task5	VR-C10	2002/02/14 01:08	Succeeded(2002/02/13 19:05)	Start Time: 2002/02/14 01:08
Task6	VR-C10	2002/02/14 01:08	Succeeded(2002/02/13 19:05)	Start Time: 2002/02/14 01:08
Task7	VR-C10	2002/02/14 01:08	Succeeded(2002/02/13 19:05)	Start Time: 2002/02/14 01:08

● Task Name

The names that were specified at Task Settings are displayed here. The status of each task is displayed as an icon at the left of the name.



Running

This task is currently being executed.



Waiting

This task is currently standing by to be executed at the next scheduled execution time.



Disabled

“Enable this setting” for this task is not selected at Task Settings and is currently not being executed.



Not scheduled

This task is not currently scheduled for execution.



Settings damaged

Inconsistencies have occurred in this task’s settings and the task will not be executed.

● Server Name

The server names that were specified at Task Settings are displayed here.

● Next Run Time

The date and time when the task is to be executed next is displayed here.

● Last Result

The last results achieved by the task and the task end time are displayed here.

● Schedule

The start date, start time, and execution interval for each task are displayed here.

Refresh Task View Display Content

To refresh the Task View content to reflect the most recent information, choose “Refresh” from the View menu.

Task Name	Refresh	PS	Name	Next Run Time	Last Result	Schedule
Task1			VR-C10	2002/02/14 19:02	Succeeded(2002/02/13 19:05)	Start Time: 2002/02/14 19:02
Task2			VR-C10	2002/02/13 19:46	Succeeded(2002/02/13 19:06)	Start Time: 2002/02/13 19:46

Starting/Stopping the Service

The task scheduler service can be started and stopped.

To Make Settings...

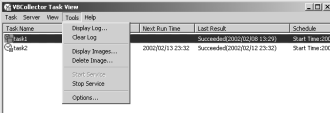

Choose Start Service or Stop Service from the Tools menu. If the service has started, Stop Service is enabled in the menu; if the service is stopped, Start Service is enabled.

When the Confirmation dialog box appears, click OK.

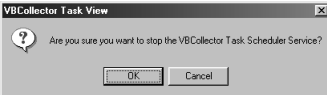

Viewing Recorded Images

The images that were downloaded according to the task schedule are saved in the folder specified at Server Information. VBCollector includes a function that outputs images, to a Web browser to simplify viewing.

Displaying Images

Downloaded images are selected by server name and date, and displayed in a Web browser.

To View Pictures...

1. Choose Display Images from the Tools menu.

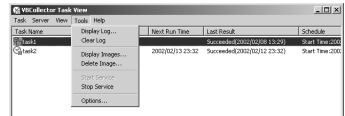

2. The Image List dialog box appears. Select the server name to be viewed, select the date of the list to be displayed, and click the “Display Image” button.

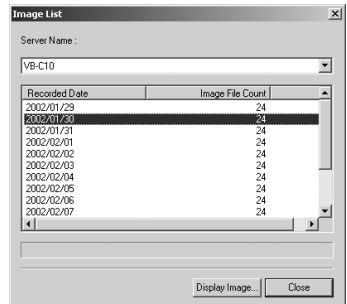

3. When the confirmation dialog box appears, click the “OK” button.

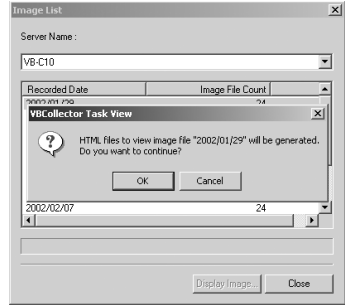

4. HTML for displaying the images is generated, the Web browser starts up, and thumbnail images of the selected date are displayed in 100-image units on the page.

Click on the image to be viewed; it is displayed in the original saved dimensions.

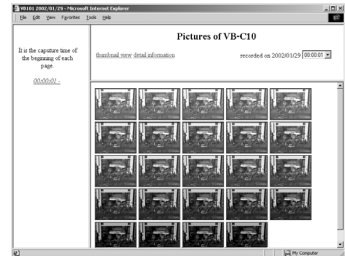

5. When Detail Display above the frame is clicked, detailed information on the images in the thumbnail screen is displayed.

Click on the image to be viewed; it is displayed in the original saved dimensions.

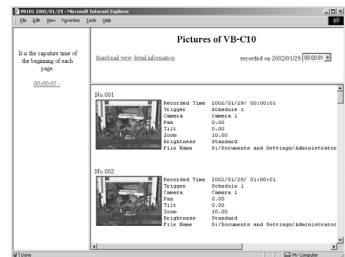

Deleting Images

Downloaded images can be deleted.

To Delete Images...

Choose Delete Image from the Tools menu.

In the Image List dialog box, select the name of the server that VBCollector downloaded the image to be deleted, select the date to be deleted by clicking on it, then click the “Delete Image” button.

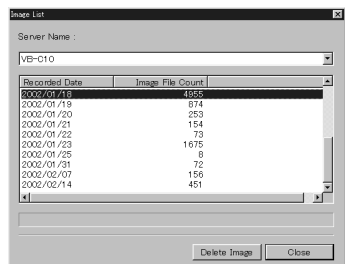

Viewing Logs



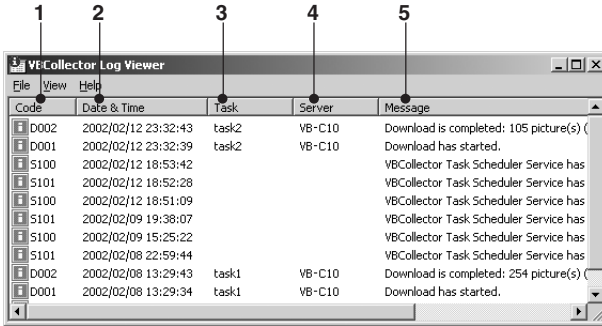

VBCollector outputs logs concerning the execution of tasks. To view a log, choose “Display Log” from the Tools menu.



The following information about logs is displayed:

1 Code

Identification codes are displayed here. Four types of icons representing the level are also displayed with these codes.

-  Information level
-  Warning level
-  Error level
-  Unknown

2 Date & Time

The date and time when the log was generated is displayed here.

3 Task

The name of the task that output the log is displayed here.

4 Server

The name of the server to which the task performs downloads is displayed here.

5 Message

The log's message is displayed here.

Displaying Logs According to Selection Criteria

Logs can be filtered according to type, code, or date and time so that only the required information is displayed.

To Make Settings...

1. Choose Filter from the View menu.

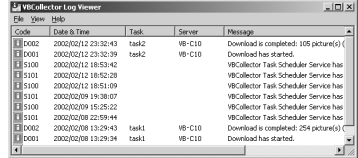

Code	Date & Time	Task	Server	Message
D002	2002/02/12 23:32:43	task2	VB-C10	Download is completed: 105 picture(s)
I001	2002/02/12 23:32:39	task2	VB-C10	Download has started.
I100	2002/02/12 18:53:42			VBCollector Task Scheduler Service has
I101	2002/02/12 18:52:28			VBCollector Task Scheduler Service has
I100	2002/02/12 18:51:09			VBCollector Task Scheduler Service has
I101	2002/02/09 15:28:07			VBCollector Task Scheduler Service has
I100	2002/02/09 15:25:22			VBCollector Task Scheduler Service has
I101	2002/02/08 22:09:44			VBCollector Task Scheduler Service has
D002	2002/02/08 13:29:43	task1	VB-C10	Download is completed: 254 picture(s)
D001	2002/02/08 13:29:34	task1	VB-C10	Download has started.

2. The Filter dialog box appears.

To display only the logs that match the specified criteria, enter the criteria below and click the “OK” button. If no changes are required, click the “Cancel” button.

● Specify Task

Select if filtering by task name, then enter the task name.

● Specify Server

Select if filtering by server name, then enter the server name.

● Error Type

Specify the error type when filtering by error type.

“Not Specified”

Selecting this item disables priority and code settings.

“Specify Priority”

From Error, Warning, or Information, select the error level to be displayed.

“Specify Code”

Select if only logs with the corresponding identification code are to be displayed, then enter the identification code.

● Date & Time

Filters logs by output date and time.

“Specify Start Date & Time”

When this item is selected and a date and time is entered, logs generated **after** the specified start date and time are displayed.

“Specify End Date & Time”

When this item is selected and a date and time is entered, logs generated **before** the specified end date and time are displayed.

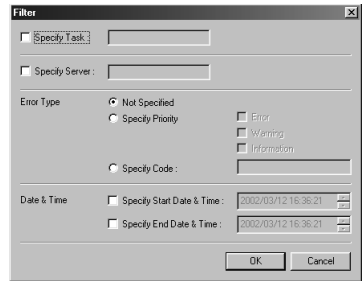

The Filter dialog box contains the following options:

- Specify Task: []
- Specify Server: []
- Error Type:
 - Not Specified
 - Specify Priority:
 - Error
 - Warning
 - Information
 - Specify Code: []
- Date & Time:
 - Specify Start Date & Time: [2002/03/12 16:36:21]
 - Specify End Date & Time: [2002/03/12 16:36:21]
- Buttons: OK, Cancel

Setting Download Capacity

In order to perform downloads based on a task schedule, you can set the upper limit on the number of pictures or specify the response to be made in the event the specified percentage of available space on the drive where pictures are to be saved is exceeded.

To Make Settings...

1. Choose “Options” from the Tools menu.



2. The “Options” dialog box appears.

- (1) Min. amount of free space required on image directory

Set the minimum available space required on the target drive to a value in % between 1 and 50. Images will be stored on the drive until this minimum space limit is reached.

- (2) What to do when min. is reached

Set the response to be taken when the minimum available space set above is reached. Select either “Abort task” or “Delete old image(s)”.

- (3) Set max. number of pictures per downloaded

When this is selected, the maximum number of pictures that can be transferred to the PC in a single download session can be specified within a range from 1 to 10000.

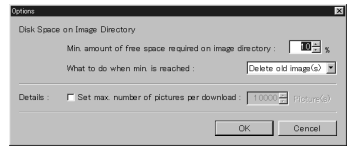

3. Click the “OK” button.

Chapter

A large, bold, black number '7' is centered on the page. It has a white outline and a grey shadow underneath, giving it a 3D effect. The shadow is a soft, grey oval shape positioned directly below the number.

7

Troubleshooting

This chapter explains how to deal with problems that arise with the operation of the VB-C10/VB-C10R and other faults.

Troubleshooting

Before you contact your Canon dealer or service outlet, check the items listed below. If a log message is displayed, refer to the log message list for the log details and the appropriate response.

The VB-C10/VB-C10R does not start up. The Camera LED does not light.

- Check that the AC cable is connected correctly.
- Switch the VB-C10/VB-C10R off and then on again (→ P.2-4).
- If the Camera LED (→ P.1-9, 1-10) is not illuminated in green, there is a system error. Press the Reset switch (→ P.8-5). If this does not resolve the problem, contact your Canon dealer.

VBIPI.exe does not work.

- Check that the LAN cable used for setup is connected correctly.
- Try turning off the power to the VB-C10/VB-C10R, then turning it on again (→ P.2-4). There will no longer be any effect on VBIPI.exe 20 minutes or more after power is turned on.
- Check to see if the VB-C10/VB-C10R and the PC running VBIPI.exe are connected to the same network segment.

The VB-C10/VB-C10R sample page does not appear.

- Check that the LAN cable is connected correctly.
- Check that the VB-C10/VB-C10R network settings are correct. In particular, check that the IP address, subnet mask and default gateway address settings are valid for the network you are using.
- If you have changed the IP address, the new IP address does not take effect until you reboot the VB-C10/VB-C10R.
- If access control for the VB-C10/VB-C10R is being used, check the settings (→ P.3-19).
- Check that the IP address or URL settings in the viewer software are correct.
- When using the router's NAT function, be sure the VB-C10/VB-C10R's IP address in the Web page is correct (→ P.5-26).

The video does not appear.

- Check that the viewer software is correctly installed (→ P.1-4). Please refer also to the viewer software User's Manual (Mon-E.pdf) contained on the supplied CD-ROM.
- If the video quality is poor, check the quality settings on the VB-C10/VB-C10R (→ P.3-11). Also, check settings such as the number of background colors as on the viewer PC.
- You can limit the number of viewers that can access the VB-C10/VB-C10R at the same time. The message without a video is displayed when this limit is exceeded (→ P.3-20).
- If you cannot see the video using the Java Viewer, check your system environment such as the browser version (→ P.1-6). Up-to-date information is provided on the VB-C10/VB-C10R Website.
(URL: <http://www.canon.com/webview/>)

I can't control the camera.

- Check that the LAN cable for camera control is connected correctly.
- Check to see if the camera angle is restricted to a preset (→ P.3-15).

I forgot the password.

- All factory defaults settings can be restored by pressing the Reset switch (→ P.8-5). The default administration password is "VB-C10". The VB-C10/VB-C10R's settings will need to be made again, however, since all network settings such as the IP addresses and subnet masks are also returned to the factory defaults.

I cannot record pictures.

- The number of pictures that can be recorded depends on the setting. From time to time, please delete recorded pictures that are not needed (→ P.3-22).
- Check that the camera is on and the cable has been connected properly.



If you have a problem, consult the ReadMe also. The ReadMe file may contain important information not included in this manual. Be sure to read this file.

Log Messages

The Syslog log messages are classified into the following 3 categories. Classification details are dealt with in the UNIX syslog.

Classification	Level	Fault Severity
err	Error	Fault involving a malfunction (operation interrupted)
warning	Warning	Fault not involving malfunction
info	Information	Information on correct operation

System-related Log Message

● S004 Starting up the system (info)

Message	Starting WebView
Explanation	Starting up WebView Livescope.

Application-related Log Messages

● A007 View restriction setting error (warning)

Message	inconsistent view restriction for camera [1]
Explanation	The view restrictions settings are corrupted. The camera control functions cannot be used.
Response	Restore the factory default settings or reset the permitted field of view restrictions.

● A008 Compatibility error in the view restrictions settings (warning)

Message	unacceptable view restriction for camera [1]
Explanation	Even in the telephoto field of view, the view restriction settings cannot be satisfied in the horizontal or vertical direction. When this occurs, the zoom setting is fixed at the telephoto field of view, and camera head control is prohibited in directions that do not satisfy the permitted field of view restrictions.
Response	Set appropriate values for the permitted field of view restrictions.

● A011 Camera control error (warning)

Message	VB-C10 (VB-C10R) [1] malfunction (%1)
%1	Error (read/writeltimeout...)
Explanation	Camera control I/O error.
Response	If this occurs frequently, this is a malfunction. Contact an authorized Canon service representative.

● A022 Applet archive load failure (warning)

Message	archive/%1 not found
%1	Applet archive name (glimpse.cabl glimpse.zip lvapplet.cabl lvapplet.zip imagemap.gif)
Explanation	The applet archive file does not exist or is corrupted.
Response	Copy the missing (or damaged) file in the "/archive" directory from the CD-ROM and reboot. The original applet archive file is in the CD-ROM.

● A023 Status change of external input devices (err)

Message	a %1 detected at %2
%1	external device input change (front-edge rear-edge)
%2	external device terminal (In1)
Explanation	A change was detected at external device terminal In1. "front edge" denotes OFF → ON and "rear-edge" denotes ON → OFF.

Chapter



Appendix

Specifications

VB-C10/VB-C10R		
Software	Operating System	Linux
	Protocols	TCP/IP, HTTP, BOOTP, FTP and WebView (from Canon)
	Video compression method	Motion-JPEG (video quality settings variable from 1 to 5) JPEG (for still pictures)
	Video transmission rate	0.1 to 30 fps (variable)
	Output image sizes	160 × 120, 320 × 240, 640 × 480 (pixel)
	Display image sizes	80 × 60, 160 × 120, 320 × 240, 640 × 480 (pixel)
	Server	HTTP, FTP and WebView Livescope
	Log management	Syslog format
	Camera control	Pan, tilt, zoom, brightness, shutter speed, focus mode, view restriction, control time limit
	Connection limitation	Access control (password), maximum view time, service period, number of concurrent connections (max. 20)
Interface	Network	Ethernet (1) (RJ45, 10/100 auto-negotiation)
	Display LEDs	Power and Network status display
	External I/O	1 input, 1 output
Main unit specifications	Dimensions	VB - C 10: 106.0 × 143.1 × 111.0 mm (4 ³ / ₁₆ × 5 ⁵ / ₈ × 4 ³ / ₈ in.) (W × D × H) VB-C10R: 136.0 × 143.1 × 111.9 mm (5 ¹¹ / ₃₂ × 5 ⁵ / ₈ × 4 ¹³ / ₃₂ in.) (W × D × H) (excluding attachments, VB-C10R includes mounting plate)
	Weight	VB - C 10: 645 g VB-C10R: 730 g
	Operating environment	Temp.: 0-40°C; Humidity: 20-85% RH (condensation free)
	Power supply	AC adapter, power consumption 25 W or less

AC Adapter	
Model	PA-V16
Input	100-240 V AC, 50/60 Hz
Output	13 V DC, 1.8 A (max.)
Polarity	Exterior (-), interior (+)
Size	58 × 118 × 25 mm (2 ⁵ / ₁₆ × 4 ²¹ / ₃₂ × 1 in.) (W × D × H) (excluding attachments)
Weight	Approx. 205 g

●These specifications are subject to change without notice due to product improvements, etc.

External Device I/O Terminals

External Device Input Terminals (IN⁺, IN⁻)

The external device input terminals consist of a + terminal and a '-' terminal. The '-' terminal is grounded on the inside of the main unit. By connecting two cables to the + and '-' terminals and then electrically short-circuiting across the terminals (ON) or separating the connection (OFF), an interrupt can be generated for the internal controller. See "Picture Recording and External Device I/O Settings Page" in Chapter 3 "Setup Procedures" (→ P.3-16) for information on the settings. Connect any sensors and switches to terminals with electrically separate GND terminals and power supplies.

External Device Output Terminals (OUT A, OUT B)

The external device output terminals consist two terminals (OUT A and OUT B). There is no distinction between + and '-' with OUT A and OUT B. The Internal controller switches the two output terminals to disconnected or connected condition. The output terminals use optocouplers and are separate from the internal circuit in the VB-C10/VB-C10R.

* External input status can be checked and external output status can be controlled using Admin Viewer (→ P.4-25).

Loads connected to the output terminals should be within the following ratings:

Rating across the output terminals: Up to 50 V DC

Continuous load current: 100 mA

Internal Connection Chart

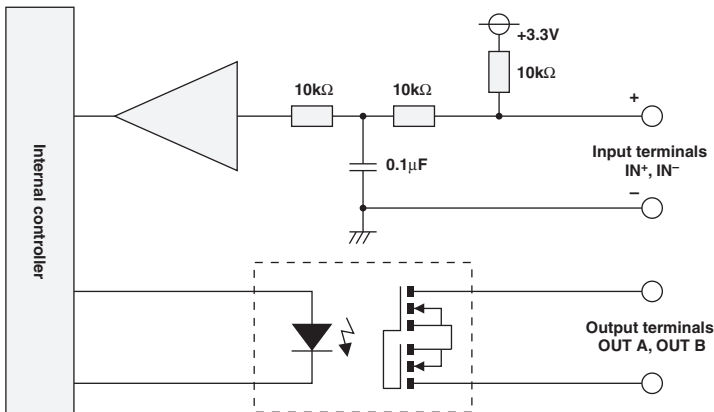

Restoring the Factory Default Settings

Since the VB-C10/VB-C10R supports a wide variety of functions, we recommend that you make a note of the settings for each function (→ P.8-6). If you want to redo the settings from the beginning because you have forgotten them or for some other reason, first restore the factory default settings.

* Please refer to page 8-6 for more about the factory default settings.

Restoring the Factory Default Settings from the Administration Tools Page via a Web Browser

1. Launch the Web browser and display the settings title page.

The VB-C10/VB-C10R's IP address, user name, and administration password are required when displaying the settings title page (→ P.3-7).

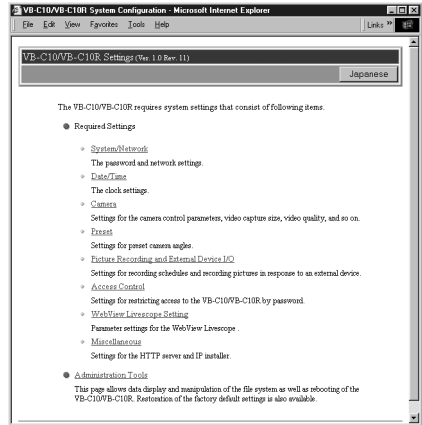

2. On the settings title page, click “Administration Tools”.

The Administration Tools page appears.

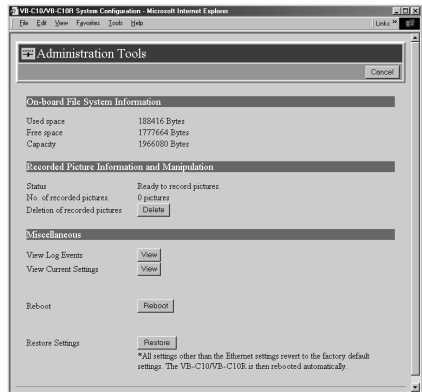

3. Click the “Restore” button for “Restore Settings”.

When the “Restore” button is clicked, the confirmation message below appears. To proceed with restoring the default settings, click the “OK” button.

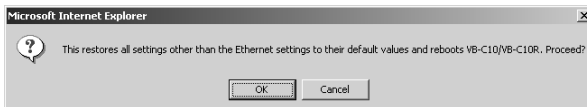



If you click the “OK” button at this point, it will not possible to abort the process to restore the default settings. Click the “Cancel” button if you do not wish to restore the default settings.

4. The VB-C10/VB-C10R’s factory default settings are restored.

Settings other than network-related settings such as the VB-C10/VB-C10R’s IP address, subnet mask, and default gateway address are returned to factory default settings.

If the IP Address and Password are Unknown

If the VB-C10/VB-C10R’s IP address or administration password are not known or have been forgotten, the VB-C10/VB-C10R cannot be operated over a network. In this case, press the Reset switch at the bottom of the unit.

1. Hold the Reset switch while you turn the VB-C10/VB-C10R’s power switch off and then on again.

The Reset switch is located toward the rear on the bottom. Use a thin tipped object such as the end of a paper clip to press the Reset switch.

See page 2-4 “Turning the Power ON and OFF” for procedures on how to turn OFF and ON the VB-C10/VB-C10R’s power switch.

2. Hold the Reset switch for more than 5 seconds even after the power switch is turned ON.

All settings in the VB-C10/VB-C10R will be returned to the factory default settings.

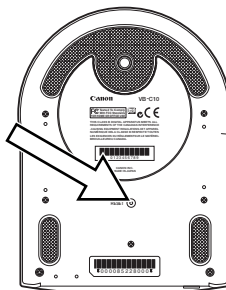

If the Reset switch is pressed and all factory default settings are restored, the VB-C10/VB-C10R’s network-related settings such as IP address, submask, and default gateway address are all also returned to the factory default settings, making it impossible to operate the VB-C10/VB-C10R from a PC connected to it. Use “VBIPI.exe” on the supplied CD-ROM to set an IP address appropriate to the environment you will be using (→ P.3-3).

Factory Default Setting

Item	Setting	Item Setting 1 ((y) (m) (d))	Item setting 2 ((y) (m) (d))
● Administrator ID	root	—	—
● Administrator password	VB-C10		
● Settings page path	admin	—	—
● Date and time Offset from GMT	+9 (Japan time)		
● Ethernet address IP address Subnet mask	192.168.100.1 255.255.0.0		
● Default Gateway address	192.168.100.254		
● Camera control Wide-angle converter	Not Used		
● Video Capture Size	320 × 240		
● Video Quality	3		
● Return to Home position Pan Tilt Zoom Brightness Shutter speed Focus mode View Restriction Upper/Lower value Left/Right value Telephoto/Wide-angel	No 0 0 0 Standard Auto Auto No None None None		
● Preset	None		
● Picture recording	No		
● Access Control	None		
● User list	None		

Item	Setting	Item Setting 1 ((y) (m) (d))	Item setting 2 ((y) (m) (d))
● WebView Livescope			
Video Transmission Port	65310		
Camera Control Port	65311		
Max Clients	20		
Control Queue Length	20		
Max Frame rate (fps)	30.0		
Max View Time (sec)	0		
Max Camera Control Time (sec)	20		
Camera Stabilization Time (ms)	1500		
Service time restriction	None		
● Miscellaneous Settings			
HTTP Port	80		
Global Address for Web Pages	Blank		
Connection Keeping	No		
Target IP address	Blank		
Interval	1		
IP Installer	ON		

Index

Symbols

100/10 BT Ethernet connector 1-9, 1-10

A

About the Panorama Creation Tool
 display screen 4-8
About view restriction 3-14
AC adapter 1-8, 3-2, 3-3
AC cable 1-8
Access control settings page 3-19
Admin Viewer 4-3, 4-15, 4-20, 4-24
Administration password 8-5
Administration Tools settings page 3-22
Applet tag descriptions 5-20
Authorized user account 3-19

B

Base 1-9, 1-10
Brightness 3-12

C

Camera control port 3-20
Camera head 1-9, 1-10, 2-4, 3-13
Camera LED 1-9, 1-10, 2-4
Camera name 3-11
Camera position 3-17
Camera settings page 3-11
Camera stabilization time 3-20
Capturing panorama pictures 4-9
CD-ROM 1-8, 3-3, 4-4, 6-7
Checking operation 3-6
CltSetup.exe 6-7
Connection keeping 3-21
Control queue length 3-20

D

Date and time 3-10
Default gateway address 3-9, 8-5
Details displayed on the Task View 6-13
Displaying a specified number of live
 video frames as a video at access 5-24
Displaying connection information 4-11
Displaying live video from
 a specified angle as still pictures 5-25
Displaying the live video at access
 as a still pictures 5-24
Distributing videos using
 a browser only 5-24

E

Editing server information 6-10
Enabling/disabling view restrictions 4-26
Ethernet 3-9, 6-2
Example of a web page using
 the Helper Viewer 5-23
Example of using the Java Viewer
 to create a web page 5-9
Example of video distribution using
 one fixed global address 5-26
Executing and canceling tasks 6-12
External device I/O jack 6-2
External device I/O terminals 1-9, 1-10
External device input 3-16
External device input terminals
 (IN+, IN-) 8-3
External device names 3-17
External device output terminals
 (OUT A, OUT B) 8-3

F

Factory default setting 8-6
Features of the Helper Viewer 5-5
Features of the VB-C10/VB-C10R 1-2
Focus mode 3-12
FTP client 5-8

G

GetStillImage parameters 5-25
Glimpse 5-3, 5-11, 5-19

H

Hardware and software requirements 1-6
Helper Viewer 1-6, 3-17, 4-24
Home position 3-12
HTTP port 4-5
HTTP server 3-21
Hub 3-2

I

Important safety instructions ix
Initial setup 3-3
Initialization 2-4
Installing the VB-C10/VB-C10R 2-2
Installing the VB-C10R on the ceiling 2-2
Installing VBCollector 6-7
IP address 2-5, 3-3, 3-4, 3-6, 3-7, 3-9,
3-10, 3-21, 4-5
IP installer 3-21

J

Java Viewer 1-6
Java Viewer parameters 5-17

L

LAN cable 3-2
LiveApplet 5-3, 5-11, 5-17
Log messages 7-4
Log Viewer 4-3, 4-22

M

MAC address 1-11
Maintenance xii
Maximum camera control time 3-20
Maximum frame rate 3-20
Maximum number of clients 3-20
Maximum view time 3-20
Miscellaneous settings page 3-21
Modifying the startup
and disconnection screens 5-13

N

Network LED 1-9, 1-10

O

On-board file system information 3-22
Opening/saving pictures 4-11
Operating external device 4-25
Optional products 1-5
Overview of VB Administration Tools 4-2

P

P2P 3-2
Pan 3-12
Panorama Creation Tool 4-2, 4-7
Password 3-4, 3-5, 3-7
Picture recording and external device
I/O settings page 3-16
Plug for external device 1-8
Post-event recording 3-16
Power connection socket 1-9, 1-10
Pre-event recording 3-16
Preset Setting Tool 4-3, 4-17
Preset Setting Tool display screen 4-18
Preset settings page 3-15
Proxy 4-5

R

Range of camera head movement 3-13
Reconnecting 4-11
Registering a server 6-8
Registering tasks 6-10
Reset switch 1-11, 3-9, 8-5
Restart 3-8
Restoring the factory default settings 8-4
from the administration tools page
via a web browser 8-4
Restrict service time 3-20
Root account 3-9
Router 1-4, 2-5

S

- Safe use of equipment vii
- Sample configuration
 - in an ISP environment 2-5
- Sample LAN environment configuration ... 2-5
- Sample network configurations 2-5
- Sample page 3-6
- Saving web page data 5-8
- Schedule 3-17
- Screw hole for tripod mounting 1-11
- Serial No. 1-11
- Setting downloads 6-18
- Setting presets 4-20
- Setting up the web server 5-21
- Setting view restrictions 4-15
- Settings title page 3-7, 3-8
- Shutter speed 3-12
- Special privileges of administrators 4-24
- Specifications 8-2
- Starting up VB Administration Tools 4-5
- Starting up VBCollector 6-8
- Subnet mask 3-9, 8-5
- Synchronize with NTP server 3-10
- System components and their operation ... 1-9
- System configuration 1-4
- System/network settings page 3-9

T

- Telephoto, wide-angle 3-12
- Tilt 3-12
- Time zone 3-10
- Troubleshooting 7-2

U

- Updating/deleting panorama pictures 4-10
- User name 3-4, 3-5, 3-7
- Using a tripod 2-2
- Using the Helper Viewer
 - to distribute videos 5-21
- Using the Java Viewer
 - to create a web page 5-7
- Using the still picture
 - recording function linked
 - to a external device 6-2
- Using the still picture
 - recording function with a
 - predetermined schedule 6-4

V

- VB Administration Tools .. 1-6, 3-12, 4-2, 4-4
- VAdmin Startup Panel 4-2, 4-6
- VBCollector 1-7
- VBIPi.exe 3-3, 3-21, 7-2
- Video capture size 3-11
- Video quality 3-11
- Video transmission port 3-20
- View current settings 3-22
- View log events 3-22
- View restriction 3-11, 3-12
- View restriction settings 3-13
- View Restriction Tool 4-3, 4-12
- View Restriction Tool display screen 4-13
- Viewer 1-6
- Viewing logs 4-22, 6-16
- Viewing recorded images 6-14
- Viewing recorded pictures 6-6
- Viewing sample pages 5-6

W

- Web pages for video distribution 5-2
- Webview Livescope MV 1-7
- WebView Livescope setting settings page ... 3-20
- Webview Livescope Viewer Software 1-6
- Wide-angle converter 1-5, 2-3
- Windows XP 3-3, 4-4, 6-7
- Writing IP addresses 5-9

Z

- Zoom 3-12

Free Manuals Download Website

<http://myh66.com>

<http://usermanuals.us>

<http://www.somanuals.com>

<http://www.4manuals.cc>

<http://www.manual-lib.com>

<http://www.404manual.com>

<http://www.luxmanual.com>

<http://aubethermostatmanual.com>

Golf course search by state

<http://golfingnear.com>

Email search by domain

<http://emailbydomain.com>

Auto manuals search

<http://auto.somanuals.com>

TV manuals search

<http://tv.somanuals.com>