

NETWORK CAMERA

VB-C60

Operation Guide

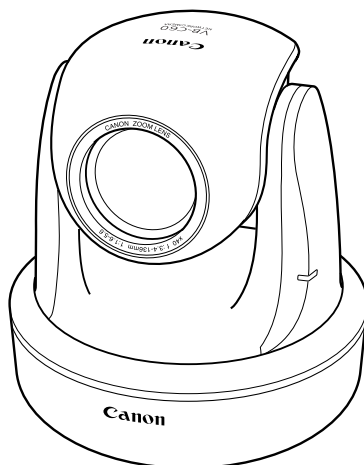

Before using the product, be sure to read the Start Guide and this Operation Guide.

Introduction

Thank you for purchasing Canon Network Camera VB-C60/VB-C60B (hereafter referred to as VB-C60).

The only difference between VB-C60 and VB-C60B is the body color.

This Operation Guide describes how to set up and use VB-C60. Read this guide carefully before using VB-C60 to ensure that you make the best possible use of this product. Also, be sure to read the ReadMe file on the Setup CD-ROM.

For the latest information, please refer to the Canon Web site.

Exclusion of Liability

If the Product is connected to a recording device, Canon Inc. shall not be responsible for any financial losses that may be incurred as a result of the loss of recorded information or images, regardless of the internal or external cause of the loss.

Copyright

Videos, images or sounds recorded with your VB-C60 may not be utilized or published, without consent of copyright holders, if any, except in such a way as permitted for personal use under the relevant copyright law.

Notes

1. All rights reserved.
2. The contents of this guide are subject to change without any notice.
3. Every effort has been made to ensure that this guide is flawless. However, if you find any errors, please contact us.
4. Notwithstanding the above, Canon shall not be responsible for any effects resulting from the use of this guide.

Notes on privacy and publicity rights regarding the utilization of video/audio

When using VB-C60 (for video or audio recording), it is the responsibility of the users to take all care to protect privacy and avoid any violation of publicity rights. Canon shall have no liability whatsoever in this regard.

<Reference>

- Please be sure to gain approval of the building management office before installing a camera, if copyrighted architectural structures or copyrighted premises are got into the frame.

Legal Notice

In some countries or regions, monitoring via a camera is banned by the law or regulation, and the law or regulation depends on the country or region.

Before using VB-C60, confirm the law or regulation of the country or region where the camera is used.

Trademark Notice

- Canon and the Canon logo are registered trademarks of Canon Inc.
- Microsoft Windows and Microsoft Internet Explorer are trademarks or registered trademarks of Microsoft Corporation in the United States and other countries.
- Windows is legally recognized as the Microsoft Windows Operating System.
- Other brands or product names in this guide are trademarks or registered trademarks of their respective companies.

WARNING : To reduce the risk of electric shock, do not expose this appliance to rain or moisture.

Use of Bundled Software “VK-Lite” (Disclaimer)

Malfunction, failure of VK-Lite or other factors may cause problems, such as recording failure, recorded data corruption or loss. Canon shall have no liability whatsoever for any loss or damages incurred by the user as a result of such problems.

MPEG-4

NOTICE ABOUT THE MPEG-4 VISUAL STANDARD: THIS PRODUCT IS LICENSED UNDER THE MPEG-4 VISUAL PATENT PORTFOLIO LICENSE FOR THE PERSONAL AND NON-COMMERCIAL USE OF A CONSUMER TO (i) ENCODING VIDEO IN COMPLIANCE WITH THE MPEG-4 VISUAL STANDARD (“MPEG-4 VIDEO”) AND/OR (ii) DECODING MPEG-4 VIDEO THAT WAS ENCODED BY A CONSUMER ENGAGED IN A PERSONAL AND NON-COMMERCIAL ACTIVITY. NO LICENSE IS GRANTED OR SHALL BE IMPLIED FOR ANY OTHER USE. ADDITIONAL INFORMATION INCLUDING THAT RELATING TO PROMOTIONAL, INTERNAL AND COMMERCIAL USES AND ADDITIONAL LICENSING MAY BE OBTAINED FROM MPEG LA, LLC. SEE [HTTP://WWW.MPEGLA.COM](http://www.mpegla.com).

“This product is licensed under AT&T patents for the MPEG-4 standard and may be used for encoding MPEG-4 compliant video and/or decoding MPEG-4 compliant video that was encoded only (1) for a personal and non-commercial purpose or (2) by a video provider licensed under the AT&T patents to provide MPEG-4 compliant video. No license is granted or implied for any other use for MPEG-4 standard.”

Third Party’s Software

The product (network camera and bundled VK-Lite viewer) contains third party’s software modules. For detail information, please refer to ReadMe-E.txt on the supplied CD-ROM. Each module’s license conditions are also available in the License folder on the same CD-ROM.

Software under GPL and LGPL

If you would like to obtain the source code under GPL/LGPL, please contact the dealer, where you purchased the product, or a sales agent.

Contents

Introduction	ii
Contents	v
How to Read the Guides	viii
User's Manual	viii
Icons using in this Guide	ix
Camera's Top Page	x
Access Camera's Top Page	x
Access the Setting Menu	xi
Access the Sample Pages	xi
Access the VB-C60 Viewer	xii
User Authentication for Accessing the Setting Menu or Admin Viewer	xiii

Chapter 1 Detailed Settings

Setting Menu	1-2
Access the Setting Menu	1-4
Setting Menu	1-4
Common Items	1-5
Set Administrator Password, LAN, IPv6 and DNS (Network)	1-7
Set the Date and Time (Date and Time)	1-11
Set the Camera Control and External Device Names (Camera)	1-13
Set the Image Size, Quality and Frame Rate (Image)	1-19
Set HTTP Upload, FTP Upload and E-mail Notification (Upload)	1-21
Set Up the Image, Audio and HTTP Servers (Server)	1-26
Set Image Buffering, Motion Detection, Audio Playback, Interval Timer (Event)	1-29
Set User Access Privileges (Access Control)	1-35
Set IPsec (IPsec)	1-39
Setting Items That Require a Reboot (Reboot)	1-42
Display Event Log and Current Settings, Execute Maintenance (Maintenance)	1-44

Chapter 2 VBAdminTools

Overview of VBAdmin Tools	2-2
VBAdmin Tools	2-2
Panorama Creation Tool	2-2
View Restriction Tool	2-2
Preset Setting Tool	2-3
Motion Detection Tool	2-3
Log Viewer	2-3
Admin Viewer	2-3

Start Up VBAAdmin Tools	2-4
Panorama Creation Tool	2-6
Panorama Creation Tool Display Screen	2-7
Capture Panorama Image	2-8
Register/Delete Panorama Image	2-9
Reconnect	2-10
Open/Save Panorama Image from/to Image File	2-10
View Restriction Tool	2-11
View Restriction Tool Display Screen	2-12
Set View Restrictions	2-14
Preset Setting Tool	2-18
Preset Setting Tool Display Screen	2-19
Set Presets	2-21
Preset Tour	2-24
Motion Detection Setting Tool	2-27
Log Viewer	2-36
Download Log File	2-36
View Logs	2-37

Chapter 3 VB-C60 Viewer

VB-C60 Viewer Overview	3-2
Major Differences between Admin Viewer and VB Viewer	3-2
User Authority and Camera Control Privilege	3-3
Starting VB-C60 Viewer	3-5
Start up VB-C60 Viewer	3-5
Close VB-C60 Viewer	3-6
Connect from the VBAAdmin Tools	3-6
How to Operate the VB-C60 Viewer	3-8
“Admin Viewer” Display Screen	3-8
“VB Viewer” Display Screen	3-10
Obtain the Camera Control	3-11
Control the Camera	3-12
Configure Image and Audio Settings	3-17
Display Information	3-20
Operating and Setting as Administrator	3-21
Open the Control for Admin Panel	3-21
Control the External Device Output	3-22
Display the Status of External Device Input	3-22
Display the Status of Motion Detection	3-22
Control and Set the Camera	3-23
Set the Focus	3-24
Set the Exposure	3-25
Set the White Balance	3-27

Set the Smart Shade Control 3-28
 Set the Night Mode 3-28

Chapter 4 Creating Web Pages for Video Distribution

Web Pages for Video Distribution 4-2
View Sample Pages 4-4
Distribute Video using VB Viewer 4-5
 Create a Web Page using the VB Viewer 4-5
 Save Web Page Data 4-6
 Example of Using the VB Viewer to Create a Web Page 4-6
 VB Viewer Parameters 4-8
Distribute Video using a Browser Only 4-9
 Display the Live Video at Access as a Still Image 4-9
Example of Video Distribution using One Global Address 4-10
Distribute Still Images to a Mobile Phone 4-11
 Overwrite Sample Pages 4-12

Chapter 5 Appendix

 Modifiers 5-2
Troubleshooting 5-4
Log Message List 5-6
 VB-C60 Log Messages 5-6
VB-C60 Viewer Message List 5-12
 Messages displayed in the Information Field 5-12
Restore the Factory Default Settings 5-14
 Restore the Factory Default Settings from the Maintenance Menu Using a
 Web Browser 5-14
 Initialize the Camera using the Reset Switch 5-15
List of Factory Default Settings 5-16
Index 5-20

How to Read the Guides

In the Start Guide and Operation Guide, the text and illustrations are applicable for both VB-C60 and VB-C60B.

VB-C60 comes with two guides; “**Start Guide**” and this “**Operation Guide**” (on supplied Setup CD-ROM).

User’s Manual

Start Guide (enclosed)



Start Guide explains the safety precautions, the types of bundled software, the system requirements, and the software installation instruction, the initial setting and mounting procedures for VB-C60.

Sections where the user should refer to the Operation Guide are indicated by the  icon accompanied by the relevant page number.

Operation Guide (this guide) (VBC60OG_E.pdf)



Operation Guide explains how to configure the basic settings for VB-C60, how to use VAdmin Tools and VB-C60 Viewer, and troubleshooting tips.

The Operation Guide is contained in the Setup CD-ROM.

The Setup CD-ROM also contains “VK-Lite”, a simplified version of the Network Video Recorder (→  Start Guide P.1-6). The instruction manuals below are provided for VK-Lite.

Setup Guide (VK20SUG_E.pdf)



Setup Guide provides notes for using VK-Lite, the system requirements, system configuration, installation instruction and setup procedures.

Administrator’s Manual (VK20AM_E.pdf)



Administrator’s Manual provides details of how to use VK-Lite. Be sure to read this manual before use.



Viewer Operation Guide (VK20VOG_E.pdf)



Viewer Operation Guide is the operation guide for VK-Lite Viewer. For detailed information on how to use VK-Lite Viewer, refer to the “Administrator’s Manual”.

Icons using in this Guide

Following icons are used to draw reader's attention to particularly important text in this guide.

Icon	Explanation
 Note	Important information that must be observed or actions that are prohibited during an operation. These notes must be read to prevent the equipment from possible faults or damage.
 Tip	Supplementary information or a reference to the operation. Users are recommended to read these memos.
	Please refer to Start Guide.

Camera's Top Page

This section explains the VB-C60's top page including the setting menus and how to access the VB-C60 viewer.

First, you need to access the camera's top page using a Web browser.

From the page, you can open the VB-C60 viewer for displaying video or the setting page for detailed settings of the camera.

When you access VB-C60 for the first time, please refer to the Start Guide comes with VB-C60.



Note

In this guide, the IP address "192.168.100.1" (factory default setting) is used to explain how to operate the camera. In actual operation, use the IP address that you set in your VB-C60.

Access Camera's Top Page

1. Access <http://192.168.100.1/> in the Web browser

2. The camera's top page appears

The overview of each link is as follows.



① **Language button**

Click this button to change the language to be displayed.

② **Link to Setting Page (Setting Menu)**

Click this link to display the setting menus.

③ **Link to Sample Pages**

Click this link for sample images.

④ **Link to VB-C60 viewer**

Click to start the VB-C60 viewer that displays video from VB-C60 in the Web browser.

The VB-C60 viewer includes two viewers: "Admin Viewer" and "VB Viewer" (→ P.3-2).

● **Explanation of each link**

Admin Viewer

Click to start Admin Viewer.

VB Viewer

Click to start VB Viewer.

Access the Setting Menu

Click ② Setting Page to move to the setting page for detailed settings.
For details on the Settings Menu, see Chapter 1 “Detailed Settings”(→ P.1-2).



Access the Sample Pages

Click ③ Sample Page to access the sample pages.
You can view three types of sample pages: still image, video, and image for mobile phone.



Tip

For details on how to utilize the sample pages, see Chapter 4 “Creating Web Pages for Video Distribution”(→ P.4-2).

Access the VB-C60 Viewer

Click the “Admin Viewer” or “VB Viewer” link under ④ “VB-C60 Viewer” to access the VB-C60 viewer.



Admin Viewer



VB Viewer

User Authentication for Accessing the Setting Menu or Admin Viewer

User authentication is required to access the “Setting Menu” or “Admin Viewer”.

The factory default setting is as follows.

User name : root

Password : VB-C60

The user name “root” is the Administrator account of VB-C60.



from Setting Page



from Admin Viewer



Note

- When Administrators and Authorized users use the VB-C60 viewer on the same PC, it is strongly recommended not to check the “Remember my password” checkbox.
- Be sure to enter the correct user name and password. If entering a wrong one, try again with the correct name and password.
- Be sure to change the Administrator password for system security. Do not forget the new password.
- If you forgot the Administrator password, press the camera’s reset switch to restore the factory default setting (→ P.5-15). **However, note that all settings are restored to the factory default settings.**
- If you need to delete sample pages (→ P.4-4) for security reasons, be sure to access the following path using FTP and copy the files to PC or other devices for backup, before deleting.

Path to the Japanese version sample: /mnt_flash/www/html/sample/

Path to the English version sample: /mnt_flash/www/html/sample/

To restore deleted sample pages, you need to write back the copied files to the above path. So, be sure to back up the files before deleting sample pages.



Tip

For more information on VB-C60 viewer and the user type, see Chapter 3 “VB-C60 Viewer” (→ P.3-2).

Chapter **1**

Detailed Settings

This chapter describes the detailed settings for VB-C60 such as network connection, camera control, date, time and access control.

Setting Menu

You can move to each setting page from Setting Menu for following various camera settings. For details, refer to each page of this manual.

● Setting Menu



● Network

Settings for the administrator password, LAN, IPv6, DNS and SNMP (→ P.1-7)

● Date and Time

Settings for the date, time and time zone on the camera (→ P.1-11)

● Camera

Settings for the camera name, camera initial settings, camera control, day/night, installation conditions, camera position control, external input device names and external output device names (→ P.1-13)

● Image

Settings for image quality, image size and frame rate of JPEG image and MPEG-4 video (→ P.1-19)

● Upload

Settings for HTTP/FTP upload via HTTP or FTP and e-mail notification (→ P.1-21)

● Server

Settings for the image server, audio server and HTTP server (→ P.1-26)

● Event

Settings for image buffer, motion detection, external device input, interval timer and voice file upload (→ P.1-29)

● Access Control

Settings for the authorized user account, user authority and host access restriction (→ P.1-35)

● IPsec

Settings for IPsec (→ P.1-39)

● Reboot Item

Settings for items that require a reboot after the setting (→ P.1-42)

● Maintenance

Viewing of the event log and current settings, rebooting the camera, and restoring the factory default settings (→ P.1-44)



Note

Windows Vista/XP

- If the “Windows Security Alert” dialog box appears, click “Unblock”. Once you click “Unblock”, this dialog box will not be displayed again.



- If a pop-up blocker appears when you attempt to view “Help” of each setting item or when you attempt to open “View Log Events” or “View Current Settings” in the “Maintenance” page, follow the instructions of the information bar to disable the pop-up blocker.



Access the Setting Menu

To configure each setting, first you need to access to the camera via a web browser.
To begin with, access to the camera's top page (→ P.x). For details of entering a user name and a password, refer to page P.xiii.

Setting Menu

You can access each setting page and the Admin viewer from the Setting Menu.

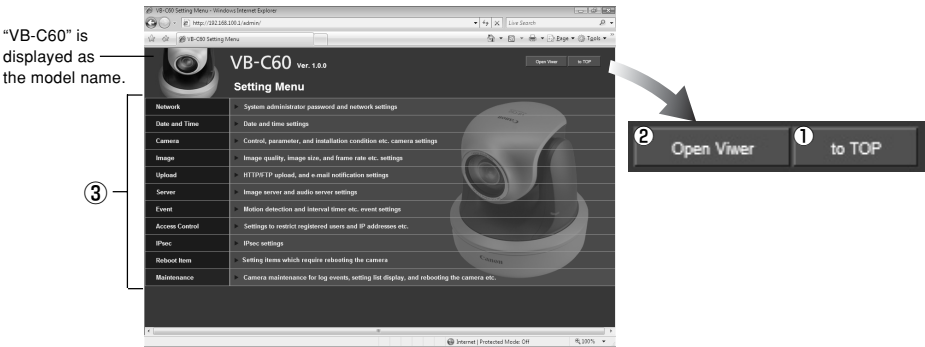

- ① **to Top button**
Click this button to move to the camera's top page.
- ② **Open Viewer button**
Click this button to open the Admin viewer.
- ③ **Setting Menu**
Click this button to move to each setting page.



Note

For security reasons, be sure to close the browser after you finish setting on the setting pages.

Common Items

■ Apply Changes

When you change the settings on each setting page, the grayed-out “OK” button on the top right of the page changes to blue.



Click “OK” to enable the changes.

Click “Clear” to reset the changes.

■ Setting Items That Require Reboot

An orange mark is indicated for each setting item that requires rebooting the camera to enable the change.

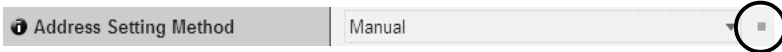

When you change a setting item with the orange mark, the “OK” button displayed on the top right of the setting page changes to “OK and Reboot”.



Click “OK and Reboot” to enable the change. The setting changes and then the camera reboots. Click “Clear” to reset the changes.



Tip

- A dialog box appears to alert when clicking “OK” or “OK and Reboot” after changing the network setting, in which the currently-used browser becomes unable to access to the camera.
- If the above network setting is changed and so the viewer cannot reconnect to the camera automatically, links to candidate URIs are displayed. However, you may not be able to connect using the URI, as these are just candidate URIs. In such case, try connecting from VB Initial Setup Tool.

■ Return to the Setting Menu

Click “to Menu” on the top right of each setting page to return to the Setting Menu.

VB-C60 Ver. 1.0.0

to Menu



Note

- Do not open multiple setting pages when changing settings for a single camera settings.
- Do not use “Back” and “Forward” of the web browser to move between the setting pages. The old page is displayed due to effects of caching, so the set values may return to the older ones, or unintended changes may be made.



Tip

Detailed information for each setting item is available by clicking  “HELP” in each column.

Set Administrator Password, LAN, IPv6 and DNS (Network)

Network

Reboot

OK

Clear

You can configure following settings.

- **Administrator Password**

Setting the administrator password.

- **LAN**

Setting for items required for LAN connection such as IP address.

- **IPv6**

Setting for IPv6.

- **DNS**

Setting for the name server address, host name and DDNS.

- **SNMP**

Setting for SNMP.

▼ Administrator Password

Administrator Password ①	① Password Up to 8 characters	*****
②	② Confirm Password Up to 8 characters	*****

① **Password**

Set the administrator password. Up to 8 alphanumeric characters (including spaces and printable characters) can be used. The factory default setting is "VB-C60". Be sure to disconnect the Admin viewer or VBAAdmin Tools from the camera before changing the password.

② **Confirm Password**

Enter the same password as above for confirmation.



Note

- For system security, make sure to change the administrator password, and not to forget the new password.
- If you forget the password, press the camera's reset switch to restore the factory default setting (→ P.5-15). **However, note that all settings will be restored to the factory default settings.**

▼LAN

LAN	①	IP Address Setting	Manual
	②	IP Address	192.168.100.1
	③	Subnet Mask	255.255.255.0
	④	Default Gateway Address	
	⑤	LAN Interface	Auto
	⑥	Maximum Transmission Unit <small>576 - 1500</small>	1500

① IP Address Setting

Select “Auto (DHCP)” or “Manual” as IP address setting method. If you select “Auto (DHCP)”, values automatically retrieved from the DHCP server are used for “IP Address”, “Subnet Mask”, and “Default Gateway Address”. If you select “Manual”, directly enter values according to the environment.

② IP Address

Enter the static IP address if you specify “Manual” in ①.

③ Subnet Mask

Set the subnet mask assigned to each network if you specify “Manual” in ①.

④ Default Gateway Address

Set the default gateway address if you specify “Manual” in ①. Be sure to set the address when connecting the camera to a subnet other than the viewer.

⑤ LAN Interface

Select from “Auto”, “Full Duplex” and “Half Duplex”. Normally, use “Auto”.

⑥ Maximum Transmission Unit

Enter the maximum transmission unit size. Normally, there is no need to change this setting from 1500.



Note

- Please consult with your network administrator for “IP address”, “Subnet Mask”, and “Default Gateway Address”.
- If there are any errors in any of “IP address”, “Subnet Mask” or “Default Gateway Address”, you may not be able to access the camera via the network. In this case, use the VB Initial Setting Tool v4.0 (→ Start Guide P.2-9) to configure the address settings again.
- If you change the setting of “IP Address Setting”, “Subnet Mask”, “Default Gateway Address”, “LAN Interface” or “Maximum Transmission Unit”, the currently-used browser may become unable to access the camera. Be sure to read the note in the “Setting Items That Require a Reboot” page, in advance (→ P.1-42). It is also recommended to read the note before changing settings of “IPv6” and “DNS” (→ P.1-9).
- When “Auto (DHCP)” is specified for “IP Address Setting”, the IP address may not be correctly assigned if there is a router between the DHCP server and VB-C60. In this case, specify “Manual” and assign a fixed IP address manually.
- When using IPv6, set “Maximum Transmission Unit” to 1280 or higher.



Tip

- When using ADSL, the transmission efficiency may be increased by setting a lower value for Maximum Transmission Unit.
- The IP address assigned by “Auto (DHCP)” can be confirmed in VB Initial Setting Tool.

▼IPv6

IPv6	① IPv6	Enable
	② IPv6 Address	

① IPv6

Select “Enable” when using IPv6.

② IPv6 Address

The IPv6 address is displayed in the column.



Tip

In the environment where IPv6 is not available, nothing is displayed in the “IPv6 Address” column even when specifying “Enable”.

▼DNS

DNS	①	① Name Server Address 1	
		② Name Server Address 2	
	②	③ Host Name Up to 63 characters	
		④ Host Name Registration with DDNS	Disable

① Name Server Address 1 - 2

Enter the name server address to be registered. When using only one name server, leave Name Server Address 2 field blank.

② Host Name Registration with DDNS

Select “Enable” and enter the host name. You can register the host name to the name server. You can use up to 63 characters including A-Z, a-z, 0-9, -, ., for the host name.



Tip

- The host name is useful when using the VB-C60 with “Auto (DHCP)” (→ P.1-8). You must register the host name in the DNS server in advance. For more information on DNS server settings, contact your system administrator.
- If Name Server Address 1 is not available, the camera automatically will access Name Server Address 2. However, Name Server Address 2 must be registered in advance.

▼SNMP

SNMP	①	SNMP	Enable
	②	Community Name <small>Up to 31 characters</small>	public
	③	Administrator Contact Information <small>Up to 63 characters</small>	
	④	Administration Function Name <small>Up to 31 characters</small>	
	⑤	Installation Location <small>Up to 31 characters</small>	

① SNMP

Select from “Disable” and “Enable”. Specify “Enable” if you need to reference camera’s information from the SNMP manager.

② Community Name

Enter the SNMP community name. For security reason, it is recommended to change the default community name.

③ Administrator Contact Information

Enter the contact information of camera’s administrator, such as an e-mail address. The entered information can be checked from the SNMP manager.

④ Administration Function Name

Enter the camera name used for administration. The entered name can be checked from the SNMP manager. When it is blank, default value “VB-C60” is used.

⑤ Installation Location

Enter camera’s location information. The entered information can be checked from the SNMP manager.



Tip

- The camera’s information is read-only from the SNMP Manager.
- Use the SNMP Manager in SNMP MIB2 (RFC1213 compatible).

Set the Date and Time (Date and Time)

Date and Time

OK

Clear

You can configure following settings.

- **Current Date and Time**

The date and time set on the camera are displayed.

- **Setting**

Setting for the date, time and time zone.

▼Current Date and Time

Current Date and Time	🕒 Date yyyy/mm/dd	2008/05/23
	🕒 Time hh:mm:ss	09:43:57

Date, Time

The date and time set on the camera are displayed.

▼Setting

Setting	①	🕒 Setting Method	Set manually ▼
	②	🕒 Date yyyy/mm/dd	2008/05/23
		🕒 Time hh:mm:ss	09:43:57
	③	🕒 Time Zone	(GMT+09:00) Osaka, Sapporo, Tokyo ▼

① Setting Method

Select from “Set Manually”, “Synchronize with NTP server”, “Synchronize with NTP broadcast” and “Synchronize with computer time”.

② Date, Time

Configure the following settings depending on the ① “Setting Method”.

Set manually

Manually enter the date and time in “Year/Month/Day” format for the date and in “hh:mm:ss” format for the time. Use 2 digits for the month, day and time.

Example: Enter “2008/08/23” and “13:23:04” for 1:23:04 PM, August 23 2008.

Setting Method	Set manually
Date yyyy/mm/dd	2008/05/23
Time hh:mm:ss	09:43:57
Time Zone	(GMT+09:00) Osaka, Sapporo, Tokyo

Synchronize with NTP server

Enter the NTP server IP address, so that the time is synchronized with the NTP server's time.

Setting Method	Synchronize with NTP server
NTP Server (IP Address)	
Time Zone	(GMT+09:00) Osaka, Sapporo, Tokyo

Synchronize with NTP broadcast

The time is synchronized with the NTP broadcast's time.

Setting Method	Synchronize with NTP broadcast
Time Zone	(GMT+09:00) Osaka, Sapporo, Tokyo

Synchronize with computer time

The time is synchronized with the date and time of the computer currently accessing the camera. The time zone is also automatically selected.

Setting Method	Synchronize with computer time
Date yyyy/mm/dd	2008/05/31
Time hh:mm:ss	20:35:39
Time Zone	(GMT+09:00) Osaka, Sapporo, Tokyo

③ Time Zone

Select the appropriate time zone.



Tip

- After applying the settings by clicking “OK”, “Setting Method” is automatically set to “Set manually”.
- When “Synchronize with NTP server” is selected, if the camera cannot connect to the NTP server because of the wrong IP address of the NTP server or other reasons, the date and time will not be changed.
- The Time Zone does not support Daylight Savings Time.

Set the Camera Control and External Device Names (Camera)

Camera

Reboot

OK

Clear

You can configure following settings.

- **Camera Name**

Enter the camera name. The name is required when using VK-64 with the camera.

- **Camera Control**

Setting for the AF mode, shutter speed, focus, digital zoom and Image Stabilizer.

- **Day/Night**

Select the switching mode for Day/Night.

- **Installation Conditions**

Setting for dome use, LED and installation style.

- **Camera Position Control**

Configure whether or not to use the registered preset positions for the pan/tilt/zoom operations. Also set the operations of when there is no request for the control privilege.

- **External Device Names**

Set the external input/output device names.

Camera Name

General

Camera Name Up to 15 characters

Camera

Camera Name

Be sure to enter the camera name with 15 or less alphanumeric characters, including spaces and printable characters.



Tip

When using optional network video recorder VK-64/VK-16 or banded VK-Lite, the camera name specified here will be displayed.

▼Camera Initial Settings

Camera Initial Setting		
①	AE Mode	Shutter Priority AE
	Shutter Speed	1/100
②	Focus Mode	Auto

① AE Mode, Slow Shutter, Shutter Speed

Set the camera's exposure mode and shutter speed.

AE Mode

Auto

"Auto" is used to automatically control the exposure.

Flickerless

"Flickerless" is used to reduce flicker in video caused by some factors, like fluorescent lamps. The shutter speed is automatically adjusted according to the brightness of the shooting environment.

Shutter-priority AE

"Shutter-priority AE" is used when specifying the shutter speed.

Slow Shutter

Slow Shutter can be set only when "AE Mode" is set to "Auto".

Select the slowest shutter speed, which is used to capture video in lower light conditions in the "Auto" mode. You can select the speed from "Disable", "1/15" and "1/8". Moving subjects may be blurred when captured in low light conditions, so it is important to select the suitable mode according to the shooting condition.

Shutter Speed

Shutter Speed can be set only when "AE Mode" is set to "Shutter-Speed Priority AE".

You can choose from 12 levels of shutter speed between "1/8" and "1/8000". It is recommended to specify faster speed when capturing moving subjects, so that the image blur can be reduced.

② Focus Mode

Set the camera's focus mode.

Auto

"Auto" is used to automatically obtain correct focus. Normally, select "Auto".

Fixed at infinity

The focus is fixed at a point of infinity.



Note

- When monitoring subjects through a glass window, the camera may focus on the glass surface if there is dust or drop of water on it. So, in such situation, be sure to place the camera at a close distance from the window, possibly less than 30 cm.
- The above item ① and ② are the initial values used at camera startup. The new settings will be applied when the camera is turned on again or the camera is rebooted. Use the "Control for Admin" panel of VB-C60 viewer to configure the settings used in the actual operating environment (→ P.3-21).
- When capturing subjects like traffic lights and electronic signboards, the captured video may be blinking. It may be reduced by changing the exposure mode to "Auto (Shutter-priority AE)" and choosing a shutter speed of 1/100 or slower.



Tip

- The camera may have difficulty focusing automatically on subjects of the type shown below.

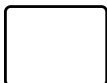

Subjects with little or no contrast (e.g. a white wall)

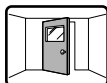

Angled subjects



Highly reflective subjects

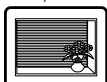

Subjects that consist entirely of oblique or horizontal lines or stripes

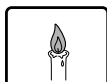

Insubstantial subjects such as flames or smoke

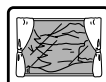

Subjects seen through glass

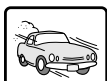

Quickly moving subjects

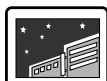

Night views or dark places

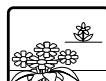

Far and near subjects in the same frame

- The focusing range (approx) differs depend on the “Day/Night” and other settings as shown below.

	Day/Night setting		Day mode		Night mode	
	Dome	Infrared lamp	Wide end	Tele end	Wide end	Tele end
Auto	Not used	None	0.3m~∞	1.5m~∞	0.5m~∞	1.8m~∞
	Used	None	2.1m~∞		2.4m~∞	
	Not used	Yes	/		0.5m~∞	1.8m~∞
	Used	Yes	/		0.5m~∞	2.4m~∞
Fixed at infinity		None	Point of infinity			
		Yes	Point of infinity Note) The camera may be out of focus.			

- It is recommended to set “Focus Mode” to “Fixed at infinity” to capture video of low-contrast subjects, of which it is difficult to obtain correct focus, e.g. night scene.

▼Camera Control

Camera Control	①	Digital Zoom	Disable
	②	Image Stabilizer	Disable

① Digital Zoom

Select whether or not to use the digital zoom from “Disable” or “Enable”.

* The higher the zoom factor is, the lower the image quality may be.

② **Image Stabilizer**

Select whether or not to activate Image Stabilizer from “Disable”, “On1” and “On2”. Image Stabilizer effectively works to compensate for image blur caused by camera shake. If “On1” is not strong enough to correct the image blur, try “On2”. While Image Stabilizer is being activated with “On1” or “On2”, the viewing angle may be narrower and the image quality may be degraded, comparing with when Image stabilizer is disabled. This is because of the stabilization process, not camera failure.

	Blur Level	Ratio of viewing angle	No. of effective pixels
Disable	–	100%	Approx. 310,000 pixels
On1	Small	83%	Approx. 210,000 pixels
On2	Large	50%	Approx. 80,000 pixels



Note

- It is recommended to set the image capture size to “320 x 240” or smaller, while specifying “On2”.
- IS does not work to correct vibration of a subject itself.
- Image Stabilizer cannot correct image blur caused by instantaneous shake or large vibration that exceeds a certain level.
- Refer to P.3-20, for note on viewer use while Image Stabilizer is being activated.

▼ **Day/Night**

Day/Night	①	Mode	Auto
	②	Switching Brightness	Standard
	③	Response (sec.)	20

① **Mode**

Select the switching mode from “Manual” and “Auto”. When specifying “Auto”, you can set “Switching Brightness” and “Response” according to the environment where the camera is installed or the switching condition.

* If you are using an infrared lamp, you cannot use “Auto”.

② **Switching Brightness**

Select the brightness level to switch day mode and night mode from “Darker”, “Slightly Darker”, “Standard”, “Slightly Brighter” and “Brighter”. When you prefer to shoot color video as much as possible, select “Darker”. When you prefer to reduce noise even in black and white video, select “Brighter”.

③ **Response (sec.)**

Select the time, at which day mode and night mode switches, from “5”, “10”, “20”, “30” and “60”. The day and night mode are switched when the brightness set in the above ②, maintains for a set period of time. It is recommended to specify “30” or “60” for situations, where the brightness frequently changes, for example, light sources pass in front of the camera. Or, specify “5” or “10” for situations, where there are few changes in brightness.



Note

- Operation of the day/night switching function should be tested thoroughly before using “Day/Night” in the “Auto” mode.
- When using “Day/Night” in the “Auto” mode, “AE Mode” should be set to “Auto” or “Flickerless” (→ P.3-25).
- When using the camera with IR light, “Day/Night” should be set to “Manual”. IR light cannot be used in the “Auto” mode.
- While using “Day/Night” in the “Auto” mode, the IR cut filter may be inserted and removed several times, at the time of switching day mode and night mode. In the meanwhile, Pan, Tilt, Zoom and Manual focus do not operate.

▼ Installation Conditions

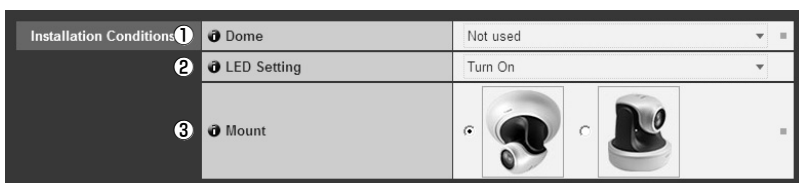

① Dome

Select whether or not to use a dome. When you use the camera with a dome housing, select “Used”.

② LED Setting

Select whether or not to light the LED on camera’s head arm from “Turn On” and “Turn Off”. Select “Turn OFF” when the LED light is not needed or it can interfere monitoring, for example, when you use the camera with an optional indoor dome housing (VB-RD51S-C/S) or when reflected LED lights may be gotten into the shooting frame.

③ Mount

Select the camera mount type. The factory default setting is Inverted.



Tip

- Even when “LED Setting” is set to “Turn off”, the LED will turn on once when the camera is started.
- The image for the Inverted “Mount” type shows the conditions with the cover for a ceiling mount (The ceiling mount cover is option).

▼ Camera Position Control

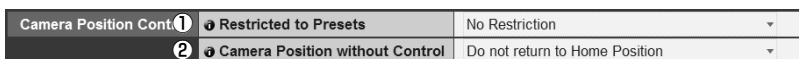

① Restricted to Presets

Select whether or not to restrict the camera control to presets from “No Restriction” and “Preset Only”. When “Preset Only” is selected, the camera control is restricted to preset angles only for all users except the administrator.

② **Camera Position without Control**

Select whether or not to move the camera's direction to the home position when nobody has the control privilege. Specify "Return to Home Position" so that the camera automatically changes its direction to the home position. Before using this function, you need to set the camera's home position using VBAdmin Tool (→ P.2-18).

▼**External Input Device 1 - 2/External Output Device 1 - 2**

External Input Device 1	Device Name (alphanumeric characters) Up to 15 characters	<input type="text"/>
External Input Device 2	Device Name (alphanumeric characters) Up to 15 characters	<input type="text"/>
External Output Device 1	Device Name (alphanumeric characters) Up to 15 characters	<input type="text"/>
External Output Device 2	Device Name (alphanumeric characters) Up to 15 characters	<input type="text"/>

External Input Device/External Output Device - Device Name

To distinguish between connected external devices, be sure to set a device name with up to 15 ASCII characters (including blank and printable characters) excluding double quote " " .



Tip

When you are using the Admin viewer, optional network video recorder VK-64/VK-16, or bundled VK-Lite, the device name specified here is displayed.

Set the Image Size, Quality and Frame Rate (Image)

Image

Reboot

OK

Clear

You can configure following settings.

- JPEG

Configure the image quality, size and maximum frame rate for JPEG images.

- MPEG-4

Configure the image quality, size and capture frame rate for MPEG-4 video.

▼JPEG

JPEG		
①	Image Quality: 160 x 120	3
	Image Quality: 320 x 240	3
	Image Quality: 640 x 480	3
	Image Size: Image Transmission	320x240
②	Maximum Frame Rate: Image Transmission	30.0
③	Image Size: Upload	320x240

① **Image Quality**

Select the image transmission quality for each image size in JPEG from 1 - 5 (in 5 levels). The higher the value, the higher the image quality.

② **Image Size: Image Transmission**

Select the image size used when transmitting images from “160x120”, “320x240” and “640x480”. The set image size is used as a default image size for transmitting images to viewers.

③ **Maximum Frame Rate: Image Transmission**

Reduce the viewer load by limiting the maximum frame rate for transmitting images per second. The maximum value is 30 fps. Enter a value between 0.1 and 30. 0.

④ **Image Size: Upload**

Select the image size for image upload from “160x120”, “320x240” and “640x480”. For information on upload settings, refer to P.1-21.

▼MPEG-4

MPEG-4		
①	Video Quality	3
②	Video Size	320x240
③	Capture Frame Rate	30

① **Video Quality**

Select the video quality for MPEG-4 video from 1 - 5 (in 5 levels). The higher the value, the higher the video quality.

② **Video Size**

Select the video size for transmission from “320x240” and “640x480”.

③ **Capture Frame Rate**

Select the capture frame rate from “10”, “15” and “30”.



Note

- Higher image size or quality results in a larger data size per frame and a heavier network load.
 - JPEG : The frame rate may decrease.
 - MPEG-4 : Video may be interrupted temporarily.
- The data volume may become large according to the type or amount of movements of subjects. Set the image size smaller or set the image quality lower, in conditions, where the frame rate continues decreasing for a long time.
- If you are using optional network video recorder VK-64/VK-16 or bundled VK-Lite, the image size and quality settings affect the required hard disk space for recording.

Set HTTP Upload, FTP Upload and E-mail Notification (Upload)

Upload

Reboot OK Clear

You can configure following settings.

- **General Upload**
Setting for upload operations.
- **HTTP Upload**
Setting for HTTP upload.
- **FTP Upload**
Setting for FTP upload.
- **E-mail Notification**
Setting for e-mail notification of event information and images.

▼General Upload



Upload

Select the upload method from “Upload Disabled”, “HTTP Upload” and “FTP Upload”.



Note

- You also need to set the “Event” menu settings to use the upload function (→ P.1-29).
- Set the “Image Size: Upload” (→ P.1-19) to 320 x 240 or smaller, when you use both e-mail notification including text and an image, and image upload by HTTP/FTP upload.
- When you set image upload and e-mail notification to be continuously carried out, some images or e-mail may be dropped and not be sent, according to the size of the image data or the network condition to the server. In that case, a message is displayed in the log events.



Tip

- Following tips are effective to reduce the load of image upload and e-mail notification. It is also useful to check settings, including network to the server.
 - Reduce the size of image files
 - Set a smaller value for JPEG > “Image Quality” (→ P.1-19).
 - Set smaller image size in JPEG > “Image Size: Upload” (→ P.1-19).
 - Reduce the frequency of upload
 - Set a smaller value for “Pre-event Buffer (number of image frames)” and “Post-event Buffer (number of image frames)” (→ P. 1-29).
 - Set “Disable” for any one of “ON Event Operation”, “OFF Event Operation”, or “Continuous Motion Operation”, when “Motion Detection Event” is set to “Enable” (→ P.1-30).

- Set “Disable” for either of “ON Event Operation” or “OFF Event Operation”, when “External Device Input Event” is set to “Enable” (→ P. 1-32).
- Select a longer interval for “Interval of the Timer”, when “Interval Timer Event” is set to “Enable” (→ P.1-33).
- Reduce the frequency of e-mail notification
 - Set “Disable” for any one of “ON Event Operation”, “OFF Event Operation”, or “Continuous Motion Operation”, when “Motion Detection Event” is set to “Enable” (→ P.1-30).
 - Set “Disable” for either of “ON Event Operation” or “OFF Event Operation”, when “External Device Input Event” is set to “Enable” (→ P. 1-32).
 - Select a longer interval for “Interval of the Timer”, when “Interval Timer Event” is set to “Enable” (→ P.1-33).

▼HTTP Upload

HTTP Upload	①	🔍 Notification	Notification Only with HTTP
	②	🔍 URI Up to 255 characters	
	③	🔍 User Name Up to 31 characters	
		🔍 Password Up to 31 characters	*****
	④	🔍 Proxy Server Up to 63 characters	
	⑤	🔍 Proxy Port 1 - 65535	80
	⑥	🔍 Proxy User Name Up to 31 characters	
		🔍 Proxy Password Up to 31 characters	*****
	⑦	🔍 Parameter (query string) Up to 127 characters	
	⑧	🔍 HTTP Upload Test	Exec

- ① **Notification**
Select information to be notified from “Notification Only with HTTP” or “Image attached Notification with HTTP”.
- ② **URI**
Enter the URI for upload (using up to 255 characters).
- ③ **User Name, Password**
Enter the user name and password required for authentication.
- ④ **Proxy Server**
Enter the proxy server’s host name or IP address (using up to 63 characters).
- ⑤ **Proxy Port**
Enter the proxy server’s port number (The default port number is “80”).
- ⑥ **Proxy User Name, Proxy Password**
Enter the proxy server’s user name and password.
- ⑦ **Parameter (query string)**
Enter the URI parameters (using up to 127 characters) using interpreted sequences (%) (→ P.5-2).
- ⑧ **HTTP Upload Test**
Click “Exec” to perform a HTTP to check if HTTP upload is properly carried out according to your settings.



Enter “Proxy Server”, “Proxy Port”, “Proxy User Name” and “Proxy Password” when connecting to the camera via a proxy server.

▼FTP Upload

FTP Upload	①	📘 Notification	Image data upload with FTP
	②	📘 FTP Server <small>Up to 63 characters</small>	<input type="text"/> The value is not specified.
	③	📘 User Name <small>Up to 31 characters</small>	<input type="text"/> The value is not specified.
		📘 Password <small>Up to 63 characters</small>	<input type="password"/> *****
	④	📘 PASV Mode	Disable ▾
	⑤	📘 File Upload Path <small>Up to 255 characters</small>	<input type="text"/>
	⑥	📘 File Naming	YYMMDDHHMMSSms ▾
	⑦	📘 FTP Upload Test	<input type="button" value="Exec"/>

① Notification

The information to be notified is set to “Image data upload with FTP”.

② FTP Server

Enter the FTP server’s host name or IP address (using up to 63 characters).

③ User Name, Password

Enter the user name and password required for authentication.

④ PASV Mode

When uploading via FTP, select whether or not to use the PASV mode from “Enable” or “Disable”.

⑤ File Upload Path

Enter a remote path for image files to be upload to (using up to 255 characters).

⑥ File Naming

Select the file naming rule.

“Year month day hour second ms”

Images are uploaded with file name “{year}{month}{day}{hour}{minute}{second}{ms}.jpg”. (e.g.: 20080123112122000.jpg)

“Year month day folder / hour minute second ms”

First, a folder named “{year}{month}{day}” is created, and then images are uploaded with file name “{hour}{minute}{second}.jpg”. (e.g.: 20080123/112122000.jpg)

“Loop”

Images are uploaded with a file name starting from the number “0000” up to the number set in “Maximum Number of Loops”. (e.g.: 0000.jpg, 0001.jpg)

“User settings”

Images are uploaded with a file name specified in “Subdirectory Name to Create” and “File Name to Create”.

📘 File Naming	Loop ▾
📘 Maximum Number of Loops <small>0 - 9999</small>	<input type="text" value="0"/>

Maximum Number of Loops

Enter the maximum number of loops between 0 and 9999 when “File Naming” is set to “Loop”.

1 File Naming	User Setting
2 Subdirectory Name to Create Up to 127 characters	
3 File Name to Create Up to 127 characters	image.jpg
4 FTP Upload Test	Exec

Subdirectory Name to Create, File Name to Create

Enter a subdirectory name and file name to create (up to 127 characters) when “File Naming” is set to “User Setting”, using interpreted sequences (%) (→ P.5-2).

7 FTP Upload Test

Click “Exec” to perform an FTP upload test to check if FTP upload is properly carried out according to your settings.

▼E-mail Notification

E-mail Notification	1 Notification	Text Only
	2 Mail Server Name Up to 63 characters	
	3 Mail Server Port 1 - 65535	25
	4 Sender (From) Up to 63 characters	
	5 Recipient (To) Up to 63 characters	
	6 Authentication	None
	7 Subject Up to 31 characters	
	8 Message Up to 255 characters	
	9 E-mail Notification Test	Exec

1 Notification

Select information to be notified from “Text only” or “Text with Image”.

2 Mail Server Name

Enter the SMTP server’s host name or IP address (using up to 63 characters).

3 Mail Server Port

Enter the SMTP server’s port number (The default port number is “25”).

4 Sender (From)

Enter the sender’s e-mail address (using up to 63 characters).

5 Recipient (To)

Enter the recipient’s e-mail address (using up to 63 characters).

⑥ Authentication

Select the mail authentication method from “None”, “POP before SMTP” and “SMTP-AUTH”, according to the authentication method of the destination SMTP server.

User Name, Password, POP Server

When the mail authentication method is set to “POP before SMTP”, enter the user name and password required for authentication, and the POP server’s host name or IP address.

Authentication	POP before SMTP
User Name Up to 31 characters	username
Password Up to 31 characters	*****
POP Server Up to 63 characters	servername

User Name, Password

When the mail authentication method is set to “SMTP-AUTH”, enter the user name and password required for authentication.

Authentication	SMTP-AUTH
User Name Up to 31 characters	username
Password Up to 31 characters	*****

⑦ Subject

Enter a subject for e-mail notification (using up to 31 characters).

⑧ Message Body

Enter the message (text) of e-mail (using up to 255 characters), using interpreted sequences (%) (→ P.5-2).

⑨ E-mail Notification Test

Click “Exec” to perform an e-mail notification test to check if e-mail notification is properly carried out according to your settings.

Set Up the Image, Audio and HTTP Servers (Server)

Server

■ Reboot

OK

Clear

You can configure the following settings.

● Image Server

Setting for image distribution from the camera.

● Audio Server

Setting for audio transmission and reception.

● HTTP Server

Setting for the HTTP port and Web page distribution.

▼Image Server

Image Server			
①	Maximum Number of Clients	0 - 30	30
②	Camera Control Queue Length	0 - 30	30
③	Maximum Connection Time (sec.)	0 - 65535	0
④	Camera Control Time (sec.)	1 - 3600	20

① Maximum Number of Clients

Set the maximum number of clients, to which the camera can simultaneously distribute video. You can set up to 30 clients. When 0 is specified, only the Admin viewer can connect to the camera.

② Camera Control Queue Length

Set the maximum queue length of requests for the camera control privilege from viewers. The maximum value is 30. Enter an integer from 0 to 30. When you set 0, only the administrator can control the camera.

③ Maximum Connection Time (sec.)

Set the time limit in which each client can connect to the camera.

④ Camera Control Time (sec.)

Set the maximum time period in which viewers can control the camera. The maximum time period is 3600 seconds. Enter an integer from 1 to 3600.

▼Audio Server

Audio Server	①	Audio Transmission from the Camera	Enable
	②	Input Volume 1 - 100	50
	③	Voice Activity Detection	Enable
	④	Audio Reception from the Viewer	Enable
	⑤	Output Volume 1 - 100	50
	⑥	Echo Canceller	Enable
	⑦	Audio Input	Line In

① Audio Transmission from the Camera

Specify “Enable” for transmitting audio from a microphone connecting to the camera to VB-C60 viewer.

② Input Volume

Set the volume on the microphone between 1 and 100. The higher the value, the louder the microphone’s output volume.

③ Voice Activity Detection

Specify “Enable”, so that the data size for audio transmission is temporarily reduced while the server is not detecting any audio input. It enables to reduce network load.

④ Audio Reception from Viewer

Specify “Enable” for outputting audio from optional VK viewers or bundled VK-Lite viewer through speakers connected with the camera.

⑤ Output Volume

Set the volume on the speakers, between 1 and 100. The higher the value, the louder the speaker’s volume.

⑥ Echo Canceller

Specify “Enable” for removing echo caused in the microphone and speakers.

⑦ Audio Input

Select the microphone input mode from “Line In”, “Microphone In (dynamic microphone)” and “Microphone In (condenser microphone)”.

- Audio Transmission
- Input Volume
- Voice Activity Detection
- Echo Canceller

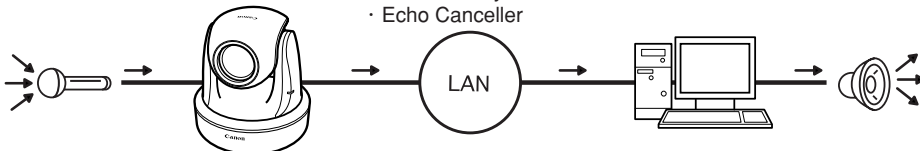

- Audio Reception
- Output Volume

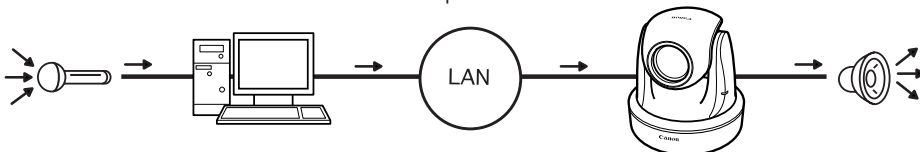



Note

- Switch between Line In and Microphone In in the setting page according to the specifications of the microphone you use (→ P.1-27).
Be sure to use the correct settings to avoid damaging to the camera and microphone.
- Volume and audio quality may vary depending on the characteristics of the microphone.
- Use the VK-Lite viewer to send audio via VB-C60’s audio output terminal. It cannot be sent from the VB-C60 viewer (→ Start Guide P.1-8).
- Use a speaker with amplifier to connect to the camera (→ Start Guide P.3-7).
- When “Echo Canceller” is set to “Enable”, audio quality and volume may be affected. Use this function according to the environment where you install and how you use the VB-C60.
- Before using audio transmission function, be sure to read “Usage Notice of Audio” carefully (→ Start Guide P.xiv).

▼HTTP Server

HTTP Server	①	HTTP Port 80,1024 - 65535	80	=
	②	Global Address for the Web Page	IP Address	▼
		IP Address (global address for the web page)		
		Port Number (global address for the web page) 1 - 65535		

① HTTP Port

Set the HTTP port number to 80 or between 1024 and 65535.

Normally use 80 (factory default setting).

② Global Address for the Web Page

Enter the global address and the port number to assign a fixed global address to the camera (→ P.4-10) using router’s NAT function. When “IP Address” is selected, enter the IP address specified in the “IP Address” field. When “Host Name” is selected, enter the host name specified in “DNS” in “Network”. Perform any necessary settings in “DNS” (→ P.1-9).



Note

- If you change the setting of “HTTP Port”, the currently-used browser may become unable to access the camera. Be sure to read the note in the “Setting Items That Require a Reboot” page (→ P.1-43), in advance.
- When selecting “IP Address” in “Global address for the Web page”, be sure to set both “IP Address (global address for the Web page)” and “Port Number (global address for the Web page)”. When selecting “Host Name”, be sure to set “DNS” → “Host Name” in “Network”, too.

Event

OK

Clear

You can configure following settings.

- **Image Buffer**
Setting for buffering images.
- **Motion Detection**
Setting for operations while motion detection is being activated.
- **External Device Input**
Setting for operations during external device input events.
- **Interval Timer**
Setting for interval timer for e-mail notification and upload operations.
- **Sound Clip Upload**
Setting for audio files to be registered.

▼Image Buffer

Image Buffer	①	Frame Rate 1 - 10	1
	②	Pre-event Buffer (number of image frames) 0 - 100	0
	③	Post-event Buffer (number of image frames) 0 - 100	0

- ① **Frame Rate**
Set the frame rate used when temporarily buffering images in the camera.
- ② **Pre-event Buffer (number of image frames)**
Set the number of images to be buffered, which were captured prior to each event.
- ③ **Post-event Buffer (number of image frames)**
Set the number of images to be buffered, which were captured after each event.



Note

- The maximum size of image buffering is approximately 4 MB.
When you set a smaller image size, “Frame Rate”, “Pre-event Buffer”, or “Post-event Buffer” may not be carried out as you set (→ P.1-21).
- When image buffering is not carried out as you set, a message is displayed in the log events.
Make sure that there is no log event occurring before use the function (→ P.1-21).

▼Motion Detection

Motion Detection	①	🔊 Motion Detection Event	Enabled
	②	🔊 ON Event Operation	Enable ▾
	③	🔊 OFF Event Operation	Enable ▾
	④	🔊 Continuous Motion Operation	Enable ▾
	⑤	🔊 Upload	Enable ▾
	⑥	🔊 E-mail Notification	Enable ▾
	⑦	🔊 Audio Playback at ON Event	Enable ▾
	⑧	🔊 Audio Playback at OFF Event	Enable ▾
	⑨	🔊 Sound Clip	sound1 ▾
	⑩	🔊 Volume 1 -100	50
	⑪	🔊 Automatic Tracking at ON Event	Enable ▾
	⑫	🔊 Maximum Tracking Time (sec.) 1 -300	60

① Motion Detection Event

Whether motion detection is enabled or disabled is indicated. You can switch between enabled or disabled using “Motion Detection Setting Tool” of VBAAdmin Tools (→ P.2-27).

② ON Event Operation

Select whether or not to activate image upload and e-mail notification when the camera detects motion (=ON event). Specify “Enable” to activate those functions when the camera detects motion.

③ OFF Event Operation

Select whether or not to activate image upload and e-mail notification when the camera finishes detecting motion (=OFF event). Specify “Enable” to activate those functions when the camera finishes detecting motion.

④ Continuous Motion Operation

Select whether or not to activate image upload and e-mail notification during motion detection. Specify “Enable” to activate those functions while the camera is detecting motion.

⑤ Upload

Specify “Enable” to upload images according to the setting for image buffering, when the camera detects motion. To use this function, you also need to configure settings of the “General Upload” submenu and the “HTTP Upload” or the “FTP Upload” submenu in “Upload”.

⑥ E-mail Notification

Specify “Enable” to send an e-mail notification when the camera detects motion. To use this function, you also need to configure settings of the “E-mail Notification” submenu in “Upload”.

⑦ Audio Playback at ON Event

Select whether or not to activate audio play when the camera detects motion (=ON event). Specify “Enable” for playing an audio file, specified in following “Sound Clip”, when the camera detects motion (=ON event).

⑧ Audio Playback at OFF Event

Select whether or not to play audio when the camera finishes detecting motion (=OFF event). Specify “Enable” for playing an audio file, specified in following “Sound Clip”, when the camera finishes detecting motion (=OFF event).

⑨ Sound Clip

Select an audio file. Refer to P. 1-34, for how to register audio files.

⑩ **Volume**

Set the volume for playing a specified sound clip between 1 and 100. The higher the value, the louder the volume.

⑪ **Automatic Tracking at ON Event**

Select whether to automatically change the camera direction toward a subject during detecting motion (=ON event). Specify "Enable" so that the camera automatically changes its direction toward a moving subject while the camera is detecting the motion.

⑫ **Maximum Tracking Time (sec.)**

Set the time to continue automatic tracking.



Note

The motion detection and external device output functions cannot be used together.



Tip

● The following events can be a trigger in motion detection.

- ON Event
- OFF Event
- Continuous Motion (Time of motion detection)

Following functions can be set when the above items are set to "Enable".

- Upload
- E-mail notification

Settings for upload and e-mail notification are available in the following setting menu.

- Upload : "Upload" → "General Upload" submenu
→ "HTTP Upload" submenu or "FTP Upload" submenu
- E-mail Notification: "Upload" → "E-mail Notification" submenu

When image upload is set to enable in "Upload", images are uploaded according to the settings of the "Image Buffer" submenu in "Event".

Even when neither image upload nor e-mail notification is set to be activated for motion detection events, the following function is available as long as "Motion Detection Event" is set to "Enable".

- Notification of event to clients

Whether to enable or disable audio playback can be specified for each of ON event and OFF event.

- For notes on motion detection use, refer to Start Guide P.xiv.

▼External Device Input

External Device Input ①	External Device Input Event	Enable
External Device Input ②	ON Event Operation	Enable
③	OFF Event Operation	Enable
④	Preset	Preset 1
⑤	Upload	Enable
⑥	E-mail Notification	Enable
⑦	Audio Playback at ON Event	Enable
⑧	Audio Playback at OFF Event	Enable
⑨	Sound Clip	sound2
⑩	Volume 1 - 100	50

① External Device Input Event

Select whether or not to enable image upload and e-mail notification triggered by an external device input event.

② ON Event Operation

Select whether or not to activate preset, image upload and e-mail notification when the camera receives an input signal from external devices (=ON event). Specify “Enable” so that those functions become activated by being triggered by an ON event.

③ OFF Event Operation

Select whether or not to activate preset, image upload and e-mail notification when the camera receives no input signal from external devices (=OFF event). Specify “Enable” so that those functions become activated by being triggered by an OFF event.

④ Preset

Select preset positions from “Preset1” to “Preset20”. When controlling the camera according to events from external devices, first you need to register preset positions using “Preset Setting Tool” of “VBAAdmin Tools” (→ P.2-18), and then specify the corresponding positions from “Preset 1” to “Preset 20”. Specify “None” when you don’t need to control the camera.

⑤ Upload

Specify “Enable” to upload images according to the setting for image buffering, when the camera receives an input signal from external devices.

⑥ E-mail Notification

Select whether or not to upload images by being trigger by an input from external devices. Specify “Enable” to send an e-mail notification based on settings for image buffering, when the camera receives an input signal from external devices. To use this function, you need to configure settings of the “E-mail Notification” submenu in “Upload”.

⑦ Audio Playback at ON Event

Select whether to play audio when the camera receives an input signal from external devices. Specify “Enable” for playing an audio file registered in following “Sound Clip”.

⑧ Audio Playback at OFF Event

Select whether to play audio when the camera receives no input from external devices. Specify “Enable” for playing an audio file registered in following “Sound Clip”.

⑨ Sound Clip

Select an audio file. Refer to P.1-34, for how to register audio files.

⑩ **Volume**

Set the volume for playing a specified sound clip between 1 and 100. The higher the value, the louder the volume.



Tip

The following events can be a trigger.

- ON event
- OFF event

Following functions can be set when the above items are set to “Enable”.

- Upload
- E-mail Notification
- Preset

Settings for the above functions are available in the following setting menu.

- Upload : “Upload” → “General Upload” submenu
→ “HTTP Upload” submenu or “FTP Upload” submenu
- E-mail Notification : “Upload” → “E-mail Notification” submenu
- Preset : VAdmin Tools → Preset Setting Tool
→ “Event” → “External Device Input 1 or2” submenu → “Preset”

When image upload is set to enable in “Upload”, images are uploaded according to the settings of the “Image Buffer” submenu in “Event”.

Even when image upload, e-mail notification and preset are all not set to be activated for external device input events, the following function is available as long as “External Device Input Event” is set to “Enable”.

- Notification of event to clients

Whether to enable or disable audio playback can be specified for each of ON event and OFF event.

▼ **Interval Timer**

Interval Timer	①	Interval Timer Event	Enable
	②	Interval of the Timer	1 min.
	③	Upload	Disable
	④	E-mail Notification	Disable

① **Interval Timer Event**

Select whether enable or disable timer for uploading images and/or e-mail notification.

② **Interval of the Timer**

Select the interval of the timer.

③ **Upload**

Select “Enable” for sending an e-mail notification at the specified time intervals.

④ **E-mail Notification**

Select “Enable” for uploading images at the specified time intervals.



Tip

Interval timer events according to “Interval Timer” can be a trigger in the interval timer.

Following functions can be set when upload and e-mail notification is set to “Enable”.

- Upload
- E-mail notification

Settings for the above functions are available in the following setting menu.

- Upload: “Upload” → “General Upload” submenu
→ “HTTP Upload” submenu or “FTP Upload” submenu
- E-mail Notification: “Upload” → “E-mail Notification” submenu

▼Sound Clip Upload

Sound Clip Upload ①	🔍 Browse File	<input type="text"/>	Browse...	Add
②	🔍 Sound Clip Name <small>Up to 15 characters</small>	<input type="text"/>		Delete

① **Browse File**

Specify an audio file to be uploaded as sound playback.

② **Sound Clip Name**

Name the audio file to be registered (up to 15 characters).

To delete registered files, click “Delete”.



Tip

You can register only audio files, of which playback time is 20 seconds or shorter, and of which file format is “wav.” (μ-law, PCM 8 bits, 8000Hz sampling frequency, mono).

Set User Access Privileges (Access Control)

Access Control

OK

Clear

You can configure following settings.

- **Authorized User Account**

For registering users who can connect to the camera.

- **User Authority**

Configure user privileges for authorized users and guest users.

- **Host Access Restriction**

For specifying hosts from which access is authorized or restricted.

▼ Authorized User Account

The screenshot shows a window titled "Authorized User Account". On the left is a dark sidebar with a "2" icon. The main area is divided into two sections. The top section, labeled "1", contains two input fields: "User Name" (with a note "Up to 8 characters") and "Password" (with a note "Up to 8 characters"). To the right of these fields is an "Add" button. The bottom section, labeled "2", contains a "User List" table. To the right of the table is a "Delete" button and two small arrow buttons (up and down).

① **User Name, Password**

You can add authorized users to the “User List” by entering their user names and passwords and then clicking “Add”.

You can use up to 8 characters, including A-Z, a-z, 0-9 for the user names.

You can use up to 8 ASCII characters (including spaces and other printable characters) for the passwords.

② **User List**

A list of authorized users is displayed. You can set the user authorities for those users. Up to 50 users can be registered, in addition to the Administrator (root).

You can switch the sort the list of these users using ▲ ▼ on the right side.

To remove a user from the list, select the user from the User List and click “Delete”.

▼User Authority

User Authority	Privileged Camera Control	Camera Control	Image Distribution	Audio Distribution
Authorized User	<input checked="" type="checkbox"/>	<input checked="" type="checkbox"/>	<input checked="" type="checkbox"/>	<input type="checkbox"/>
Guest User		<input checked="" type="checkbox"/>	<input checked="" type="checkbox"/>	<input type="checkbox"/>

Privileged Camera Control, Camera Control, Image Distribution, Audio Distribution

Set user privileges for authorized users and guest users, by checking the items.



When recording using optional network video recorder VK, make sure that the “Audio Distribution” box for the authorized user is checked.



Higher privileges can be set to authorized users over guest users.

▼Host Access Restriction

Host Access Restriction	
①	Host List Up to 30 items
②	Apply the list to HTTP Server No
③	Apply the list to Image Distribution No
④	Apply the list to Audio Distribution No

① Host List

The list shows settings for authorized hosts and restricted hosts.

② Apply the list to HTTP Server

Specify “Yes” to apply the host list to HTTP server access. Once applied, some user access will be restricted, such as access to the camera from viewers, access to camera’s top page and access to setting pages. The list is also applied to image distribution and audio distribution.

③ Apply the list to Image Distribution

Specify “Yes” to apply the host list to the image distribution function. You can restrict image distribution from any viewer. The list is also applied to audio distribution.

④ Apply the list to Audio Distribution

Specify “Yes” to apply the host list to the audio distribution function. You can restrict audio distribution and reception from any viewer.



Note

- If there is no Host List, access is permitted to all hosts.
- If the Host List that prohibits access for all hosts is applied, the host restriction function will be disabled and access is permitted to all hosts.
- To prohibit access over the HTTP connection via a proxy server, the address of the proxy server must be set.
- When the Host Access Restriction settings are configured incorrectly, access to the setting pages may be prohibited, and you may have to restore the factory default settings.
- When using the host access control, you cannot connect to the VB-C60 via IPv6.
- If you change the setting of “Host List” or “Apply the list to HTTP Server”, the currently-used browser may become unable to access the camera. Be sure to read the note in the “Setting Items That Require a Reboot” page (→ P.1-43), in advance.



Tip

The Host Restriction function is to restrict hosts, in which viewers and other client applications are running. Access restriction is available with a list including single or multiple entries, described in the following format.

Listing Format

“ ! ” addr “ -addr2 ”

- “addr” is written in the standard IP address format.
- Because the IP addresses in “addr” and “addr2” define the range of IP addresses, if an IP address A is higher than “addr” and lower than “addr2”, the IP address A is included in the addr-addr2 range. The addr2 parameter can be omitted, in which case it is taken to be the same value as addr.
- If the entry begins with “!”, then access will be denied. If not, access will be authorized.
- If an address of host corresponds to more than one entry, the settings for the first corresponding entry from the top of the Host List are used for determining whether access is authorized or restricted. Therefore, note that in the examples 3 to 5 given below the entry of addresses to be authorized must be specified before the addresses to be restricted.
- Redundant or contradictory entries included in the list are automatically deleted.
- If the given address does not belong to any of the entries, access is authorized.

Example 1: To prohibit access from a host

```
!172.20.0.10
```

Access from the host with an IP address of 172.20.0.10 is prohibited.

Example 2: To prohibit access from hosts in a given address range

```
!172.20.0.0-172.20.0.20
```

Access from hosts with IP addresses from 172.20.0.0 to 172.20.0.20 is prohibited.

Example 3: To authorize access from hosts in a given address range while prohibiting access from other hosts

```
172.20.0.10-172.20.0.12
```

```
!0.0.0.0-255.255.255.0
```

Access is only authorized from hosts with IP addresses from 172.20.0.10 to 172.20.0.12 is prohibited.

Example 4: To prohibit access from hosts in a given address range while permitting access from one host within that range

```
172.20.0.10
```

```
!172.20.0.0-172.20.0.20
```

Access from hosts with IP addresses from 172.20.0.0 to 172.20.0.20 is prohibited, except for the host at 172.20.0.10, from which access is permitted.

Example 5: To prohibit access from hosts in a given address range while permitting access from a range of hosts within that range

```
172.20.0.10-172.20.0.15
```

```
!172.20.0.0-172.20.0.20
```

Access from hosts with IP addresses from 172.20.0.0 to 172.20.0.20 is prohibited, except for the hosts with addresses between 172.20.0.10 and 172.20.0.15, from which access is permitted.

Set IPsec (IPsec)

IPsec

■ : Reboot

OK

Clear

You can configure following settings.

- You can set various IPsec settings for up to 5 communications.

▼IPsec Set

There are 5 IPsec Set from 1 to 5, and you can configure the IPsec settings for each communication using each IPsec Set.

IPsec Set 1	①	IPsec	Manual	▼	■
	②	IPsec Mode	Tunnel Mode	▼	■
	③	Destination Address (IPv4/IPv6)	192.168.200.0		■
	④	Source Address (IPv4/IPv6)	192.168.100.1		■
	⑤	Security Protocol	ESP	▼	■
	⑥	Security Gateway Address (IPv4/IPv6)	192.168.10.1		■
	⑦	Destination Prefix Length	24		■

① IPsec

Select whether or not to use IPsec from “Manual” and “Disable”.

② IPsec Mode

Select the IPsec operation mode from “Tunnel Mode” or “Transport Mode”.

③ Destination (IPv4/IPv6)

Enter the destination IP address.

④ Source Address (IPv4/IPv6)

Enter the IP address of the source.

⑤ Security Protocol

Select the IPsec protocol to use from “ESP”, “AH” or “ESP and AH”.

When selecting “ESP”, enter the setting items related to ESP only.

When selecting “AH”, enter the setting items related to AH only.

When selecting “ESP and AH”, enter all of the setting items.

⑥ Security Gateway Address (IPv4/IPv6)

When “Tunnel Mode” is set for ② IPsec Mode, set the IP address of the security gateway.

⑦ Destination Prefix Length

Destination prefix length is required only when “Tunnel Mode” is set for ② IPsec Mode.

Enter the destination prefix length, between 0 and 128.

When using IPv4, enter it between 0 and 32.

- When ⑤ “Security Protocol” is set to “ESP” or “ESP and AH”, the following setting items must be configured.

④	IPsec	Manual	▼	⋮
④	IPsec Mode	Tunnel Mode	▼	⋮
④	Destination Address (IPv4/IPv6)	192.168.200.0		⋮
④	Source Address (IPv4/IPv6)	192.168.100.1		⋮
④	Security Protocol	ESP	▼	⋮
④	Security Gateway Address (IPv4/IPv6)	192.168.10.1		⋮
④	Destination Prefix Length	24		⋮
⑧	SA ESP Encryption Algorithm	AES	▼	⋮
⑨	SA ESP Authentication Algorithm	HMAC_SHA1_96	▼	⋮
⑩	SA ESP Encryption Key (outbound)	0F445981962E9AC7E79385E037C35FC3		⋮
⑪	SA ESP Authentication Key (outbound)	BB64787768DFC8DE7EB4D84EC81B453168F3B32F		⋮
⑫	SA ESP SPI (outbound)	1000		⋮
⑬	SA ESP Encryption Key (inbound)	6F822A37272BF55EB581A91A53770C57		⋮
⑭	SA ESP Authentication Key (inbound)	81E4DC85387FB09192B26CA1A2FBD97202159B96		⋮
⑮	SA ESP SPI (inbound)	2000		⋮

⑧ SA ESP Encryption Algorithm

Select the ESP encryption algorithm from “AES”, “3DES”, “DES” and “NULL” according to the encryption algorithm supported by the destination device.

“AES” or “3DES” is recommended to use normally.

⑨ SA ESP Authentication Algorithm

Select the ESP authentication algorithm from “HMAC_SHA1_96”, “HMAC_MD5_96” and “No Authentication” according to the authentication algorithm supported by the destination device.

If only “ESP” is used, “None” cannot be selected.

⑩ SA ESP Encryption Key (outbound)

Set the SA encryption key for outbound. Set a hexadecimal value that corresponds to 128bit if “AES” is selected in ⑧, 192bit if “3DES” or “64bit if “DES”. If “NULL” is selected, this setting is not necessary.

⑪ SA ESP Authentication Key (outbound)

Set the SA authentication key for outbound. Use a hexadecimal value that corresponds to 160bit if “HMAC_SHA1_96” is selected in ⑨ or 128bit if “HMAC_MD5_96”. If “None” is selected, this setting is not necessary.

⑫ SA ESP SPI (outbound)

Set the SA SPI value for outbound. Set it in the range of 256 - 4294967295.

⑬ SA ESP Encryption Key (inbound)

Set the SA encryption key for inbound. Set a hexadecimal that corresponds to 128bit if “AES” is selected in ⑧, 192bit if “3DES” or “64bit if “DES”. If “NULL” is selected, this setting is not necessary.

⑭ SA ESP Authentication Key (inbound)

Set the SA encryption key for inbound. Set a hexadecimal that corresponds to 160bit if “HMAC_SHA1_96” is selected in ⑨ or 128bit if “HMAC_MD5_96”. If “None” is selected, this setting is not necessary.

⑮ SA ESP SPI (inbound)

Set the SA SPI value for inbound. Set it in the range of 256 - 4294967295. Since the setting value is used as an ID number to identify SA, do not specify the same value as the SPI of another ESP.

■ When “Security Protocol” in ⑤ is set to “AH” or “ESP and AH”, the following setting items must be configured.

	Security Protocol	AH
	Security Gateway Address (IPv4/IPv6)	192.168.10.1
	Destination Prefix Length	24
16	SA AH Authentication Algorithm	HMAC_SHA1_96
17	SA AH Authentication Key (outbound)	6F92282D51B290EA4B51D8833A4EFF295A6E5F40
18	SA AH SPI (outbound)	3000
19	SA AH Authentication Key (inbound)	7E0E6F639A0A81A83B6C5642EFE859881B2883AE
20	SA AH SPI (inbound)	4000

16 SA AH Authentication Algorithm

Select the AH authentication algorithm from “HMAC_SHA1_96” and “HMAC_MD5_96” according to the authentication algorithm supported by the destination device.

17 SA AH Authentication Key (outbound)

Set the SA authentication key for outbound. Set a hexadecimal value that corresponds to 160bit if “HMAC_SHA1_96” is selected in ⑧ or 128bit if “HMAC_MD5_96”.

18 SA AH SPI (outbound)

Set the SA SPI value for outbound. Set it in the range of 256 - 4294967295.

19 SA AH Authentication Key (inbound)

Set the SA authentication key for inbound. Set a hexadecimal value that corresponds to 160bit if “HMAC_SHA1_96” is selected in ⑧ or 128bit if “HMAC_MD5_96”.

20 SA AH SPI (inbound)

Set the SA SPI value for inbound. Set it in the range of 256 - 4294967295. Since the setting value is used as an ID number to identify SA, do not specify the same value as the SPI of another AH.



Note

- In order to operate VB-C60 using IPsec, you need to set communication destinations and the network in advance. For more information on these settings, contact your system administrator.
- If you change the setting of “IPSec”, the currently-used browser may become unable to access the camera. Be sure to read the note in the “Setting Items That Require a Reboot” page (→ P.1-43), in advance.

Setting Items That Require a Reboot (Reboot)

Reboot Item



Reboot

OK

Clear

“Reboot Item” includes setting items that require a reboot after the setting.

- LAN, IPv6, Installation Conditions, MPEG-4, HTTP Server

LAN ①	IP Address Setting	Manual
	IP Address	192.168.100.1
	Subnet Mask	255.255.255.0
	Default Gateway Address	
	LAN Interface	Auto
	Maximum Transmission Unit <small>576 - 1500</small>	1500
IPv6 ②	IPv6	Enable
Installation Conditions ③	Dome	Not used
	Mount	 
MPEG-4 ④	Video Size	320x240
	Capture Frame Rate	30
HTTP Server ⑤	HTTP Port <small>80,1024 - 65535</small>	80

- ① **LAN**
Settings required for LAN connection such as IP address (→ P.1-8)
- ② **IPv6**
Settings for IPv6 use (→ P.1-9)
- ③ **Installation Conditions**
Settings for camera's installation conditions (→ P.1-17)
- ④ **MPEG-4**
Settings for video size and frame rate in MPEG-4 (→ P.1-19)
- ⑤ **HTTP Server**
Setting of the HTTP port number (→ P.1-28)

The following dialog box appears to alert after changing some values for the network settings, with which the currently-used browser may become unable to access to the camera.

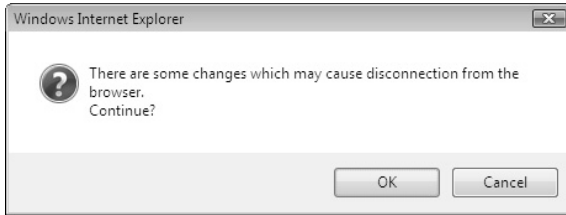

Click "OK" to apply the setting change.

After the camera is rebooted, a candidate URI(s) with which you can connect to the camera is displayed.



When reconnecting to the camera, use the displayed URI.

If you cannot connect to the camera using the displayed URI, contact your administrator.

* The settings in "Reboot Item", which are related network settings, include "IP Address", "Subnet Mask", "Default Gateway Address" and "HTTP Port".

Display Event Log and Current Settings, Execute Maintenance (Maintenance)

Maintenance

■ : Reboot

You can configure following settings.

● Tool

For displaying and initializing the camera's settings.

▼Tool

Tool	①	View Log Events	View	
	②	View Current Settings	View	
	③	Reboot	Reboot	■
	④	Restore Settings	Restore	■

① View Log Events

Display a log file, showing the camera's operation and connection with viewers (→ P. 2-36).

② View Current Settings

Display a list of current settings.

③ Reboot

Reboot the camera.

④ Restore Settings

All settings will be restored to the factory default settings, except camera's administrator password, IP address, subnet mask, default gateway address, date and time, time zone, LAN interface, maximum transmission unit, and IPv6 use. The camera will be automatically rebooted after the restoring process.



Note

Do not turn off the camera while it is restoring the settings, otherwise the camera may not operate properly.



Tip

- It is recommended that you make a note of the current settings before you restore the factory default settings in "Restore the Factory Default Settings" (→ P.5-14)
- The camera's Reset switch can also be used to restore the factory default settings, but note that this will reset all settings (→ P.5-15).

Chapter



VBAAdmin Tools

This chapter describes how to set up cameras using VBAAdmin Tools. You can create panoramas, set a view restriction, presets and motion detection, view logs, and launch the Admin Viewer. You should configure detailed settings as described in Chapter 1 in advance.



Overview of VBAAdmin Tools

VBAAdmin Tools comprises of “VBAAdmin Tools” and applications that you can start from the tool such as “Panorama Creation Tool”, “View Restriction Tool”, “Preset Setting Tool”, “Motion Detection Tool”, “Log Viewer” and “Admin Viewer”. You can easily configure the settings of VB-C60, view images with special privileges, check the operation status and retrieve logs from a remote location via networks.

VBAAdmin Tools (→ P.2-4)

This is the main panel of VBAAdmin Tools. Each tool is started up from this panel. Install VBAAdmin Tools first from the supplied CD-ROM. (→ Start Guide P.2-4)

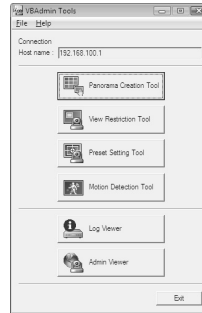

Panorama Creation Tool (→ P.2-6)

This tool is used to capture/create a panorama image displaying the full view of the area covered by VB-C60. Once you capture and register a panorama image, the image is displayed in the Panorama Display Area in the VB-C60 viewer. You can see, at a glance, which part of the entire viewing area is currently covered by the configured area when configuring a view restriction and presets.

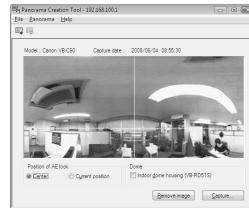

View Restriction Tool (→ P.2-11)

This tool enables you to set view restrictions visually. View restrictions can be set by operating the mouse while referring to a panoramic preview.

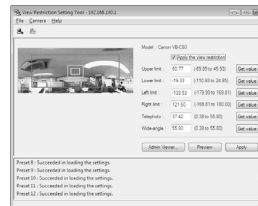

Preset Setting Tool (→ P.2-18)

This tool enables you to set presets and home positions visually. Presets can be set by operating the mouse while referring to a panoramic preview. You can also configure the settings of “Preset Tour”, which tours through multiple presets to monitor.

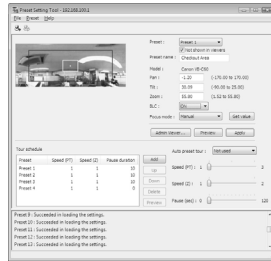

Motion Detection Tool (→ P.2-27)

This tool is to set up motion detection function, which uploads images, notifies to viewers and logs events, when the captured object moves, causing a change to occur in the video image. You can set the position and size of motion detection areas, and the conditions to judge the timing of motion detection with viewing the video from the camera.

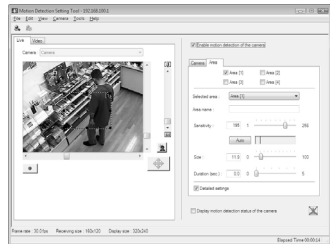

Log Viewer (→ P.2-36)

This viewer enables viewing of operation status logs output to VB-C60.

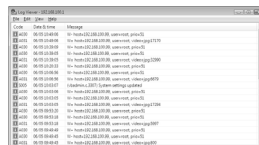

Admin Viewer (→ P.3-5)

This viewer is for the administrator of VB-C60. It offers special functions that are not included in the VB Viewer, such as Camera Control, Exposure, White Balance and External Device Output.



Start Up VAdmin Tools

To Start Up...

1. Double-click “VAdmin Tools v4.0” desktop icon or select “WebView Livescope” → “VAdmin Tools v4.0” from Programs in the Start menu bar to start up the VAdmin Tools

Starting up from the desktop icon



Starting from the Start menu bar



2. Connection Setting dialog appears

To use VAdmin Tools, it should first be connected to VB-C60. Enter connection settings and click “OK”.

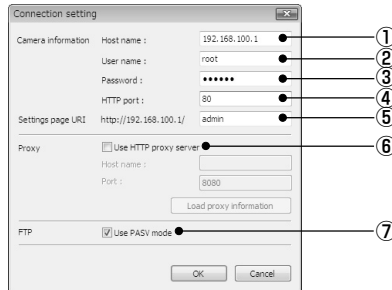

① Host name (→ P.1-8)

Specify IP address or host name of VB-C60.

② User name

Enter default Administrator account “root” for VB-C60.

③ Password (→ P.1-7)

Enter Administrator password. (The factory default setting is “VB-C60” for both the VB-C60 and VB-C60B.)

④ HTTP port (→ P.1-28)

Default setting is “80”.

⑤ Settings page URI

Enter “admin” as the administrator URI. (This cannot be changed.)

⑥ Proxy

*For the proxy setting, contact your network administrator.

●Use HTTP proxy server

Check it when connecting to VB-C60 via proxy server.

●Host name

Specify the IP address or host name of proxy server.

●Port number

Enter port number of proxy server. (The default is “8080”).

●Load proxy information

When checked, the proxy server information set in Internet Explorer is automatically retrieved.

⑦ FTP

To use the Panorama Creation Tool and the Log Viewer of the VAdmin Tools, it is necessary to connect to VB-C60 using FTP. The FTP connection mode can be selected from the PASV mode or PORT mode.

●Use PASV mode

Check it when selecting the PASV mode. Normally, select PASV mode. Clear the check box when using PORT mode.

3. A confirmation message is displayed

Click "OK".

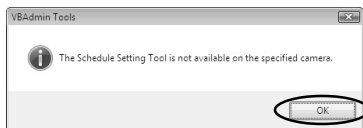

4. VAdmin Tools starts

You can start the Panorama Creation Tool, View Restriction Tool, Preset Setting Tool, Motion Detection Tool, Log Viewer or Admin Viewer by clicking the button for each tool.

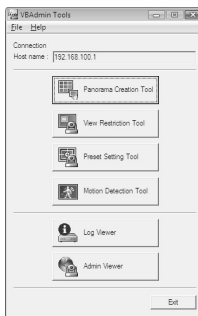

When the camera is disconnected after start up, select "Connect" from the File menu bar to display the Connection Setting dialog.

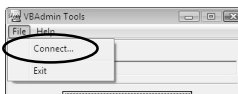

Note on Windows Vista/XP

Note

If you start up VB Initial Setup Tool on Windows Vista/XP, Windows Security Alert dialog may appear. If the dialog appears, click "Unblock". Once you click "Unblock", the dialog box will not appear again.



Note

If connecting to the camera with specifying IPv6 address, you cannot use Admin Viewers with Internet Explorer.



Tip

- Panorama Creation Tool, View Restriction Tool, Preset Setting Tool and Motion Detection Tool cannot be launched simultaneously. Log Viewer and Admin Viewer can be launched simultaneously.
- When connecting to another Canon network camera other than VB-C60, you may not be able to use some of the tools.

Panorama Creation Tool

This tool is used to create a panorama image displaying the full view of the area covered by VB-C60. When using VB-C60 Viewer to perform pan, tilt, or zoom as well as define presets, you can see, at a glance, which part of the entire viewing area is currently covered.

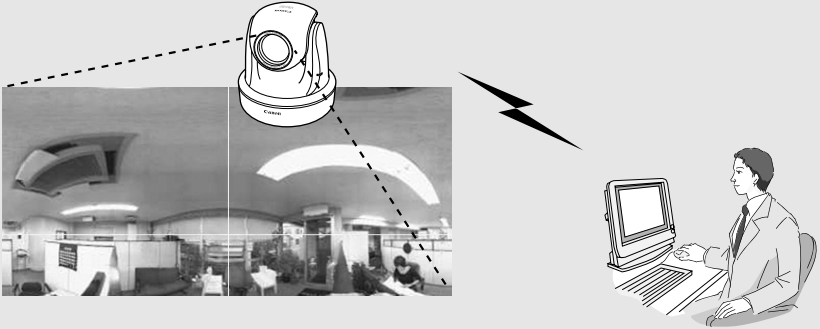

Panorama Creation Tool is used to take and create panorama image and register them in VB-C60.



Admin Viewer



Preset Setting Tool

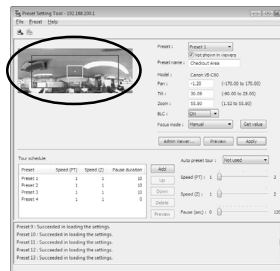

You can see, at a glance, where the region currently being set is located within the entire area.

Panorama Creation Tool Display Screen

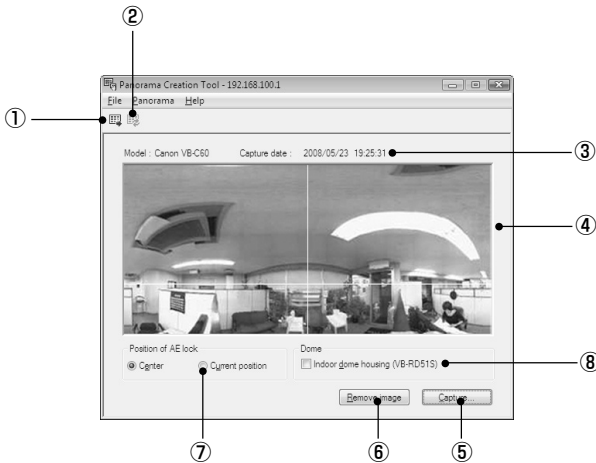

① **Show Registered Panorama Image button**

Displays panorama image registered in VB-C60.

② **Register Panorama Image button**

Register panorama image currently displayed in panorama creation tool.

③ **Display Camera model and Capture Date**

Displays the model of camera currently connected and the date when the panorama image was captured, if it has already been captured.

④ **Display Panorama image**

Displays the panorama image that was captured.

⑤ **Capture button**

Captures panorama image.

⑥ **Remove Image button**

Delete a captured panorama image.

⑦ **Position of AE Lock**

Switch the AE lock position between the center of the panorama image and current camera position. The AE lock function is used to capture image based on exposure level set on the specified position.

⑧ **Indoor dome housing (VB-RD51S)**

Check this option to prevent VB-C60 from capturing areas obstructed by the optional indoor dome housing (VB-RD51S).

Capture Panorama Image

How To Capture

1. Click “Capture” to start capturing

Change the AE lock position as required.

Check the Indoor dome housing (VB-RD51S) option if you are using the optional indoor dome housing.

To stop capturing while it is in progress, click “Stop”.

2. After capturing is completed, click “OK” to accept the image

To capture the image again, click “Recapture”. Or, a square section in the displayed grid can be captured again by double-clicking on that section. Click “Cancel” to discard the captured image.

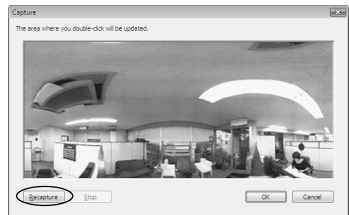
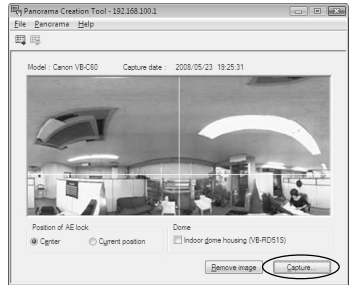

Note

Image Stabilizer is canceled temporarily, while Panorama Creation Tool is capturing an image.

Register/Delete Panorama Image

After capturing a panorama image, send it to VB-C60 and register it to reflect the image.

To “Register” the Panorama Image ...

Click “Register Panorama Image”

Panorama image is registered.



To Delete...

Click “Remove Image” and then click “Resister Panorama Image”

The panorama image registered in VB-C60 is deleted.



Tip

After registering the panorama image, VB-C60 automatically reboots and disconnects from the VB Admin Tools. A dialog box asking whether or not to reconnect to VB-C60 appears after VB-C60 restarts. Click “OK” to reconnect to the camera.

Reconnect

Reconnections when a connection with VB-C60 has been cut.

How To Reconnect

Select “Reconnect” from the File menu bar

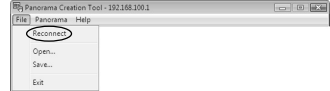

Open/Save Panorama Image from/to Image File

You can open an image file as a panorama image, or save a panorama image as an image file. Only JPEG format images created by the Panorama Creation Tool can be used.

How To Open

Select “Open” from the File menu bar and select the desired image file in the displayed dialog



How To Save

Select “Save” from the File menu bar and select a folder to save the image, then enter its file name



View Restriction Tool

View Restriction Tool is to restrict the area where the camera can capture. Once you set the view restriction, you can limit the area, within which VB-C60 viewer can display.

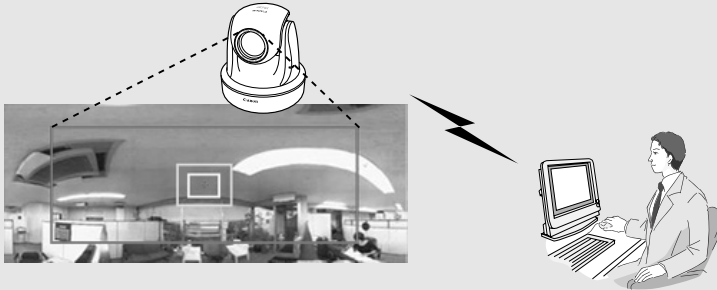

View Restriction Tool lets you easily set view restrictions in cases where you want to set restrictions on zoom or a portion of the field of view when videos are distributed live or in other such instances.

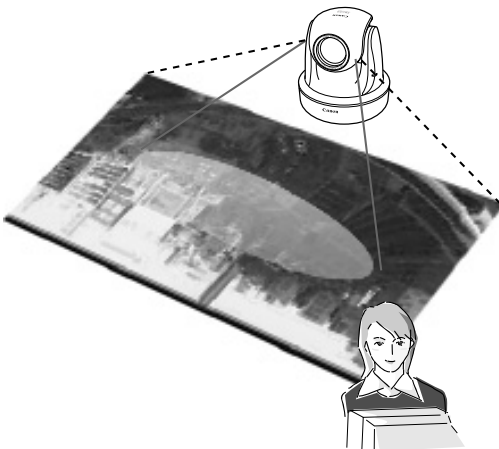
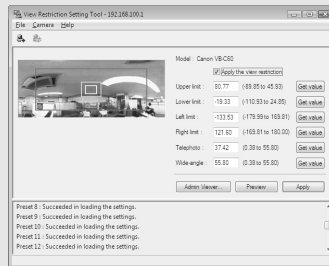

[Limitations by view restriction settings]

Limitations set by View Restriction Tool become available in the following cases.

- When a user access to the Admin viewer with an authorized user authority.
- When accessing to the VB viewer.

View Restriction Tool Display Screen

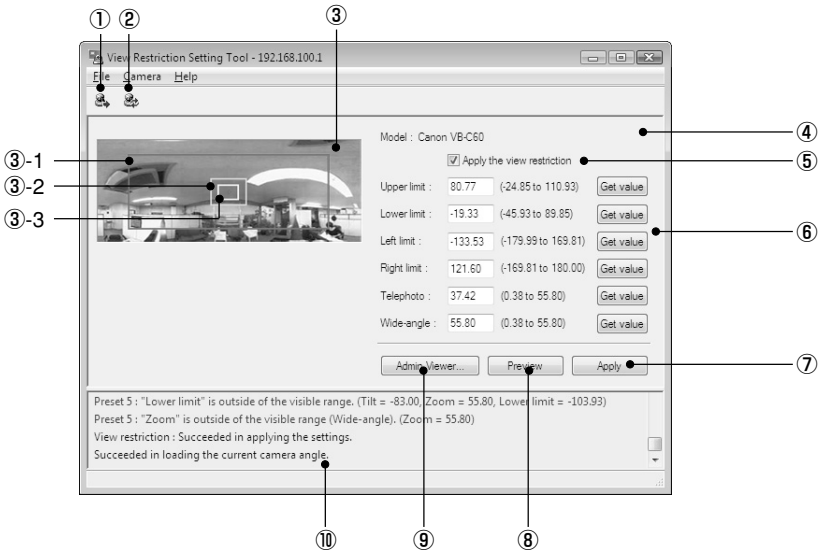

① Load View Restriction button

Loads the view restriction values currently set in VB-C60.

② Save View Restriction button

Saves the view restriction values set and applied using this Tool to VB-C60.

After setting the view restriction, be sure to click “Save View Restriction” to save the setting values to VB-C60.

③ Panorama Preview

Displays the panorama image registered in VB-C60. A View Restriction preview frame, which is recreated with the setting values, is displayed. You can, by dragging with the mouse, change the shape of or move the frame which will then be reflected in the View Restriction setting values.

●View Restriction Preview Frame

- ③-1 Pan/Tilt Preview Frame (red) : Upper/Lower/Left/Right values of view restriction area
- ③-2 Wide-angle Preview Frame (green) : Zoom field of view (wide angle) restriction area
- ③-3 Telephoto Preview Frame (yellow) : Zoom field of view (telephoto) restriction area

④ Model

Displays the model of the camera that is currently connected.

⑤ Apply the view restriction

Check the checkbox to enable the view restriction area.

⑥ View Restriction Value Input boxes and Get value button

You can change the values by entering numeric values in the View Restriction Value Input boxes. You can retrieve the current camera angle into each setting values by clicking “Get value”.

●View restriction setting values

Upper value .. Value for the upper limit of the view restriction. The upper value of the selected camera angle is obtained using the “Get value” button.

Lower value .. Value for the lower limit of the view restriction. The lower value of the selected camera angle is obtained using the “Get value” button.

Left value Value for the left limit of the view restriction. The left value of the selected camera angle is obtained using the “Get value” button.

Right value Value for the right limit of the view restriction. The right value of the selected camera angle is obtained using the “Get value” button.

Telephoto Value for the telephoto limit of the view restriction The zoom value of the selected camera angle is obtained using the “Get value” button.

Wide-angle Value for the wide-angle limit of the view restriction. The zoom value of the selected camera angle is obtained using the “Get value” button.

⑦ Apply button

Uses this button to apply the current view restriction settings to VB-C60. Using this button does not save the values to VB-C60. Be sure to use “Save View Restriction”.

⑧ Preview button

Uses this button to reflect the values in the View Restriction Value Input boxes to the View Restriction Preview frame.

⑨ Admin Viewer button

Starts the Admin Viewer.

⑩ Status List

Displays the results of operation of this tool. Warning messages are displayed in blue and error messages are displayed in red.



Note

Clicking “Apply” does not save the edited values to VB-C60. Click “Save View Restriction” to enable the changed values.

Set View Restrictions

You can change the view restriction values by entering numeric values in the View Restriction Value Input boxes or using the camera angles from the View Restriction Preview Frame or Admin Viewer. Select a suitable method according to your preference or environment.

■ Change Setting Values from the View Restriction Preview Frame

Use the preview frame on the panorama image to set the view restriction.

To Make Settings

1. Check the “Apply the view restriction” check box
2. Modify the shape of the “Pan/Tilt Preview Frame (red)”, “Telephoto Preview Frame (yellow)” or “Wide-angle Preview Frame (green)” displayed on the panorama image to set the view restrictions

When enlarging or reducing the Telephoto Preview and Wide-angle Preview frames, the vertical/horizontal ratio is fixed.

You can also enter numeric values in the View Restriction Value Input boxes.

3. Click “Apply”

Confirm that the values are applied correctly in the Status List and click “Save View Restriction” to save the values to VB-C60.

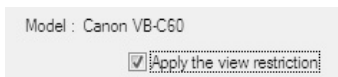

■ Retrieve Values from the Camera Angle of the Admin Viewer and Change Settings

Launch Admin Viewer and set the view restriction while checking the position in the image.

How To Make Settings

1. Check the “Apply the view restriction” check box
2. Click “Admin Viewer” to launch Admin Viewer
If accessing to Admin Viewer, you should make user authentication (→ P.xiii)
3. Click “Obtain/release Camera Control” in Admin Viewer to obtain the camera control rights

Obtain/release Camera Control button



4. Change camera angle to the position you want to set with the Upper, Lower, Left, Right, Telephoto, and Wide-angle values, and then click “Get value” for each setting

You can confirm the retrieved values in the View Restriction Value Input boxes or View Restriction Preview frame.

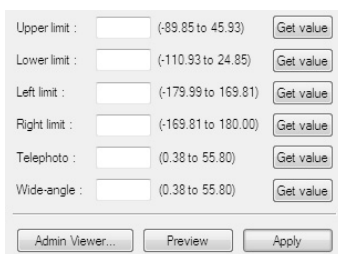

5. Click “Apply”

Confirm that the values are applied correctly in the Status List and click “Save View Restriction” to save the values to VB-C60.





Note

- When changing settings for camera's installation conditions, you need to recapture a panorama image and register again.
- Panorama Preview may be slightly different from the actual picture. You need to check if the view restrictions are correctly reflected in VB Viewer after the view restrictions have been set.
- You should use VB Viewer when confirming the setting. (view restriction is not applied in Admin Viewer.)
- If changing the setting of Image Stabilizer after View Restriction settings, the view restriction area may be different between when it is set and when it is actually used (→ P.3-20).
- When changing Image Stabilizer or Digital Zoom setting, you need to reconfirm the view restriction.



Tip

- Even when view restriction is set, if the camera is controlled to capture near the boundary of the view restrictions, the restricted area may be momentarily captured.
- To release view restriction, clear the "Apply the view restriction" check box and then click "Apply" and "Save View Restriction".
- When the value is blank while "Apply the view restriction" is checked, the maximum view restriction value is used.
- The controllable area and captured area are as follows:

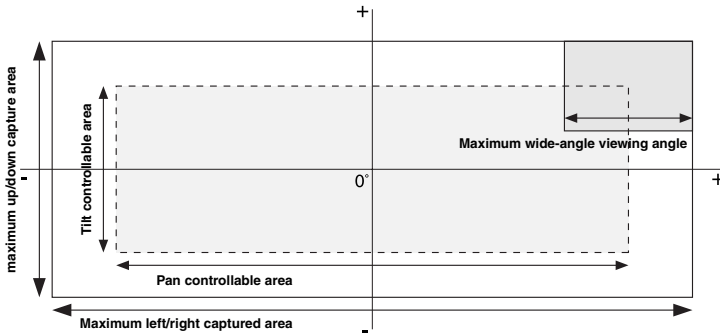

- The pan and tile area depending on the zoom rate (viewing angle).

When the view restriction is set, the camera operation angle is automatically restricted.

When a wide-angle is used without changing the camera operation angle, the view restriction is violated, and therefore the operation angle is automatically narrowed.

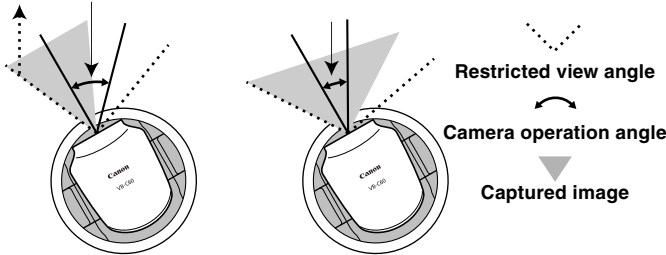

When zooming out using a wide-angle violates the view restriction, the camera direction (pan/tilt) is automatically adjusted.

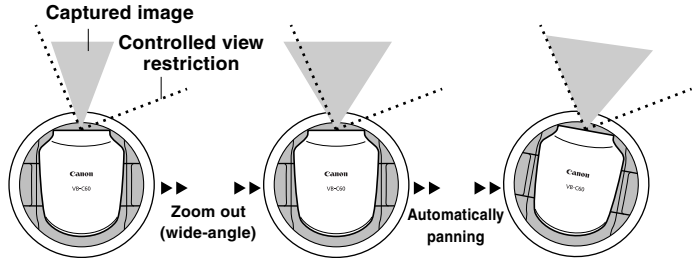

- When you narrow the area to be covered, the zoom area may also be narrowed.

Preset Setting Tool

This tool enables you to easily set presets and home positions visually. They can be set by operating the mouse while referring to a panoramic preview. You can also set the “Preset Tour” settings, which tours through multiple presets to monitor.

The diagram illustrates the process of setting up a camera for a preset tour. On the left, a camera is shown with a dashed line pointing to a panoramic preview of a city street with a large 'ODAKYU' sign. A lightning bolt symbol indicates a transition to a user sitting at a computer. The computer screen displays the 'Preset Setting Tool' interface, which includes a 'Preset' dropdown menu, a 'Preset Name' field, and various numerical settings for 'Home', 'Start', 'TR', 'Stop', and 'D.C.'. Below these are 'Update camera', 'Preview', and 'Apply' buttons. A 'Tour schedule' table is also visible, listing preset names, speeds, and durations. At the bottom of the window, there are status messages indicating successful loading of settings for various presets.

After setting presets, set Preset Tour

Preset	Speed (PT)	Speed (D)	Pause duration	Auto preset tour	Use speed
Preset 1	1	1	00	On	1
Preset 2	1	1	00	On	2
Preset 3	1	1	00	On	2
Preset 4	1	1	00	On	2

Reflecting to VB-C60 Viewer



Performing Preset Tour

Preset Setting Tool Display Screen

The display screen for Preset Setting Tool is divided into “Preset Settings Area” and “Preset Tour Settings Area”. You can set up to 20 presets and home position while referring to a panoramic preview in the Preset Setting Area. You can set “Preset Tour” settings, which tours through multiple presets to monitor, in the Preset Tour Setting Area.

Explanation below is a description of the “Preset Setting Area” screen.

For more information on the Preset Tour Setting Area, see “Preset Tour” (→ P.2-24).

■ Preset Setting Tool Display Screen

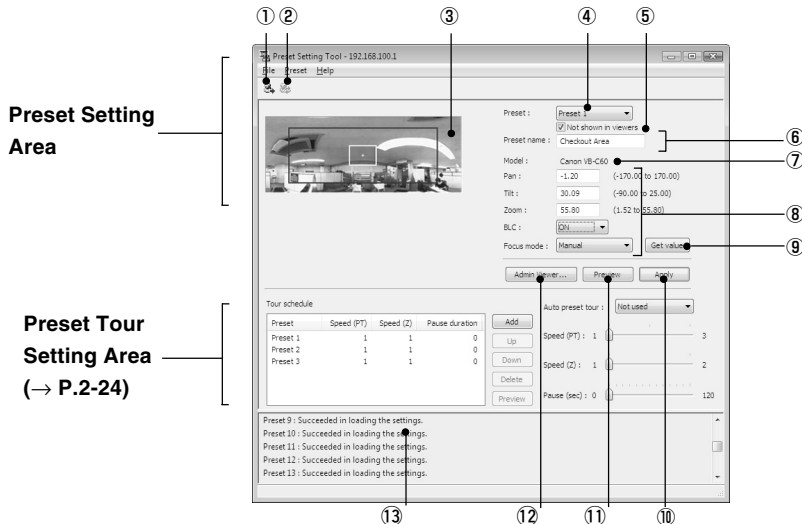

① Load Preset Settings button

Loads preset settings currently set in VB-C60.

② Save Preset Settings button

Saves preset settings which is set and applied with this Tool to VB-C60.

After setting the presets, be sure to click “Save Preset Settings” to save the settings.

③ Panorama Preview

Displays the panorama image registered in VB-C60. A yellow Preset Preview frame shows the location of the Preset Setting. By dragging it with the mouse, you can change the size of frame or move the frame which will then be reflected in the Preset settings.

④ Preset Selection Box

Select preset or home position to set.

⑤ Not shown in viewers

Uncheck this option if you are using presets from VB-C60 Viewer. If you select “Home Position” in the Preset Selection box, this setting will be grayed out (setting not possible).

⑥ Preset name

Be sure to enter a preset name. The preset name field is grayed out and cannot be entered when “Home position” is selected in Preset Selection Box. Enter each preset name with 15 or less alphanumeric characters, including spaces and printable characters.

⑦ Model

The model of the camera that is currently connected is displayed.

⑧ Camera Parameters

Use “Pan” and “Tilt” to specify the central angle for the pan and tilt ranges you want set. Use “Zoom” to enter the angle for the field of view.

● Camera Angle

Pan Sets pan position of the camera.

Tilt Set tilt position of the camera.

Zoom Sets angle of view of the camera.

● BLC

Set the backlight compensation for the camera. Select “Off” or “On”.

● Focus

Set focus mode for the camera. Select from “Auto”, “Fixed at infinity” or “Manual” (→ P.3-24).

⑨ Get value button

When “Get value” is clicked, the current angle and focus position (for Manual mode) of VB-C60 is retrieved as camera parameters.

⑩ Apply button

The current settings of preset and preset tour are applied to the VB-C60.

⑪ Preview button

Settings of the camera parameters are reflected in the Preset Preview Frame. The camera angle of VB-C60 is also switched based on this preset, which can be confirmed in the Admin Viewer.

⑫ Admin Viewer button

Starts the Admin Viewer.

Use this button to set presets while watching the actual video image via Admin Viewer.

Set the camera toward the position with which the preset is set, click “Get value” and then click “Apply” to set the preset.

⑬ Status List

Displays the results of communications between this tool and VB-C60.

Warning messages are displayed in blue and error messages are displayed in red.



Clicking “Apply” does not save the edited settings to VB-C60. After editing the settings, be sure to click “Save Preset Settings” to save the settings to VB-C60.

Set Presets

Presets can be set using either of the following two methods. Select a suitable method according to your preference or environment.



If you use presets in VB-C60, uncheck the “Not shown in Viewers” option.

■ Change Settings from Preset Preview Frame

Use the preview frame on the panorama image to set presets.

How To Make Settings

1. Select preset from the Preset Selection box and enter preset name

You should enter a preset name for the selected preset.

2. Drag the Preset Preview frame shown on the panorama image to move or change its shape and set the preset

When you click on a spot in the image, the center of the Preview frame moves to the clicked position.

At this point, you can also adjust the setting position by editing the values in the camera parameters.



3. Click “Apply”

Check the Status List to make sure that the values are applied correctly and click “Save Preset Settings” to save the values to VB-C60.

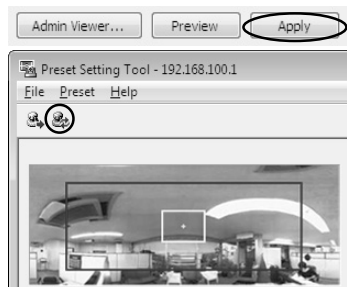

■ Change the Settings from Admin Viewer's Camera Angle

Launch Admin Viewer and set the camera angle as a preset.

To Make Settings...

1. Select a preset from the Preset Selection box and enter the preset name

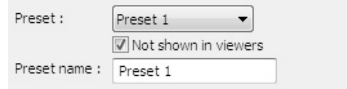

2. Click "Admin Viewer" to launch the Admin Viewer
If accessing to Admin Viewer, you should make user authentication (→ P.xiii)



3. Click "Obtain/release Camera Control" in Admin Viewer to obtain the camera control



4. Operate the camera at a desired position and then click "Get value"

The retrieved values can be checked with the camera parameter or in the Preset Preview frame.

At this point, you can also adjust the setting position by editing the values in the camera parameters.

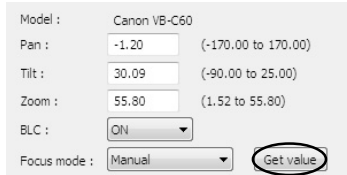

5. Click "Apply"

Check the Status List to make sure that the values are applied correctly and click "Save Preset Settings" to save the values to VB-C60.

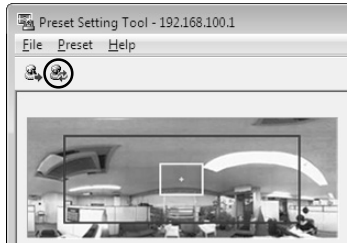



Note

- The Panorama Preview may be slightly different from the actual image. After setting the presets, make sure that the presets are correctly reflected in the Admin Viewer.
- When using the manual focus, adjust the focus manually while watching the video via the Admin Viewer. After manual focusing completes, click “Get value” to set the preset.
- When changing the Image Stabilizer setting, after setting the preset.
- When using a dome housing, set the preset while the dome is installed.
- When changing settings for camera’s installation conditions, you need to renew the settings of preset.



Tip

- You can set up to 20 presets.
- Changes in the preset settings are not applied to the viewer while it is connected.
- If you check “Not shown in Viewers” (→ P.2-19), you can prevent presets from being used in VB-C60.
- Preset positions cannot be set in the digital zoom area.
- You can set multiple presets and save them at once using “Save Preset Settings”.

Preset Tour

You can set “Preset Tour” to monitor multiple presets that have already been set.

■ Preset Tour Setting Area Display Screen

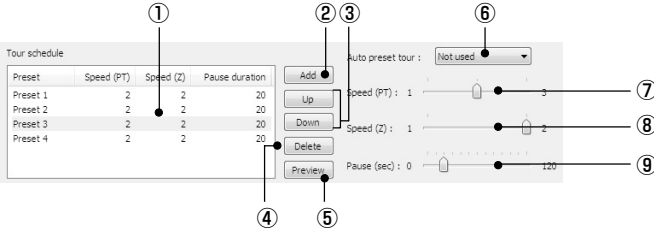

① Tour Schedule list

Displays a list of presets which are set for Preset Tour.

② Add button

Adds a preset to the Tour Schedule list.

③ Up/Down buttons

Select a preset in the list and click “Up” or “Down” to change the Preset Tour order. The Preset Tour commences from the preset at the top of the list.

④ Delete button

Deletes the selected preset.

⑤ Preview button

Reflects the settings for the selected preset in the Preset Preview frame. The camera angle of VB-C60 is also switched based on this preset, which can be confirmed in the Admin Viewer.

⑥ Auto preset tour

Select an option for the Preset Tour from the following.

Not used

Preset Tour is not performed.

For viewers

Preset Tour is performed when the camera is connected with VB-C60 Viewer or another viewer.

Always

Preset Tour is always performed.

⑦ Speed (PT)

Sets the speed at which the camera moves when panning and tilting, within a range of 1-3. Scrolling the slide bar from left to right increases the value and speed.

⑧ **Speed (Z)**

Sets the camera speed for zooming within a range of 1-2. Scrolling the slide bar from left to right increases the value and speed.

⑨ **Pause (sec.)**

Set the time duration to pause the camera at the preset position in the range of 0-120 seconds in increments of 5 seconds.



When the following warning message appears, you may need to change the settings by referring to the following table.

Example of warning message

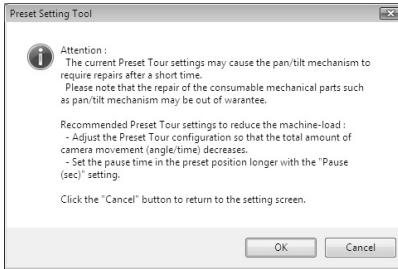

*The tour schedule shown in the screen changes depending on the setting.

Press Cancel to return to the setting screen.

Press OK to save the setting data without changing it.

(When using the Preset Setting Tool, click "Save" in the setting page.)

The standard durability of the pan/tilt mechanism is 300,000 round trips at full angle operation. The entire tour time is determined by the combination of movement speed, movement range and pause duration. Refer to the following tables for the settings.

Total tour hours (guideline) of Preset Tour in the panning direction until reaching to 300,000 round trips

Setting Speed (PT) to 1

Pause (sec.)	Pan Direction Movement Range (degree)		
	±50	±100	±150
0	11616	11475	11427
10	17000	14166	13222
20	22666	17000	15111
30	28333	19833	17000

(Unit: hour)

Setting Speed (PT) to 2

Pause (sec.)	Pan Direction Movement Range (degree)		
	±50	±100	±150
0	5950	5808	5761
10	11333	8500	7555
20	17000	11333	9444
30	22666	14166	11333

(Unit: hour)

Example: When Speed (PT) is 1, Pause is 30 seconds and Pan Direction Movement Range (angle) is ±50, 300,000 round trips are completed in 28,333 hours.



- Preset Tour is not performed when the camera is controlled with VB-C60 Viewer or another viewer.
- Preset Tour does not work while VK-64/VK-16 (option), VK-Lite or Motion detection Tool is connecting with the camera.

■ Set Preset Tour

To Make Settings...

1. Select the tour method from “Auto preset tour”

Select either “For viewers” or “Always”.

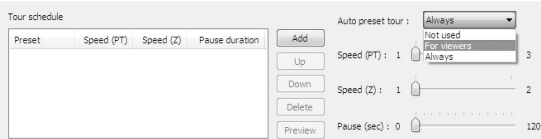

2. Select the preset number to add in the Tour Schedule from “Presets” in the Preset Setting area and click “Add”

The preset is registered in the Tour Schedule list. You can register up to 20 presets.

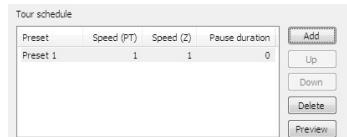

3. Select a preset from the Tour Schedule list and set the speed of panning, tilting and zooming and the duration (sec.) to pause at the preset position for each preset using the slide bar for “Speed (PT)”, “Speed (Z)” and “Pause (sec.)”

Click “Preview” to reflect the setting values for the selected preset in the Preset Preview frame. The camera angle is switched based on this preset, which can be confirmed in the Admin viewer.



4. Click “Apply”

Check the Status List to make sure that the values are applied correctly and click “Save Preset Settings” to save the values to VB-C60.

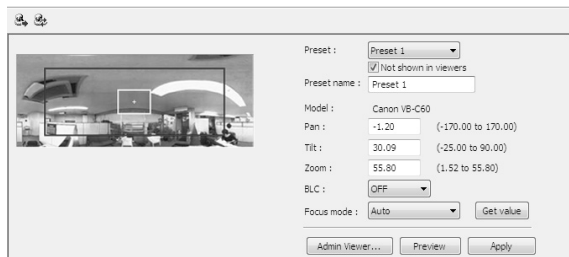

Note When using Preset Tour, do not use the Motion Detection function.
When Day/Night is set to Auto, the camera may pause longer than your setting.



Tip The home position cannot be added to the Tour schedule list.

Motion Detection Setting Tool

This tool is to set up motion detection function, which uploads images, notifies to viewers and logs events, when the captured object moves, causing a change to occur in the video image. You can set the position and size of motion detection areas, and the conditions to judge the timing of motion detection with viewing the video from the camera.



Setting Motion Detection easily using Motion Detection Setting tool

The levels of motion detection determine how great the variation must be (sensitivity), how large the changed area must be as a proportion of the whole detection area (proportion), and how long the variation must continue (duration) before it is recognized as motion and the specified action is performed.



Notes on Using This Function

The Motion Detection function is not suitable for conditions where high reliability is required. It is not recommend using this function in situations where high reliability is required, such as for monitoring purposes. Canon accepts no liability whatsoever for faults, etc. resulting from the use of the Motion Detection.

■ Motion Detection Setting Tool Display Screen (Live Mode)

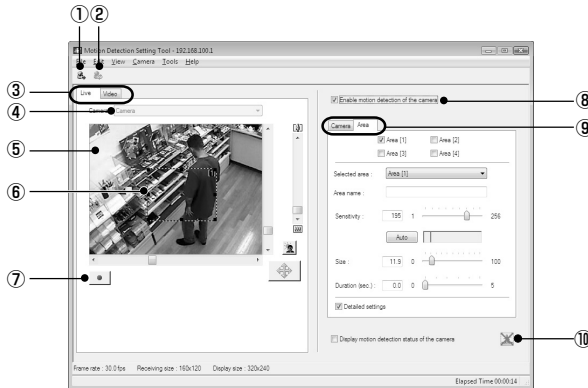

① Load Motion Detection button

Loads the motion detection settings of VB-C60.

② Save Motion Detection button

Saves the current motion detection settings edited with this tool.

After setting the motion detection, be sure to use “Save Motion Detection” to save the setting values to VB-C60.

③ Live Mode tab (Live/Recorded Video)

● Live

Displays the video image and controls the camera. You can also record the displayed video image.

● Video

You can set the conditions to judge the timing of motion detection with playing video from the camera. For information on the screen display and how to operate them, see P.2-35.

④ Camera Selection box

Displays the name of the camera that is currently connected.

⑤ Viewer

Displays the video image and controls the camera.

⑥ Motion detection area frame

Shows the area covered by the motion detection with a dotted-line frame. The frame can be resized and moved by the dragging the mouse.

⑦ Rec. Start button

Starts recording of the video.

⑧ Enable motion detection of the camera

Check this option to enable the Motion Detection function.

9 Setting tab (Camera/Area)

● Camera tab

Set the frame rate and preset position (→ P.2-30).

● Area tab

Select the area for which the motion detection is enabled and set the sensitivity, size and duration for each area. For detailed information on the screen display and how to operate them, see P.2-31.

10 Display motion detection status of the camera

Check the checkbox to display the motion detection status. You can check if the setting values are valid for the camera (→ P.2-32).

■ Motion Detection Settings Procedure

This section briefly describes the of motion detection setting procedure. For more details of settings, refer to each reference page.

1. Start Motion Detection Setting Tool

The Motion Detection Setting Tool window is displayed (“Motion Detection Tool Display Screen” (→ P.2-28)). Settings for motion detection are available in the Setting tab on the right side of the screen. There are two setting tabs available: “Camera” tab and “Area” tab.

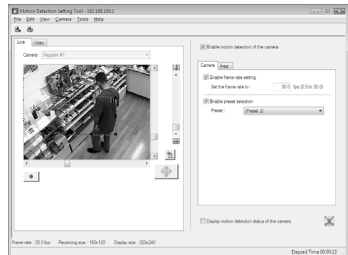

2. Set the frame rate and camera direction (“Camera” tab → P.2-30)

3. Set the detection area (“Area” tab → P.2-31)

4. Set the conditions to judge of motion detection at what degree of change in video, motion is detected (“Area” tab → P.2-31)

5. Save the settings



Tip

- Video is displayed in 160x120 and black and white in the viewer of Motion Detection Setting Tool, regardless of settings of the camera.
- In the “Area” tab, you can set the conditions to judge the timing of motion detection with viewing the video from the camera. For information on the display screen, see ““Detected” status and Screen Display” (→ P.2-34). In the “Video” tab, you can set the conditions of judgment with viewing video recorded in “Live” tab (→ P.2-35).
- Motion Detection function
 - When setting for motion detection, be sure to test the actual performance and check if it properly detects motion.
 - Please note that motion detection may not work properly when capturing rapidly moving subjects or in dark conditions.
 - Motion detection may wrongly detect motion because of light, wind or other changes in the subject.

■ Set Up Motion Detection

How To Set up

1. Enable motion detection

Check the “Enable motion detection of the camera” check box.

2. Set the frame rate and camera position (“Camera” tab)

Set the camera’s frame rate and position.

The camera position can be set to a desired position using the viewer for live video, or you can select a preset in the “Camera” tab.

You need to set the preset settings using Preset Setting Tool in advance (→ P.2-21).

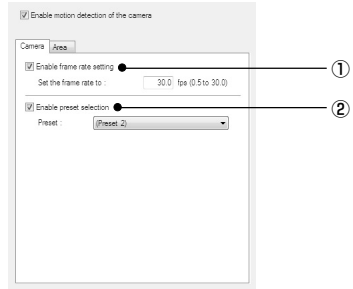

① Enable frame rate setting

Check the checkbox, so that you can set the frame rate value for motion detection. Enter the value in the range of 0.5-30.0 fps.

② Enable preset selection

Check the checkbox, so that you can select a preset for the camera position.



The setting value of “Maximum Frame Rate: Image Transmission (→ P.1-19)” should be larger than the frame rate set in this tool.



- The set frame rate may not be achieved when the network is overloaded.
- When a lower frame rate is set, the motion detection is applied to images extracted from the captured video. This enables detecting of objects in slow motion.
- The frame rate set here is applied to the motion detection only.
- Presets, which are set out of the view restriction area, are not displayed in the preset list.

3. Set the detection area (“Area” tab)

Up to 4 detection areas can be created. Each area can be resized and moved by dragging the frame. To resize the frame, drag “■” on four corners of the frame. To move the frame, drag the frame by clicking in the frame. You need to set the sensitivity for each area separately. With VB-C60, you can adjust the motion detection sensitivity with viewing video, recorded in the “Live” tab (→P.2-35).



① Motion Detection Area

Check a detection area to be used, and the detection area frame is displayed in the viewer. Up to 4 detection areas can be created.

② Selected area

When you create multiple motion detection areas, you can set the detection sensitivity for each area frame separately.

③ Sensitivity

Set the detection sensitivity in the range of 1-256. Drag the slide bar to set the value. Set a higher value to detect with a high sensitivity.

④ Auto button

Click “Auto” to automatically set the sensitivity for motion detection. The camera detects motion when changes in the subjects in the detection area are bigger than the set sensitivity. Click the button when there is no motion in the detection area.

⑤ Detection indicator

The level of detected motion is indicated in the graph in real time (→ P.2-34).

⑥ Size

If the ratio of the selected detection area (blue solid line frame) to the area where the VB-C60 detects motion (displayed in a red or yellow rectangle) exceeds the value set here, the status of the VB-C60 becomes “Detected” (→ P.2-34). However, even when the set ratio is exceeded the value set in Size, the “Detected” status does not effective if the duration set in “Duration” is not reached. Drag the slide bar to set the size in the range of 0-100%.

⑦ Duration

When changes in the video image in the detection area meet the conditions set in ③ “Sensitivity” and ⑥ “Size” and continue for the value set in “Duration”, the status of the VB-C60 becomes “Detected”.

“Duration” is normally fixed at “0.2”. However, the “Details” check box is checked, you can set the value by directly entering the value or dragging the slide bar in the range of 0-5 seconds.

⑧ Details

When the checkbox is checked, you can set the values for “Sensitivity”, “Size” and “Duration” by entering numeric values. When unchecked, “Duration (sec.)” is fixed at “0.2”.



Tip

- Even if changes occur in the video image in the detection area during viewing the viewer, the VB-C60 does not recognize it as “motion” if the sensitivity is set to a low level. In addition, even when you increase the sensitivity, unless the size of the area where a motion is detected within the area frame and the duration of the motion meet the set values, the status of the VB-C60 does not become “Detected”.
- You can also select the detection area to set by clicking it in the viewer. The selected detection area frame is displayed in a blue solid line frame.
- When Selected area is set to “Not specified”, the detection statuses of all of the detection areas you have created can be displayed simultaneously. Clicking on a location for which no area frame is set in the viewer can display them in the same manner.

4. Check the motion detection status of the camera

Check “Display motion detection status of the camera” to confirm the status of the motion detection with the settings you have configured. The motion detection status is displayed using one of the following icons.

You cannot save the settings with “Display motion detection status of the camera” checked. Clear the check to save the settings.



“Detection disabled”



“Detected”



“Not detected”

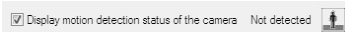

Note

- Because the video distribution frame rate may be lowered when the data is sent via a proxy server, connection without using a proxy server is recommended while setting the motion detection.
- It is recommended that the detection sensitivity is set under condition close to actual operation condition as much as possible.



Tip

- The “Motion detected (peak block display)” and “Display motion detection status of the camera” displays in this tool, and the actual detection status of the VB-C60 may not match perfectly.
- When the Motion Detection function of the VB-C60 is enabled, the processing load on the VB-C60 becomes high, and therefore the video distribution frame rate may decrease compared to when it is disabled.
- Select “Edit” → “Copy sensitivity settings” from the menu bar to copy setting values of Sensitivity, Size, and Duration (sec.) of each detection area, which is checked ([1]~[4]) at that point. After that, check other area ([1]~[4]), then select “Edit” → “Paste sensitivity settings” again, so that the copied setting values are pasted to the checked area.

5. Click “Save Motion Detection” to save the settings



“Detected” Status and Display Screen

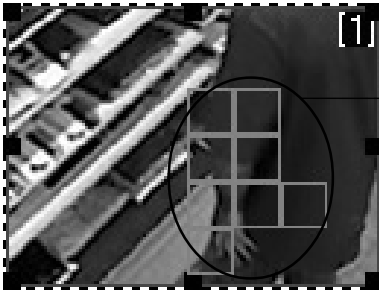

→ A frame of areas where the motion is being detected is indicated with blue solid line in the viewer.

→ Areas detected at the configured sensitivity are indicated with a yellow or red rectangle in the motion detection area frame.

Yellow rectangle: Indicates that the status is not “Detected” even though the camera is detecting motion because it did not meet the set value in “Size” or “Duration”.

Red rectangle: Indicates that the status is “Detected” because the camera is detecting motion and it meets the set values in “Size” and “Duration”.

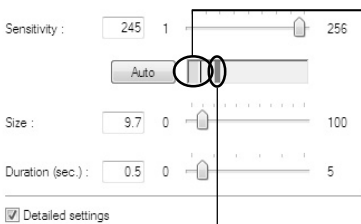

→ When a change occurs in the video, the value set in “Size” is displayed using a vertical bar line in the indicator. There are the following 2 indicator colors.

Green: The size of motion detected does not reach the value set in “Size”.

Yellow: The size of motion detected reaches the value set in “Size”.

Peak block

When a change in the video meets the conditions set in both “Size” and “Duration” and the status of the camera becomes “Detected”, a red peak block appears. You need to set the detection sensitivity with checking the level of motion at which level a peak block appears.

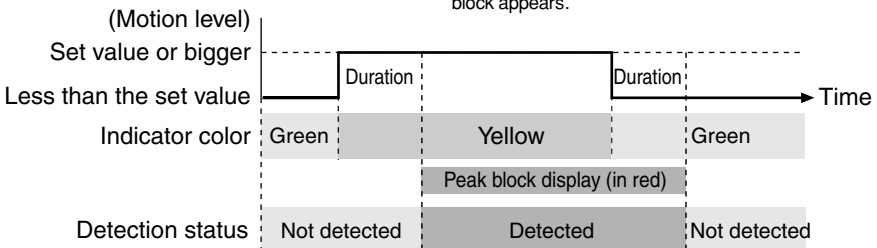

When motion that reaches the value set in “Size” or a higher value continues for the duration or longer, the status becomes “Detected” and a red peak block is displayed. Even if the motion becomes smaller than the set size while the status is “Detected” and the peak block is displayed, the “Detected” status is maintained until the duration ends.



Tip

Set the Sensitivity with checking Recorded Video

It is effective to adjust the setting values with viewing the actual motion in the viewer when setting the sensitivity on which the status of the VB-C60 becomes “Detected”. In the VB-C60, you can set the motion detection sensitivity with viewing the video recorded in the “Live” tab (→ P.2-28), so you do not need to repeatedly make motions in front of the camera.

1. Select “Tools” → “Video recording options” from the menu bar, and the Video recording options dialog is displayed



① Maximum recording time

Set the maximum recording time in the range of 60-300 seconds.

② Self-timer

Set the duration to start recording after the “Rec. Start” button is clicked. Set it in the range of 0-30 seconds.

2. Adjust the camera position and click “Rec. Start” in the “Live” tab

Recording of the video displayed in the viewer starts. Make some motions in front of the camera to record a video to be used for setting the motion detection sensitivity.

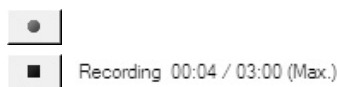

Click the stop button to stop recording.

3. Adjust the sensitivity in the “Area” tab with checking the video in “Video” tab

① List of recorded video

A list of recorded video is displayed.

② Delete button

You can delete the video selected in the list.

③ Control buttons

“Move to Start”, “Rewind”, “Play”, “Fast Forward”, and “Move to End” from the left. Check “Loop playback” to play the video repeatedly.



Log Viewer

Log Viewer enables viewing of operation status logs of the camera.

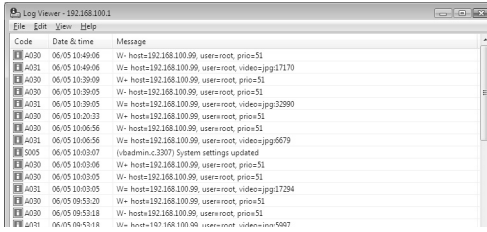

- Log Viewer only displays a log. You cannot delete the log.
- To save the log, select "File" → "Save" from the menu bar. The log is saved as a text file.

Download Log File

How To Download

When starting the Log Viewer from VB Admin Tools, the latest log file is automatically obtained and displayed.

To obtain another list of log files, select "File" → "Download" from the menu bar.

After the list is retrieved, a list of log files appears in the dialog box. Select the log file you want to view by clicking on it, then click "Download" and the selected file will be downloaded.

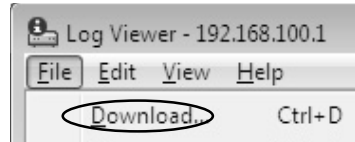

View Logs

The following information is included in a log.

● Code

The log codes are displayed. See “Log Message List” (→ P.5-6) for the log codes.

One of following three icons is displayed with each log code, depending on the log level. Logs without a log code are displayed without an icon.



Information level



Error level



Warning level

● Date & Time

The date and time when the log was generated is displayed.

● Message

The log messages are displayed.

■ Save Logs to File/Open Saved File

You can save a displayed log to a file as well as view saved log files.

How To Save

Select “Save” from the File menu bar

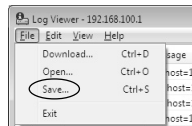

How To View

Select “Open” from the File menu bar and select the log file you want to view

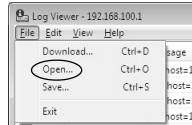

■ Copy and Search Logs

You can copy or search a displayed log.

How To Copy

Select the log you want to copy by clicking on it, then choose “Copy” from the Edit menu bar

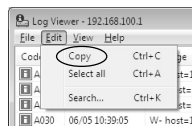

How To Search Data

1. Choose “Search” from the Edit menu bar

The Search Log dialog is displayed.

2. Enter a character string to search for and click “Search”

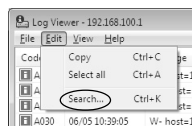

■ Display All Logs

How To Display

Select “View” → “Show all logs” from the menu bar

All event logs are displayed, like “View Log Events” (→ P.1-44) in “Maintenance” in camera’s setting page.

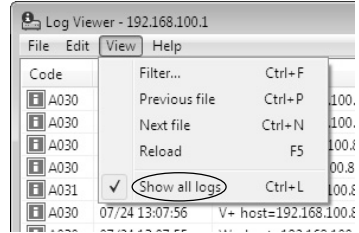

■ Select and View Logs by condition

Logs can be filtered according to log type, code, or date and time so that only the required information is displayed.

How To Make Settings

1. Choose “Filter” from the View menu bar

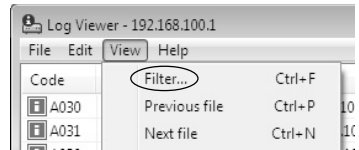

2. The Filter dialog appears.

Set the search criteria and click “OK”. The search results then appear showing a list of logs that match the selected criteria

If filtering is not required, click “Cancel”.

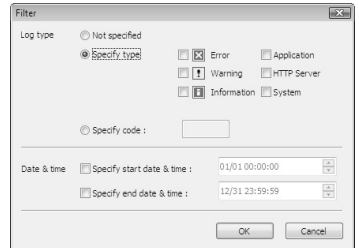

Log type

To filter by log type, check “Specify type” or “Specify code”. Otherwise select “Not specified”. Logs without a log code are filtered only when “Not specified” is selected with “Show all logs” in View menu bar checked.

● Specify type

Specify the log level

From “Error”, “Warning”, and “Information”, select the log levels to be displayed.

Specify the modules that output the logs

Check the source module to output the logs from “Application”, “HTTP Server”, and “System”.

● Specify code

Specify the code of the logs. The codes are compared to the characters that are entered and only logs with matching log codes will be displayed. For example, if you enter “A0”, logs with a code starting with “A0” will be displayed.

Date & Time

● Specify start date & time

When this item is selected and a date and time is entered, logs generated after the specified start date and time are displayed.

● Specify end date & time

When this item is selected and a date and time is entered, logs generated before the specified end date and time are displayed.



Tip

“Application” and “System” correspond to the list of log messages (→ P.5-6).

Chapter

3

VB-C60 Viewer

This chapter describes how to use the VB-C60 viewer with which you can access a camera via a Web browser to view live videos, control the pan, tilt and zoom, exposure mode, night mode, white balance, focus, smart shade control, and other functions.

VB-C60 Viewer Overview

The VB-C60 viewer is a viewer used to access network camera VB-C60 via a Web browser and to control the camera, including image display and pan/tilt/zoom controls.

The VB-C60 viewer includes 2 viewers: Admin viewer and VB viewer.



Use the VK-Lite viewer to view MPEG-4 video from the camera.
The VB-C60 viewer can display JPEG video only.

Major Differences between Admin Viewer and VB Viewer

●Operational Items

Admin Viewer : In addition to the basic camera controls including video display, pan/tilt/zoom control, you can use administrative control functions such as focus, exposure and white balance.

VB Viewer : Available operations are limited to the basic camera controls such as video display and pan/tilt/zoom control.

●Access Control

Admin Viewer : Users with the “Privileged Camera Control” can use this viewer.
Password authentication is required.

For Authorized users, the Administrator must provide the “Privileged Camera Control” in advance (→ P.1-36).

VB Viewer : Users with the “Camera Control” can use this viewer.

Depending on the settings, the password authentication requirement can be changed, and camera’s pan/tilt/zoom control can be restricted.

User Authority and Camera Control Privilege

The relationship between user authority and camera control privilege is as follows:

User Authority	Camera Control		Image Distribution	Audio Distribution
	Privileged Camera Control	Camera Control		
Administrator	✓	✓	✓	✓
Authorized users	✓ (can be changed)	✓ (can be changed)	✓ (can be changed)	✓ (can be changed)
Guest users	X	✓ (can be changed)	✓ (can be changed)	✓ (can be changed)

*can be changed: The administrator can change the privileges of Authorized users and Guest users.

There are four types of privileges that can be set for users: Privileged Camera Control, Camera Control, Image Distribution and Audio Distribution.

The “Privileged Camera Control” is required to use the Admin viewer.

The “Image Distribution” privilege is required to view video using the VB viewer. The “Camera Control” privilege is additionally required to control the camera using the VB viewer.

The “Audio Distribution” privilege is required to receive audio using the Admin viewer or VB viewer.

Administrator

Users with all privileges. The user name is fixed to “root”.

The Admin viewer can be started from the “Admin Viewer” link on the top page.

Authorized users

Authorized users can start the Admin viewer from the “Admin Viewer” link on the top page if the user is provided with the “Privileged Camera Control”. If the “Privileged Camera Control” is disabled, Authorized users cannot start up the Admin viewer, but can start up the VB viewer. If all privileges are disabled, Authorized users cannot start up even the VB viewer.

Guest users

Guest users can control camera’s pan/tilt/zoom, backlight compensation, video display and audio distribution only.

The VB viewer can be started from the “VB Viewer” link on the top page. The Administrator can completely prohibit camera access from Guest users by disabling all privileges.



Note

- The Admin viewer started by the “Administrator” can take away the camera control privilege from the Admin viewer started by an “Authorized user” any time. The Administrator can keep the camera control privilege, but during that time, Authorized users cannot obtain the camera control privilege. After viewing video, be sure to close the viewer or click “Obtain/Release Camera Control” to release the camera control privilege.

- While an Administrator is connecting to a camera, other Administrators cannot connect to the same camera. On the other hand, multiple Admin viewers started by “Authorized users” can connect to one camera at the same time. In that case, the camera control privilege is always given to the last user.



Tip

- In the factory default settings, the “Privileged Camera Control” is given to “Authorized users”, too.
- When Guest users’ privileges are all disabled, a User Authentication dialog box is displayed at the startup of the VB viewer. Users can use the VB viewer as an Authorized user or an Administrator, by starting up the VB viewer with entering the user name and the password of the Authorized user or the Administrator.
- List of Authorized users’ privileges
Each privilege of authorized users is as follows:

Provided controls	Viewer	Operations
Privileged Camera Control Camera Control Image Distribution Audio Distribution	Admin Viewer (Viewer Screen)	Controlling camera’s PTZ, switching on/off of backlight compensation, changing video display size, switching on/off of audio reception, reconnecting to the camera, switching to full screen mode, pausing/resuming video
	Admin Viewer (Administrator Control Screen)	All operations in “Control for Admin” display screen Details Smart Shade Control, Focus, Exposure, White Balance, Night Mode, displaying detection of External Device Input, displaying detection of Motion Detection Area, controlling External Device Output
	VB Viewer	All operations in VB Viewer Details Controlling camera’s PTZ, switching on/off of backlight compensation, changing video display size, switching on/off of audio reception, reconnecting to the camera, pausing/resuming video
Camera Control Image Distribution Audio Distribution	VB Viewer	All operations in VB Viewer Details Controlling camera’s PTZ, switching on/off of backlight compensation, changing video display size, switching on/off of audio reception, reconnecting to the camera, pausing/resuming video
Image Distribution Audio Distribution	VB Viewer	Changing video display size, switching on/off of audio reception, reconnecting to the camera, pausing/resuming video * The User Authentication dialog box is displayed when clicking the camera control button. Users can control the camera by entering the Administrator’s user name and the password in the dialog box.
Image Distribution	VB Viewer	Changing video display size, reconnecting to the camera, pausing/resuming video

* When “Image Distribution” is disabled, users cannot use the VB viewer.

Starting VB-C60 Viewer

Start up VB-C60 Viewer

Various settings of the VB-C60 viewer are available by accessing to the camera via a Web browser. First, access the Settings Title Page.



In this guide, IP address “192.168.100.1” (factory default setting) is used to explain how to set up the camera. Enter the IP address that is actually set for your VB-C60.

How To Start

1. Access “http://192.168.100.1/” using a Web browser
2. Click “Admin Viewer” or “VB Viewer”, according to the user type



3. To open “Admin Viewer”, enter the user name and password

The factory default setting is as follows (→ P.xiii).

User name : root

Password : VB-C60

The user name “root” is VB-C60’s Administrator account.

* The default password is “VB-C60”. Be sure to change the password in the “Network” menu in the setting page (→ P.1-7).

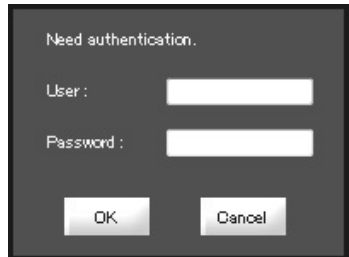

4. The VB-C60 viewer starts

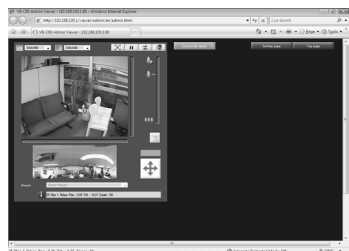

Close VB-C60 Viewer

How To Close

Close the Web browser that is displaying the viewer.

Connect from the VBAAdmin Tools

It is a viewer to control cameras as the administrator.

How To Start Up

1. Start the VBAAdmin Tools

(For details on how to start the VBAAdmin Tools, see Chapter 2 “VBAAdmin Tools” (→ P.2-4).)

2. Click “Admin Viewer”

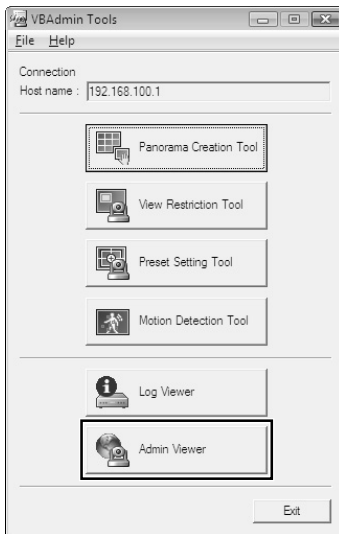

3. Enter the user name and password

The factory default setting is as follows (→ P.xiii).

User name : root

Password : VB-C60

The user name “root” is VB-C60’s Administrator account.

* The default password is “VB-C60”.

Be sure to change the password in the “Network” menu in the setting page (→ P.1-7).



4. The Admin viewer starts in a Web browser



Note

Be sure to enter the correct user name and password. If entering a wrong one, try again with the correct name and password.

How to Operate the VB-C60 Viewer

“Admin Viewer” Display Screen

This section describes the overview of the Admin viewer, including buttons and boxes, which are displayed when the Admin viewer is started.

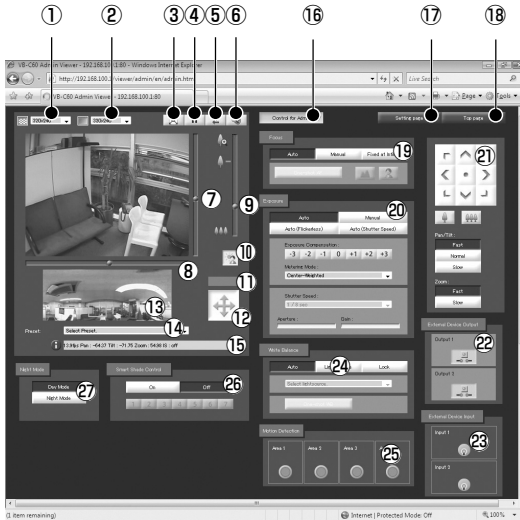

- ① **Video Capture Size**
Select the size for receiving video from the camera.
- ② **Video Display Size**
Select the size for displaying video.
- ③ **Full Screen Mode button**
Click to view live video in the full screen mode.
- ④ **Pause/Resume button**
Click to pause the video display. Click again to resume the live video display.
- ⑤ **Reconnect button**
Click to connect to the camera again.
- ⑥ **Audio Reception button**
Click to receive and output audio from the camera.
- ⑦ **Scroll bar for tilt**
Drag the scroll bar to tilt (up/down) the camera.
- ⑧ **Scroll bar for pan**
Drag the scroll bar to pan (left/right) the camera.
- ⑨ **Scroll bar for zoom**
Drag the scroll bar to control the zoom magnification.
Slide the knob upward to zoom in (to the telephoto end) or downward to zoom out (to wide end).

- ⑩ **Backlight Compensation button**
Click to switch on the backlight compensation. It works effectively to compensate for areas that are darkened due to backlight. Click again to switch off the function.
- ⑪ **Control Privilege Status Indicator**
Whether or not the client has the camera's control privilege is displayed.
- ⑫ **Obtain/Release Control Privilege button**
Click to obtain/release the camera control privilege.
- ⑬ **Panorama Display Area**
A panorama image registered in the camera is displayed. You can control the camera by dragging the frame displayed on the area.
- ⑭ **Preset Selection Box**
You can control the camera using presets registered to the camera in advance.
- ⑮ **Information Field**
Information, warning and error messages are displayed.
- ⑯ **Control for Admin button**
Click to display/hide the operation panel for the administrator control. The button is available in the Admin viewer only.
- ⑰ **Setting Page button**
Click to move to the Setting Menu page.
- ⑱ **Top Page button**
Click to move to the camera's top page.
- ⑲ **Focus**
Click to control the focus.
- ⑳ **Exposure**
Use to control the exposure.
- ㉑ **Camera Control button**
Click to control the pan/tilt/zoom. You can also change the speed.
- ㉒ **External Device Output**
Click to control the external device output.
- ㉓ **External Device Input**
Click to display the status of the external device input.
- ㉔ **White Balance**
Use to switch the white balance mode.
- ㉕ **Motion Detection**
Click to display the status of motion detection.
- ㉖ **Smart Shade Control**
Use to switch on/off the smart shade control.
- ㉗ **Night Mode**
Click to switch between the Day and Night mode.

“VB Viewer” Display Screen

This section describes the overview of the VB viewer, including buttons and boxes, which are displayed when the VB viewer is started.



- ① **Video Capture Size**
Select the size for receiving video from the camera.
- ② **Video Display Size**
Select the size for displaying video.
- ③ **Pause/Resume button**
Click to pause the video display. Click again to resume the live video display.
- ④ **Reconnect button**
Click to connect to the camera again.
- ⑤ **Audio Reception button**
Click to receive and output audio from the camera.
- ⑥ **Zoom Controller**
Click on the bar to control the zoom magnification.
- ⑦ **Backlight Compensation button**
Click to switch on the backlight compensation. It works effectively to compensate for areas that are darkened due to backlight. Click again to Switch off the function.
- ⑧ **Control Privilege Status Indicator**
Whether or not the client has the camera's control privilege is displayed.
- ⑨ **Obtain/Release Control Privilege button**
Click to obtain/release the camera control privilege.
- ⑩ **Panorama Display Area**
A panorama image registered in the camera is displayed. You can control the camera by dragging the frame displayed on the area.
- ⑪ **Preset Selection Box**
You can control the camera using presets registered to the camera in advance.
- ⑫ **Information Field**
Information, warning and error messages are displayed.

Obtain the Camera Control

The camera cannot be controlled by multiple users at the same time. Only the user who currently has the camera control privilege can control the camera. You must obtain the camera control privilege to control the camera, such as pan/tilt/zoom, backlight compensation and presets.

How To Operate

Click “Obtain/Release Camera Control” to obtain the camera control privilege

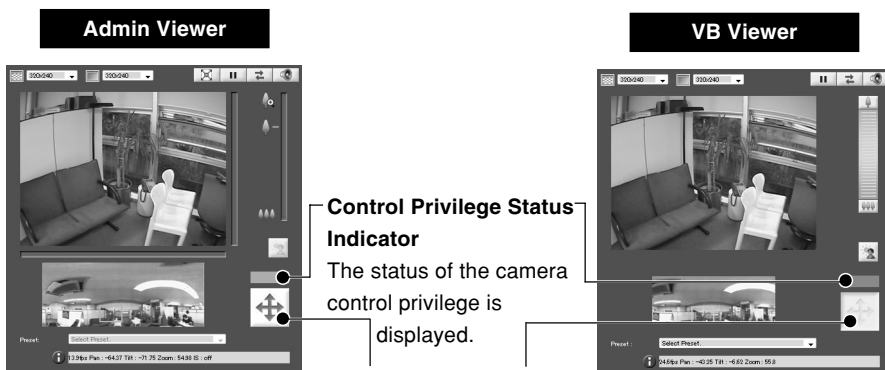

“Obtain/Release Control Privilege” button

Obtain or release the camera control privilege.

*You can only obtain the camera control privilege in the VB viewer.

■ Control Privilege Status Indicator

The display color of the Obtain/Release Control Privilege button and the Control Privilege Status Indicator changes according to the viewer type as follows.

Viewer Type	Area/Button	Control being obtained	Control being released
Admin Viewer	Control Privilege Status Indicator	Blue	Gray
	Obtain/Release Camera Control button	Orange	Blue
VB Viewer	Control Privilege Status Indicator	Blue	Gray
	Obtain/Release Camera Control button	White	Light blue



When a guest user is queued for the camera control privilege, the stand-by time is displayed in the “Control Privilege Status Indicator”.



While the video is being paused (→ P.3-18), a pause icon is displayed in the “Control Privilege Status Indicator”.

Control the Camera

■ Change the Camera Angle

How To Control

Admin Viewer

You can change the camera angle in one of the following ways.

Slide the knob on the scroll bar for pan or tilt

The camera angle changes according to the knob position on the scroll bar. You can also move the knob by clicking on a blank area on the scroll bar.



You can move the center of the shooting window by clicking on the video.

Scroll bar for tilt

Use this scroll bar to change the tilt angle (up/down) of the camera.

Scroll bar for pan

Use this scroll bar to change the pan angle (right/left) of the camera.

VB Viewer



You can move the center of the shooting window by clicking on the video.

* The VB viewer does not have the scroll bars for tilt and pan.

■ Change the Camera Angle in the Panorama Display Area



A frame displayed in the area indicates the range the camera is currently capturing.

Blue frame : The user does not have the control privilege.

Yellow frame : The user has the control privilege.

Move by clicking

Click on the Panorama window to change the pan and tilt angles so that the clicked position becomes the center of the image.

Move by dragging

Drag the yellow-framed area on the Panorama image to change the pan and tilt angles.



Tip

- Cameras are not controlled with high accuracy, by clicking on an image of the VB-C60 viewer.
- The Administrator can control the camera beyond the view restriction area with the Admin viewer. However, with the Admin viewer started by Authorized users, the users can control the camera within the view restriction area only.
- With the VB viewer, the camera control is available within the view restriction area only.

■ Change the Camera's Zoom Magnification

How To Change

Admin Viewer

Slide up or down the knob on the scroll bar for zoom

The camera zoom magnification changes according to the knob position on the scroll bar. You can also move the knob by clicking on a blank area on the scroll bar.



Zoom tele end

Optical tele end (only when digital zoom is ON)

Scroll bar for zoom

Slide up to zoom in (telephoto)

Slide down to zoom out (wide-angle)

Wide end



Tip

- When "Digital Zoom" is set to "Enable" in the "Camera" menu in the setting page, an icon indicating the optical tele end is displayed (→ P.1-15).
- You can also control the zoom magnification using the Camera Control buttons (→ P.3-23).

VB Viewer

Click on the setting bar for zoom

The camera zoom magnification changes according to the relative position on the setting bar. You can also change the zoom magnification by clicking on icons positioned on both sides of the setting bar.



Setting bar for zoom

Upper end: the maximum zoom in value (telephoto)

Lower end: the maximum zoom out value (wide-angle)

■ Change the Zoom Magnification in the Panorama Display Area



Change by dragging

Drag the yellow frame in the Panorama image and change the frame size, so that the zoom magnification changes and the yellow-framed area is zoomed.



Tip

When you click outside the yellow frame and drag the mouse, a blue frame is drawn. When you release the mouse, the blue frame changes to yellow and the camera's pan, tilt, and zoom change and move to capture the new yellow-framed area.

■ Use a Preset

You can control the camera using presets registered in the camera in advance (→ P.2-18).

How To Operate

1. Display the preset dropdown list by clicking the Preset Selection box
2. Select a preset from the list to change the camera angle



Preset Selection box



Tip

You need to set presets using VBAAdmin Tools in advance (→ P. 2-21). Registered presets are displayed in the Preset Selection box.

■ Compensate Backlight

Backlight Compensation works effectively to compensate for areas that are darkened due to backlight.

How To Operate

Click the Backlight Compensation button to make a dark image brighter

Click again to turn off the function.

Admin Viewer



VB Viewer



Configure Image and Audio Settings

You can change the video capture size and the video display size, switch to the full screen mode, pause/resume video, reconnect to the camera and start/stop receiving audio.



■ Change the Video Capture Size

You can select the size for receiving video from the camera from “160 x 120”, “320 x 240” or “640 x 480”.

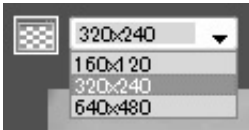

■ Change the Video Display Size

You can select the size for displaying video on the viewer from “160 x 120”, “320 x 240” or “640 x 480”.

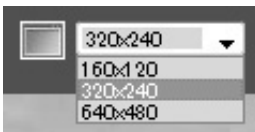

Tip

- The video capture size, set in the camera’s setting page, is applied to the size at viewer startup (→ P.1-19).
- The video display size at viewer startup is “320 x 240”.

■ Full Screen Mode (only in the Admin viewer)

You can display the video at full-screen size. Click the button to launch a new window at full screen size.



Click the close button on the full-screen window to close.

■ Pause/Resume Video

You can pause and resume the video.



Click the button to pause or resume an image

■ Save a Paused Image

How To Operate

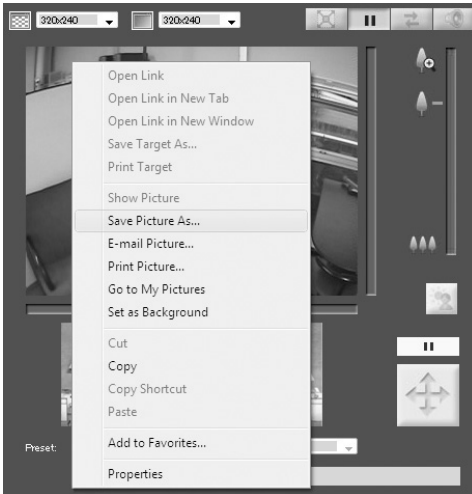

1. Click the Pause/Resume button to pause the video
2. Place the cursor on the image and right-click to display the menu
3. Select “Save Picture As”
4. Name the file and save

***Though the above screen example is of the Admin viewer, you can also save an image by the same operation using the VB viewer.**



Tip

When you pause video, the Control for Admin panel is hidden. When you resume it, the panel is displayed again.

■ Reconnect to the Camera

This function is to reconnect to the camera.



Click the button to reconnect to the camera



Tip

After reconnecting to the camera, audio reception is stopped. In addition, the camera control privilege is lost, and the video capture size and the video display size are restored to the default settings.

■ Audio Reception

You can receive audio through a microphone connected to the camera.



Click the button to receive audio



Tip

- To receive audio, you need to set “Audio Transmission from the Camera” to “Enable” in the “Audio Server” submenu in the “Server” menu in camera’s setting page, in advanced (→ P. 1-27).
- Audio cannot be received via a proxy server.

Display Information

Information and warning messages are displayed.



1 Information Message



The icon is displayed in blue.

This type of messages is displayed when the camera is operated properly. It displays help messages for buttons and pull-down menus, pan/tilt/zoom information from the camera, frame rate information, Image Stabilizer settings, etc.

2 Warning Message



The icon is displayed in yellow.

This type of messages is displayed to alert users, for example, when an unsupported browser is used, audio reception is stopped, etc.

3 Error Message



The icon is displayed in orange.

This type of messages is displayed when an error occurs in the viewer.



Note

When Image Stabilizer is ON, the actual video display angle becomes smaller than the angle value displayed in the information field (On1: approximately 83%, On2: approximately 50%). Also, the actual video display angle becomes smaller than the angle (frame) displayed in the panorama display area.



Tip

For further information on the above messages, see “VB-C60 Viewer Message List (P.5-12) ”.

Operation and Setting as Administrator

This section describes operations and settings, which are available only in the Admin viewer.

Open the Control for Admin Panel

How To Operate

1. Click “Obtain/Release Camera Control” to obtain the camera control privilege



2. Click “Control for Admin”

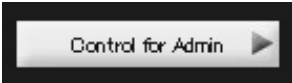

3. The Control for Admin panel is displayed



Control the External Device Output

You can control the external device output and display the current status with icons.

Click the icon to switch on/off.

Example

Top : Output OFF

Bottom : Output ON

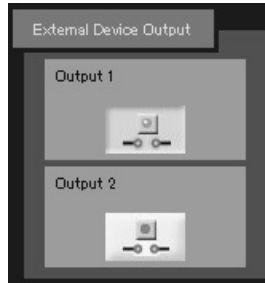

Display the Status of External Device Input

The status of external device input is checked and displayed with icons.

When a connection input signal from an external device is received, the input becomes ON, and then the status is indicated with an icon.

Example

Top : Input OFF status

Bottom : Input ON status

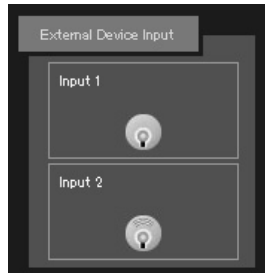

Display the Status of Motion Detection

The status of the motion detection function is indicated.

Example

Area 1 - 3 : Detection OFF

Area 4 : Detection ON



Tip

You need to set for Motion detection with “Motion Detection Setting Tool” (→ P.2-27) in VBAAdmin Tools, in advance.

Control and Set the Camera

You can control the camera and change the speed using the Camera Control buttons.

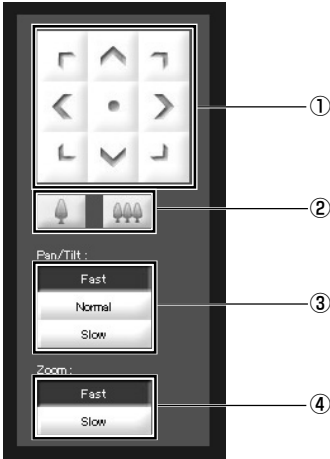

① Pan/Tilt button

You can pan and tilt the camera in the direction of arrows. Hold down the button to keep moving the camera toward the direction, and release the button to stop the movement. Click the center button to turn the camera to the front.

② Zoom button

You can zoom in and out. Hold down the icon to keep zooming, and release the icon to stop zooming.

③ Pan/Tilt speed

Select the pan/tilt speed from “Fast”, “Normal” or “Slow”.

④ Zoom speed

Select the zoom speed from “Fast” or “Slow”.



Tip



Even when the “Pan/Tilt speed” and “Zoom speed” are changed, the pan/tilt/zoom speed on the slider and a panorama image are not changed.

Set the Focus

Select the focus mode from “Auto”, “Manual” or “Fixed at infinity”.



Auto : The focus is adjusted automatically.

Manual : Hold down the  (Far) or  (Near) button to adjust the focus.
When you click “One-shot AF”, it automatically focuses the camera and then return to the “Manual” mode again.

Fixed at infinity : Focus is fixed at a point of infinity.



Note

- Even when changing the Focus Mode in the VB-C60 viewer, it is not reflected to the Focus Mode in camera's setting page.
- Note that the focus will be fixed if you select the manual focus mode.
- Once the setting is changed in the VB-C60 viewer, the setting is applied to other users' viewers as well.
- If you specify the shutter speed within the range of 1/1 to 1/4 with “Manual” exposure mode selected (→ P. 3-25), “Auto” and “One-shot AF” for the camera control will be disabled. Change the focus mode to Manual and adjust the focus.
- For the focusing range when the camera is set to “Night Mode” (→ P. 1-6, 3-28), refer to the Note on P. 1-15.

Set the Exposure

You can configure the settings related to exposure operations.

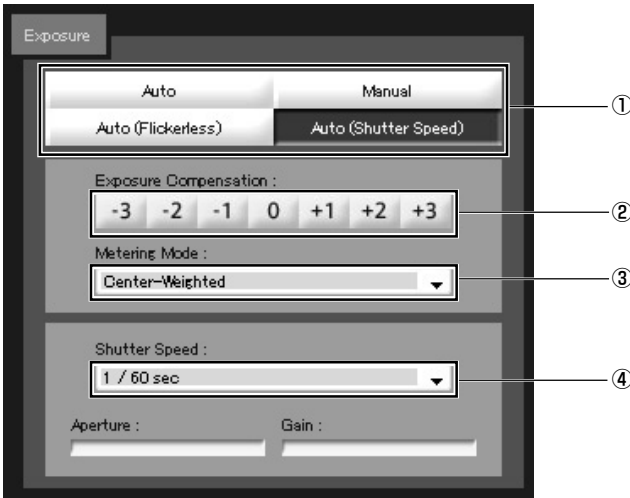

① Exposure Mode

Select from “Auto”, “Manual”, “Auto (Flickerless)” or “Auto (Shutter Speed)”.

When using the camera while setting “Day/Night” to “Auto” in the “Camera” menu in the setting page (→ P.1-16), use “Auto”, “Auto (Flickerless)” or “Auto (Shutter Speed)”.

For more information on the setting items in the Exposure Mode, see “Setting Page” (→ P.1-14).

② Exposure Compensation

When the Exposure Mode is set to “Auto”, “Auto (Flickerless)” or “Auto (Shutter Speed)”, you can select the exposure compensation value in 7 levels (-3 - +3).

When you want to make an image darker, select a negative value. Otherwise, select a positive value.

③ Metering Mode

When the Exposure Mode is set to “Auto”, “Auto (Flickerless)” or “Auto (Shutter Speed)”, select the metering mode from “Center-Weighted”, “Average” or “Spot”.

Center-Weighted

This mode meters the light in the entire screen, but especially the center of the screen is weighted. Even when there is a certain degree of brightness or darkness in the edges of the screen, an appropriate exposure can be achieved for the subject in the center.

Select this mode when the subject is located around the center.

Average

This mode meters the light in the entire screen uniformly an average.

You can obtain a stable exposure even in an environment where the gap between brightness and darkness in the screen is significant.

Select this mode to stabilize exposure in situations, for example, where there is car traffic or people entering and exiting.

Spot

This mode meters the center part of the screen.

Without being affected by brightness or darkness in outer areas of the screen, the appropriate exposure can be achieved for the subject in the center.

Select this mode to adjust the exposure in the center part of the screen when the subject is under a spotlight or in backlight.

④ **Shutter Speed**

When the Exposure Mode is set to “Manual” or “Auto (Shutter Speed)”, select the shutter speed.

When “Manual” is set, select the speed between “1/1 sec” and “1/8000 sec” from the pull-down menu.

When “Auto (Shutter Speed)” is set, select between “1/8 sec” and “1/8000 sec” from the pull-down menu.

⑤ **Aperture**

When the Exposure Mode is set to “Manual”, set the aperture value.

The further to the left you move the slider, the more closed the aperture and the darker the image. Conversely, the further to the right you move the slider, the more open the aperture and the brighter the image.

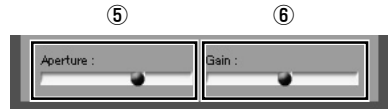

⑥ **Gain**

When the Exposure Mode is set to “Manual”, set the gain value.

The further to the left you move the slider, the lower the gain (sensitivity for brightness) and the darker the image. Conversely, the further to the right you move the slider, the higher the gain and the brighter the image.



Note

When capturing subjects like traffic lights and electronic signboards, the captured video may be blinking. It may be reduced by changing the exposure mode to “Auto (Shutter Speed)” and choosing a shutter speed of 1/100 or slower.

Set the White Balance

Select the white balance from “Auto”, “Light Source”, and “Lock”.

① **Auto**

The white balance is automatically adjusted .

② **Light Source**

Select from the pull-down menu according to the light source conditions.

Daylight Fluorescent : Select when using the camera in daylight fluorescent lighting.

White Fluorescent : Select when using the camera in neutral white or cool white fluorescent lighting.

Warm Fluorescent : Select when using the camera in warm color fluorescent lighting.

Mercury Lamp : Select when using the camera in mercury lighting.

Sodium Lamp : Select when using the camera in orange light of sodium lighting.

Halogen Lamp : Select when using the camera in halogen or incandescent lighting.

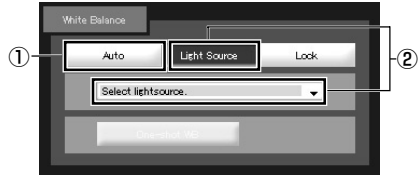

③ **Lock**

Fixes the white balance using the video currently received.

Use “One-shot WB” to forcibly fix the white balance based on the light source.

Setting example

Light up a white subject (such as white paper) using the light source, capture it using the entire screen, and execute “One-shot WB”.



Note

- Since the light source setting is based on major characteristics of each lighting type, the correct color may not be reproduced depending on the actual lamp used. In this case, use the “One-shot WB” function.
- If the image is greenish when shooting an object under a mercury lamp while the White Balance option is set to “Auto”, select “Mercury Light” in the Light Source option. If the image color is still not correct after changing the light source to the “Mercury Lamp”, return the setting to “Auto”.
- When shooting images day and night continuously.
If you shoot an object, which shows little change in appearance in an environment where the light source gradually changes (e.g. continuous outdoor shooting for day and night), the image may show an incorrect color.
In this case, pan, tilt, or zoom function to alter the image and return to the correct color.
- If you shoot a single color object or shoot images under sodium-vapor lamp or mercury lamp, it may be difficult to adjust the color automatically.

Set the Smart Shade Control

Unlike backlight compensation, Smart Shade Control adjusts darker areas with maintaining the brightness of the brighter areas.

- ① **Smart Shade Control**
Switch on/off the shade control.
- ② **Smart Shade Control Level**
When the shade control is "On", set the correction level from 1 (low) to 7 (high).



Example) If the background of an image is too bright to see the main subjects, you can adjust the contrast of the darker areas to make it easier to see. Unlike backlight compensation, the background image remains clear without "blown-out."



OFF



Smart Shade Control



Backlight Compensation



Tip

- When the smart shade control is set to "On", the file size of images becomes large.
- When the smart shade control is set to "On", noise in the screen may increase. If too much noise occurs, set the correction level to a lower level.

Set the Night Mode

Switch between "Day Mode" and "Night Mode".



Tip

The Night Mode cannot be used when "Day/Night" is set to "Auto" in the "Camera" menu on the setting page (→ P.1-16).

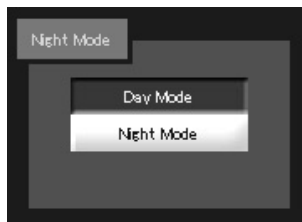

Day Mode:

You can view color video in the normal mode.

Night Mode:

The infrared cut filter is removed and the video is displayed in black and white.



Tip

For the focusing range when the camera is set to "Night Mode" (→ P. 1-16, 3-28), refer to the Note on P. 1-15.

Chapter **4**

Creating Web Pages for Video Distribution

This chapter describes how to use the VB-C60 to webcast information.

Image data can be distributed in various ways, including displaying video or still images and displaying multiple images on a Web page.



Web Pages for Video Distribution

To distribute image data using VB-C60, you need to create a dedicated Web page. The viewer that can be used with VB-C60 is “VB-C60 Viewer”, which allows you to set detailed parameter settings.

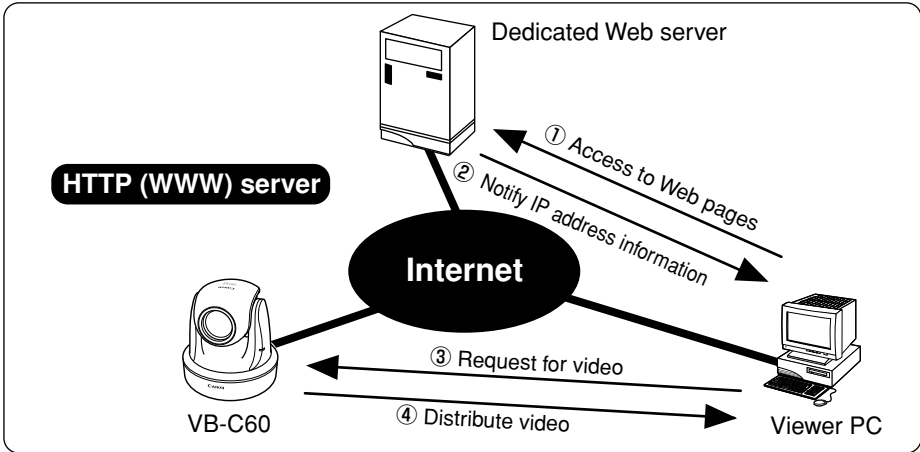

If you select a link requesting video in step ①, a file that includes the IP address information for the VB-C60 is sent from the Web server in step ②. If you are using the VB Viewer, the video is distributed to the viewer PC from the VB-C60 in response to the request in step ③.

■ Example of a Web page for video distribution (VB-C60's built-in page)



The above page is built into VB-C60. It can be accessed from the URL below.

<http://192.168.100.1/>

* The underlined portion is a sample IP address. Use the actual IP address set for the VB-C60 (→ P.1-8).



Note

VB-C60 is equipped with a built-in Web server. If the content of the Web pages used for distributing video is stored onto the built-in flash memory in VB-C60, the VB-C60 can be used both for distributing Web pages and video over the Web. Please refer to P.4-6 for procedures on how to save Web page data.



Tip

You can use the Language setting function for the Browser to create a multi-lingual Web site. For example, if you set the French-language top pages as Index-fr.html and the English-language top page as Index.html and supply users with a URL address terminates in slash, such as <http://192.168.100.1/sample/>, the server will transmit a file corresponds with the language setting for the Browser. For further information on the Language setting function for the Browser, refer to the Browser Help.

* The underlined portion is a sample IP address. Enter the actual IP address set for the VB-C60 (→ P.1-8).

View Sample Pages

Ready-made video distribution sample pages are provided with VB-C60. Follow the procedure below to view these pages. Refer to these pages when creating your own Web pages.

How To View the Pages

1. Launch your Web browser and enter the following URL:

http://192.168.100.1/sample/

* The underlined portion is a sample IP address. Enter the actual IP address set for the VB-C60 (→ P.1-8).

* The page can be displayed from “Sample Page” on the top page (→ P.x).

2. The following pages appear. Click the sample page you wish to view.

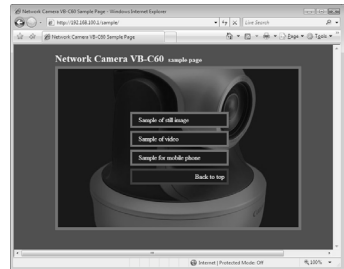

Examples of sample pages

Still image sample

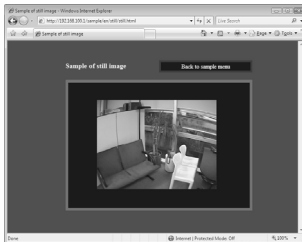

This is a sample page, which retrieves still images to display from the camera.

Video sample

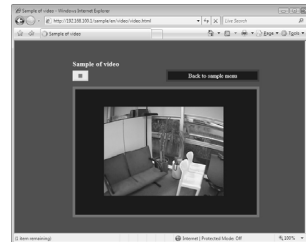

This is a sample page, which displays live videos.

Sample for mobile phones

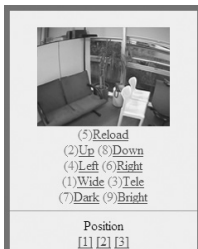

This is a still image display sample page with the camera control function for mobile phones. (It can be viewed on Web browsers on standard PCs.)

Distribute Video using VB Viewer

This section describes how to use the VB Viewer to distribute video. Application examples are also given.

Create a Web Page using the VB Viewer

You can incorporate and display the VB Viewer in the Web page.

```
<iframe src="http://192.168.100.1/viewer/live/en/live.html"  
        scrolling="no"  
        width=490 height=500>  
</iframe>
```

* The underlined portion is a sample IP address. Enter the actual IP address set for the VB-C60 (→ P.1-8).

You can also specify the URL without the IP address as shown below when you save the Web page in the flash memory in VB-C60.

```
<iframe src="/viewer/live/en/live.html"...>
```

Save Web Page Data

VB-C60 is equipped with a Flash memory where Web page data can be saved. Data is saved by transferring the data files using FTP. The data is placed as a file under /usr/www/html/local.

Device	File system (accessed by an ftp client)	URI (accessed by a Web browser)
On-board flash memory	ftp://IP address/usr/www/html/local	http://IP address/local/



Note

- Output performance may be degraded if there is insufficient free space in the flash memory. Ensure that only the minimum amount of data required is stored in the flash memory.
- Camera's setting change may not be available if web pages' data size is too large. Make sure that the whole web page's data size is less than 3MB if you save the data in the camera's flash memory. In that case, be sure to check the event log after changing settings and check an error in saving setting values (S306, S307) is not displayed. If the error was displayed, delete the web page data and then again configure the settings. For details about the error messages, refer to P.5-11.

Example of Using the VB Viewer to Create a Web Page

This section describes an example in which the VB Viewer is used to create a Web page. Use this example to create your own original Web page.



sample.htm

```
<html>
<head>
<title>VB Viewer Sample Page</title>
</head>

<body bgcolor="gray">
<center>
<h1>LiveApplet</h1>

<iframe src="http://192.168.100.1/viewer/live/en/live.html"
        scrolling="no"
        width=490 height=500>
</iframe>

</center>
</body>
</html>
```

* The underlined portion is a sample IP address. Enter the actual IP address set for the VB-C60 (→ P.1-8). You can also specify the URL without the IP address as shown below when you save the Web page in the flash memory in the VB-C60.

```
<iframe src="/viewer/live/en/live.html"...>
```

VB Viewer Parameters

You can specify parameters to provide a Web page to modify the behavior or appearance of Web pages. Ensure that you thoroughly understand the parameters.

■ object tag description

Attribute name	Omissible	Description
src	No	<p>Specifies the URL of the VB Viewer. You can refer to the VB Viewer in Japanese and English versions at the following URLs.</p> <p>Japanese version: src="http://IP address/viewer/live/ja/live.html" English version: src="http://IP address/viewer/live/en/live.html"</p> <p>You can also specify the URL without the IP address as shown below for the Web page saved in the flash memory in the VB-C60.</p> <p>Japanese version: src="/viewer/live/ja/live.html" English version: src="/viewer/live/en/live.html"</p> <p>*When you wish to hide the scroll bar, also specify the following parameter. scrolling="no"</p>
height	No	<p>This parameter specifies the height of the VB Viewer display area in units of pixels.</p> <p>When displaying the video in QQVGA (160×120) or QVGA (320×240), specify height = 500 or higher.</p> <p>When displaying the video in VGA (640×480), specify height=740 or higher.</p>
width	No	<p>This parameter specifies the width of the VB Viewer area in the unit of pixel.</p> <p>When displaying the video in QQVGA (160×120) or QVGA (320×240), specify width=490 or higher.</p> <p>When displaying the video in VGA (640×480), specify width=810 or higher.</p>

Distribute Video using a Browser Only

You can also use the WebView-HTTP protocol to distribute video from VB-C60. Some examples are described in this section.

Display the Live Video at Access as a Still Image

When a client accesses the Web page that provides videos, the video shot at that point can be supplied as a still image.

For a more detailed example, refer to the sample page.

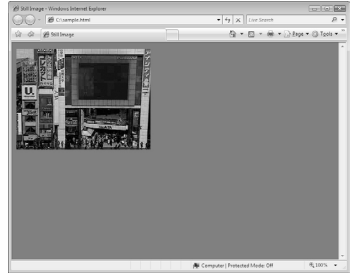

```
<IMG SRC=http://192.168.100.1/-wvhttp-01-/GetOneShot>
```

* The underlined portion is a sample IP address. Enter the actual IP address set for the VB-C60 (→ P.1-8).

Example of Video Distribution using One Global Address

One fixed global address is required if VB-C60 is being used to distribute live videos on the Internet. An Internet service provider (ISP) that offers a single-address fixed global address service can be used. In this case, a router with the NAT function is required.

Example: In this example, the global address 192.168.1.10 assigned by the ISP is used. The local address 192.168.100.2 is set for VB-C60 (and 192.168.100.1 for the router).

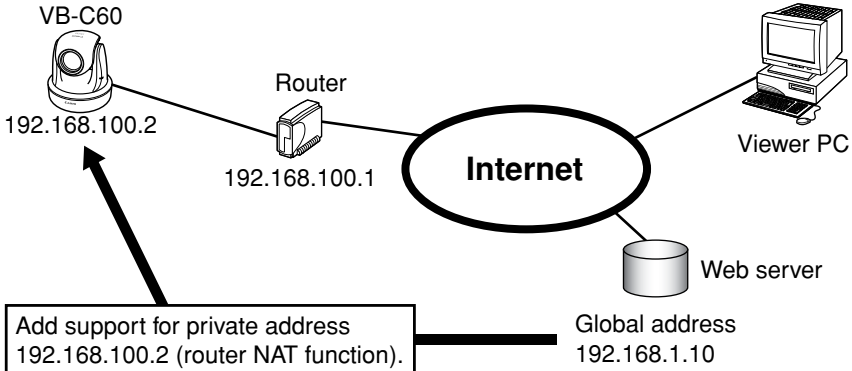

In this case, this page cannot be viewed in the VB viewer even when "http://192.168.100.2/sample/" is accessed through the Internet. Set "Global Address for the Web Page" (→ P.1-28) to 192.168.1.10. Describe the Web pages for distributing video as follows.

Set the VB Viewer description (→ P.4-5) as follows:

```
<iframe src="http://192.168.1.10/viewer/live/en/live.html"
        scrolling="no"
        width=490 height=500>
</iframe>
```

* The underlined portion is a sample IP address. Enter the actual IP address set for the "Global Address for Web Pages" (→ P.1-8).



- Contact respective manufacturers for details on setting the router.
- You need to set for "Global Address for the Web Page" (→ P.1-28) to distribute audio.

Distribute Still Images to a Mobile Phone

You can view still images and control the camera using the Web service of a mobile phone. You can easily create still image distribution pages for mobile phones with HTML, which uses the command `image.cgi`. Sample pages for still image distribution for mobile phones have been provided for the VB-C60. See below for how to view them.

1. Start up your browser and enter the following URL

<http://192.168.100.1/m/>

* The underlined portion is a sample IP address. Enter the actual IP address set for the VB-C60 (→ P.1-8).

2. Select the language (English or Japanese)

3. The sample page appears

The sample page has been created in such a way that you can control the camera. Adjust the camera direction, zoom and brightness. You can perform the operation corresponding to each key by pressing the dial keys on your mobile phones.



Depending on the model of the mobile phone, there may be cases where the images do not appear or where it is not possible to control the camera.



You can control the camera only when other users do not have control privileges.

Overwrite Sample Pages

You can change screen displays and the content of operations by overwriting the HTML file under the following path by accessing the flash memory in the VB-C60 via ftp.

Path to the Japanese version sample: /mnt_flash/www/html/sample/ja/mobile/

Path to the English version sample: /mnt_flash/www/html/sample/en/mobile/

```
<IMG SRC="/-wvhttp-01-/image.cgi?v=jpg:160x120&pan=-17000&tilt=0&zoom=5580"
ALT="position 1"><BR>
```

For example, to change the control position [1], overwrite the underlined value in "pos1.html". See the table below for details of the parameters of the image.cgi command.



Note

Before overwriting the sample files in the flash memory in VB-C60, be sure to create a backup of them.

■ image.cgi Parameters

Command	Description
pan	Specifies the pan of the camera in units of 0.01. When a positive value is specified, the camera is panned toward the right. When a negative value is specified, the camera is panned toward the left direction. Example: 90 degrees toward right ⇒ pan=9000 35 degrees toward left ⇒ pan=-3500
tilt	Specifies the tilt of the camera in units of 0.01. When a positive value is specified, the camera is tilted upward. When a negative value is specified, the camera is tilted downward. Example: 20 degrees to upward ⇒ tilt=2000 15 degrees to downward ⇒ tilt=-1500
zoom	Specifies the zoom angle (horizontal) of the camera in units of 0.01. Example: 50 degree angle ⇒ zoom=5000 5 degree angle ⇒ zoom=500
v	Specifies the image size using the following formats. QQVGA ⇒v=jpg:160×120 QVGA ⇒v=jpg:320×240 VGA ⇒v=jpg:640×480



Tip

For pan, tilt and zoom, you can specify the relative position from the current position using “d”, which indicates the current position.

Example:

Panning 10 degrees to the right from the current position \Rightarrow pan=d+1000

Tilting 5 degrees downward from the current position \Rightarrow tilt=d-500

Narrow the angle by 2 degrees \Rightarrow zoom=d-200

Widen the angle by 2 degrees \Rightarrow zoom=d+200

You can also specify “v”, which indicates the percentage for the current angle. In this method, specify the percentage using the current angle as 100. (Half the angle is 50, and twice the angle is 200.)

Example:

Panning for the angle (=1 screen) to the right from the current position \Rightarrow pan=v+100

Tilting half a screen downward from the current position \Rightarrow tilt=v-50

Half the angle \Rightarrow zoom=v+50

Double the angle \Rightarrow zoom=v+200

Chapter



Appendix

Modifiers

The following parameter descriptions using the '%' symbol are possible.

%n	Initiation cause of shooting operation (number)	0 (test) 1 (External Device Input 1) 2 (External Device Input 2) 33 (interval timer) 130 (motion detection "area 1") 131 (motion detection "area 2") 132 (motion detection "area 3") 133 (motion detection "area 4")
%N	Initiation cause of shooting operation (character string)	"External device input name (alphanumeric characters)" "Motion detection area name 1/2/3/4" "NULL (blank character/for interval timer and test)"
%X	Image width	Number of horizontal pixels
%Y	Image height	Number of vertical pixels
%C	Camera number	
%D	Camera name	"Camera name (alphanumeric characters)"
%P	Pan position	-179.99 ~ 180.00
%T	Tilt position	-179.99 ~ 180.00
%Z	Zoom position	0.1 ~ 300.00
%V	Camera server	VB-C60
%y	Year of shot	2001 ~ 2031
%m	Month of shot	1 ~ 12
%d	Day of shot	1 ~ 31
%w	Weekday of shot	0 ~ 6 (corresponds to Sun. to Sat.)
%H	Hour of shot	00 ~ 23
%M	Minute of shot	00 ~ 59
%S	Second of shot	00 ~ 59
%s	Millisecond of shot	000 ~ 999
%z	Time zone of shot	-1200 ~ +1300
%a	Weekday name of shot	Sun Mon Tue Wed Thu Fri Sat
%b	Month name of shot	Jan Feb Mar Apr May Jun Jul Aug Sep Oct Nov Dec
%h	Host name	"Host Name"

*If an unconformity is found, an error occurs during the execution.

*For undefined "characters, %" will be removed.

■ Available Modifiers

Available modifiers in each setting item are as follows:

HTTP Upload (→ P.1-22)

Parameter (query string)

All of the modifiers can be used.

FTP Upload (→ P.1-23)

Subdirectory Name to Create

Available modifiers are %y, %m, %d, %w, %H, %h and %n only.

File Name to Create

Available modifiers are %y, %m, %d, %w, %H, %M, %S, %s and %n only.

E-mail Notification (→ P.1-24)

Text

All of the modifiers can be used.



Troubleshooting

Before you contact your Canon dealer or contact support, check the items listed below. If a log message is displayed, refer to the log message list for the detail and the countermeasure.

The camera does not start up

- If you are using a PoE HUB, check that the LAN cable is connected properly.
- If you are using the AC Adapter (option), check that the AC Adapter is connected properly.
- Power Off then On the camera (→  Start Guide P.2-7).

VB Initial Setting Tool does not work

- Check that the LAN cable is connected properly.
- Power Off then On the camera (→  Start Guide P.2-7). The camera stops responding to VB Initial Setting Tool 20 minutes after power-on.
- Check that the PC where VB Initial Setting Tool is running and the camera are connected to the LAN on the same segment.
- VB Initial Setting Tool may not run on Windows Vista/XP. In this case, see “Windows Vista/XP” (→  Start Guide P.1-10). Refer to the same note if you are enabling Windows Firewall on Windows Server 2003 Standard Edition (SP1).
- Check that the VB initial setup tool for older models is not used.

Camera's top page does not appear

- Check that the LAN cable is connected properly.
- Check that the network for the camera is set properly. In particular, check that the IP address, subnet mask, and default gateway address setting available for the current network.
- When changing the IP address setting, the new IP address does not take effect until the camera is rebooted.
- Check that the URI (i.e., camera's IP address) you entered in the Web browser is correct (→ P.x,1-43, 3-5).

The video does not appear

- If the video quality is poor, check the video quality setting of the camera (→ P.1-19). Also check the display color quality setting of the PC where the viewer is running.
- Up to 30 viewers can access the camera simultaneously. If this limit has been exceeded, a message appears instead of video.

Audio cannot be used

- When audio cannot be used, check the audio server settings of the camera, as well as the sound and audio device settings of the PC.
- When you use the Admin viewer as an Administrator, make sure that no viewer with the Administrator privilege, such as VK viewer, has already been using the audio capability on the same camera.
- Audio cannot be received via a proxy server.

Video recording steam cannot be used

- The stream for recording is not available when HTTP upload or FTP upload is enabled in "Upload" in the "Upload" menu. In order to use the steam for recording, set "Upload Disabled" in "Upload" (→ P.1-21).

Cannot control the camera

- Anyone who connects to the Admin viewer as an Administrator occupies camera control. Therefore, if you are connecting the Admin viewer as an Authorized user, you cannot get the camera control privilege until the Administrator releases it. Contact the Administrator (→ P.3-3).

The viewer is disconnected

- Check that the network or PC is working property.
- Reboot the PC and reconnect to the camera.

Have forggotten the password

- You can initialize all the settings by using the reset switch (→ P.5-15). The factory default password is "VB-C60." However, all settings including network settings, such as the IP address and subnet mask are also initialized, so you need to be set again.

Cannot upload images

- Make sure that you have correctly set both the upload destination in the "Upload" menu, and event upload operation in the "Event" menu.
- You can check the performance of already-applied setting of upload destination with the "Test" submenu in the "Upload" menu (→ P.1-22, 1-23, 1-24).
- Be sure to check detailed operating conditions through log events in the "Maintenance" menu or logs on the server. See "Application Messages (Uploader)" (→ P.5-8) and Note in Page 1-21.
- Contact the system administrator for server settings.

Log Message List

VB-C60 Log Messages

Log messages are divided into the following 6 categories.

Classification	Level	Code	Error level
alert	Error	5xx	Hardware level failure (system operation stops)
crit	Error	4xx	Software level failure (task operation stops)
err	Error	3xx	A failure affecting camera operation (task continues)
warning	Warning	2xx	A failure not affecting the camera operation
notice	Warning	1xx	A failure external to the system
info	Information	0xx	Information regarding normal operation

■ Application Messages (Camera)

●A030 WebView Livescope client start and stop

Message	%1%2 host=<host>, user=<user>, prio=<priority>
%1	W: WebView session, V: Sessionless Video Client, N: Sessionless Event Client
%2	+: Connect, -: Disconnect
Explanation	The camera server client has been connected or disconnected.

●A031 Image data transmission quantity

Message	%1 host=<host>, user=<user>, video=<jpg mp4>.<number of frames>
%1	W: WebView session, V: Sessionless Video Client

●A101 Invalid user name

Message	user <user name> not found
Explanation	Access was made by an unauthorized user.

●A102 Invalid password

Message	user <user name> password mismatch
Explanation	The password is invalid.

●A111 Invalid host

Message	host <IP address> access denied
Explanation	Access was made by a prohibited host.

●A160 Pan/tilt sub system recover

Message	<pan tilt> recovered
Explanation	The pan/tilt subsystem being stopped has recovered.
Remark	Refer to A460.

●A201 Registered panorama image failure

Message	corrupt panorama image - ignored
Explanation	The panorama image file is invalid.
Countermeasure	Recapture a panorama image and register it again.
Remark	This may occur when registering a file while it is opened.

●A250 Control failed during camera initialization

Message	camera control timeout - <camera command>
Explanation	A failure occurred during the initialization due to a command timeout (upright/inverted installation, universal head initialization, dome).
Countermeasure	If this is not resolved after a reboot, it is a camera failure.

●A260 Pan/tilt position slipped

Message	<pan/tilt> slipped - c=<error code>
Explanation	A pan/tilt position was misaligned.

●A330 Video input system failure

Message	video input timeout - resetting
Explanation	After video input was stopped, the video input system was reset.
Countermeasure	If the problem persists, it is a camera failure.

●A350 Camera control system

Message	camera status timeout - resetting (A350)
Explanation	The camera control system was reset because a communication timeout with the camera occurred.
Countermeasure	If the problem persists, it is a camera failure.

●A450 Camera initialization failed

Message	camera initialization failure - <error code> (A450)
Explanation	The camera control function was stopped because the camera control system could not be initialized.
Countermeasure	If this is not resolved after a reboot, it is a camera failure.

●A460 Pan/tilt sub system stop

Message	<pan tilt> stopped - c=<error code> (A460)
Explanation	The pan/tilt control function was disabled because a failure occurred while controlling the pan/tilt.
Countermeasure	If this is not resolved after a reboot, it is a camera failure.
Remark	Recover it at http://vbip/-vwhttp-01-/platformreset (if it is not a camera failure).

■ Application Messages (Uploader)

●A004 Uploader start and stop [info]

Message	%1 uploader (A004)
%1	Start (starting) or stop (stopping)
Explanation	The uploader has started or stopped.

●A120 Upload destination name resolution failed [notice]

Message	uploader cannot resolve the server name (A120)
Explanation	Name resolution of the upload destination failed.

●A121 Upload destination connection failed [notice]

Message	uploader cannot connect the server (A121)
Explanation	connect () to the upload destination failed.

●A122 Upload destination connection failed [notice]

Message	uploader cannot connect the server (A122)
Explanation	Connection to the upload destination failed due to a cause other than A120 and A121.

●A130 Buffer recovery of stream for recording [notice]

Message	stream buffer recovered - lost=<number of the lost frames> (A130)
Explanation	Image buffering for stream for recording was recovered.

●A134 Invalid upload setting value (FTP/HTTP mode) [notice]

Message	ftp/http mode invalid. uploader set <none> forcibly(A134)
Explanation	The setting value of the upload method was invalid. "none" (do not upload) was set forcibly.

●A135 Invalid upload setting value (PORT/PASV mode for FTP) [notice]

Message	ftp port/pasv mode invalid. uploader set <pasv> forcibly(A135)
Explanation	The setting value of the PORT/PASV mode for FTP upload was invalid. "PASV mode" was set forcibly.

●A136 Invalid upload setting value (HTTP notice only/image mode) [notice]

Message	http notice/image mode invalid. uploader set <image> forcibly(A136)
Explanation	The setting value of notice only/image mode for HTTP upload was invalid. "Image mode" was set forcibly.

●A137 Invalid upload setting value (e-mail notification) [notice]

Message	smtp mode invalid. uploader set <none> forcibly(A137)
Explanation	The setting value of e-mail notification was invalid. "none" (do not send e-mail notification) was set forcibly.

●A138 Invalid upload setting value (e-mail notification authentication method) [notice]

Message	authentication mode invalid. uploader set <smtp auth> forcibly(A138)
Explanation	The setting value of the e-mail notification authentication method was invalid. "SMTP_AUTH" was set forcibly.

●A230 Warning detection of video input [warning]

Message	stream buffer overflowed (A230)
Explanation	Image buffer for stream for recording overflowed and it started discarding images.

●A270 Upload image buffer overflow [warning]

Message	%1 images are lost due to upload buffer overflow (A220)
Explanation	Image buffer overflowed with upload images.
Countermeasure	Adjust to reduce the frequency of events and adjust the image quality and size of images to be uploaded.

●A271 E-mail notification communication buffer overflow [warning]

Message	mail queue is full (A271)
Explanation	Communication buffer overflowed with e-mail notification.
Countermeasure	Adjust to reduce the frequency of events and adjust the image quality and size of images to be uploaded.

●A272 Upload communication buffer overflow

Message	ftp/http queue is full (A272)
Explanation	Communication buffer overflowed with upload.
Countermeasure	Adjust to reduce the frequency of events and adjust the image quality and size of images to be uploaded.

●A470 Uploader initialization failed [crit]

Message	uploader initialization failure - %1 (A470)
%1	Error number
Explanation	The uploader initialization failed.
Countermeasure	If this is not resolved after a reboot, it is a camera failure.

■ Application Messages (Audio Server)

●B001 Audio server start and stop [info]

Message	%1 vvaudio
%1	starting shutdown
Explanation	The Audio Server has started or stopped.

●B011 Audio client start [info]

Message	[%1] %2 connected n=%3
%1	Client type (send recv)
%2	Client host IP address
%3	Total number of clients
Explanation	An audio client has been connected to the Audio Server.

●B012 Audio client stop [info]

Message	[%1] %2 closed [%3]
%1	Client type (send recv)
%2	Client host IP address
%3	Disconnection type (active passive sender)
Explanation	An audio client has been disconnected from the Audio Server.

●B101 Abnormal request received [notice]

Message	%1 unusual request [%2]
%1	Client host IP address
%2	Error type (400 404 ...)
Explanation	A request was rejected due to a command error (400) or parameter error (404).

●B102 Client connection rejected [notice]

Message	%1 request denied [%2]
%1	Client host IP address
%2	Rejection type (41 43 ...)
Explanation	A client connection was rejected due to an authentication error (41), resource shortage (43), specification of an unsupported codec (45), specification of an unsupported stream (46), restriction on the number of clients (49), operation mode (4a).
Countermeasure	41: Check the user name, password, or user list. 43: Reconnect or reboot the camera. 45-46: Use supported client software. 49: Check the setting of the number of clients. 4a: Check that use of the Audio Server is allowed.

●B103 Client forcibly disconnected [notice]

Message	%1 access denied [%2]
%1	Client host IP address
%2	Rejection type (41 43 ...)
Explanation	Although connection was allowed at the start of the session, the settings have been changed to ban the client access and the client has been forcibly disconnected from the Audio Server (the rejection types are the same as B102).

●B301 Transmission audio device error [err]

Message	cannot use audio device for tx [%1 : %2]
%1	Error process (Id buff)
%2	Error number
Explanation	An audio device error was detected.
Countermeasure	Reboot the camera. If the problem persists, ask for service.

●B401 Audio device initialization failed [crit]

Message	audio device initialization error [%1]
%1	Error number
Explanation	The Audio device initialization failed. The Audio Server will stop.
Countermeasure	Reboot the camera. If the problem persists, it is an Audio Device failure. Ask for service.

●B402 Audio Server initialization failed [crit]

Message	wvaudio initialization error [%1]
%1	Error number
Explanation	The Audio Server initialization failed. The Audio Server will stop.
Countermeasure	Reboot the camera. If the problem persists, it is an Audio Server failure. Ask for service.

●B403 Setting change failed [crit]

Message	cannot set config [%1]
%1	Error number
Explanation	Update of the setting values failed. The Audio Server will stop.
Countermeasure	Reboot the camera. If the problem persists, it is an Audio Server failure. Ask for service.

■ HTTP Server Messages

●H143 User name specification failure [notice]

Message	(http_auth.c.858) get_password failed (H143)
Explanation	An unknown user has been specified in the user authentication.

●H144 Password specification failure [notice]

Message	(http_auth.c.865) password doesn't match for %1 %2 (H144)
%1	URL Name of the user who executed the countermeasure for XSS vulnerability (process equivalent to ftpd)
%2	User Name
Explanation	An incorrect password has been specified in the user authentication.

●H145 Connection rejected due to host access restriction [notice]

Message	(mod_haccess.c.XXX) host %1 access denied (H145)
%1	IP Address
Explanation	A connection has been rejected due to host access restriction.

■ System Messages

●S004 System start and stop [info]

Message	%1 webview
%1	Start (starting) or stop (stopping)
Explanation	The Video Server (webview) has started or stopped.

●S005 System setting changed [info]

Message	(vbadm.c.XXX) System settings updated (S005)
Explanation	The settings have been changed without a reboot.

●S240 Camera error [warning]

Message	serviceman call (S240)
Explanation	The camera may have an error. Ask for service.

●S306 Error in saving setting values [err]

Message	Can't update system settings (S306)
Explanation	An error occurred when saving setting values in the system. The setting values failed to be saved.
Countermeasure	Need to make space by, for example, deleting unnecessary files in the user area.



●S307 Error in saving setting values [err]

Message	(vbadm.c.XXX) Can't update system settings (S307)
Explanation	An error occurred when saving setting values using the setting protocol. The setting values failed to be saved.
Countermeasure	Need to make space by, for example, deleting unnecessary files in the user area.

VB-C60 Viewer Message List

Messages displayed in the Information Field

Messages displayed in the Information Field in the viewer are divided into following three categories.

Icon	Classification	Description
	Information message	help messages for buttons and pull-down menus, pan/tilt/zoom information from the camera, frame rate information, bit rate information, etc.
	Warning message	messages to alert users, for example, when an unsupported browser is used, an audio session is disconnected, etc.
	Error message	messages to notify users of errors in the viewer.

■ Information Messages

*The message is displayed when the mouse cursor is placed on the following GUI parts

Message	GUI parts
Changes video display size.	Video Capture Size Change UI
Changes video capture size.	Video Display Size Change UI
Switches to full screen mode.	Full Screen Mode button
Pauses/Resumes video.	Pause/Resume button
Reconnects to the camera.	Reconnect button
Starts/Stops receiving audio.	Audio Reception button
Displays camera controls for administrators.	Control for Admin button
Changes zoom ratio.	Scroll bar for zoom
Zoom-in the camera.	Zoom Controller (tele)
Zoom-out the camera.	Zoom Controller (wide)
Switches on/off backlight compensation.	Backlight Compensation button
Displays camera control privilege status.	Control Privilege Status Indicator
Switches on camera control privilege.	Obtain/Release Control privilege button
Switches on/off camera control privilege.	Obtain/Release Control privilege button
Moves the center of the camera's image to the clicked position.	Video Display area
Displays the panorama image as a camera control.	Panorama Display area
Controls the camera to preset positions.	Preset
Displays information.	Information Field

Message	Description
Connection closed by the camera.	The connection with the camera has been closed.
{n}fps Pan : {p} Tilt : {t} Zoom : {z}	Displayed during normal communication with the camera.
{n}fps Pan : {p} Tilt : {t} Zoom : {z} IS : {Image stabilization setting}	Displayed during normal communication with the camera.
Audio connection has been closed.	This message is displayed when an audio session was disconnected while video session is running (for both transmission and reception systems).

■ Warning Messages

Message	Description
Your web browser is not supported.	Unsupported browser is being used.

■ Error Messages

Message	Description
No response from the camera.	Connection failed because of an invalid IP address or other reasons.
The camera is not available because of too many users.	The maximum number of connections has been exceeded.
Failed to get camera control privilege.	The control privilege request was rejected because it is currently being used by an Admin viewer or other reasons.
The camera is not available for free accesses.	The viewer cannot connect to the camera due to the address restriction or out of service hours.
Failed to establish audio connection.	Connection to receive audio failed.
Please connect to the camera.	You attempted to operate the camera without connecting the viewer to the camera.
Please switch on camera control privilege.	You attempted to operate the camera without obtaining the camera control privilege.
Another user is already connected as Administrator.	Another Admin viewer has already been connecting to the camera.
The viewer is already available in another window.	The viewer is already available in another window.
Cookie is not available or blocked on your web browser.	Cookie is not available or blocked on your web browser.
JavaScript is not available or disabled on your web browser.	JavaScript is not available or disabled on your web browser.

Restore the Factory Default Settings

Since VB-C60 supports various functions, it is recommended to take a note of each setting value. If you need to redo settings from the beginning because you have forgotten them or for some other reasons, restore the factory default settings.

* For information on the factory default settings, refer to P.5-16.

Restore the Factory Default Settings from the Maintenance Menu Using a Web Browser

1. Start a Web browser and access the camera's setting page

The camera's IP address, user name and administration password are required to display the setting page (→ P. 1-8).



2. Click "Maintenance" on the setting page

The Maintenance page is displayed.

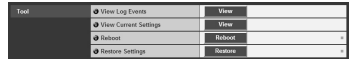

3. Click "Restore" in the "Restore Settings" submenu

A message of whether to restore the factory default settings is displayed for confirmation. Click "OK" to restore the factory default settings.

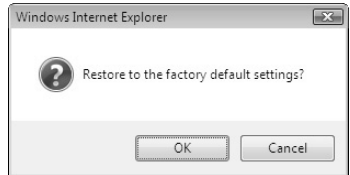

Note

- Never power off the camera while the restore operation is in progress. If turning off before completion, the camera may not work properly.
- Once you click "OK", the process cannot be cancelled.

4. All settings in the camera will be returned to the factory default settings

All settings will be restored to the factory default settings, except camera's administrator password, IP address, subnet mask, default gateway address, date and time, time zone, LAN interface, maximum transmission unit, and IPv6 use. The camera will be automatically rebooted after the restoring process.

Initialize the Camera using the Reset Switch

If you have forgotten the IP address or Administrator password of VB-C60, you cannot control the camera via the network. In this case, press the reset switch on the rear of the camera.

1. Power off the camera

For information on how to power on/off the camera, refer to “Turning ON / OFF” (→  Start Guide P.2-7).

2. Switch on the camera with holding down the reset switch, then keep holding the reset switch for at least 5 seconds

The reset switch is recessed from the rear panel. Use a thin tipped object to press the reset switch.

All settings will be initialized.

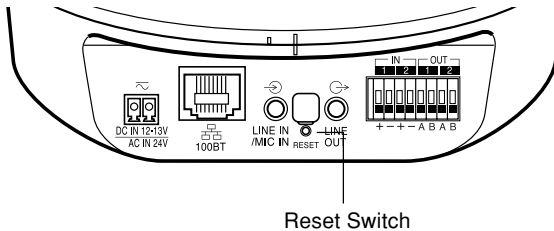

Note If you use the reset switch to initialize VB-C60, all the settings including the network-related settings (IP address, subnet mask, and default gateway address) will be initialized. Therefore, you cannot use the camera from the PC connected to the camera via the network after reset. Set the IP address for your environment using “VB Initial Setting Tool v4.0” installed in the PC when initializing the camera (→  Start Guide P.2-9).

List of Factory Default Settings

The following table lists the factory default settings. When you have changed these settings, be sure to make a note of the new values.

Item	Setting	Item Setting 1 (year/month/day)	Item Setting 2 (year/month/day)
<ul style="list-style-type: none"> ● User name (Administrator ID) ● Administrator password 	<ul style="list-style-type: none"> root VB-C60 		
<ul style="list-style-type: none"> ● Setting page path 	<ul style="list-style-type: none"> admin 		
<ul style="list-style-type: none"> ● LAN IP Address Setting IP Address Subnet Mask Default Gateway Address LAN Interface Maximum Transmission Unit ● IPv6 IPV6 IPV6 Address ● DNS Name Server Address 1 Name Server Address 2 Host name Register the Host Name in DDNS ● SNMP SNMP Community Name Administrator Contact Information Administration Function Names Installation Location 	<ul style="list-style-type: none"> Manual 192.168.100.1 255.255.255.0 Auto 1500 Enable Enable Disable Disable public VB-C60 		
<ul style="list-style-type: none"> ● Current Date and Time ● Setting Setting Method NTP Server (IP Address) Time Zone 	<ul style="list-style-type: none"> Set manually (GMT+09:00) Osaka, Sapporo, Tokyo 		
<ul style="list-style-type: none"> ● Camera Name Camera name (alphanumeric characters) ● Camera Initial Settings AE Mode Slow Shutter Shutter Speed Focus Mode ● Camera Control Digital Zoom Image Stabilizer ● Day/Night Mode Switching Brightness Response (sec.) ● Installation Conditions Dome LED Setting Mount ● Camera Position Control Restricts to Presets Camera position without control ● Input Device 1 External Input Device Name (alphanumeric characters) ● Input Device 2 External Input Device Name (alphanumeric characters) ● Output Device 1 External Output Device Name (alphanumeric characters) ● Output Device 2 External Output Device Name (alphanumeric characters) 	<ul style="list-style-type: none"> Camera Auto Disable 1/100 Auto Disable Disable Manual Standard 20 Not used Turn On On the ceiling No Restriction Do not return to Home Position 		
<ul style="list-style-type: none"> ● JPEG Image Quality: 160 X 120 Image Quality: 320 X 240 Image Quality: 640 X 480 Image Size: Image Transmission Maximum Frame Rate: Image Transmission Image Size: Upload ● MPEG-4 Video Quality Video Size Capture Frame Rate 	<ul style="list-style-type: none"> 3 3 3 320 x 240 30.0 320 x 240 3 320 x 240 30 		
<ul style="list-style-type: none"> ● General Upload Upload 	<ul style="list-style-type: none"> Upload Disabled 		

Item	Setting	Item Setting 1 (year/month/day)	Item Setting 2 (year/month/day)
<ul style="list-style-type: none"> ● HTTP Upload <ul style="list-style-type: none"> Notification URI User Name Password Proxy Server Proxy Port Proxy User Name Proxy Password Parameter (query string) ● FTP Upload <ul style="list-style-type: none"> Notification FTP Server User Name Password PASV Mode File Upload Path File Naming <ul style="list-style-type: none"> Subdirectory Name to Create File Name to Create Maximum Number of Loops ● E-mail Notification <ul style="list-style-type: none"> Notification Mail Server Name Mail Server Port Sender (From) Recipient (To) Authentication <ul style="list-style-type: none"> User Name Password POP Server Subject Message 	<p>Notification Only with HTTP</p> <p>80</p> <p>Image data upload with FTP</p> <p>Enable</p> <p>YYMMDDHHMMSSms</p> <p>image.jpg</p> <p>0</p> <p>Text only</p> <p>25</p> <p>None</p>		
<ul style="list-style-type: none"> ● Image Server <ul style="list-style-type: none"> Maximum Number of Clients Camera Control Queue Length Maximum Connection Time (sec.) Camera Control Time (sec.) ● Audio Server <ul style="list-style-type: none"> Audio Transmission from the Camera <ul style="list-style-type: none"> Input Volume Voice Activity Detection Audio Reception from the viewer <ul style="list-style-type: none"> Output Volume Echo Canceller Audio Input ● HTTP Server <ul style="list-style-type: none"> HTTP Port Global Address for the Web Pages IP Address (global address for the Web page) Port Number (global address for the Web page) 	<p>30</p> <p>30</p> <p>0</p> <p>20</p> <p>Disable</p> <p>50</p> <p>Disable</p> <p>Disable</p> <p>50</p> <p>Disable</p> <p>Line In</p> <p>80</p> <p>IP Address</p>		
<ul style="list-style-type: none"> ● Image Buffer <ul style="list-style-type: none"> Frame Rate Pre-event Buffer (number of image frames) Post-event Buffer (number of image frames) ● Motion Detection <ul style="list-style-type: none"> Motion Detection Event ON Event Operation OFF Event Operation Continuous Motion Operation Upload E-mail Notification Audio playback at ON event Audio playback at OFF event <ul style="list-style-type: none"> Sound Clip Volume Automatic Tracking at ON event <ul style="list-style-type: none"> Maximum tracking time (sec.) 	<p>1</p> <p>0</p> <p>0</p> <p>Enable</p> <p>Disable</p> <p>Disable</p> <p>Disable</p> <p>Disable</p> <p>Disable</p> <p>Disable</p> <p>Disable</p> <p>50</p> <p>Disable</p> <p>60</p>		

Item	Setting	Item Setting 1 (year/month/day)	Item Setting 2 (year/month/day)
<ul style="list-style-type: none"> ● IPsec Set 1 IPsec IPsec Mode Destination Address (IPv4/IPv6) Source Address (IPv4/IPv6) Security Protocol Security Gateway Address (IPv4/IPv6) Destination Prefix Length SA ESP Encryption Algorithm SA ESP Authentication Algorithm SA ESP Encryption Key (outbound) SA ESP Authentication Key (outbound) SA ESP SPI (outbound) SA ESP Encryption Key (inbound) SA ESP Authentication Key (inbound) SA ESP SPI (inbound) SA AH Authentication Algorithm SA AH Authentication Key (outbound) SA AH SPI (outbound) SA AH Authentication Key (inbound) SA AH SPI (inbound) 	<p>Disable Tunnel Mode</p> <p>ESP</p> <p>0 AES HMAC_SHA1_96</p> <p>HMAC_SHA1_96</p>		
<ul style="list-style-type: none"> ● IPsec Set 2 IPsec IPsec Mode Destination Address (IPv4/IPv6) Source Address (IPv4/IPv6) Security Protocol Security Gateway Address (IPv4/IPv6) Destination Prefix Length SA ESP Encryption Algorithm SA ESP Authentication Algorithm SA ESP Encryption Key (outbound) SA ESP Authentication Key (outbound) SA ESP SPI (outbound) SA ESP Encryption Key (inbound) SA ESP Authentication Key (inbound) SA ESP SPI (inbound) SA AH Authentication Algorithm SA AH Authentication Key (outbound) SA AH SPI (outbound) SA AH Authentication Key (inbound) SA AH SPI (inbound) 	<p>Disable Tunnel Mode</p> <p>ESP</p> <p>0 AES HMAC_SHA1_96</p> <p>HMAC_SHA1_96</p>		
<ul style="list-style-type: none"> ● IPsec Set 3 IPsec IPsec Mode Destination Address (IPv4/IPv6) Source Address (IPv4/IPv6) Security Protocol Security Gateway Address (IPv4/IPv6) Destination Prefix Length SA ESP Encryption Algorithm SA ESP Authentication Algorithm SA ESP Encryption Key (outbound) SA ESP Authentication Key (outbound) SA ESP SPI (outbound) SA ESP Encryption Key (inbound) SA ESP Authentication Key (inbound) SA ESP SPI (inbound) SA AH Authentication Algorithm SA AH Authentication Key (outbound) SA AH SPI (outbound) SA AH Authentication Key (inbound) SA AH SPI (inbound) 	<p>Disable Tunnel Mode</p> <p>ESP</p> <p>0 AES HMAC_SHA1_96</p> <p>HMAC_SHA1_96</p>		
<ul style="list-style-type: none"> ● IPsec Set 4 IPsec IPsec Mode Destination Address (IPv4/IPv6) Source Address (IPv4/IPv6) Security Protocol Security Gateway Address (IPv4/IPv6) Destination Prefix Length SA ESP Encryption Algorithm SA ESP Authentication Algorithm SA ESP Encryption Key (outbound) SA ESP Authentication Key (outbound) SA ESP SPI (outbound) SA ESP Encryption Key (inbound) SA ESP Authentication Key (inbound) SA ESP SPI (inbound) SA AH Authentication Algorithm SA AH Authentication Key (outbound) SA AH SPI (outbound) SA AH Authentication Key (inbound) SA AH SPI (inbound) 	<p>Disable Tunnel Mode</p> <p>ESP</p> <p>0 AES HMAC_SHA1_96</p> <p>HMAC_SHA1_96</p>		
<ul style="list-style-type: none"> ● IPsec Set 5 IPsec IPsec Mode Destination Address (IPv4/IPv6) Source Address (IPv4/IPv6) Security Protocol Security Gateway Address (IPv4/IPv6) Destination Prefix Length SA ESP Encryption Algorithm SA ESP Authentication Algorithm SA ESP Encryption Key (outbound) SA ESP Authentication Key (outbound) SA ESP SPI (outbound) SA ESP Encryption Key (inbound) SA ESP Authentication Key (inbound) SA ESP SPI (inbound) SA AH Authentication Algorithm SA AH Authentication Key (outbound) SA AH SPI (outbound) SA AH Authentication Key (inbound) SA AH SPI (inbound) 	<p>Disable Tunnel Mode</p> <p>ESP</p> <p>0 AES HMAC_SHA1_96</p> <p>HMAC_SHA1_96</p>		

Index

A

Access Control	1-35
Admin Tool	2-2
Admin Viewer	3-8
Audio Transmission from the Camera	3-19
Control for Admin Panel	3-21
Administrator	3-3
Administrator Password	1-7
AE Mode	1-14
Audio	1-27
Audio Distribution	1-36
Audio Reception	3-8, 3-10
Audio Transmission	1-27
Input Volume	1-27
Output Volume	1-27
Audio Server	1-27
Authorized User	3-3

B

Backlight Compensation	2-20, 3-9, 3-16
------------------------------	-----------------

C

Camera Control	1-15
Camera Name	1-13
Camera Parameters	2-20
Camera Position Control	1-17

D

Date	1-11
Date and Time	1-11
Day/Night	1-16
Default Gateway Address	1-8
Digital Zoom	1-15
DNS	1-7, 1-9

E

Echo Canceller	1-27
E-mail Notification	1-24
Event Log	1-44
Exposure	3-25
External Device Input	1-32, 3-22
Display Screen	3-22
Operate	1-32
External Device Names	1-18
External Device Output	3-22
Control	3-22

F

Factory Default	5-14
List of Settings	5-16
Restore	5-14
Filtering	2-38
Focus	1-15
Focus Mode	1-14

Frame Rate	1-19
FTP Upload	1-23

G

Gain	3-26
Global Address	1-28, 4-10
Guest User	3-3

H

Home Position	1-18
Host Access Restriction	1-36
HTTP Port	1-28
HTTP Server	1-28
HTTP Upload	1-22

I

Image Buffer	1-29
Image Quality	1-19
Image Server	1-26
Image Size	1-19
Infrared cut filter	1-17, 3-28
Interval Timer	1-33
IP Address	1-8, 1-28, 1-42, 2-4
IPsec	1-39
IPv6	1-9

J

JPEG	1-19
------------	------

L

LED	1-17
Log	2-37
Copy	2-37
Save	2-37
Search	2-37
Select and View	2-38
Log Codes	2-37
Log Message	5-6
Log Viewer	2-36
Download	2-36
Launch	2-5
Search	2-37
Select and View	2-38
View	2-37

M

Maintenance	1-44
Maximum Frame Rate	1-19
Maximum Transmission Unit	1-8
Microphone	1-27
Mobile Phone	4-11
Modifiers	5-2
Motion Detection	1-30
Motion Detection Setting Tool	2-27
MPEG-4	1-19

N

Name Server Address	1-9
Network	1-7
Night Mode	3-28

P

Pan	2-17, 2-20
Panorama Creation Tool	2-6
Capture	2-8
Display Screen	2-7
Panorama Preview	2-12, 2-19
Password	xiii
Preset	1-32
Preset Preview frame	2-21
Preset Setting Area	2-19
Preset Setting Tool	2-18
Display Screen	2-19
Set	2-21
Preset Tour	2-24
Set	2-26
Proxy	2-4

R

Reboot	1-42
Reconnect	2-10
Recording	2-28
Reset Switch	5-15

S

Sample Pages	4-4, 4-12
Sensitivity	2-31
Server	1-26
Setting Menu	1-2
Setup CD-ROM	viii
Shutter Speed	1-14, 3-26
Slow Shutter	1-14
Smart Shade Control	3-28
SNMP	1-10
Status List	2-13, 2-20
Subnet Mask	1-8

T

Tilt	2-17, 2-20
Time	1-11
Time Zone	1-12
Troubleshooting	5-4

U

Upload	1-21
User Account	1-35
User Authority	1-35, 3-3
User List	1-35
User Name	1-22

V

VB Viewer	3-10
VBAdmin Tools	2-2
VB-C60 Viewer	3-2
View Restriction	2-11
Voice Activity Detection	1-27

W

White Balance	3-27
---------------------	------

Canon

CANON INC.

30-2, Shimomaruko 3-chome, Ohta-ku, Tokyo 146-8501, Japan

CANON U.S.A., INC.

One Canon Plaza Lake Success, NY 11042-1198 USA

● **If you have any questions, call the Canon U.S.A. Information Center toll-free at 1-800-828-4040 (U.S.A. only)**

CANON CANADA INC. NATIONAL HEADQUARTERS

6390 Dixie Road, Mississauga, Ontario L5T 1P7

CANON CANADA INC. CALGARY

2828, 16th Street, N.E, Calgary, Alberta T2E 7K7

CANON CANADA INC. MONTRÉAL

8801 Trans Canada Hwy, St. Laurent Québec H4S 1Z6

● **If you have any questions, call the CANON CANADA Customer Information Centre toll-free at 1-800-OK-CANON (652-2666) (Canada only)**

CANON MEXICANA, S. DE R.L.DE C.V.

Boulevard Manuel Avila Camacho, No. 138 PB, Pisos 15, 16 y 17

Col Lomas de Chapultepec C.P. 11000 México, D.F. México

CANON SINGAPORE PTE. LTD.

1 HarbourFront Avenue, #04-01, Keppel Bay Tower Singapore 098632

CANON HONGKONG CO., LTD.

19/F., The Metropolis Tower, 10 Metropolis Drive, Hunghom, Kowloon, Hong Kong

CANON AUSTRALIA PTY.LTD.

1 Thomas Holt Drive, North Ryde, Sydney, N.S.W. 2113, Australia

CANON EUROPA N.V.

Bovenkerkerweg 59-61, P.O. Box 2262, 1185 XB Amstelveen, The Netherlands

CANON EUROPE LTD.

6 Roundwood Avenue, Stockley Park, Uxbridge Middlesex, UB11 1JA, United Kingdom

CANON COMMUNICATION & IMAGE FRANCE

12 Rue De L'Industrie, 92414 Corbevoie, Cedex, France

CANON (UK) LTD.

Woodhatch, Reigate, Surrey RH2 8BF, United Kingdom

CANON DEUTSCHLAND GmbH

Europark Fichtenhain A 10, 47807 Krefeld, Germany

CANON ITALIA S.p.A.

Via Milano, 8 San Donato M. se-20097 (MI), Italy

CANON (Schweiz) A.G.

Industriestrasse 12, 8305 Dietlikon, Switzerland

CANON BELGIUM N.V./S.A

Bessenveldstraat 7, 1831 Diegem, Belgium

CANON GmbH

Zetschegasse 11, A-1230 Wien, Austria

CANON ESPAÑA,S.A.

Avda. de Europa, 6 Alcobendas, 28108 Madrid, Spain

CANON SVENSKA AB

Gustav III:s, Boulevard 26, 169 88 Solna, Sweden

CANON NORGE A/S

Hallagerbakken 110, P.O. Box 33, Holmlia, N-1201 Oslo, Norway

CANON OY

Huopalahdentie 24, P.O. Box 1, FIN-00351 Helsinki, Finland

CANON DANMARK A/S

Knud Høejaards Vej 1, DK-2860, Soeborg, Denmark

Free Manuals Download Website

<http://myh66.com>

<http://usermanuals.us>

<http://www.somanuals.com>

<http://www.4manuals.cc>

<http://www.manual-lib.com>

<http://www.404manual.com>

<http://www.luxmanual.com>

<http://aubethermostatmanual.com>

Golf course search by state

<http://golfingnear.com>

Email search by domain

<http://emailbydomain.com>

Auto manuals search

<http://auto.somanuals.com>

TV manuals search

<http://tv.somanuals.com>