



Network Camera

Operation Guide



VB-R11VE/VB-R11

VB-R10VE

VB-M641VE/VB-M641V

VB-M640VE/VB-M640V

VB-M741LE/VB-M740E

Introduction

Thank you for purchasing a Canon Network Camera (hereafter referred to as the camera)*.

This "Operation Guide" explains the camera settings and operations. Read this guide carefully before using the camera to ensure correct use. Also, be sure to read the files in the LICENSE folder on the Setup CD-ROM.

* The cameras described in this manual may include models not be sold in your country and region.

For the latest information on this product (firmware and included software, user manuals, operating environment, etc.), please refer to the Canon Web Site.

Precautions for Use (Disclaimer)

■ Disclaimer

To the full extent permitted by laws and regulations, neither Canon Inc. nor any of its subsidiaries or affiliates shall be responsible for any financial losses that may be incurred as a result of the loss of recorded information or images, regardless of the internal or external cause of the loss.

EXCEPT AS SET FORTH IN THE LIMITED WARRANTY ACCOMPANYING THE CAMERA AND WITHOUT DETRACTING FROM ANY RIGHTS A CONSUMER MAY BE ENTITLED TO, AND TO THE FULL EXTENT PERMITTED BY LAWS AND REGULATIONS: (1) NEITHER CANON INC. NOR ANY OF ITS SUBSIDIARIES OR AFFILIATES MAKE ANY WARRANTY OF ANY KIND, EXPRESS OR IMPLIED, WITH REGARD TO THE MATERIAL IN THIS MANUAL OR WITH REGARD TO THE USE OF THE CAMERA INCLUDING, WITHOUT LIMITATION, IMPLIED WARRANTIES AS TO MARKETABILITY, MERCHANTABILITY, FITNESS FOR A PARTICULAR PURPOSE OR USE, OR NON-INFRINGEMENT AND (2) NEITHER CANON INC. NOR ANY OF ITS SUBSIDIARIES OR AFFILIATES SHALL BE LIABLE FOR ANY DIRECT, INCIDENTAL, OR CONSEQUENTIAL DAMAGES OF ANY NATURE RESULTING FROM THE USE OF THIS MATERIAL OR THE CAMERA.

■ Network Security

The user is responsible for the network security of this product and its use.

Take appropriate network security measures to avoid security breaches. To the full extent permitted by laws and regulations, neither Canon Inc. nor any of its subsidiaries or affiliates shall be liable for any losses, direct, incidental or consequential damages, or liabilities that may be incurred as a result of network security incidents such as unauthorized accesses.

<Network Security Recommendations>

- Change the password of the camera periodically.
- Change the HTTP or HTTPS port number of the camera.
- Limit access to the camera by network devices.

■ Privacy and Publicity Rights Regarding the Use of Video/Audio

When using the camera (for video or audio), it is the full responsibility of the user to protect privacy and avoid any violation of publicity rights. For example, obtaining consent to install the camera in advance if specific buildings or rooms are to be monitored. Canon shall have no liability whatsoever in this regard.

Legal Notice

In some cases, camera monitoring may be prohibited by law or regulation, the details of which differ by country. Before using the camera, check the laws or regulations of the country or region where the camera is used.

■ Copyright

Videos, images or sounds recorded with your camera may not be utilized or published without consent of copyright holders, if any, except in such a way as permitted for personal use under the relevant copyright law.

■ Use of Included RM-Lite Software

Flaws or other problems with RM-Lite may result in recording failure or destruction or loss of recorded data. Canon shall have no liability whatsoever for any loss or damages incurred by the user as a result of such problems.

■ Product Parts Life

Movable parts of this product (e.g., pan/tilt mechanism) as well as its electronic components may require replacement at an earlier period, according to where the product is installed, and how it is used.

Please refer to Canon's web site, for a reference as to the lifespan of the parts, in relation to how the product is used.

License Agreement for Included Software

For information on the License Agreement for Included Software, refer to the following files in the BundledSoftware folder in the Included Setup CD-ROM LICENSE folder.

Software Type	File Name
Camera Management Tool	VBTools-E.txt
Camera Angle Setting Tool (Used by VB-M641VE, VB-M640VE, VB-M641V, VB-M640V, VB-M741LE, VB-M740E)	
Network Video Recording Software RM-Lite	RM-Lite-E.txt

This product is licensed under AT&T patents for the MPEG-4 standard and may be used for encoding MPEG-4 compliant video and/or decoding MPEG-4 compliant video that was encoded only (1) for a personal and non-commercial purpose or (2) by a video provider licensed under the AT&T patents to provide MPEG-4 compliant video. No license is granted or implied for any other use for MPEG-4 standard.

Trademarks

- Canon and the Canon logo are registered trademarks of Canon Inc.
- Microsoft, Windows, Windows Vista, Internet Explorer, Windows Server, Windows Media and ActiveX are trademarks or registered trademarks of Microsoft Corporation in the United States and other countries.
- Windows is legally recognized as the Microsoft Windows Operating System.
- This product comes with exFAT, a licensed file system technology from Microsoft.
- QuickTime is a trademark of Apple Inc.
- SD, SDHC and SDXC logos are trademarks of SD-3C, LLC.
- All other company or product names used in this manual are trademarks or registered trademarks of their respective holders.

Open Source Software

The product (camera and included RM-Lite) contains Open Source Software modules. For details, please refer to "ThirdPartySoftware-E.pdf" (Third-Party Software License) in the Open-SourceSoftware folder in the LICENSE folder on the Setup CD-ROM. Each module's license conditions are also available in the same folder.

Software under GPL and LGPL

If you would like to obtain the source code under GPL/LGPL, please contact us at nvsossg@canon.co.jp and provide the following information in English or Japanese:

1. Product name and firmware version.

2. Name of the software module or modules you would like to obtain.

You can obtain the source code for a least three years from the day you purchased this product. Please note we may bill you for any costs we incur in providing you the source code.

Security Export Control

This product is subject to security export control. Therefore, to export or carry it overseas may require an authorization by governmental agencies.

Types of User Manuals

The following describes the different camera user manuals.

Included User Manuals

Installation Guide

This describes precautions and procedures for installing the camera. Sections you should reference in this guide will be marked "Installation Guide" along with the name of the reference items.

Guides Included on the Setup CD-ROM

Operation Guide (This Guide)

This document explains the initial camera settings, Viewer operations, Admin Tools settings, troubleshooting and other operations.

Appendix – Specifications

This lists the camera specifications.

Camera Management Tool User Manual

This explains details on using the Camera Management Tool.

Network Video Recording Software RM Series Administrator Manual

This explains details on using the RM-Lite video recording software (P. 22).

■ Notes

1. Any unauthorized reproduction of this guide is prohibited.
2. The contents of this guide are subject to change without any prior notice.
3. This document has been prepared with the utmost attention to accuracy. If you have any comments, however, please contact a Canon sales representative.
4. Canon shall assume no liability for any outcome of using this product, notwithstanding items 2 and 3 above.

How to Use This Operation Guide

The assumed reading format of this operation guide is on a computer screen.

■ Software Screenshots

The software screenshots samples shown in this guide are for illustration only. The screenshots may differ from the actual screens displayed.







Most screenshots used with the explanations are from a Windows 8.1 computer connected to a VB-R11 network camera.

The video size set selected for explanations is [1280 x 720 / 640 x 360 / 320 x 180]. If using a different video size set, substitute those sizes.

Symbols Indicating Camera Models





■ Symbols Indicating Camera Models

Explanations that differ depending on the camera model are indicated by the camera name and the following symbols.

Symbol	Camera Model
 R11	VB-R11VE, VB-R11
 R10	VB-R10VE
 M641	VB-M641VE, VB-M641V
 M640	VB-M640VE, VB-M640V
 M741	VB-M741LE
 M740	VB-M740E

■ Symbols Indicating Safety Precautions

This section explains the symbols used in this guide. The following symbols used in this guide indicate information for safe use of the product, as well as important and supplemental information the user should know. Be sure to read and understand this information when using the product.

Symbol	Meaning
 Warning	Failure to follow the instructions indicated by this symbol may result in death or serious injury. Be sure to follow these warnings to ensure safety.
 Caution	Failure to follow the instructions indicated by this symbol may result in injury. Be sure to follow these precautions to ensure safety.
Caution	Failure to follow the instructions indicated by this symbol may result in property damage. Be sure to follow these precautions.
 Important	Cautions and restrictions during operation. Make sure to read these carefully.
 Note	Supplementary descriptions and reference information.

Safety Precautions

This section explains precautions that must be followed when using the camera.

If they are not followed, injury, death and/or property damage may occur. Read the following information carefully and be sure to follow the precautions.

Important Warnings

Warning

To reduce a risk of fire or electric shock, do not expose this product to rain or moisture.
(VB-R11, VB-M641V, VB-M640V)

Caution

TO REDUCE THE RISK OF ELECTRIC SHOCK, DO NOT REMOVE COVER (OR BACK).
NO USER-SERVICEABLE PARTS INSIDE. REFER SERVICING TO QUALIFIED SERVICE PERSONNEL.

The AC adapter (sold separately) can be connected to the camera from a standard AC power outlet. Please refer to the user manual to make sure that the camera is compatible with the adapter.

- The socket-outlet should be installed near the equipment and should be easily accessible.
- Unplug the equipment from the wall outlet before cleaning or maintaining.

FDA regulation

This Network Camera has not been evaluated by the Food and Drug Administration (FDA) for use as a medical device. When incorporated into a system with medical applications, FDA regulations may apply. Therefore, please consult your legal advisor to determine whether FDA regulations apply.

FCC REGULATIONS

Network Camera, Model Name: VB-R11VE/VB-R10VE/VB-M641VE/VB-M640VE/VB-M741LE/VB-M740E

This equipment has been tested and found to comply with the limits for a Class A digital device, pursuant to Part 15 of the FCC Rules.

These limits are designed to provide reasonable protection against harmful interference when the equipment is operated in a commercial environment. This equipment generates, uses, and can radiate radio frequency energy and, if not installed and used in accordance with the user manual, may cause harmful interference to radio communications. Operation of this equipment in a residential area is likely to cause harmful interference in which case the user will be required to correct the interference at his own expense.

Do not make any changes or modifications to the equipment unless otherwise specified in the manual. If such changes or modifications should be made, you could be required to stop operation of the equipment. Use of shielded cable is required to comply with class A limits in Subpart B of Part 15 of FCC Rules.

European Union regulatory notices:

Network Camera, Model Name: VB-R11VE/VB-R10VE/VB-M641VE/VB-M640VE/VB-M741LE/VB-M740E

Warning

This is a class A product. In a domestic environment this product may cause radio interference in which case the user may be required to take adequate measures.

FCC NOTICE

Network Camera, Model Name: VB-R11/VB-M641V/VB-M640V

This device complies with Part 15 of the FCC Rules. Operation is subject to the following two conditions: (1) This device may not cause harmful interference, and (2) this device must accept any interference received, including interference that may cause undesired operation.

Note: This equipment has been tested and found to comply with the limits for a Class B digital device, pursuant to Part 15 of the FCC Rules. These limits are designed to provide reasonable protection against harmful interference in a residential installation.

This equipment generates, uses and can radiate radio frequency energy and, if not installed and used in accordance with the instructions, may cause harmful interference to radio communications.

However, there is no guarantee that interference will not occur in a particular installation. If this equipment does cause harmful interference to radio or television reception, which can be determined by turning the equipment off and on, the user is encouraged to try to correct the interference by one or more of the following measures:

- Reorient or relocate the receiving antenna.
- Increase the separation between the equipment and receiver.
- Connect the equipment to an outlet on a circuit different from that to which the receiver is connected.
- Consult the dealer or an experienced radio/TV technician for help.

Do not make any changes or modifications to the equipment unless otherwise specified in the manual. If such changes or modifications should be made, you could be required to stop operation of the equipment.

Canon U.S.A., Inc.

One Canon Park, Melville, New York 11747, U.S.A.

Tel No. 1-800-OK-CANON (1-800-652-2666)

Precautions

■ Camera Precautions

 Warning
<p>If you notice abnormal conditions, such as smoke, unusual sounds, heat or strange odors, immediately stop using the camera and contact your nearest dealer. Fire or electric shock may result from continued use.</p>
<p>The following may result in fire or electric shock.</p> <ul style="list-style-type: none">• If thunder starts, stop installation or inspection etc. and do not touch the camera or continue connecting the cable.• Do not disassemble or modify the camera.• Spray the camera with water, or otherwise make it wet (VB-R11/VB-M641V/VB-M640V).• Please do not insert objects like water or metal objects within the camera housing.• Do not use flammable sprays near the camera.• Do not leave LAN cables, external power supplies or AC adapter (sold separately) power connectors connected when the camera is not in use for long periods.• Do not damage the connecting cable.
<p>This camera should not be used with medical devices or other life-support systems. Depending on the computer and network environment, high-precision video transmission cannot be guaranteed due to video lag or loss. Canon will assume no liability for any accident or damage resulting from use of the camera under the conditions above.</p>

 Caution

M741

Avoid looking directly at the infrared illumination at close distance for long periods of time.
Intense infrared illumination can cause eye damage.

Caution

The following may result in camera malfunction.

- Do not capture the sun, halogen lamps, and other very bright light sources or subjects.
- Do not expose the camera to strong impact or vibration.

R11 R10 M641 M640

- Do not forcibly turn the rotating parts of the camera by hand.

■ Camera Angle Setting Tool Precautions

M641 M640 M741 M740

Caution

The Camera Angle Setting Tool is for use when installing the camera. Do not use on a daily basis.
Frequent use may result in camera malfunction.

■ Precautions for Built-In Camera Functions and Included Software

Caution

Do not use the following built-in camera functions or included software in situations requiring high reliability:

- Intelligent Function
- Image Stabilization Function
- Network Video Recording Software RM-Lite

These do not guarantee high-precision capture and cannot support applications beyond their intended range of use.
Canon will assume no liability for any accident or damage resulting from the use of these functions or software.

■ Maintenance Precautions

 Warning

Do not use flammable solvents such as alcohol, paint thinner or benzine when cleaning the camera.
Use of these may result in fire or electric shock.

 Caution

Periodically inspect the parts and screws for rust and loosening.
For inspections, please contact the dealer where you purchased the product.
Failure to follow these precautions could result in injuries and equipment damage due to falling items.

Clean the Camera

Turn off the power before cleaning the camera.

■ Clean the Exterior

- 1 Dampen a soft cloth with water or diluted neutral detergent and gently wipe away any grime.
- 2 Wipe with a dry cloth.



Important

Grime on the front cover and dome cover, may result in focusing problems, and or reduction of image quality. It is recommended that the cover be cleaned on a regular basis.

■ Clean the Lens

Use a commercial lens cleaner to remove grime on the lens surface.

- Scratches on the lens surface may result in poor video capture.
- Auto focus functionality may be degraded if the lens surface is dusty or dirty.

Camera Disposal

Dispose of the camera in accordance with local laws and regulations.

Table of Contents

Introduction.....	2
Precautions for Use (Disclaimer)	2
License Agreement for Included Software	3
Trademarks	3
Open Source Software.....	3
Security Export Control	4
User Manuals.....	5
Types of User Manuals	5
How to Use This Operation Guide	5
Symbols Indicating Camera Models.....	6
Safety Precautions.....	7
Precautions	8
Clean the Camera.....	9
Camera Disposal	10

Chapter 1

Before Use

Network Camera Capabilities.....	20
Camera Software	21
Software Included on the Camera	21
Software Included on the Setup CD-ROM.....	21
Additional Software/Licenses (Sold Separately).....	23
Operating Environment.....	24
Camera Angle Setting Tool, Admin Viewer/VB Viewer, Admin Tools	24
Steps for Setting Up Camera.....	25
Step 1 Pre-Installation Preparations.....	25
Step 2 Check Camera Connection	25
Step 3 Install the Camera.....	25
Step 4 Set the Camera Angle	25
Step 5 Adjust Advanced Settings According to Use.....	26
Step 6 Use the Viewers.....	26
Step 7 Use Admin Tools	26
Troubleshooting	26

Chapter 2

Camera Setup

Install Software	28
Necessary Software	28
Software Installation	28
Check/Make Security Settings.....	31
Check Firewall Settings.....	31
Register the Camera IP Address as a Trusted Site	32
Settings When Using Windows Server.....	33
Making Initial Camera Settings.....	36
Launch the Camera Management Tool	36
Searching for Cameras and Setting up Networks	36

Set the Password, Date and Time, Camera Name and Video.....	38
Registering Camera's IP Address to Trusted Sites.....	40
Access the Top Page of the Camera to Check Video.....	41
Access the Top Page from Camera Management Tool.....	41
Top Page.....	41
Checking Camera Video.....	43

Chapter 3

Camera Angle Setting Tool

Launch the Camera Angle Setting Tool and Connect to a Camera.....	46
Launch the Camera Angle Setting Tool.....	46
Connect to the Camera.....	46
Disconnect from the Camera and Close the Software.....	49
Camera Angle Setting Tool Screen.....	51
Set the Camera Angle.....	53
Set the Camera Angle and Zoom.....	53
Set the Focus and Exposure Compensation.....	54
Use a Camera Specification File.....	56
Create a Camera Specification File.....	56

Chapter 4

Setting Page

How to Use The Setting Page.....	60
Access the Setting Page.....	60
Common Setting Page Operations.....	61
About Each Setting Page.....	62
Configure Network Settings	
[Basic Settings] > [Network].....	64
LAN.....	64
IPv4.....	64
IPv6.....	65
DNS.....	66
mDNS.....	67
Set the Administrator Password	
[Basic Settings] > [Password].....	68
Administrator Password.....	68
Set the Date/Time	
[Basic Settings] > [Date and Time].....	69
Current Date and Time.....	69
Setting.....	69
Set Video Size and Quality	
[Basic Settings] > [Video Settings].....	72
All Videos.....	72
JPEG.....	72
H.264(1).....	73
H.264(2).....	74
Set General Camera Controls	
[Camera] > [Camera Settings].....	75
Camera Name.....	75

Camera Control.....	75
Day/Night (When Auto Is Set)	77
Installation Conditions.....	77
Camera Position Control	78
External Input Device 1, 2	78
External Output Device 1, 2	78
Set Initial Video Settings	
[Camera] > [Initial Setting].....	79
Initial Setting.....	79
Reduce Data Size by Lowering Video Quality in Specific Areas	
[Video and Audio] > [ADSR].....	82
Specified Area	82
ADSR.....	84
Display Date, Time and Text on the Viewer	
[Video and Audio] > [On-screen display].....	85
On-Screen Display.....	85
Set Audio Input/Output	
[Video and Audio] > [Audio Settings]	87
General Sound	87
Sound Clip Upload 1 to 3.....	88
HTTP, SNMP and FTP Server Settings	
[Server] > [Server Settings]	89
HTTP Server	89
SNMP Server.....	89
FTP Server.....	90
WS-Security.....	90
Video Transmission Settings	
[Server] > [Video Server]	91
Audio Transmission/Reception Settings	
[Server] > [Audio Server]	92
RTP Settings	
[Server] > [RTP Server].....	93
RTP Server	93
Audio Multicast	93
RTP Streaming 1 to 5	94
HTTP and FTP Upload Settings	
[Video Record] > [Upload]	96
Video Record Setting	96
General Upload.....	96
HTTP Upload.....	97
FTP Upload	99
Settings for Recording Video to a Memory Card	
[Video Record] > [Memory Card]	101
Video Record Setting	101
Memory Card Operations	101
Memory Card Information	101

Set E-mail Notification	
[Video Record] > [E-mail Notification]	102
E-mail Notification	102
External Device Input Triggered Operation Settings	
[Event] > [External Device]	104
External Device Output 1, 2	104
External Device Input	104
External Device Input 1, 2	105
Abnormal Audio Input Triggered Operation Settings	
[Event] > [Audio Detection]	107
Volume Detection	107
Scream Detection	108
Timer Triggered Operation Settings	
[Event] > [Timer]	110
Timer 1 to 4	110
Execute Presets When Switching Day/Night Mode	
[Event] > [Switch Day/Night]	112
Use Event Combinations	
[Event] > [Linked Event]	113
Linked Event 1 to 4	113
Linked Event Operation Examples	115
Set Users Who Connect to the Camera	
[Security] > [User Restrictions]	118
Authorized User Account	118
User Authority	118
Set Access Restrictions	
[Security] > [Host Access Restrictions]	119
IPv4 Host Access Restrictions	119
IPv6 Host Access Restrictions	120
Set HTTP Communication Encryption	
[Security] > [SSL/TLS]	121
Certificates	121
Certificate Management	122
Encrypted Communications	123
Network Port Authentication Settings	
[Security] > [802.1X]	124
802.1X Authentication	124
Authentication Method	124
Set IPsec	
[Security] > [IPsec]	126
IPsec	126
Auto Key Exchange Settings	126
IPsec Set 1 to 5	127
Memory Card Operations and Information Display	
[Memory Card]	130
Video Record Setting	130

Memory Card Operations	130
Memory Card Information	132
Display Camera Device Information and Perform Maintenance [Maintenance]	134
Device Information	134
Tool	134

Chapter 5

Admin Viewer/VB Viewer

Admin Viewer and VB Viewer	138
Major Differences Between the Admin Viewer and the VB Viewer	138
Viewer Access Restrictions	138
View Video With Admin Viewer	140
Launch the Admin Viewer	140
Admin Viewer/VB Viewer Screen	141
Check Information	143
Change the Video Size and Display Screen Size	143
Operate the Camera With Admin Viewer	147
Obtain Camera Control Privileges	147
Use Pan/Tilt/Zoom	147
Magnify and Display Part of Video (Viewer PTZ)	151
Cropping and Displaying Part of an Image (Digital PTZ)	153
Using Presets or the Home Position	154
Use Backlight Compensation	155
Receive/Transmit Audio	155
Use Control for Admin	158
Control for Admin Panel	158
Pan / Tilt / Zoom	159
Preset / Initial Setting Registration	159
Smart Shade Control	159
Haze Compensation	160
Focus	161
Exposure	162
White Balance	164
Day/Night	165
Infrared	167
External Device Output	167
Image Quality Adjustment	168
Video Reception	168
About Presets	169
Register Presets	170
Display the Preset Setting Panel	170
Use [Quick Registration]	172
Register with [Advanced Preset Settings] Panel	173
Context Menu	175
Change Multiple Presets Simultaneously	176
Automatically Move to a Preset Position at a Specified Time (Auto Control Settings)	177
Configure [Auto Control Settings]	177

Configure the Preset Tour Route	179
[Tour Route Settings] Tab	179
Tour Route Settings.....	181
Context Menu.....	183
Check the Event Detection Status With Admin Viewer	184
Confirm Status With the Event Display Panel.....	184
Record Snapshots/Video With Admin Viewer.....	186
Capture a Snapshot.....	186
Record Video to a Memory Card Manually.....	186
Use VB Viewer	188
Launch VB Viewer and Differences with Admin Viewer.....	188

Chapter 6

Admin Tools

Admin Tools Overview.....	192
Overview of Each Tool in the Admin Tools	192
Access Admin Tools.....	193
Launch Admin Tools	193
Admin Tools Operations Common to All Tools	194
Privacy Mask Setting Tool	196
Register Privacy Masks.....	196
Change/Delete a Privacy Mask.....	198
Panorama Creation Tool	201
Create a Panorama Image.....	201
Delete a Panorama Image from the Camera	204
Save/Load Panorama Image File.....	204
View Restriction Setting Tool	206
Configure View Restrictions	206
Intelligent Function Setting Tool Overview	210
Intelligent Function.....	210
Notes on Intelligent Function Settings and Operations	213
Pre-register Presets	214
Select the Intelligent Function Operation Mode	214
Intelligent Function Setting Tool	
- Video Detection -	216
Steps for Configuring Video Detection	216
Configure Detection Criteria ([Detection Criteria] Tab)	219
Configure Operations for Triggered Detection ([Event] Tab)	227
Reduce Effects of Lighting Change (Detections Settings)	228
Context Menu.....	229
Intelligent Function Setting Tool	
- Auto Tracking -	230
Set Auto Tracking.....	230
Auto Tracking Termination	233
Disable Auto Tracking.....	233
Intelligent Function Setting Tool	
Display Options and Shared Operations	234
Display Event Status	234

Display Settings for Detection Areas/Detection Lines, Detection Results (Display Options).....	234
Restart Intelligent Function	235
Log Viewer	236
Download Log Files	236
View Logs.....	237
Recorded Video Utility	240
Use the Video List	240
Download/Delete Video	242
Play Back Video	244

Chapter 7

Appendix

Memory Card Data	250
Saved Data and Data Organization of Memory Card	250
Data Downloaded with Recorded Video Utility	250
Modifiers	252
Troubleshooting	254
List of Log Messages	256
Log Messages on the Camera.....	256
Error Log	256
Warning log	261
Notification log	263
List of Viewer Messages	269
Messages Displayed in the Information Display	269
Restore Default Settings	270
Restoring the Initial Setting from the Maintenance Page in the Web Browser	270
Restoring Factory Default Settings with the Reset Switch on the Camera	270
List of Factory Default Settings	273
Index.....	283

Chapter

1



Before Use

This chapter explains camera functions, software and operating environment. It also describes the flow from preparation and setup through to actual use.

Network Camera Capabilities

This network camera is capable of not just camera operations using the installed software but also recording and uploading video and monitoring using various intelligent functions.

However, the functions that can be used differ depending on the model. For the difference in functions by model, refer to the table below.

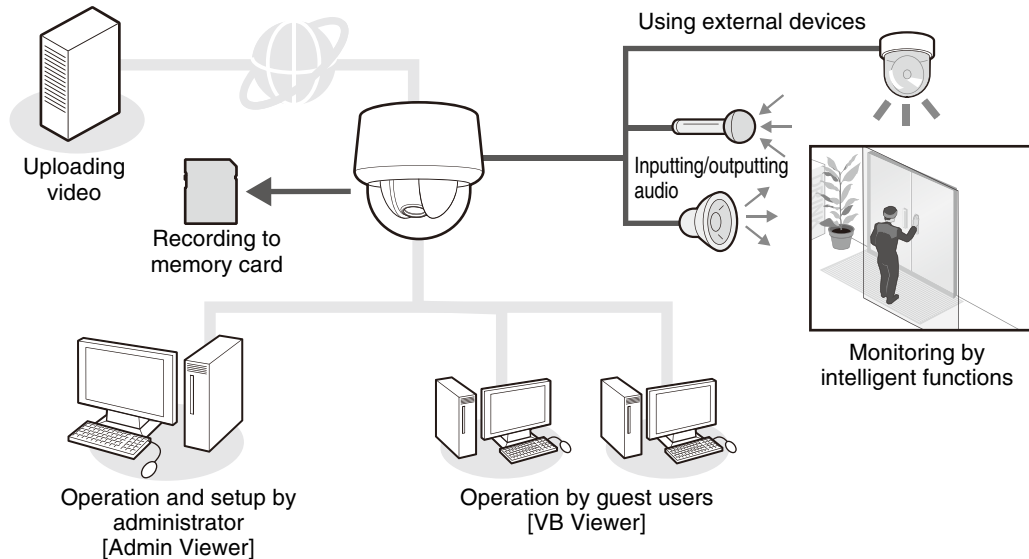

Table of Function Compatibility by Model

The functions for which availability differs depending on the model are shown below.

	R11	R10	M641	M640	M741	M740
Pan/Tilt	✓	✓	-	-	-	-
Digital PTZ	-	-	✓	✓	✓	✓
Audio I/O Terminals	✓	-	✓	-	✓	-
External Device Terminals	✓	-	✓	-	✓	-
Infrared Illumination	-	-	-	-	✓	-
Camera Angle Setting Tool	-	-	✓	✓	✓	✓
Audio Detection	✓	-	✓	-	✓	-
Auto Tracking	✓	✓	-	-	-	-
Event Triggered Preset Movement	✓	✓	-	-	-	-
Linked Event	✓	-	✓	-	✓	-
Panorama Creation Tool	✓	✓	-	-	-	-
View Restriction Setting Tool	✓	✓	-	-	-	-
microSD/microSDHC/microSDXC memory card support*	-	-	✓	✓	-	-
SD/SDHC/SDXC memory card support*	✓	✓	-	-	✓	✓
Max. Number of Registered Presets	257		21			

* In this guide, "memory card" refers to the memory cards that can be used by the cameras.



Camera Software

The software needed for camera setup and use is included on the camera and on the setup CD-ROM included with the camera. The software can also be purchased separately.

Software Included on the Camera

The following software is included on the camera. It is automatically downloaded from the camera when you use it.

■ Admin Viewer/VB Viewer (P. 137)

These Viewers are used for camera control and for monitoring video and events.

Admin Viewer can only be used by administrators and registered users with camera control permissions, and allows complete control of the camera.

The VB Viewer allows any user with camera access to use the camera, but the user is restricted to a limited set of functions.

■ Admin Tools (P. 191)

This tool is used for making camera settings and for managing cameras.

- Privacy Mask Setting Tool
- Intelligent Function Setting Tool
- Log Viewer
- Recorded Video Utility

R11 R10

- Panorama Creation Tool
- View Restriction Setting Tool



Note

To use Admin Viewer and Admin Tools, .NET Framework 3.5 SP1 (when using Internet Explorer 8/9) or .NET Framework 4.5 (when using Internet Explorer 10/11) is necessary.

If it is not installed on the computer, it will be automatically installed when using the installer (P. 28).

Software Included on the Setup CD-ROM

The software included on the setup CD-ROM is installed and used on a computer.

■ Camera Management Tool (P. 36)

This tool is used for batch managing multiple cameras, from making settings to performing maintenance. The Camera Management Tool can perform the following tasks.

- Set various camera settings.
- Launch software included on the camera, such as Admin Viewer and Admin Tools.
- Update firmware, back up/restore settings, perform memory card and other operations, as well as, camera maintenance.

This guide explains how to use this tool to make initial settings for cameras (P. 36). For details on other uses and functions, please refer to the "Camera Management Tool User Manual".

The Camera Management Tool can be installed by the installer application.

Installer location: Setup CD-ROM > [Applications] folder > VBToolsInstall.exe

■ Camera Angle Setting Tool (P. 45)

M641 M640 M741 M740

This tool allows you to adjust the camera angle during installation by viewing video from the camera on the computer screen via a network.

Installer location: Setup CD-ROM > [Applications] folder > VBToolsInstall.exe

■ Admin Tools Certificate

This is a digital certificate for using Admin Viewer and Admin Tools.

Installer location: Setup CD-ROM > [Applications] folder > VBToolsInstall.exe

■ Admin Viewer/Admin Tools with Proxy Authentication Support

Use these when going through a proxy server with proxy authentication.

Software location: Setup CD-ROM > ProxyAuthSupport folder

■ RM-Lite

This software displays, records and plays back video from up to four cameras via a network.

Software location: Setup CD-ROM > [Applications] folder > RMLiteInstall.exe

RM-Lite Software

Type	Overview	License
RM-Lite Storage Server	Up to four cameras can be registered to record video (JPEG).	1 license
RM-Lite Viewer	Plays video recorded in the storage server and displays live video (JPEG/H.264) from the camera. Up to four cameras can be registered for the viewer.	1 license
RM-Lite Manager	Use register cameras and configure recording schedules.	1 license

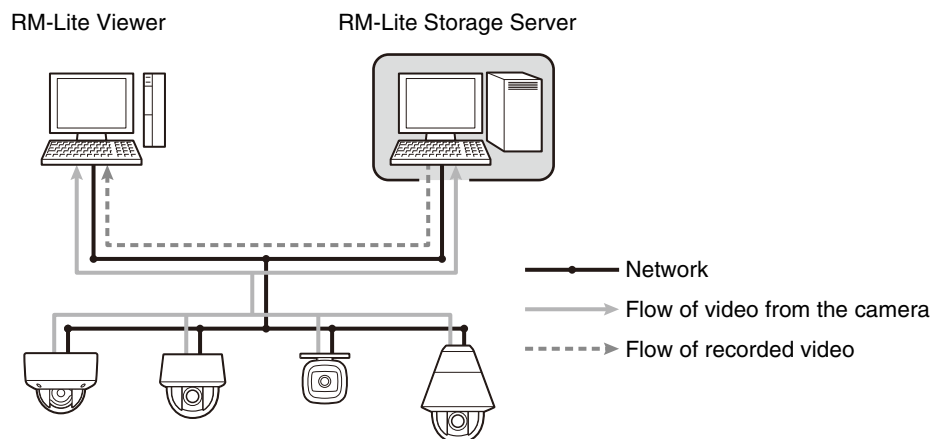

Supported cameras	VB-R11VE, VB-R11, VB-R10VE, VB-M641VE, VB-M641V, VB-M640VE, VB-M640V, VB-M741LE, VB-M740E, VB-H43, VB-H630VE, VB-H630D, VB-H730F, VB-M42, VB-M620VE, VB-M620D, VB-M720F, VB-S30D, VB-S31D, VB-S800D, VB-S900F, VB-S805D, VB-S905F, VB-H41, VB-H610VE, VB-H610D, VB-H710F, VB-M40, VB-M600VE, VB-M600D, VB-M700F, VB-C60, VB-C500VD/VB-C500D, VB-C300, VB-C50i/VB-C50iR, VB-C50FSi/VB-C50Fi
-------------------	--------------------------------------------------------------------------------------------------------------------------------------------------------------------------------------------------------------------------------------------------------------------------------------------------------------------------------------------------------------------------------------------

Important

To add the RM-Lite Viewer or RM-Lite Manager, you must purchase RM-Lite-V (sold separately).

 **Note**

For details on the usage, operating environment, and functions of RM-Lite, please refer to the "System Administrator Manual".

Additional Software/Licenses (Sold Separately)

You can purchase additional software and licenses as necessary.

■ Canon H.264 Additional User License AUL-VB

Additional license for viewing H.264 video with multiple computers via Admin Viewer or Recorded Video Utility. Each camera includes one license. Additional licenses are necessary for multiple computers to view H.264 video from a single camera.

■ RM-64/RM-25/RM-9

This software allows network cameras to be used for multipoint surveillance, and for displaying, recording and playing back videos from the camera.

The number of cameras that can be registered with RM-64/RM-25/RM-9 varies: 64, 25, or 9 cameras respectively can be registered. By using multiple Storage Servers, you can construct a surveillance system supporting up to 512 cameras.

 **Note**

Licenses for upgrading from RM-9 to RM-25 or RM-64, and from RM-25 to RM-64 are also available.

■ RM-V

This additional license lets you install the RM-64/RM-25/RM-9 RM Manager and Viewer on multiple computers. Purchase the license to be able to view video from the camera from multiple locations and for other similar purposes.

■ RM-Lite-V

This additional license lets you install the RM-Lite Viewer or RM-Lite Manager on multiple computers. Purchase the license to be able to view video from the camera from multiple locations and for other similar purposes.

Operating Environment

For the latest information on this product (firmware and included software, user manual, operating environment, etc.), please refer to the Canon Web Site.

Camera Angle Setting Tool, Admin Viewer/VB Viewer, Admin Tools

CPU	Intel Core i7-2600 or higher
OS* ¹	Windows Vista Ultimate/Business/Enterprise/Home Premium SP2 32/64-bit Windows 7 Ultimate/Professional/Enterprise/Home Premium SP1 32/64-bit Windows 8/Windows 8 Pro/Windows 8 Enterprise 32/64-bit* ⁴ Windows 8.1/Windows 8.1 Pro/Windows 8.1 Enterprise 32/64-bit* ⁴ Windows Server 2008 Standard SP2 32/64-bit Windows Server 2008 R2 Standard SP1 64-bit Windows Server 2012 Standard 64-bit* ⁴ Windows Server 2012 R2 Standard 64-bit* ⁴
Web Browser* ²	Internet Explorer 8/9 32-bit Internet Explorer 10/11
Memory	2 GB or more
Viewer Display	1920 x 1080 or higher
Software* ³	.NET Framework 3.5 SP1 (when using Internet Explorer 8/9) – Must be installed on Windows Vista and Windows Server 2008 systems .NET Framework 4.5 (when using Internet Explorer 10/11) – Must be installed on Windows 7 and Windows Server 2008 R2 systems
Audio	A computer that supports audio is required to use the camera's audio function.

*1 Set the Control Panel's font size (DPI) for Admin Tools and Admin Viewer to 100% or 125%.

*2 The browser must support JavaScript, XAML browser applications, and IFRAME (HTML tag).
The VB Viewer requires Cookies.

*3 Installation is unnecessary if only VB Viewer will be used. .NET Framework 3.5 SP1 and 4.5 are provided on the included setup CD-ROM, and the appropriate installer is selected automatically depending on the version of Internet Explorer.

*4 The included software or the software installed on the camera cannot be started from the Start screen added to Windows 8 and later.



Note

For details on using Camera Management Tool, please refer to "Camera Management Tool User Manual".

Steps for Setting Up Camera

Step 1 Pre-Installation Preparations

Make preparations to use the camera via a network.

Install necessary software

→ “Install Software” (P. 28)

Check/configure computer and web browser security settings

→ “Check/Make Security Settings” (P. 31)

Use Camera Management Tool to configure initial camera settings.

→ “Making Initial Camera Settings” (P. 36)

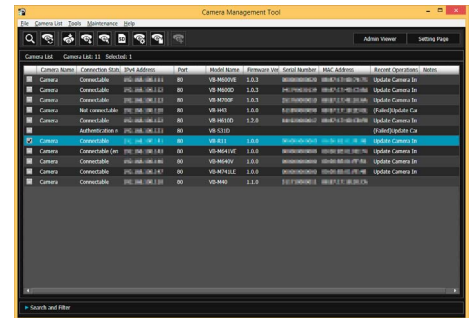

Camera Management Tool

Step 2 Check Camera Connection

Access the camera with a computer to ensure preparations have been properly completed.

Access the camera top page using a web browser

→ “Access the Top Page from Camera Management Tool” (P. 41)

Launch VB Viewer to check camera video

→ “Checking Camera Video” (P. 43)

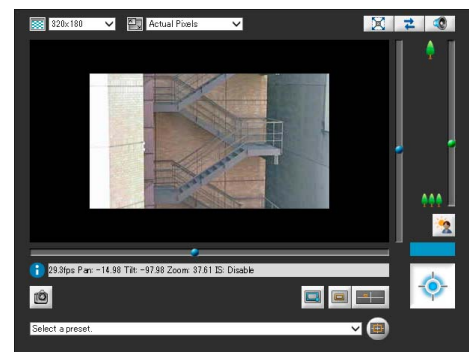

VB Viewer

Step 3 Install the Camera

Install the camera to suit the operating environment it will be used in.

→ “Installation Guide”

Step 4 Set the Camera Angle M641 M640 M741 M740

Use Camera Angle Setting Tool to set the camera angle while checking video on the computer screen.

→ “Camera Angle Setting Tool” (P. 45)



Camera Angle Setting Tool

Step 5 Adjust Advanced Settings According to Use

Advanced settings can be made in the Setting Menu, such as for camera control and security, suitable for the intended camera use.

→ “Setting Page” (P. 59)

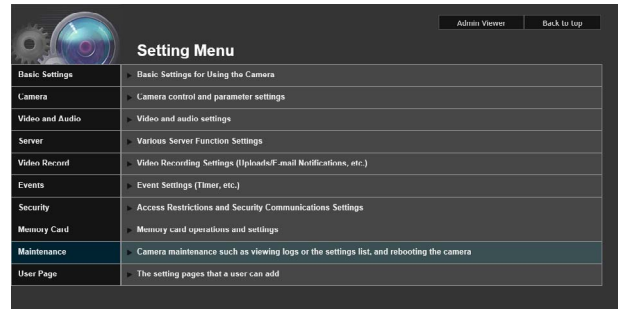

Setting Page

Step 6 Use the Viewers

Use the viewers included on the camera.

The Admin Viewer is intended for administrators, and the VB Viewer for guest users. Use the VB viewer to check content distributed to guest users and Admin Viewer to make all settings and fully check all preparations.

→ “Admin Viewer/VB Viewer” (P. 137)

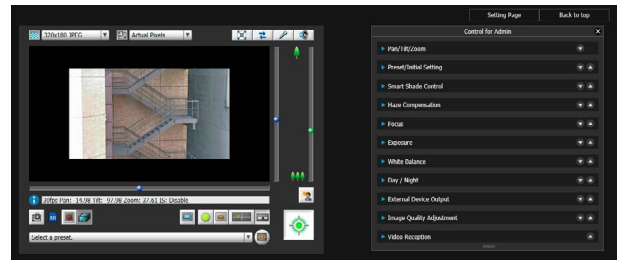

Admin Viewer

Step 7 Use Admin Tools

Admin Tools can be used to set masks to ensure privacy, set view restrictions and set the Intelligent Function to detect changes in video. You can also view logs of the camera's operational status, as well as browsing and managing video recorded to the camera's memory card.

→ “Admin Tools” (P. 191)

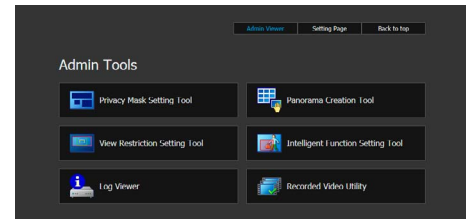

Troubleshooting

Please refer to the “Appendix” (P. 249), in case of error messages or problems.

The top half of the page features a blue gradient background with several overlapping, semi-transparent images of camera lenses. The lenses are arranged in a cluster, with some appearing larger and more prominent than others, creating a sense of depth and focus.

Chapter 2

Camera Setup

To prepare the camera for use, install necessary computer software and make initial settings for web browser security and the camera.

When initial settings are complete, access the camera and check if video can be viewed.

Install Software

Use the setup CD-ROM included with the camera to install necessary software.

Necessary Software

You will need the following software:

- Camera Management Tool (P. 36)
- Admin Tools Certificate
- .NET Framework 3.5 SP1/.NET Framework 4.5 (unnecessary if already installed on computer)

M641 M640 M741 M740

- Camera Angle Setting Tool

Note

- All computer users will be able to use Admin Viewer and Admin Tools if the Admin Tools Certificate is installed.
- If .NET Framework 3.5 SP1/.NET Framework 4.5 is not installed on the computer, the installer will automatically install the version appropriate for the version of Internet Explorer used on the computer.

Software Installation

■ Installation Methods

The software can be installed together using [Easy Installation], or you can select which software to install using [Custom Installation].

Note

- [Easy Installation] will also install the Camera Angle Setting Tool, which cannot be used by VB-R11VE, VB-R11 and VB-R10VE. Use [Custom Installation] and exclude the Camera Angle Setting Tool if you do not need to install it.
- If you plan to use Admin Viewer and Admin Tools on a computer that will not be used for the initial camera setup (a computer that does not have Camera Management Tool installed), you can select [Custom installation] and only install the “Admin Tools Certificate”.

■ Install Software

- 1** Insert the setup CD-ROM into the drive on the computer.
- 2** Confirm that all other applications have been closed.
- 3** Double-click the CD-ROM icon > [Applications] folder > [VBToolsInstall.exe] in Windows Explorer.



The installation screen appears.

Note

If the [User Account Control] screen appears, click [Yes] or [Continue].

4 Select the installation method.



5 Confirm or select the software that will be installed.

If you select [Easy Installation], confirm the software that will be installed and click [Next].

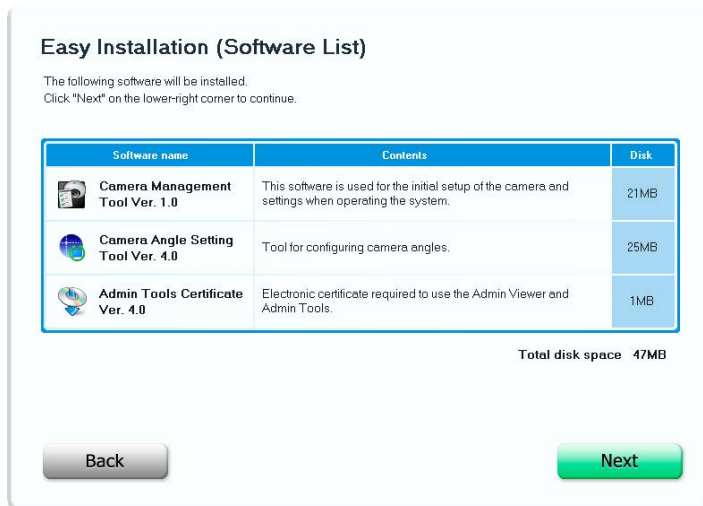

If you select [Custom Installation], select the software to be installed and click [Next].

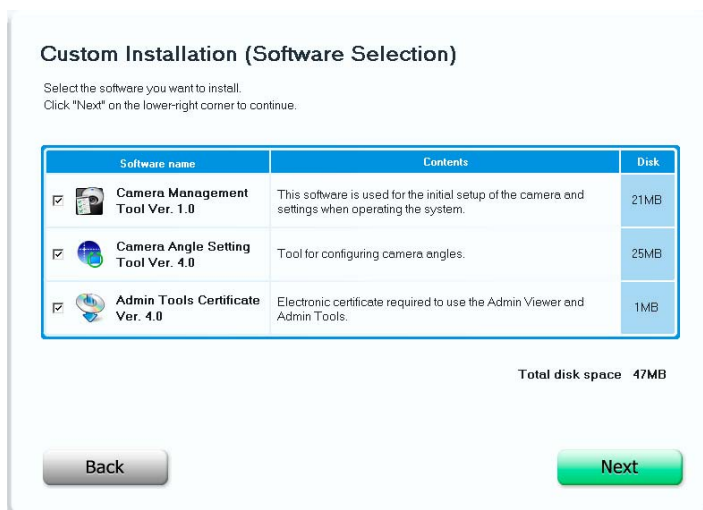

The User License Agreement screen appears.

6 Read through the user license agreement and click [Yes] if you accept it.

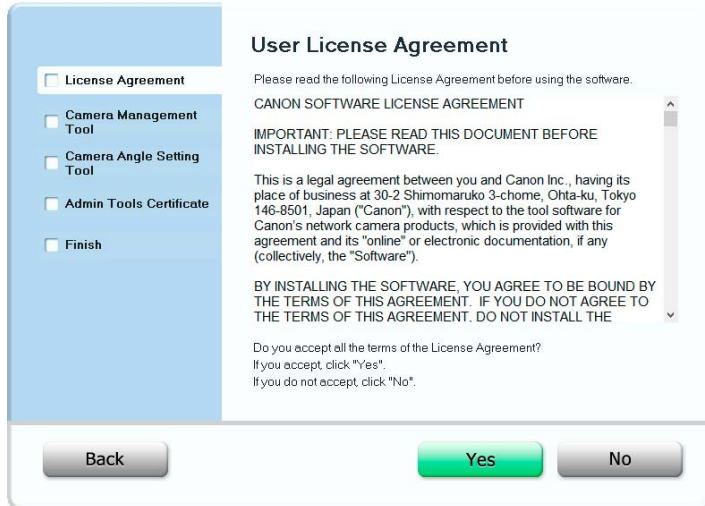

Installation starts.

7 Click [Exit] or [Reboot].

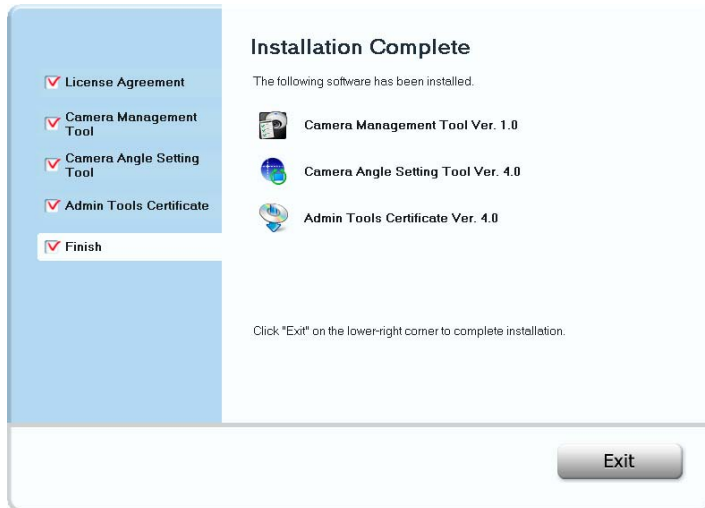

The Camera Management Tool icon and Camera Angle Setting Tool icon (if installed) will appear on the desktop.



Check/Make Security Settings

Depending on Windows or Internet Explorer security settings, software or web browsers may be blocked from making camera settings or using the camera.

Change or check security settings beforehand.

Check Firewall Settings

To use the Camera Management Tool on computers where Windows Firewall is enabled, you may need to register the Camera Management Tool as an application allowed to communicate via the firewall.

Note

Even if you do not perform the following steps, you can still register the Camera Management Tool with the [Windows Security Alert] dialog box that appears when you launch the software (P. 36).

- 1 Click [System and Security] > [Windows Firewall] in [Control Panel].
- 2 Click [Allow an app or feature through Windows Firewall].

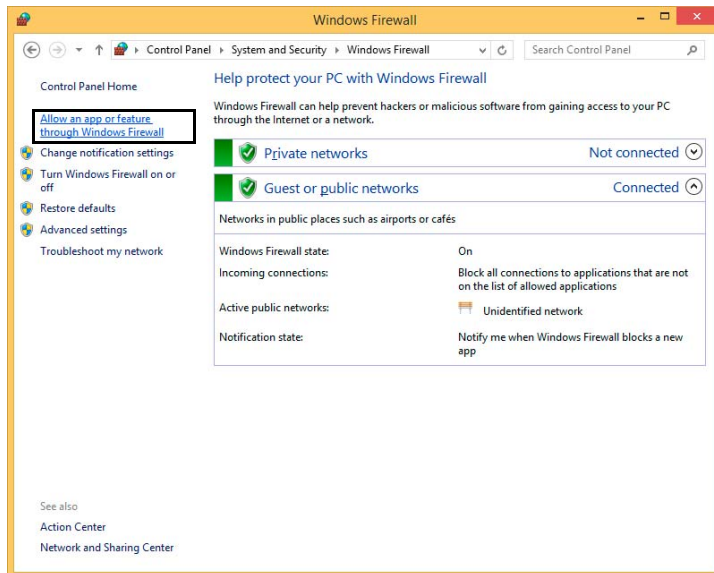

3 Click [Change settings] > [Allow another app].

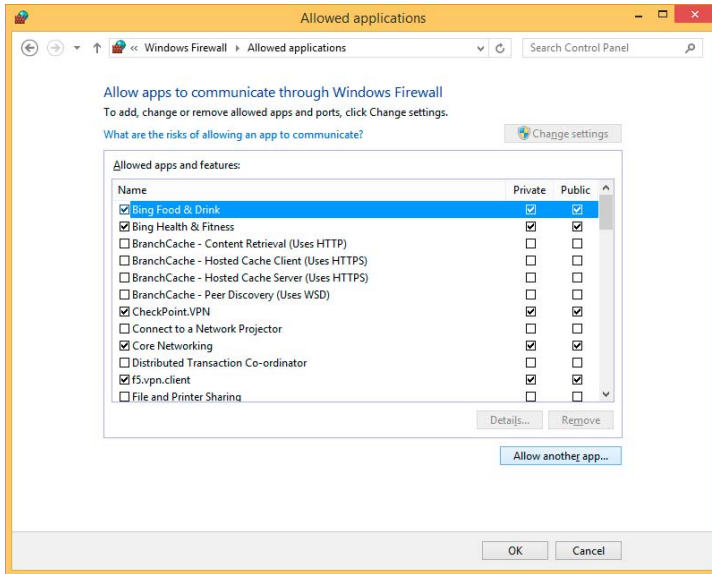

4 Select [Camera Management Tool] and click [Add].

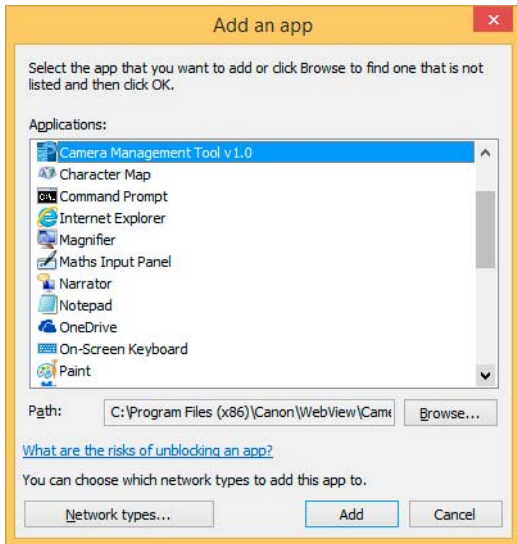

Register the Camera IP Address as a Trusted Site

In Internet Explorer 9 or later and Windows Server 2008/Windows Server 2012, Internet Explorer's security level for Internet and intranet sites is set to [High] by default.

As a result, it may be necessary to register the camera's IP address as a trusted site to access the Admin Viewer/VB Viewer, Setting Page or Admin Tools.

Note

- Set the camera IP address with the Camera Management Tool (P. 37).
- If you skip registration in this step, you can perform registration later using Camera Management Tool (P. 40).

1 Click [Tools] menu > [Internet Options] in Internet Explorer.

2 Click the [Security] tab.

3 Click [Trusted sites] > [Sites].

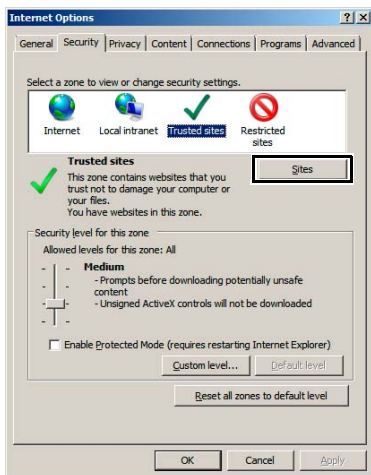

The [Trusted sites] dialog box appears.

4 Enter the IP address of the camera under [Add this Web site to the zone], then click [Add].

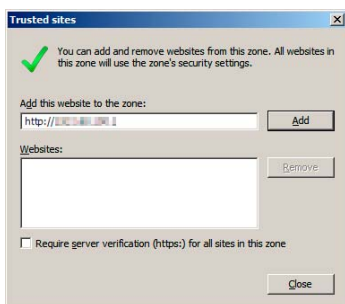

Note

- Clear the [Require server verification (https:) for all sites in this zone] check box if it is selected. The camera's IP address will be registered to the [Websites] list.

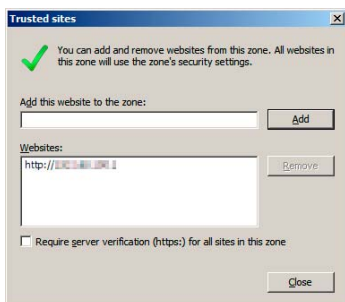

- You can register IP addresses for multiple cameras by using a wildcard (*) when entering the IP address. For example, if you enter "192.160.1.*", all cameras that share the "192.160.1" portion of the address will be registered as trusted sites.

Settings When Using Windows Server

Register "about:internet" and the Camera Host Name

Admin Viewer and Admin Tools will not launch when IE ESC (Internet Explorer Enhanced Security Configuration) is enabled in Windows Server 2008/Windows Server 2012.

Before using the tools, register "about:internet" and the host name for the connected camera in the Internet Explorer "local intranet" or "trusted sites" list.

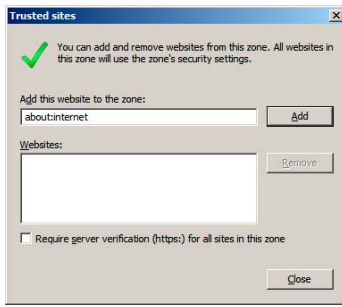

Important

When "about:internet" is registered, the security level in Windows 7 is the same as when using Internet Explorer. After using Admin Viewer/Admin Tools, it is recommended that you remove "about:internet" and the camera name as necessary and restore the original security level.

■ Security Settings When Using an SSL Connection

When an SSL connection to the camera is made from a web browser (Internet Explorer 9/10/11) in Windows Server 2008/Windows Server 2012, the following operations may cause the display of the blocked content dialog box and prevent further operation.

- The launching of Admin Tools or Admin Viewer
- Audio reception from VB Viewer

This occurs when Internet Explorer Enhanced Security Configuration (IE ESC) is enabled in Internet Explorer 9/10/11. Use the procedures below to change this setting.

- 1 Click [Tools] menu > [Internet Options] in Internet Explorer 9/10/11.
- 2 Click the [Advanced] tab.
- 3 Clear the [Do not save encrypted pages to disk] check box in [Security].

Important

Note that when Internet Explorer Enhanced Security Configuration is turned back on, the [Do not save encrypted pages to disk] check box also becomes enabled.

■ Sound Settings for Using the Audio Functions

In Windows Server 2008/Windows Server 2012, the sound function is disabled by default. To use audio functions with the viewer, follow the steps below to enable the sound function.

- 1 Open [Control Panel] and click [Hardware].



2 Click [Sound].

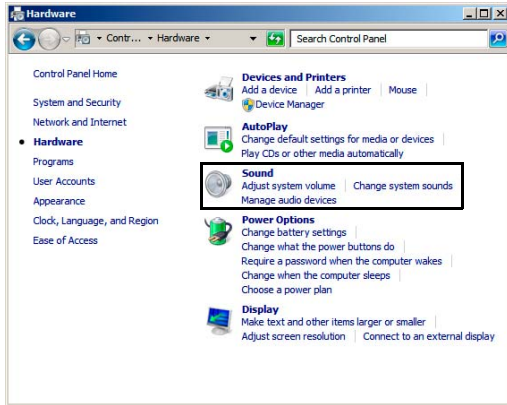

[Audio Service Not Running] dialog box appears.

3 Click [Yes].



The [Sound] dialog box appears.

4 Click the [Playback] tab to confirm that an audio device has been installed.

If no audio device is installed, refer to your computer manual.

Making Initial Camera Settings

To use the camera, you must first set the network settings for the camera and then establish a network connection between the camera and a computer. Use Camera Management Tool for these settings.

This section will explain, in addition to network settings, how to set the camera name, the date and time and other settings. It will also explain how to use the Camera Management Tool to make initial camera settings.

Note

- For details on using Camera Management Tool, please refer to “Camera Management Tool User Manual”.
- The settings made here will be reflected in the settings on the Setting Page (P. 59).

Launch the Camera Management Tool

Launch the Camera Management Tool that was installed onto the computer from the setup CD-ROM.

1 Connect the camera and computer to the network and turn on the power.

Please refer to “Installation Guide” > “Connecting the Camera”

2 Double-click the [Camera Management Tool] icon on the desktop.



Camera Management Tool launches and the [Camera Search Settings] dialog box appears.

3 Enter the factory default password (“camera”) into [Administrator Password] and click [OK].

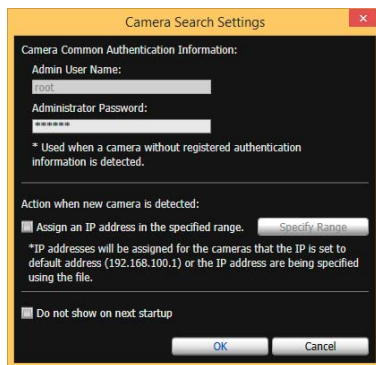

The Camera Management Tool main screen will appear.

Searching for Cameras and Setting up Networks

This will explain network settings so you can search for network connected cameras and connect to them from a computer. The examples will be for setting one camera. The Camera Management Tool, however, can set multiple cameras at the same time.

- 1 Click the [Search Camera] icon.

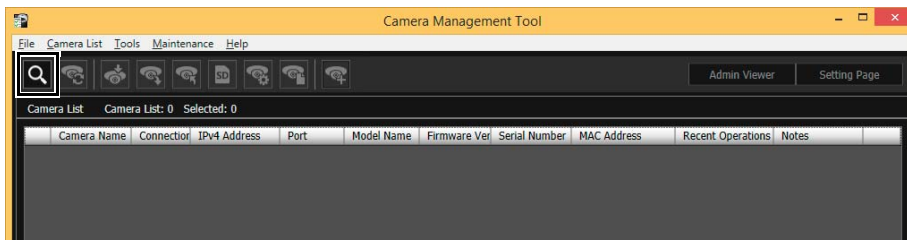

- 2 Detected cameras will appear in the camera list.
- 3 Select a camera in the camera list and click the [Basic Camera Settings] icon.

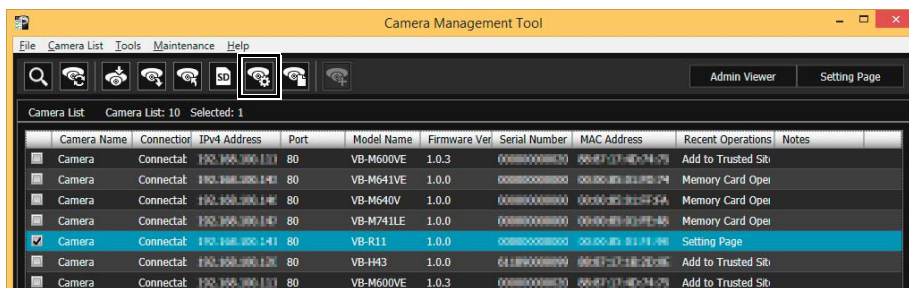

The [Basic Camera Settings] dialog box appears.

- 4 Set each of the [Network] items.

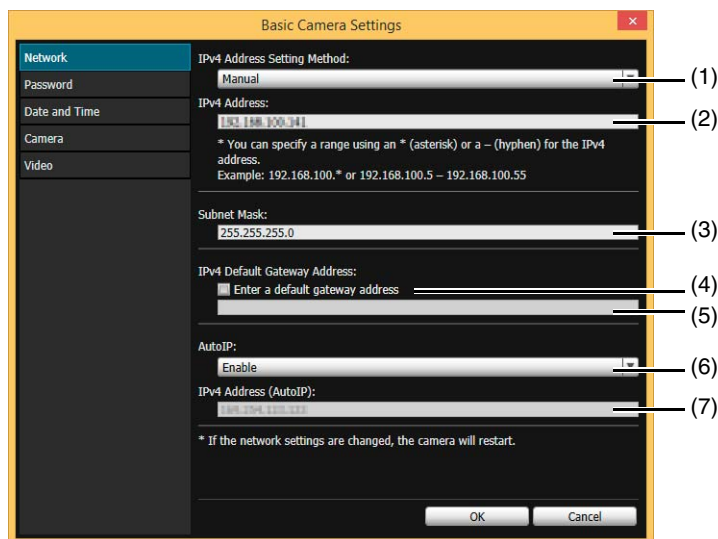

- (1) [IPv4 Address Setting Method]
Select the method for setting the IPv4 address.
If [Manual] is selected, directly enter values that suit the environment in which the camera is used.
If [Auto (DHCP)] is selected, the value automatically acquired from the DHCP server will be entered in [IPv4 Address], [Subnet Mask] and [IPv4 Default Gateway Address].
- (2) [IPv4 Address]
If you selected [IPv4 Address Setting Method] > [Manual], enter a fixed IPv4 address.
- (3) [Subnet Mask]
If you selected [IPv4 Address Setting Method] > [Manual], enter the designated subnet mask values for each network.
- (4) [Enter a default gateway address]
Select this to manually set the default gateway address.

(5) [IPv4 Default Gateway Address]

Be sure to set this if you select [IPv4 Address Setting Method] > [Manual] and connect to the camera with a different subnet than that of the viewer.

(6) [AutoIP]

Select this to enable or disable AutoIP.

(7) [IPv4 Address (AutoIP)]

When [Enable] is selected for [AutoIP], an automatically set IPv4 address is displayed.

5 Click [OK].

The camera will restart and the settings will take effect.

When you click [OK], other settings in ([Password], [Date and Time], [Camera], [Video]) [Basic Camera Settings] will also take effect.

Set the Password, Date and Time, Camera Name and Video

Set basic camera information, such as the camera name, administrator password and date. Once you have entered information for each item, click [OK].

■ Password Setting

Click [Password] and set the administrator password.



Important

To ensure system security, be sure to change the administrator password. Do not forget the new password.

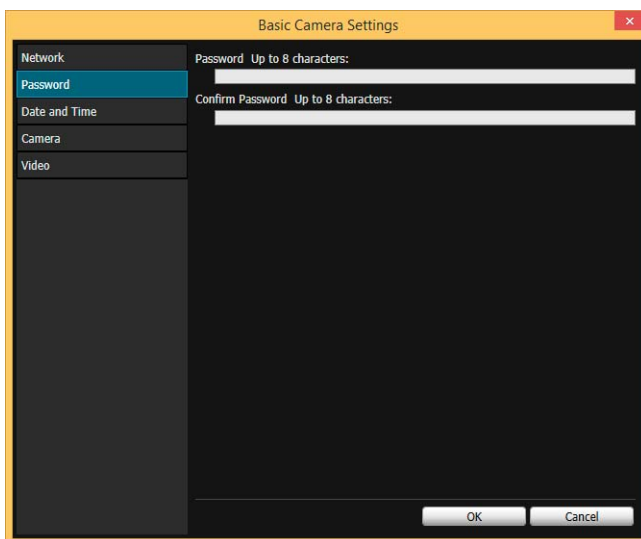

Date and Time Settings

Click [Date and Time] and make settings such as the camera date and time setting method, time zone, and daylight saving time.

For details on each item, please refer to “Setting” (P. 69) in “Set the Date/Time”.

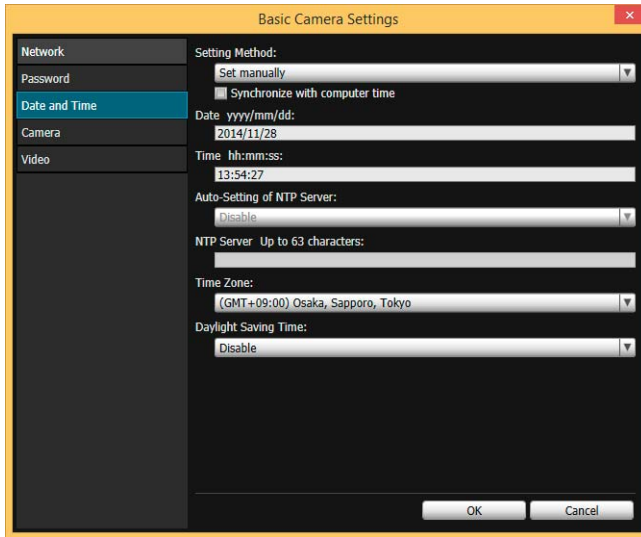

Camera Name Setting

Click [Camera] and set the camera name displayed in the viewers and other software.

For setting details, please refer to “Camera Name” (P. 75) in “Set General Camera Controls”.

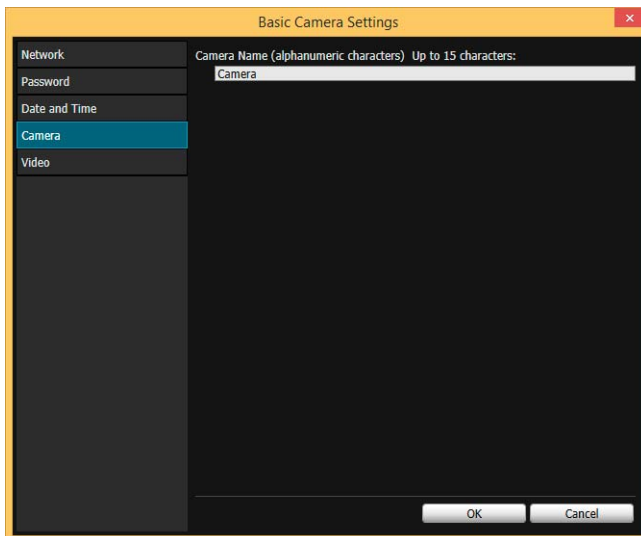

Video Settings

Click [Video] and configure the size and quality settings of the video transmitted from the camera.
For setting details, please refer to “Set Video Size and Quality [Basic Settings] > [Video Settings]” (P. 72).

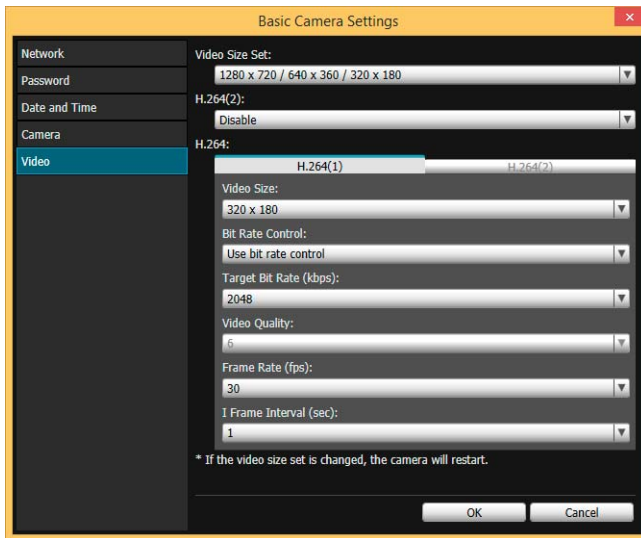

Registering Camera's IP Address to Trusted Sites

With Internet Explorer 9 or later and Windows Server 2008/Windows Server 2012, Internet Explorer's security level for Internet and intranet sites is set to [High] by default.

As a result, it may be necessary to register the camera's IP address as a trusted site to access the Admin Viewer/VB Viewer, Setting Page or Admin Tools.

- 1 Select a camera from the camera list.
- 2 Click [Maintenance] menu > [Add to Trusted Sites].

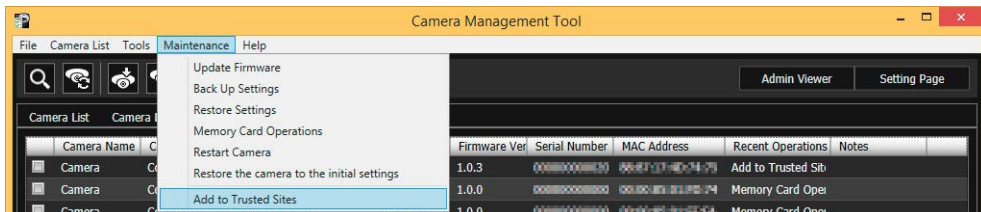

A confirmation message appears.

- 3 Click [OK].
The camera will be registered as a trusted site for Internet Explorer.

Note

The registered information will be loaded when Internet Explorer is restarted. Close and restart Internet Explorer if it is running.

Access the Top Page of the Camera to Check Video

When camera installation and initial settings are complete, access the camera with the Camera Management Tool and check if video can be viewed properly.

Access the Top Page from Camera Management Tool

You can use the Camera Management Tool to launch the camera top page.

- 1 Launch the Camera Management Tool (P. 36)
- 2 Double-click the IPv4 address of a camera in the camera list to launch its top page.

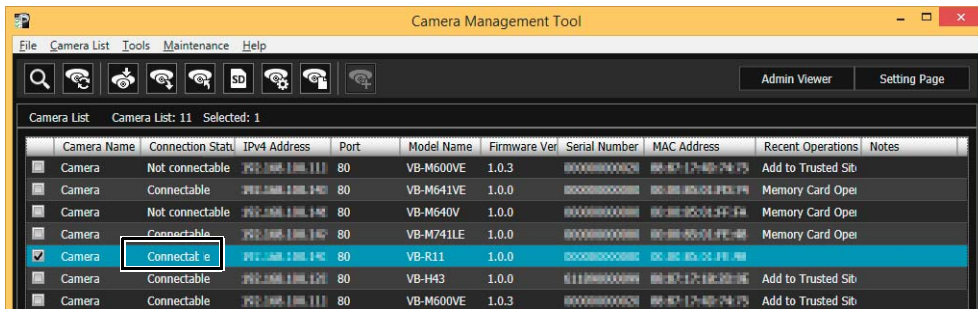

The web browser will start and the camera top page appears.

Note

- The web browser will not start when [Connection Status] for a camera is [Not connectable].
- You can also launch the camera top page by entering the IP address configured with the Camera Management Tool (P. 37) directly into the web browser.
- If the camera top page does not launch, please refer to “Troubleshooting” (P. 254).

Top Page

From the top page of the camera, you can navigate to the Setting Page to configure various camera settings, launch Admin Tools, and access Viewers to view video.

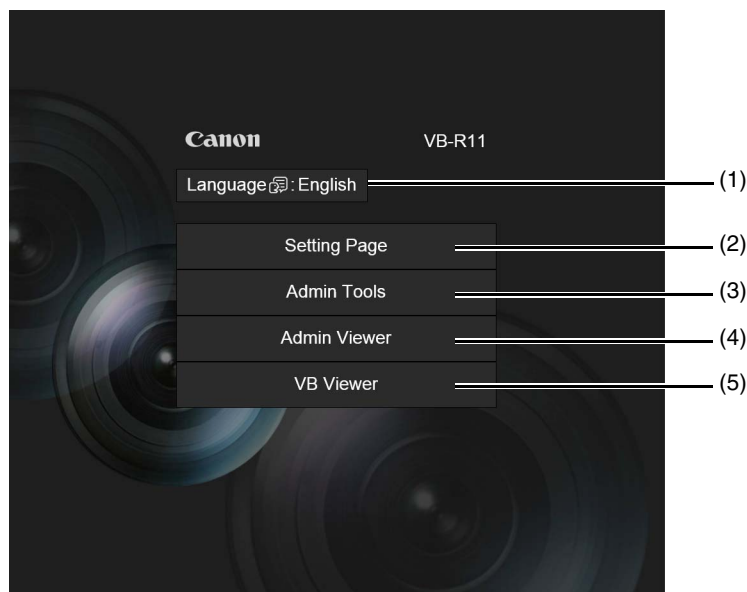

(1) Language Button

Click to switch the display language.

- (2) [Setting Page]
Displays the Setting Page (P. 60).
You can make initial camera settings and settings to suit how the camera will be used.
- (3) [Admin Tools]
Displays the Admin Tools top page (P. 193).
You can launch various tools for making settings, such as for using the camera, or launch a utility for managing recorded video.
- (4) [Admin Viewer]
Launches the Admin Viewer (P. 43).
- (5) [VB Viewer]
Launches the VB Viewer (P. 43).

User Authentication

When you use the Setting Page, Admin Tools or Admin Viewer, an authentication screen appears, and you are prompted to enter a user name and password.

If you enter the wrong user name or password, you will not be able to connect to the camera. Enter the correct user name and password and connect to the camera.



Authentication Screen for Setting Page

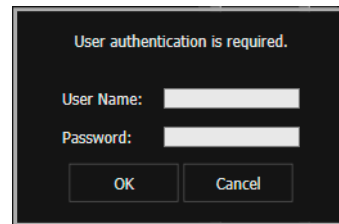

Authentication Screen for Admin Tools/Admin Viewer

The factory default user name and password are:

User Name: root

Password: camera

The user name “root” is the administrator account for the camera.

Important

- To ensure system security, be sure to change the administrator password. Do not forget the new password.
- Restore factory default settings if you have forgotten the administrator password (P. 270). Note that this will reset all camera settings to factory default settings except for date and time.
- If you connect to the camera using the administrator account, it will not be possible to connect with administrator privileges from a different computer.
- If the administrator and an authorized user share the VB Viewer on the same computer, it is strongly recommended that the [Remember my credentials] check box be cleared.
- The Admin Tools and the Admin Viewer cannot be used if an IPv6 address is specified. Only host names are supported for IPv6 connections.

Note

- Only administrators can connect to a camera using the Setting Page and Admin Tools.
- Authorized users with camera control privileges can also connect using Admin Viewer. You can set the user privileges of registered users with [Security] > [User Restrictions] > [User Authority] on the Setting Page (P. 118).

- Depending on the security settings in Internet Explorer, the blocked content dialog box may appear when attempting to access the Setting Page, Admin Tools or the Viewers when using the camera with Internet Explorer 9 or later, or on Windows Server 2008/ Windows Server 2012. If this happens, click [Add] to register the camera IP address as a trusted site.



Checking Camera Video

Check the camera video with a viewer. VB Viewer and Admin Viewer are available.

This section only explains how to launch a viewer for checking video. For details on how to use each Viewer, please refer to "Admin Viewer/VB Viewer" (P. 137).

Note

If the blocked content dialog box appears when you launch a viewer, click [Add] in the dialog box to register the camera's IP address as a trusted site.

Viewing Video With VB Viewer

VB Viewer allows any user with camera access to use the camera. The user, however, is restricted to a limited set of functions.

When you click [VB Viewer] on the top page, the VB Viewer launches and displays the camera video.

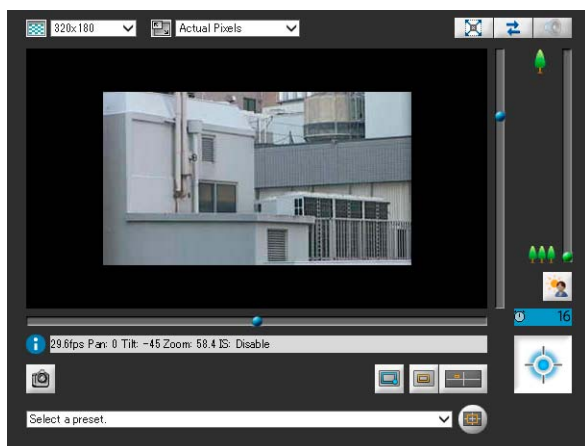

Viewing Video With Admin Viewer

The Admin Viewer can only be used by administrators and registered users with camera control privilege. It allows complete control of the camera.

- 1 Click [Admin Viewer] on the top page.

The user authentication window appears.

2 Enter a user name and password (P. 42) and click [OK].

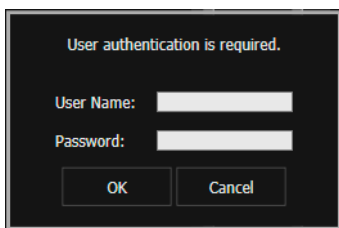

The Admin Viewer launches and displays the camera video.

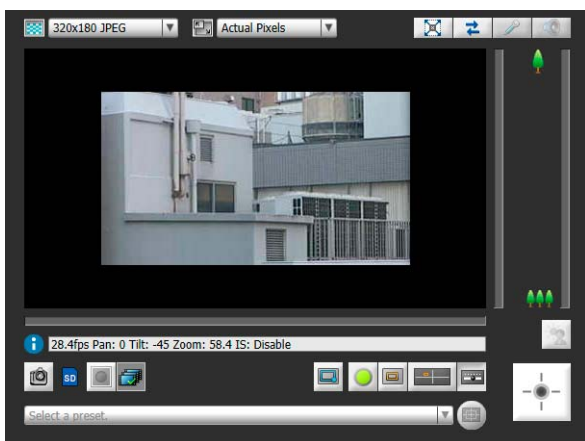

Chapter 3

Camera Angle Setting Tool

M641 M640 M741 M740

After installing the camera, connect to it with the Camera Angle Setting Tool and view the displayed video to make settings, such as the camera angle, focus and exposure.

Launch the Camera Angle Setting Tool and Connect to a Camera

The Camera Angle Setting Tool allows you to view displayed video on a computer to make settings, such as the camera angle and focus.

Use this to adjust the camera during installation or if the camera has been moved from its original position.

The following gives an overview of the settings that can be made with the Camera Angle Setting Tool.

M641 **M640**

Pan, Tilt, Rotation, Zoom, Focus, Image Flip

M741 **M740**

Zoom, Focus, Image Flip

Important

- The Camera Angle Setting Tool is for use when installing the camera. Do not use on a daily basis. Frequent use may result in camera malfunction.
- After changing settings with the Camera Angle Setting Tool, make sure that the settings made with the Setting Page and Admin Tools function correctly.
- The Camera Angle Setting Tool cannot be used via a proxy server.
- The upload function cannot be used while the Camera Angle Setting Tool is connected.

Launch the Camera Angle Setting Tool

Double-click the [Camera Angle Setting Tool] icon on the desktop to launch it.



Note

You can also launch the Camera Angle Setting Tool from the Camera Management Tool. For details, please refer to the "Camera Management Tool User Manual".

Connect to the Camera

Use the Camera Angle Setting Tool to select the camera on which you want to set the camera angle.

Important

- Connections to a single camera are limited to 30 minutes. If the connection is closed because you exceeded the time limit before you completed camera angle settings, reconnect to the camera.
- Multiple computers cannot simultaneously connect to the same camera using the Camera Angle Setting Tool.

There are two methods for connecting to the camera.

- Specify camera information.
- Use a Camera Specification File (P. 56)

■ Connect by Specifying Camera Information

- 1 Click [File] menu > [Connect].

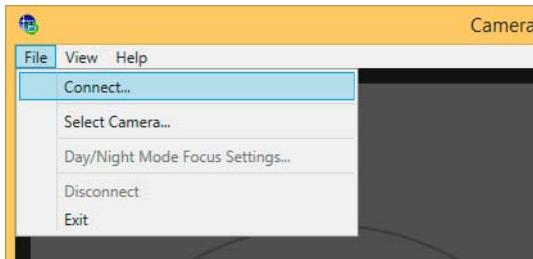

The [Connection settings] dialog box appears.

- 2 Enter the connection settings for the camera.

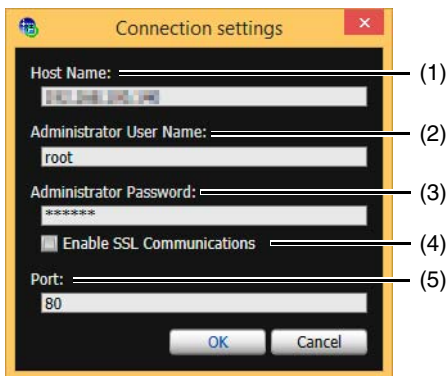

- (1) [Host Name]
Enter the host name or IP address of the camera (P. 37).
- (2) [Administrator User Name]
Enter the administrator user name for the camera (P. 42).
- (3) [Administrator Password]
Enter the administrator password for the camera (P. 42).
- (4) [Enable SSL Communications]
Select this to connect to the camera using SSL communication.
Normally, disabling SSL communication (the factory default setting) is not an issue (P. 123).
- (5) [Port]
Set the HTTP port number to 80, 443 or a value in the range of 1024 to 65535.
Normally use [80] (factory default setting) (P. 89).

- 3 Click [OK].

A confirmation message will appear.

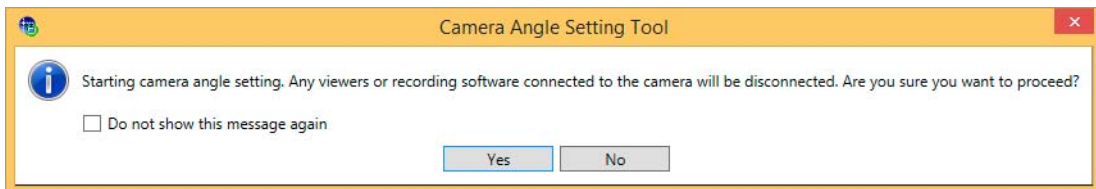

Note

Connecting to the camera with the Camera Angle Setting Tool will disconnect connections to that camera from Viewers and recording software, except for those connecting via RTP.

- 4 Click [Yes].

You will connect to the camera and live video from it will appear.

■ Use a Camera Specification File for Connecting

You can connect to a camera by loading camera information listed in a camera specification file (P. 56).

- 1 Click [File] menu > [Select Camera].

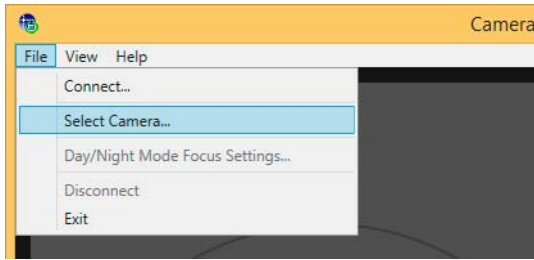

The [Select Camera] dialog box appears.

- 2 Click [Load camera specification file].

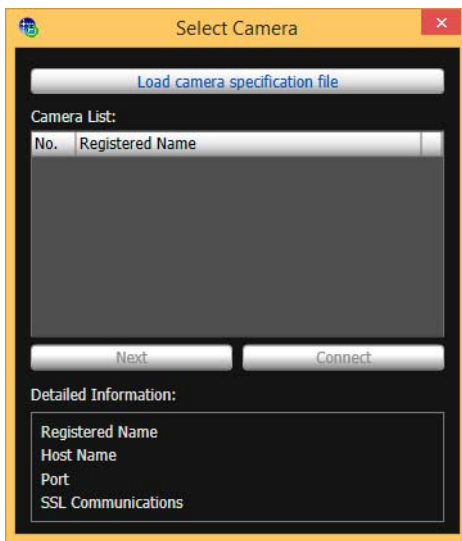

- 3 Select a camera specification file and click [Open].

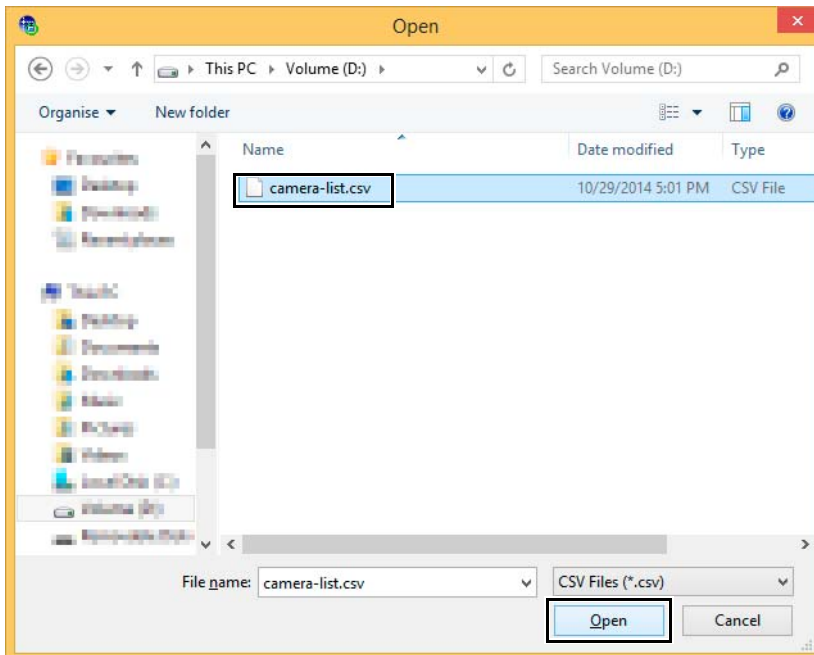

The camera specification file will be loaded and the camera name will appear in [Camera List].

- 4 Select a camera to connect to and click [Connect].

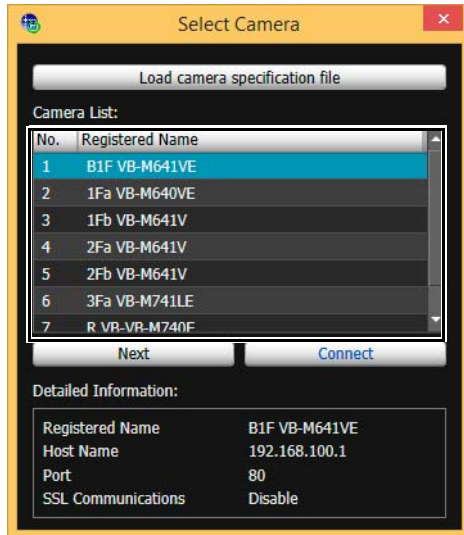

You will connect to the camera.

■ Connect to the Next Camera

After setting the camera angle, click [Next] to connect to the next camera.

You will be disconnected from the current camera and connected to the next camera appearing in the list.

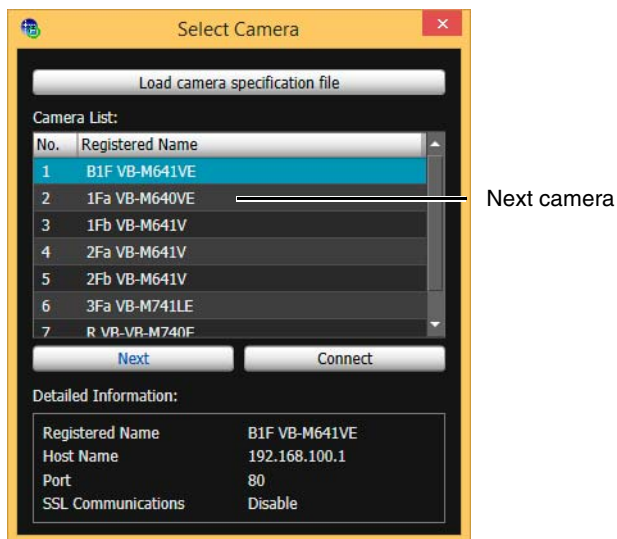

🗨 Note

- The [Select Camera] dialog box will continue to display until you close the Camera Angle Setting Tool or click the X in the upper right corner of the dialog box.
- The camera list will be discarded when the Camera Angle Setting Tool is closed. Load the camera specification file the next time you launch the Camera Angle Setting Tool.

Disconnect from the Camera and Close the Software

Once you have completed setting the camera angle, follow the steps below to disconnect from the camera and close the Camera Angle Setting Tool. Note that camera angle settings will be lost if you turn the camera on/off without performing these steps.

1 Click [File] menu > [Disconnect].

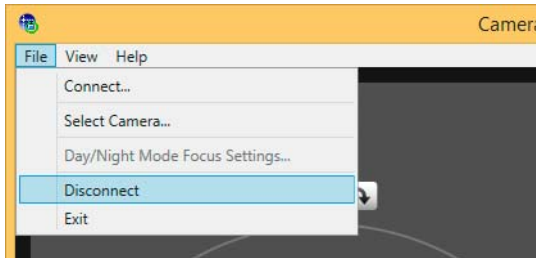

You will disconnect from the camera.

2 Click [File] menu > [Exit].

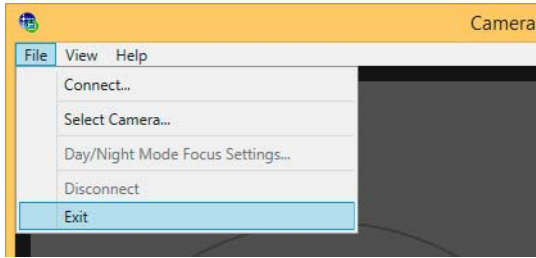

The Camera Angle Setting Tool will close.

Camera Angle Setting Tool Screen

M641 M640



M741 M740

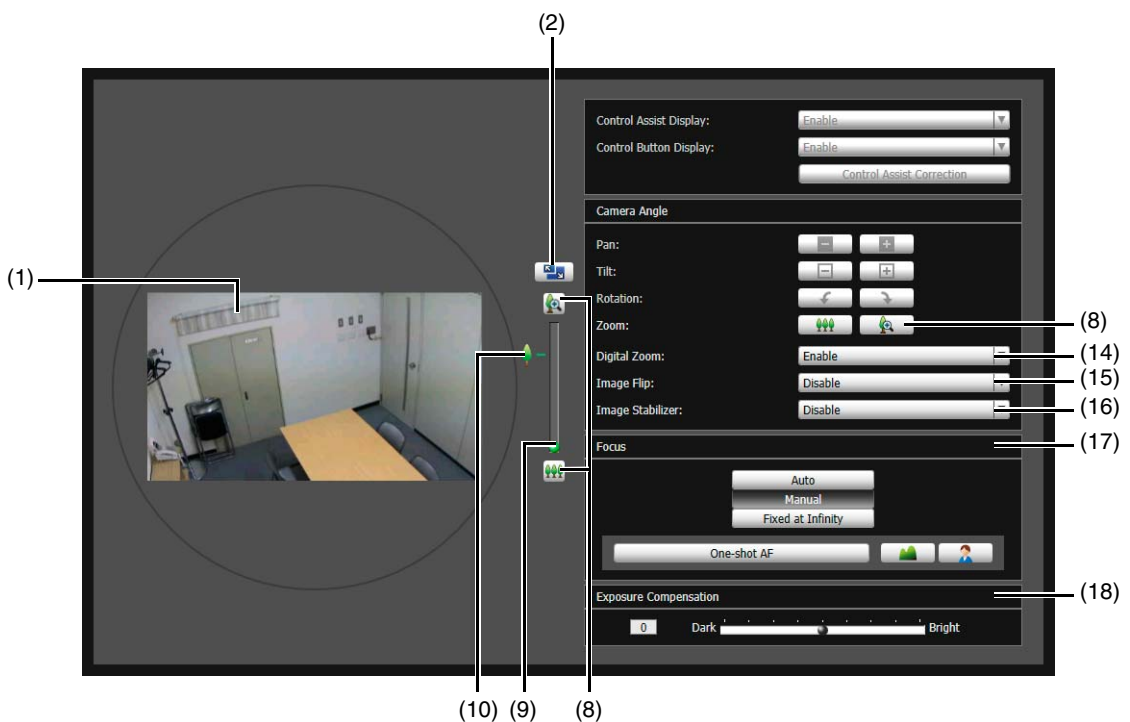

- (1) Video Display Area
Camera video appears here.
- (2) [Switch Screen Size] Button
Switch the Camera Angle Setting Tool screen between small and large sizes.
You can select the screen size with [Display] menu > [Display screen size].
- (3) Control Assist Display **M641 M640**
Display dotted lines indicating the possible ranges for panning and tilting.

- (4) **[Pan] Buttons** **M641** **M640**
Pan the camera.
- (5) **[Tilt] Buttons** **M641** **M640**
Tilt the camera.
- (6) **[Rotation] Buttons** **M641** **M640**
Rotate the camera.
- (7) **[Rotation] Slider** **M641** **M640**
Click on the slider or drag the slider to rotate the camera angle.
- (8) **[Zoom] Buttons**
Zoom the camera.
- (9) **[Zoom] Slider**
Click on the slider or drag the slider to zoom the camera.
- (10) **Optical telephoto end icon**
Appears when [Digital Zoom] > [Enable] has been selected. Digital zoom is used when dragging the slider above this icon.
- (11) **[Control Assist Display] Selection Menu** **M641** **M640**
Select whether or not to display control assistance in the video display area.
- (12) **[Control Button Display] Selection Menu** **M641** **M640**
Select whether or not to display pan and tilt control buttons in the video display area.
- (13) **[Control Assist Correction] Button** **M641** **M640**
If you click this when the displayed control assistance does not match the actual camera angle, the actual camera angle will be confirmed and the position of the displayed control assistance automatically corrected. Correction takes approximately one minute.
- (14) **[Digital Zoom]**
Select whether or not to use digital zoom.
If you select [Enable], the digital zoom range will appear on the zoom slider and you will be able to use digital zoom.
The higher the digital zoom ratio, the lower the video quality.
- (15) **[Image Flip] Selection Menu**
Select the orientation of the camera video.
If [Enable] is selected, the video is displayed rotated 180 degrees.
- (16) **[Image Stabilizer]**
Select this to reduce blur in video due to camera vibration.
If there is still blur after selecting [On1], select [On2].
The angle of view will be narrower and the video noisier when using stabilization compared to when it is not used.



Important

- Stabilization will not affect blurring of subjects.
- Stabilization is not effective beyond a certain degree of vibration or for momentary vibrations.
- If you select [On2], it is recommended selecting a video reception size less than 640 × 480.
- If you use stabilization, please refer to the information listed in the following “Important” sections.
 - The “Important” section in “View Restriction Setting Tool” (P. 207).
 - The “Important” section in “View Video With Admin Viewer” (P. 143).
 - The “Important” section in “Register Presets” (P. 170).

- (17) **[Focus]**
Focus the camera (P. 54).
- (18) **[Exposure Compensation] Slider**
Adjust exposure to suit the brightness of subjects (P. 55).

Set the Camera Angle

After connecting to the camera, view the displayed video to make settings, such as the camera angle and zoom.

Important

You will have to reconfigure Intelligent Function detection area settings, privacy mask settings, or preset settings you have already made on a camera, if you change settings on that camera with the Camera Angle Setting Tool.

Set the Camera Angle and Zoom

You can set the camera angle and zoom using the video display area or buttons.

■ Make Settings with the Operation Buttons and Sliders M641 M640

You can set the camera angle with the [Pan], [Tilt] and [Rotation] buttons. While you push a button, the camera angle will change in that direction. When you release the button, the camera angle will stop.

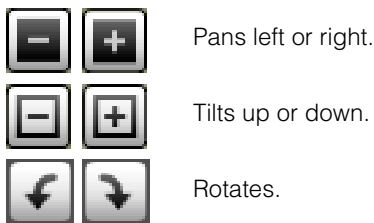

If you rotate the camera angle using the [Rotation] slider, release the mouse button when the video display area is horizontal.

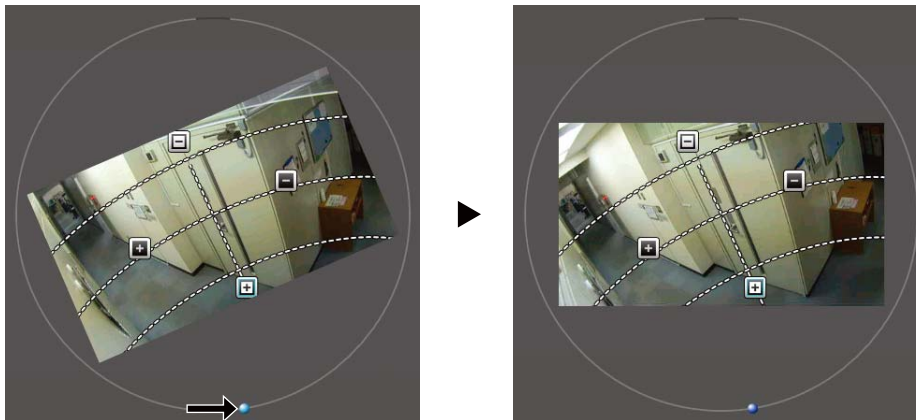

■ Set Camera Angle by Clicking Video M641 M640

If you click anywhere in the video display area, the camera angle will change to center on that location. If you click outside the pan or tilt range, however, the camera angle will only change for the one which is within its range.

Note

If the camera moves differently than the intended operation, or if settings in the full range displayed by control assist cannot be made, control assist may be out of alignment with the actual camera angle. If this happens, reset the camera angle after clicking [Control Assist Correction].

Change the Camera Zoom Ratio

You can change the zoom ratio of the camera with the [Zoom] buttons or [Zoom] slider. Operation will continue while you hold a [Zoom] button down and stop when you release it.



Zooms in.



Zooms out.

If you drag the slider handle, the camera zoom ratio will change according to the position on the slider. If you select [Digital Zoom] > [Enable], the maximum optical telephoto icon and digital zoom range will appear and you will be able to use digital zoom. The higher the digital zoom ratio, however, the lower the video quality becomes.

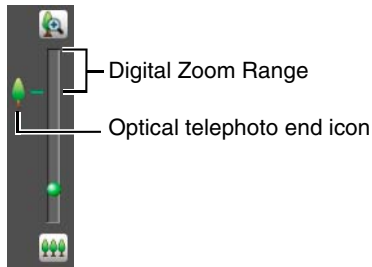

Set the Focus and Exposure Compensation

This focuses on the subject. Adjust exposure to suit the brightness of subjects.



Note

The exposure compensation value set with the Camera Angle Setting Tool will be reset when the camera is rebooted.

Set the Focus

You can automatically or manually focus on subjects, or set focus to infinity. You can use One-shot AF to focus on subjects manually.

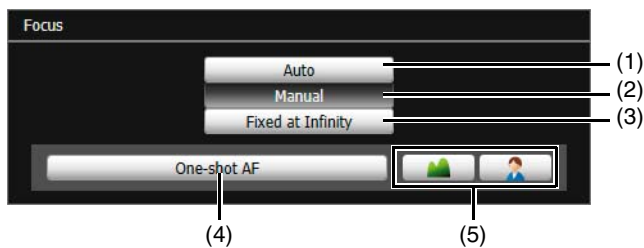

(1) [Auto]

Automatically focuses on the subject.

(2) [Manual]

Use buttons ((4) and (5)) to manually adjust focus.

(3) [Fixed at Infinity]

Fixes the focus near infinity.

(4) [One-shot AF]

Use when the focus mode is set to [Manual]. When you click this, it will focus once using autofocus and then switch to manual focus.

(5) Far and Near Buttons

Use to adjust focus when the focus mode is set to [Manual].

Focus will change while you hold the buttons down and stop when you release them.



Focuses further away.









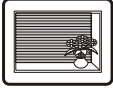

Focuses nearer.

Note

- Focusing may be difficult for the following types of subjects when using [Auto] or [One-shot AF].

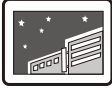
Difficult to Focus Subjects

 A white wall or other subject lacking bright/dark contrast	 A slanting subject	 A subject reflecting strong light
 A subject consisting of only slant lines or horizontal stripes	 A subject having no form, such as flame or smoke	 A subject seen through glass
 A fast moving subject	 A dark area or night view	 Subjects both near and far

- It is recommended that you check that the camera is focused whenever you restart the camera or use One-shot AF.
- The focus ranges (approximate) are shown in the table below.

Focus Mode	Day/Night Settings	
	Day mode	Night mode
Auto/Manual	0.3 m (12 in.) – infinity	0.3 m (12 in.) – infinity
Fixed at Infinity	Fixed near infinity*	

* Using infrared illumination from an external device may throw the camera out of focus.

Set the Exposure Compensation

Set the video brightness.



Use a Camera Specification File

If you create a camera specification file listing the information needed to connect to cameras beforehand, you can load the file with the Camera Angle Setting Tool and connect to cameras that appear in the camera list simply by specifying them. When you set the camera angle of multiple cameras, this eliminates the need to enter information, such as the host name and password, of each camera individually.



Important

Enter the actual administrator passwords in the camera specification file. Handle the camera specification file with sufficient care.

Create a Camera Specification File

Create the camera specification file with an editor like the text editor and save the file as .csv format.



Important

The maximum number of cameras that can be listed in a camera specification file is 30. An error will be generated if you try to load a file with the Camera Angle Setting Tool listing 31 or more cameras.

Information Listed in a Camera Specification File

The camera specification file consists of the following format.

Header Row	RegisterName	HostName	PortNumber	UserName	Password	ConnectType
Individual Camera Information (Max. 30 Cameras)	B1F VB-M641VE	192.168.100.1	80	root	camera1	0
	1Fa VB-M640VE	192.168.100.2	80	root	camera2	0
	1Fb VB-M641V	192.168.100.3	80	root	camera3	0
	⋮	⋮	⋮	⋮	⋮	⋮

The first row serves as a header row listing the titles of each column.

Each row from the second row on, lists the information for one camera per row.

The information listed in each column is described below.

Header Row Title	Information Listed in Column
RegisterName	Enter any camera name. This will appear in the camera list when connected.
HostName	Host name or IP address of the camera.
PortNumber	HTTP port number for the camera (default setting is 80).
UserName	Administrator user name for the camera (default setting is "root").
Password	Administrator password for the camera (default setting is "camera").
ConnectType	Enable SSL communications: 1 Disable SSL communications: 0 (default setting is 0).

■ Example Using a Text Editor for Entry

Enter each item separated by a comma. Give the file the .csv extension and save it.

```
RegisterName,HostName,PortNumber,UserName>Password,ConnectType
B1F VB-M641VE,192.168.100.1,80,root,camera1,0
1Fa VB-M640VE,192.168.100.2,80,root,camera2,0
1Fb VB-M641V,192.168.100.3,80,root,camera3,0
2Fa VB-M641V,192.168.100.4,80,root,camera4,0
2Fb VB-M641V,192.168.100.5,80,root,camera5,0
3Fa VB-M741LE,192.168.100.6,80,root,camera6,0
R VB-M740E,192.168.100.7,443,root,camera7,0
```



Important

If you separate items with a delimiter other than a comma, such as a semicolon, the Camera Angle Setting Tool will not be able to load the file.

The background of the top section is a vibrant blue gradient. In the upper right corner, there are several overlapping, semi-transparent images of camera lenses, creating a sense of depth and focus.

Chapter 4

Setting Page

The Setting Page is used to make necessary basic settings after camera installation, such as, network, video and security settings, and to make settings to suit the situation in which a camera will be used. It also has the maintenance menu for the camera.

How to Use The Setting Page

This section explains operation up to displaying the Setting Page, and common Setting Page operations.

Access the Setting Page

Use a web browser to access the camera's top page to display the Setting Page.

- 1 Launch the camera top page and click [Setting Page] (P. 41).

A user authentication window appears.

- 2 Enter a user name and password (P. 42) and click [OK].

The Setting Menu will appear.

Note

You can also access the Setting Page from the Camera Management Tool. For details, please refer to the "Camera Management Tool User Manual".

Setting Menu

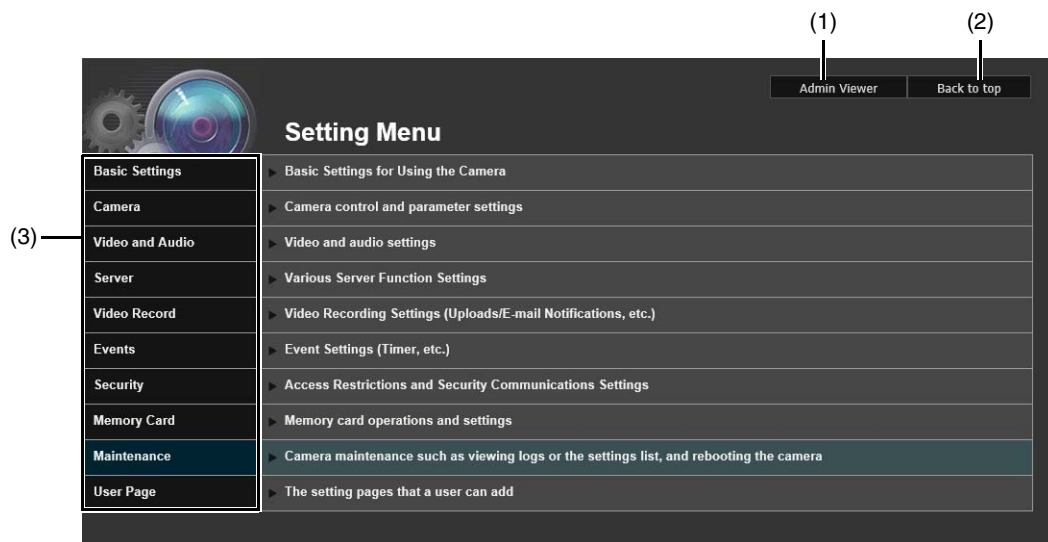

- (1) [Admin Viewer]

Click this button to launch Admin Viewer.

- (2) [Back to top]

Click this button to navigate to the top page.

- (3) Setting Menus

If you click this, a submenu (P. 62) will appear (excluding the [Memory Card], [Maintenance] and [User Page] menus). Click the submenu to navigate to each Setting Page.

Important

- To ensure security, exit the web browser after completing settings on the Setting Page and after using Admin Viewer/Admin Tools.
- Do not open multiple Setting Pages at one time and try to change the settings of a single camera.

Common Setting Page Operations

This section explains basic Setting Page operations, and operations common to all Setting Pages.

■ Applying Changes to Settings

When a setting is changed on the Setting Page, [Apply] shown on the top right and bottom right of the Setting Page changes from grayed-out to blue.



Click [Apply] in this state to apply the changed settings.
Click [Clear] to revert to the previous settings.

■ Setting Changes Requiring Rebooting

Items that require the camera to be rebooted in order to apply the changed settings are indicated with an orange symbol to their right.

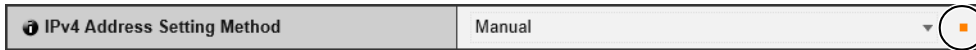

When any item indicated with an orange symbol is changed, [Apply] shown at the top right and bottom right of each Setting Page changes to [Apply and reboot].



Click [Apply and reboot] to apply the changed settings and reboot the camera.
Click [Clear] to revert to the previous settings.

 **Important**
Setting changes will be lost if you navigate to another Setting Page without clicking [Apply] or [Apply and reboot]. Be sure to click [Apply] or [Apply and reboot] to apply the changed settings.

■ Return to the Setting Menu

Click [Settings menu] at the top right of each Setting Page to return to the top menu.



 **Important**
Do not use the [Back] or [Forward] button in the web browser to navigate Setting Pages. The changed settings may revert to the original settings or unwanted setting changes may be applied.

■ Help

Click  [Help] at the beginning of any setting item to display a detailed explanation of that setting item.

■ Setting Ranges and Character Limits

For settings where you enter numerical values or characters, the setting range or character limits that can be entered will be displayed.

Please enter the settings within the displayed limits.



About Each Setting Page

This section will give an overview of each item in Setting Menu and each list of submenus.

Each of the [Basic Settings], [Video and Audio]/[Video], and [Video Record] menus has a [Video Settings] submenu, but the functions are all common. The functions can be set in any of the menus and the settings will be reflected in all of the [Video Settings] submenus.

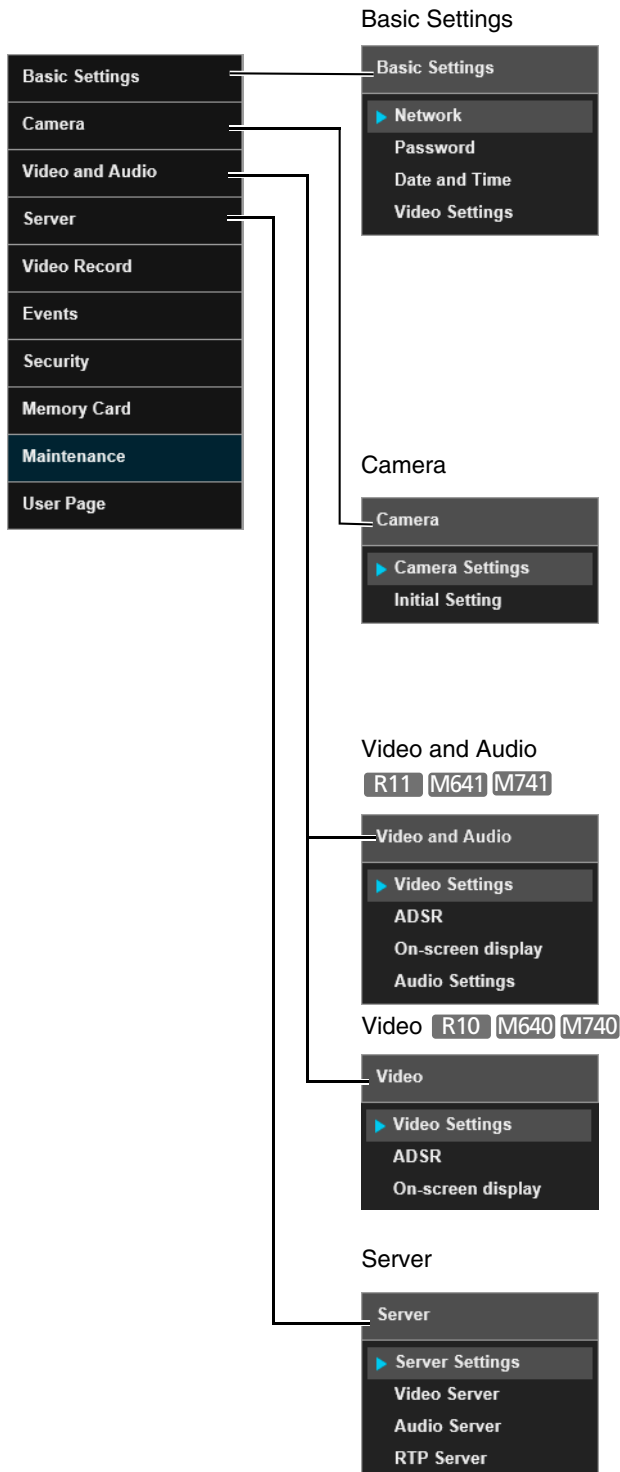

- **Network (P. 64)**
Network settings for connecting to the camera.
- **Password (P. 68)**
Use this to change the administrator password from the default password.
- **Date and Time (P. 69)**
Camera date and time settings.
- **Video Settings (P. 72)**
General video settings, such as the size and quality of video transmitted from the camera.
- **Camera Settings (P. 75)**
Settings for the camera name and external input/output devices, and for camera use and installation settings.
- **Initial Setting (P. 79)**
Sets initial settings, such as video quality compensation, at camera start up.
- **Video Settings (P. 72)**
- **ADSR (P. 82)**
ADSR is an abbreviation for Area-specific Data Size Reduction.
Reduces the size of transmitted H.264 video by reducing the video quality of unspecified area.
- **On-screen Display (P. 85)**
Displays the date and time, camera name and other UI strings on the Viewer.
- **Audio Settings (P. 87)** **R11 M641 M741**
Settings for audio input from the microphone connected to the camera and audio output from the Viewer.
- **Server Settings (P. 89)**
Settings for HTTP server, SNMP server, FTP server usage or WS-Security time checks.
- **Video Server (P. 91)**
Settings for clients that can be connected to a video server.
- **Audio Server (P. 92)** **R11 M641 M741**
Settings for audio transmission from the camera to the computer, and audio reception from the computer to the camera.
- **RTP Server (P. 93)**
Settings for RTP streaming.

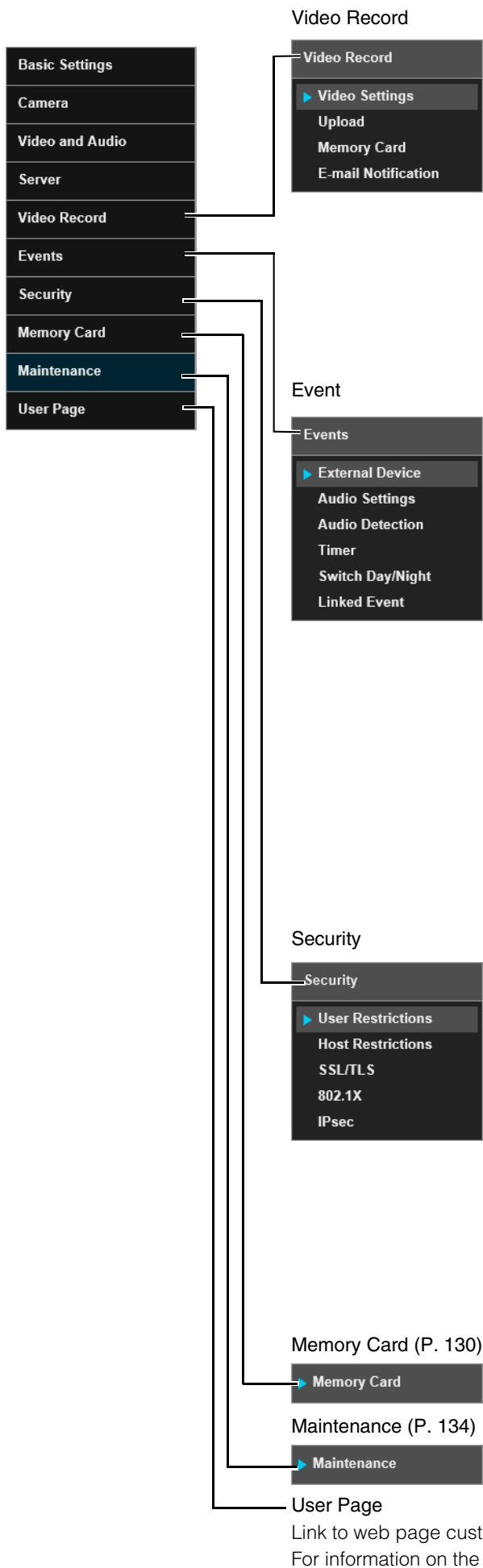

- **Video Settings (P. 72)**
 - **Upload (P. 96)**
Settings for uploading video via HTTP or FTP when an event is triggered.
 - **Memory Card (P. 101)**
Settings for recording video to a memory card when an event is triggered.
The settings of this item are the same as those of the [Memory Card] menu. The settings can be made with either of them.
 - **E-mail Notification (P. 102)**
Settings for sending an e-mail notification to a specified recipient when an event is triggered.
 - **External Device (P. 104)** **R11 M641 M741**
Operation settings for external device output and for external device input triggered events.
 - **Audio Settings (P. 87)** **R11 M641 M741**
The settings of this item are the same as those of [Video and Audio] > [Audio Settings].
 - **Audio Detection (P. 107)** **R11 M641 M741**
Detected changes in audio input from the microphone connected to the camera can trigger operations such as video recording or e-mail notification.
 - **Timer (P. 110)**
The timer function can generate events that can trigger operations, such as video recording and e-mail notifications, at regular intervals.
 - **Switch Day/Night (P. 112)**
The camera angle can be moved to preset positions when events cause Day Mode and Night Mode to switch.
 - **Linked Event (P. 113)** **R11 M641 M741**
By linking two types of events, a single event is triggered.
 - **User Restrictions (P. 118)**
Used for adding new authorized users that can access the Admin Viewer, and for setting permissions for users.
 - **Host Restrictions (P. 119)**
Separate access control from IPv4 and IPv6 addresses can be set.
 - **SSL/TLS (P. 121)**
Certificate creation, administrative settings and encrypted communication settings.
 - **802.1X (P. 124)**
Settings for 802.1X authentication and authentication status display, and for certificate administration.
 - **IPsec (P. 126)**
Settings for using IPsec.
- Perform memory card operations or configure settings.
- Check logs or settings, or perform camera maintenance.

Configure Network Settings

[Basic Settings] > [Network]

Network settings for connecting to the camera.





Important

If any network settings are changed, the camera may become inaccessible from the active web browser. If this occurs, a confirmation dialog box will appear when you click [Apply] or [Apply and reboot]. Click [OK] to apply the new settings.

If you reboot the camera after changing settings and cannot connect to the camera from the web browser, any available URI for connecting to the camera will be displayed in a message. If you cannot connect to the camera through the displayed URI, contact your system administrator.

LAN

Set the LAN communication method and size of video transmitted from the camera.

LAN	
 LAN Interface	Auto  
 Maximum Packet Size <small>576 - 1500</small>	1500 

[LAN Interface]

Select the interface suited to the device for connecting to the camera. Generally use [Auto].

[Maximum Packet Size]

Enter the maximum packet size to be transmitted by the camera. Normally there is no need to change the default setting of 1500.

A setting of 1280 or greater is necessary when using IPv6.













When using ADSL, setting a slightly lower value may increase transmission efficiency.

IPv4

Settings for using IPv4 to connect to the camera. The IPv4 address can be assigned by the DHCP server automatically or set manually.

Important

- Contact your System Administrator for the [IPv4 Address], [Subnet Mask] and [IPv4 Default Gateway Address] if you set the IPv4 address manually.
- If any of the [IPv4 Address], [Subnet Mask] or [IPv4 Default Gateway Address] settings are wrong, the camera may become inaccessible via the network. If this occurs, use the Camera Management Tool to reset the address (P. 36).

IPv4	
 IPv4 Address Setting Method	Manual  
 IPv4 Address	192.168.1.100 
 Subnet Mask	255.255.255.0 
 IPv4 Default Gateway Address	
 AutoIP	Enable 
 IPv4 Address (AutoIP)	192.168.1.100 

[IPv4 Address Setting Method]

Select the method for setting the IPv4 address.

For [Manual], enter a fixed IPv4 address into [IPv4 Address].

For [Auto (DHCP)], the settings acquired from the DHCP server will be automatically entered in [IPv4 Address], [Subnet Mask] and [IPv4 Default Gateway Address].

Important

If [Auto (DHCP)] is selected as the IPv4 address setting method, the IPv4 address may not be assigned correctly in certain environments, such as when a router is present between the DHCP server and the camera. If this occurs, select [Manual] and enter a fixed IPv4 address.

[IPv4 Address]

When [IPv4 Address Setting Method] is set to [Manual], enter a fixed IPv4 address. The IP address cannot start with 127., such as 127.0.0.1.

[Subnet Mask]

When [IPv4 Address Setting Method] is set to [Manual], enter the designated subnet mask values for each network.

[IPv4 Default Gateway Address]

When [IPv4 Address Setting Method] is set to [Manual], enter a default gateway IP address. Be sure to set this when connecting the camera to a different subnet from that of the Viewer.

[AutoIP]

Select this to enable or disable AutoIP.

[IPv4 Address (AutoIP)]

When [AutoIP] is set to [Enable], an automatically set IPv4 address is displayed.

IPv6

Settings for using IPv6 to connect to the camera. The IPv6 address can be assigned by the RA or DHCPv6 server automatically or set manually.

Important

Contact your System Administrator for the [IPv6 Address], [Prefix Length] and [IPv6 Default Gateway Address] if you set the IPv6 address manually.

IPv6	
IPv6	Enable
Auto (RA)	Enable
Auto (DHCPv6)	Enable
IPv6 Address (Manual)	
Prefix Length <small>16 - 128</small>	64
IPv6 Default Gateway Address	
IPv6 Address (Auto)	<input type="text"/> <input type="text"/> <input type="text"/> <input type="text"/> <input type="text"/>

[IPv6]

Select this to enable or disable IPv6.

[Auto (RA)]

Select [Enable] to set an address automatically using RA (Router Advertisement, network information automatically transmitted from a router).

[Auto (DHCPv6)]

Select [Enable] to use DHCPv6 to set an address automatically.

[IPv6 Address (Manual)]

Enter a fixed IPv6 address if you set the address manually.

[Prefix Length]

Enter a prefix length if [Disable] is specified in [Auto (RA)].

[IPv6 Default Gateway Address]

Enter a default gateway address if [Disable] is specified in [Auto (RA)]. Be sure to set this when connecting the camera to a different subnet from that of the Viewer.

[IPv6 Address (Auto)]

If [Enable] is specified in [IPv6] and [Enable] is specified in [Auto (RA)] and [Auto (DHCPv6)], then the automatically acquired address will be shown.

Note

In an environment where IPv6 cannot be used, and IPv6/Auto is set to [Enable], then only the link-local address will be displayed in the [IPv6 Address (Auto)] field.

DNS

Set the DNS server address. The DNS server address can be set manually or automatically assigned by a DHCP/DHCPv6 server.

DNS	
Name Server Address 1	<input type="text"/>
Name Server Address 2	<input type="text"/>
Auto-Setting of Name Server Address	<input type="text" value="Use DHCP/DHCPv6"/>
Name Server Address (DHCP)	<input type="text"/>
Name Server Address (DHCPv6)	<input type="text"/>
Host Name <small>Up to 63 characters</small>	<input type="text"/>
Host Name Registration with DDNS	<input type="text" value="Disable"/>
Search Domain <small>Up to 63 characters</small>	<input type="text"/> <input type="button" value="Add"/>
Search Domain List	<div style="border: 1px solid gray; height: 100px; width: 100%;"></div> <input type="button" value="Delete"/> <input type="button" value="▲"/> <input type="button" value="▼"/>

[Name Server Address 1], [Name Server Address 2]

Enter the name server address you want to register. To register only one address, keep the [Name Server Address 2] field blank.

You must set at least one if you manually set the IPv4 address or IPv6 address.

Note

If [Name Server Address 1] is unavailable, [Name Server Address 2] will be accessed. However, [Name Server Address 2] must be set in advance.

[Auto-Setting of Name Server Address]

Select the server to use for automatically setting the name server address.

To set [Use DHCP], select [Auto (DHCP)] in [IPv4 Address Setting Method] (P. 64).

To set [Use DHCPv6], select [Enable] in [IPv6], then select [Enable] in [Auto (DHCPv6)] (P. 65).

[Name Server Address (DHCP)]

Select [Use DHCP] or [Use DHCP/DHCPv6] in [Auto-Setting of Name Server Address] to display the name server address acquired from the DHCP server.

[Name Server Address (DHCPv6)]

Select [Use DHCPv6] or [Use DHCP/DHCPv6] in [Auto-Setting of Name Server Address] to display the name server address acquired from the DHCPv6 server.

[Host Name]

You can register the camera host name in name server using alphanumeric characters.

Do not use “_” (underscore) in the host name in Internet Explorer 8/9/10/11.

[Host Name Registration with DDNS]

When you enter a name into [Host Name] and select [Enable], the host name will be registered in the name server.

Registering the host name to DDNS is useful when operating with [IPv4 Address Setting Method] set to [Auto (DHCP)] (P. 64). DNS server registration settings must be set in advance. Contact your system administrator for the DNS server settings.

[Search Domain]

Enter a domain name and click [Add] to add the domain name to the Search Domain List.

Specify the host name without specifying a domain name for a server, such as the upload server, to search domains in the form “host name + domain name”, where the domain names are specified in the Search Domain List.

Do not use “_” (underscore) in the domain name in Internet Explorer 8/9/10/11.

[Search Domain List]

A list of domain names added using [Search Domain].

The function queries the DNS server for each domain name starting from the top of the list.

Use the ▲▼ buttons on the right to change the order of the domain names.

To delete a domain name, select one from the list and then click [Delete].

mDNS

This will configure settings for using multicast DNS. If you use mDNS, the IP address and host name of the camera will be broadcast to other hosts on the network.

mDNS	
<input checked="" type="checkbox"/> Use mDNS	Enable ▼

[Use mDNS]

Select this to enable or disable mDNS.

Set the Administrator Password

[Basic Settings] > [Password]

In order to prevent users, other than administrators, from changing the system, change the administrator password from the default password.



Important

- To ensure system security, be sure to change the administrator password. Do not forget the new password.
- Press the reset switch to restore factory default settings if you have forgotten the administrator password (P. 270). Note, however, that this will reset all camera settings to factory default settings except for date and time.

Administrator Password

Change the administrator password.

Administrator Password	
Password Up to 8 characters	*****
Confirm Password Up to 8 characters	*****

[Password]

Enter the administrator password in alphanumeric characters (spaces or printable characters).

The factory default setting is "camera".

If the Admin Viewer, Admin Tools, etc., are connected, terminate the connection before changing the password.

[Confirm Password]

Enter the same password as above for confirmation.

Set the Date/Time

[Basic Settings] > [Date and Time]

Camera date and time settings.

Current Date and Time

The date and time set in the camera are shown.

Current Date and Time	
Date <small>yyyy/mm/dd</small>	2014/10/30
Time <small>hh:mm:ss</small>	14:02:29

Setting

Set the date and time setting method, time zone and daylight saving time for the camera.

Setting	
Setting Method	Set manually
Date <small>yyyy/mm/dd</small>	2014/10/30
Time <small>hh:mm:ss</small>	14:02:29
Time Zone	(GMT+09:00) Osaka, Sapporo, Tokyo
Daylight Saving Time	Disable

[Setting Method]

Select the date and time setting method.

The settings are configured as follows depending on the setting configured in [Setting Method].

[Set manually]

Set the desired date and time in [Date] and [Time].

Set the time in 24-hour format in <hour:minute:second> order.

[Synchronize with NTP server]

Select the setting method displayed in [Auto-Setting of NTP Server].

[Not used]

Setting	
Setting Method	Synchronize with NTP server
Auto-Setting of NTP Server	Disable
NTP Server <small>Up to 63 characters</small>	rtp.nict.jp
Time Zone	(GMT+09:00) Osaka, Sapporo, Tokyo
Daylight Saving Time	Disable

Enter the IP address or host name of the NTP server in [NTP Server].

[Use DHCP]

Setting	
Setting Method	Synchronize with NTP server
Auto-Setting of NTP Server	Use DHCP
NTP Server (DHCP)	
Time Zone	(GMT+09:00) Osaka, Sapporo, Tokyo
Daylight Saving Time	Disable

The camera time is synchronized with the time of the NTP server at the address acquired from the DHCP server. The acquired NTP server address appears in [NTP Server (DHCP)].

In order to set [Use DHCP], you must change [Network] > [IPv4] > [IPv4 Address Setting Method] to [Auto (DHCP)] (P. 64).

[Use DHCPv6]

Setting	
Setting Method	Synchronize with NTP server
Auto-Setting of NTP Server	Use DHCPv6
NTP Server (DHCPv6)	
Time Zone	(GMT+09:00) Osaka, Sapporo, Tokyo
Daylight Saving Time	Disable

The camera time is synchronized with the time of the NTP server at the address acquired from the DHCPv6 server. The acquired NTP server address appears in [NTP Server (DHCPv6)].

In order to set [Use DHCPv6], you must change [Network] > [IPv6] > [Use IPv6] to [Enable], then set [Auto (DHCPv6)] to [Enable] (P. 65).

[Use DHCP/DHCPv6]

The camera time is synchronized with the time of the NTP server at the address acquired from the DHCP server or DHCPv6 server.

If the NTP server (address) can be acquired from both the DHCP server (IPv4) and DHCPv6 server, the NTP server address acquired from the DHCP server (IPv4) will be used.

[Synchronize with NTP broadcast]

The camera will synchronize time with NTP broadcasts received from the NTP server.

The camera's NTP broadcast mode does not support IPv6.

Setting	
Setting Method	Synchronize with NTP broadcast
Time Zone	(GMT+09:00) Osaka, Sapporo, Tokyo
Daylight Saving Time	Disable

[Synchronize with computer time]

The date and time will be synchronized with that of the computer currently accessing the camera. After clicking [Apply], [Setting Method] will change to [Set manually].

[Time Zone] is not automatically selected, so set it if necessary.

Setting	
Setting Method	Synchronize with computer time
Date yyyy/mm/dd	2014/11/28
Time hh:mm:ss	14:42:05
Time Zone	(GMT+09:00) Osaka, Sapporo, Tokyo
Daylight Saving Time	Disable

Note

- If the NTP server IP address is incorrect or a connection with the NTP server cannot otherwise be established, the date and time will not be changed.

- The NTP server query interval is 300 seconds. Synchronization will take time if the time difference is large.

[Time Zone]

Select the appropriate time zone.

If the time zone is changed, the date and time display will update automatically according to the specified time zone.

[Daylight Saving Time]

Select whether or not to automatically adjust for daylight saving time to suit the time zone.

Set Video Size and Quality

[Basic Settings] > [Video Settings]

General video settings, such as the size and quality of JPEG and H.264 video transmitted from the camera.

Important

- This [Video Settings] submenu is common with the [Video Settings] submenu found in [Video and Audio] or [Video], and [Video Record]. A setting configured in any of the [Video Settings] submenus will be reflected in the other [Video Settings] submenus.
- The following may occur if video size, video quality and target bit rate are set higher, as this increases network load and data size per frame.
 - JPEG: The frame rate may drop
 - H.264: Video may be temporarily disrupted
- In case of H.264 video, block noise may become noticeable if a large video size and low target bit rate are set.
- The data size may increase depending on the type or movement of the subject. If the frame rate remains low or other undesirable conditions continue for a prolonged period, lower the video size or quality setting.
- The included RM-Lite can only record JPEG video.

All Videos

Set the video size sets used by the camera.

All options in the [Video Settings] submenu and the size sets that can be selected in [Video Size] in all of the Setting Pages are determined by the video size set selected here.

This also determines the video sizes and screen sizes that can be selected by each Viewer.

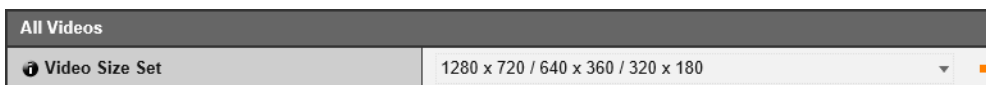

[Video Size Set]

Categories and aspect ratios vary according to each video size set.

[Video Size Set]	Category	Aspect Ratio
[1280 x 720 / 640 x 360 / 320 x 180]	720p	16:9
[1280 x 960 / 640 x 480 / 320 x 240]	4:3	4:3

Important

Changing the [Video Size Set] selection and clicking [Apply and reboot] will disconnect all connections and then change all the video sizes. Consequently, users connected to the camera must reconnect.

If the [Video Size Set] selection is changed, review the following settings and check the operation.

- ADSR
- Privacy Mask settings
- Intelligent Function settings
- Present Setting
- View Restriction settings **R11** **R10**
- Camera Angle Setting Tool **M641** **M640** **M741** **M740**

JPEG

You can configure settings for the quality and size of JPEG video transmitted from the camera, as well as, the video size when recording the camera video.

The video sizes that can be set or selected depend on the [Video Size Set] setting.

JPEG	
Video Quality: 320 x 180	6
Video Quality: 640 x 360	6
Video Quality: 1280 x 720	6
Video Quality: Digital PTZ	6
Video Size: video Transmission	320 x 180
Maximum Frame Rate: Video Transmission 0.1 - 30	30.0
Video Size: Upload / Memory card	320 x 180

[Video Quality]

Select the video quality transmitted from the camera for each size in a video size set. Greater values have higher quality.

[Video Quality: Digital PTZ] **M641** **M640** **M741** **M740**

Select the video quality for digital PTZ.

[Video Size: Video Transmission]

Select the default video size transmitted from the camera when no video size has been specified by the Viewer.

[Maximum Frame Rate: Video Transmission]

Limit the maximum frame rate per second transmitted to reduce the viewer load. Up to 30 frames per second can be set.

[Video Size: Upload/Memory card]

Select the size of video when using the upload function (P. 96) or when recording to a memory card (P. 101). Set whether to upload a video or record it to a memory card with [Video Record] > [Upload] or [Memory Card] > [Video Record Action] (P. 96).

H.264(1)

Settings for H.264(1) video transmitted from the camera.

Configure settings here for using H.264 video for upload or memory card recording. H.264(2) video cannot be used for upload or memory card recording.

H.264(1) video can be displayed using Admin Viewer and RM-Lite Viewer. It cannot be displayed using VB Viewer.

The video sizes that can be selected depend on the [Video Size Set] setting.

H.264(1)	
Video Size	320 x 180
Bit Rate Control	Use bit rate control
Target Bit Rate (kbps)	2048
Frame Rate (fps)	30
I Frame Interval (sec)	1

[Video Size]

Select the size of the video transmitted from the camera.

[Bit Rate Control]

Set the video bit rate.

If you select [Use bit rate control], please set [Target Bit Rate (kbps)]. If you select [Do not use bit rate control], please set [Video Quality].

[Target Bit Rate (kbps)]

You can select the target bit rate if [Bit Rate Control] is set to [Use bit rate control].

Bit Rate Control	Do not use bit rate control
Video Quality	6

[Video Quality]

You can select the video quality if [Bit Rate Control] is set to [Do not use bit rate control]. Greater values have higher quality.

[Frame Rate (fps)]

Select the video frame rate.

[I Frame Interval (sec)]

Select the I frame interval (sec) for H.264 video.



Important

- When [H.264(1)] is used for memory card recording and upload, the following restrictions apply to the [H.264(1)] setting.
 - [Bit Rate Control]: [Use bit rate control] only
 - [Target Bit Rate (kbps)]: [3072] or less
 - [I Frame Interval (sec)]: either [0.5], [1], or [1.5]
- The included RM-Lite cannot record H.264 video.

H.264(2)

Settings for H.264(2) video transmitted from the camera.

H.264(2) video can be displayed using Admin Viewer and RM-Lite Viewer. It cannot be used for upload, memory card recording, or by VB Viewer.

The video sizes that can be selected depend on the [Video Size Set] setting.

H.264(2)	
H.264(2)	Enable
Video Size	320 x 180
Bit Rate Control	Use bit rate control
Target Bit Rate (kbps)	2048
Frame Rate (fps)	30
I Frame Interval (sec)	1

[H.264(2)]

Select [Enable] to dual stream H.264 video.

[Video Size], [Bit Rate Control], [Target Bit Rate (kbps)], [Video Quality], [Frame Rate (fps)], [I Frame Interval (sec)]

Please refer to each setting in "H.264(1)".



Important

- When dual streaming H.264 videos, setting the video size for H.264(1) and H.264(2) to the following combinations restricts the frame rate to a maximum of 15 fps. For all other combinations, a frame rate of up to 30 fps can be selected.

H.264(1)	H.264(2)
1280 x 960	1280 x 960
1280 x 720	1280 x 720

- The included RM-Lite cannot record H.264 video.

Set General Camera Controls

[Camera] > [Camera Settings]

Settings for the camera name and external input/output devices, and for camera use and installation settings.

Camera Name

Set the camera name.

Camera Name	
Camera Name (alphanumeric characters) <small>Up to 15 characters</small>	Camera

[Camera Name]

Enter any camera name. Be sure to enter a name in [Camera Name (alphanumeric characters)].

Camera Control

Set various controls to ease viewing of video.

Camera Control	
Digital Zoom	Disable
Image Stabilizer	Disable
AGC Limit	6
Smart Shade Control Strength (Auto)	Medium
Haze Compensation Strength (Auto)	Medium
Pan/Tilt Speed Control	Control by zoom position
Auto Flip	Enable

M741

Infrared Strength (Auto)	Strong
---------------------------------	--------

[Digital Zoom] **R11** **R10**

Select this to enable or disable digital zoom.

If [Enable] is selected, the digital zoom telephoto end icon will appear next to the zoom slider in the Viewer (P. 148).

Unlike optical zoom, the higher the digital zoom ratio, the lower the video quality.

[Image Stabilizer]

Select this to enable or disable blur reduction in video due to camera vibration.

If there is still blur after selecting [On1], select [On2].

The angle of view will be narrower and video noisier when using stabilization compared to when it is not used.



Important

- The image stabilizer is not effective when the subject is shaking.
- Stabilization is not effective beyond a certain degree of vibration or for momentary vibrations.
- If you select [On2], It is recommended to select a video reception size less than [640 x 480].
- If you use stabilization, please refer to the information listed in the following "Important" sections.
 - The "Important" section in "View Restriction Setting Tool" (P. 207).
 - The "Important" section in "View Video With Admin Viewer" (P. 143).
 - The "Important" section in "Register Presets" (P. 170).

[AGC Limit]

Select the Auto Gain Control (AGC) limit value for increasing gain to brighten video in low light conditions.

The greater the value, the higher the sensitivity will become, but video noise will increase.

Important

- [AGC Limit] will not function if [Admin Control] > [Exposure] (P. 162) is set to [Manual] or [Auto (Flickerless)].
- Minimum subject illumination may change when [AGC Limit] is set.

[Smart Shade Control Strength (Auto)]

Select the control strength when [Smart Shade Control] (P. 80) is set to [Auto].

- [Mild]: Select if noise is noticeable.
- [Medium]: Recommended setting for Auto mode (default setting).
- [Strong]: Select to increase visibility in dark areas.

[Haze Compensation Strength (Auto)]

Select the strength of compensation when [Haze Compensation] (P. 81) is set to [Auto].

Note

When [Haze Compensation] is set to [Auto] and [Haze Compensation Strength (Auto)] is set to [Strong], contrast may be strong if the subject is not obscured by haze. If this happens, set [Haze Compensation Strength (Auto)] to [Mild].

[Infrared Strength (Auto)] **M741**

Select the infrared illumination strength when you have selected [Auto], [Auto (Flickerless)] or [Auto (Shutter-priority AE)] for [Exposure] (P. 80).

Note

- If all or part of the image appears to have a white glow, there is a possibility that a wall (even a wall not in the image) is reflecting the infrared lighting. If this occurs, please adjust the camera angle.
- When using the infrared lighting, and there is a problem in getting the desired contrast on the object (would like the image brighter or darker), please adjust the Exposure Compensation (P. 80) and/or the Metering Mode (P. 80).

[Pan/Tilt Speed Control] **R11 R10**

Select the pan/tilt control mode.

If [Control by zoom position] is selected, the pan/tilt speed will be slower in telephoto, and faster in wide-angle.

Note

- Pan/Tilt Speed Control can also be set in [Control for Admin] > [Pan/Tilt Speed] (P. 148).
- If [Control by zoom position] is selected, [Control for Admin] > [Pan/Tilt Speed] will also be fixed at [Control speed by zoom position].

[Auto Flip] **R11 R10**

Select this to enable or disable Auto Flip.

If you enable Auto Flip and tilt the camera using the video display area in the Admin Viewer/VB Viewer (P. 147), the video will flip when the tilt angle of the camera nears 100°.

For example, if tracking a subject that passes directly under a ceiling mounted camera (tilt angle 90°), the video will flip as the tilt angle nears 100° without the subject appearing inverted.

Note

Auto Flip may be disabled depending on the View Restriction Setting Tool settings (P. 209).

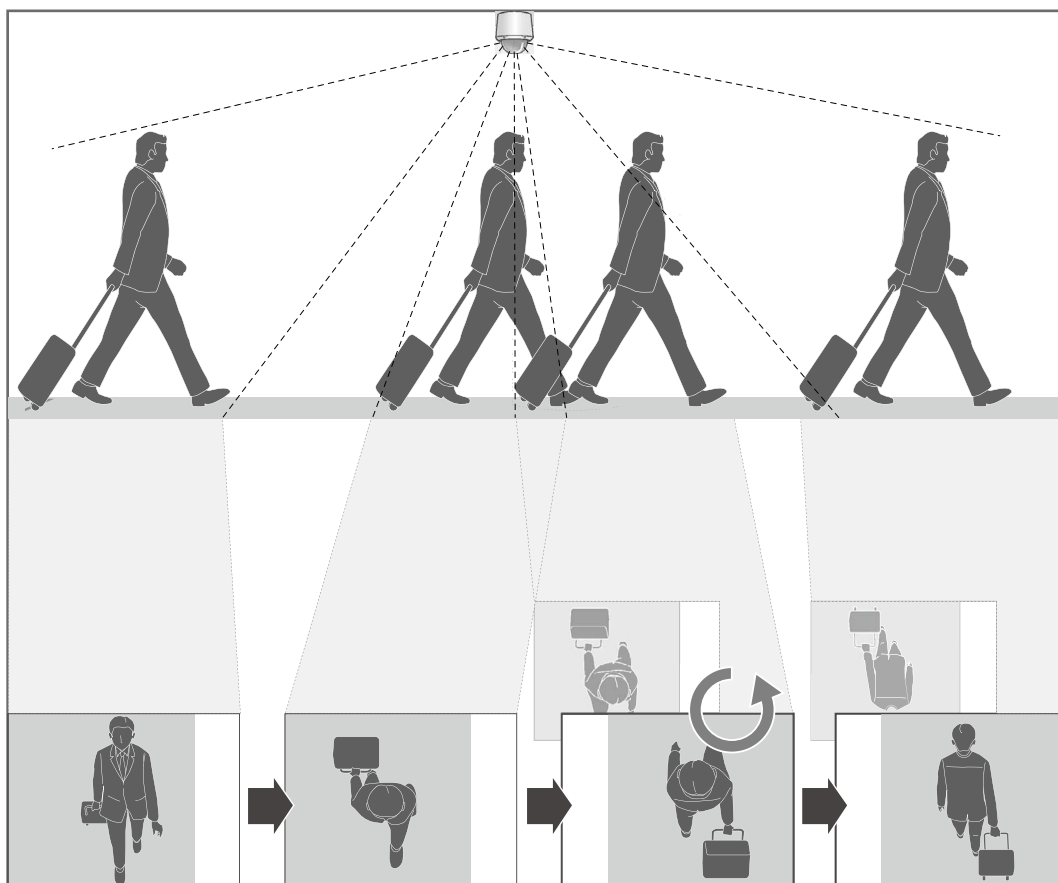

Day/Night (When Auto Is Set)

Set conditions for switching Day Mode and Night Mode when [Initial Settings] > [Day/Night] (P. 81) is set to [Auto].

Day/Night (when Auto is set)	
Switching Brightness	Standard
Response (sec.)	20

[Switching Brightness]

Select the brightness for switching Day/Night Mode when [Day/Night] is set to [Auto].
 Select [Darker] if you want to capture video in color as much as possible.
 Select [Brighter] to reduce noise. Note that this mode switches to monochrome sooner.

[Response (sec.)]

Select the number of seconds for determining when to switch Day/Night Mode, when [Day/Night] is set to [Auto]. Day/Night Mode switches when the brightness continues to exceed or fall below the brightness set in [Switching Brightness] within any of the settings for the number of seconds selected.
 Select [30] or [60] if brightness changes frequently, such as when a light source passes in front of the camera. Select [5] or [10] if change in brightness is minimal.

Installation Conditions

Configure settings for camera use suitable for the location the camera will be installed.

Installation Conditions	
LED Setting	Turn On
Image Flip	Disable

[LED Setting] **M741** **M740**

Select whether to enable or disable the camera operation status LED.
The LED will light for several seconds when starting the camera even if set to [Turn Off].

[Image Flip]

Select whether or not to vertically flip the video.
Select the setting suited to the camera installation method, such as ceiling mounting or placing on a desk.

Camera Position Control

Settings for camera use when there are no camera control restrictions for users or requests for camera control privileges.

Camera Position Control	
Restricted to Presets	No Restriction
Camera Position without Control	Do not return to Home Position

[Restricted to Presets] **R11** **R10**

Restricts camera control of the camera angle, such as with VB Viewer, to presets, including the home position, for users other than administrators.

[Camera Position without Control]

Select the camera operation when there are no users with camera control privileges.
If [Return to Home Position] has been selected, the home position of the camera must be set in advance with [Control for Admin] > [Preset/Initial Setting] > [Preset Setting] > [Preset Registration] tab (P. 170).

External Input Device 1, 2 **R11** **M641** **M741**

Enter each device name in order to identify the corresponding external input device being connected.
There are 2 external input device terminals on the camera.

External Input Device 1	
Device Name (alphanumeric characters) <small>Up to 15 characters</small>	

[Device Name]

Enter the name of the device connected to the external input device terminal. Be sure to enter a name in [Device Name (alphanumeric characters)].

External Output Device 1, 2 **R11** **M641** **M741**

Enter each device name in order to identify the corresponding external output device being connected.
There are 2 external output device terminals on the camera.

External Output Device 1	
Device Name (alphanumeric characters) <small>Up to 15 characters</small>	

[Device Name]

Enter the name of the device connected to the external output device terminal. Be sure to enter a name in [Device Name (alphanumeric characters)].

Set Initial Video Settings [Camera] > [Initial Setting]

Sets initial settings, such as video quality compensation, at camera start up.

Initial Setting

If the current camera settings and saved initial camera settings differ when you access [Initial Setting], [Apply] in the upper right of the screen will appear blue. If you click [Apply], the current camera settings will be saved as the initial camera settings. Clicking [Clear] will revert to the initial camera settings saved in the camera.

In addition, if you click [Preset/Initial Setting] > [Initial Setting Registration] (P. 159) in Control for Admin, the settings at that point will applied here as initial camera settings.

Initial Setting	
🔍 Pan/Tilt/Zoom position	Register
🔍 Focus	Auto
🔍 Exposure	Auto
🔍 Slow Shutter	Disable
🔍 Exposure Compensation	0
🔍 Metering Mode	Center-Weighted
🔍 Smart Shade Control	Manual
🔍 Smart Shade Control Level	1 (Mild)
🔍 White Balance	Auto
🔍 Noise Reduction	Standard
🔍 Sharpness	3
🔍 Color Saturation	4
🔍 Haze Compensation	Disable
🔍 Day/Night	Day Mode

M741	
🔍 Use Infrared	Day/Night Operation
🔍 Infrared Level	1 (Low)

(1) Video Display Area

This displays a preview of how video will appear due to changes made in each item.

The video display area is used for confirmation. To actually apply the changes as initial camera settings, it is necessary to click [Apply] and save the settings.

Note

If another Viewer with administrator privileges, such as the Admin Viewer, connects to the camera, video from the camera will cease and a globe icon will appear in the video display area.

(2) Use the pan, tilt and zoom sliders. **R11 R10**

Drag the sliders to pan (horizontally), tilt (vertically) or zoom in (telephoto)/zoom out (wide-angle) the camera.

To register the adjusted pan, tilt, and zoom positions as the initial camera angle settings, set [Pan/Tilt/Zoom Position] to [Register] and click [Apply].

(3) [Snapshot] Button

Open the snapshot panel and display a still image of the moment you clicked the button (P. 186).

(4) [Reconnect] Button

Reconnects to the camera.

[Pan/Tilt/Zoom Position]

Choose if you would like to register the present pan, tilt, and zoom positions. If you select [Unregister], the camera will return to the pan, tilt, and zoom positions when the camera was turned off, when restarted.

[Focus]

Selects the focus.

For details, please refer to "Focus" in "Use Control for Admin" (P. 161).

[Exposure]

Selects an exposure.

For details, please refer to "Exposure" in "Use Control for Admin" (P. 162).

[Slow Shutter]

When [Auto] is selected for [Exposure], you can select the slowest shutter speed.

For details, please refer to "Exposure" in "Use Control for Admin" (P. 162).

[Exposure Compensation]

Selects an exposure compensation value.

For details, please refer to "Exposure" in "Use Control for Admin" (P. 162).



Important

The setting is not available if [Smart Shade Control] is set to [Auto].

[Metering Mode]

Selects a metering mode.

For details, please refer to "Exposure" in "Use Control for Admin" (P. 162).

Exposure	Manual
Shutter Speed	1/30
Aperture	
Gain	

[Shutter Speed]

When [Manual] or [Auto (Shutter-priority AE)] is selected for [Exposure], you can select the shutter speed.

For details, please refer to "Exposure" in "Use Control for Admin" (P. 162).

[Aperture], [Gain]

These can be set when [Exposure] is [Manual].

For details, please refer to "Exposure" in "Use Control for Admin" (P. 162).

[Smart Shade Control], [Smart Shade Control Level]

If the background is bright and the subject is hard to see, this function brightens dark areas without affecting bright areas to make the subject easier to see.

For details, please refer to "Smart Shade Control" in "Use Control for Admin" (P. 159).

 **Important**

- [Auto] cannot be selected for [Smart Shade Control] if [Exposure] is set to [Manual].
- [Smart Shade Control] is not available if [Haze Compensation] is set to [Auto] or [Manual].

[White Balance]

Select the white balance according to the light source to achieve natural color in the video.
For details, please refer to “White Balance” in “Use Control for Admin” (P. 164).

[Noise Reduction]

Select a noise reduction level.

For details, please refer to “Image Quality Adjustment” in “Use Control for Admin” (P. 168).

[Sharpness]

Select a sharpness level.

For details, please refer to “Image Quality Adjustment” in “Use Control for Admin” (P. 168).

[Color Saturation]

Select a color saturation level.

For details, please refer to “Image Quality Adjustment” in “Use Control for Admin” (P. 168).

[Haze Compensation], [Haze Compensation Level]

If the subject is obscured by haze, this adjusts contrast in the video to improve subject visibility.

For details, please refer to “Haze Compensation” in “Use Control for Admin” (P. 160).

 **Important**

Haze Compensation cannot be used if [Smart Shade Control] is set to [Auto] or [Manual].

[Day/Night]

Select a capture mode suited to the brightness of the subject.

For details, please refer to “Day/Night” in “Use Control for Admin” (P. 165).

[Use Infrared], [Infrared Level] M741

Select whether or not to use the [Day/Night] linked infrared illumination.

For details, please refer to “Infrared” in “Use Control for Admin” (P. 167).

 **Important**

[Infrared Level] can only be set when [Exposure] is [Manual].

Reduce Data Size by Lowering Video Quality in Specific Areas

[Video and Audio] > [ADSR]

Reduces the size of transmitted H.264 video by reducing the video quality of non-target areas, such as ceilings and the sky. ADSR is an abbreviation for Area-specific Data Size Reduction.

Important

- This function can be used if [Bit Rate Control] is set to [Do not use bit rate control] in [Video Settings] > [H.264(1)] or [H.264(2)].
- Some image scenes and settings for selected areas may not be able to reduce data size using ADSR. Please test the ADSR feature in the environment, before use.

Note

- The quality of the specified area is determined by [Video Settings] > [H.264(1)] or [H.264(2)].

R11 R10

- Even if the camera is panned, tilted, or zoomed, the specified area follows the movement of the camera.
- Specified areas can only be configured within view restrictions.

Specified Area

Specify the area where video quality is not lowered.

You can specify up to eight areas with different colored frames.

Important

- You may have to reconfigure the specified areas if you change the [Camera] > [Image Flip] setting.
- Reconfigure the specified area if you change the [Video Settings] > [All Videos] > [Video Size Set] settings.

R11 R10

- Configure the specified area to a slightly larger size.
- Specified areas may deviate slightly from the specified position depending on the zoom position.
- The selected area can only be set within the optical zoom range, and cannot be set using the digital zoom range (P. 148).

Note

If another Viewer with administrator privileges, such as the Admin Viewer, connects to the camera, a globe icon will appear in the video display area and you will not be able to configure a specified area.

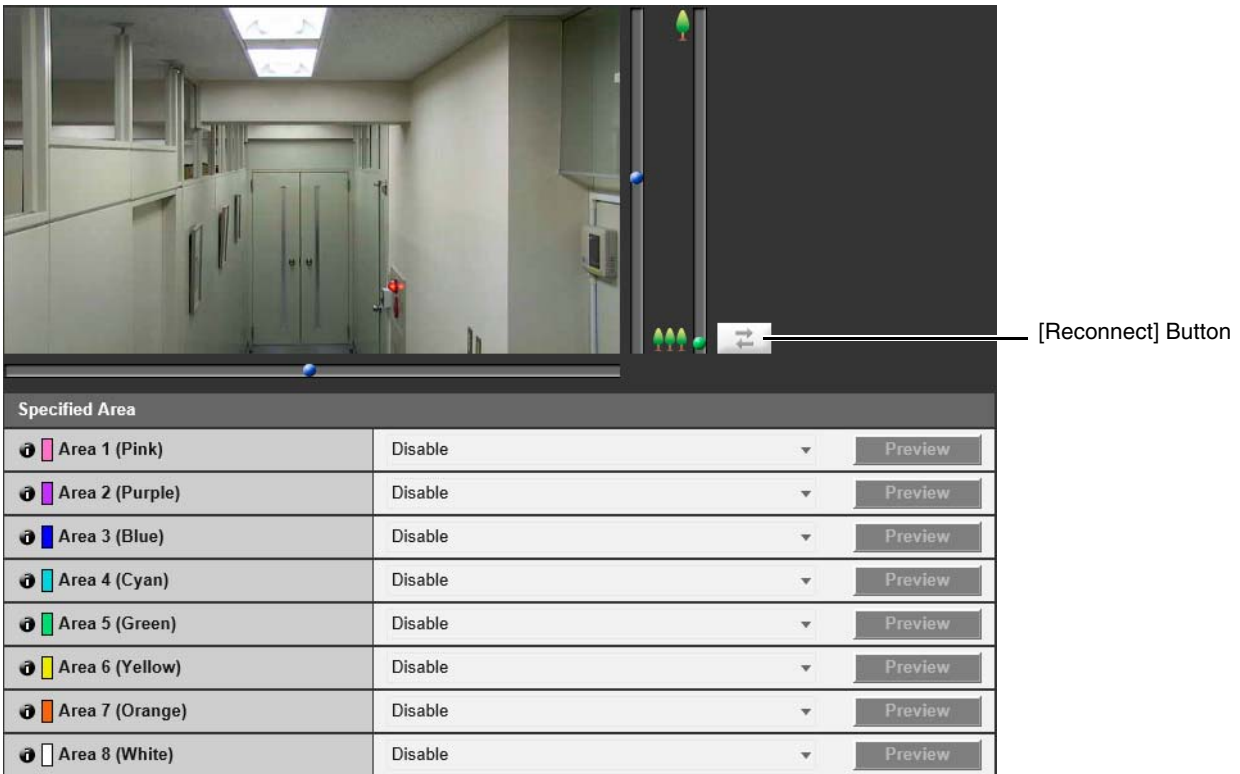

If you select [Enable] for the area with the frame color you would like to use for the specified area, the frame will appear on the Viewer.

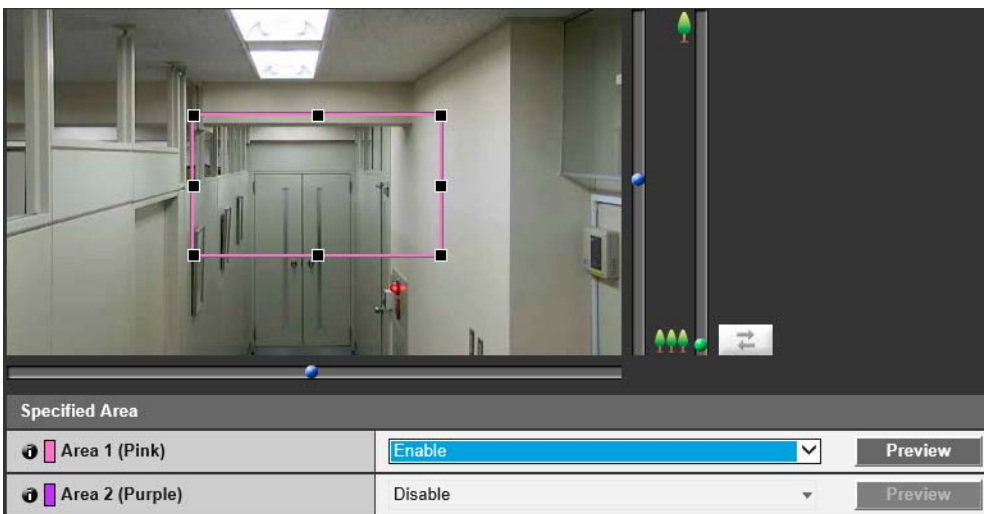

Set the specified area as follows with the display area.

- Drag out a frame and move it to the area you want to specify.
- Change the size of the frame by dragging any of the 8 handles (■).
- If you want to change the camera angle, use the pan/tilt/zoom sliders. **R11 R10**

[Preview] **R11 R10**

The camera will move to a specified area if you click [Preview] for that area.

Note

You can use Admin Viewer to check video with ADSR settings applied. Video outside the specified area will deteriorate according to the amount of applied data reduction.

ADSR

Set whether H.264(1) and H.264(2) will each lower video quality outside areas set with [Specified Area].

ADSR	
 Enable in H.264(1)	Disable ▾
 Enable in H.264(2)	Disable ▾

[Enable in H.264(1)]

Select [Enable] to lower video quality outside areas set with [Specified Area] in H.264(1) video.



Important

If you use [ADSR] with [H.264(1)], H.264(1) video cannot be uploaded or recorded to a memory card.

[Enable in H.264(2)]

Select [Enable] to lower video quality outside areas set with [Specified Area] in H.264(2) video.

Display Date, Time and Text on the Viewer

[Video and Audio] > [On-screen display]

Displays the date and time, camera name and other UI strings on the Viewer.

Important











The on-screen time display is not suitable for usage where high reliability is required. Only use it as reference information on systems where utmost and constant reliability is required for surveillance.

Note

- Depending on video quality settings, on-screen display may become difficult to decipher. Set after confirming appearance on actual video.
- When using digital PTZ, on-screen display will not appear if the cropped video has a horizontal size of 384 pixels or less.

M641 M640 M741 M740

On-Screen Display

On-screen display	
 Date display	Enable
 Position of date display	Upper left
 Format of date display	YYYY/MM/DD
 Time display	Enable
 Position of time display	Upper left
 Text display	Display designated string
 Position of text display	Upper left
 Text string display <small>Up to 15 characters</small>	
 Color of text	White
 Background color	Black
 Color depth of text and background	Fill text and background color

[Date display]

Select whether to display the date on the Viewer.

[Position of date display]

Select position for date display on the Viewer.

[Format of date display]

Select the year, month and day display order.

[Time display]

Select whether to display the time on the Viewer.

[Position of time display]

Select position for time display on the Viewer.

[Text display]

Select the text strings to display on the Viewer.

[Display designated string]

Displays the text string entered in [Text string display] below.

[Display camera name]

Displays the camera name entered in [Camera Name (alphanumeric characters)] (P. 75).

[Position of text display]

Select position for text display on the Viewer.

[Text string display]

If [Text display] is set to [Display designated string], enter the text string to be displayed in alphanumeric characters.

[Color of text]

Select from eight colors for the text color.

[Background color]

Select from eight colors for the background color.

[Color depth of text and background]

Select a color depth combination (Filling, Transparence, Translucence) for the text and background color.

Set Audio Input/Output

[Video and Audio] > [Audio Settings]

R11 M641 M741

Settings for audio input from the microphone connected to the camera and audio output from the Viewer. The output sound clip used when an event is triggered can also be registered.

This [Audio Settings] submenu is common with the [Audio Settings] submenu found in the [Event] menu.





Settings configured in any page will be reflected in the other pages.

Important

- Video and audio can be distributed to up to 30 clients. However, when there are many clients or they are connected to the camera over an SSL connection, the video frame rate may slow down and the sound may drop out if audio reception from the camera is enabled.
- The video and audio may not be synchronized.
- If the [Input Volume] or [Echo Canceller] setting is changed after setting volume detection (P. 107) or scream detection (P. 108), check the detection setting again.
- The audio may be temporarily interrupted, depending on the performance of the computer and the network environment.
- The audio may be interrupted if anti-virus software is enabled.
- Communication may be temporarily interrupted, cutting off the audio, if the LAN cable is unplugged and plugged in again. If this occurs, reconnect from the Viewer.
- The volume, sound quality, etc., may change depending on the characteristics of the microphone used.
- Use a speaker with an amplifier to connect to the camera ("Installation Guide" > "Audio Input/Output Terminals").

General Sound

Set the audio input/output volume, echo cancellation and microphone type.

General Sound	
 Input Volume 1 - 100	50
 Output Volume 1 - 100	50
 Echo Canceller	Disable ▾
 Audio Input	Line In ▾

[Input Volume]

Enter the input volume from the microphone connected to the camera.

This can be set when [Server] > [Audio Server] > [Audio Transmission from the Camera] (P. 92) is set to [Enable].

[Output Volume]

Enter the output volume from the Viewer to the speaker connected to the camera.

This can be set when [Server] > [Audio Server] > [Audio Reception from Viewer] (P. 92) is set to [Enable].

[Echo Canceller]

Select to enable or disable the Echo Canceller for suppressing echoes that occur between the microphone and speaker.

This can be set when [Server] > [Audio Server] (P. 92) is set to the following.

- [Audio Transmission from the Camera] is set to [Enable]
- [Audio Reception from Viewer] is set to [Enable]

Important

Use of the Echo Canceller may affect audio quality and volume. Use it when necessary to suit the installation environment and camera usage.

[Audio Input]

Select the type of microphone connected to the camera.

Caution

If using a microphone, switch [Line In] and [Microphone In] (P. 87) with [Audio Input] to suit the specifications of the microphone.

Using the wrong input may damage the camera and/or microphone. Be sure to configure settings correctly.

Sound Clip Upload 1 to 3

You can upload up to three sound clips for playback when an event is triggered.

Note

The sound clip is used when audio playback is set in [Event] > [External Device Input] (P. 104) or [Intelligent Function Setting Tool] > [Event] tab (P. 228).

Sound Clip Upload 1	
Browse File	<input type="text"/> <input type="button" value="Browse..."/> <input type="button" value="Add"/>
Sound Clip Name <small>Up to 15 characters</small>	<input type="text"/> <input type="button" value="Delete"/>

[Browse File]

Specify the sound clip to upload and click [Add].

To be able to upload a sound clip, it must satisfy the following requirements.

- Playback length: Less than 20 seconds.
- File Format: ".wav" (μ-law PCM 8bit. Sampling frequency 8000 Hz, monaural)

A sample sound clip is included on the Setup CD-ROM in the SOUND folder.

[Sound Clip Name]

Enter the name of the sound clip to upload.

Be sure to enter the sound clip name. If it is blank when you click the [Apply] button, the sound clip will be deleted.

To delete an uploaded sound clip, click [Delete] next to the name of the sound clip.

HTTP, SNMP and FTP Server Settings

[Server] > [Server Settings]







Settings for HTTP server, SNMP server, FTP server usage or WS-Security time checks.

HTTP Server

Set the authentication method and HTTP port number.

Important

If the setting of [HTTP Port] or [HTTPS Port] is changed and the camera may become inaccessible from the active web browser, a confirmation dialog box will appear. Click [OK] to apply the new setting.
If you reboot the camera and cannot connect to the camera from the web browser, any available URI for connecting to the camera will be displayed in a message.
If you cannot connect to the camera through the displayed URI, contact your system administrator.

HTTP Server	
 Authentication Method	Digest Authentication  
 HTTP Port 80, 1024 - 65535	80 
 HTTPS Port 443, 1024 - 65535	443 

[Authentication Method]

Select an authentication method for use by the HTTP server.

[HTTP Port]

Enter an HTTP port number.

Normally use [80] (factory default setting).

[HTTPS Port]

Enter an HTTPS port number.







Normally use [443] (factory default setting).

SNMP Server

Configure the necessary settings to use SNMP.

Note

- The camera information referenced from the SNMP manager is read-only.
- Use an SNMP Manager that supports SNMP MIB2 (supporting RFC1213).
- Supports SNMP protocol versions v1 and v2c (v3 unsupported).

SNMP Server	
 SNMP	Enable 
 Community Name Up to 31 characters	public
 Administrator Contact Information Up to 63 characters	
 Administration Function Name Up to 31 characters	VB-R11
 Installation Location Up to 31 characters	

[SNMP]

Select this to enable or disable SNMP.

When using SNMP, the camera information can be referenced by the SNMP Manager.

[Community Name]

Enter a community name for SNMP.

It is recommended that you change the default community name from [public] to ensure system security.

[Administrator Contact Information]

Enter contact information (e-mail address, etc.) for the administrator of the camera.

Setting information can be referenced by the SNMP manager.

[Administration Function Name]

Enter the camera name used for administration.

Setting information can be referenced by the SNMP manager.

If left blank, the camera model name will be used.

[Installation Location]

Enter information regarding the installation location of this camera.

Setting information can be referenced by the SNMP manager.

FTP Server

FTP Server	
 Use FTP Server	Disable ▼

[Use FTP Server]

Select whether to use an FTP server.

 **Important**

Canon will assume no liability for any accident or damage resulting from use of FTP software.

WS-Security

WS-Security	
 Check Time on Authentication	Check ▼

[Check Time on Authentication]

Select whether to check the time information of data transmitted by the client.

Video Transmission Settings

[Server] > [Video Server]

Settings for clients that can connect to a video server.

Video Server	
Maximum Number of Clients <small>0 - 30</small>	30
Camera Control Queue Length <small>0 - 30</small>	30
Maximum Connection Time (sec.) <small>0 - 65535</small>	0
Camera Control Time (sec.) <small>1 - 3600</small>	20

[Maximum Number of Clients]

Enter the maximum number of clients that can be connected to the camera at the same time. If set to [0], only administrators will be able to connect.

Important

R11 M641 M741

When there are many clients or they are connected to the camera over an SSL connection, the video frame rate may slow down and the sound may drop out if audio reception from the camera is enabled.

[Camera Control Queue Length]

Enter the maximum queue length for clients requesting camera control privileges from the Viewer. If set to [0], only Admin Viewer and Admin Tools can queue for camera control.

[Maximum Connection Time (sec.)]

Enter the maximum time in seconds during which an individual client can connect to the camera. If set to [0], the connection time is unlimited.

[Camera Control Time (sec.)]

Enter the maximum time VB Viewer can retain camera control privileges.

Audio Transmission/Reception Settings [Server] > [Audio Server]

R11 M641 M741

Settings for audio transmission from the camera to the computer, and audio reception from the computer to the camera.

Audio Server	
Audio Transmission from the Camera	Disable
Voice Activity Detection	Disable
Audio Reception from Viewer	Disable

[Audio Transmission from the Camera]

Select to transmit audio from the microphone connected to the camera to the Viewer.

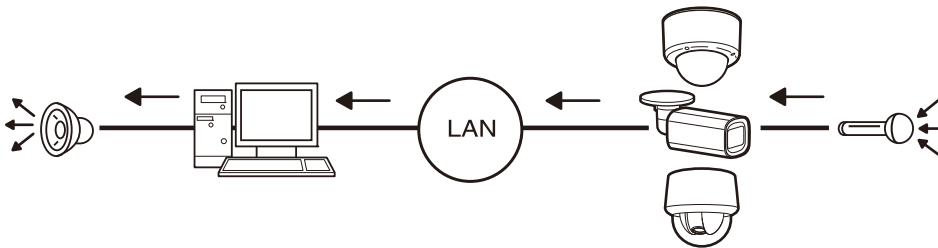

[Voice Activity Detection]

Select whether to detect when there is no sound coming from the microphone.

When set to [Enable], audio data transmission will pause while there is no sound input from the camera. This can reduce the load on the network used.

[Audio Reception from Viewer]

Select to receive audio from Admin Viewer and RM Viewer.

Received audio can be output from a speaker with an amplifier connected to the camera.

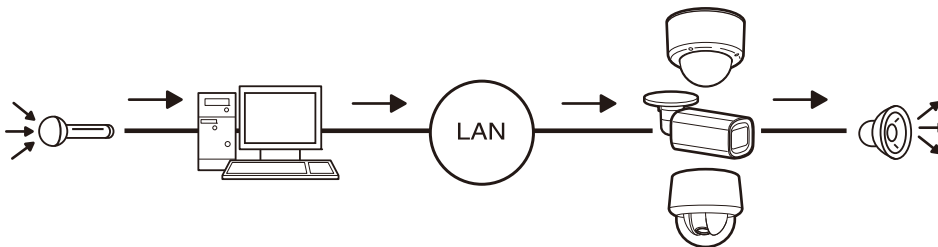

RTP Settings

[Server] > [RTP Server]

Set the video and audio transmission using RTP.

RTP Server

Enable RTP, and set the RTSP authentication method and port number.

RTP Server	
RTP	Enable
RTSP Authentication Method	Digest Authentication
RTSP Port <small>554, 1024 - 65535</small>	554

[RTP]

Select this to enable or disable RTP.

[RTSP Authentication Method]

Select an authentication method for RTSP. Since the RTSP authentication method is configured independently of the HTTP authentication method, you need to configure each authentication method.

[RTSP Port]

Enter the RTSP port number.

Normally use [554] (factory default setting).

Audio Multicast R11 M641 M741

Set multicast for audio transmission.

Audio Multicast	
Multicast Address	0.0.0.0
Multicast Port <small>0, 1024 - 65534 (even numbers only)</small>	0
Multicast TTL <small>0 - 255</small>	1

[Multicast Address]

Enter the multicast address for audio transmission as follows.

IPv4: Range from 224.0.0.0 to 239.255.255.255.

IPv6: Address starting with ff00::/8

Set IPv4 to [0.0.0.0] and IPv6 to [::0 (::)] to disable multicast.

[Multicast Port]

Enter the multicast port number for audio transmission.

If set to [0], multicast is disabled.

[Multicast TTL]

Enter the effective range for multicast transmission.

If set to [0], multicast is disabled.

The TTL (Time To Live), representing the effective range for multicast transmission, is decremented each time the signal passes through a router. When the value reaches 0, the signal can no longer pass through the router and be transmitted. For example, if TTL is set to [1], multicast transmission is confined to the local segment only and cannot pass through the router to be transmitted.

RTP Streaming 1 to 5

You can set each stream for RTP stream transmission in an RTP Streaming 1 to RTP Streaming 5 session.

RTP Streaming 1	
Video Size	320 x 180 JPEG
Frame Rate 1 - 30	5
Multicast Address	0.0.0.0
Multicast Port 0, 1024 - 65534 (even numbers only)	0
Multicast TTL 0 - 255	1
Audio Transmission	Disable

[Video Size]

Select the video format (JPEG or H.264) and video size for the RTP stream.

The video sizes for JPEG will vary depending on the [Video Size Set] settings (P. 72).

The video sizes for H.264 will be determined according to the [H.264(1)] and [H.264(2)] settings in [Video Settings] (P. 73).

In addition, [H.264(1)] and [H.264(2)] cannot be set for multiple RTP streams.

[Frame Rate]

Enter the frame rate if the RTP stream is JPEG video.

This cannot be set for H.264 video. The [Frame Rate] setting in [Video Settings] > [H.264(1)] or [H.264(2)] will be used.

[Multicast Address]

Enter the multicast address for RTP streaming as follows.

IPv4: Range from 224.0.0.0 to 239.255.255.255.

IPv6: Address starting with ff00::/8

Enter [0.0.0.0] for IPv4 and [::0(::)] for IPv6 to disable multicast.

[Multicast Port]

Enter the multicast port number for RTP streaming.

If set to [0], multicast is disabled.

[Multicast TTL]

Enter the effective range for multicast transmission of RTP streams.

If set to [0], multicast is disabled.

The TTL (Time To Live), representing the effective range for multicast transmission, is decremented each time the signal passes through a router. When the value reaches 0, the signal can no longer pass through the router and be transmitted.

For example, if TTL is set to [1], multicast transmission is confined to the local segment only and cannot pass through the router to be transmitted.

[Audio Transmission] **R11** **M641** **M741**

Select whether to use audio transmission for RTP streaming.

Note

- RTP Streaming URL
rtsp://Address:Port Number/rtpstream/config1(to 5)=r|u|m
[=r|u|m] is optional and can be omitted. If specified, specify only one option.
r: Requests RTP over TCP
u: Requests RTP over UDP
m: Requests multicast
Example: RTP Streaming 1 request using RTP over TCP
rtsp://192.168.100.1:554/rtpstream/config1=r
Caution: Note that the actual operation is dependent on the RTP client application, so the URL does not necessarily specify the method used for transmission.
- When H.264 is selected, bit rate control and video quality are each set with [Video Settings] (P. 73).
- The [Video Distribution] and [Audio Distribution] settings in [Security] > [User Restrictions] > [User Authority] are not used for RTP.
- RTP streaming video may not be viewable on systems using a proxy server or firewall. If this occurs, contact your system administrator.
- If Host Access Restrictions are applied to a client while it is streaming using RTP over UDP, it may take from a few to tens of seconds until streaming ceases.

R11 M641 M741

- Regardless of the [Server] > [Audio Server] > [Audio Transmission from the Camera] setting, RTP streaming audio will be used. However, to use audio settings, select [Enable] for [Audio Transmission from the Camera] and configure the settings.

HTTP and FTP Upload Settings

[Video Record] > [Upload]

Settings for uploading video via HTTP or FTP when an event is triggered.

Use [Server] > [Server Settings] (P. 89) to configure HTTP server and FTP server settings for uploading.

Important

- The following settings are necessary to use the upload function or recording to the memory card.
 - [Video Record] settings configured with [Timer] in the [Event] menu.
 - [Video Record] settings configured with each of the [Event] menus ([External Device], [Audio Detection] and [Linked Events]).
R11 M641 M741
 - The setting in the [Event] tab of the Intelligent Function Setting Tool (P. 227).
- When using the upload function, or recording to the memory card, do not change the settings in the [Setting Page]. Doing so may result in the upload function or the recording to memory card to stop.
- If you are using HTTP or FTP upload, and e-mail notification by text and video, set [Video Settings] > [JPEG] > [Video Size: Upload / Memory card] (P. 73) to a small size.
- HTTP upload does not support SSL/TLS.
- If the camera is set to upload or send e-mail notification continuously, not all video or e-mails may be sent depending on the video size and the network condition to the server. If this occurs, a message is written to the log (P. 134).
- If the destination for HTTP or FTP upload, or e-mail notification is set for a Windows operating system, IPsec communication is not supported.

Video Record Setting

When an event is triggered, sets whether to upload camera video with HTTP or FTP or to record the video to a memory card. These can also be set with the [Memory Card] submenu (P. 101) and will be reflected in [Video Record Setting] here.





Video Record Setting	
 Video Record Action	Upload ▼





[Video Record Action]

Select [Upload] to upload video.

General Upload

Sets the upload method and video format for upload.

General Upload	
 Upload	HTTP Upload ▼
 Video Format	JPEG ▼
 Frame Rate <small>1 - 10</small>	1
 Pre-event Buffer (number of frames) <small>0 - 100</small>	0
 Post-event Buffer (number of frames) <small>0 - 100</small>	0

General Upload	
 Upload	FTP Upload ▼
 Video Format	H.264(1) ▼
 Pre-event Buffer (sec) <small>0 - 5</small>	0
 Post-event Buffer (sec) <small>0 - 20</small>	0

[Upload]

Select whether to upload with HTTP or FTP.

[Video Format]

Select the video format for upload. [H.264(2)] cannot be used.

Video size and quality of the uploaded video follow the settings in [Video Settings] (P. 72).

Important

For H.264(1), the following settings must be configured in [Video Settings] > [H.264(1)] (P. 73).

- [Bit Rate Control]: [Use bit rate control]
- [Target Bit Rate (kbps)]: [3072] or less
- [I Frame Interval (sec)]: [0.5], [1] or [1.5]

[Frame Rate]

Enter the maximum frame rate of video to be uploaded when [Video Format] is set to [JPEG].

[Pre-event Buffer (number of frames)] (JPEG)/ [Pre-event Buffer (sec)] (H.264(1))

Enter the number of frames or seconds of video to be buffered before the event.

Enter the maximum number of frames for [JPEG] or the maximum number of seconds for [H.264(1)] in [Video Format].

[Post-event Buffer (number of frames)] (JPEG)/ [Post-event Buffer (sec)] (H.264(1))

Enter the number of frames or seconds of video to be buffered after the event.

Enter the maximum number of frames for [JPEG] or the maximum number of seconds for [H.264(1)] in [Video Format].

Important

The maximum video buffer size capacity is approx. 5 MB. If a large video size is set, the Frame Rate, Pre-event Buffer and Post-event Buffer may not be achieved as specified.

If buffering cannot be achieved as specified, a message is written to the log (P. 134). Confirm that no messages appear in the log.

Note

If the server or network load increases due to the upload settings, the video frame rate may drop. If this occurs, reconfigure the following settings to reduce the size and frequency of uploaded data.

- Set a lower value for [Video Size: Upload / Memory card] for [JPEG] (P. 73).
- Reduce the number of frames or seconds in [Pre-event Buffer] or [Post-event Buffer] (P. 97).
- If [Volume Detection Event] is enabled, disable [ON Event Operation], [OFF Event Operation] or [Ongoing ON Event Operation] (P. 107).
R11 M641 M741
- From the Intelligent Function Setting Tool [Event] tab, disable [ON Event Operation], [OFF Event Operation] or [Detected mode Operation] (P. 227).
- If [External Device Input Event] is enabled, disable [Active Event Operation], [Inactive Event Operation] or [Ongoing Active Event Operation] (P. 105). R11 M641 M741
- If [Timer Event] is enabled, increase the value in [Repeat Interval] (P. 110).

HTTP Upload

Settings for the HTTP upload function when [Upload] is set to [HTTP Upload].

The HTTP upload function sends notifications via HTTP or via HTTP with attached videos, depending on the network camera event.

For information about the HTTP upload function and settings, contact your nearest Canon Customer Service Center.

HTTP Upload	
Notification	Notification Only with HTTP
URI Up to 255 characters	http://192.168.100.67
User Name Up to 31 characters	
Password Up to 31 characters	*****
Proxy Server Up to 63 characters	
Proxy Port 1 - 65535	80
Proxy User Name Up to 31 characters	
Proxy Password Up to 31 characters	*****
Parameter (query string) Up to 127 characters	
HTTP Upload Test	Exec

[Notification]

Select whether to only send event information notifications or notifications with attached videos when using HTTP upload.

[URI]

Enter the HTTP server URI to which to upload.

[User Name], [Password]

Enter the user name and password required for authentication.

Digest authentication is not supported.

[Proxy Server]

If using a proxy server, enter the host name or IP address of the proxy server.

[Proxy Port]

If using a proxy server, enter the port number of the proxy server.

[Proxy User Name], [Proxy Password]

Enter to use a user name and password for the proxy server.

Digest authentication is not supported.

[Parameter (query string)]

Enter the request parameters.

Parameters can be specified using the “%” character (P. 252).

[HTTP Upload Test]

Clicking [Exec] initiates an upload test based on the settings currently entered.

Only a single JPEG will be uploaded, but it is not necessary to click [Apply] at that time. After entering a password, first click [Exec], then click [Apply].



Important

Enter [Proxy Server], [Proxy Port], [Proxy User Name] and [Proxy Password] if connecting via a proxy server.

FTP Upload

Settings for the FTP upload function when [Upload] is set to [FTP Upload].

FTP Upload	
Notification	Video data upload with FTP
FTP Server <small>Up to 63 characters</small>	192.168.100.67
User Name <small>Up to 31 characters</small>	ftp
Password <small>Up to 63 characters</small>	*****
PASV Mode	Enable
File Upload Path <small>Up to 255 characters</small>	
File Naming	YYMMDDHHMMSSms
FTP Upload Test	<input type="button" value="Exec"/>

[Notification]

This is set to [Video data upload with FTP].

[FTP Server]

Enter the host name or IP address of FTP server.

[User Name], [Password]

Enter the user name and password required for authentication.

[PASV Mode]

Select whether to use PASV mode when connecting to an FTP server.

[File Upload Path]

Enter a remote path (directory name) for video files to be uploaded to.

[File Naming]

Select a first naming rule for the upload file.

[YYYYMMDDHHMMSSms]

Video is uploaded according to the file name format of “{year}{month}{day}{hour}{minute}{second}{ms}.jpg”.
(Example: 20140123112122000.jpg)

[YYYYMMDD Directory/HHMMSSms]

A subdirectory named “{year}{month}{day}” is created first, and then the video is uploaded using the file name “{hour}{minute}{second}{ms}.jpg”.
(Example: 20140123/112122000.jpg)

File Naming	Loop
Maximum Number of Loops <small>0 - 9999</small>	0

[Loop]

Video is loaded with a file name numbered in sequence from 0000 up to the value set in [Maximum Number of Loops].
(Example: 0000.jpg, 0001.jpg) The number will return to 0000 when the maximum number of loops is reached.
Since the way FTP servers manage the upload of files with existing file names differs as follows, be sure to check the FTP server specifications before configuring this setting.

- Overwrite the existing file name
- Automatically save the file with a different name
- Generate an error

[Maximum Number of Loops]

If [Loop] is set under [File Naming], enter the maximum number of loops.

File Naming	User Setting
Subdirectory Name to Create <small>Up to 127 characters</small>	
File Name to Create <small>Up to 127 characters</small>	image.jpg

[User Setting]

Video is uploaded according to the file naming method specified in [Subdirectory Name to Create] and [File Name to Create].

[Subdirectory Name to Create], [File Name to Create]

If file naming is set to [User Setting], enter the subdirectory name to be created as well as the name of the created file. Parameters can be specified in the entry with the “%” character (P. 252).

[FTP Upload Test]

Clicking [Exec] initiates an upload test based on the settings currently entered.

Only a single JPEG will be uploaded, but it is not necessary to click [Apply] at that time. After entering a password, first click [Exec], then click [Apply].

Settings for Recording Video to a Memory Card

[Video Record] > [Memory Card]

Settings for recording video to a memory card when an event is triggered.

[Memory Card Operations] and [Memory Card Information] on this page are common with [Memory Card] (P. 130). Settings configured in any page will be reflected in the other pages.

Video Record Setting

Sets whether to record video from the camera to a memory card or upload it with HTTP or FTP.

These can also be set with the [Upload] submenu (P. 96) and will be reflected in [Video Record Setting] here.

Video Record Setting	
i Video Record Action	Record to Memory Card

[Video Record Action]

Select [Record to Memory Card] to record to a memory card.

Memory Card Operations

For details on settings, please refer to (P. 130).

Memory Card Information

For details on settings, please refer to (P. 132).

Set E-mail Notification

[Video Record] > [E-mail Notification]

Settings for sending an e-mail notification to a specified recipient when an event is triggered.

E-mail Notification

Set the mail server to be used for e-mail notifications and the content of the e-mail to be sent.

E-mail Notification	
Notification	Text Only
Mail Server Name Up to 63 characters	
Mail Server Port 1 - 65535	25
Sender (From) Up to 63 characters	
Recipient (To) Up to 63 characters	
Authentication	None
Subject Up to 31 characters	
Message Body Up to 255 characters	
E-mail Notification Test	Exec

[Notification]

[Subject] and [Body] are text.

If you set [Text with Image], an image (JPEG format) captured immediately before the event will be attached.

[Mail Server Name]

Enter the host name or IP address of the SMTP server.

[Mail Server Port]

Enter the port number for the SMTP server.

[Sender (From)]

Enter the e-mail address of the sender.

[Recipient (To)]

Enter the e-mail address of the recipient.

[Authentication]

Select an authentication method suited to the destination SMTP server.

Authentication	POP before SMTP
User Name Up to 31 characters	username
Password Up to 31 characters	*****
POP Server Up to 63 characters	servername

[User Name], [Password], [POP Server]

Enter the user name and password needed for authentication, and the POP server host name or IP address when e-mail authentication is set to [POP before SMTP].

Authentication	SMTP-AUTH
User Name Up to 31 characters	username
Password Up to 31 characters	*****

[User Name], [Password]

Enter the user name and password needed for authentication when e-mail authentication is set to [SMTP-AUTH].

[Subject]

Enter the subject of the e-mail in alphanumeric characters.

[Message Body]

Enter the message body (text) of the e-mail in alphanumeric characters.
Parameters can be specified in the text using the “%” character (P. 252).

[E-mail Notification Test]

Clicking [Exec] initiates an e-mail notification test based on the settings currently entered.
It is not necessary to click [Apply]. After entering a password, first click [Exec], then click [Apply].

External Device Input Triggered Operation Settings

[Event] > [External Device]

R11 M641 M741

Operation settings for external device output and for external device input triggered events.

External Device Output 1, 2

Set the operation for output to the external device.

The camera has two external device outputs. You can set the output for each of them.

Note

The output for an external device can be switched between active and inactive with [Control for Admin] > [External Device Output] (P. 167).

External Device Output 1	
Operation Mode	Normally Open
Active Output Format	Continuous
Pulse Output Time (sec) 1 - 120	1

[Operation Mode]

Select whether the output terminals are normally open or closed.

When [Normally Open] is set, the output terminals remain in the open state (non-conducting circuit) during normal operation, and the terminals close upon an active event and open upon an inactive event.

When [Normally Close] is selected, the output terminals remain in the closed state (conducting circuit) during normal operation, and the terminals open upon an active event and close upon an inactive event.

Normally Open

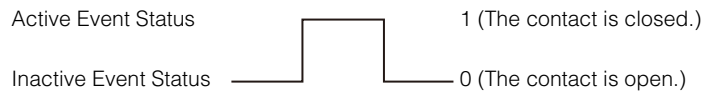

Normally Close

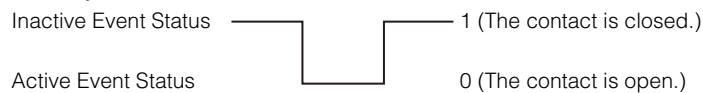

[Active Output Format]

Select the output format when the external device output is active.

[Pulse Output Time (sec)]

Enter the output duration time (sec.) when [Active Output Format] is set to [Pulse].

Important

When [Active Output Format] is set to [Pulse] and a timer is used (P. 110), a single contact output is controlled when the timer starts.

External Device Input

External Device Input	
External Device Input Event	Enable

[External Device Input Event]

Select whether to use the input from an external device, such as a connected sensor, as an event.

External Device Input 1, 2

Set the operation to be performed when an event is triggered by input from an external device. The camera has two external device inputs. You can set the input for each of them. You can set these if you have selected [Enable] in [External Device Input Event].

Note

An icon in the Admin Viewer Event Display panel will indicate when there is an external device input event (P. 184).

External Device Input 1	
Operation Mode	Normally Open
Active Event Operation	Enable
Inactive Event Operation	Disable
Ongoing Active Event Operation	Disable
Preset	None
Video Record	Disable
E-mail Notification	Disable
External Device Output for Active Event	Disable
External Device Output for Inactive Event	Disable
Audio Playback at Active Event	Enable
Audio Playback at Inactive Event	Disable
Sound Clip	SAMPLE_1
Volume 1 - 100	50
Switch Day/Night	Disable

[Operation Mode]

Select the circuit condition to suit the signal input from the connected external device.

When [Normally Open] is set, an active event occurs when the terminals of the external device close, and an inactive event occurs when the terminals open.

When [Normally Close] is set, an active event occurs when the terminals of the external device open, and an inactive event occurs when the terminals close.

[Active Event Operation]

Select the operation to be performed when an active event is triggered.

If [Enable] is set, [Preset], [Video Record] and [E-mail Notification] will be executed according to their settings when an active event is triggered.

[Inactive Event Operation]

Select the operation to be performed when an inactive event is triggered.

If [Enable] is set, [Preset], [Video Record] and [E-mail Notification] will be executed according to their settings when an inactive event is completed.

[Ongoing Active Event Operation]

Select the operation to be performed during an active event. This can only be set when [Active Event Operation] is set to [Enable].

If [Enable] is selected, [Video Record] and [E-mail Notification] will be executed according to their settings during the active event.

[Preset] R11

If you specify a preset, the camera angle will automatically move to the preset location when an external device input event is triggered.

It is necessary to set presets beforehand with [Control for Admin] > [Preset/Initial Setting] > [Preset Setting] (P. 170).

Important

When the user has camera control privileges, those camera control privileges are released if the camera is moved to a preset position specified in the [Preset] settings.

[Video Record]

Select whether to record video depending on the event.

If you select [Enable] and an external device input event is triggered, video will be transmitted to the recording destination specified in [Video Record Action] (P. 96).

[E-mail Notification]

Select whether to send an e-mail notification depending on the event.

If [Enable] is selected, e-mail notification will be performed when an external device input event is triggered.

To use e-mail notification, you must set [Video Record] > [E-mail Notification] (P. 102) beforehand.

[External Device Output for Active Event]

Select whether external device output (1 or 2) is active or inactive when an active event is triggered.

[External Device Output for Inactive Event]

Select whether external device output (1 or 2) is active or inactive when an inactive event is triggered.

[Audio Playback at Active Event]

If you select [Enable], the sound clip specified in [Sound Clip] will play back at active events for the external device input.

[Audio Playback at Inactive Event]

If you select [Enable], the sound clip specified in [Sound Clip] will play back at inactive events for the external device input.

[Sound Clip]

Select the sound clip when [Audio Playback at Active Event] or [Audio Playback at Inactive Event] has been set to [Enable].

You must register the sound clip with [Video and Audio] > [Audio Settings] (P. 88) beforehand.

[Volume]

Enter the volume for the sound clip.

[Switch Day/Night]

Select the Day/Night Mode switching behavior when an external device input event is triggered.

When [Switch to Day Mode] is set, switches to Day Mode when an active event is triggered, and switches to Night Mode when an inactive event is triggered.

When [Switch to Night Mode] is set, switches to Night Mode when an active event is triggered, and switches to Day Mode when an inactive event is triggered.



Important

- When [Day/Night] in the Admin Viewer is set to [Auto] (P. 165), [Switch Day/Night] will not happen when an external device input event is triggered.
- If the [Switch Day/Night] settings switch Day/Night Mode while the user has camera control privileges, camera control will be released.

Abnormal Audio Input Triggered Operation Settings

[Event] > [Audio Detection]

R11 M641 M741

Audio input from the microphone connected to the camera, such as loud noises or screams, or when expected audio input ceases, can trigger operations such as video recording or e-mail notification.

Important

For notes on use of volume detection, please refer to "Precautions for Built-In Camera Functions and Included Software" (P. 9) in "Safety Precautions".

Note

You can check the audio detection status on the Admin Viewer Event Display panel (P. 185).

Volume Detection

An audio detection event will be triggered when audio input volume is detected exceeding or falling below the reference volume setting.

Set the conditions for triggering a volume detection event and the operations to perform according to an event.

Important

Volume detection is temporarily disabled when an event causes the playback of a sound clip or when audio is transmitted from the Viewer.

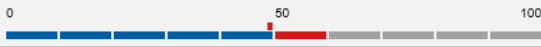
Volume Detection	
Volume Detection Event	Enable
Detect Criteria	The reference volume level or above
Reference Volume Level <small>1 - 100</small>	50
Current Volume Level	
Detect Criteria Duration (sec) <small>0 - 10</small>	0
ON Event Operation	Enable
OFF Event Operation	Disable
Ongoing ON Event Operation	Disable
Preset	None
Video Record	Disable
E-mail Notification	Disable
External Device Output for ON Event	Disable
External Device Output for OFF Event	Disable

[Volume Detection Event]

Select whether to use volume detection event.

[Detect Criteria]

Select the criteria for triggering a volume detection event.

[Reference Volume Level]

Enter the reference sound level to be used for detection.

Set the reference volume level by performing an actual test while checking [Current Volume Level] before configuring the setting.

[Current Volume Level]

The current volume level appears on the status bar.

The level set in [Reference Volume Level] is indicated by a red mark. Volume below the reference level appears in blue, that above the reference level appears in red.

[Detect Criteria Duration (sec)]

When the status meeting the volume detection criteria has continued for the duration or longer, an ON event is triggered.

[ON Event Operation]

If [Enable] is set, [Preset], [Video Record] and [E-mail Notification] will be executed according to their settings when a volume detection event (ON event) is triggered.

[OFF Event Operation]

If [Enable] is set, [Preset], [Video Record] and [E-mail Notification] will be executed according to their settings when a volume detection event (OFF event) is completed.

[Ongoing ON Event Operation]

Select the operation to be performed when an ON event is triggered. This can be set when [ON Event Operation] is set to [Enable].

If [Enable] is selected, [Video Record] and [E-mail Notification] will be executed according to their settings during the volume detection event.

[Preset] **R11**

If you specify a preset, the camera angle will automatically move to the preset location when a volume detection event is triggered.

It is necessary to set presets beforehand with [Control for Admin] > [Preset/Initial Setting] > [Preset Setting] (P. 170).



Important **R11**

When the user has camera control privileges, those camera control privileges are released if the camera is moved to a preset position specified in the [Preset] when triggered by a volume detection event.

[Video Record]

Select whether to record video depending on the volume detection event.

If you select [Enable] and a volume detection event is triggered, video will be transmitted to the recording destination specified in [Video Record Action] (P. 96).

[E-mail Notification]

Select whether to send an e-mail notification depending on the volume detection event.

If you select [Enable] and a volume detection event is triggered, an e-mail notification will be sent.

To use e-mail notification, you must set [Video Record] > [E-mail Notification] (P. 102) beforehand.

[External Device Output for ON Event]

Select whether external device output (1 or 2) is active or inactive when an ON event is triggered.

[External Device Output for OFF Event]

Select whether external device output (1 or 2) is active or inactive when an OFF event is triggered.

Scream Detection

A scream detection event is triggered when sounds from someone, such as a scream or cry, are detected.

You can also set the operations to perform depending on the scream detection event.



Important

- Scream detection detects abnormal sound in relatively quiet environments. Detection is difficult in noisy environments.
- The scream detection is not a voice recognition function.
- Detection may be difficult if an excessively loud scream is input.
- Detection may be difficult if the duration of the scream is short.
- Detection may be temporarily difficult if the same sound is input repeatedly multiple times.

Scream Detection	
Scream Detection Event	Enable
ON Event Operation	Enable
Preset	None
Video Record	Disable
E-mail Notification	Disable
External Device Output for ON Event	Disable

[Scream Detection Event]

Select whether to use scream detection event.

[ON Event Operation]

If [Enable] is set, [Preset], [Video Record] and [E-mail Notification] will be executed according to their settings when a scream detection event (ON event) is triggered.

[Preset] **R11**

If you specify a preset, the camera angle will automatically move to the preset location when a scream detection event is triggered.

It is necessary to set presets beforehand with [Control for Admin] > [Preset/Initial Setting] > [Preset Setting] (P. 170).



Important

When the user has camera control privileges, those camera control privileges are released if the camera is moved to a preset position specified in the [Preset] when triggered by a scream detection event.

[Video Record]

Select whether to record video depending on the scream detection event.

If you select [Enable] and a scream detection event is triggered, video will be transmitted to the recording destination specified in [Video Record Action] (P. 96).

[E-mail Notification]

Select whether to send an e-mail notification depending on the scream detection event.

If you select [Enable] and a scream detection event is triggered, an e-mail notification will be sent.

To use e-mail notification, you must set [Video Record] > [E-mail Notification] (P. 102) beforehand.

[External Device Output for ON Event]

Select whether external device output (1 or 2) is active or inactive when an ON event is triggered.

Timer Triggered Operation Settings

[Event] > [Timer]

The timer function can generate events that can trigger operations, such as video recording and e-mail notifications, at regular intervals.

You can set the following two types of timers.

- 24 hours continuous from specified timer
- Within specified time only











Either type can be set to trigger timer events at regular intervals.

Note

Timer events are different than [Timer] in [Control for Admin] > [Preset/Initial Setting] > [Preset Setting] > [Auto Control Settings] tab (P. 177).

Timer 1 to 4

You can register up to 4 timer events.

Timer 1	
 Timer Event	Enable <input type="text"/>
 24-Hour Continuous Setting	Disable <input type="text"/>
 Start Time <small>hh:mm</small>	00:00 <input type="text"/>
 End Time <small>hh:mm</small>	00:00 <input type="text"/>
 Repeat Interval	None <input type="text"/>
Operation	
 Start Time Preset	None <input type="text"/>
 Video Record	Disable <input type="text"/>
 E-mail Notification	Disable <input type="text"/>
 External Device Output	Disable <input type="text"/>
 Switch Day/Night	Disable <input type="text"/>

[Timer Event]

Select whether to use a timer event.

[24-Hour Continuous Setting]

When set to [Enable], the timer event will be repeated at the interval in [Repeat Interval] for 24 hours, starting from the time specified in [Start Time].

When set to [Enable], only [Video Record] operations will be performed.

[Start Time]

Enter the start time of the timer event in 24-hour format. The timer event will be triggered at the start time.

[End Time]

When [24-Hour Continuous Setting] is set to [Disable], enter the end time in 24-hour format for repeating the timer event.

The timer event will be triggered at the end time.

[Repeat Interval]

Select a repeat interval for timer events. The timer event will be triggered at the selected intervals.

Operation

Set the operations to be performed when timer events are triggered.

[Start Time Preset] **R11** **R10**

When [24-Hour Continuous Setting] is set to [Disable] and you specify a preset, the camera angle will automatically move to the preset location at the time set in [Start Time].

It is necessary to set presets beforehand with [Control for Admin] > [Preset/Initial Setting] > [Preset Setting] (P. 170).

Important

When control privileges are held by applications like Admin Viewer, and the camera angle has moved as a result of [Start Time Present], camera control is released.

[Video Record]

Select whether to record video depending on the timer event.

If you select [Enable] and a timer event is triggered, video will be transmitted to the recording destination specified in [Video Record Action] (P. 96).

[E-mail Notification]

When [24-Hour Continuous Setting] is set to [Disable], select whether to send an e-mail notification depending on the timer event.

If [Enable] is selected, e-mail notification is performed when a timer event is triggered.

To use e-mail notification, you must set [Video Record] > [E-mail Notification] (P. 102) beforehand.

[External Device Output] **R11** **M641** **M741**

When [24-Hour Continuous Setting] is set to [Disable], set whether external device output (1 or 2) is active or inactive when a timer event is triggered.

[Repeat Interval] is not supported.

[Switch Day/Night]

When [24-Hour Continuous Setting] is set to [Disable], select the Day/Night Mode switching behavior when a timer event is triggered. This can only be set with [Timer 1].

Select [Switch to Day Mode] to switch to Day Mode at the start time, and Night Mode at the end time.

Select [Switch to Night Mode] to switch to Night Mode at the start time, and Day Mode at the end time.

[Repeat Interval] is not supported.

Important

- If you set [Start Time] and [End Time] and select a preset with [Start Time Preset], the Day/Night setting in [Control for Admin] > [Preset/Initial Setting] > [Preset Setting] > [Preset Registration] tab > [Advanced Preset Settings] > [Day/Night] (P. 174) is given priority. Therefore, even if you set [Switch Day/Night] to [Switch to Day Mode] or [Switch to Night Mode], the [Switch Day/Night] setting will be disabled if the opposite setting has been configured in [Control for Admin] > [Advanced Preset Settings].
- When [Day/Night] in the Control for Admin is set to [Auto] (P. 165), [Switch Day/Night] will not happen when a timer event is triggered.
- If the [Day/Night Mode Switching] settings switch Day/Night Mode while the user has camera control privileges, camera control will be released.

Execute Presets When Switching Day/Night Mode

[Event] > [Switch Day/Night]

When events trigger the switching of Day/Night Mode, presets registered in advance can be executed, such as changing the camera angle or video quality settings.

Important

When the Admin Viewer or other camera control applications have control privileges, the presets for [Preset when Switching to Day mode] and [Preset when Switching to Night Mode] will not run.

Note

- It is necessary to set presets beforehand with [Control for Admin] > [Preset/Initial Setting] (P. 170).
- You can set the timing for event triggered Day/Night Mode switching in [Switch Day/Night] in [External Device Input] (P. 105) or [Timer] (P. 110).

Day/Night Mode Switching	
 Preset when Switching to Day Mode	None ▼
 Preset when Switching to Night Mode	None ▼

[Preset when Switching to Day Mode]

Executes the preset when switched to Day Mode.

[Preset when Switching to Night Mode]

Executes the preset when switched to Night Mode.

Use Event Combinations

[Event] > [Linked Event]

R11 M641 M741

By linking two types of events, a single event is triggered. Select AND/OR for the event linking method. You can set the operations to perform, such as recording video or sending e-mail notifications, when a linked event is triggered.

Note

You can check the linked event status on the Admin Viewer Event Display panel (P. 185).

Linked Event 1 to 4

You can register up to four linked events.

You can link five types of events: [Volume Detection], [Scream Detection], [External Device Input], [Timer] and [Intelligent Function].

Linked Event 1	
Linked Event	Enable
Event Linking Method	AND
Event Order	None
Event Gap (seconds) 0 - 60	2
Event 1	
Event Type	External Device Input
External Device Input	Input 1
Status	Active
Event 2	
Event Type	Intelligent Function
Intelligent Function	Setting 1
Status	On
Operation	
ON Event Operation	Enable
OFF Event Operation	Disable
Ongoing ON Event Operation	Disable
Video Record	Disable
E-mail Notification	Disable
External Device Output for ON Event	Disable
External Device Output for OFF Event	Disable
Audio Playback at ON Event	Enable
Audio Playback at OFF Event	Disable
Sound Clip	SAMPLE_1
Volume 1 - 100	50

[Linked Events]

Select whether to use a linked event.

[Event Linking Method]

Select the event linking conditions.

[AND]: A new linked event is triggered if both event types selected with [Event 1] and [Event 2] are triggered. Set [Event Order] and [Event Gap] for this.

[OR]: A new linked event is triggered if either event type selected with [Event 1] and [Event 2] is triggered.

[Event Order]

You can select the order two events must be triggered when [Event Linking Method] is set to [AND]. If set to [None], the order will not be considered.

[Event Gap (seconds)]

Enter the interval between two events that must be triggered when [Event Linking Method] is set to [AND]. A new linked event is triggered if the second event triggers within the specified interval after the first event was triggered.

■ Event 1, 2

Specify the two events to be linked. The settings are the same for both.

[Event Type]

Select the event type for linking.



Note

[Intelligent Function] cannot be specified in both [Event 1] and [Event 2].

Event 1	
Event Type	Volume Detection
Status	On

For [Volume Detection], select whether an ON event or OFF event triggers a linked event.

Event 1	
Event Type	Scream Detection
Status	On

For [Scream Detection], select whether an ON event or OFF event triggers a linked event.

Event 1	
Event Type	External Device Input
External Device Input	Input 1
Status	Active

For [External Device Input], select External Device Input 1 or 2, then select an active event or inactive event to trigger a linked event.

Event 1	
Event Type	Timer
Timer	Timer 1

For [Timer], select the timer event number to use.

Event 1	
Event Type	Intelligent Function
Intelligent Function	Setting 1
Status	On

For [Intelligent Function], select the Intelligent Function detection setting number (P. 217) to use.

■ Operation

Set the operations to be performed when linked events are triggered.

[ON Event Operation]

If [Enable] is set, [Preset], [Video Record] and [E-mail Notification] will be executed according to their settings when a linked event (ON event) is triggered.

[OFF Event Operation]

If [Enable] is set, [Preset], [Video Record] and [E-mail Notification] will be executed according to their settings when a linked event (OFF event) is completed.

[Ongoing ON Event Operation]

Select the operation to be performed when an ON event is triggered.

If [Enable] is selected, [Video Record] and [E-mail Notification] will be executed according to their settings during the linked event.

[Preset] R11

If you specify a preset, the camera angle will automatically move to the preset location when a linked event is triggered.

It is necessary to set presets beforehand with [Control for Admin] > [Preset/Initial Setting] > [Preset Setting] (P. 170).

**Note**

This cannot be set when [Event Type] is set to [Intelligent Function].

[Video Record]

Select whether to record video depending on the linked event.

If you select [Enable] and a linked event is triggered, video will be transmitted to the recording destination specified in [Video Record Action] (P. 96).

[E-mail Notification]

Select whether to send an e-mail notification depending on the linked event.

If you select [Enable] and a linked event is triggered, an e-mail notification will be sent.

To use e-mail notification, you must set [Video Record] > [E-mail Notification] (P. 102) beforehand.

[External Device Output for ON Event]

Select whether external device output (1 or 2) is active or inactive when an ON event is triggered.

[External Device Output for OFF Event]

Select whether external device output (1 or 2) is active or inactive when an OFF event is triggered.

[Audio Playback at ON Event]

If you select [Enable], the sound clip specified in [Sound Clip] will play back when a linked event is triggered.

**Note**

This can only be set when [Event Type] is set to [External Device Input] or [Intelligent Function].

[Audio Playback at OFF Event]

If you select [Enable], the sound clip specified in [Sound Clip] will play back when a linked event completes.

[Sound Clip]

Select the sound clip when [Audio Playback at ON Event] or [Audio Playback at OFF Event] has been set to [Enable].

You must register the sound clip with [Video and Audio] > [Audio Settings] (P. 88) beforehand.

[Volume]

Enter the volume for the sound clip.

Linked Event Operation Examples

This shows linked event status examples according to the ON/OFF combinations for Event 1 and Event 2.

In the examples below, [Event Gap] is 4 seconds and each cell in the graph below represents 1 second.

■ [Event Linking Method] Set to [OR]

Only One Event ON

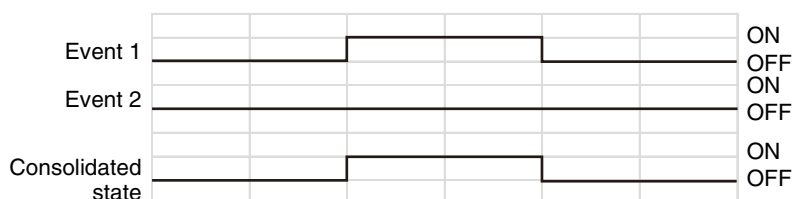

Both Events ON

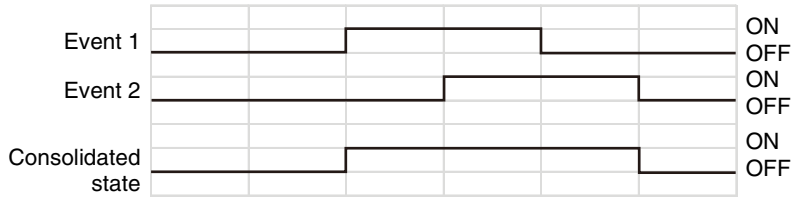

■ [Event Linking Method] is Set to [AND], [Event Order] is Specified

This shows examples when [Event Order] is set to [Event 1 -> 2].

When [Event Order] is set to [None], and [Event Linking Method] is set to [AND] linked events will be as in the examples even if Event 1 and Event 2 are switched.

When Events Occur in Order 1 -> 2

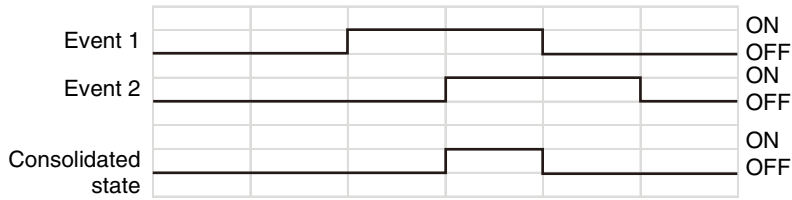

When Events Occur in Order 2-> 1 -> 2

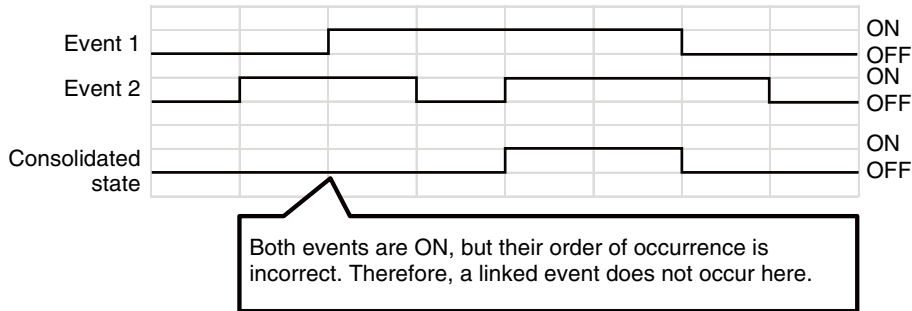

Event 2 Triggered but Event Gap Setting ([4] sec.) Exceeded

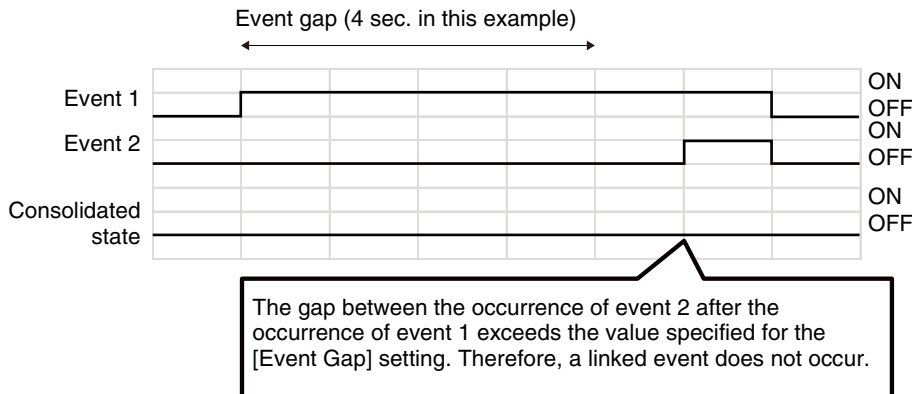

[Status] of Event 1 Set to [OFF], ON States Do Not Coincide

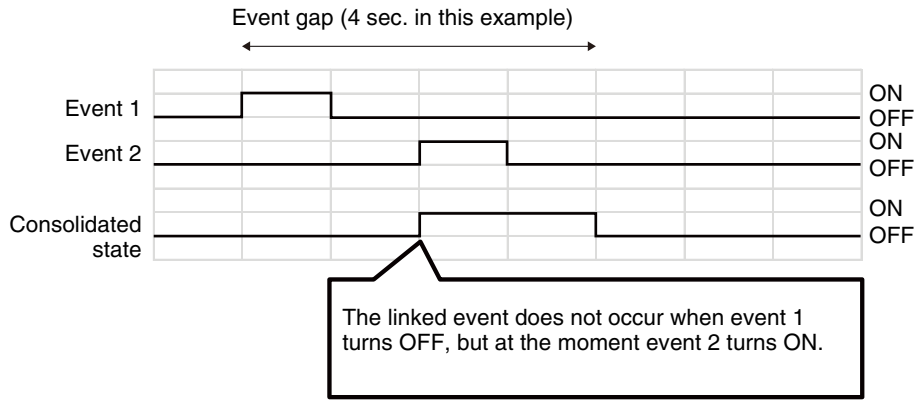

One Event Switches Between ON/OFF

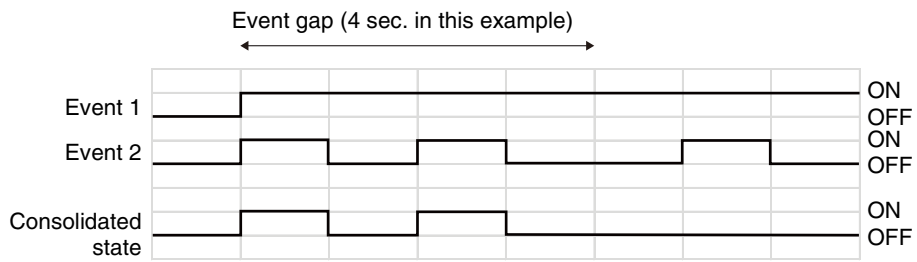

Set Users Who Connect to the Camera [Security] > [User Restrictions]

Used for adding new authorized users that can access Admin Viewer, and for setting permissions for authorized and guest users.

For details on user permissions, please refer to “Viewer Access Restrictions” (P. 138).

Authorized User Account

Add authorized users.

Authorized User Account	
User Name Up to 15 characters	<input type="text"/>
Password 6 to 15 characters	<input type="password"/>
	<input type="button" value="Add"/>
User List	<div style="border: 1px solid gray; height: 100px;"></div>
	<input type="button" value="Delete"/>
	<input type="button" value="▲"/> <input type="button" value="▼"/>

[User Name], [Password]

To add the authorized user, enter the user name and password, then click [Add].

The user name can use the characters A to Z, a to z, 0 to 9, “-” (hyphen) and “_” (underscore).

Enter the password in alphanumeric characters.

Up to 50 authorized users can be added.

[User List]

Displays a list of added authorized users.

The order of the list can be changed with the ▲▼ buttons on the right.

To delete an authorized user from the list, select the user and click [Delete].

User Authority

Set the permissions for authorized users and guest users.

User Authority				
	Privileged Camera Control	Camera Control	Video Distribution	Audio Distribution
Authorized User	<input checked="" type="checkbox"/>	<input checked="" type="checkbox"/>	<input checked="" type="checkbox"/>	<input checked="" type="checkbox"/>
Guest User		<input checked="" type="checkbox"/>	<input checked="" type="checkbox"/>	<input checked="" type="checkbox"/>

[Privileged Camera Control], [Camera Control], [Video Distribution]

[Audio Distribution] **R11** **M641** **M741**

Select the items for granting users permissions.

Authorized users have elevated permissions compared to guest users.

Set Access Restrictions

[Security] > [Host Access Restrictions]

Separate access control from IPv4 and IPv6 addresses can be set.

Important



- To prohibit access via a proxy server in HTTP connection, a proxy server address must be set.
- If host access restriction is set mistakenly, access to the Setting Pages themselves may be prohibited, in which case restoring the factory default settings will become the only means for recovery.

Note

If the same address is duplicated, the policy for the address that appears highest on the list will be applied.

IPv4 Host Access Restrictions

Specify the hosts from which IPv4 access is permitted and restricted.

IPv4 Host Access Restrictions			
 Apply Host Access Restrictions	Enable <input type="button" value="v"/>		
 Default Policy	Authorize Access <input type="button" value="v"/>		
 Network Address / Subnet	01:	<input type="text"/>	32 Yes <input type="button" value="v"/>
	02:	<input type="text"/>	32 Yes <input type="button" value="v"/>
	03:	<input type="text"/>	32 Yes <input type="button" value="v"/>
	04:	<input type="text"/>	32 Yes <input type="button" value="v"/>
	05:	<input type="text"/>	32 Yes <input type="button" value="v"/>
	06:	<input type="text"/>	32 Yes <input type="button" value="v"/>
	07:	<input type="text"/>	32 Yes <input type="button" value="v"/>
	08:	<input type="text"/>	32 Yes <input type="button" value="v"/>
	09:	<input type="text"/>	32 Yes <input type="button" value="v"/>
	10:	<input type="text"/>	32 Yes <input type="button" value="v"/>
	11:	<input type="text"/>	32 Yes <input type="button" value="v"/>

[Apply Host Access Restrictions]

Select whether to use IPv4 host access restrictions.

[Default Policy]

Select whether to allow or block access from IPv4 addresses that have not been specified in [Network Address / Subnet].

[Network Address / Subnet]

Enter IPv4 addresses into the list and select [Yes] or [No] for access for each address.

You can specify the subnet to set access restrictions by network or host.

If set to [No], access to all ports is blocked.

IPv6 Host Access Restrictions

Specify the hosts from which IPv6 access is permitted and restricted.

IPv6 Host Access Restrictions				
Apply Host Access Restrictions	Enable			
Default Policy	Authorize Access			
Prefix / Prefix Length	01:	<input type="text"/>	/	128 Yes
	02:	<input type="text"/>	/	128 Yes
	03:	<input type="text"/>	/	128 Yes
	04:	<input type="text"/>	/	128 Yes
	05:	<input type="text"/>	/	128 Yes
	06:	<input type="text"/>	/	128 Yes
	07:	<input type="text"/>	/	128 Yes
	08:	<input type="text"/>	/	128 Yes
	09:	<input type="text"/>	/	128 Yes
	10:	<input type="text"/>	/	128 Yes
	11:	<input type="text"/>	/	128 Yes

[Apply Host Access Restrictions]

Select whether to use IPv6 host access restrictions.

[Default Policy]

Select whether to allow or block access from IPv6 addresses that have not been specified in [Prefix / Prefix Length].

[Prefix / Prefix Length]

Enter IPv6 addresses (prefixes) into the list and select [Yes] or [No] for access for each address.

You can specify the prefix length to set access restriction by network or host.

If set to [No], access to all ports is blocked.

Set HTTP Communication Encryption

[Security] > [SSL/TLS]











Certificate creation, administrative settings and encrypted communication settings.

Certificates

Create an SSL/TLS certificate.

Important

Use a self-signed certificate when complete security does not need to be ensured, such as through operation tests. For system operation, it is recommended that you acquire and install a certificate issued by a CA.

Certificates	
 Create Self-Signed Certificate	<input type="button" value="Exec"/>
 Certificate Status	Not Installed
 Country (C) 2 characters	
 State/Province (ST) Up to 128 characters	
 Locality (L) Up to 128 characters	
 Organization (O) Up to 64 characters	
 Organizational Unit (OU) Up to 64 characters	
 Common Name (CN) Up to 64 characters	
 Validity Period Start Date yyyy/mm/dd	
 Validity Period End Date yyyy/mm/dd	

[Create Self-Signed Certificate]

Enter the following items and click [Exec] to create a self-signed certificate.

Follow the displayed message and reboot. The certificate created will take effect after rebooting.

Note

Creating a certificate takes time, so it is recommended that you stop video transmission and upload processes.

[Certificate Status]

If no certificate is installed, [Not Installed] will appear. If a certificate is installed, the validity period for the certificate will appear.

[Country (C)]

Enter the ISO3166-1 alpha-2 country code.

[State/Province (ST)], [Locality (L)], [Organization (O)], [Organizational Unit (OU)], [Common Name (CN)]

Enter state/province name, locality, organization name, organizational unit and common name in alphanumeric characters (spaces or printable characters).

Enter an FQDN format host name, etc. to set the common name (required).

[Validity Period Start Date], [Validity Period End Date]

Set the validity period of the certificate to be created (required when creating a self-signed certificate).

Certificate Management

Manage the SSL/TLS certificate.

Certificate Management	
Generate Certificate Signing Request	Exec
Display Certificate Signing Request	Exec
Install Server Certificate	<input type="text"/> Browse... Exec
Install Intermediate Certificate	<input type="text"/> Browse... Exec
Delete Server Certificate	Exec
Delete Intermediate Certificate	Exec
Display Server Certificate Details	Exec
Display Self CA Certificate	Exec
Backup	Exec
Restore	<input type="text"/> Browse... Exec

[Generate Certificate Signing Request]

Click [Exec] to create server private key and generate a certificate signing request. Once processed, the certificate signing request will appear in a separate window.

Note

Generating a certificate signing request takes time, so it is recommended that you stop video transmission and upload processes.

[Display Certificate Signing Request]

Click [Exec] to view the details of the certificate signing request.

[Install Server Certificate]

Perform this operation to install a server certificate. Specify the certificate file to be installed using [Browse] and click [Exec]. The certificate installed will take effect after rebooting.

[Install Intermediate Certificate]

Perform this operation to install an intermediate certificate. Specify the certificate file to be installed using [Browse] and click [Exec]. The certificate installed will take effect after rebooting.

Note

To install an intermediate certificate and a primary intermediate certificate, use a text editor or similar software to place them in the same file and install them as an intermediate certificate.

[Delete Server Certificate]

Click [Exec] to delete the server certificate. However, if SSL communications are enabled, the certificate cannot be deleted. Set [SSL Communications] to [Disable] before deleting a certificate. The deletion will take effect after rebooting.

[Delete Intermediate Certificate]

Click [Exec] to delete the intermediate certificate along with the primary certificate. However, if SSL communications are enabled, the certificate cannot be deleted. Set [SSL Communications] to [Disable] before deleting a certificate. The deletion will take effect after rebooting.

[Display Server Certificate Details]

Click [Exec] to view the details of the certificate.

[Display Self CA Certificate]

Used for the purpose of testing SSL communications, but otherwise not normally used.

[Backup]

Click [Exec] to perform a backup of the certificates and private key. This can only be performed via SSL communications.

[Restore]

Installs the certificates and private key from backup.

Click [Browse] to specify the backup file, then click [Exec]. This can only be performed via SSL communications.

The restored certificate will take effect after rebooting.

Encrypted Communications

Set encrypted communications.

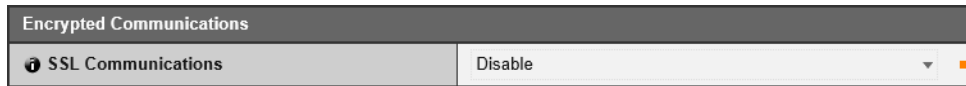

[SSL Communications]

Select this to enable or disable SSL communications.

The setting will take effect after rebooting.

However, if no certificate is installed, SSL communications cannot be used.

Note

- It may take a few minutes to generate an SSL key.
- If SSL communications are used, video transmission performance drops.
- Depending on the type of the certificate being installed on the camera, a dialog box may appear indicating that the web browser has accepted the certificate and a connection can be made. If the dialog box does not appear, register the CA certificate in the web browser.

Network Port Authentication Settings

[Security] > [802.1X]

Settings for 802.1X authentication and authentication status display, and for certificate administration.

802.1X Authentication

Display the 802.1X authentication enable/disable control and status.

802.1X Authentication	
802.1X Authentication	Disable
Authentication Status	Stop

[802.1X Authentication]

Select this to enable or disable 802.1X authentication.

[Authentication Status]

Display the status of 802.1X authentication. There are three types of status: [Authenticated], [Unauthenticated], and [Stop].

Authentication Method

Set the authentication method used for 802.1X authentication.

Authentication Method	
Authentication Method	EAP-MD5
User Name <small>Up to 63 characters</small>	
Password <small>1 to 244 characters</small>	*****

[Authentication Method]

Select the authentication method used for 802.1X authentication.

[User Name]

Enter the user name used for authentication.

[Password]

Enter the required password for authentication.

This is displayed only when [Authentication Method] is set to [EAP-MD5], [EAP-TTLS], or [EAP-PEAP].

■ Certificate Information

This is displayed only when [Authentication Method] is set to [EAP-TLS], [EAP-TTLS], or [EAP-PEAP].

Certificate Information	
CA Certificate Status	Not Installed
Client Certificate Status	Not Installed
Client Private Key Status	Not Installed

[CA Certificate Status]

If no CA certificate is installed, [Not Installed] is displayed. If a CA certificate is installed, the validity period of the certificate is displayed.

[Client Certificate Status]

If no client certificate is installed, [Not Installed] is displayed. If a client certificate is installed, the validity period of the certificate is displayed.

This is displayed only when [Authentication Method] is set to [EAP-TLS].

[Client Private Key Status]

If no client private key is installed, [Not Installed] is displayed. If a client private key is installed, [Installed] is displayed.

This is displayed only when [Authentication Method] is set to [EAP-TLS].

Certificate Management

This is displayed only when [Authentication Method] is set to [EAP-TLS], [EAP-TTLS], or [EAP-PEAP].

Important

- If any CA certificates, client certificates, and client private keys already exist when installing certificates, they are discarded and new versions are installed.
- An error occurs if the format of the certificate or private key to be installed is incorrect.
- Client certificates and client private keys are checked as a pair when installing, and an error occurs if they do not match.
- The certificate and private key used for 802.1X authentication must be installed as separate items, irrespective of the installation status of certificates for SSL/TLS.

Certificate Management	
Install CA Certificate	<input type="text"/> <input type="button" value="Browse..."/> <input type="button" value="Exec"/>
Install Client Certificate	<input type="text"/> <input type="button" value="Browse..."/> <input type="button" value="Exec"/>
Install Client Private Key	<input type="text"/> <input type="button" value="Browse..."/> <input type="button" value="Exec"/>
Client Private Key Password <small>1 to 234 characters</small>	<input type="password" value="*****"/>
Delete Certificate	<input type="button" value="Exec"/>

[Install CA Certificate]

Installs a CA certificate.

Specify the certificate file to be installed using [Browse] and click [Exec].

[Install Client Certificate]

Installs a client certificate.

Specify the certificate file to be installed using [Browse] and click [Exec].

This is displayed only when [Authentication Method] is set to [EAP-TLS].

[Install Client Private Key]

Installs a client private key.

Specify the private key file to be installed using [Browse] and click [Exec].

This is displayed only when [Authentication Method] is set to [EAP-TLS].

[Client Private Key Password]

Enter the password for the client private key.

Required when a password has been configured for the private key.

This is displayed only when [Authentication Method] is set to [EAP-TLS].

[Delete Certificate]

Deletes all installed CA certificates, client certificates, and client private keys.

Only "CA Certificate" is displayed when [Authentication Method] is set to [EAP-TTLS] or [EAP-PEAP], but any installed client certificates and client private keys are also deleted.

Set IPsec

[Security] > [IPsec]

Settings for using IPsec.



Important

- To run this camera with IPsec, the communicating devices and network must be set beforehand. Contact your system administrator for these settings.
- When connecting with IPsec, set the camera IP address manually.
For IPv4 addresses, use addresses with [IPv4 Address Setting Method] set to [Manual] in [Basic Settings] > [Network] > [IPv4].
For IPv6 addresses, use addresses set with [IPv6 Address (Manual)] in [Basic Settings] > [Network] > [IPv6].
- If the IPsec setting is changed and the camera may become inaccessible from the active web browser, a confirmation dialog box will appear. Click [OK] to apply the new settings.
If you reboot the camera and cannot connect to the camera from the web browser, any available URI for connecting to the camera will be displayed in a message.
If you cannot connect to the camera through the displayed URI, contact your system administrator.

Note

If IPsec is used, video transmission performance drops.



















IPsec

IPsec	
 IPsec	Auto Key Exchange  

[IPsec]

Select key settings for using IPsec.

Auto Key Exchange Settings

Auto Key Exchange Settings	
 IPsec SA Encryption Algorithm	AES->3DES  
 IPsec SA Authentication Algorithm	HMAC_SHA1_96  
 IPsec SA Validity Period (min) <small>10 - 1440</small>	480 
 ISAKMP SA Encryption Algorithm	AES->3DES  
 ISAKMP SA Authentication Algorithm	SHA1  
 DH Group	Group 2  
 ISAKMP SA Validity Period (min) <small>10 - 1440</small>	480 

[IPsec SA Encryption Algorithm]

Select the IPsec SA encryption algorithm.

The specified algorithm will be checked for an applicable encryption algorithm starting from the left.

[IPsec SA Authentication Algorithm]

Select the IPsec SA authentication algorithm.

The specified algorithm will be checked for an applicable authentication algorithm starting from the left.

[IPsec SA Validity Period (min)]

Enter the duration of validity for IPsec SA.

[ISAKMP SA Encryption Algorithm]

Select the SA encryption algorithm for use with auto key exchange protocol IKE.

[ISAKMP SA Authentication Algorithm]

Select the SA authentication algorithm for use with auto key exchange protocol IKE.

[DH Group]

Select the key generation information that will be used in the DH algorithm for key exchange via auto key exchange protocol IKE.

[ISAKMP SA Validity Period (min)]

Enter the duration of validity for ISAKMP SA.

IPsec Set 1 to 5

IP security can be specified through auto key exchange or manual setting with up to five communicating devices.

■ Auto Key Exchange

**Important**

If the camera is rebooted during auto key exchange communication, a connection error may result after rebooting. If this occurs, connect again.

**Note**

If auto key exchange is used, it will take approximately 5 to 10 seconds before communication with the camera starts.

IPsec Set 1	
IPsec Set	Enable in IPv4
IPsec Mode	Tunnel Mode
Destination IPv4 Address	192.168.200.1
Source IPv4 Address	192.168.100.1
Security Protocol	ESP
Security Gateway IPv4 Address	192.168.10.1
Destination Subnet Mask Length 1 - 32	16
IKE Pre-Shared Key Up to 127 characters	pre-shared-key

[IPsec Set]

Set whether IPv4 or IPv6 will use or will not use IPsec sets.

[IPsec Mode]

Select the IPsec mode.

[Destination IPv4 Address], [Destination IPv6 Address]

Enter the IP address of the connection destination.

[Source IPv4 Address], [Source IPv6 Address]

Enter the IP address of the source.

[Security Protocol]

Select the IPsec protocol.

If [ESP] is selected, enter only the setting items relating to ESP.

If [AH] is selected, enter only the setting items relating to AH.

If [ESP and AH] is selected, enter all setting items.

[Security Gateway IPv4 Address], [Security Gateway IPv6 Address]

Enter the IP address of the security gateway if [IPsec Mode] is set to [Tunnel Mode].

[Destination Subnet Mask Length] (IPv4), [Destination Prefix Length] (IPv6)

Enter the subnet mask (IPv4) or prefix length (IPv6) when [IPsec Mode] is set to [Tunnel Mode].

[IKE Pre-Shared Key]

Enter the pre-shared key for IKE (auto key exchange).

IPsec Set 1	
IPsec Set	Enable in IPv4
IPsec Mode	Tunnel Mode
Destination IPv4 Address	192.168.200.1
Source IPv4 Address	192.168.100.1
Security Protocol	ESP and AH
Security Gateway IPv4 Address	192.168.10.1
Destination Subnet Mask Length <small>1 - 32</small>	16
SA ESP Encryption Algorithm	AES
SA ESP Authentication Algorithm	HMAC_SHA1_96
SA ESP Encryption Key (outbound)	0445981926E9AC7E79385E037C35FC3
SA ESP Authentication Key (outbound)	BB64787768DFC8DE7E7B4D84EC81B453158F3B32
SA ESP SPI (outbound) <small>256 or higher</small>	1000
SA ESP Encryption Key (inbound)	6F822A37272BF55EB581A91A53770C57
SA ESP Authentication Key (inbound)	81E4DC85387FB09192B26CA1A2FBD97202159B96
SA ESP SPI (inbound) <small>256 or higher</small>	2000
SA AH Authentication Algorithm	HMAC_SHA1_96
SA AH Authentication Key (outbound)	6F92282D51B290EA4B51D8833A4EFF295A6E5F40
SA AH SPI (outbound) <small>256 or higher</small>	3000
SA AH Authentication Key (inbound)	7E0E6F639A0A81A83B6C5642EFE859881B2883AE
SA AH SPI (inbound) <small>256 or higher</small>	4000

[IPsec Set]

Set whether IPv4 or IPv6 will use or will not use IPsec sets.

[IPsec Mode]

Select the IPsec mode.

[Destination IPv4 Address], [Destination IPv6 Address]

Enter the IP address of the connection destination.

[Source IPv4 Address], [Source IPv6 Address]

Enter the IP address of the source.

[Security Protocol]

Select the IPsec protocol.

If [ESP] is selected, enter only the setting items relating to ESP.

If [AH] is selected, enter only the setting items relating to AH.

If [ESP and AH] is selected, enter all setting items.

[Security Gateway IPv4 Address], [Security Gateway IPv6 Address]

Enter the IP address of the security gateway if [IPsec Mode] is set to [Tunnel Mode].

[Destination Subnet Mask Length] (IPv4), [Destination Prefix Length] (IPv6)

Enter the subnet mask (IPv4) or prefix length (IPv6) when [IPsec Mode] is set to [Tunnel Mode].

When [Security Protocol] Is Set to [ESP] or [ESP and AH]

[SA ESP Encryption Algorithm] to [SA ESP SPI (inbound)] must be set.

[SA ESP Encryption Algorithm]

Set the ESP encryption algorithm to suit the encryption algorithm supported by the device to connect to.

Normally [AES] or [3DES] is recommended.

[SA ESP Authentication Algorithm]

Set the ESP authentication algorithm to suit the authentication algorithm supported by the device to connect to.

If [ESP] is used alone, [No Authentication] cannot be selected.

[SA ESP Encryption Key (outbound)]

Enter the SA encryption key for outbound.

If [AES], [3DES] or [DES] was selected in [SA ESP Encryption Algorithm], set a 128-bit, 192-bit or 64-bit hexadecimal number, respectively. This item need not be set if [NULL] was selected.

[SA ESP Authentication Key (outbound)]

Enter the SA authentication key for outbound.

If [HMAC_SHA1_96] or [HMAC_MD5_96] was selected in [SA ESP Authentication Algorithm], set a 160-bit or 128-bit hexadecimal number, respectively. This item need not be set if [No Authentication] was selected.

[SA ESP SPI (outbound)]

Enter the SA SPI value for outbound.

Set a desired value in the range of 256 to 4294967295.

[SA ESP Encryption Key (inbound)]

Enter the SA encryption key for inbound.

If [AES], [3DES] or [DES] was selected in [SA ESP Encryption Algorithm], set a 128-bit, 192-bit or 64-bit hexadecimal number, respectively. This item need not be set if [NULL] was selected.

[SA ESP Authentication Key (inbound)]

Enter the SA authentication key for inbound.

If [HMAC_SHA1_96] or [HMAC_MD5_96] was selected in [SA ESP Authentication Algorithm], set a 160-bit or 128-bit hexadecimal number, respectively. This item need not be set if [No Authentication] was selected.

[SA ESP SPI (inbound)]

Enter the SA SPI value for inbound.

Set a desired value in the range of 256 to 4294967295.

Since this setting is used as an ID for identifying the SA, be careful not to specify an inbound SPI whose value is already used in the SPI for other ESP.

When [Security Protocol] Is Set to [AH] or [ESP and AH]

[SA AH Authentication Algorithm] to [SA AH SPI (inbound)] must be set.

[SA AH Authentication Algorithm]

Set the AH authentication algorithm to suit the authentication algorithm supported by the device to connect to.

[SA AH Authentication Key (outbound)]

Enter the SA authentication key for outbound.

If [HMAC_SHA1_96] or [HMAC_MD5_96] was selected in [SA AH Authentication Algorithm], set a 160-bit or 128-bit hexadecimal number, respectively.

[SA AH SPI (outbound)]

Enter the SA SPI value for outbound.

Set a desired value in the range of 256 to 4294967295.

[SA AH Authentication Key (inbound)]

Enter the SA authentication key for inbound.

If [HMAC_SHA1_96] or [HMAC_MD5_96] was selected in [SA AH Authentication Algorithm], set a 160-bit or 128-bit hexadecimal number, respectively.

[SA AH SPI (inbound)]

Enter the SA SPI value for inbound.

Set a desired value in the range of 256 to 4294967295.

Since this setting is used as an ID for identifying the SA, be careful not to specify an inbound SPI whose value is already used in the SPI for another AH.

Memory Card Operations and Information Display

[Memory Card]

Settings for recording video to a memory card inserted in the camera. You can also see the status of the memory card. The content on this page is common with [Video Record] > [Memory Card] (P. 101). Settings configured in any page will be reflected in the other pages.

Important

Information recorded to the memory card may be regarded as “personal information”. Take sufficient precautions for handling this information when releasing to third parties for disposal, transfer or repair.

Note

- The following memory cards can be used.
 - SD memory card, SDHC memory card, SDXC memory card **R11** **R10** **M741** **M740**
 - microSD memory card, microSDHC memory card, microSDXC memory card **M641** **M640**
- For inserting and removing the memory card, please refer to “Installation Guide” > “Using a Memory Card”.
- Only H.264(1) video can be recorded to a memory card. [H.264(2)] cannot be recorded.

Video Record Setting

Sets whether to record video from the camera to a memory card or upload it with HTTP or FTP. These can also be set with [Video Record] > [Upload] (P. 96) and will be reflected in [Video Record Setting] here.

Video Record Setting	
 Video Record Action	Record to Memory Card 

[Video Record Action]

Select [Record to Memory Card] to record to a memory card.

Memory Card Operations

The setting items will change depending on the memory card status (unmounted/mounted).

Important

Be sure to perform the unmount process when turning off the power to the camera or removing the memory card. Failing to unmount first may result in management file problems or the memory card becoming inaccessible.

You can use the Camera Management Tool (P. 36) to batch mount/unmount memory cards from multiple cameras.

Mount Status

The memory card will be automatically mounted when you insert it into the memory card slot. It will also be automatically mounted if it has been inserted in the memory card slot when the camera starts up.

Memory Card Operations	
Mount/Unmount	<input type="button" value="Unmount"/>
Operation Settings	Save Logs and Videos
Video Format	JPEG
Pre-event Buffer (number of frames) <small>0 - 100</small>	0
Post-event Buffer (number of frames) <small>0 - 100</small>	0
Overwrite videos	Disable
Auto Video Delete	Enable
Days Saved <small>1 - 90</small>	30
Delete Time <small>hh:mm</small>	00:00
Recreate Video Management Information	<input type="button" value="Exec"/>
Format	<input type="button" value="Exec"/>

[Mount/Unmount]

Click [Unmount] to unmount the memory card.

Be sure to unmount the memory card when turning off the power to the camera or removing the memory card.

[Operation Settings]

Select the data to save to the memory card.

For details on the video saved when [Save Logs and Videos] has been set, please refer to “Saved Data and Data Organization of Memory Card” (P. 250).

Note

New files cannot be saved to the memory card if there is no free space.

[Video Format]

Select the video format to record to a memory card.

Video is recorded in this format when [Video Record Action] is set to [Record to Memory Card].

Video size and quality of the recorded video follow the settings in [Video Settings] (P. 72).

Important

For [H.264(1)], the following settings must be configured in [Video Settings] > [H.264(1)] (P. 73).

- [Bit Rate Control]: [Use bit rate control]
- [Target Bit Rate (kbps)]: [3072] or less
- [I Frame Interval (sec)]: [0.5], [1] or [1.5]

Note

- When set to [JPEG] and an upload error occurs, the frame rate of video recorded in JPEG format is always 1 fps.
- When a network error occurs interrupting the transmission of recording-mode stream video, video is saved in the JPEG format regardless of the [Video Format] setting (the frame rate is fixed at 1 fps).

[Pre-event Buffer (number of frames)] (JPEG)/ [Pre-event Buffer (sec)] (H.264(1))

Enter the number of frames or seconds of video to be buffered before the event.

Enter the maximum number of frames for [JPEG] or the maximum number of seconds for [H.264(1)] in [Video Format].

Depending on conditions, however, saving the set number of frames or seconds may not be possible.

[Post-event Buffer (number of frames)] (JPEG)/ [Post-event Buffer (sec)] (H.264(1))

Enter the number of frames or seconds of video to be buffered after the event.

Enter the maximum number of frames for [JPEG] or the maximum number of seconds for [H.264(1)] in [Video Format].

Depending on conditions, however, saving the set number of frames or seconds may not be possible.

[Overwrite videos]

Select whether to allow overwriting data when the available space on the memory card becomes too low while recording video to a memory card due to an event being triggered.

If you select [Enable], videos recorded due to an event, timer or ONVIF will be overwritten starting from the oldest file.

[Auto Video Delete]

Select to automatically delete video from the memory card that has exceeded the [Days Saved] setting.

If you select [Enable], set [Days Saved] and [Delete Time].

[Days Saved]

Enter the number of days video recorded to the memory card should be saved.

[Delete Time]

Enter the time to delete video that has exceeded the [Days Saved] setting.

[Recreate Video Management Information]

If you click [Exec], the management information file for recorded video will be recreated on the memory card.

The memory card cannot be accessed during this process. It is also recommended that users not upload or stream video from the camera.

The more files that are involved in the recreation of video management information, the longer the process will take and may require several hours to process.

[Format]

Click [Exec] to format the memory card.

Formatting erases all files and directories on the memory card.

■ Unmount Status

If a memory card is not inserted into the camera, or if you click [Unmount] in [Memory Card Operations], the memory card status will change to unmounted.

Memory Card Operations	
Mount/Unmount	Mount
Operation Settings	Save Logs and Videos
Video Format	JPEG
Pre-event Buffer (number of frames) 0 - 100	0
Post-event Buffer (number of frames) 0 - 100	0
Overwrite videos	Disable
Auto Video Delete	Disable
Format	Exec

[Mount/Unmount]

Click [Mount] to change the status of an inserted memory card to mounted.

For details on [Operation Settings], [Video Format], [Pre-event Buffer], [Post-event Buffer], [Overwrite videos], [Auto Video Delete], [Days Saved], [Delete Time] and [Format], please refer to "Mount Status" (P. 131).

Memory Card Information

Displays the status of the memory card inserted in the camera and information about card capacity.

Memory Card Information	
Memory Card Recognition	Mounted
Memory Card Operation Status	Operable
Video Management Information Status	Normal
Video Saving	Can Save
Memory Card Capacity	991616KB (968.3MB)
Used Capacity	12384KB (12.0MB)

[Memory Card Recognition]

Displays the current status of the memory card.

[Memory Card Operation Status]

Displays the operation status of the memory card.

[Operable]: Status of various possible operations.

[Recreating video management information]: This status indicates that video management information is being recreated. Other operations cannot be performed.

[Deleting videos]: This status indicates that videos are being deleted. Other operations cannot be performed.

[Video Management Information Status]

Displays the status of the video management information.

[Normal]: This status indicates that video management information is normal.

[Video Management Information Recreation Required]: This status indicates that management files are corrupted or not consistent with saved video files.

It is necessary to click [Exec] in [Recreate Video Management Information] to recreate the management file.

If the management files are not recreated even when [Recreate Video Management Information] is used, [Format] (P. 132) must be used.

[Video Saving]

Displays whether videos can be saved to the memory card.

[Cannot Save] may occur for the following reasons.

- Memory card is not mounted.
- The video management file is corrupted.
- The card is write-protected.
- The memory card is full and [Overwrite videos] is set to [Disable].

[Memory Card Capacity]

Displays the current capacity of the memory card.

[Used Capacity]

Displays the current used capacity of the memory card.

**Note**

For details on data saved to the memory card, please refer to "Memory Card Data" (P. 250).

Display Camera Device Information and Perform Maintenance [Maintenance]

Check camera information, such as the firmware version, and perform maintenance on the camera system.

Device Information











Displays information about the connected camera.

Device Information	
Model Name	VB-R11
Firmware Version	Ver. 1.0.0
Serial Number	XXXXXXXXXX
Build Number	10000000
MAC address	00:00:00:00:00:00

Tool

You can display camera logs and settings, initialize and backup/restore settings.

Caution
You must not turn off the camera while [Restore Default Settings], [Back Up Settings] or [Restore Settings] are in operation. Turning off the camera at this stage may result in disabling its ability to boot correctly.

Tool	
 View Logs	<input type="button" value="View"/>
 View Current Settings	<input type="button" value="View"/>
 View License	<input type="button" value="View"/>
 Reboot	<input type="button" value="Exec"/> 
 Restore Default Settings	<input type="button" value="Exec"/> 
 Back Up Settings	<input type="button" value="Exec"/>
 Restore Settings	<input type="button" value="Exec"/> 
 Refresh Drive System	<input type="button" value="Exec"/>

[View Logs]

Display a history of camera operations and connections to each viewer, etc.

[View Current Settings]

Display a list of current settings for the Setting Page.

[View License]

Display information on 3rd party software licenses.

[Reboot]

Reboot the camera.

[Restore Default Settings]

Except for the following settings, all user settings will be discarded and returned to the default settings after rebooting.

- Administrator password of the basic settings, LAN, IPv4, IPv6
- Date and Time
- Host access restrictions for security
- SSL/TLS

- 802.1X

Note

- It is recommended that you note down each current setting before you click [Exec] in [Restore Default Settings].
- The camera can be restored to factory default settings using the reset switch as well. Note, however, that this will reset all camera settings to factory default settings except for date and time (P. 270).

[Back Up Settings]

All settings, except date and time, will be backed up to the memory card.

The IP address, certificates used by SSL and 802.1X and private key will also be backed up.

[Restore Settings]

Restores all settings, except date and time, from the memory card backup file created with [Back Up Settings].

The IP address, certificates used by SSL and 802.1X and private key will also be restored.

After restore is completed, the camera will be rebooted.

Important

If you restore a backup file from another camera, you may encounter problems, such as address collisions on the network.

[Refresh Drive System] **R11** **R10**

Cleans the connection parts inside the camera.

When [Exec] is clicked, the pan operation is performed for two cycles each of left and right and then the camera returns to the camera angle before execution when the operation completes.

Using this may be effective if panning causes problems with the video and audio.

Note

The following users will be disconnected while refreshing the drive system.

- All users except for administrators
- Users not connected via RTP

Chapter

5

Admin Viewer/VB Viewer

Access the Viewers included on the camera with a web browser to view and use live video, and configure those display settings.

Admin Viewer and VB Viewer

Two types of Viewers are included on the camera, the Admin Viewer and the VB Viewer.

Admin Viewer

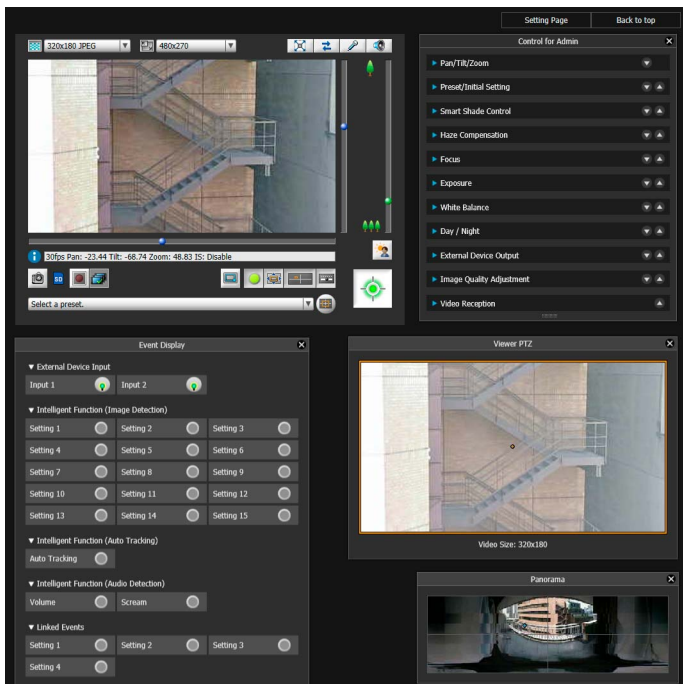

VB Viewer

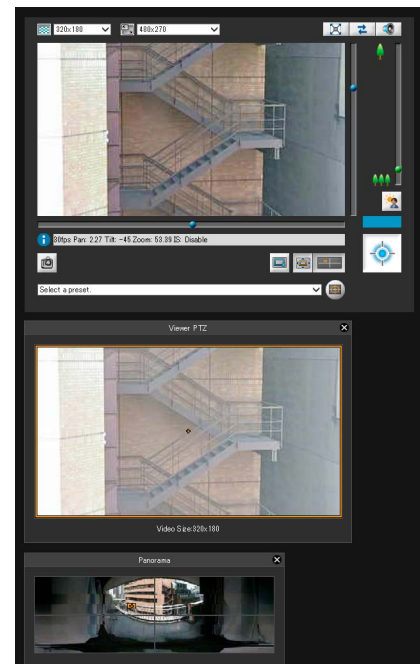

All panels are opened in these sample screenshots.

Major Differences Between the Admin Viewer and the VB Viewer

The scope of operations for Admin Viewer and VB Viewer differ.

Admin Viewer:

This viewer, in addition to using video, gives users administrative controls, such as for shooting conditions or event detection display.

VB Viewer:

This viewer is limited to basic image operations for viewing images.

Viewer Access Restrictions

Besides administrators, authorized users and guest users can access the Viewers.

The Viewers each user can access depend on the granted access privileges (P. 118).

Administrator:

This user is granted full privileges and can launch the Admin Viewer and VB Viewer. The user name is fixed to "root".

The administrator can prohibit all camera access from guest users by revoking all privileges for authorized users and guest users.

Authorized user:

This user can launch the Admin Viewer and VB Viewer if privileged camera control has been granted.

It is necessary to register the user name and password (P. 118).

Guest user:

This user can only use a limited set of functions. Guest users can launch the VB Viewer.

The four types of privileges for using the Viewers are privileged camera control, camera control, video distribution and audio distribution.

The scope of each privilege and whether it can be granted to a user is shown below.

Privilege	Privileged Camera Control	Camera Control	Video Distribution	Audio Distribution
Scope of Privilege	Admin Viewer Use	VB Viewer Use	View Video With VB Viewer	Receive or Audio with Admin Viewer/VB Viewer
Grant to Authorized Users	Yes	Yes	Yes	Yes
Grant to Guest Users	No	Yes	Yes	Yes

Important

The Admin Viewer launched by an administrator can access only one camera at a time. While administrator privileges are used to access the camera from a given computer, access with administrator privileges from other computers will not be granted. In contrast, the camera can be accessed simultaneously by multiple instances of the Admin Viewer launched by [Authorized Users] from different computers. Take note, however, that when controlling the camera, the control privileges are given to the user who accessed the camera most recently.

Note

- The factory default setting gives privileged camera control to [Authorized User] as well.
- If you disable all guest user privileges, the user authentication dialog box will appear when you launch the VB Viewer. When the name and password for an authorized user or administrator are entered, the VB Viewer can be used with authorized user or administrator privileges, respectively.

View Video With Admin Viewer

Launch the Admin Viewer to check the camera status and view video, and to configure settings.

Launch the Admin Viewer

Important

The Admin Tools Certificate must be installed on a computer to use the Admin Viewer (P. 28).

- 1** Launch the camera top page and click [Admin Viewer] (P. 41).

A user authentication window appears.

- 2** Enter a user name and password (P. 42) and click [OK].

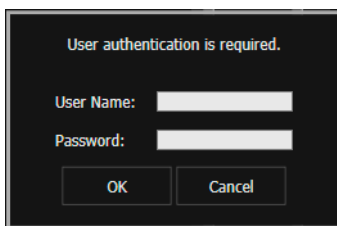
A screenshot of a user authentication dialog box. The dialog has a dark background with white text. At the top, it says "User authentication is required." Below this, there are two input fields: "User Name:" and "Password:". At the bottom, there are two buttons: "OK" and "Cancel".

Launches the Admin Viewer.

Note

- You can also launch the Admin Viewer from the Camera Management Tool. For details, please refer to the "Camera Management Tool User Manual".
- You can also launch the Admin Viewer by clicking [Admin Viewer] in the upper right of the [Admin Tools] page (P. 193).
- In environments without a proxy server, select [Internet options] > [Connections] tab > [LAN settings] and clear the [Automatically detect settings] check box in Internet Explorer.

■ Exit the Viewer

Close the web browser to exit the Viewer.

Admin Viewer/VB Viewer Screen

Basic operations not requiring administrator privileges are the same for both Viewers.

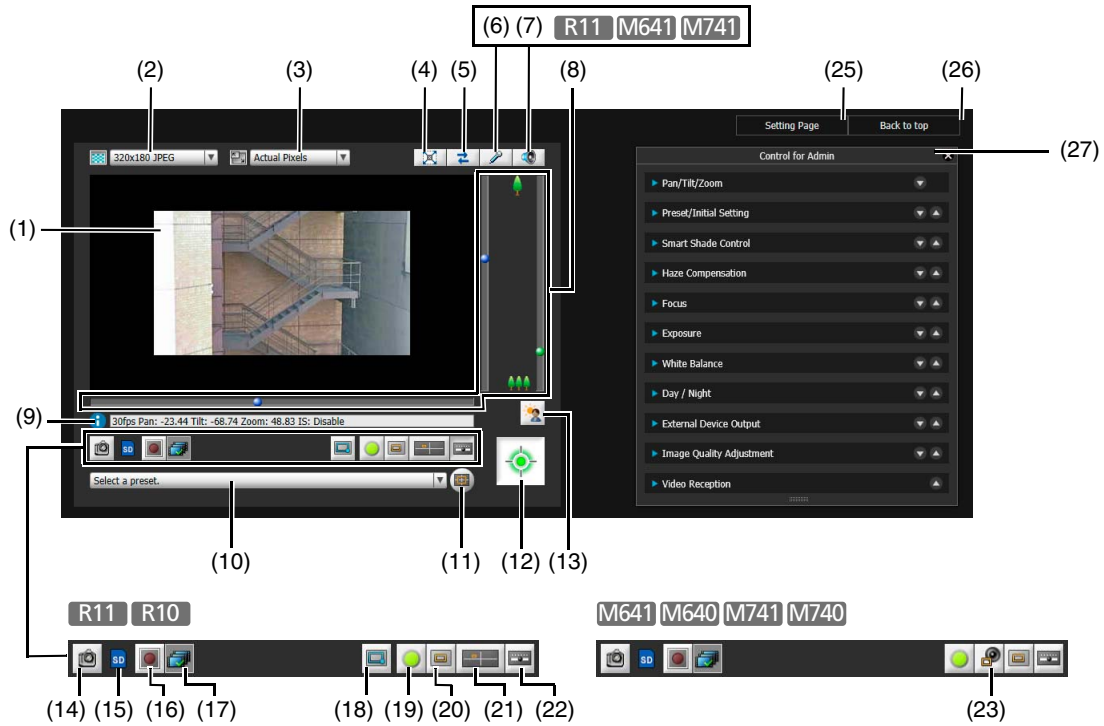

Admin Viewer

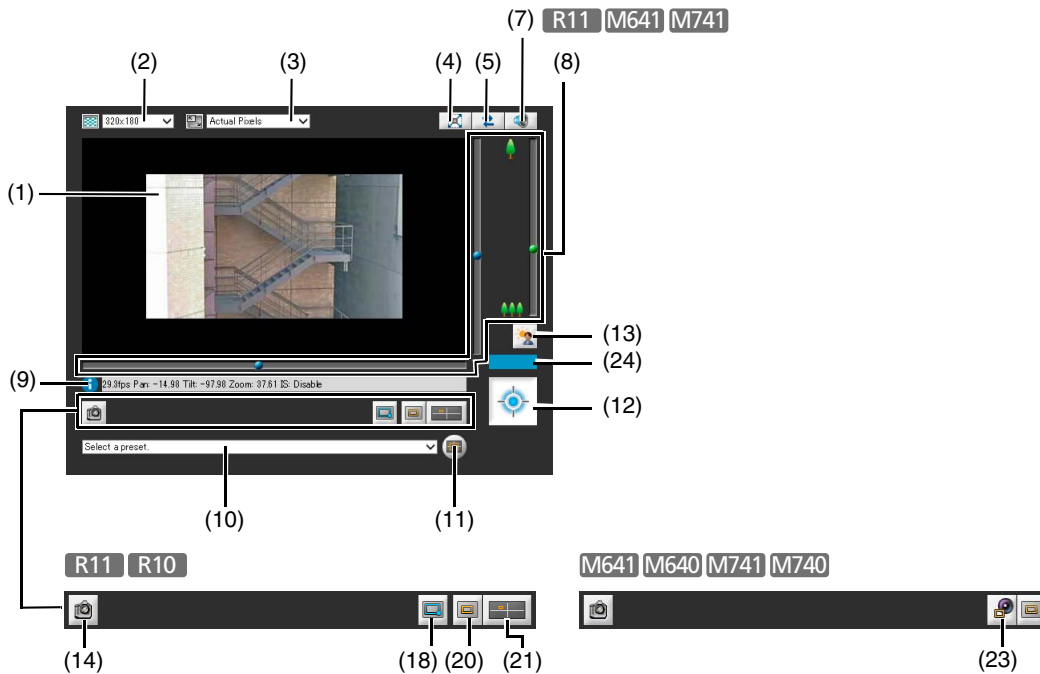

VB Viewer



- (1) **Video Display Area**
Displays video received from the camera.
- (2) **Video Size**
Set the size and format of video received from the camera (Admin viewer only) (P. 143).

- (3) **Video Display Size**
Set the display size of the video shown on the screen (P. 144).
- (4) **[Full Screen Mode] Button**
Video is displayed in full screen mode (P. 144).
- (5) **[Reconnect] Button**
Reconnects to the camera.
- (6) **[Audio Transmission] Button** **R11** **M641** **M741**
Displays the Audio Transmission panel (P. 156).
- (7) **[Audio Reception] Button** **R11** **M641** **M741**
Displays the Audio Reception panel (P. 155).
- (8) **Use the pan, tilt and zoom sliders.**
Drag the sliders to pan (horizontally), tilt (vertically) or zoom in (telephoto)/zoom out (wide-angle) the camera (P. 148).
- (9) **Information Display**
Information messages, warning messages and error messages are displayed (P. 143).
- (10) **Preset Selection Menu**
Select presets registered to the camera (P. 154).
- (11) **[Home Position] Button**
Move the camera angle to the home position(P. 154).
- (12) **[Obtain/Release Camera Control Privileges] Button**
Obtain and release the camera control privileges (P. 147).
- (13) **[BLC] (Back Light Compensation) Button**
Turns on/off backlight compensation. This control is effective when the video is dark due to backlight (P. 155).
- (14) **[Snapshot] Button**
Open the snapshot panel and display a still image of the moment you clicked the button (P. 186).
- (15) **Memory card mount status icon**
Displays the camera's memory card mount status.
 : Memory card is mounted.
 : memory card is not mounted.
- (16) **[Memory Card Recording] Button**
Start and stop video recording to a memory card (P. 186). You can use this when a memory card is mounted and you have obtained camera control privileges.
- (17) **[Recorded Video Utility] Button**
Launches the Recorded Video Utility (P. 240).
- (18) **[Switch Area Zoom/Drag to Move] Button** **R11** **R10**
Switch between Area Zoom and Drag to Move functions for dragging in the video display area (P. 149).
- (19) **[Event Display] button**
Display the Event Display panel (P. 184).
- (20) **[Viewer PTZ] Button**
Displays the viewer PTZ panel (P. 151).
- (21) **[Panorama Display] Button** **R11** **R10**
Displays the panorama display panel (P. 151).
- (22) **[Control for Admin] Button**
Displays the Control for Admin panel (P. 158).
- (23) **[Digital PTZ] Button** **M641** **M640** **M741** **M740**
Display the Digital PTZ panel (P. 153).
- (24) **Control Privilege Display**
Displays the control privileges retention status (P. 188).
- (25) **[Setting Page]**
The screen switches to the Setting Page.

(26) [Back to top]

The screen switches to the top page of the camera.

(27) Admin Control Panel

Allows various camera operations with administrator privileges (P. 158).

Check Information

Information, such as the frame rate, camera pan/tilt/zoom values and descriptions of each function, appears in the Information Display.

Warnings and error message will also appear here if there are problems with camera operations or systems.

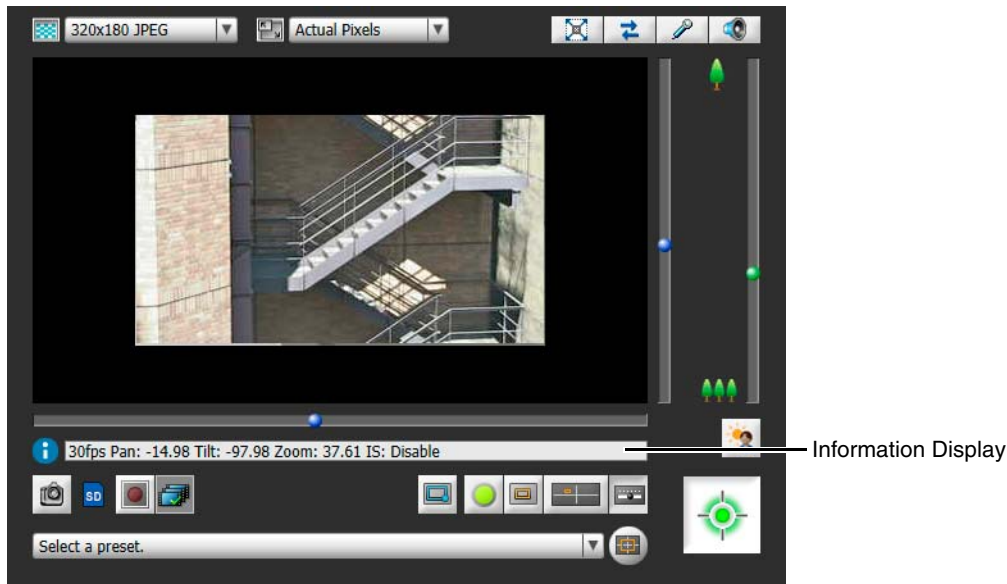

For details on the information displayed, please refer to “List of Viewer Messages” (P. 269).

Important

- When [Camera] > [Camera Settings] > [Camera Control] > [Image Stabilizer] (P. 75) is enabled on the Setting Page, the actual angle of view of the video will be smaller than the pan/tilt/zoom values shown in the Information Display.

R11 R10

- The actual angle of view will also be smaller than the angle of view (frame) (P. 151) displayed in the panorama display panel.

Change the Video Size and Display Screen Size

You can set the video size to receive from the camera and the size to display on the computer screen.

Change the Video Size

Select the video size to receive from the camera with the video size setting in the upper left of the Viewer.

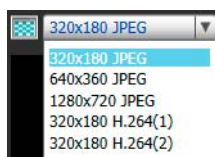

The sizes that can be selected depend on the setting in [Basic Settings] > [Video Settings] > [All Videos] > [Video Size Set] on the Setting Page (P. 72).

[Video Size Set] Setting	Selectable video size	
	JPEG	H.264*
1280x720 / 640x360 / 320x180	320x180 640 x 360 1280 x 720	<ul style="list-style-type: none"> The sizes set with [Video Size] in [Basic Settings] > [Video Settings] > [H.264(1)] or [H.264(2)] in the Setting Page (P. 73), determine the sizes displayed to the menu.
1280 x 960 / 640 x 480 / 320 x 240	320 x 240 640 x 480 1280 x 960	<ul style="list-style-type: none"> When [H.264(2)] is set to [Enable] in [Basic Settings] > [Video Settings] > [H.264(2)] in the Setting Page (P. 74), [H.264(1)] and [H.264(2)] video sizes are both displayed to the menu.

* When [Enable H.264 reception] is selected in [Control for Admin] > [Video Reception] (P. 168), H.264 video sizes will be added to the menu display.

Change the Display Screen Size

You can change the size of the video display area screen with the display size setting in the upper left of the Viewer.

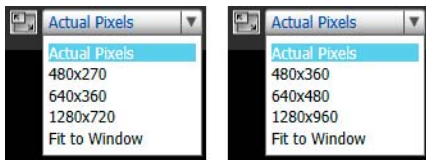

The sizes that can be configured depend on the setting in [Basic Settings] > [Video Settings] > [All Videos] > [Video Size Set] on the Setting Page (P. 72).

[Video Size Set] Setting	Selectable Screen Size	Remarks
1280x720 / 640x360 / 320x180	Actual Pixels 480 x 270 640 x 360 1280 x 720 Fit to Window	[Actual Pixels] displays the video at the size at which it is being captured. [Fit to Window] displays the video at the maximum size possible in the web browser window.
1280 x 960 / 640 x 480 / 320 x 240	Actual Pixels 480 x 360 640 x 480 1280 x 960 Fit to Window	

Displaying in Full Screen Mode

You can display the video display area in full screen mode by clicking the [Full Screen Mode] button in the upper right of the Viewer.

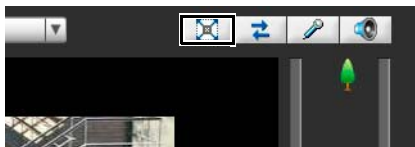

To exit full screen mode

Use the following methods to return normal display.

- Click  that appears in the lower right of full screen.
- Right-click on the screen and select [Exit Full Screen Mode] from the menu that appears.

Context Menu

While in full screen mode, right-click the mouse to open a menu necessary for camera control.

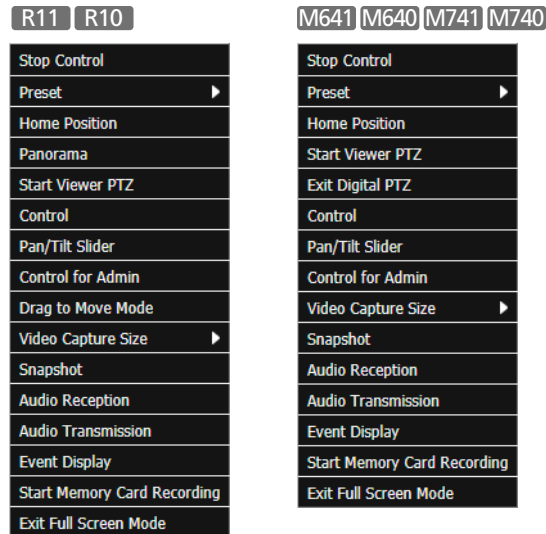

[Start/Stop Control]

Obtain and release the camera control privileges.

[Preset]

Select a preset.

[Home Position]

Move the camera angle to the home position.

[Panorama] R11 R10

Displays the panorama display panel.

[Start/Exit Viewer PTZ]

Displays the viewer PTZ panel.

[Start/Exit Digital PTZ] M641 M640 M741 M740

Display the Digital PTZ panel.

[Control]

Display a panel containing the zoom slider, [Backlight Compensation] button and [Obtain/Release Camera Control Privileges] button.

[Pan/Tilt Slider]

Display the pan and tilt sliders.

[Control for Admin]

Displays the Control for Admin panel.

[Drag to Move Mode/Area Zoom Mode] R11 R10

Switch between Area Zoom and Drag to Move functions for dragging in the video display area.

[Video Capture Size]

Switches the video capture size.

[Snapshot]

Take a snapshot.

[Audio Reception] R11 M641 M741

Displays the Audio Reception panel.

[Audio Transmission] R11 M641 M741

Displays the Audio Transmission panel.

[Event Display]

Display the Event Display panel.

[Start/Stop Memory Card Recording]

Start and stop video recording to a memory card.

[Exit Full Screen Mode]

Exit full screen mode.

Operate the Camera With Admin Viewer

This explains how to set the camera angle using the Admin Viewer. This also explains audio transmission/reception using an external device connected to the camera.

Obtain Camera Control Privileges

To use the camera, you must obtain control privileges with the Viewer.

If you have not yet obtained camera control privileges, click the [Obtain/Release Camera Control Privileges] button.

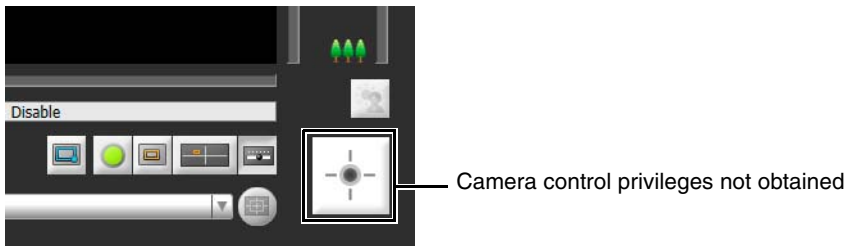

You will obtain control privileges and be able to use the buttons on the Viewer.

The center of the [Obtain/Release Camera Control Privileges] button turns green while you have control privileges.

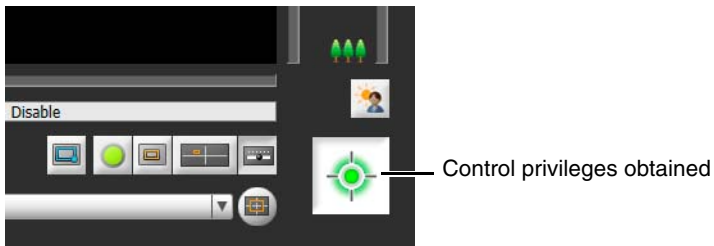

Important

- Multiple users cannot obtain control privileges simultaneously.
- If the Admin Viewer obtains control privileges while the VB Viewer has control privileges, the control privileges for the VB Viewer will be overridden.
- At any time, the administrator can launch the Admin Viewer to override the control privileges of another instance of the Admin Viewer launched by [Authorized User]. The administrator can retain the control privileges, but doing so prevents authorized users from obtaining control privileges. Once finished, the administrator should always exit the Viewer or click the [Obtain/Release Camera Control Privileges] button to release the control privileges.

Use Pan/Tilt/Zoom R11 R10

You can pan, tilt and zoom the camera to set the camera angle.

Note

- You must obtain control privileges to pan, tilt or zoom the camera.
- Camera operations performed by clicking or dragging will not be precise.
- Users operating the Admin Viewer with the administrator privileges can control the camera outside the view restrictions. Users operating the Admin Viewer with authorized user privileges can control the camera only within the view restrictions.

■ Click on the Video Display Area or Use the Sliders

Move by Clicking on the Video Display Area

If you click in the video display area, the camera angle will change to center on the mouse pointer location. If the camera angle does not center on the desired location with a single click, repeat the operation.

Note

While using the Viewer PTZ, clicking on the video display area does not work.

Move Using the Sliders

Drag the pan and tilt sliders to pan and tilt the camera.

Drag the zoom slider to zoom the camera.

The slider can also move by clicking directly on the slider bar..

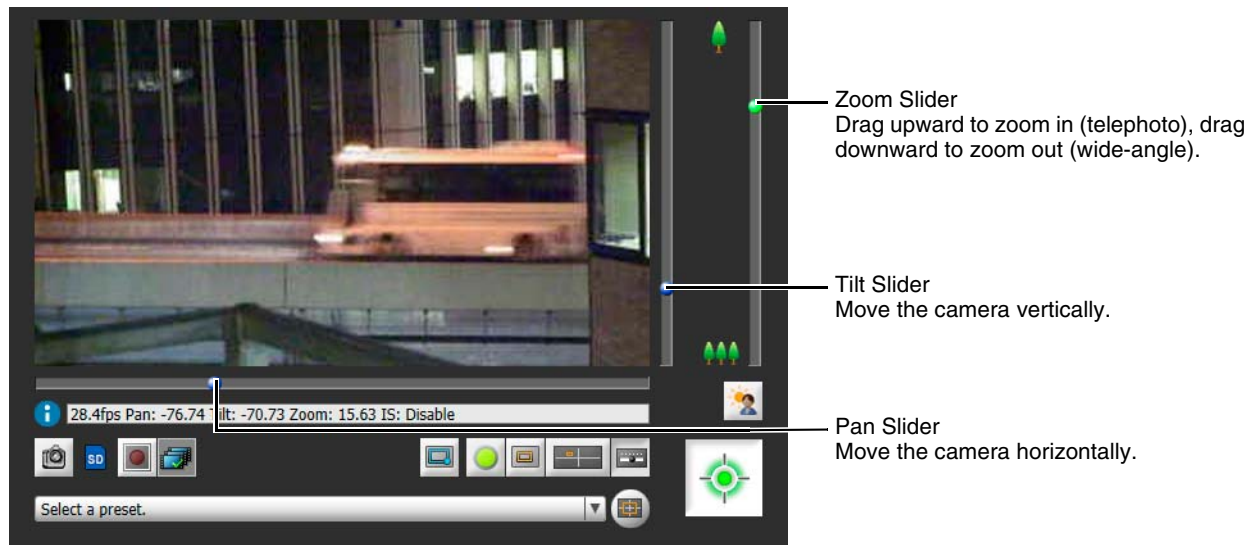

Slider When Using Digital Zoom

If you set [Camera] > [Camera Settings] > [Camera Control] > [Digital Zoom] to [Enable] on the Setting Page, the digital zoom range will appear on the zoom slider and you will be able to use digital zoom.

Note

The higher the digital zoom ratio, the lower the video quality.

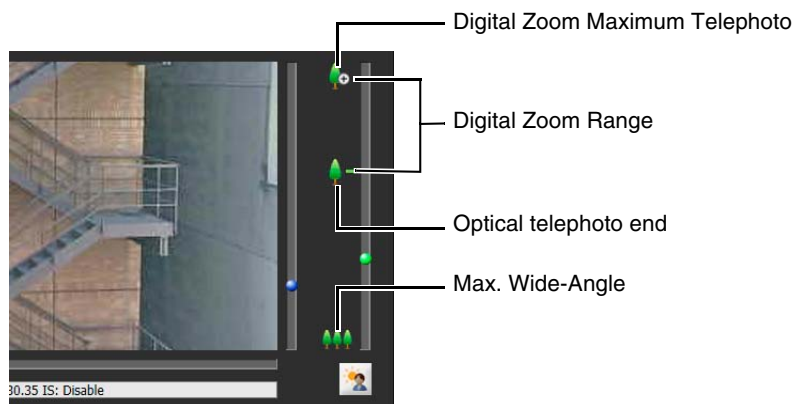

■ Use [Pan/Tilt/Zoom] in Control for Admin

You can pan, tilt and zoom the camera with [Control for Admin] > [Pan/Tilt/Zoom].

1 Display Control for Admin (P. 158).

2 Click [Pan/Tilt/Zoom].

The [Pan/Tilt/Zoom] controls appears.

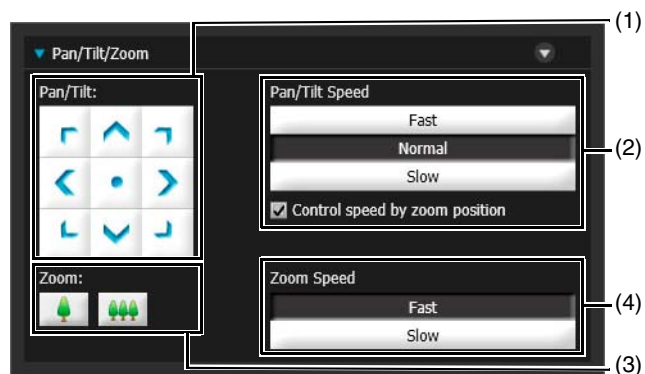

(1) [Pan/Tilt]

The camera angle will change in the direction of each arrow. Operation will continue while you hold the button down and stop when you release it.

Click the center button to center the camera at 0° pan, 45° tilt (When upright. -45° when ceiling mounted).

(2) [Pan/Tilt Speed]

Select the pan/tilt speed when using the [Pan/Tilt] buttons.

[Control speed by zoom position]

When selected, the pan/tilt speed will be slower in the telephoto zoom range, and faster in wide-angle zoom range.

Note

You can select this when [Camera] > [Camera Settings] > [Camera Control] > [Pan/Tilt Speed Control] (P. 76) is set to [Control at set speed]. If [Pan/Tilt Speed Control] is set to [Control by zoom position], [Control speed by zoom position] cannot be deselected.

(3) [Zoom]

Click the buttons to zoom in and zoom out. Operation will continue while you hold the button down and stop when you release it.

(4) [Zoom Speed]

Select the zoom speed when using the [Zoom] buttons.

Note

The pan/tilt/zoom operation speed using the sliders and the panorama display will not change even if you change the [Pan/Tilt Speed] or [Zoom Speed] settings.

Use Area Zoom/Drag to Move

You can drag on the video display area to zoom in and out, and change the camera angle.

Note

You cannot not use Area Zoom or Drag to Move when using Viewer PTZ.

Use Area Zoom to Zoom In and Out

- 1 Click the [Switch Area Zoom/Drag to Move] button to enter Area Zoom () mode.





- 2 Drag out a rectangle in the video display area.

Drag left-to-right to define an area to zoom in on.

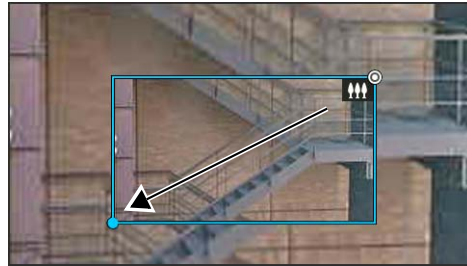
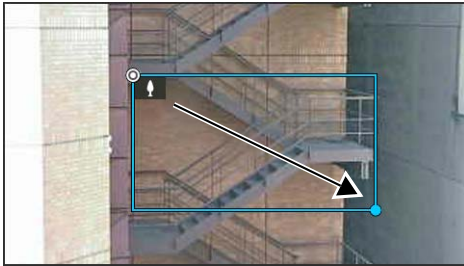
Drag right-to-left to draw out a rectangle in which will appear a preview of the video display area that will be zoomed out to.



When operating in Area Zoom mode, an icon (zoom in: ; zoom out: ) appears in the rectangle. To stop Area Zoom, right-click while holding the left button while the rectangle is displayed.

- 3 Release the mouse button.

When dragged left-to-right, the camera will zoom in until the area in the rectangle fills the video display area. When dragged right-to-left, the camera will zoom out, centered around the area in the rectangle.

Use Drag to Move to Change the Camera Angle

- 1 Click the [Switch Area Zoom/Drag to Move] button to enter Drag to Move () mode.



- 2 In the video display area, drag in the direction you would like to change the camera angle. An arrow will appear.

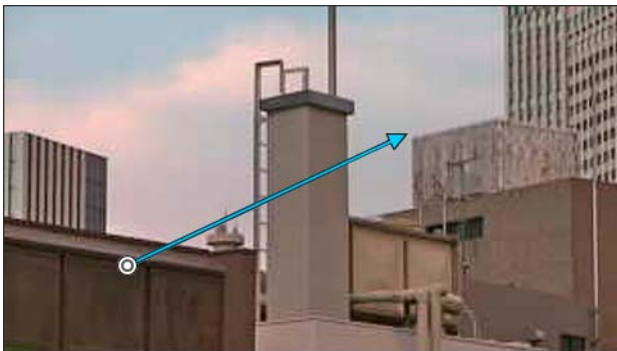

The camera angle will move in the direction of the arrow.

Movement speed increases with the length of the arrow. The maximum length of the arrow is half the width and height of the video display area, and corresponds with the maximum movement speed.

Note

- The direction of the arrow will not change even when using Auto Flip (P. 76).
- When using Drag to Move, the sliders will not move while the cameras moves.

3 Release the mouse button.

The camera will stop.

Operate Camera With Panorama Display Panel

You can operate the camera using the frames within the panorama display area.

To use a panorama image in the panorama display panel, you must create the image and save it to the camera (P. 201).

1 Click the [Panorama Display] button.



The panorama display panel appears.

2 Use the frame in the panorama display panel to pan/tilt/zoom the camera.

The frame indicates the area being captured by the current camera.



Move or Zoom by Dragging

Click inside the frame and drag it to pan and tilt the camera.

If you click and drag outside the frame, a new frame will be drawn. The camera will pan/tilt/zoom to capture the area in the frame.

If you drag an edge of the frame to change its size, the camera will zoom in or out to capture the area in the frame.

Move by Clicking

If you click outside the frame, the frame will move and center on that point, panning and tilting the camera.

Magnify and Display Part of Video (Viewer PTZ)

User the Viewer PTZ to magnify part of a video (using digital zoom) without moving the camera.

When you do not want to move the camera to pan, tilt or zoom, this still allows you to take advantage of functions, such as the Intelligent Function.

Important R11 R10

While using the Viewer PTZ, you cannot operate the camera by clicking or dragging in the video display area.

Note

- You cannot record the video magnified with the Viewer PTZ.
- You can display the magnified video in full screen mode when using the Viewer PTZ.

- 1 Click the [Viewer PTZ] button.

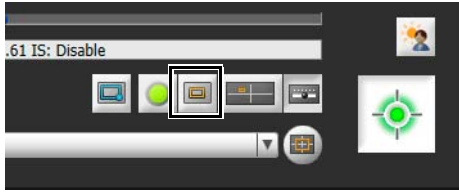

The Viewer PTZ panel appears.
Initially, the preview frame (orange) surrounds the entire video.

- 2 In the Viewer PTZ panel, drag an edge of the preview frame to make it smaller.

The video of the area inside the preview frame is magnified to fill the video display area.

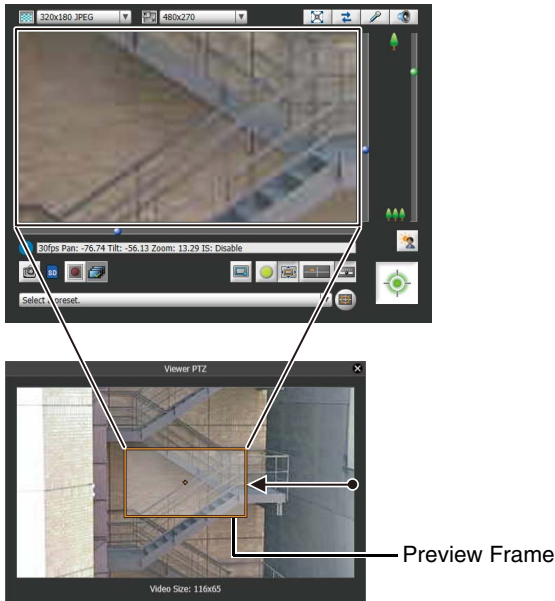

- 3 Move the frame to the area you would like to magnify and resize the frame as desired.

Move or Resize by Dragging

Press the mouse button inside the frame and drag it to move the preview frame.
If you press the mouse button and drag outside the frame, a new preview frame will be drawn.
You can resize the preview frame by dragging an edge of the frame.

Move by Clicking

If you click outside the frame, the preview frame will move and center on that point.

Move Using the Sliders **M641** **M640** **M741** **M740**

You can use the pan, tilt and zoom sliders in the video display area to move the preview frame.

Note

The Viewer PTZ uses digital zoom, so the higher the digital zoom ratio, the lower the quality of the video.

Exiting Viewer PTZ

When you click the [Viewer PTZ] button while using the Viewer PTZ, the Viewer PTZ panel closes and you exit the Viewer PTZ.

Note

- If you close the Viewer PTZ panel without exiting the Viewer PTZ, the view in the video display area will remain magnified. However, when you reconnect to the Admin Viewer, the initial state will be restored.

- The [Viewer PTZ] button display will change as follows depending on whether or not you are using the Viewer PTZ.



You are not using the Viewer PTZ (video being received by the camera appears in the video display area)



You are using the Viewer PTZ (magnified video appears in the video display area)

Cropping and Displaying Part of an Image (Digital PTZ) M641 M640 M741 M740

You can use the Digital PTZ panel to crop and display part of a camera image in the image display area. It is also possible to use a preset or home position registered to the camera.

Digital PTZ

Digital PTZ is a function that allows easy panning, tilting, and zooming by transmitting only a part of the camera effective pixel area without moving the camera lens position that was adjusted during camera installation.



Note

If Digital PTZ is enabled while receiving H.264 video, the received video changes to JPEG format.

Differences Between Digital PTZ and Viewer PTZ

Digital PTZ and Viewer PTZ are both functions allowing easy panning, tilting and zooming using the digital zoom, but they have the following differences because they employ different operating principles.

Digital PTZ M641 M640 M741 M740	Viewer PTZ
Transmits only the cropped part of the entire area that can be captured by the camera.	Enlarges the specified part of the video transmitted from the camera and then displays it in the viewer.
The size of the received data is small.	The size of the received data is large.
Independent operation cannot be performed by each Viewer. If multiple Viewers are connected, the same Digital PTZ display is applied to the other Viewers.	PTZ operation can be performed independently for each Viewer.

Crop Video With Digital PTZ Panel

- 1 Click the [Digital PTZ] button.

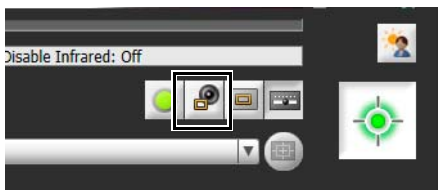

The Digital PTZ panel appears.

- 2 In the Digital PTZ panel, move and resize the preview frame.

The preview frame operations are the same as with the Viewer PTZ (P. 152).

The preview frame size can be set to any of 5 sizes. The screen sizes that can be selected change as follows depending on the setting in [Basic Settings] > [Video Settings] > [All Videos] > [Video Size Set] on the Setting Page.

- [1280 x 720 / 640 x 360 / 320 x 180] selected: 640x360, 512x288, 384x216, 256x144, 128x72
- [1280 x 960 / 640 x 480 / 320 x 240] selected: 640x480, 512x384, 384x288, 256x192, 128x96



Note

The preview frame will move in steps. Fine-tuned movement is not possible.

The video of the area inside the manipulated preview frame is magnified to fill the video display area.



Note

The Digital PTZ uses digital zoom, so the higher the digital zoom ratio, the lower the video quality.

Using Presets or the Home Position

You can use a registered preset or home position to specify the range for Digital PTZ.

Select a preset from the preset selection menu (P. 142) to move the preview frame on the Digital PTZ panel to the preset position and display the video inside the frame in the video display area.

Click the [Home Position] button to move the preview frame on the Digital PTZ panel to the home position and display the video inside the frame in the video display area.

Note

Register presets and the home position beforehand in [Control for Admin] (P. 170).

Exiting Digital PTZ

When you click the [Digital PTZ] button while using the Viewer PTZ, the Digital PTZ panel closes and you exit Digital PTZ.

Note

- If you close the Digital PTZ panel without exiting Digital PTZ, Digital PTZ continues to operate. However, when you reconnect to the Admin Viewer, the initial state will be restored.
- The [Digital PTZ] button display will change as follows depending on whether or not you are using Digital PTZ.



You are not using Digital PTZ (video being received by the camera appears in the video display area)



You are using Digital PTZ (cropped video appears in the video display area)

Using Presets or the Home Position

It is possible to control the camera using a preset or home position registered to the camera in advance.

When you click the preset selection menu and select a preset from the list that appears, the camera will move to the camera angle of the selected preset.

Clicking the [Home Position] button will move the camera angle to the home position.

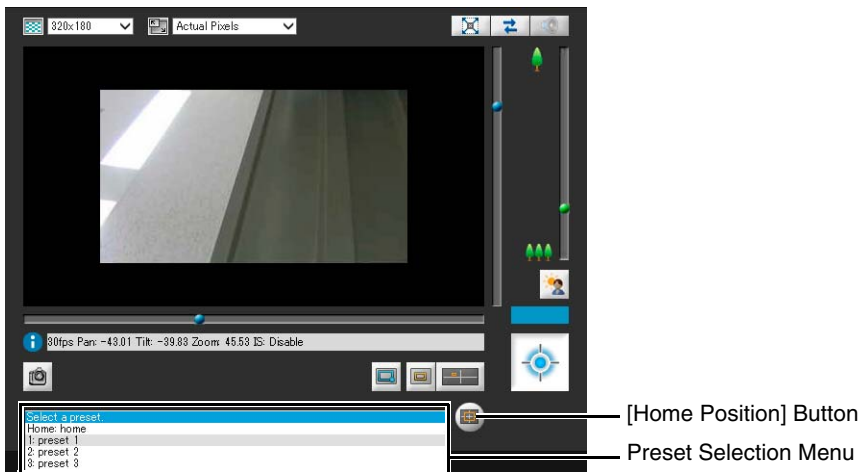

Note

Register presets and the home position beforehand with [Preset Registration] tab in [Control for Admin] > [Preset/Initial Setting] > [Preset Setting] (P. 170). The registered preset will appear in the preset selection menu.

Use Backlight Compensation

Click [BLC] to brighten video that is dark due to backlight.



Click the button again to cancel backlight compensation.

Important

- The [BLC] button is not available if [Smart Shade Control] (P. 159) is set to [Auto].
- The [BLC] button is not available if [Exposure] (P. 162) is set to [Manual].

Note

Use Smart Shade Control (P. 159) if over-exposure of highlights is prominent in the video.

Receive/Transmit Audio R11 M641 M741

Receive audio from the camera, transmit audio from the Viewers and configure the respective volume settings.

Note

When you are using Internet Explorer 11 in a 64-bit operating system and the camera is registered as a trusted site and protected mode is enabled, reception and transmission of audio will be disabled.

Receive Audio

Receive audio from the microphone connected to the camera and play it back in the Viewer.

- 1 Click the [Audio Reception] button.

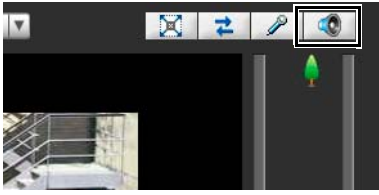

The Audio Reception panel appears.

- 2 Select [Receive audio].

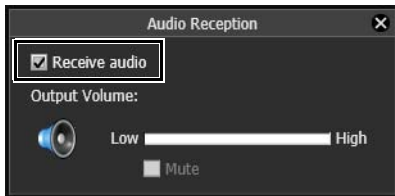

Use the [Output Volume] slider to adjust the volume as needed.

The [Audio Reception] button icon will change to  while receiving audio.

Note

- To receive audio, you must set [Server] > [Audio Server] > [Audio Transmission from the Camera] to [Enable] in the Setting Page beforehand (P. 92).
- The first time the Audio Reception panel is opened with the VB Viewer, a message to install the “Canon Network Camera Audio Receiver” add-on will appear in the information bar of the web browser. Install the add-on.
- If you select [Receive audio] in the Audio Reception panel, you will continue to receive audio even if you close the panel.
- To use the audio function in environments that use a proxy server, select in Internet Explorer [Use a proxy server for your LAN] in [Internet options] > [Connections] tab > [LAN settings] > [Proxy server], then specify the camera IP address in [Advanced] > [Exceptions].
- If you click  ([Reconnect] button) and reconnect, audio reception will stop and camera control will be released.

Transmit Audio

You can use the Admin Viewer to transmit audio received from an external device connected to the computer to a speaker with an amplifier connected to the camera.

- 1 Click the [Audio Transmission] button.

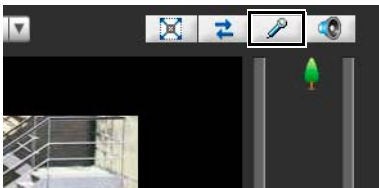

The Audio Transmission panel appears.

- 2 Click the microphone button.

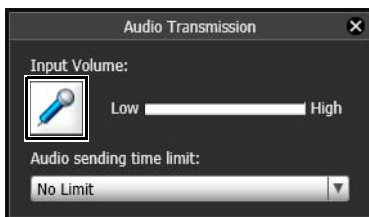

Audio transmission starts.

Use the [Input Volume] slider to adjust the volume as needed.

The [Audio Transmission] button icon will change to  while transmitting audio.

3 Select the amount of time to transmit audio with [Audio sending time limit].

Note

- To transmit audio, you must set [Server] > [Audio Server] > [Audio Reception from Viewer] to [Enable] in the Setting Page beforehand (P. 92).
- Audio transmission will continue even if you close the Audio Transmission panel.
- To use the audio function in environments that use a proxy server, select in Internet Explorer [Use a proxy server for your LAN] in [Internet options] > [Connections] tab > [LAN settings] > [Proxy server], then specify the camera IP address in [Advanced] > [Exceptions].
- Only [Administrator] can transmit audio from the Viewer.

Use Control for Admin

You can use the Control for Admin panel to operate the camera, configure video quality and reception settings, register presets and perform other tasks.

By clicking [Initial Setting Registration] in [Preset/Initial Setting] (P. 159), you can apply the settings in Control for Admin to each of the setting items in [Camera] > [Initial Setting] (P. 79) in the Setting Page. Additionally, settings configured in [Initial Setting] in the Setting Page will be applied to each setting item in [Control for Admin].

Control for Admin Panel

■ Display Control for Admin Panel

If the Control for Admin panel is closed, obtain camera control privileges and click the [Control for Admin] button.



The Control for Admin panel appears.

■ Note

You can open the various control items even without obtaining camera control privileges, but you will only be able to configure settings for the [Preset/Initial Settings] and [Video Reception] items.

■ Open/Close and Move Control Items

Click the title of a control item to open or close it.

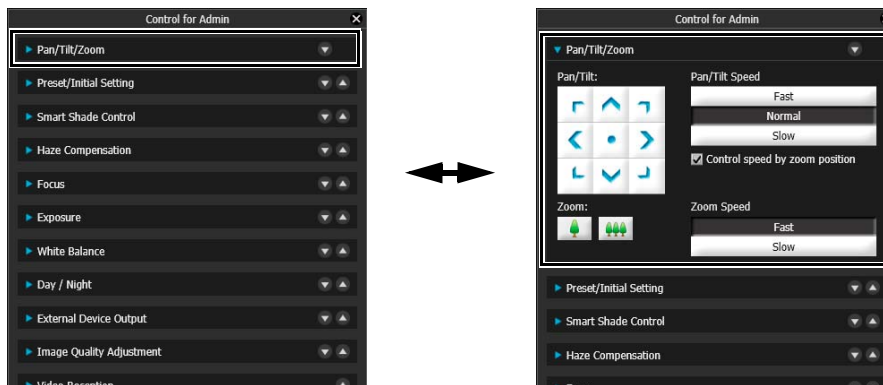

You can also reorder control items using the up/down buttons.

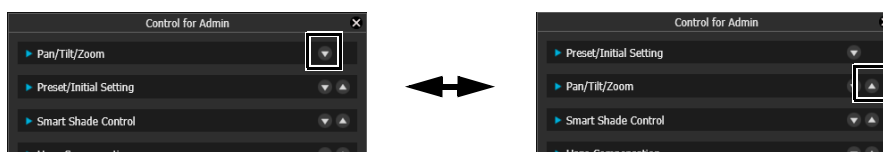

Pan / Tilt / Zoom R11 R10

Pan, tilt and zoom the camera, as well as configure the speed settings for those operations.
For details, please refer to “Use [Pan/Tilt/Zoom] in Control for Admin” (P. 148).

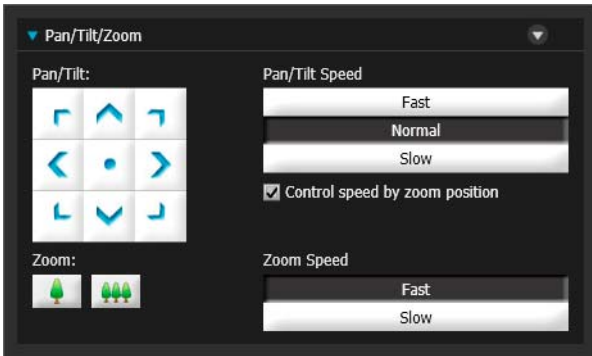

Preset / Initial Setting Registration

■ Preset Setting

Register presets and the home position, configure the preset tour route and preset auto control settings.
For details, please refer to “Register Presets” (P. 170).

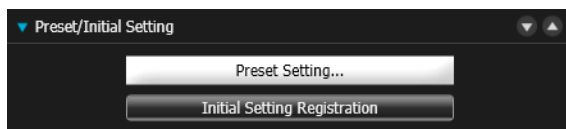

■ Initial Setting Registration

When you click [Initial Setting Registration], each of the current settings for the items in Control for Admin, except the following items, will be registered to [Camera] > [Initial Setting] in the Setting Page.

- [Video Reception]
- [External Device Output] R11 M641 M741

A confirmation message appears, when you click [Initial Setting Registration].

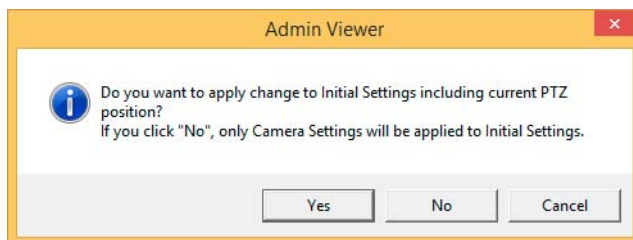

If [yes] is clicked, the present pan/tilt/zoom position, as well as the camera settings, are registered. If [No] is clicked, only the present camera setting values are registered. If [cancel] is clicked, nothing is registered, and the message is closed.

Smart Shade Control

If the background is bright and the subject is hard to see, this function brightens dark areas without affecting bright areas to make the subject easier to see.

This is different than Backlight Compensation (P. 155). This function suppresses over-exposure of highlights while compensating for under-exposure in dark areas of the video.

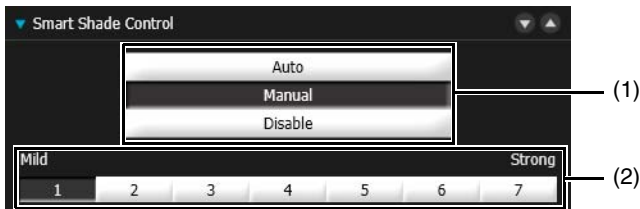

(1) Smart Shade Control Modes

[Auto]

Combines Smart Shade Control and Exposure Compensation to automatically adjust the video so that there are no over-exposed or under-exposed areas.

[Manual]

Use buttons in (2) to manually set the compensation strength.

[Not used]

Disables Smart Shade Control.

Important

- [Auto] cannot be selected for [Smart Shade Control] if [Exposure] (P. 162) is set to [Manual].
- If you set [Haze Compensation] to [Auto] or [Manual], [Smart Shade Control] is set to [Disable].

(2) Smart Shade Control level

When Smart Shade Control is set to [Manual], set a compensation level.

Note

- When [Auto] or [Manual] is selected for Smart Shade Control, the video data size increases.
- When [Manual] is selected for Smart Shade Control, setting a high compensation level may increase video noise. If noise is noticeable, lower the control level.

Haze Compensation

If the subject is obscured by haze, this adjusts contrast in the video to improve subject visibility.

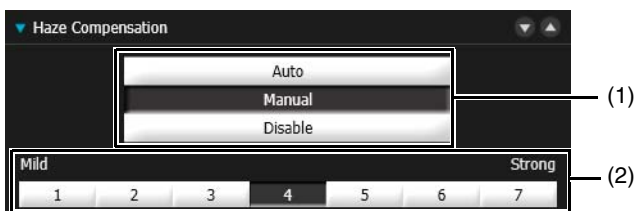

(1) Haze Compensation Modes

[Auto]

Automatically uses Compensation Removal.

[Manual]

Use buttons in (2) to manually set the compensation strength.

[Not used]

Disables Haze Compensation.

(2) Haze Compensation Strength

When Haze Compensation is set to [Manual], set a strength level.

Important

If you set [Smart Shade Control] to [Auto] or [Manual], [Haze Compensation] is set to [Disable].

Note

- When [Auto] or [Manual] is selected for [Haze Compensation], the video data size increases.
- When using [Haze Compensation], contrast may be strong if the subject is not obscured by haze. If this happens, set [Haze Compensation] to [Manual] and set a lower Haze Compensation strength.

Focus



This focuses on the subject.



(1) [Auto]

Automatically focuses on the subject.

(2) [Manual]

 If you push and hold the (Far)  (Near) buttons, you can adjust the focus toward telephoto or wide-angle respectively.

When you click [One-shot AF], the camera will focus once using autofocus and then switch to manual focus.

(3) [Fixed at Infinity]

The focus is fixed at infinity where a camera focal point is unnecessary.

Important

- The focus set with the Admin Viewer will be applied to other users.
- Depending on the lighting used, focus may not be maintained when switching between [Day Mode] and [Night Mode]. Focus when switching Day/Night Mode can be set in the [Day/Night Mode Focus Settings] panel in the Admin Viewer (P. 165).
- If you select [Manual] for [Exposure] (P. 162) and set the shutter speed to [1/1 sec], focus will not be maintained with [Auto] and [One-shot AF] in [Focus]. If this occurs, use [Manual] to set the focus.
- Note that if you set the focus manually it will remain fixed.
- In conditions where an outdoor scene is captured from an indoor location through a glass window, the camera may focus on the glass if there is dust or water on the surface. Install the camera at the shortest possible distance from the glass surface.

Focus Ranges

The estimated focus ranges for [Auto] and [Fixed at infinity] depending on the [Day/Night] setting are shown in the following table.

Focus Mode	Day/Night Settings			
	Day Mode		Night Mode	
	Max. Wide-Angle	Max. Telephoto	Max. Wide-Angle	Max. Telephoto
Auto/Manual	0.3 m (12 in.) – infinity	2.0 m (6.6 ft.) – infinity	1.0 m (3.3 ft.) – infinity	2.0 m (6.6 ft.) – infinity
Fixed at Infinity	Fixed near infinity*			

* Using infrared illumination from an external device may throw the camera out of focus.

M641 M640 M741 M740

For details on focus ranges, please refer to the table on P. 55.

Note

- For details on difficult to focus subjects, please refer to “Difficult to Focus Subjects” (P. 55).
- It is recommended that you check that the camera is focused whenever you restart the camera or use One-shot AF.

Exposure

Set the exposure and shutter speed.

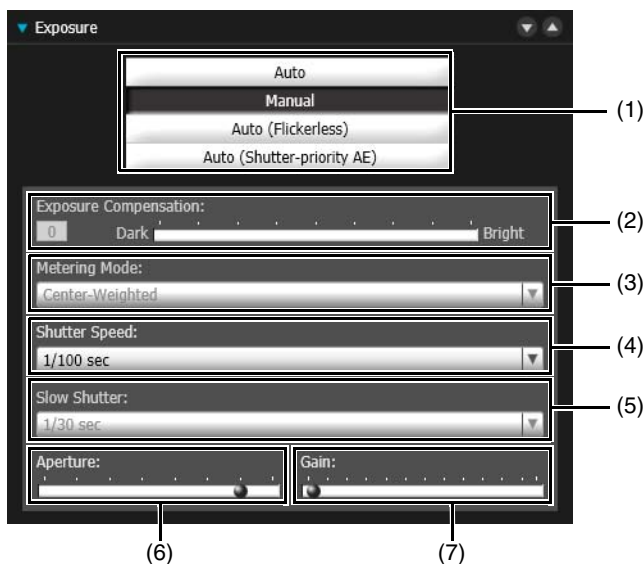

(1) Exposure mode

[Auto]

The exposure is controlled automatically.

[Manual]

The exposure is set by adjusting the shutter speed, aperture and gain manually.

This is not available if [Smart Shade Control] (P. 159) is set to [Auto].

[Auto (Flickerless)]

Shutter speed is adjusted automatically to suit the lighting conditions. Video flickering caused by fluorescent lights, etc., is reduced.

[Auto (Shutter-priority AE)]

The aperture is adjusted automatically to suit the specified shutter speed.

Note

If [Auto] is selected in [Camera] > [Initial Setting] > [Day/Night] on the Setting Page, select [Auto], [Auto (Flickerless)] or [Auto (Shutter-priority AE)] for [Exposure].

(2) [Exposure Compensation]

When you select [Auto], [Auto (Flickerless)] or [Auto (Shutter-priority AE)] for [Exposure], you can adjust the brightness of the video by using the slider to select the exposure compensation.

This is not available if [Smart Shade Control] (P. 159) is set to [Auto].

(3) **[Metering Mode]**

When you select [Auto], [Auto (Flickerless)] or [Auto (Shutter-priority AE)] for [Exposure], you can select the metering mode.

[Center-Weighted]

The entire scene is metered with an emphasis on the center.

Even when slightly darker/brighter areas are present on the periphery of the scene, an appropriate exposure can be achieved for the subject near the center.

Use this mode if the subject is positioned near the center of the screen.

[Average]

The entire scene is metered and averaged.

A stable exposure can be achieved even in a capture environment where there are notable brightness differences within the screen.

Use this mode to stabilize the exposure in scenes where vehicles or people are moving.

[Spot]

The center of the screen is metered.

An appropriate exposure can be achieved for the subject at the center of the screen regardless of the brightness/darkness on the periphery of the screen.

Use this mode if you want to adjust the exposure to the center of the screen because the subject is, for example, lit by a spotlight or backlit.

(4) **[Shutter Speed]**

When you select [Manual] or [Auto (Shutter-priority AE)] for [Exposure], you can select the shutter speed.

If [Manual] is selected, set the shutter speed in the range of [1/1 sec] to [1/16000 sec].

If [Auto (Shutter-priority AE)] is selected, set the shutter speed in the range of [1/2 sec] to [1/16000 sec].

When capturing a moving subject, selecting a higher shutter speed can reduce blurry video capture.

Setting a slow shutter speed may prevent Intelligent Function from working correctly. Select a shutter speed that suits the capture conditions and purpose.



Important

- If a traffic signal, electronic scoreboard, etc. is captured the video may flicker. In this case, try changing [Exposure] to [Auto (Shutter-priority AE)] and then select a shutter speed lower than 1/100, to please refer to if the situation improves.
- Setting a slow shutter speed may prevent Intelligent Function from working correctly. Select a shutter speed that suits the capture conditions and purpose.

(5) **[Slow Shutter]**

If you select [Auto] or [Auto (Flickerless)] for [Exposure], select the slowest shutter speed from the range [1/2 sec] to [1/30 sec].

Slower shutter speeds generate afterimages in video when capturing a moving subject.

(6) **[Aperture]**

If [Manual] is selected for [Exposure], set a desired aperture.

Moving the slider to the left closes the aperture and darkens the image. Moving the slider to the right opens the aperture and brightens the image.

(7) **[Gain]**

If [Manual] is selected for [Exposure], set the sensitivity to affect brightness.

Moving the slider to the left darkens the video, moving it to the right brightens video.

White Balance

Set the white balance according to the light source to achieve natural color in the video.

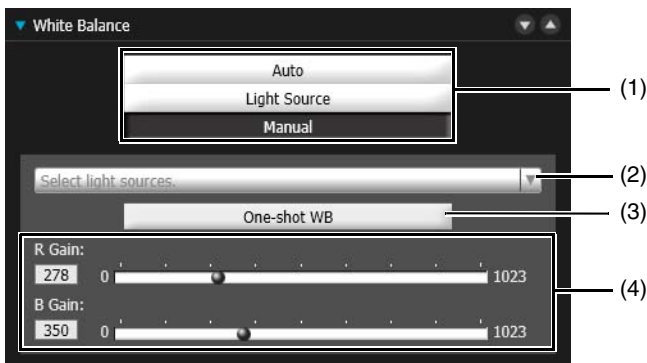

(1) White Balance mode

[Auto]

The white balance is adjusted automatically.



Important

- When the subject has only one color, is under low light conditions, or when sodium lamps, mercury lamps or certain other fluorescent lighting is used, [Auto] may not adjust colors appropriately.
- If [Auto] is set, and the subject appears greenish under mercury lamps, set white balance to [Light Source] and select [Mercury Lamp]. If the colors in the video are still not appropriate under mercury lamps even when you select [Mercury Lamp], use [One-shot WB].

[Light Source]

Select the light source from the pull-down menu in (2) to suit the camera usage.



Important

Since the light source selection options are based on representative characteristics, appropriate colors may not be achieved depending on the applicable light source. If this occurs, use the [One-shot WB] function.

[Manual]

Use (3) and (4) to manually adjust the white balance.

(2) Select a Light Source

If you select [Light Source] for the white balance, select a light source.

[Daylight Fluorescent]

Select this option to capture video under daylight fluorescent lighting.

[White Fluorescent]

Select this option to capture video under day white fluorescent or white fluorescent lighting.

[Warm Fluorescent]

Select this option to capture video under warm fluorescent lighting.

[Mercury Lamp]

Select this option to capture video under mercury lamps.

[Sodium Lamp]

Select this option to capture video under orange sodium lamps.

[Halogen Lamp]

Select this option to capture video under halogen lamps or incandescent bulbs.

(3) [One-shot WB]

If you set white balance to [Manual], this will force the white balance to match the light source and lock the setting.

Setting Method Example:

Illuminate a white subject (white paper, etc.) using the light source, making sure the subject fills the entire screen, and then use [One-shot WB].

(4) [R Gain], [B Gain]

If you set white balance to [Manual], use the sliders to set the Red and Blue gain values.

Important

- When [Day/Night] (P. 165) is set to [Night Mode] (including when it is set to [Auto] and Night Mode is judged to be applicable), the white balance function cannot be used.
- Notes on Capturing Video Continuously Day and Night
If a subject that seldom changes is captured in a location where the light source changes gradually, such as when capturing a subject continuously day and night, appropriate colors may not be achieved. In this case, applying changes to the image to capture will achieve the appropriate colors.

Day/Night

Set a capture mode suited to the brightness of the camera installation environment.

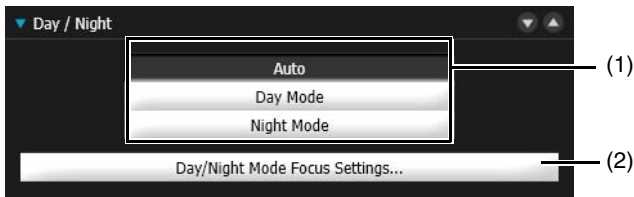

(1) Day/Night mode

[Auto]

The camera automatically determines ambient brightness and switches to Day Mode or Night Mode.

[Day Mode]

Captures normal color video.

[Night Mode]

Removes the infrared filter to increase sensitivity. Video turns to monochrome.

Important

- If you use [Auto], conduct a thorough operation test to check the effectiveness of the setting beforehand.
- If you use [Auto], set [Control for Admin] > [Exposure] (P. 162) to [Auto], [Auto (Flickerless)] or [Auto (Shutter-priority AE)]. Note that depending on the shutter speed when set to [Auto (Shutter-priority AE)], however, the mode may not switch to Night Mode even if [Auto] is selected.
- If you exit the Admin Viewer while [Day Mode] or [Night Mode] is set, these will remain in effect, even if [Camera] > [Initial Setting] > [Day/Night] is set to [Auto] in the Setting Page.
To enable [Auto], set [Day/Night] to [Auto] before exiting the Admin Viewer.
- If you use [Auto], the infrared filter may move several times while the mode is switching between Day Mode and Night Mode. You will not be able to use pan, tilt, zoom and manual focus during this period.
- If Night Mode will be used under infrared illumination, turn on the lighting before switching to Night Mode.

(2) [Day/Night Mode Focus Settings]

The focusing positions under normal lighting, such as fluorescent, and infrared illumination differ since the wavelengths of these light sources differ. For this reason, set the focus positions for when Day/Night Mode are switched.

This function can only be set when [Focus] is set to [Manual] (P. 161).

Click this to display the [Day/Night Mode Focus Settings] panel.

Important

- While making settings with the [Day/Night Mode Focus Settings] panel, it is not possible to make settings using the Admin Tools on another computer.
- Even if you use [Day/Night Mode Focus Settings], focus may not be maintained in Night Mode if the light source changes (e.g. sunlight added to infrared illumination).

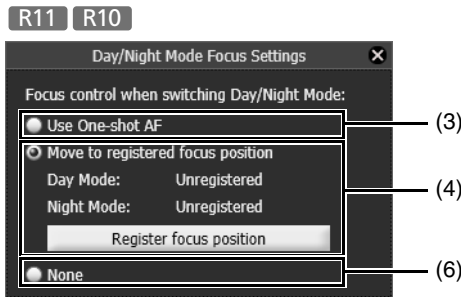
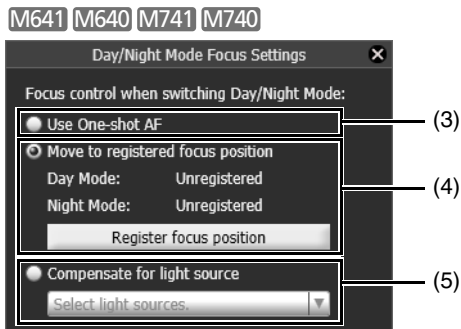

- (3) [Use One-shot AF]
This is the factory default setting. Select this to use One-shot AF when switching Day/Night Mode.

Important

When using [Use One-shot AF] and switching between Day/Night Mode, it may not be possible to focus on the intended subject if another subject, such as a person, passes in front at that time.

- (4) [Move to registered focus position]
When switching Day/Night Mode, the focus positions preregistered for Day Mode and Night Mode in [Register focus position] will be used. For details, please refer to “Register the Focus Positions” that follows.
- (5) [Compensate for light source] **M641 M640 M741 M740**
Select this option to adjust the focus position to suit the lighting being used when switching to Night Mode.
- [Fluorescent]
Select this option to capture video under fluorescent, LED, sodium or mercury lighting.
- [Halogen Lamp]
Select this option to capture video under halogen or incandescent lighting.
- [Infrared (740nm)]
Select this option to capture video under infrared (740 nm wavelength) illumination.
- [Infrared (850nm)]
Select this option to capture video under infrared (850 nm wavelength) illumination.
- [Infrared (940nm)]
Select this option to capture video under infrared (940 nm wavelength) illumination.
- (6) [None] **R11 R10**
When switching Day/Night Mode, the camera automatically focuses on each of the fluorescent lighting focus positions set beforehand for Day Mode and Night Mode.

Registering the Focus Positions

These are the steps to register the focus positions to use when switching Day/Night Mode mentioned in (4) earlier.

- 1** Display the [Day/Night Mode Focus Settings] panel.
- 2** Select [Day Mode] in Day/Night Mode (P. 165).

- 3 Under the lighting conditions of the Day Mode, adjust the focus position as required while watching the video.
- 4 Click [Register focus position] in the [Day/Night Mode Focus Settings] panel.
[Registered] will appear in [Day Mode:].
- 5 Switch Day/Night Mode to [Night Mode].
- 6 Repeat steps 3 and 4 under the Night Mode lighting conditions to register the focus position.
[Clear the registered focus position?] will appear if you select [Use One-shot AF] or [None], even if only one focus position has been registered for either [Day Mode] or [Night Mode].
If you select [No], the registered focus position will be retained even if you select to [Use One-shot AF] or [None].



Note

See the following for the focus ranges when using Day/Night Mode settings.

- "Focus Ranges" (P. 161) **R11** **R10**
- The table in the "Note" section of "Set the Focus" (P. 55) **M641** **M640** **M741** **M740**

Infrared **M741**

Set how infrared illumination is used.

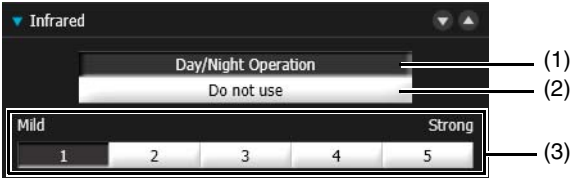

- (1) [Day/Night Operation]
Linked to Day/Night. Turns on infrared illumination in Night Mode.
- (2) [Do not use]
Infrared illumination is not used.
- (3) Infrared Illumination Strength
Sets the infrared illumination strength when [Day/Night Operation] is selected.



Important

Infrared illumination strength can only be set when [Exposure] (P. 162) is set to [Manual].



Note

If all or part of the image appears to have a white glow, there is a possibility that a wall (even a wall not in the image) is reflecting the infrared lighting. If this occurs, please adjust the camera angle.

External Device Output **R11** **M641** **M741**

Use external device output.
Click the icons to activate and deactivate output.



Output status is shown by the icons.
Screen Example:
Output 1: inactive
Output 2: active

Image Quality Adjustment

Adjust the quality of the video.

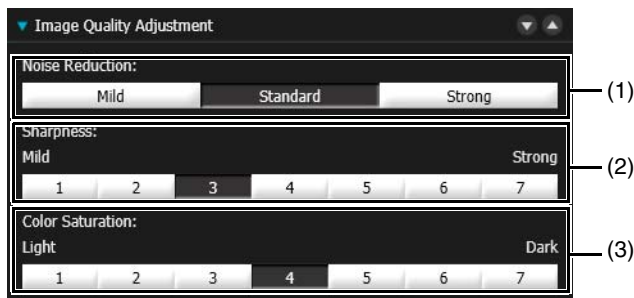

(1) [Noise Reduction]

Select a noise reduction level. This setting is generally more effective in low-light conditions.

When set to [Strong], the noise reduction effect is increased, but the afterimage of moving subjects becomes easier to see.

When set to [Mild], the noise reduction effect is decreased and resolution is increased, but the video file size becomes larger.

(2) [Sharpness]

Set a sharpness level.

When set toward [Strong] the video becomes sharper, and when set toward [Mild] the video becomes softer.

When set toward [Strong] the video file size becomes larger.

(3) [Color Saturation]

Set a color saturation level.

Video Reception

Video reception settings for the video display area.

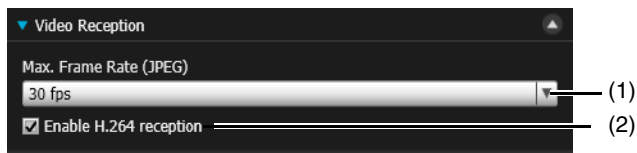

(1) [Max. Frame Rate (JPEG)]

You can select the maximum frame rate for JPEG video.

The setting is not selectable when displaying H.264 video in the video display area.

(2) [Enable H.264 reception]

Select to receive H.264 video.

The Software Product License Agreement dialog box appears. Click [Yes] to accept the terms of the license agreement. The decoder is downloaded from the camera, enabling H.264 video reception.

Note

When you are using Internet Explorer 11 in a 64-bit operating system and the camera is registered as a trusted site and protected mode is enabled, reception of H.264 video will be disabled.

About Presets

By registering settings as presets, such as camera angles, camera settings (e.g. exposure) and Day/Night Mode switching, the presets can be easily called up by Viewers to apply the settings.



Import **R11** **R10**

It is strongly recommended you register as presets, the positions Intelligent Function will use for the camera.

■ Using Presets

In addition to immediate display of registered camera angles when operating the viewer, you can use presets as follows.

- Execute the presets at predetermined times or during switches between Day Mode and Night Mode. (Auto Control Settings) (P. 177)
- Automatically cycle through multiple presets at a set time and in a predetermined sequence. (Tour Route Settings) (P. 179)
- When using the Intelligent Function, lock the monitoring position at a preset camera angle (P. 216). You can also automatically return to a preset position after Auto Tracking completes (P. 230). **R11** **R10**

Register Presets

Use the [Preset Registration] tab to register presets and the home position.

The number of presets you can register are as follows.

- Maximum 257 presets (including the home position). **R11** **R10**
- Maximum 21 presets (including the home position). **M641** **M640** **M741** **M740**

Important

- Reconfigure the presets if you change the [Camera] > [Camera Settings] > [Installation Conditions] > [Image Flip] (P. 78) settings on the Setting Page.
- Reconfigure the presets if you change [Video Settings] > [All Videos] > [Video Size Set] (P. 72) settings in the Setting Page.
- If you change the settings in [Camera Settings] > [Camera Control] > [Image Stabilizer] in the Setting Page (P. 75), the angle of view when using the camera will not match the angle of view when you configured presets. If you change [Image Stabilizer] settings, recheck the preset settings.

Note

- You cannot register presets/initial settings if the Panorama Creation Tool, Privacy Mask Setting Tool, View Restriction Setting Tool or Intelligent Function Setting Tool are running on a computer running Admin Viewer.
- You can only use one registered preset/initial setting on one computer.
- Only users with administrator privileges can register presets.

Display the Preset Setting Panel

If you click [Preset Setting] in [Control for Admin] > [Preset/Initial Setting], the Preset Setting panel will appear.

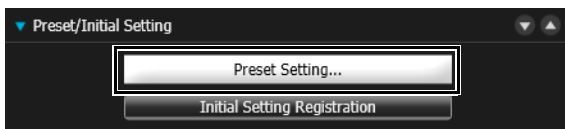

Note

The following panels will also appear with the Preset Setting panel.

- Panorama Display Panel **R11** **R10**
- Digital PTZ Panel **M641** **M640** **M741** **M740**

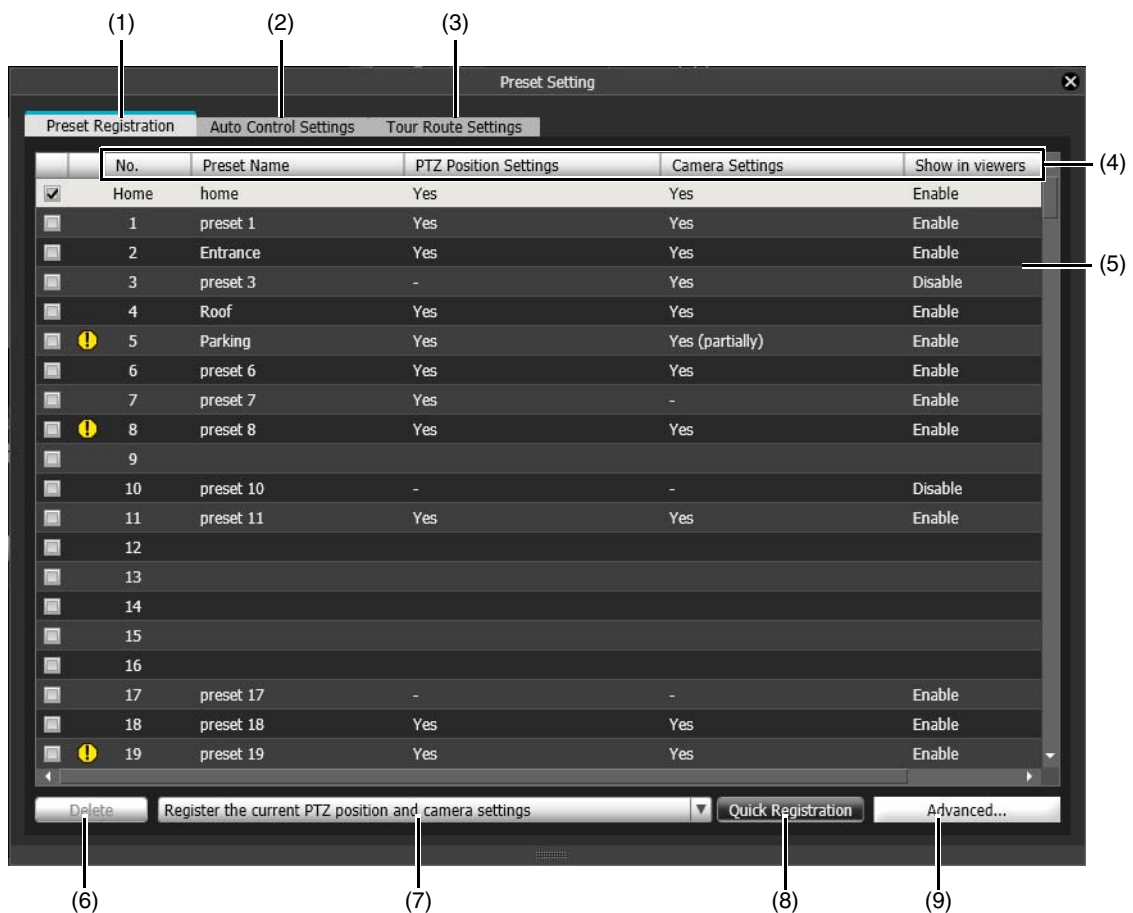

- (1) [Preset Registration] Tab
Registers presets.
- (2) [Auto Control Settings] Tab
Displays the Auto Control Settings panel (P. 177).
- (3) [Tour Route Settings] Tab
Displays the Tour Route Settings screen (P. 179).
- (4) Preset List Headers
The following items appear here. Click an item to sort the list.

[No.]

The number of the preset. If the position for the preset is outside the view restriction range, ⚠ (warning icon) will appear on the left.

[Preset Name]

Displays the registered preset name.

[PTZ Position Settings]

[Yes] appears if pan, tilt or zoom positions are registered in presets.

[Camera Settings]

[Yes] appears if camera settings (P. 174) are registered in presets, and [Yes (partially)] if only partial camera settings are registered.

[Show in viewers]

Shows whether presets are set to be selectable in the Viewers.

[Enable] appears when using [Quick Registration] or for presets that were registered with [Show in viewers] selected in the [Advanced Preset Settings] panel (P. 173).

- (5) Preset List
Presets appear in a list. If you double-click a registered preset in the list, you can also check that preset in the video display area.

- (6) [Delete]
Delete the selected preset. [Home] (home position) cannot be deleted.
- (7) Items to Register Menu
Select the setting to register with [Quick Registration] (P. 172).
- (8) [Quick Registration]
Registers the settings selected in [Items to Reg.] in presets (P. 173).
- (9) [Advanced]
Displays the [Advanced Preset Settings] panel (P. 173).

Use [Quick Registration]

- 1 Use the Viewer to display the camera angle in the video display area that you want to register.

Note

You can also use the following panels to change the camera angle.

- Panorama Display Panel **R11** **R10**
- Digital PTZ Panel **M641** **M640** **M741** **M740**

- 2 Configure the video with [Control for Admin] if necessary.

- 3 On the preset list, select the number of the preset to register, then select the items in [Items to Reg.] to register in the preset.

Select [Home] to set the home position.

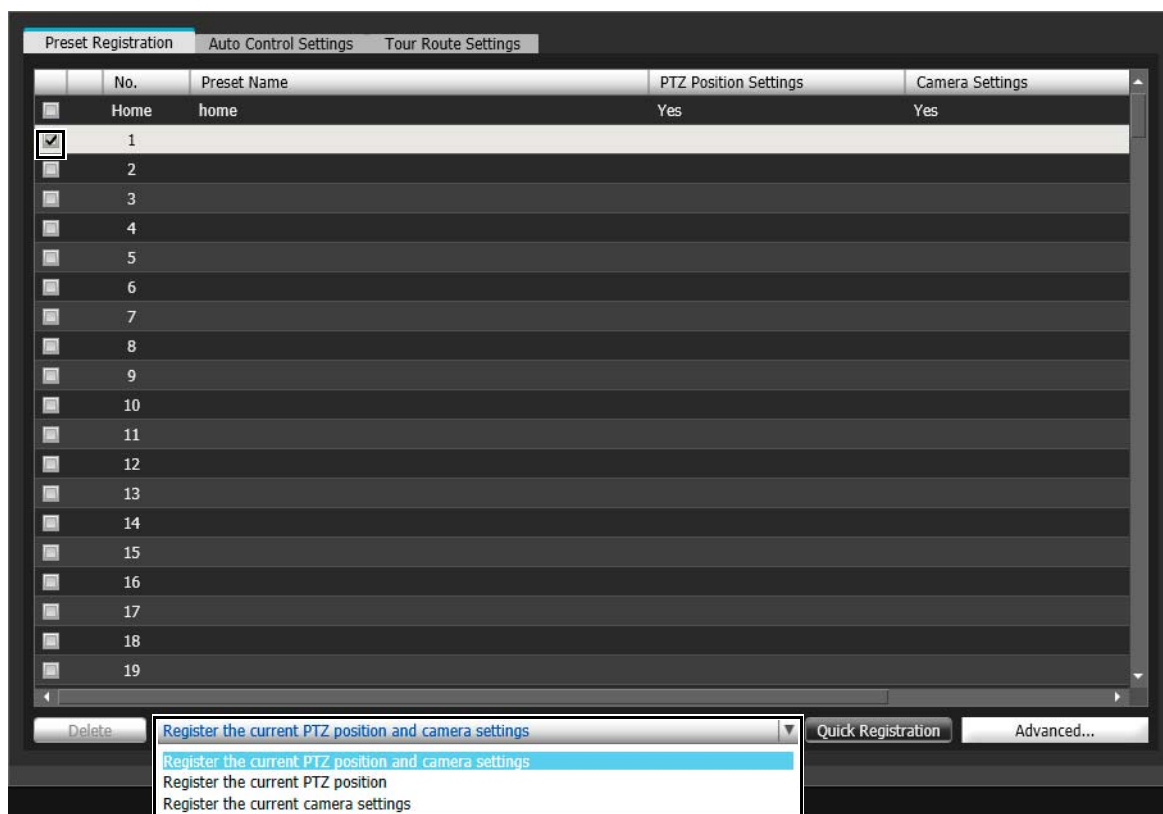

You can register the following information.

Current PTZ Positions

The current pan, tilt and zoom positions displayed in the video display area.

Current Camera Settings

Current settings for items in Control for Admin excluding the following items.

- [Pan/Tilt/Zoom] **R11** **R10**
- [Video Reception]

- [External Device Output] **R11** **M641** **M741**

4 Click [Quick Registration]

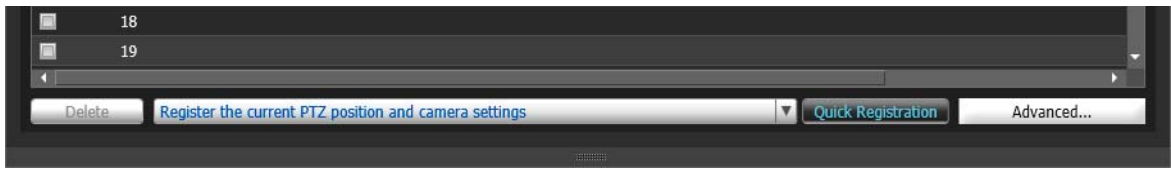

The items selected in [Items to Reg.] for the selected preset numbers will be registered.

Note

- The preset number will be appended to the preset name.
If you want to set your own preset name from the start, click the [Advanced] button instead of the [Quick Registration] button and follow the steps below for registration.
- If you select a registered preset and click [Quick Registration], the preset settings will be exchanged with the current camera angle and settings.
- Presets set with [Quick Registration] will be selectable in the Viewers.

Register with [Advanced Preset Settings] Panel

You can use the [Advanced Preset Settings] panel to arbitrarily name presets, load camera information to configure advanced preset settings and perform other tasks.

- 1 Select a preset for registering advanced settings from the preset list.
- 2 Click the [Advanced].

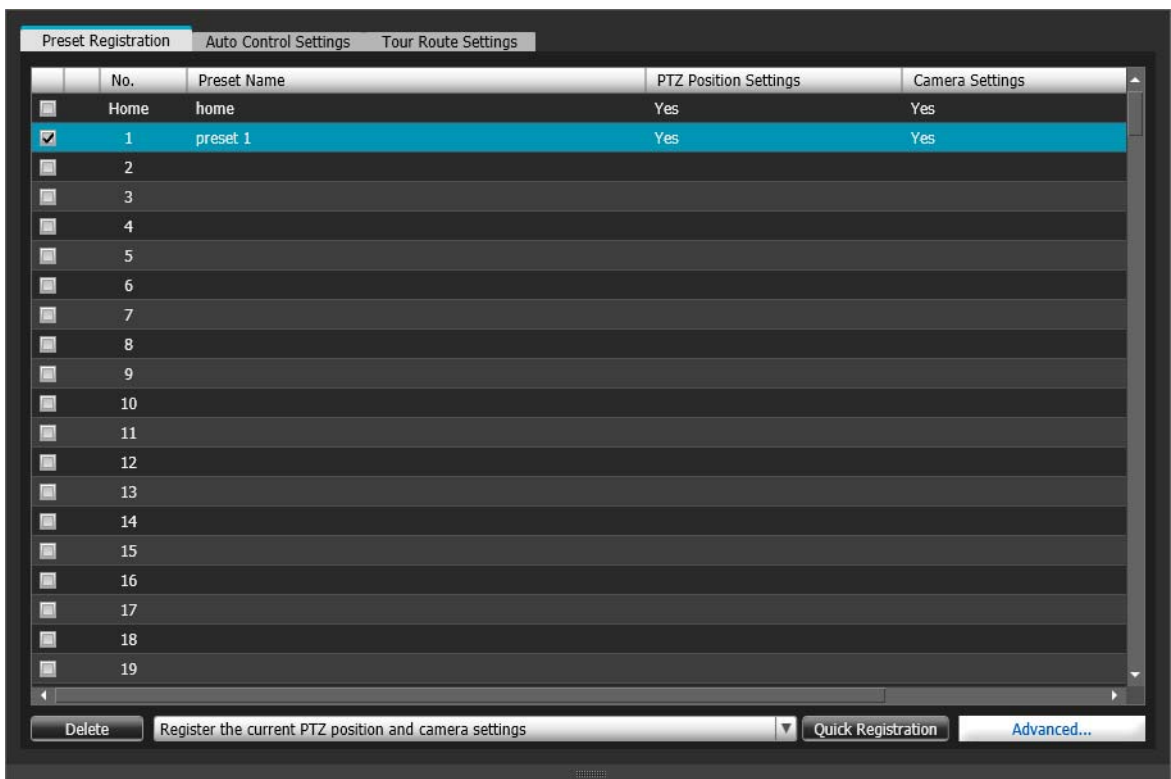

The [Advanced Preset Settings] panel appears.

3 Set each item.

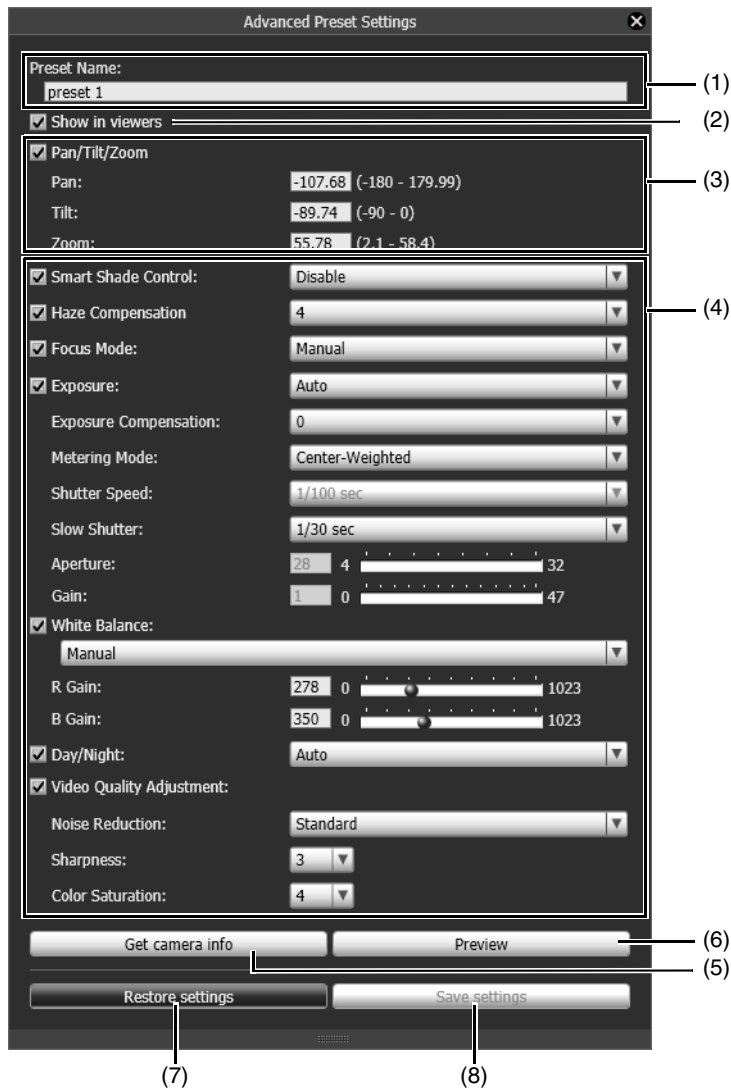

- (1) **[Preset Name]**
Enter a preset name of 64 characters or less. Be sure to enter a name in [Preset Name].
- (2) **[Show in viewers]**
Select this to allow the Viewers to use the preset.
- (3) **[Pan/Tilt/Zoom]**
R11 R10
You can set the pan, tilt and zoom positions by entering values.
M641 M640 M741 M740
The pan, tilt, zoom positions appear.

Note

- This check box cannot be cleared for [Home] (home position). Be sure to set this.
-  (warning icon) will appear to the left of the value if you enter settings that fall outside the setting range.

- (4) **Camera Settings**
Select the items in Control for Admin to apply to the preset. For details on each item, please refer to "Use Control for Admin" (P. 158).

Important

If [Manual] is selected in Focus Mode, manually adjust the focus while checking the actual video in the video display area. After the focus has been adjusted, set the focus using [Get camera info]. Click [Save settings] to save the focus settings.

Note

If one of [Smart Shade Control], [Haze compensation], [Exposure], or [Infrared] (VB-M741LE) is selected, all four will be selected automatically.

However, the following combinations cannot be configured.

- [Exposure] cannot be set to [Manual] and [Smart Shade Control] cannot be set to [Auto] at the same time.
- [Smart Shade Control] cannot be used if [Haze Compensation] is set to [Auto] or a manual setting ([1] to [7]).
- [Haze Compensation] cannot be used if [Smart Shade Control] is set to [Auto] or a manual setting ([1] to [7]).
- When [Exposure] is set a value other than [Manual], [Infrared] cannot be set to [Level]. **M741**

(5) [Get camera info]

The current video display area camera angle and camera settings will be loaded into the [Advanced Preset Settings] panel.

Use this to apply changes in the camera angle and settings to the preset.

(6) [Preview]

Click this to have the settings in the [Advanced Preset Settings] panel applied to the video display area.

(7) [Restore settings]

If you previewed incorrect settings, etc., click this to revert to the settings registered in the camera.

(8) [Save settings]

Registers the settings in the [Advanced Preset Settings] panel.

4 Click [Save settings].

The edited preset settings are saved to the camera.

If you configure preset settings, be sure to save them to the camera using [Save settings].

Context Menu

If you right-click on a preset in the preset list, the following menu appears.

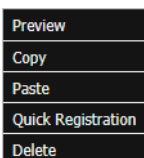

[Preview]

The settings for the preset you right-clicked on are reflected in the video display area.

[Copy]

The settings for the preset you right-clicked on are copied.

[Paste]

Copied preset settings are applied to the preset you right-clicked on.

[Quick Registration]

Registers the settings selected in [Items to Reg.] in presets (P. 172).

[Delete]

The preset you right-clicked on is deleted. [Home] (home position) cannot be deleted.

Note

The available menu items change depending on the preset you right-click on.

Change Multiple Presets Simultaneously

If you select multiple presets on the preset list and register settings with [Quick Registration] or the [Advanced Preset Settings] panel, all of the presets will be configured with the same settings.



Note

Home positions cannot be configured simultaneously.

Automatically Move to a Preset Position at a Specified Time (Auto Control Settings)

Presets registered in advance can be executed at a specified time or when events trigger the switching of Day/Night Mode. Preset camera settings are also applied.

Configure [Auto Control Settings]

Select the [Switch Day/Night] or [Timer] preset in the [Auto Control Settings] tab, and click the [Save settings]. You can register up to 4 timer preset auto controls.

Important

If both [Switch Day/Night] and [Day/Night] > [Day/Night Focus Settings] > [Focus control when switching Day/Night Mode] (P. 165) have been set, [Focus control when switching Day/Night Mode] will be given priority.

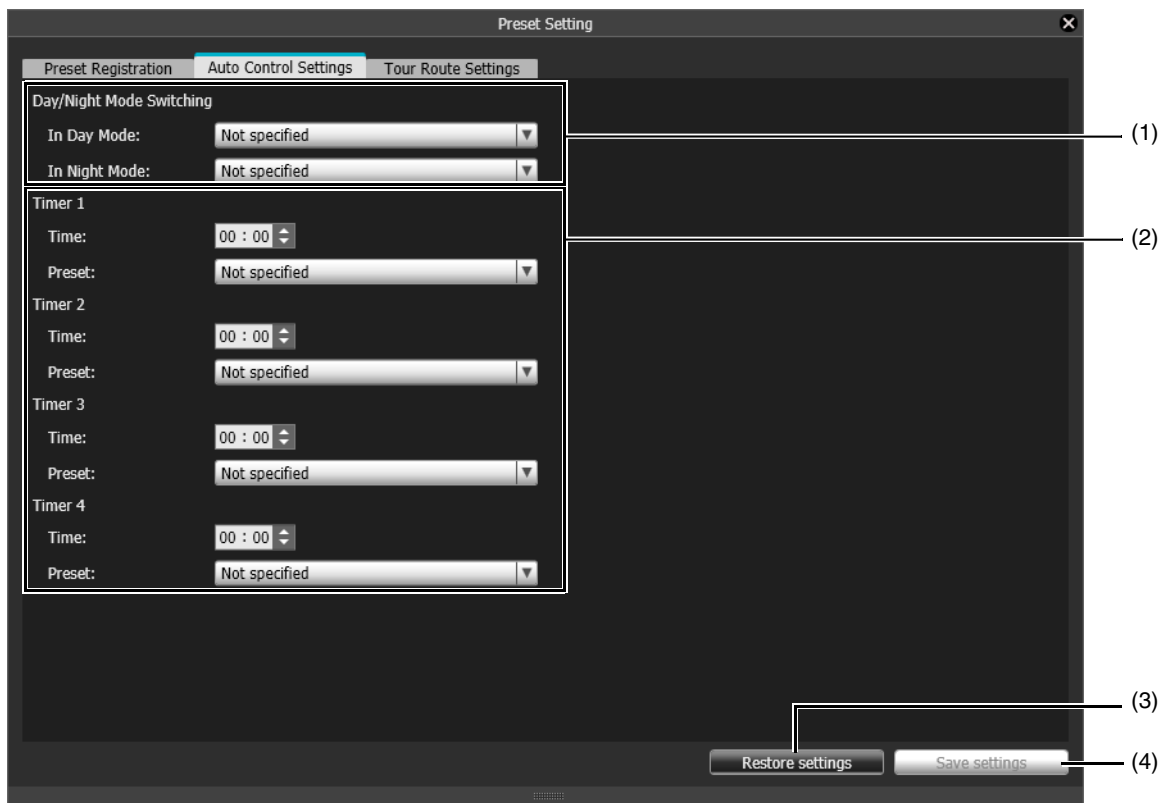

- (1) [Switch Day/Night]
Select each registered preset to be executed when switching to Day Mode or Night Mode using auto control.
- (2) [Timer 1] to [Timer 4]
To use a preset at a specified time, set the time in 24-hour format and select the preset.

Important

- You cannot specify the same time multiple times in [Timer 1] to [Timer 4].
- If the [Timer] set here, and the [Timer] in the Setting Page are set on the same time, the timer in the Setting Page will have priority.
Example)
 - [Event] > [Timer] > [Start Time] is set to [2:00] in the Setting Page, select [preset2] as the [Start Time preset]
 - [Timer] > [Time] is set to [2:00] in the [Auto Control Settings] tab, and Preset is set to [preset1].Result: Preset 2 will run at 2:00.

- (3) [Restore settings]
Revert to the auto control settings registered in the camera.



Important

[Restore settings] is shared with the [Tour Route Settings] tab. Since clicking this affects both tabs, also take care when restoring tour route settings.

- (4) [Save settings]
Register the settings for [Auto Control Settings].



Important

[Save settings] is shared with the [Tour Route Settings] tab. Since clicking this affects both tabs, also take care when saving tour route settings.



Note

Auto control settings will not be executed while you have camera control privileges.

Configure the Preset Tour Route

You can have the camera automatically tour multiple registered presets to allow monitoring.



Important R11 R10

- Since use of preset tour could lead to overuse of the camera, possibly resulting in camera malfunction, it should only be used when necessary. The amount of camera move in unit time can be reduced by increasing the duration the camera pauses at each point along the tour.
- Intelligent Function cannot be used while using preset tour.



Note

Preset tour is not performed while the camera is being controlled, such as with the Admin Viewer or the Admin Tools. Preset tour is not performed when control privileges are obtained by RM-Lite.

[Tour Route Settings] Tab

Since the number of tour routes you can register, the numbers of preset that can be toured per route and the tour conditions vary depending on the camera model, screen configurations differ as follows.

R11 R10





- (1) **[Route List]** **R11** **R10**
This is the preset tour route list. It displays the configured tour conditions. You can configure five tour routes.
- (2) **Tour Condition Settings**
Configure the tour route name and conditions for touring (P. 181).
- (3) **Select Preset List**
Registered presets in the [Preset Setting] tab appear in this list if [PTZ Position Settings] is [Yes].
Select the preset you want to add to the tour route from this list.

Note

If the position for the preset is outside the view restriction range,  (warning icon) will appear on the left.

- (4) **[Tour Presets List]**
Presets that will be toured appear in this list. They will be toured in order from the top of the list.
You can configure settings, such as changing the preset order and the time to pause at a preset position.
- (5) **[Restore settings]**
This discards the settings you are configuring and reverts to the settings registered in the camera.

Important

[Restore settings] is shared with the [Auto Control Settings] tab. Since clicking this affects both tabs, also take care when restoring auto control settings.

- (6) **[Save settings]**
The settings in the [Tour Route Settings] tab are saved to the camera.

Important

[Save settings] is shared with the [Auto Control Settings] tab. Since clicking this affects both tabs, also take care when saving auto control settings.

Tour Route Settings

The number of tour routes you can register and the number of presets that can be toured per route are as follows.

- Maximum 5 routes, maximum 60 presets per route. **R11 R10**
- Maximum 1 route, maximum 20 presets per route. **M641 M640 M741 M740**

R11 R10

Route Name	Effective Conditions	Active Time	Revert
route 1	For Viewers	-	No
route 2	Not used	-	No
route 3	Not used	-	No
route 4	Not used	-	No
route 5	Not used	-	No

Note **R11 R10**

If the effective conditions or active times of the registered tour routes conflict, the routes listed higher in the [Route List] take precedence.

- 1 Select the tour route to configure from [Route List].
- 2 Settings for Tour Route Names and Usage

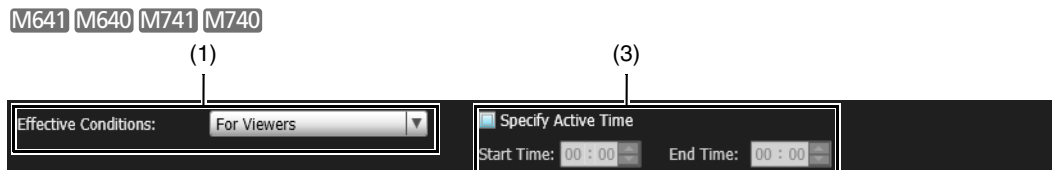

- (1) [Effective Conditions]
 - Select the conditions to perform a preset tour.
 - [Not used]
 - Preset tour is not performed.
 - [For Viewers]
 - Preset tour is performed when a Viewer is connected to the camera.
 - [Always]
 - Preset tour is always performed.

Note

When [Not used] is selected, the subsequent preset tour route settings cannot be configured.

- (2) [Route Name] **R11 R10**
 - Enter the tour route name of 64 characters or less.
 - (3) Active Time Settings
 - Select [Specify Active Time] to configure a preset tour at a predetermined time, and enter the start time and end time for the preset tour.
 - (4) [Reverse route] **R11 R10**
 - If you select this, the preset tour order in [Tour Presets List] will be reversed.
- 3** Select a preset to tour from the Select Preset list.
- You can select multiple presets.

4 Click .

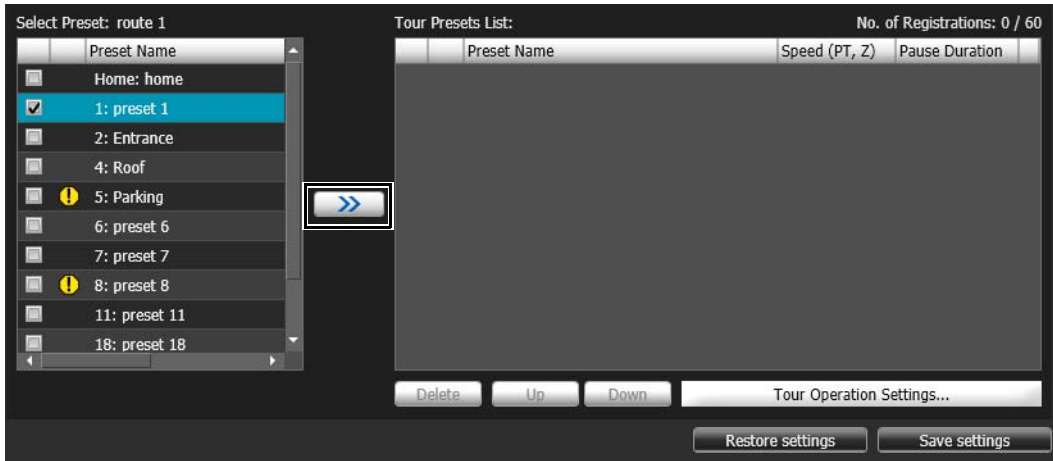

The preset is added to the [Tour Presets List].

R11 R10 You can add a maximum of 60 presets.

M641 M640 M741 M740 You can add a maximum of 20 presets.

Select a preset in [Tour Presets List] and click the [Up] or [Down] to change its position in the list.

If you select a preset in [Tour Presets List] and then click [Delete], the preset will be deleted.

 **Note**

If a preset has already been added to [Tour Presets List] and is selected when another preset is added from the [Select Preset] list, the added preset will appear below the selected preset.

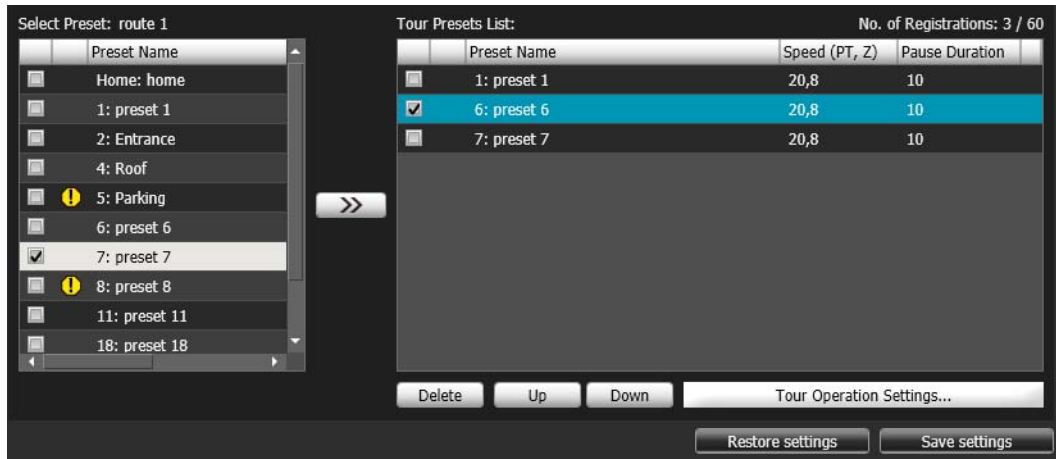

5 Configure the preset speed and pause duration.

Select the preset to configure in [Tour Presets List] and click [Tour Operation Settings].

The [Tour Operation Settings] panel appears.

R11 R10

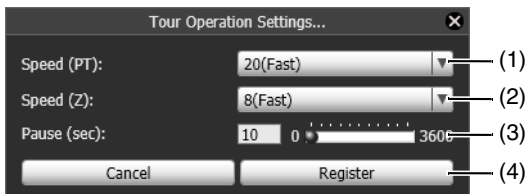

M641 M640 M741 M740

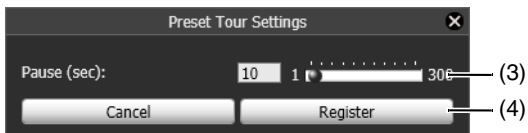

- (1) [Speed (PT)] **R11 R10**
Select the camera pan/tilt speed for moving to the next preset.
- (2) [Speed (Z)] **R11 R10**
Select the camera zoom speed for moving to the next preset.
- (3) [Pause (sec)] **R11 R10**
Set the time the camera pauses at the preset position.
- (4) [Preset Registration]
Register the [Tour Operation Settings] as the tour operations of the selected preset.



Note

If you want to view video during moves between presets, select a slow to medium speed. If you only want to switch quickly to view video at the preset positions, select a fast speed.

6 Click [Save settings].

Click [Save settings] after configuring the route. The setting will be saved to the camera.



Important

If you do not save the settings and click [Restore settings] in the [Auto Control Settings] tab, the settings in the [Tour Route Settings] tab will also revert.

Context Menu

■ [Route List] Context Menu **R11 R10**

If you right-click on a tour route in [Route List], the following menu appears.



[Copy]

The settings for the tour route you right-clicked on are copied.

[Paste]

Copied tour route settings are applied to the tour route you right-clicked on.

[Clear]

The tour route you right-clicked on is returned to its initial state. It is not saved to the camera.

■ Preset selection list menu

If you right-click on a preset name in the [Select Preset] or [Select Tour Route Preset] list, the following menu appears.



[Preview]

The preset you right-clicked can be verified in the video display area.

Check the Event Detection Status With Admin Viewer

You can use the Event Display panel in the Admin Viewer to check the status for external device inputs, Intelligent Function detection, and the triggering of linked events.

Confirm Status With the Event Display Panel

Click the [Event Display] button (P. 142) to display the panel.

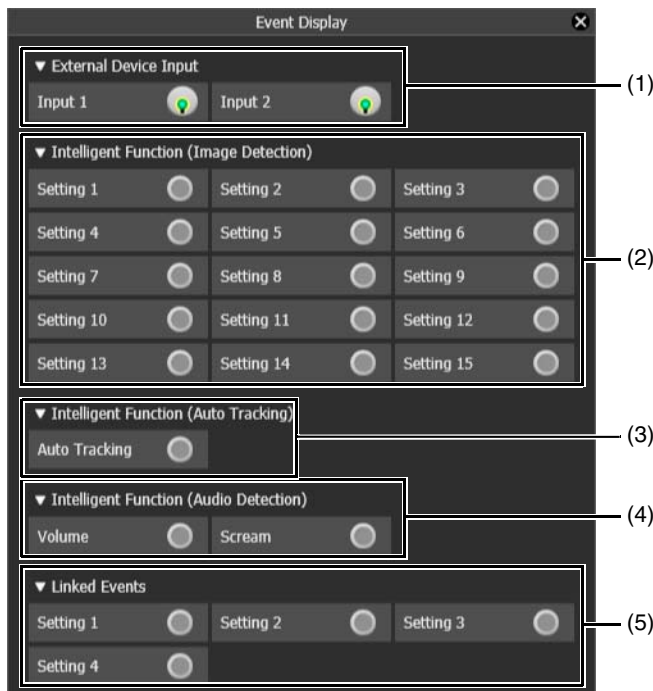

(1) [External Device Input] R11 M641 M741

When a contact input signal is received from an external device, input will be activated and indicated with an icon.
Example:



Input 1: Input inactive
Input 2: Input active

(2) [Intelligent Function (Image Detection)]

The status of video detection (P. 210) by the Intelligent Function is displayed for each detection setting number.
When the detection settings configured in Intelligent Function (Moving Object Detection, Abandoned Object Detection, Removed Object Detection, Camera Tampering Detection, Passing Detection, or Intrusion Detection) are triggered, the corresponding icon will turn green.

If names are entered in [Detection Setting Name] in Intelligent Function Setting Tools (P. 219), [Setting 1] to [Setting 15] will be displayed with the corresponding names.

Example:



Setting 1: Image Detection status ON
Other settings: Image Detection status OFF

Note

The icon indicating the detection status will be displayed for a maximum of five minutes (except for Moving Object Detection).

(3) [Intelligent Function (Auto Tracking)] R11 R10

The detection status of Auto Tracking (P. 230) by the Intelligent Function is displayed. If detection is triggered, the icon will turn green.

Example:



Auto Tracking status ON

(4) [Intelligent Function (Audio Detection)] R11 M641 M741

Displays the status of [Volume Detection] or [Scream Detection] set in [Event] > [Audio Detection] (P. 107) in the Setting Page. If detection is triggered, the icon will turn green.

Example:

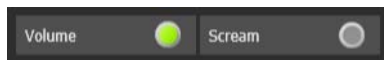

Volume: Volume Detection status ON

Scream: Scream Detection status OFF

(5) [Linked Events] R11 M641 M741

Displays the status of linked events for Intelligent Function set with [Event] > [Linked Events] (P. 113) in the Setting Page. If a linked event is triggered, the icon will turn green.

Example:



Setting 2: Linked Event status ON

Other settings: Linked Event status OFF

Record Snapshots/Video With Admin Viewer

You can capture snapshots or manually record video to a memory card inserted in the camera as you view video in the video display area.

Capture a Snapshot

Capture and save a snapshot from the video in the video display area.

- 1 Click [Snapshot] button at the moment you want to capture a snapshot.

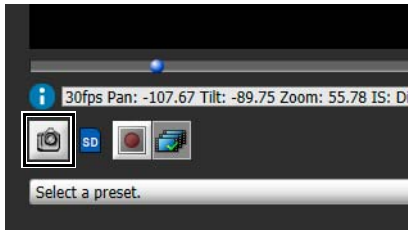

The Snapshot panel will open showing a snapshot from the moment you clicked. If you click the [Snapshot] button again, the image displayed in the Snapshot panel will be updated.

- 2 To save the snapshot, right-click on the Snapshot panel.
- 3 Click [Save Picture As] in the menu that appears.
- 4 Enter the desired file name and save the snapshot.

Note

- The snapshot is saved as a JPEG file.
- The saved snapshots are the same size as the video capture size.

Record Video to a Memory Card Manually

Manually record video being displayed in the video display area to a memory card inserted in the camera.

Note

- You can manually record video if the following conditions have been met.
 - The memory card inserted in the camera is mounted (P. 142).
 - Set [Operation Settings] to [Save Logs and Videos] in [Video Record] > [Memory Card] > [Memory Card Operations] (P. 101) in the Setting Page.
- The format and size of the video recorded to a memory card depends on the settings configured on the Setting Page.
 - Video format: [Memory Card] > [Memory Card Operations] > [Video Format] (P. 130)
 - Video size: JPEG [Basic Settings] > [Video Settings] > [JPEG] > [Video Size: Upload / Memory card]
H.264 [Basic Settings] > [Video Settings] > [H.264(1)] > [Video Size]

Recording Videos Manually

- 1 If you have not obtained camera control privileges, click the [Obtain/Release Camera Control Privileges] button to obtain the privileges.

2 Click the [Memory Card Recording] button.

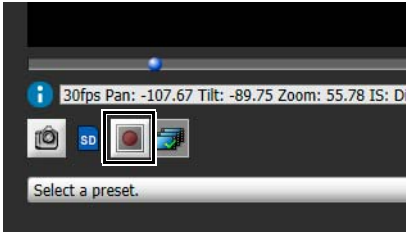

The display of the [Memory Card Recording] button will change during video recording.

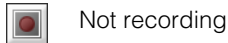

Not recording



Recording

3 To stop video recording, click the [Memory Card Recording] button again.

Important

- Manually recorded video to the memory card will automatically be terminated after 300 seconds of recording.
- When recording manually, do not change the settings in the [Setting Page]. Doing so may result in the termination of the manual recording.

■ Confirming Recorded Video

Use the Recorded Video Utility (P. 240) to confirm and playback the video manually recorded to a memory card. Click the [Recorded Video Utility] button to launch the Recorded Video Utility.

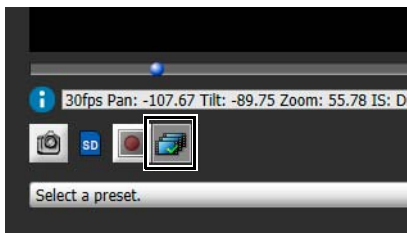

Use VB Viewer

For details on each part of the VB Viewer, please refer to “Admin Viewer/VB Viewer Screen” > “VB Viewer” (P. 141).

Launch VB Viewer and Differences with Admin Viewer

■ Launch VB Viewer

Launch the camera top page and click [VB Viewer] to launch the VB Viewer (P. 41).

■ Differences with the Admin Viewer

The following Admin Viewer functions and buttons are not available in the VB Viewer.

- H.264 video display
- Memory card mount status icon
- [Memory Card Recording] button
- [Recorded Video Utility] button
- [Event Display] button
- [Control for Admin] button
- [Audio Transmission] button **R11 M641 M741**





VB Viewer Operation Range

If you have set view restrictions with the View Restriction Setting Tool (P. 206), the VB Viewer can only be used within the view restrictions.

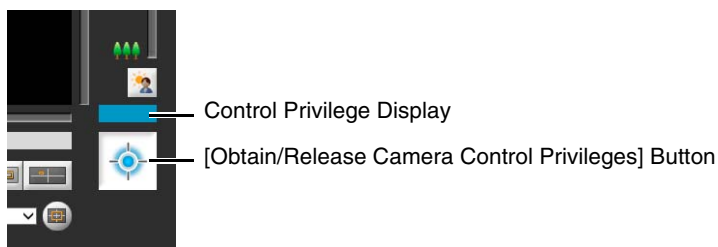
Camera Control Privilege Status Indicator

Depending on the camera control privilege status, the camera control privilege indicator and [Obtain/Release Camera Control Privileges] button appearance changes as follows.



Appearance	Control Privilege Status	Explanation
	Control privileges not obtained	Camera control privilege indicator is grayed out. The [Obtain/Release Camera Control Privileges] button is animated.
	Waiting to obtain control privileges	If you click the [Obtain/Release Camera Control Privileges] button while privileges are not assigned and are put in the queue for privileges, the camera control privilege indicator will display the remaining time.
	Control privileges obtained	Camera control privilege indicator appears in blue. The center of the [Obtain/Release Camera Control Privileges] button is blue.
	Control privileges obtained (remaining control time)	After obtaining control privileges, the amount of time for maintaining control privilege priority is displayed in the control privilege indicator.

Context Menu in Full Screen Mode

The following menus appear when you right-click in full screen mode in the VB Viewer.

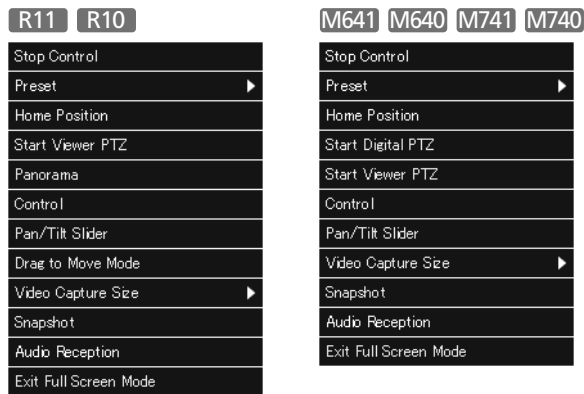

For details on each item, please refer to P. 145.

Chapter

6

Admin Tools

Use the Admin Tools included on the camera to configure the various monitoring methods used by the camera.

There are also tools for checking camera operation and managing recorded video.

Admin Tools Overview

The Admin Tools consists of tools for configuring settings, such as for camera use, a viewer for checking the camera operation status logs and a utility for managing recorded video.

You can launch each tool from the [Admin Tools] top page (P. 193).

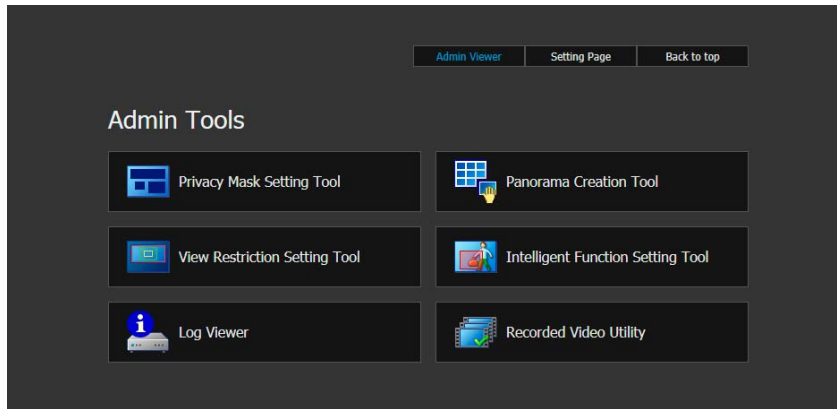

Overview of Each Tool in the Admin Tools

Privacy Mask Setting Tool (P. 196)

This tool masks areas you do not want to show in the camera video, such as areas where you want to maintain privacy. Up to eight areas can be masked, allowing thorough protection of privacy.

Panorama Creation Tool (P. 201) **R11** **R10**

This tool captures the entire area that can be captured by the camera to create a panorama image. The panorama image appears in the panorama display panel of the Admin Viewer/VB Viewer and in the setting screen of the View Restriction Setting Tool. It also allows you to see at a glance which part of the entire area the Viewer is displaying video from or has made settings in.

View Restriction Setting Tool (P. 206) **R11** **R10**

This tool limits the range that can be captured by the camera. You can visually configure settings with the preview frame on the panorama screen using the mouse.

Intelligent Function Setting Tool (P. 210)

This tool configures settings for writing to a log, recording video, or sending e-mail notifications when a part of the video changes, such as when a subject moves. You can configure detection areas or conditions while checking the video.

Log Viewer (P. 236)

This Viewer allows browsing the camera operation status logs recorded in the camera. You can also download the log from the camera and save the file.

Recorded Video Utility (P. 240)

This is a utility for browsing and managing video recorded on memory cards inserted in the camera. You can display a list of recorded video, and play back, delete and download video.

Access Admin Tools

This explains the [Admin Tools] top page and how to launch the Admin Tools.

Important

The Admin Tools Certificate must be installed on the computer to launch the Admin Tools (P. 22).

Launch Admin Tools

Launch the Admin Tools by accessing the Admin Tools top page from the camera top page.

Note

- The Privacy Mask Setting Tool, Panorama Creation Tool, View Restriction Setting Tool and Intelligent Function Setting Tool cannot be launched simultaneously.
- To use the Admin Tools in environments without a proxy server, select [Internet options] > [Connections] tab > [LAN settings] and clear the [Automatically detect settings] check box in Internet Explorer.
- When the Preset Setting panel is opened with the Admin Viewer, all tool buttons will be disabled except for the Recorded Video Utility and Log Viewer.

1 Launch the camera top page and click [Admin Tools] (P. 41).

A user authentication window appears.

2 Enter a user name and password (P. 42) and click [OK].

The [Admin Tools] top page will appear.

3 Click the tool you would like to launch.

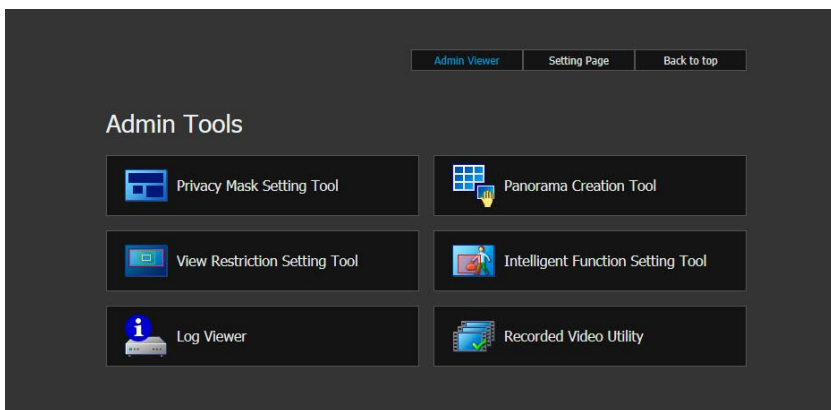

The tool will launch.

Note

- The first time you launch any of the tools in the Admin Tools, it may take about 5 to 10 seconds for the software to download to the computer. When accessing via SSL encrypted communication, download time will take longer (about 20 to 30 seconds).
- Admin Tools can also be launched from the Camera Management Tool. For details, please refer to the Camera Management Tool user manual.

■ Launch Other Top Pages

You can launch the top pages for the Admin Viewer, Setting Page and camera by clicking the buttons in the upper right of the [Admin Tools] top page.

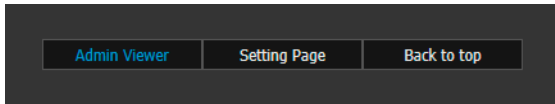

Admin Tools Operations Common to All Tools

The way you operate the viewer area for the Privacy Mask Setting Tool, View Restriction Setting Tool and Intelligent Function Setting Tool is the same.

■ Viewer Area

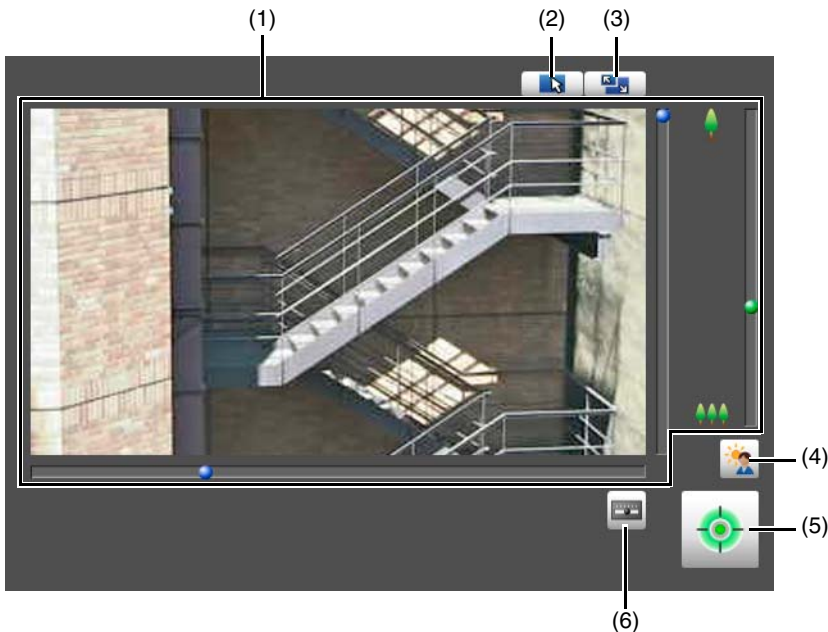

(1) Video Display Area

This displays the video currently being captured by the camera. You can set the area using the mouse in the video display area.

Note

When [1280x720/640x360/320x180] is set for the 16:9 aspect ratio in [Basic Settings] > [Video Settings] > [All Videos] > [Video Size Set], black bars will appear on the top and bottom of the video display area.

(2) [Switch Mouse Operation] Button

When you click this button, mouse operations for icons and in the video display area change as follows.



: You can specify areas on the displayed video. While in this mode, the camera angle will not change.



: You can pan and tilt the camera.

(3) [Switch Screen Size] Button

Each time you click this button, the screen size of the video display area switches between 320 x 240 and 640 x 480.

(4) [BLC] (Back Light Compensation) Button

Click this button to turn backlight compensation on or off (P. 155).

(5) [Obtain/Release Camera Control Privileges] Button

Click this to obtain and release the camera control privileges (P. 147).

(6) [Control for Admin] Button

Displays the Control for Admin panel.

R11 R10

Pan/Tilt/Zoom Operations

Pan, tilt, and zoom operations are the same as in the Admin Viewer (P. 147).

Note

- Area Zoom and Drag to Move (P. 149) cannot be used with the video display area of the Admin Tools.
- Auto Flip (P. 76) is disabled in the video display area in Admin Tools.

Control for Admin

Privacy Mask Setting Tool, View Restriction Setting Tool and Intelligent Function Setting Tool can use certain items in Control for Admin.

Control for Admin Operations

Click the [Control for Admin] button (P. 195) in the viewer area to display the Control for Admin panel. The Control for Admin panel operates in the same way as Control for Admin of the Admin Viewer (P. 158). You can configure the following items in Control for Admin panel of the Admin Tools.



[Smart Shade Control]

You can configure Smart Shade Control settings (P. 159).

[Haze Compensation]

You can adjust the video if the subject is obscured by haze (P. 160).

[Focus]

You can adjust focus (P. 161).

[Exposure]

You can adjust exposure (P. 162).

Note

If you select [Lock camera position] (P. 216) or [Specify the initial camera position], the Intelligent Function Setting Tool (P. 230), you will not be able to use the tool's Control for Admin items.

Privacy Mask Setting Tool

This tool masks specified areas of the camera video. You can check the camera video and set up to 8 privacy masks. When the camera is panned, tilted, or zoomed, the privacy mask areas follow the camera video.



Important

- Privacy masks are applied to all video transmitted from the camera (live video, uploaded video, recorded video and video recorded to a memory card).
- Privacy masks are not available in the following situations.
 - While the camera is launched after being turned on.
 - For camera video in the Camera Angle Setting Tool [M641](#) [M640](#) [M741](#) [M740](#)
 - While a panorama image is being created. [R11](#) [R10](#)
- Intelligent Function detection also works in the privacy mask areas. Subject movement may be visible.

Register Privacy Masks

Use the mouse to position and size the privacy mask areas, then save the settings to the camera.

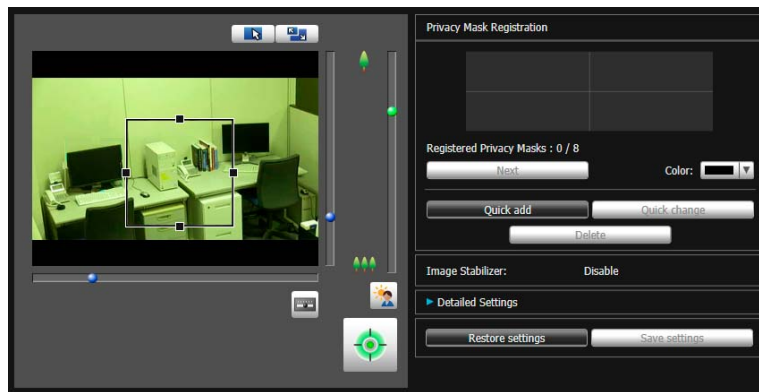

Settings Screen for the Privacy Mask Setting Tool

1 If you have not yet obtained the camera control privileges, click the [Obtain/Release Camera Control Privileges] button and obtain the control privileges (P. 147).

2 Set the size and position for the privacy mask in the video display area.

Drag the preview frame displayed in the video display area to the position you want to mask. Change the size of the preview frame by dragging the handles (■) positioned on its four sides.

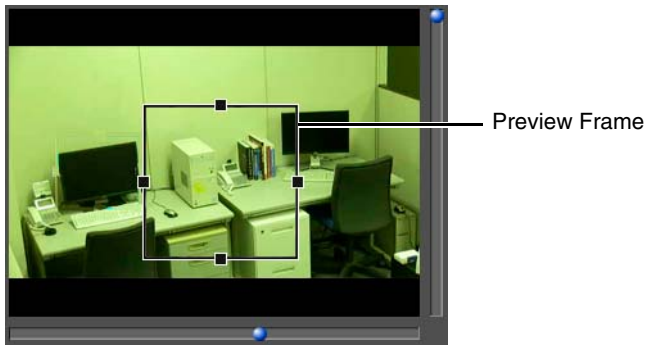

 **Important** R11 R10

- Set the privacy mask area to a slightly larger size than the area you want to hide.
- You can only set privacy masks in the optical zoom range. Privacy masks cannot be set in the digital zoom range (P. 148).

3 Select the color for the privacy mask area with [Color].

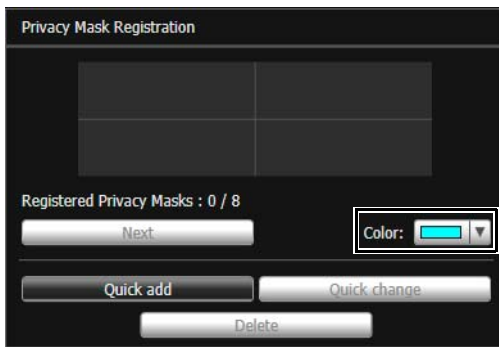

4 Click [Quick add].

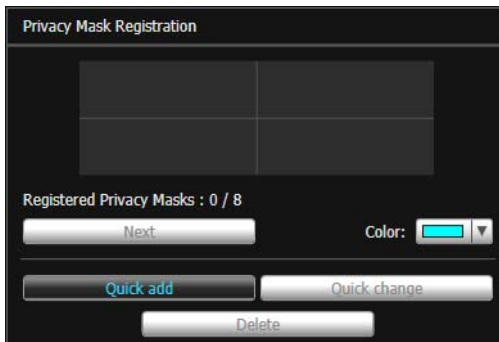

The privacy mask area is saved to the camera.
Saved privacy mask areas are shown in the video display area and the privacy mask registration area.

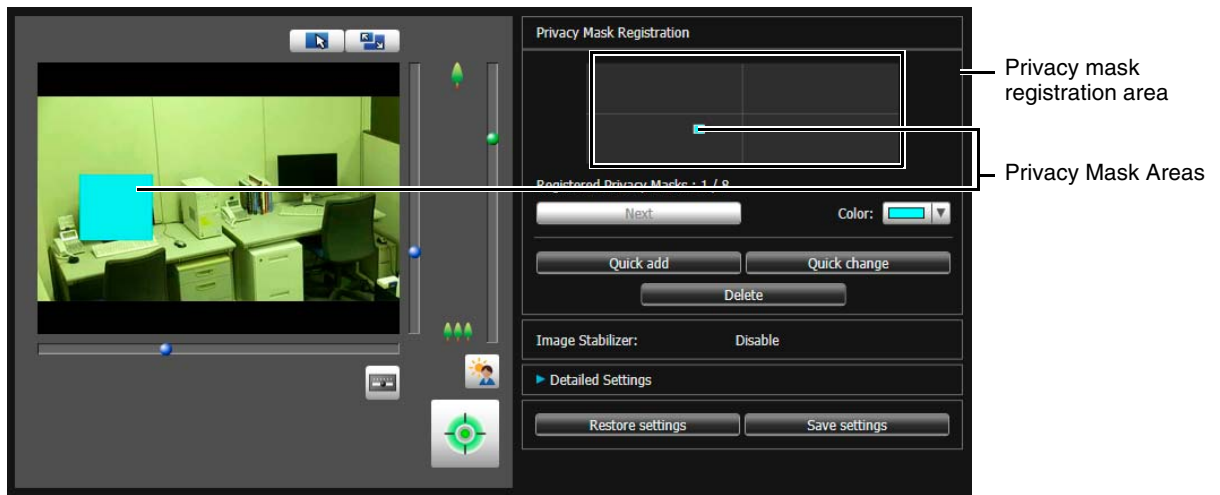

5 To add privacy mask areas, repeat steps 2 to 5.

You can save up to 8 privacy masks.

Important

- Check privacy mask settings again if you change the [Basic Settings] > [Video Settings] > [All Videos] > [Video Size Set] settings on the Setting Page.
- You will need to set the position of the privacy mask again if you change the [Image Flip] setting in [Camera] > [Camera Settings] > [Installation Conditions] on the setting page.
- If you reconfigure privacy mask settings after you changed the [Camera] > [Camera Settings] > [Camera Control] > [Image Stabilizer] on the setting page, reconfigure all privacy mask positions and sizes.

R11 R10

- After registering a privacy mask, pan, tilt and zoom the camera to confirm the areas you want to mask do not become visible when the camera direction is altered.
- Privacy masks may deviate slightly from the specified position depending on the zoom position.
- If you change the privacy mask settings after saving a panorama image using the Panorama Creation Tool, you must use the Panorama Creation Tool to recreate the panorama image.

Change/Delete a Privacy Mask

■ How to Select a Privacy Mask

There are two ways to select a privacy mask area.

- Click the privacy mask area you want to change in the privacy mask registration area.
- Keep clicking [Next] until you select the privacy mask area you want.

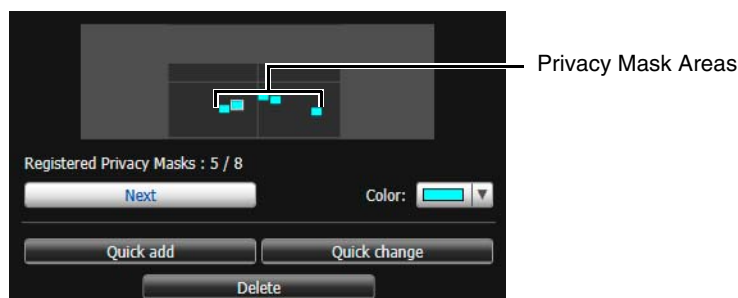

Privacy Mask Registration Area

This shows the positions of privacy mask areas in the entire area that can be captured by the camera.

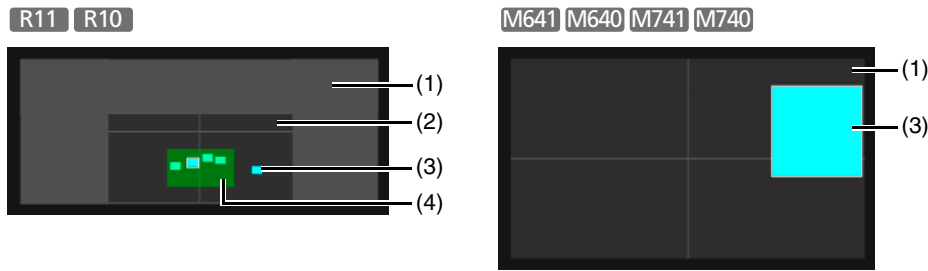

(1) Entire Area That Camera Can Capture

This shows the area that can physically be captured.

R11 R10

Even if a panoramic image is registered on the camera, it will not be displayed here.

(2) View Restriction Area **R11 R10**

Appears if view restrictions have been configured with the View Restriction Setting Tool (P. 206).

(3) Privacy Mask Areas

Privacy masks selected in [Detailed Settings] [Enable Privacy Mask] (P. 200) are displayed filled with color. Privacy masks not selected are displayed with a crossed out frame.

(4) Maximum Wide-Angle Area **R11 R10**

This is the visible area when the camera is at maximum wide-angle. This is only displayed when a privacy mask area is being dragged.

Change Mask Position and Size

1 Select the privacy mask area you want to change.

2 Change the position and size of the privacy mask area.

You can use the mouse to move or resize the preview frame, or change values in [Detailed Settings] (P. 200).

Note

To discard changes and restore settings saved to the camera, click [Restore settings].

3 Click [Quick change] or [Save settings].

The changed privacy mask area is saved to the camera.

Note

Select a disabled privacy mask and click [Quick change] to enable it.

Enter Values for Detailed Position and Size Settings

You can configure detailed position and size settings for the camera angle and privacy mask areas by entering values.

If you select a privacy mask and click [Detailed Settings], the fields for entering values will appear.

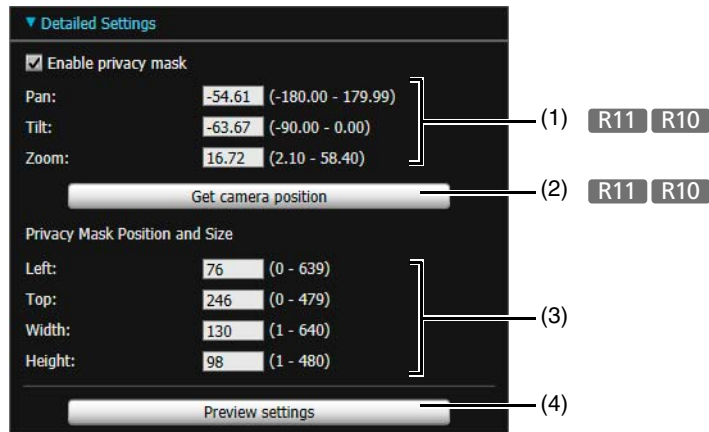

(1) [Pan], [Tilt], [Zoom] **R11 R10**

The settings for pan, tilt and zoom appear here if you saved privacy masks using [Quick add] or clicked [Get camera position]. You can also directly enter the setting values.

(2) [Get camera position] **R11 R10**

Click this to load the current camera pan, tilt, and zoom settings and display them in (1).

(3) [Privacy Mask Position and Size]

The position and size settings for the selected privacy mask appear here. You can also directly enter the setting values.

(4) [Preview settings]

Click this to preview the settings entered in (1) and (3) in the video display area and privacy mask registration area. The preview results are not saved to the camera.

Enable/disable a Privacy Mask

Select the check box to enable the settings of a selected privacy mask area.

Clear the check box to temporarily disable a privacy mask area without deleting it. The disabled privacy mask area will be displayed with a crossed out frame.

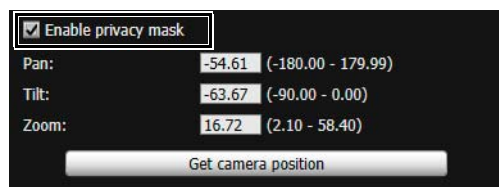

Delete a Privacy Mask

1 Select the privacy mask area you want to delete.

2 Click [Delete].

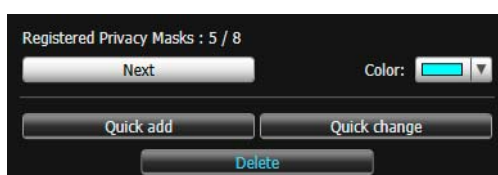

The selected privacy mask area is deleted from the camera.

This tool captures the entire area that can be captured by the camera to create a panorama image. The panorama image appears in the panorama display panel (P. 151) of the Admin Viewer/VB Viewer and in the setting screen of the View Restriction Setting Tool (P. 206).

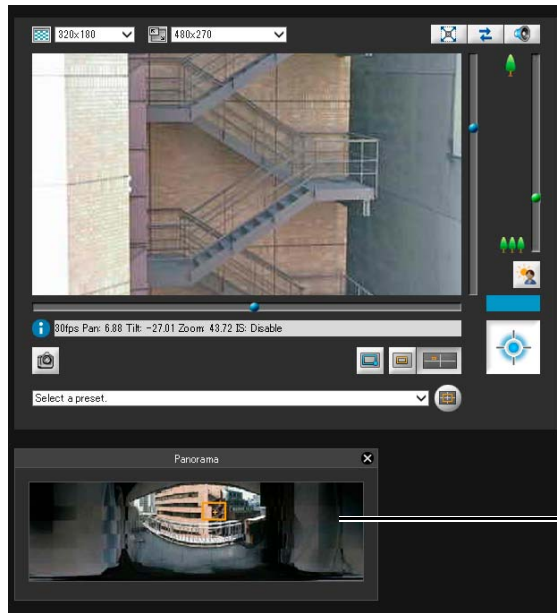

VB Viewer Panorama Display Panel

Important

If the privacy mask settings were changed using the Privacy Mask Setting Tool, it is recommended that you recreate the panorama image to reflect the new privacy mask settings in the panorama image.

Create a Panorama Image

Once you have created and saved a panorama image to the camera, it can be used by the tools.

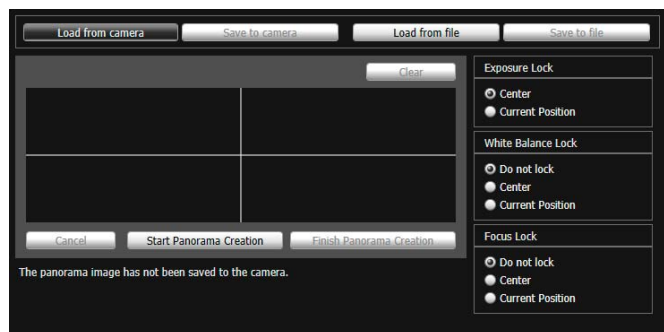

Panorama Creation Tool Settings Screen

- 1 If necessary, configure the [Exposure Lock], [White Balance Lock] and [Focus Lock] settings used when capturing the panorama image.

These settings will be applied at the panorama image capture start time and will revert back to their previous settings once capture is completed.

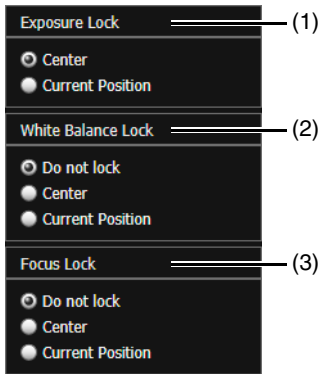

- (1) [Exposure Lock]
The exposure for the selected position will be automatically adjusted and locked during capture.
- (2) [White Balance Lock]
The white balance for the selected position will be automatically adjusted and locked during capture.
- (3) [Focus Lock]
The focus for the selected position will be automatically adjusted and locked for the entire scene during capture.

- 2 Click [Start Panorama Creation].

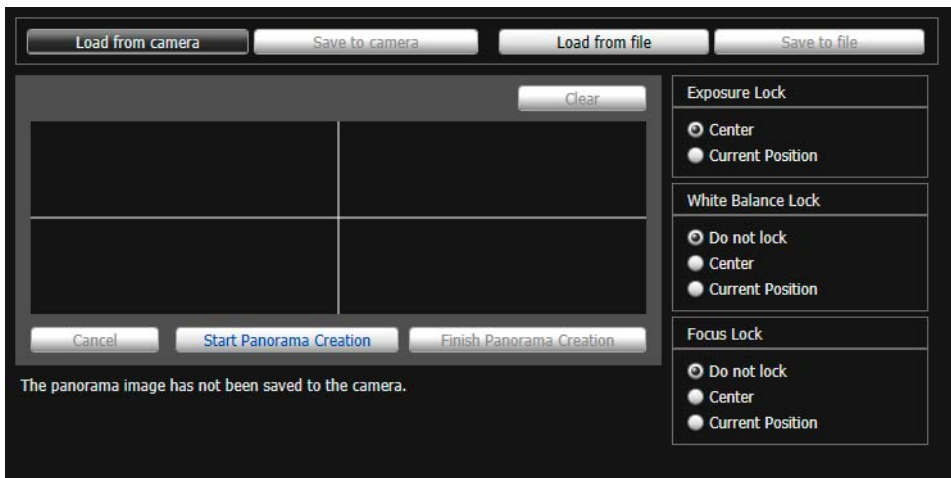

Capture starts and the panorama image is created.
To stop capture while underway, click [Cancel].

Note

- While a panorama image is being captured, the Image Stabilizer is temporarily disabled.
- The following users will be disconnected while creating a panorama image.
 - All users except for administrators
 - Users not connected via RTP
- When a small value is entered for [Maximum Frame Rate: Video Transmission] (P. 73) in [Video Settings] > [JPEG] in the Setting Page, panorama capture is slowed down.

- 3 Recapture the image if necessary.

Recapture a part of the image:

When you position the mouse pointer over the panorama image, a white grid appears.

If you right-click on a part of the image and select [Recapture] from the menu that appears, only that part of the image will be recaptured.

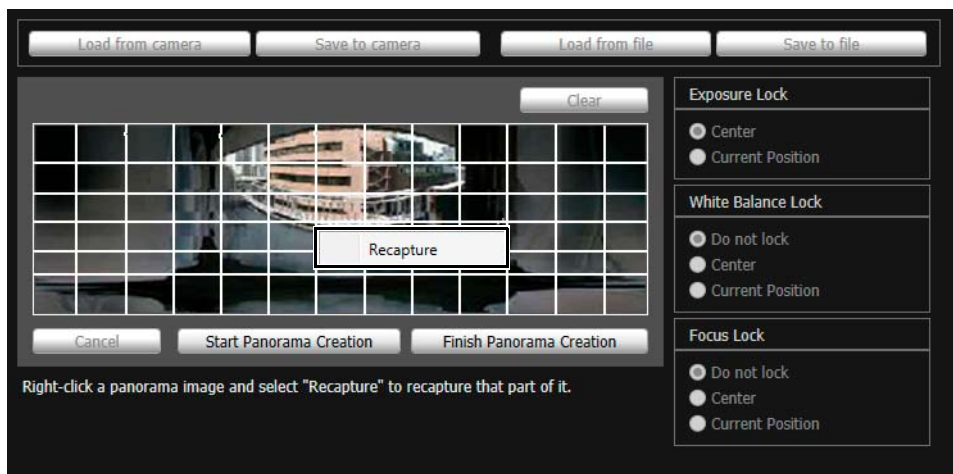

Recapture an entire panorama image:
Click [Start Panorama Creation] again.

4 Click [Finish Panorama Creation].

The created panorama image will not appear in other tools yet.

5 Click [Save to camera].

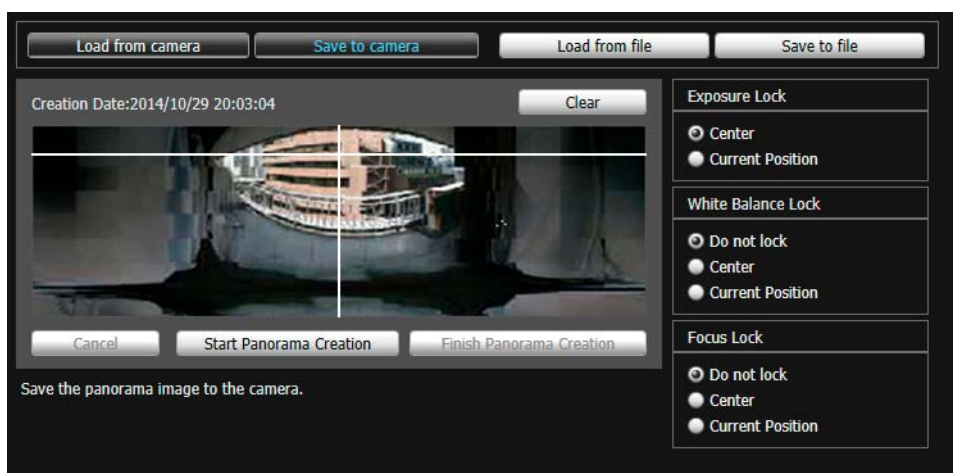

A confirmation message will appear.

6 Click [OK].

The panorama image is saved to the camera and appears in other tools.

Delete a Panorama Image from the Camera

Delete a panorama image saved in the camera.

- 1 Click [Clear].

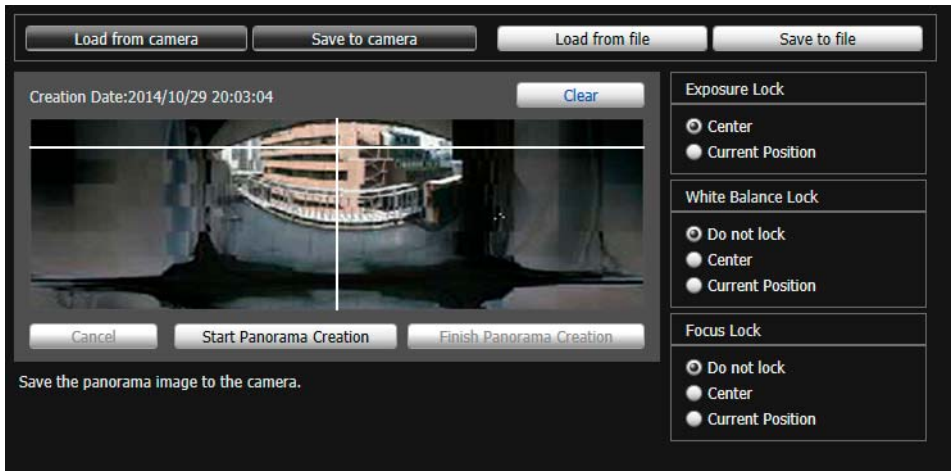

The currently displayed panorama image is deleted.

- 2 Click [Save to camera].
A confirmation message will appear.
- 3 Click [OK].
The panorama image saved in the camera is deleted.

Save/Load Panorama Image File

You can save recorded panorama images as image files and open image files as panorama images. Only JPEG images can be used.

Save an Image File

- 1 Click [Save to file].

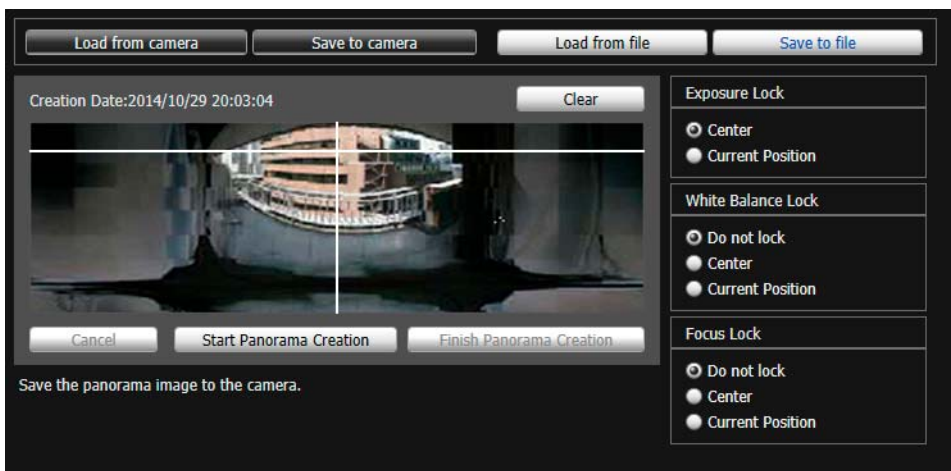

- 2 Select the folder you want to save the image file in and enter the file name in the displayed dialog box.

3 Click [Save].

Load an Image File

1 Click [Load from file].

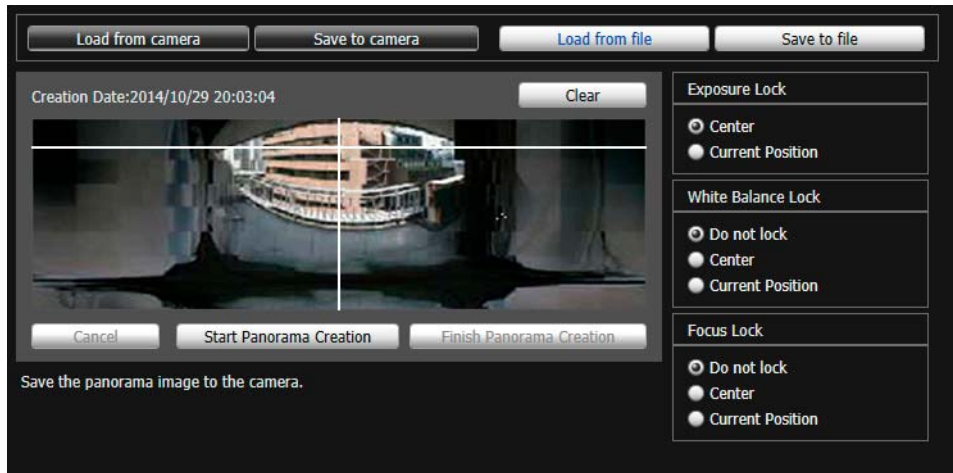

2 Select the image file you want to use from the dialog box that appears.

3 Click [Open].

This tool limits the range that can be captured by the camera. You can use this, for example, to limit zoom or the field of view to a certain range when publishing live video.

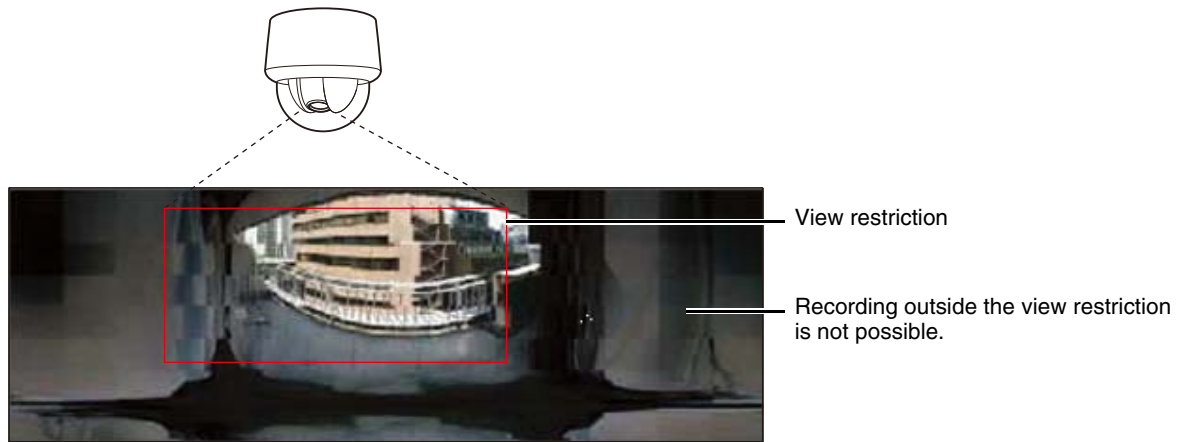

Scope of View Restriction Settings

Restrictions set by the View Restriction Setting Tool are applied in the following cases.

- When the Admin Viewer is accessed with authorized user privileges.
- When the VB Viewer is accessed.
- When accessed via the Intelligent Function Setting Tool.
- When accessed via RM-Lite.
- For presets or functions that move to preset positions.

Note

Even when view restrictions are set, an area outside the view restriction may still appear momentarily when the camera is controlled near the boundary of the view restriction.

Configure View Restrictions

There are two ways to configure view restriction settings.

- Use the panorama screen view restriction preview frame.
- Use the viewer area and load the position information from the camera.

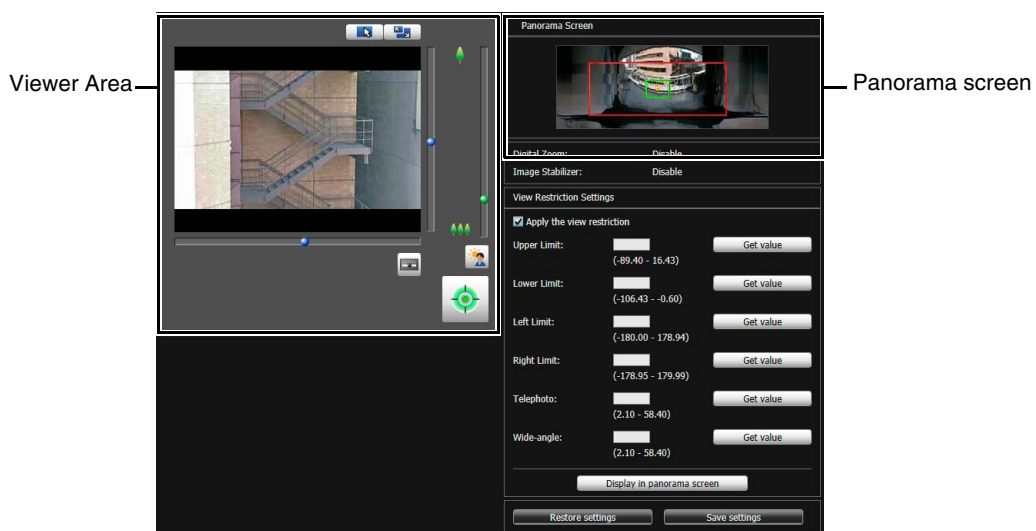

View Restriction Setting Tool Settings Screen

Important

- If you have changed how the camera is installed, recapture the panorama image and register it again.
- Check view restriction settings again if you change the [Basic Settings] > [Video Settings] > [All Videos] > [Video Size Set] settings on the Setting Page.
- When [Camera] > [Camera Settings] > [Camera Control] > [Digital Zoom] or [Image Stabilizer] are changed in the setting page, check restriction settings again.

■ Configure Settings With the Panorama Screen Preview Frame

- 1 Select [Apply the view restriction].



Note

To delete view restriction settings, clear the [Apply the view restriction] check box and click [Save settings].

- 2 Drag or resize the 3 types of preview frames displayed on the panorama screen to configure the view restrictions.

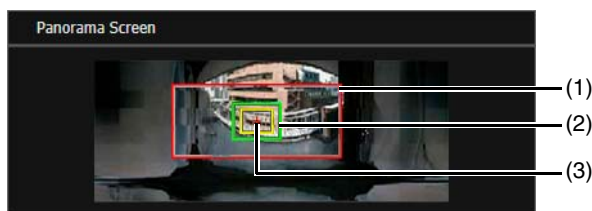

- (1) **Pan/Tilt Preview Frame (Red Frame)**
Displays the vertical and horizontal range the camera can move.
- (2) **Wide-Angle Preview Frame (Green Frame)**
Indicates the maximum wide-angle view possible within the pan/tilt preview frame. You cannot change the aspect ratio.
- (3) **Telephoto Preview Frame (Yellow Frame)**
Indicates the maximum telephoto view possible within the wide-angle preview frame. You cannot change the aspect ratio.

Note

If you resize the preview frames, the view restriction setting values will be updated in the value entry fields.

- 3 Click [Save settings].

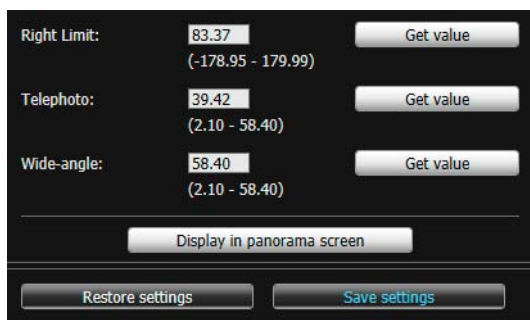

The settings are saved to the camera.

Note

The panorama screen may be slightly different from the actual image. After you have configured view restrictions, be sure to use the VB Viewer to confirm they have been reflected correctly. View restrictions are not applied to the video display area of this tool nor in the Admin Viewer.

Load Position Information from Video Display Area Camera Angle to Configure Settings

You can set the preview frame displayed on the panorama screen by loading position information from the actual video appearing in the video display area.

You can also enter values directly.

- 1 Select [Apply the view restriction].

Setting	Value	Range	Action
Upper Limit:	-33.04	(-89.40 - 16.43)	Get value
Lower Limit:	-60.02	(-106.43 - -0.60)	Get value
Left Limit:	-13.48	(-180.00 - 178.94)	Get value
Right Limit:	34.46	(-178.95 - 179.99)	Get value
Telephoto:		(2.10 - 58.40)	Get value
Wide-angle:		(2.10 - 58.40)	Get value

Display in panorama screen

Note

If you have selected [Apply the view restriction] and leave any of the setting values empty, the maximum view range will be set.

- 2 Use the viewer area to adjust the camera angle, set the upper, lower, left and right limits, and the telephoto and wide-angle views, clicking [Get value] for each position set.

The imported view restriction is reflected in the value input box.

For more detailed settings, you can directly input values into value input boxes.

- 3 Click the [Display in panorama screen] button.

You can confirm the loaded setting values were updated in the panorama screen.

- 4 Click [Save settings].

The settings are saved to the camera.

Note

- The controllable range and range that can be captured are as follows.

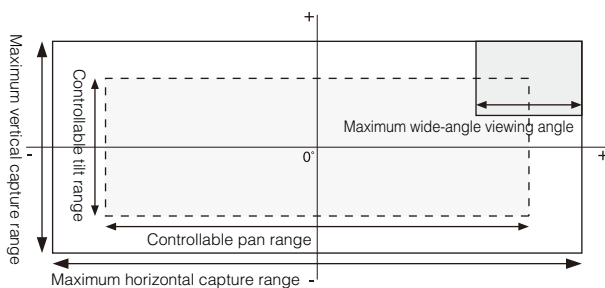

- The pan and tilt ranges vary depending on the zoom ratio (view angle).

Setting view restrictions automatically restricts the camera operating angle.

At wide-angle, the camera operating angle would allow capture outside the view restrictions if the angle remained the same. Therefore, it is narrowed automatically.

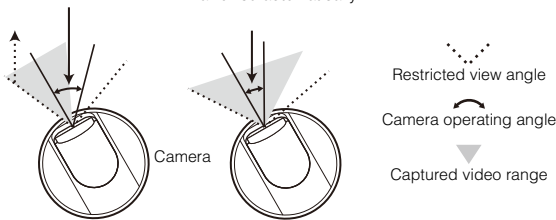

- If the view restriction will be exceeded as a result of zooming toward wide-angle, the camera will first pan and tilt to a position where the maximum wide-angle zoom will be within the viewing restriction area. Wide-angle zoom control will then be enabled within the view restriction area.

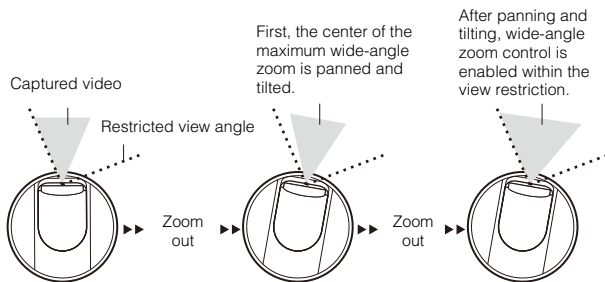

- Reducing the view restriction may also reduce the zoom range.

■ Auto Flip and View Restriction Settings

Under the following conditions, when the View Restriction Setting Tool is launched or [Restore settings] is clicked, a message appears indicating that the view restriction setting values are disabled and  (warning icon) appears to the left of the [View Restriction Settings] setting value input box.

Conditions

- [Apply the view restriction] is selected.
- [Camera] > [Camera Settings] > [Camera Control] > [Auto Flip] is set to [Enable] in the Setting Page (P. 76).
- When [Camera] > [Camera Settings] > [Installation Conditions] > [Image Flip] is set to [Disable] in the Setting Page (P. 78): [Lower Limit], [Left Limit], or [Right Limit] has been entered for [View Restriction Settings].
- When [Camera] > [Camera Settings] > [Installation Conditions] > [Image Flip] is set to [Enable] in the Setting Page (P. 78): [Lower Limit], [Left Limit], or [Right Limit] has been entered for [View Restriction Settings].

[Save settings] is clicked when [View Restriction Settings] is enabled.

Under the above conditions, a message also appears indicating that Auto Flip is disabled when [Save settings] is clicked.

When you click [OK] in the message, Auto Flip is disabled and the [View Restriction Settings] are saved.

Intelligent Function Setting Tool Overview

Intelligent Function

The Intelligent Function records video, sends e-mail notifications, plays audio and starts other operations when it detects changes in the video due to subject movement.

The Intelligent Function has the following modes.

- Video Detection
- Auto Tracking **R11** **R10**
- Audio Detection **R11** **M641** **M741**

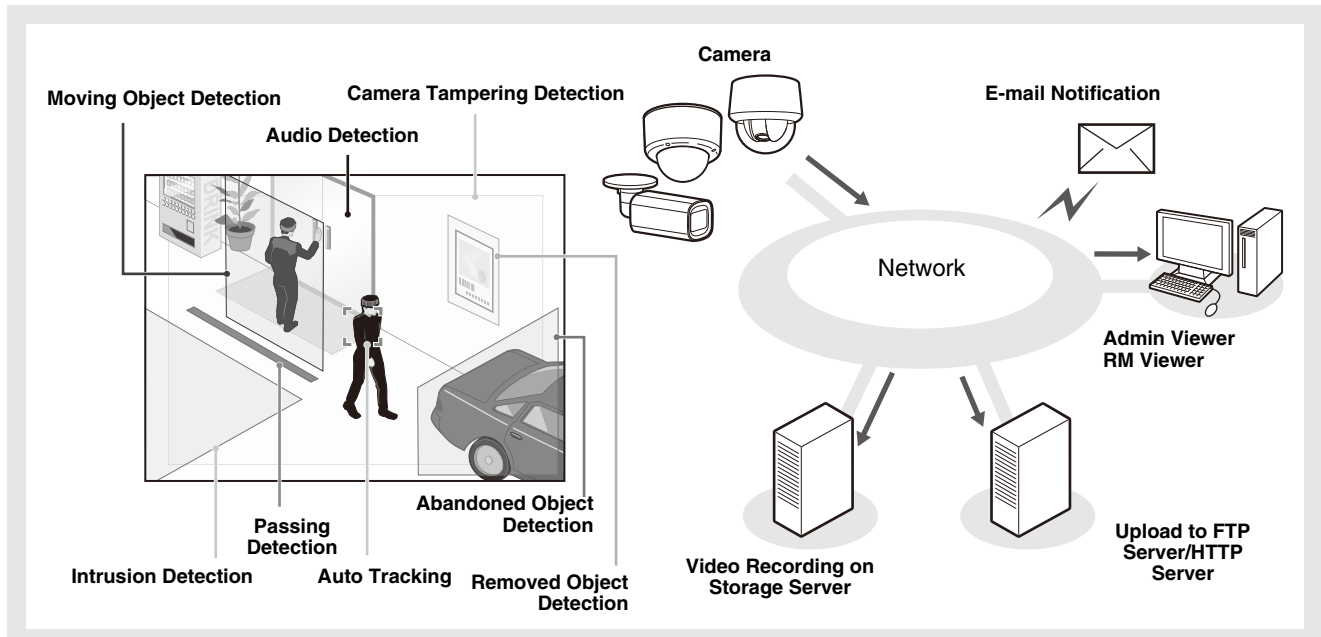

Notes on Use of This Camera

The Intelligent Function is not suitable for applications where high reliability is required. If constant and maximum reliability is required for surveillance it is not recommended that you use this function. Canon shall assume no liability for any accident, loss or other undesirable outcomes resulting from Intelligent Function operations.

Video Detection

Detects changes to video in a specified area. There are 6 types of detection to suit your needs.

Moving Object Detection

Detect moving objects. This function can be used to detect visitors or suspicious individuals. Moving object detection is triggered while moving objects are inside the detection area.

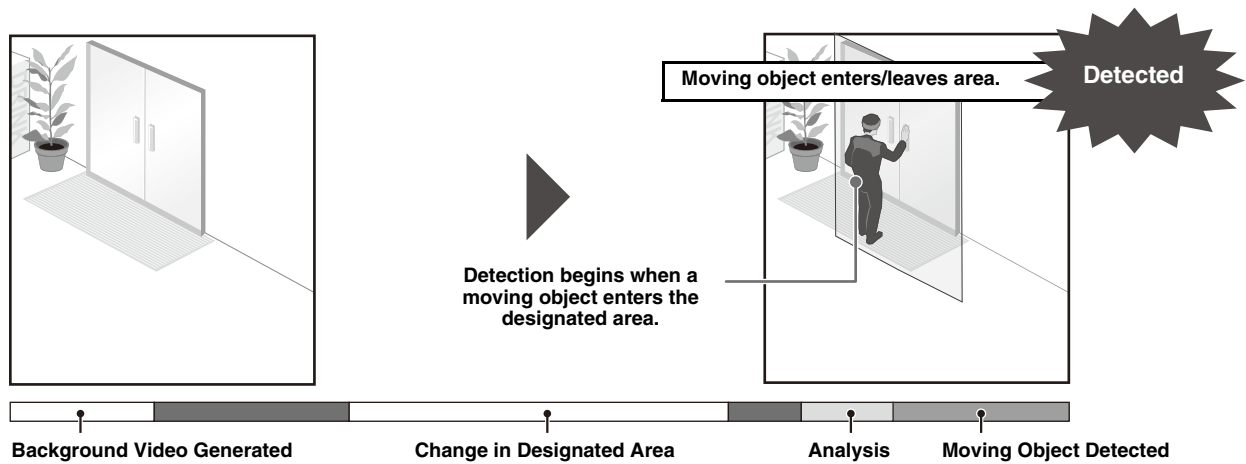

Abandoned Object Detection

Detect objects that are carried in and abandoned for a certain duration. This function can be used to detect suspicious objects that have been left behind. Abandoned object detection is triggered when an object is left in the detection area for a specified duration.

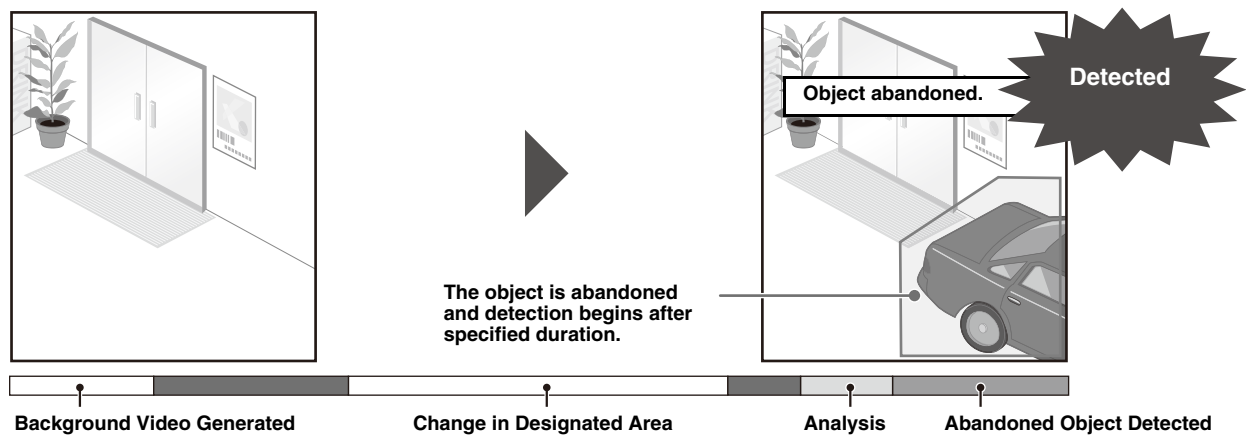

Removed Object Detection

Detect objects that have been removed. This can be used to detect actions such as the taking away of valuables. Removed object detection is triggered when an object is removed from the detection area for a specified duration.

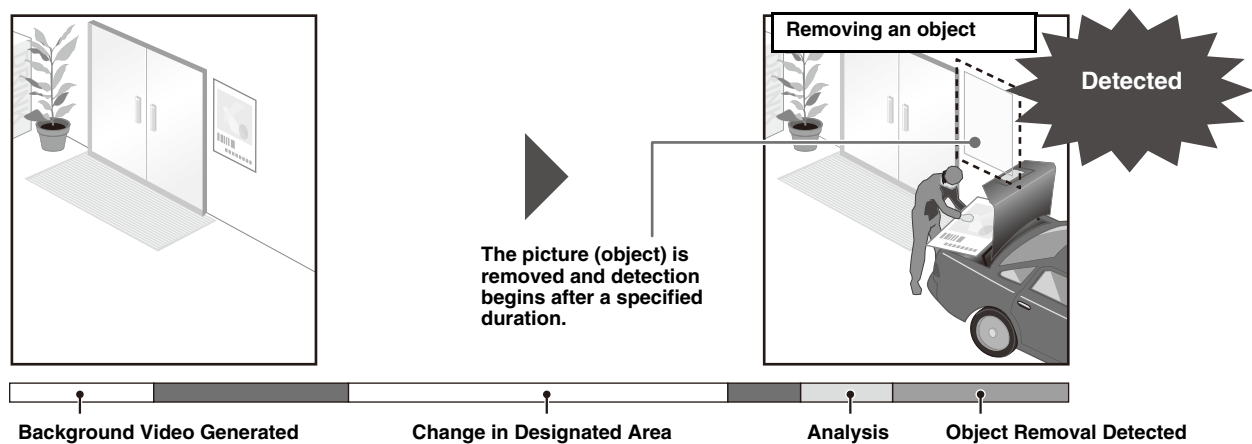

Camera Tampering Detection

Detect when capture is being disrupted. This can be used to detect when the camera orientation is changed or the video display is obscured with spray, etc. Camera tampering detection is triggered when an area exceeding a specified ratio of change is continuously altered.

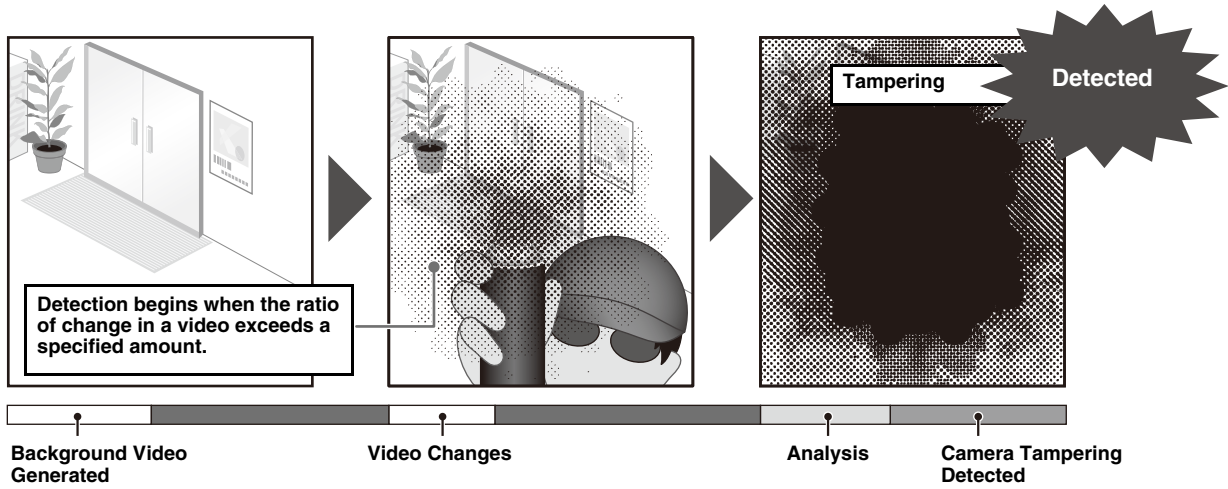

Passing Detection

Detect when a person or moving object crosses a specified line.

This determines that an object is passing when the decision point of the object detection frame crosses a detection line.

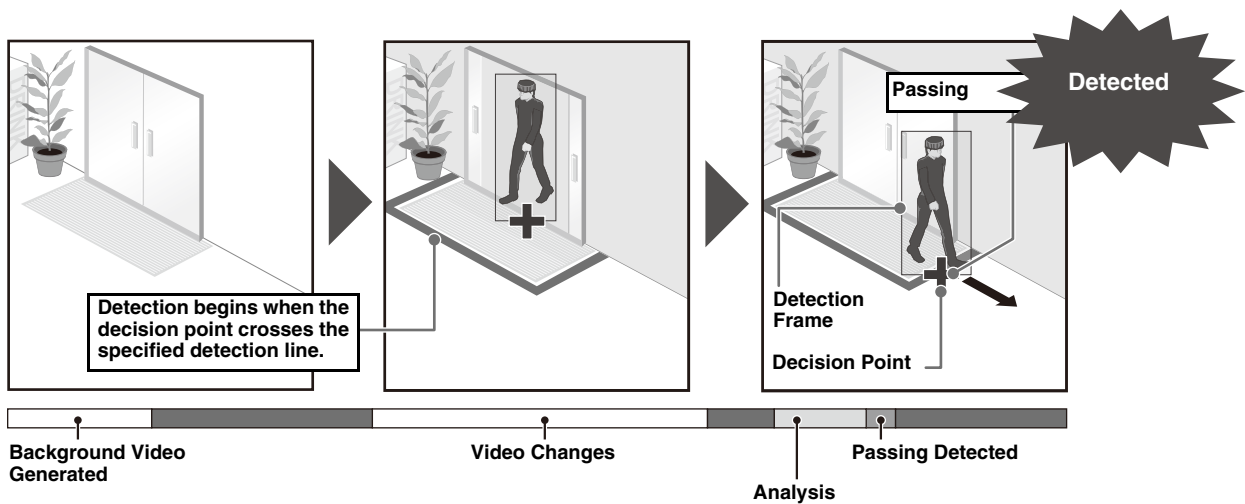

Intrusion Detection

Detect when a person or moving object crosses a specified area. This can be used to detect actions such as when someone climbs over a barrier and enters a restricted area in a museum, etc. This determines that an object is entering when the decision point of the object detection frame enters the detection area and the specified duration has elapsed.

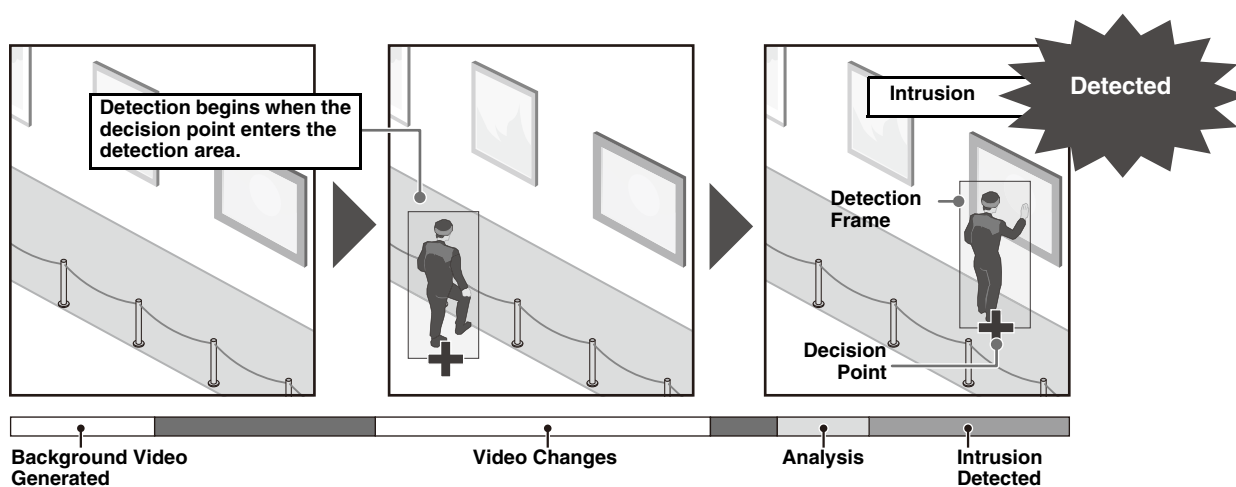

Auto Tracking

R11 R10

The camera automatically tracks an object when it is detected moving in a detection area. This allows monitoring movement, such as of suspicious persons.

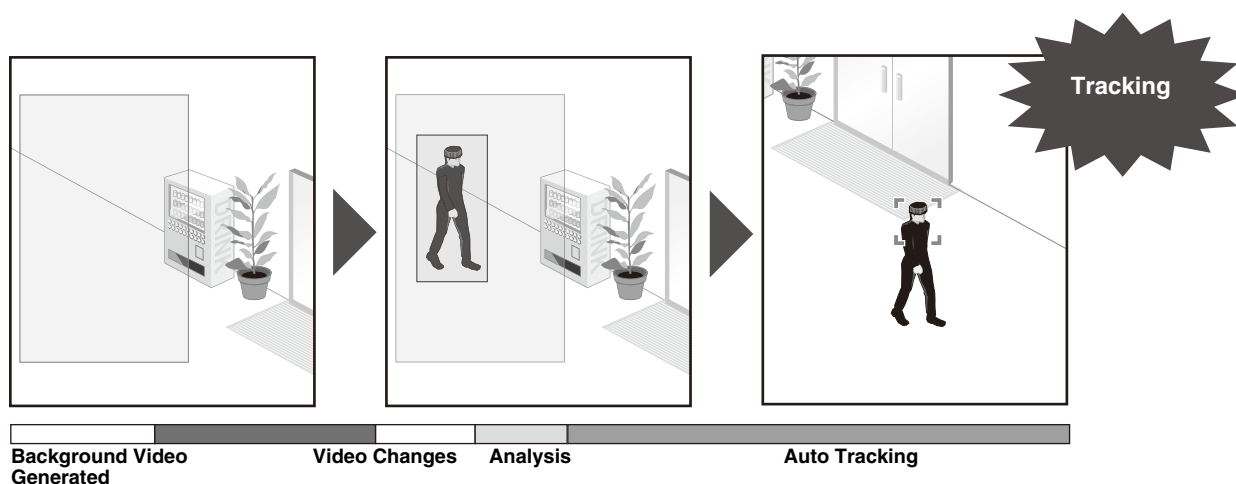

Audio Detection

R11 M641 M741

Detects audio input to the camera. There are 2 types of detection.

These are set with [Event] > [Audio Detection] (P. 107) on the Setting Page, not with the Intelligent Function Setting Tool.

[Volume Detection]: Detects when volume level exceeds or falls below a reference volume.

[Scream Detection]: Detects screams or cries from people.

Notes on Intelligent Function Settings and Operations

- When setting the Intelligent Function, do an actual detection/tracking test to confirm that detection will be performed correctly.
- If a sudden change in lightness or darkness occurs within the entire screen, proper detection may not be possible for up to five minutes. When tracking, the effect will be visible as soon as there is change in the scene.
- When the image is zoomed in (telephoto), detection/tracking may not work as expected.
- Detection/tracking will not be performed while the Intelligent Function is restarting.

- If the camera is operated while configuring or using the Intelligent Function, [Restarting intelligent function. Please wait.] is shown and the Intelligent Function will restart.
- If the display switches between Day mode and Night mode, [Restarting intelligent function. Please wait.] is shown and intelligent function will restart.
- If [Basic Settings] > [Video Settings] > [All Videos] > [Video Size Set] settings on the Setting Page are changed, be sure to change the preset position settings (only for the VB-R11VE/VB-R11/VB-R10VE) and Intelligent Function settings, and check operations. The Intelligent Function may not operate, depending on the settings.

R11 R10

- Set the Intelligent Function again if the angle of view is changed through camera operation, or the camera position of a preset or home position is changed.
- If [Status] in [Detection Setting List] is [Enabled] when the camera position is fixed, control privileges cannot be obtained by VB Viewer or RM. Also, the preset tour will no longer run.

■ Difficult-to-Detect Subjects

The following subjects may not be detected/tracked, or may result in erroneous detection/tracking.

- Objects or areas where there is little contrast in color or brightness with the background may not be detected/tracked.
- Small objects and changes on the screen may not be detected/tracked.
- Partial or entire changes in brightness on the screen may trigger detection/tracking.
- When there are multiple overlapping objects, there may be a change in detection. For example, objects passing may either not be detected or the timing of detection may be incorrect.
- When there are large numbers of objects in the scene, objects may not be properly detected/tracked.
- Objects with little movement may not be tracked.
- Objects directly below the camera may take time to be tracked.
- Areas with bright reflections or selected areas that are very bright, can result in an object not probably being tracked.

Pre-register Presets **R11 R10**

It is strongly recommended that you register the camera angle as a preset in advance and lock the camera to that position when using video detection. It is also recommended that the field of view that captures targeted objects at a larger ratio be used.

For details on preset registration, please refer to “Register Presets” (P. 170).

Select the Intelligent Function Operation Mode **R11 R10**

Video detection and auto tracking cannot be used simultaneously. When you launch the Intelligent Function Setting Tool, you can select which one to use.

Note

The detection condition settings are retained even if you change operation modes.

- 1** Launch the Intelligent Function Setting Tool (P. 193).
- 2** Select [Video Detection] or [Auto Tracking] and click [OK].

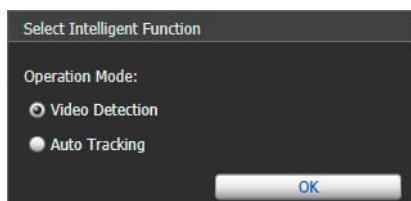

Important

[Video Detection] and [Motion Detection] are exclusive of each other. Only the selected mode operates, the other is disabled. The settings of the disabled operation mode, however, are retained (except the camera angle) and used if the mode is enabled again later.

A confirmation screen appears.

[Video Detection]

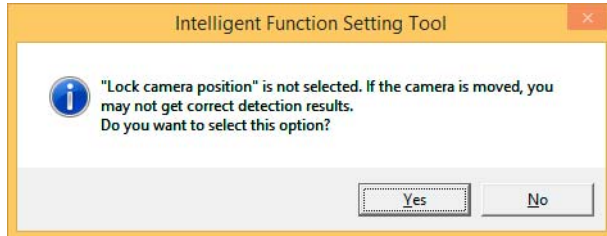

When you click [Yes], the Intelligent Function Setting Tool launches with its [Lock camera position] selected. If you click [No], select [Lock camera position] after video detection launches.

[Auto Tracking]

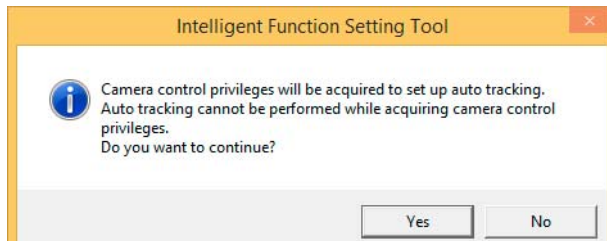

If you click [Yes], you will obtain camera control and can configure Auto Tracking settings. If you click [No], obtain camera control after Auto Tracking launches and configure Auto Tracking settings.

3 Set the Selected Operation Mode

When [Video Detection] is selected, please refer to "Intelligent Function Setting Tool - Video Detection -" (P. 216) to configure video detection settings.

When [Auto Tracking] is selected, please refer to "Intelligent Function Setting Tool - Auto Tracking -" (P. 230) to configure Auto Tracking settings.

Intelligent Function Setting Tool

- Video Detection -

In video detection, select the type to detect, and set the tracking area for video changes while checking images on the camera. You should also set which operations (e-mail notification, record video, playing audio from the speaker connected to the camera) should be carried out when changes are detected.

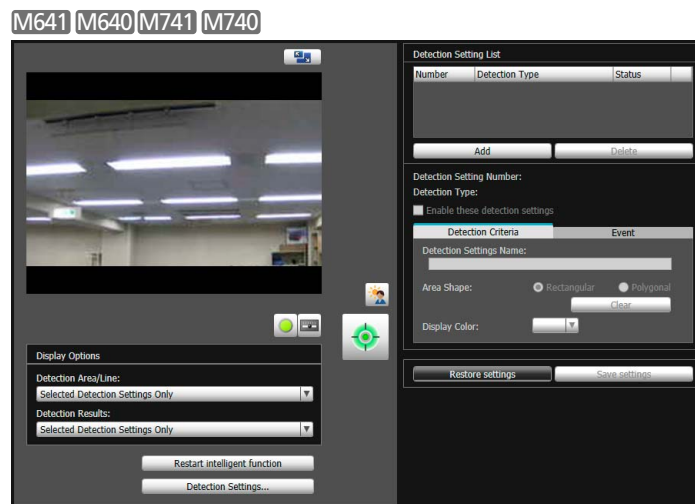
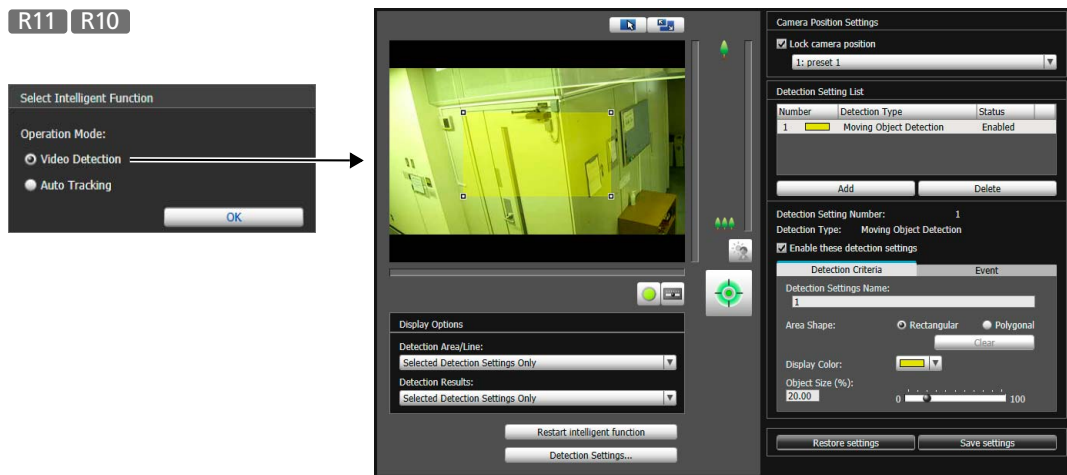

Steps for Configuring Video Detection

The following are the basic steps for configuring video detection. For details on settings for each type of detection, please refer to “Configure Detection Criteria ([Detection Criteria] Tab)” (P. 219).

- 1 Select [Lock camera position] in [Camera Position Settings], then select a preset. **R11 R10**

For details on how to adjust presets, please refer to “Register Presets” (P. 170).

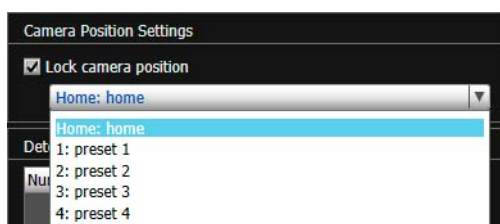

Note

You can select presets that meet the following conditions.

- Presets configured within the view restrictions.
- Presets with pan, tilt and zoom setting values (no empty entries) configured in the [Preset Registration] tab. (P. 171)

2 Click [Add] in [Detection Setting List].

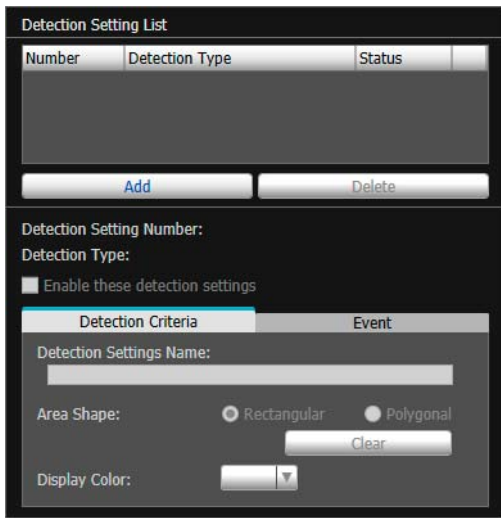

3 Select [Detection Setting Number] (1 to 15) and [Detection Type] for the detection setting to be added.

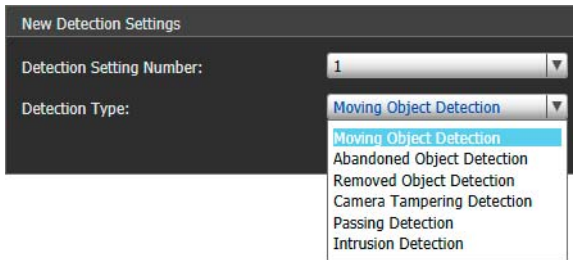

Note

You can register up to 15 detection settings.

4 Click [OK].

The added detection setting will appear in the [Detection Setting List] and [Detect Criteria] tab.

5 Select [Enable these detection settings].

To disable detection settings, clear this check box.

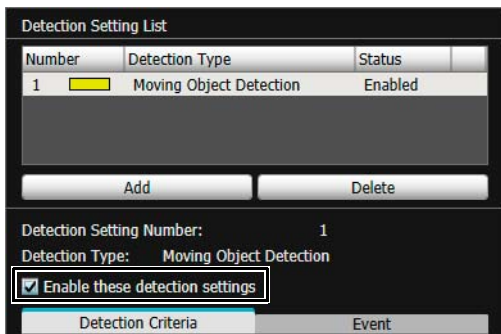

6 Configure the detection criteria.

Set criteria in the video display area or [Detection Criteria] tab (P. 219). The detection criteria differ according to the detection type.

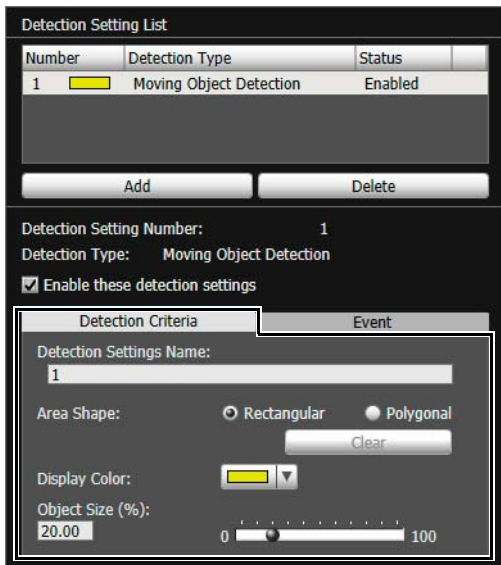

7 Configure event settings.

Set which operations to carry out for video detection in the [Event] tab (P. 227).

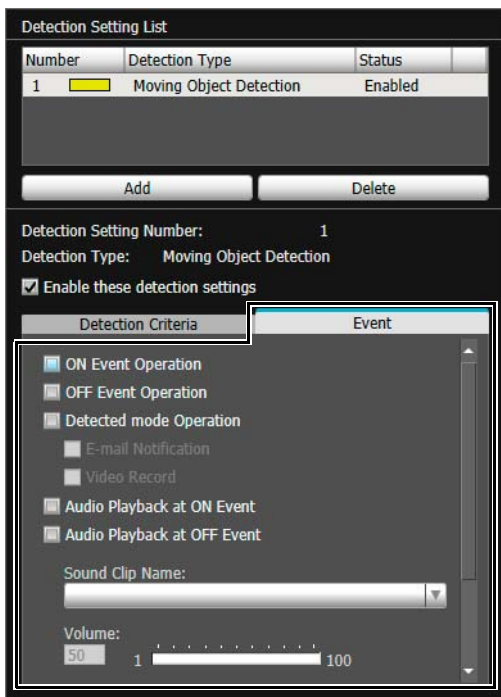

8 Click [Save settings].

The settings are saved to the camera.

Note

To restore settings, click [Restore Settings] before saving. This discards the settings you have specified and restores the settings saved in the camera.

9 To register multiple detection settings, repeat steps 2 to 8.

10 Check the detection result.

You can check the detection status of the specified detection settings in video display area and the event display panel (P. 234).

Configure Detection Criteria ([Detection Criteria] Tab)

Detection criteria is controlled and set in the video display area for each type of detection.

Important

It is recommended that you configure the detection criteria in conditions as close as possible to the actual conditions in which you will use the camera.

■ Settings Common to Each Detection Type

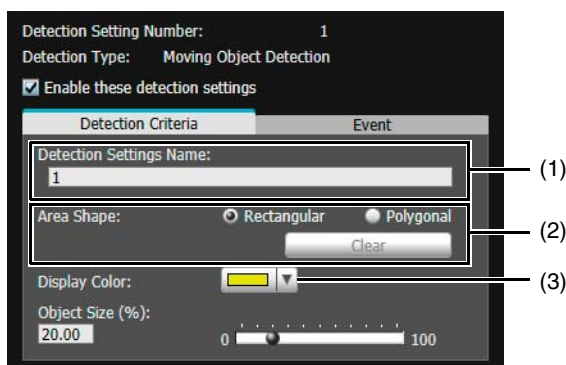

- (1) **[Detection Settings Name]**
Enter a detection name of 64 characters or less. Be sure to enter a name in [Detection Settings Name].
- (2) **[Area Shape]**
Configure whether the detection area is a rectangle or a free-shape polygon.

Note

You cannot select [Area Shape] for camera tampering detection.

Use [Rectangular]

Configure the detection area by moving, resizing or changing the shape of the rectangle that appears in the video display area.



Drag the area to move it, and drag the vertices to resize it.

Use [Polygonal]

Click the video display area to place a vertex for the polygon at the clicked position.

Place the vertices in order, then either click the first vertex again or double-click the last vertex to set the polygon detection area.



Drag the area to move it, and drag the vertices to resize it.
You can specify polygonal areas with a maximum of 32 vertices.

Note

If you change the shape of a detection area you have already configured, the area is deleted and you switch to configuring a new area.

[Clear]

The detection area configured with [Polygonal] is deleted.

(3) [Display Color]

Select the color for detection areas and detection lines.

How to Configure Moving Object Detection

Set the area you want to detect a moving object in as a detection area.

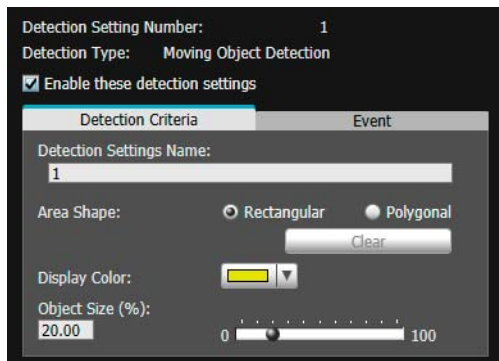

1 Select [Rectangular] or [Polygonal].

2 Use the video display area to configure the area where you would like to detect moving objects (P. 219).

3 Configure the size of the object needed for triggering detection in [Object Size (%)].

This determines how large the moving object must be in relation to the detection area you set in step 2 for motion detection to be triggered.

When the setting values or slider is changed, an indicator frame representing the object size is displayed for one second in the center of the video display area allowing you to check the size ratio while specifying the setting.

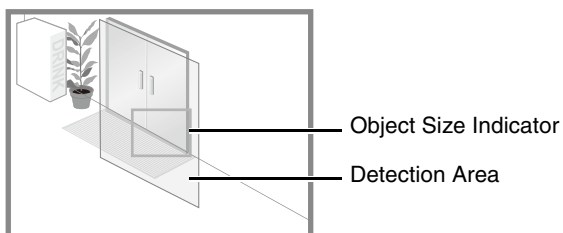

Detection Status for Moving Object Detection

All moving objects detected are shown with contour lines.

If a moving object is smaller than [Object Size (%)], its contour lines are white.

If the moving object is larger than [Object Size (%)], its contour lines take on the same color as the detection area, indicating that "detected" mode has been triggered.

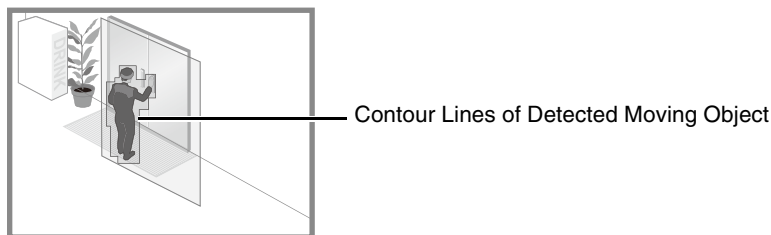

Note

If an object is placed in or removed from the moving object detection area, "detected" mode will be triggered for Moving Object Detection.

How to Configure Abandoned Object Detection

Set the area you want to detect a placed object in as a detection area.

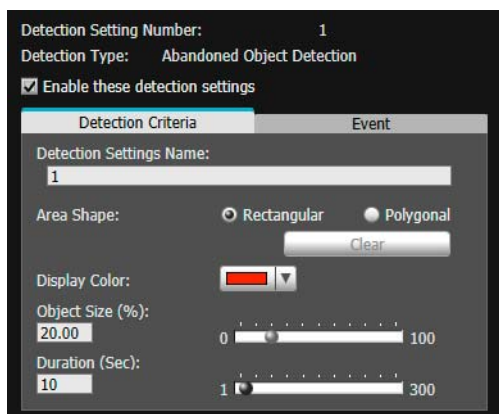

- 1 Select [Rectangular] or [Polygonal].
- 2 Use the video display area to configure the area where you would like to detect abandoned objects (P. 219).
- 3 Configure the size of the object needed for triggering detection in [Object Size (%)].

This determines how large the abandoned object must be in relation to the detection area you set in step 2 for abandoned object detection to be triggered.

When the setting values or slider is changed, an indicator frame representing the object size is displayed for one second in the center of the video display area allowing you to check the size ratio while specifying the setting.

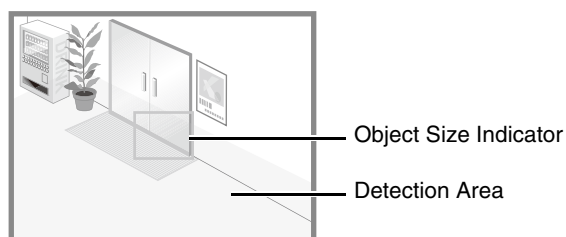

- 4 Configure [Duration (Sec)] for the time required for an object to be detected as an abandoned object.

Detection Status for Abandoned Object Detection

All moving objects detected are shown with contour lines.

If [Object Size (%)] and [Duration (Sec)] are not exceeded, contour lines are white.

If both [Object Size (%)] and [Duration (Sec)] are exceeded, the contour lines take on the same color as the detection area, indicating that "detected" mode has been triggered.

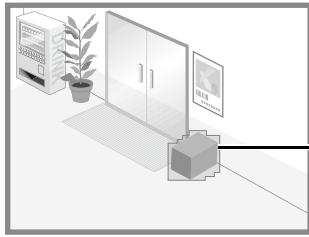

Contours of Moving Object Detected as Abandoned

How to Configure Removed Object Detection

Set an area around the target objects, for Removed Object Detection. If there are multiple objects for which you want to enable detection, be sure to configure Removed Object Detection for each object.

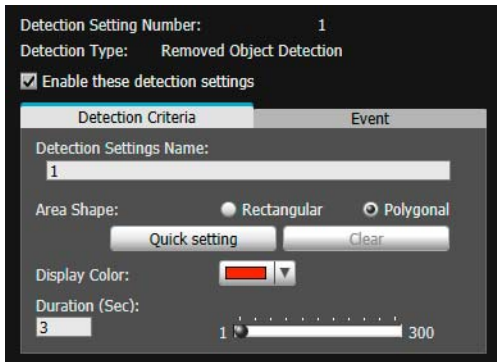

1 Select [Rectangular] or [Polygonal].

2 Use the video display area to configure an area along the contours of the object you do not want removed (P. 219). You can also click [Quick setting] and follow the steps below to configure the area.

Temporarily remove the target object for removed object detection from the video display area.

Click [Restart intelligent function] (P. 235).

The background image is generated

Return the target object to its original position.

Click [Quick setting].

An outline of the object is drawn using a polygon with up to 32 vertices.

If there are multiple objects detected, the outline is drawn around the object occupying the largest area.

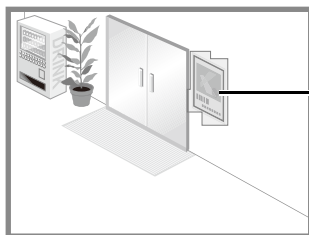

Set detection area

Click [Restart intelligent function] again.

Important

Set detection areas for removed object detection so that they precisely match the contours of the target object. Influence from the target object's shadow or adjacent objects may result in the target object being recognized as larger than it actually is and will not trigger removed object detection. In this occurs, reconfigure the detection area to outline the recognized target object.

- 3 Configure [Duration (Sec)] for time required for an object to be detected as a removed object.

Detection Status for Removed Object Detection

All moving objects detected are shown with contour lines.

As long as [Duration (Sec)] is not exceeded, contour lines are white.

When [Duration (Sec)] is exceeded, contour lines take on the same color as the detection area, indicating that "detected" mode has been triggered.

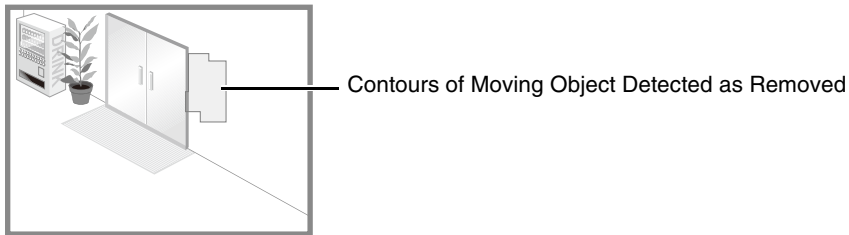

How to Configure Camera Tampering Detection

For [Camera Tampering Detection], the entire video display area is the detection area. The area cannot be changed.

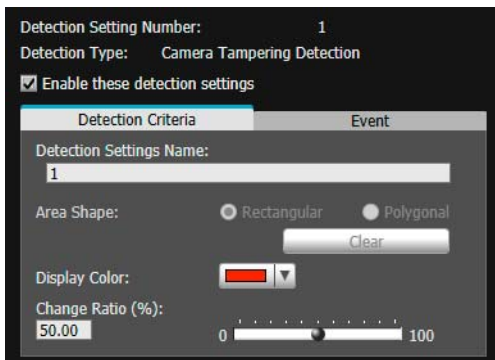

In [Change Ratio (%)], you can set the ratio of screen change for tampering detection to be determined in relation to the entire video display area.

When the setting values or slider is changed, an indicator frame representing the area of the entire video display area that can be obstructed is displayed for one second in the center of the video display area allowing you to check while specifying the setting.

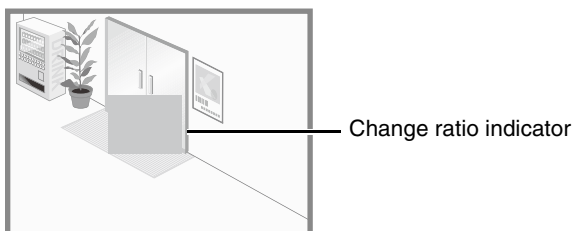

Detection Status for Camera Tampering Detection

All moving objects detected are shown with contour lines.

If an object is smaller than [Change Ratio (%)], its contour lines are white.

If the obscured area in the video exceeds [Change Ratio (%)], contour lines take on the same color as the detection area, indicating that "detected" mode has been triggered.

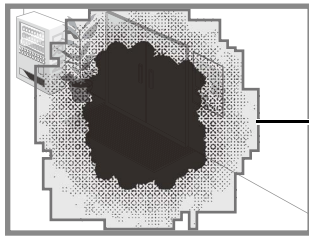

Contours of Moving Object Detected as Tampering



Note

Detection will not be possible for three seconds after the change ratio for camera tampering detection is changed, or when switching into camera tampering detection from another detection mode.

How to Configure Passing Detection

The detection line for passing moving objects is determined by setting the passing direction and object decision point.

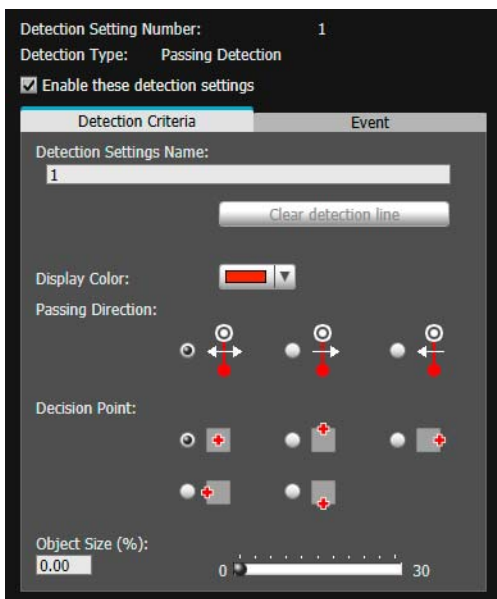

1 Follow the steps below to use the video display area to configure the passing detection line.

In the video display area, click the start point of the detection line.



Click another location.

The passing detection line will be set between the start point and next point you clicked.

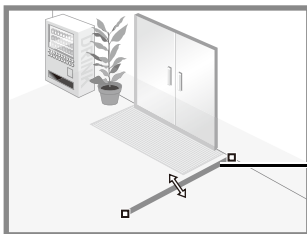

Detection line



To configure a polygonal detection line, click the vertices of the line in order.

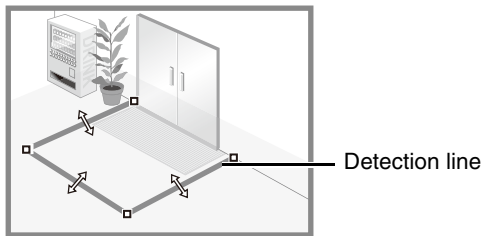

You can configure a polygonal detection line with a maximum of 32 vertices.

▼
Click any of the set vertices.
The detection line is determined.

Note

- Even after configuring a detection line, you can drag each vertex to change the shape of the detection line and the lines between vertices to move the entire detection line.
- Click [Clear detection line] to delete a detection line.

2 In [Passing Direction], select the direction for moving objects to pass the detection line.

If a moving object crosses the detection line in the selected direction, it will be detected as 'passed'.
A preview display shows the selected passing direction on the detection line in the video display area.

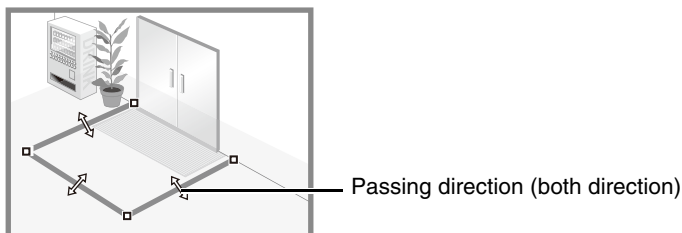

3 In [Decision Point], select the point of a moving object that will be used for triggering passing detection when the moving object crosses a detection line.

If the selected decision point crosses the detection line, it will be detected as 'passed'.
The decision point is indicated by a cross on the detection frame of the moving object.

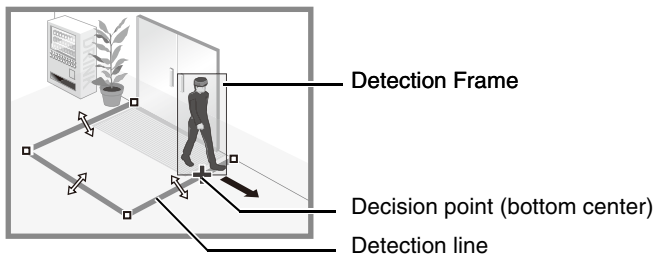

4 Configure the size of the moving object needed for triggering detection in [Object Size (%)].

Set the size ratio of moving objects for the entire screen.
If the moving object exceeds the set value for [Object Size (%)], it will be targeted for passing detection.
When the setting values or slider is changed, an indicator frame representing the object size is displayed for one second in the center of the video display area allowing you to check the size ratio while specifying the setting.

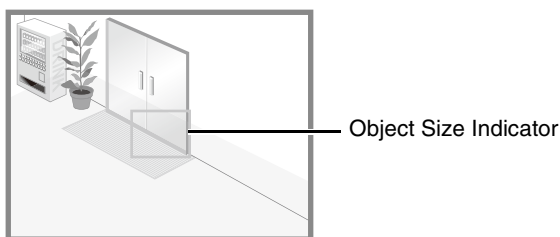

Note

A ratio of up to 30% can be set in [Object Size (%)] for passing detection.

Detection Status for Passing Detection

All moving objects detected are shown with white contour lines.

When the [Decision Point] of a moving object that exceeds the [Object Size (%)] setting crosses a detection line in the direction specified in [Passing Direction], The contour line changes to the same color as the detection line, and "detected" mode is triggered.

A passing detection event notification only occurs when the decision line is crossed. Take care in setting the operation to be performed when an event occurs.



Important

Perform a detection test after configuring passing detection to make sure the detection frame of a moving object continues to be displayed.

How to Configure Intrusion Detection

Set the area you want to detect intrusions.

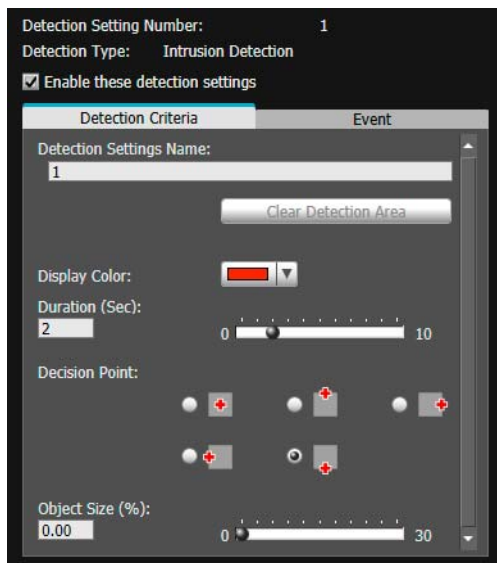

- 1 Use the video display area to configure the area where you would like to detect intruding objects (P. 219).
- 2 Configure [Duration (Sec)] for the time required for an object to enter a detection area, and be detected as an intrusion.
- 3 In [Decision Point], select the point of a moving object that will be used for triggering intrusion detection when the moving object enters a detection area.
The decision point is indicated by a cross on the detection frame of the moving object.

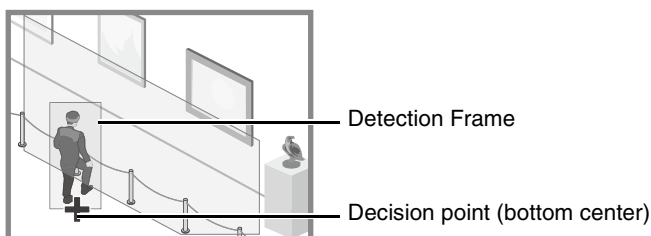

- 4 Configure the size of the moving object needed to trigger detection in [Object Size (%)].

Set the size ratio of moving objects for the entire screen.

When the setting values or slider is changed, an indicator frame representing the object size is displayed for one second in the center of the video display area allowing you to check the size ratio while specifying the setting.

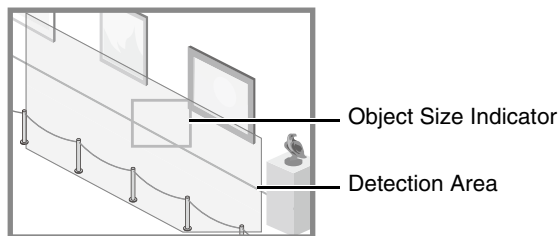

Detection Status for Intrusion Detection

All moving objects detected are shown with contour lines.

When [Decision Point] of a moving object larger than [Object Size (%)] enters a detection area and exceeds [Duration (Sec)], its contour lines take on the same color as the detection area, indicating that “detected” mode has been triggered.

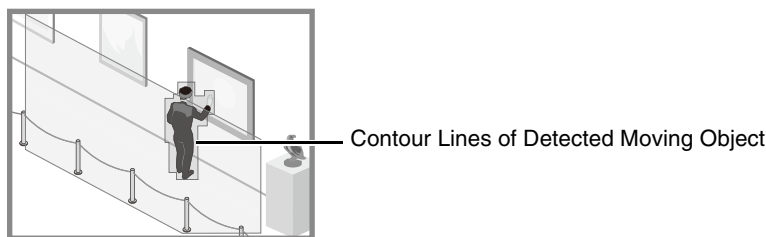

Important

After the Triggered Detection is set, please confirm that the system continues to show contour lines of the Detected Moving Object.

Configure Operations for Triggered Detection ([Event] Tab)

Set operations to be performed upon detection of changes in a subject.

This will also explain the [Event] tab in [Auto Tracking].

Video Detection

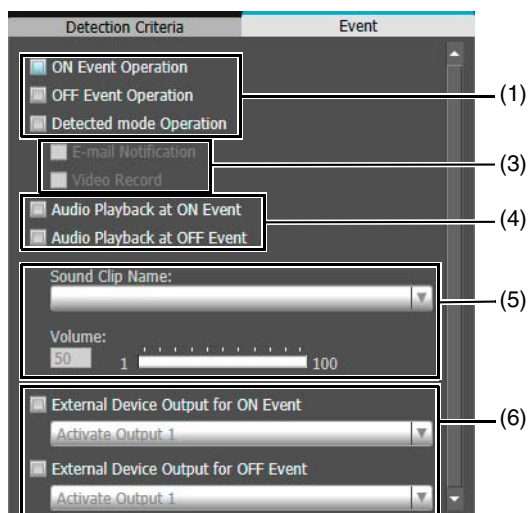

Auto Tracking R11 R10

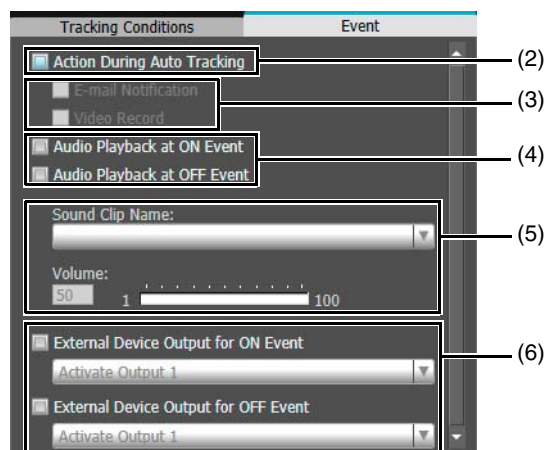

(1) Specify Operation Timing (Multiple Selections Possible)

[ON Event Operation]

When selected, the operations set in (3) are performed when “detected” mode is triggered.

[OFF Event Operation]

When selected, the operations set in (3) are performed when “detected” mode ends.

[Detected mode Operation]

When selected, the operations set in (3) are performed while “detected” mode is active.

(2) [Action During Auto Tracking] **R11 R10**

When selected, the operations set in (3) are performed while the moving object is automatically tracked.

(3) Specify Event Operation (Multiple Selections Possible)

[E-mail Notification]

When selected, e-mail notification is sent according to the timing set in (1) or (2). [Video Record] > [E-mail Notification] in the Setting Page must be set in advance (P. 102).

[Video Record]

When selected, video recording begins according to the timing specified in (1) or (2). [Video Record] > [Upload] or [Memory Card] > [Video Record Setting] in the Setting Page must be set in advance (P. 96).

(4) Specify Audio Playback Timing **R11 M641 M741**

[Audio Playback at ON Event]

When selected, the sound clip specified in (5) is played back when “detected” mode is triggered.

[Audio Playback at OFF Event]

When selected, the sound clip specified in (5) is played back when “detected” mode ends.

(5) Sound Clip Settings **R11 M641 M741**

[Sound Clip Name]

Select the sound clip to be played back. You must register the sound clip with [Video and Audio] > [Audio Settings] > [Sound Clip Upload] (P. 88) in the Setting Page in advance.

[Volume]

Set the volume for the sound clip.

(6) External Device Output Operations **R11 M641 M741**

[External Device Output for ON Event]

Select this to start or pause output to an external device when the “detected” mode is triggered, and to select the output destination (output 1 or 2) and operation (active or inactive).

[External Device Output for OFF Event]

When “detected” mode ends, select whether or not to begin output to an external device or pause, and select the output destination (output 1 or 2) and operation (active or inactive).

Reduce Effects of Lighting Change (Detections Settings)

The Intelligent Function may not work when the entire screen is exposed to sudden changes in brightness, for example, when indoor lights are turned on or off. Changing the detection settings may reduce this effect.

1 Click [Detection Settings].

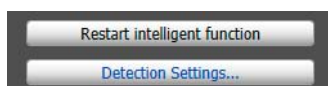

2 Select [Reduce effects of lighting change].

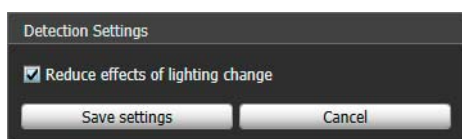

3 Click [Save settings].

The settings are saved and the Intelligent Function restarts.



Important

- It takes several seconds for the Intelligent Function to restart. No detection is performed while restarting.
- Settings in [Reduce effects of lighting change] may not work depending on the operating environment. Sudden changes in brightness that persist may also have the same effect. Perform a detection test to check whether settings work correctly.

Context Menu

Right-click on the video detection setting screen to display a menu that allows you to use the following functions. Unavailable functions will be grayed-out when you right-click.



Note

If you right-click while using auto tracking, the context menu will appear but none of the functions will be available.

[Copy detection area/line]

Copy the detection area/line of the selected detection setting to the clipboard.

[Paste detection area/line]

Paste the copied detection area/line from the clipboard to the detection setting being configured. Paste cannot be used with camera tampering detection.

Pasting a detection line is possible only when the source and the target both set passing detection.

[Clear detection area/line]

Delete the detection area/line of the selected detection setting. The camera tampering detection area cannot be deleted.

[Copy detection criteria settings]

Copy the detection criteria of the selected detection setting to the clipboard.

[Paste detection criteria settings]

Paste the copied detection criteria from the clipboard to the detection setting being configured. Pasting is possible only if the source and the target are the same detection type.

[Copy event settings]

Copy the event setting of the selected detection setting to the clipboard.

[Paste event settings]

Paste the copied event setting from the clipboard to the detection setting being configured.

For Auto Tracking, set the detection area for moving objects while checking the video on the computer screen. The camera is controlled so that the detected moving object appears near the center of the video display area. You can also set which operations (such as e-mail notification, recording video, or playing audio from the speaker connected to the camera) are carried out when detection occurs.



Set Auto Tracking

Use the following steps to set Auto Tracking.

- 1 Obtain camera control privileges to set Auto Tracking. (P. 158)
- 2 Select [Specify the initial camera position] in [Camera Position Settings], then select a preset.

For details on how to adjust presets, please refer to "Register Presets" (P. 170).

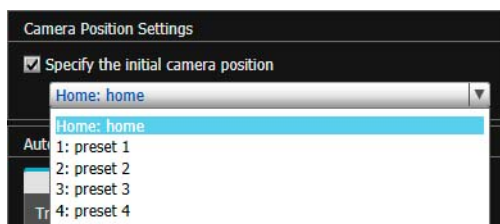

If you select [Specify the initial camera position], the camera angle will be moved to the selected preset position. The camera angle will also be moved to the selected preset position after Auto Tracking ends.

Important

It is recommended that you configure preset camera angles in advance, so the camera will move to the preset position when auto tracking starts or ends.

Note

You can select presets that meet the following conditions.

- Presets configured within the view restrictions.
- Presets with [Show in viewers] selected in the [Preset Registration] tab (P. 171).
- Presets with pan, tilt and zoom setting values (no empty entries) configured in the [Preset Registration] tab (P. 171).

3 Configure the detection area in the video display area.

Use a rectangle to specify the detection area (P. 219).

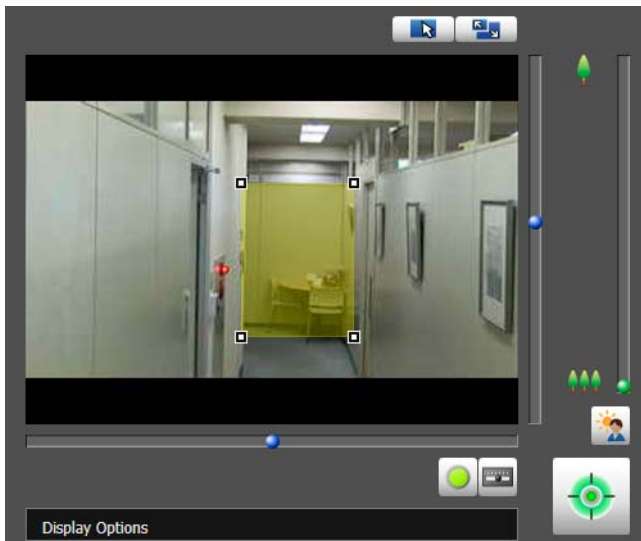

Note

The detection area is set to display within a rectangular area by default. It cannot be set to the edge of the video display area.

4 Configure the size the moving object needed to trigger detection in [Object Size (%)] in the [Tracking Conditions] tab.

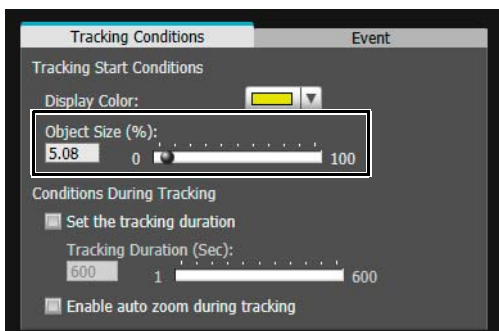

Set the size ratio of moving objects for the entire screen.

When the setting values or slider is changed, or the detection area is changed, an indicator frame representing the object size is displayed for one second in the center of the video display area allowing you to check the size ratio while specifying the setting.

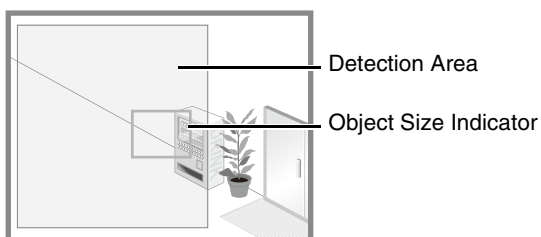

5 To configure the time to continue auto tracking, select [Set the tracking duration] and set the time in [Tracking Duration (Sec)].

After the subject is in “detected” mode, the camera tracks it for the specified time.

6 To automatically zoom in on the moving object while tracking, select [Enable auto zoom during tracking].

When selected, the camera zooms in on the moving object and automatically tracks it.

7 In the [Event] tab, configure the operations to be performed when “detected” mode is triggered.

For details on settings, please refer to “Configure Operations for Triggered Detection ([Event] Tab)” (P. 227).

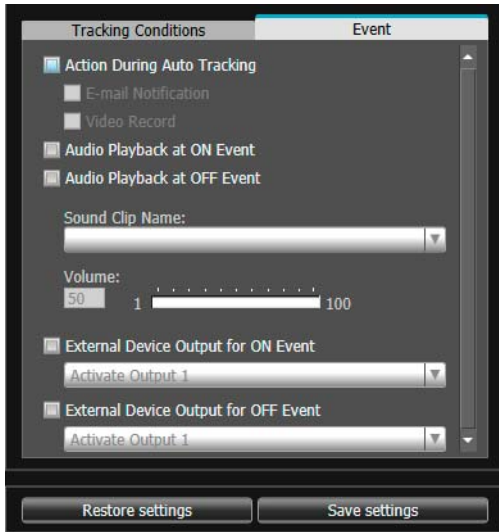

8 Click [Save settings].

The settings are saved to the camera.

9 In the message box displayed, click [Yes].

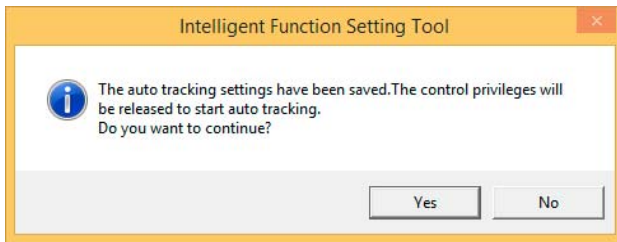

If you keep control privileges, an ON event is triggered as “detected” mode and the camera does not automatically track even when a subject is detected that meets tracking start conditions. For the camera to automatically track moving objects, it is necessary to release control privileges.

Detection Status for Auto Tracking

All moving objects detected are shown with contour lines.

If a moving object is smaller than [Object Size (%)], its contour lines are white.

If the moving object is larger than [Object Size (%)], its contour lines take on the same color as the detection area, indicating that “detected” mode has been triggered.

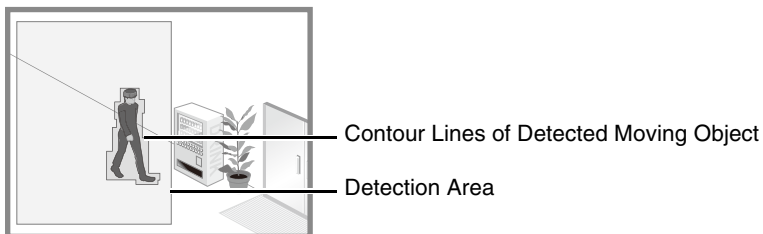

In “detected” mode, auto tracking starts and a polygon frame appears on the target object.

The camera will pan, tilt or zoom during auto tracking so the target object always appears at the center of the screen.

When [Enable auto zoom during tracking] is selected, the camera zooms in on the target and auto tracks.

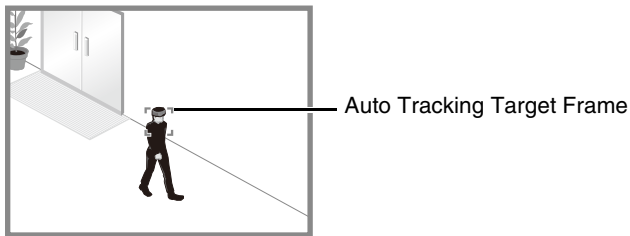

Auto tracking will start to track the first detected moving object. While auto tracking, other moving objects will not be detected even if they satisfy [Tracking Start Conditions].

Important

- When setting the Auto Tracking Function, it is recommended that you test the auto detection, to confirm that object will continue to be detected.
- Large objects closest to the center of the screen will be tracked with priority during tracking.
- During Auto Tracking, the object itself is not being recognized. Thus when two objects pass each other, or there are multiple moving objects, proper tracking of the object may not be possible.
- The camera will not track the subject if camera control privileges are enabled on the Intelligent Function Setting Tool. To allow automatic tracking with the camera, you must release the camera control privileges on the Intelligent Function Setting Tool.
- While auto tracking, preset tours will not start.
- Auto tracking beyond view restrictions is not possible.
- The privacy mask areas are also part of the auto tracking detection area.

Auto Tracking Termination

Auto tracking will be terminated in the following cases.

- Camera control privileges for auto tracking were revoked due to the following conditions.
 - The Admin Viewer obtained camera control privileges.
 - The camera moved to a preset position due to the triggering of a volume detection event or an external input device.
 - R11**
 - The camera panned or tilted due to the creation of a panorama image.
 - You obtained camera control privileges using viewer operations for auto tracking.
- The configured auto [Tracking Duration] time has elapsed.
- Tracking cannot continue because sight of the moving object was lost (examples: movement of target object was lost, target object is lost in shadow of another object, target object falls below the sizes possible for tracking, target object moves outside the possible tracking area).
- The [Intelligent Function Tool] has restarted.

When auto tracking is terminated, a tracking OFF event is triggered and the camera returns to the initial camera position (when [Specify the initial camera position] has been selected). If camera control privileges were revoked, the camera will move after camera control privileges are released.

Tracking start conditions are enabled after the camera moves back to the initial position.

Disable Auto Tracking

You can disable Auto Tracking by restarting the Intelligent Function Setting Tool and selecting [Video Detection] (P. 214) in the Intelligent Function selection screen.

Intelligent Function Setting Tool

Display Options and Shared Operations

This explains functions common to both video detection and auto tracking.

Display Event Status

Click the [Event Display] button to open the Event Display panel and confirm the detection status icon of the Intelligent Function.



This panel displays the same information as [Intelligent Function] in the Event Display panel of the Admin Viewer (P. 184).

Event Display for Detection Settings



Event Display for Auto Tracking **R11** **R10**

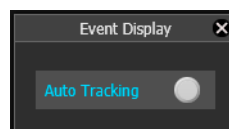

Note

If the detection setting is not saved in the camera, only the detection status for the currently selected detection setting or auto tracking is displayed.

Display Settings for Detection Areas/Detection Lines, Detection Results (Display Options)

Configure whether or not detection areas/lines and detection results appear in the video display area.

Video Detection

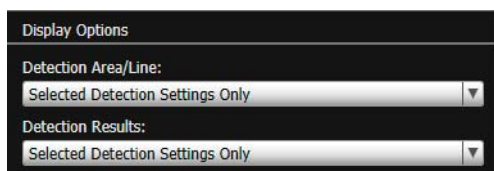

You can select the following for either [Detection Area/Line] or [Detection Results].

[Selected Detection Settings Only]

Show the detection areas/lines or detection results only for those detection settings selected in [Detection Setting List].

[All Detection Settings]

Show the detection areas/lines or detection results for all detection settings in [Detection Setting List].

[Detection Settings of the Same Type]

Show the detection areas/lines or detection results for the same type of detection settings as those selected in [Detection Setting List].

[Do not display]

No detection areas/lines or detection results are shown.

■ Auto Tracking R11 R10

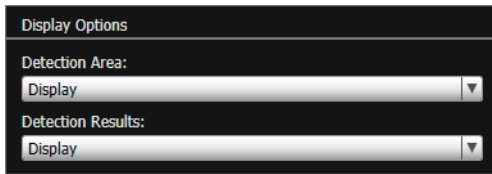

You can select [Display] / [Do not display] for either [Detection Area] or [Detection Results].

Restart Intelligent Function

If the background video has changed while you were specifying settings or detection results are not as specified, restart the Intelligent Function.

- 1** If you have not yet obtained the camera control privileges, click the [Obtain/Release Camera Control Privileges] button and obtain the control privileges.
- 2** Click [Restart intelligent function].

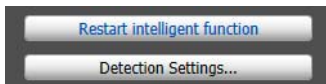

Important

It takes several tens of seconds for the Intelligent Function to restart. No detection is performed while restarting.

Log Viewer

This Viewer allows browsing the camera operation status logs recorded in the camera. You can also download the log from the camera and save the file.

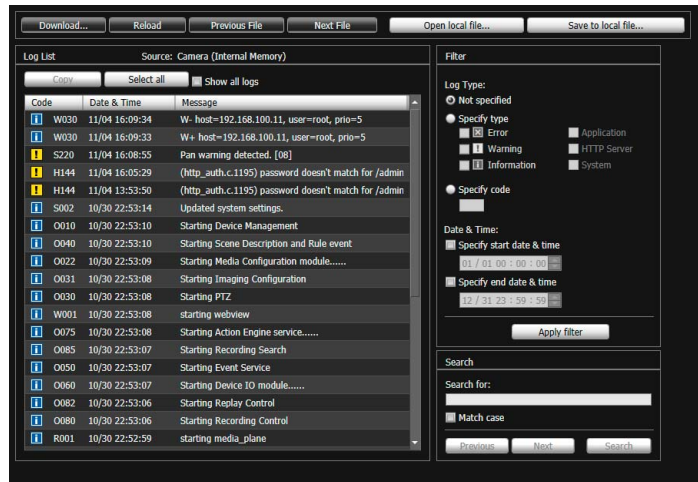

Log Viewer Screen

Download Log Files

When you launch the Log Viewer, the latest log files will be automatically downloaded from the camera and displayed in a list.

If you want to load a log file from the memory card or get a new list of log files, follow the steps below to download.

- 1 Click [Download].

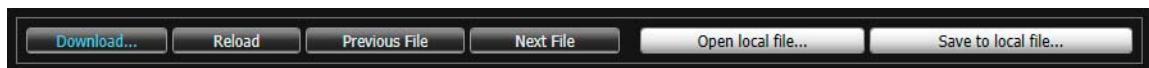

The [Download] dialog box appears.

- 2 Select [Internal memory] or [Memory Card] as the download source.

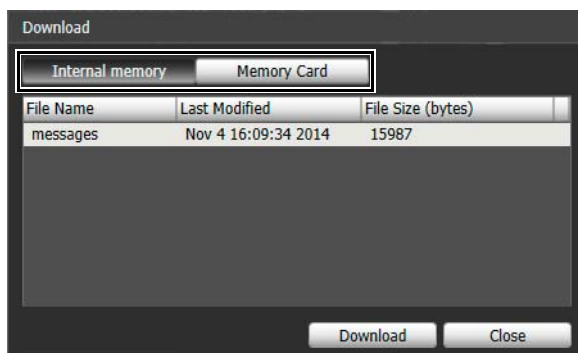

The logs in the camera memory or on the memory card will be displayed as a list.

- 3 Select a log file and click [Download].

The selected log file will be downloaded and the source for the log is displayed as follows.

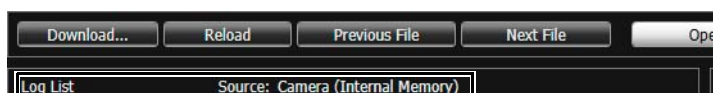

- [Camera (internal memory)]: for camera built-in memory

- [Camera (memory card)]: for the memory card
- File Name: for files saved on a computer

View Logs

The following information appears in the log.

[Code]

The log message code (P. 256).

The log code is shown together with one of three icons corresponding to the applicable level.

If the log has no log code, no icon is shown.



Error Level



Warning Level



Information Level

[Date & Time]

The date and time at which the log was generated.

[Message]

A message regarding the log.



Note

- In the Windows Control Panel, the decimal point in a value is always indicated by "." regardless of the settings of [Region and Language]. Also, the date is shown in the "yyyy/mm/dd" or "mm/dd" format, while the time is shown in the "hh:mm:ss" format. (y, m, d, h, m, and s indicate year, month, day, hour, minute, and second, respectively)
- Logs cannot be deleted in the Log Viewer.

Save/Open a Log File

You can save the log file as a text file to a computer. You can also load log files that are saved on a computer to the Log Viewer.

Save to Computer

- 1 Click [Save to local file].

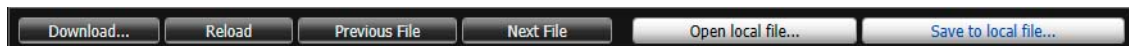

The [Save As] dialog box appears.

- 2 Select the location to save and click [Save].

Load from Computer

- 3 Click [Open local file].

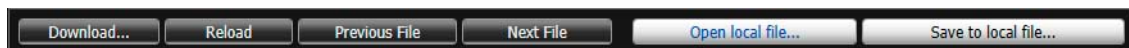

The [Open file] dialog box appears.

- 4 Select a log file to load and click [Open].

Copy Log Data

Copy log data to the clipboard.

- 1 Click to select the log you want to copy.

2 Click [Copy].

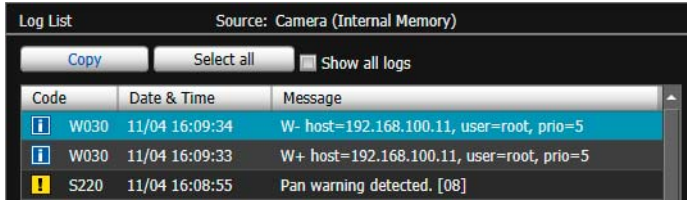

Search for a Log

1 Enter the search string into [Search for] in [Search].



2 Click [Search].

If the searched log is found, it is shown as selected.

Click [Previous] or [Next] to search for the logs above or below. Lines of logs found are shown as selected.

Show Filtered Logs

You can filter logs by type, code and date and time to only show necessary information.

1 Configure [Filter] conditions.

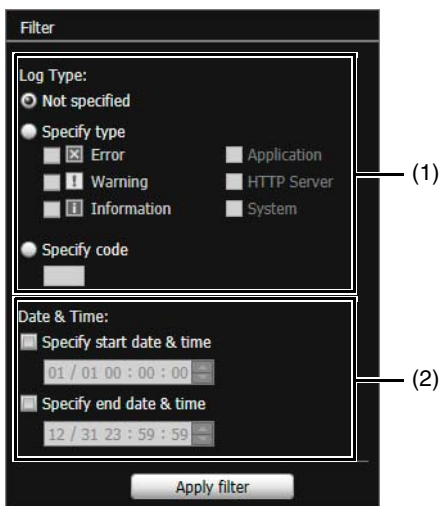

(1) [Log Type]

[Not specified]

Logs will not be filtered.

[Specify type]

Select [Error], [Warning] or [Information] for the level if logs are filtered by their levels.

To use the module output by the log for filtering, select [Application], [HTTP Server] or [System].

[Application], [HTTP Server], and [System] support the List of Log Messages (P. 256).

[Specify code]

Logs will be filtered by log code. Only logs whose code contains the entered characters are shown. If "A0" is entered, for example, logs starting with "A0" are displayed.

(2) [Date & Time]

[Specify start date & time]

When selected and a date and time are entered, logs generated on or after the specified date and time are shown.

[Specify end date & time]

When selected and a date and time are entered, logs generated on or before the specified date and time are shown.

2 Click [Apply filter]

Only shows logs matching the specified conditions.



Important

The logs saved in the camera will be deleted in the following cases.

- When [Reboot] or [Restore Default Settings] in [Maintenance] > [Tool] on the Setting Page are run.
- Factory default settings are restored with the reset switch on the camera.

Recorded Video Utility

This is a utility for browsing and managing video recorded on a memory card inserted in the camera. You can display a list of recorded video, and play back, delete and download video.

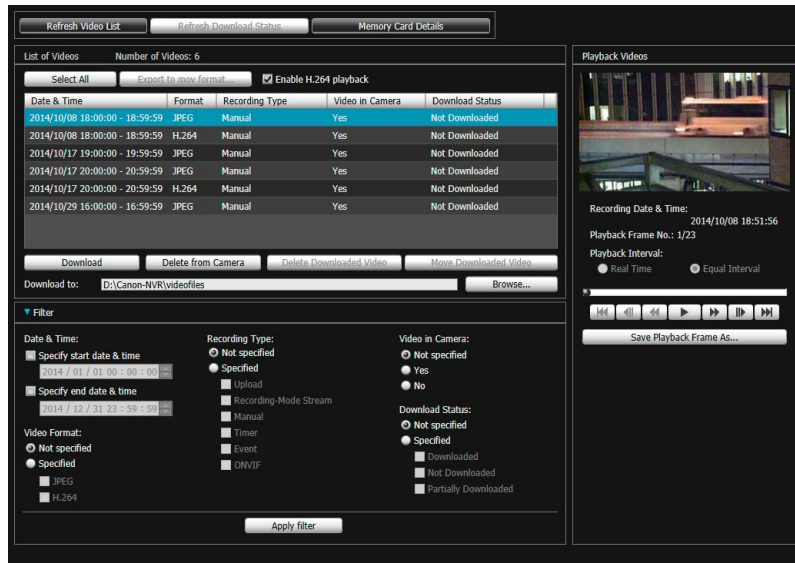

Use the Video List

Video List Display Information

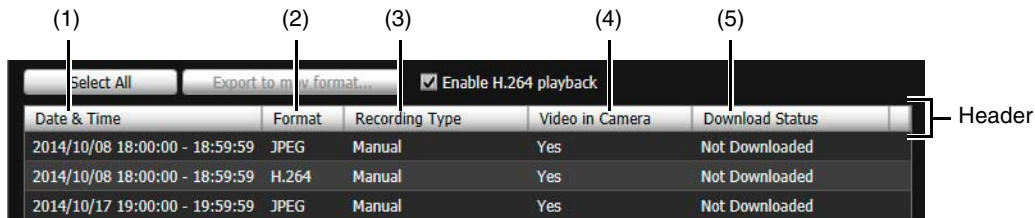

Note

If you click the header of each item, you can change the sort order (ascending or descending) for that item.

- (1) [Date & Time]
Displays the date and time of a video recording.
- (2) [Format]
Displays the format of a recorded video ([JPEG] or [H.264]).
- (3) [Recording Type]
Displays the types of recorded video.
 - [Upload]: Video failed to upload from the camera
 - [Manual]: Manually recorded video
 - [Timer]: Video recorded using the timer
 - [Event]: Video recording triggered by an event
 - [Recording-Mode Stream]: Video that has failed video distribution when using RM recording-mode stream
 - [ONVIF]: Video recorded with ONVIF
- (4) [Video in Camera]
Displays whether or not any video remains on a memory card.
When video has been deleted from a memory card after downloading it, this indicator displays [No].

(5) [Download Status]

Displays download status of video ([Downloaded], [Not Downloaded], [Partially Downloaded]).

Refresh Video List

Click [Refresh Video List] to update the video list to the current state.

Click [Refresh Download Status] to update download status of the video list to the current state.

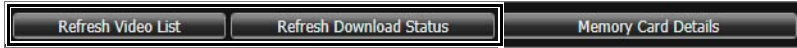

Display Memory Card Information

Click [Memory Card Details] to display information on the memory card inserted in the camera.

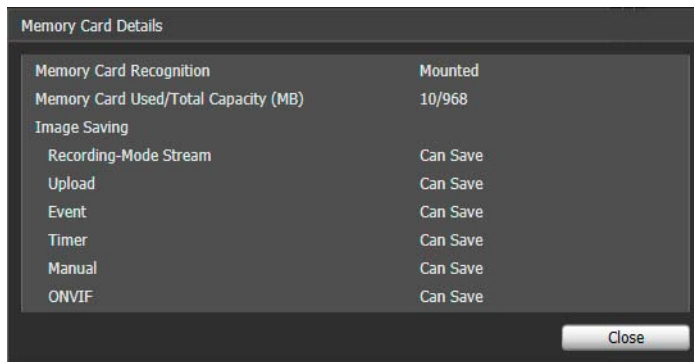
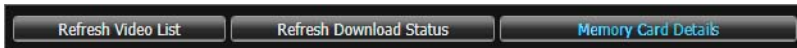

Narrow Down the Number of Videos

Use [Filter] to narrow down the number of videos that appear in the video list to the ones you need.

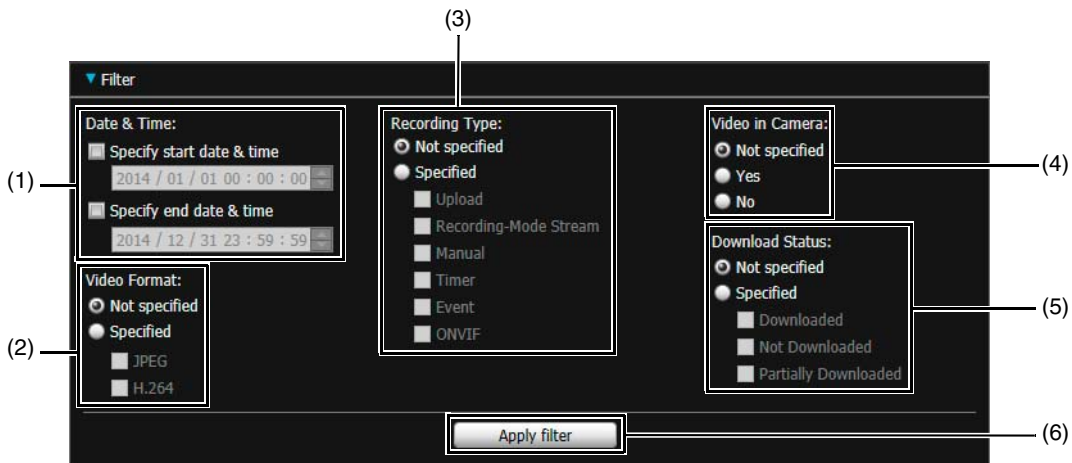

(1) [Date & Time]

[Specify start date & time]

When this checkbox is selected and a date and time are entered, videos recorded on or after the specified date and time are shown.

[Specify end date & time]

When this checkbox is selected and a date and time are entered, videos recorded on or before the specified date and time are shown.

(2) [Video Format]

Select [Specified], then select the video formats you would like to display (multiple selections possible).

- (3) **[Recording Type]**
Select [Specified], then select the video recording types you would like to display (multiple selections possible).
- (4) **[Video in Camera]**
Filters by whether or not video is saved to a memory card.
- (5) **[Download Status]**
Select [Specified], then select the download status you would like to display (multiple selections possible).
- (6) **[Apply filter]**
When this is clicked, only the videos matching the specified conditions are displayed.

Download/Delete Video

Download video recorded on a memory card inserted in the camera to a computer. You can also delete video on a memory card or that has been downloaded to a computer.

Download Video

- 1** Enter in [Download to] the path to the folder for downloading video.

Click [Browse] and specify the folder in the dialog box that appears.

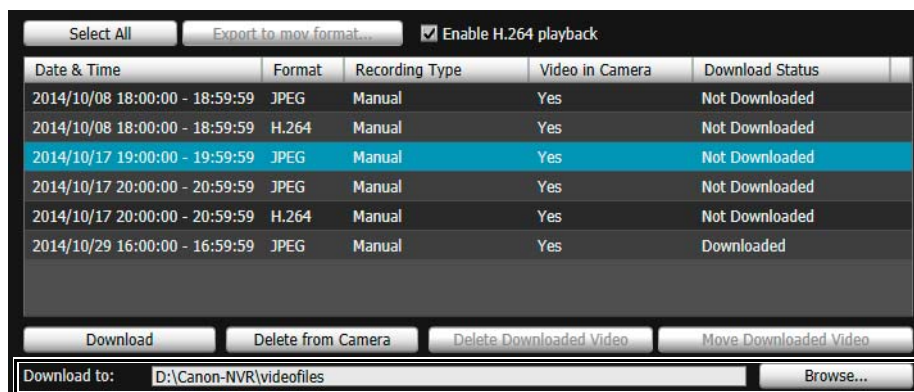

- 2** Click to select a video in the video list for download.

To select multiple videos, click the videos while holding down the Ctrl or Shift key. Click [Select All] to select all videos.

- 3** Click [Download].

The video is downloaded to the specified folder.



Important

Since the Recorded Video Utility processes both files downloaded to a computer and its original videos recorded to the memory card, the video list will not display correctly if you manually delete files downloaded to a computer. If you manually delete files, click [Refresh Download Status] to refresh status of data downloaded to a computer.



Note

If you change the download folder, the download status of the files in the download folder prior to the change becomes [Not Downloaded]. Manually copy the files in the download folder prior to the change to the new download folder to change their status to [Downloaded].

Downloaded videos are stored in a folder that is automatically created within the specified destination folder and named using the camera IP address (for example, [192.168.100.1]). Exit the Recorded Video Utility before using Explorer to browse the folders before and after the change and copy the contents of the folder with the same name as the camera IP address.

After copying, launch the Recorded Video Utility, click [Refresh Download Status] and the manually copied files will appear in the video list.

For details on the folder configuration and file naming rules for the download location, please refer to "Data Downloaded with

Delete Video

Delete video on a memory card or that has been downloaded to a computer.

Delete Video on a Memory Card

- 1 Select a video to delete in the video list.
- 2 Click [Delete from Camera].

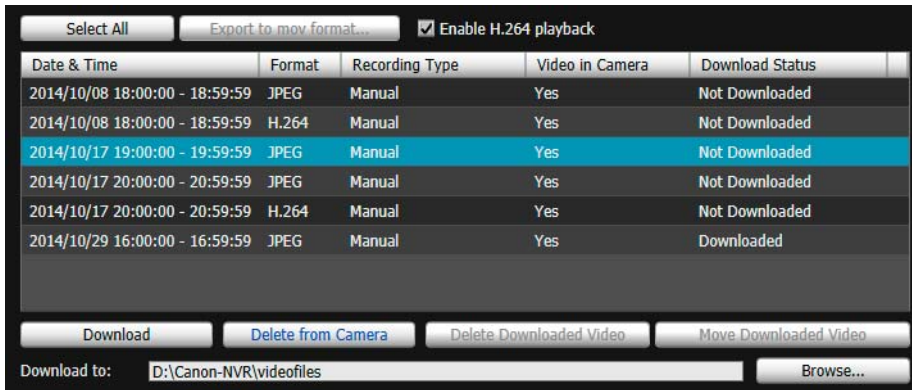

The video on the memory card will be deleted.

Note

- If the selected videos contain [Not Downloaded] videos, a message prompting you to confirm deletion appears.
- The more files that you select to delete, the long it takes to delete the video. For example, if you delete an hour's worth of video (it may only show as being one item in the video list), it can take several minutes.

Delete Downloaded Video from a Computer

- 1 Select a [Downloaded] video in the video list to delete from the computer.
- 2 Click [Delete Downloaded Video].

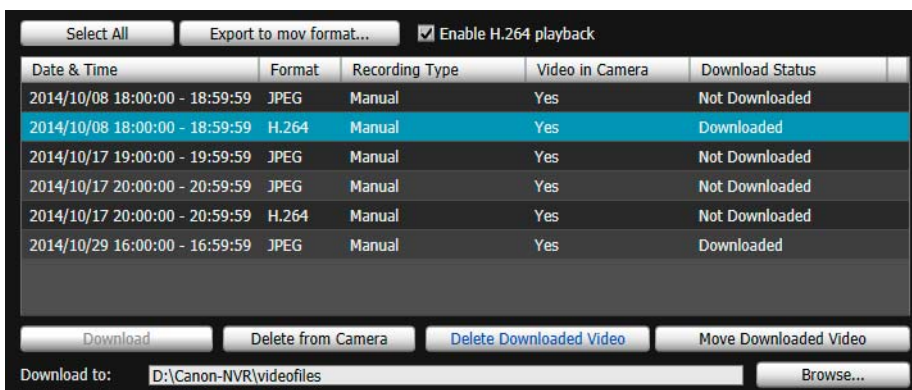

The video is deleted from the computer.

Move Downloaded Video to a Different Computer Folder

- 1 Select a [Downloaded] video in the video list to move.

2 Click [Move Downloaded Video].

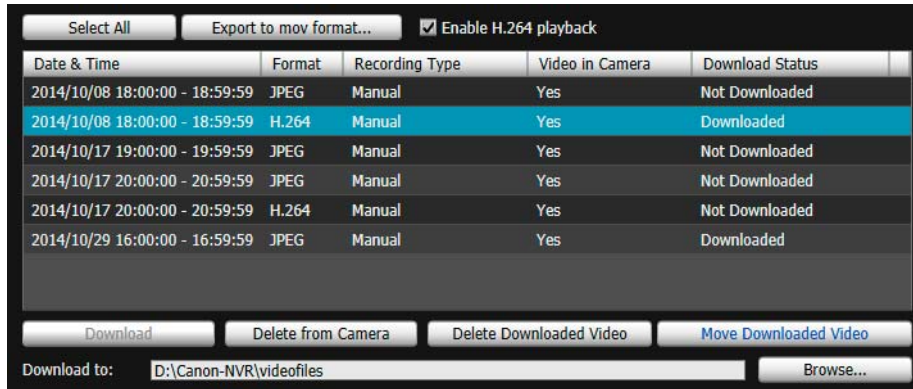

The [Browse For Folder] dialog box appears.

3 Select a folder to move to and click [OK].

The video is moved to the specified folder.

Export Movie Files for Playback

Video downloaded to a computer can be exported in the “.mov” format that can be played back on a computer. For H.264 video, subdivided files are merged into a single file.

1 Select a video to export in the video list.

Videos whose [Download Status] is labeled [Downloaded] in the video list can be exported.

2 Click [Export to mov format].

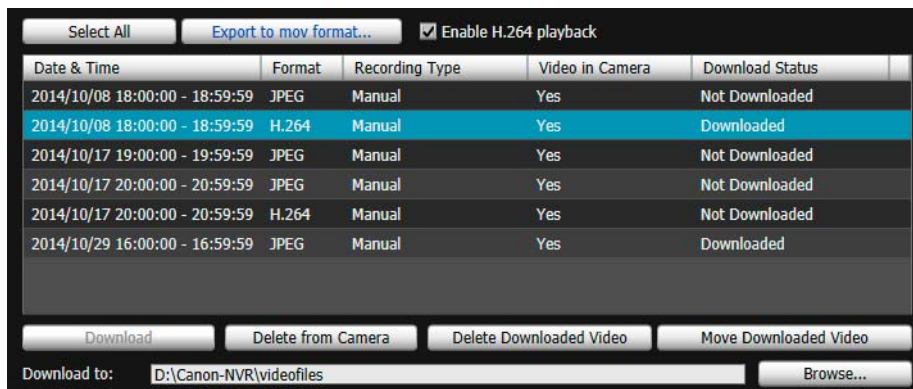

The [Browse For Folder] dialog box appears.

3 Select a folder to export to and click [OK].

The video is exported.

Note

- The exported video files can be played back using QuickTime 7.7 and Windows Media Player 11/12. For the Windows Vista operating system or earlier, use QuickTime. However, playback when using this software is not guaranteed.
- Recorded JPEG video whose video size was changed during recording and exported to a “.mov” file cannot be played back by Windows Media Player. Use QuickTime to play it back.

Play Back Video

Video selected in the video list can be played back in the [Playback Videos] area. The way to play back video differs depending on the video format.

Note

For [Downloaded] video, the video is played back on the computer. For video that has not completed download, video on the memory card is played back.

Play Back JPEG Video

1 Select JPEG video in the video list for playback.

The first frame and information for the selected video will appear in [Playback Videos].

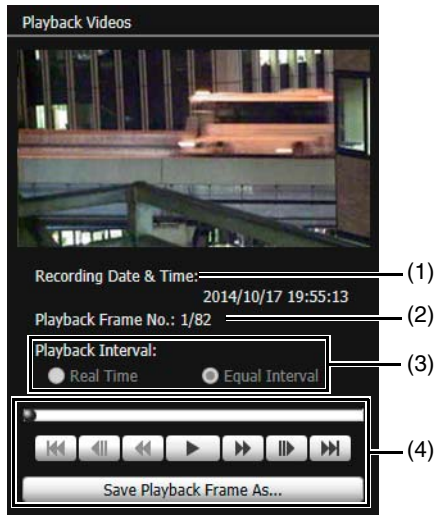

(1) [Recording Date & Time]

Displays the date and time of video frames that are being displayed.

(2) [Playback Frame No.]

Displays frame numbers and total number of video frames that are being displayed.

(3) [Playback Interval]

[Real Time]

JPEG video is played back in real time interval according to the recording time. The preceding JPEG video appears in an empty frame. [Real Time] can be selected only for playback of downloaded videos.

[Equal Interval]

JPEG video is played back at a 1-second interval.

(4) Playback Controls

Controls used for playback.

2 Use the playback controls for playback.



Note









[Not Downloaded] or [Partially Downloaded] videos may not be played back in the order they were recorded.

(1) Slider

Drag the slider to change playback position.

(2) Control Buttons

The function of each button is as follows:

	Move to first frame
	Move to previous frame
	Fast reverse
	Playback
	Pause
	Fast forward
	Move to next frame
	Move to last frame

(3) [Save Playback Frame As]

Video frames that are being played back can be saved as a separate file.

■ Play Back H.264 Video

Note

When you are using Internet Explorer 11 in a 64-bit operating system and the camera is registered as a trusted site and protected mode is enabled, playback of H.264 video will be disabled.

1 Select [Enable H.264 playback].

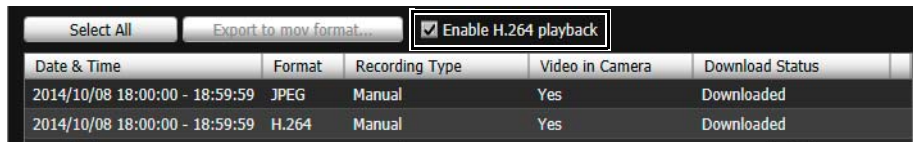

The Software Product License Agreement dialog box appears.

2 Click [Yes].

The H.264 decoder is downloaded from the camera.

3 Select H.264 video in the video list for playback.

The first frame and information for the selected video will appear in [Playback Videos].

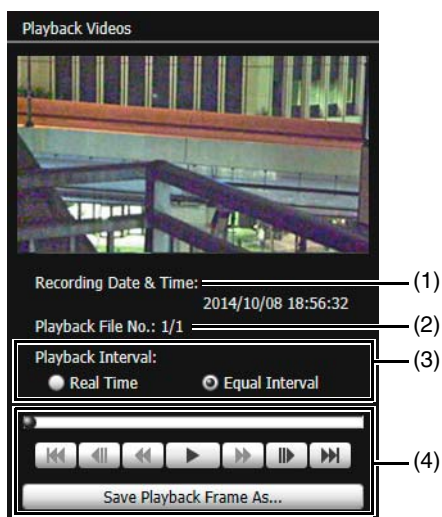

- (1) **[Recording Date & Time]**
Displays the date and time of video frames that are being displayed.
- (2) **[Playback File No.]**
Displays file numbers and total number of video files that are being displayed.
- (3) **[Playback Interval]**
 - [Real Time]**
JPEG video is played back in real time interval according to the recording time. The preceding JPEG video appears in an empty frame. [Real Time] can be selected only for playback of downloaded videos.
 - [Equal Interval]**
Even for video where frames were recorded intermittently, playback is shortened by only playing back the interval just before the empty frames.
- (4) **Playback Control**
Controls used for playback.

4 Use the playback controls for playback.

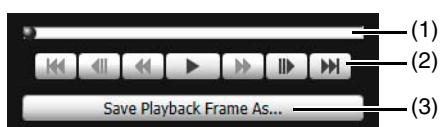

Note

- For [Not Downloaded] or [Partially Downloaded] video, if a file is played back while still downloading, playback may momentarily pause when switching files, depending on the network environment.
- [Not Downloaded] or [Partially Downloaded] videos may not be played back in the order they were recorded.

- (1) **Slider**
Drag the slider to change playback position.
- (2) **Control Buttons**
The function of each button is as follows:

	Move to first frame
	Move to previous frame
	Playback
	Pause
	Move to next frame
	Move to last frame

- (3) **[Save Playback Frame As]**
Video frames that are being played back can be saved as a separate file.

Playback H.264 Video with External Player

- 1 Clear the [Enable H.264 playback] check box.
- 2 Select H.264 video in the video list for playback.
The external player playback screen appears.

3 Use the external player for playback.

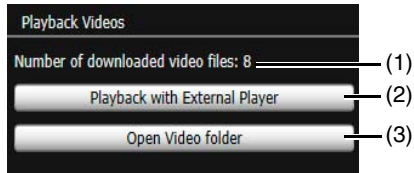

(1) [Number of downloaded video files]

The number of downloaded files the video consists of is displayed.

(2) [Playback with External Player]

Launch an external player (Windows Media Player, etc.) and the selected video is played back.

(3) [Open Video folder]

Open the folder storing the selected video. Double click the video file in the folder to play it back.



Note

- The downloaded H.264 video file will have the ".mov" extension.
- When the data size for ".mov" files is 1 MB or greater, they are split into several files.
- If ".mov" files are split into several files, only the initial few seconds of the first file can be played back.
- The downloaded video files can be played back using QuickTime 7.7 and Windows Media Player 11/12. For the Windows Vista operating system or earlier, use QuickTime. However, playback when using this software is not guaranteed.



Chapter

7

Appendix

This chapter provides supplementary information on camera functions and explains the measure to take when trouble occurs or a message appears during camera use. It also explains how to reset the camera to the factory default setting state.

Memory Card Data

This section explains the data saved to the memory card and the video data downloaded from the memory card to the computer.

Saved Data and Data Organization of Memory Card

When [Operation Settings] is set to [Save Logs and Videos] in [Memory Card] > [Memory Card Operations] (P. 130), the following data is saved automatically to the memory card inserted in the camera.

- Image files of recording-mode stream that could not be distributed due to a network error (JPEG only)
- Video files when HTTP or FTP upload failed (JPEG/H.264(1))
- Video files manually recorded by the user from the Admin Viewer (JPEG/H.264(1))
- Video files recorded by [External Device Input], [Volume Detection] and the intelligent functions when an event occurs (JPEG/H.264(1))
- Video files recorded using a timer (JPEG/H.264(1))
- Log

Note

Saving to the memory card becomes no longer possible when there is no space remaining on the memory card. When [Memory Card] > [Memory Card Operations] > [Overwrite videos] (P. 132) is set to [Enable], old video can be deleted to save new video. When it is set to [Disable], use Recorded Video Utility to delete unnecessary video.

Data Downloaded with Recorded Video Utility

When the video data of the memory card is downloaded to a computer or other device using Recorded Video Utility, it is saved under a folder structure and file name like the following.

Folder Structure

Example: H.264 video, manually recorded using a camera with an IP address of 192.168.100.1, on Sept. 10, 2014, from 16:00:00 to 16:59:59 (Camera Time Zone: GMT+09:00).

D:\work \ 192.168.100.1 \ 20140910 \ 070000_075959 _ +9 _ M _ H264
(1) (2) (3) (4) (5) (6) (7)

- (1) Folder specified with [Download to]
- (2) IP address of the camera
- (3) Video recording date
- (4) Recording start and end times (UTC)
- (5) Time difference from UTC
- (6) Recording type
 - E: Event
 - M: Manual recording
 - R: Recording-mode stream
 - T: Timer
 - U: Upload
 - O: ONVIF
- (7) Video format (JPEG or H.264)

Note

- A folder is created once per hour.
- If the time difference is added to the starting and ending times, it will equal the local time.

Modifiers

According to the setting item, you can specify parameters using modifier “% characters”.

Modifiers	Meaning	Description of character string entered
%n	Reason for capture (number)	0 (test) 1 (External device input 1) 2 (External device input 2) 33 (Timer 1) 34 (Timer 2) 35 (Timer 3) 36 (Timer 4) 145 (Volume detection) 146 (Screen Detection) 160 (Auto Tracking) 161 (Intelligent Function Detection Setting 1) 162 (Intelligent Function Detection Setting 2) 163 (Intelligent Function Detection Setting 3) 164 (Intelligent Function Detection Setting 4) 165 (Intelligent Function Detection Setting 5) 166 (Intelligent Function Detection Setting 6) 167 (Intelligent Function Detection Setting 7) 168 (Intelligent Function Detection Setting 8) 169 (Intelligent Function Detection Setting 9) 170 (Intelligent Function Detection Setting 10) 171 (Intelligent Function Detection Setting 11) 172 (Intelligent Function Detection Setting 12) 173 (Intelligent Function Detection Setting 13) 174 (Intelligent Function Detection Setting 14) 175 (Intelligent Function Detection Setting 15) 201 (Linked Event 1) 202 (Linked Event 2) 203 (Linked Event 3) 204 (Linked Event 4)
%N	Reason for capture (character string)	<External input device name (alphanumeric characters) > Intelligent Function Detection Setting name NULL (blank entry or interval timer test)
%O	Reason for capture (ON/OFF)	OFF ON
%X	Width of image	Number of pixels in horizontal direction
%Y	Height of image	Number of pixels in vertical direction
%C	Camera number	1
%D	Camera Name	Setting for [Camera Name (alphanumeric characters)]
%P	Pan position	R11 R10 -179.99 – 180.00 M641 M640 M741 M740 0
%T	Tilt position	R11 R10 -179.99 – 180.00 M641 M640 M741 M740 0
%Z	Zoom position	0.01 – 300.00
%R	Rotation position	0
%V	Camera server	VB-R11VE/VB-R11/VB-R10VE/VB-M641VE/VB-M641V/VB-M640VE/VB-M640V/VB-M741LE/VB-M740E
%y	Year of capture time	2001 – 2031
%m	Month of capture time	01 – 12
%d	Day of capture time	01 – 31
%w	Day of week of capture time	0 – 6 (Sunday to Saturday)
%H	Hours of capture time	00 – 23
%M	Minutes of capture time	00 – 59
%S	Seconds of capture time	00 – 59
%s	Milliseconds of capture time	000 – 999
%Z	Time zone of capture time	-1200 – +1300
%a	Weekday name of capture time	Sun Mon Tue Wed Thu Fri Sat
%b	Month name of capture time	Jan Feb Mar Apr May Jun Jul Aug Sep Oct Nov Dec
%h	Host Name	

Note

- A runtime error will occur if the specified name does not match.
- If this modifier is not defined, “%” will be deleted.

■ Available Modifiers

The modifiers that can be used for each setting item are specified below.

[HTTP Upload] (P. 97)

[Parameter (query string)]

All modifiers can be used.

[FTP Upload] (P. 99)

[Subdirectory Name to Create]

Only the modifiers %y, %m, %d, %w, %H, %h, %n can be used.

[File Name to Create]

Only the modifiers %y, %m, %d, %w, %H, %M, %S, %s, %n can be used.

[E-mail Notification] (P. 102)

[Message Body]

All modifiers can be used.

Troubleshooting

Before contacting the dealer where you purchased the product or Canon Customer Service Center, check the items specified as follows. If a log message is displayed, check the details of the message and corresponding countermeasure in the log message list.

Problem	Countermeasures
The camera does not launch.	<ul style="list-style-type: none"> • If you are using a PoE hub, check if the LAN cable is connected correctly. • If you are using an AC adapter (sold separately), check if the AC adapter is connected correctly. • Turn the camera off and on again (please refer to "Installation Guide" > "Connecting the Camera").
Camera Management Tool does not operate.	<ul style="list-style-type: none"> • Check if the LAN cable is connected correctly. • Turn the camera off and on again (please refer to "Installation Guide" > "Connecting the Camera"). • Check if the camera and the computers in which the Camera Management Tool is operating are connected to the LAN in the same segment. • The Camera Management Tool may not function when the [Windows Firewall] function is enabled. If that happens, refer to "Check/Make Security Settings" (P. 31).
The top page of the camera is not displayed.	<ul style="list-style-type: none"> • Check if the LAN cable is connected correctly. • Check if the network to which the camera is connected is set up correctly. In particular, check if the IP address, subnet mask and default gateway address are set within the ranges supported by the applicable network. • If you have changed the IP address, the new address will not become effective until the camera is rebooted. • Check if the correct URI (camera IP address) is entered in your web browser (P. 37, P. 41). • Check whether the connection is from a computer whose access is blocked in [Security] > [Host Access Restrictions] on the Setting Page. • Check the authentication method, [User Name], [Password], combination of certificates, and network rules for connection in [Security] > [802.1X] on the Setting Page with the system administrator.
The Admin Tools will not launch. The Admin Viewer will not launch.	<ul style="list-style-type: none"> • If the message "Your web browser is not supported." is displayed, use Internet Explorer 8 or later. • If the message "Application could not be started. Install .NET Framework x.x (x is the version)." is displayed, install the corresponding version of .NET Framework or enable settings (P. 24). • If the message "JavaScript is not available or disabled on your web browser." is displayed, set [Active Script] to [Enable] in Internet Explorer's security settings. (please refer to (3) below for instructions on how to set this.) • If the message "The settings from (1) to (3) below must be carried out to use the Admin Viewer and Admin Tools." is displayed, set the following. <ol style="list-style-type: none"> (1) Use the installer to install your Admin Tools Certificate (P. 28). (2) When using Internet Explorer 9 or later, follow the steps in "Register the Camera IP Address as a Trusted Site" (P. 32) and add this web site to [Trusted sites] in Internet Explorer's security settings. (3) In Internet Explorer click [Tools] > [Internet Option] > [Security] > [Custom level] and under the Security Settings list, set [XAML browser applications], [File download] and [Launching programs and files in an IFRAME] to [Enable].
Video is not displayed.	<ul style="list-style-type: none"> • If you wish to improve video quality, adjust it by changing the video size, video quality, and frame rate settings in [Basic Settings] > [Video Settings] (P. 72) in the Setting Page. • Up to 30 viewers can access the camera at the same time. If this limit has been exceeded, video is not displayed and a message appears.
There is no audio. R11 M641 M741	<ul style="list-style-type: none"> • If there is no audio, check the audio server settings of the camera and also check the sound and audio device settings for the computers. • If you are using the Admin Viewer with the administrator authorities, check if the camera is connected to the RM Viewer or another viewer that lets the administrator use audio. • In VB Viewer, audio cannot be used if the Canon Network Camera Audio Receiver add-on is not installed.

Problem	Countermeasures
The camera cannot be controlled.	<ul style="list-style-type: none"> • If you connect the Admin Viewer as an administrator, you will have exclusive possession of the camera control privileges. If you connect to the Admin Viewer as an Authorized User, you cannot control the camera unless the administrator releases camera control. Consult the Administrator (P. 138).
The viewer gets disconnected.	<ul style="list-style-type: none"> • Check the network and computer for abnormality. • Reboot the computer and connect again.
You forgot your password.	<ul style="list-style-type: none"> • You can initialize all settings of the camera excluding date and time using the reset switch (P. 270). The administrator password required for initialization is "camera". Note, however, that network settings such as the IP address and subnet mask will be initialized and must be set again.
Data cannot be uploaded.	<ul style="list-style-type: none"> • Check that the upload destination of [Video Record] > [Upload] and the upload operation upon an event of the [Event] menu are both set correctly. • You can perform an operation check based on the currently set upload destination by running a test from the [Upload] menu (P. 99). • Check [Maintenance] > [Tool] > [View Logs] or logs on the server to check the detailed operating environment. For details on [View Logs], please refer to "Uploader error" (P. 259), "Uploader warning" (P. 262), or "Uploader notification" (P. 265) of "List of Log Messages". Also please refer to "Important" on P. 96. • For the server settings, contact your System Administrator.
Video cannot be recorded on an memory card.	<ul style="list-style-type: none"> • To record video to an memory card when an event occurs, check the [Video Record Action] settings under [Video Record] > [Memory Card] > [Video Record Setting] in the Setting Page. When [Video Record Action] is set to [Upload], change it to [Record to Memory Card]. • When recording-mode stream video that could not be transmitted due to network errors or video for which the HTTP/FTP upload failed is not stored on the memory card, check [Operation Settings] under [Video Record] > [Memory Card] > [Memory Card Operations] in the Setting Page. When [Operation Settings] is set to [Save Log], change it to [Save Logs and Videos]. • To manually save recordings to an memory card, obtain camera control privileges.
Files cannot be saved in the Setting Page or Admin Tools.	<ul style="list-style-type: none"> • Windows prohibits saving to certain folders. Accordingly, an attempt to save a file may fail. Specify [Documents], [Pictures] and other folders.
A message indicating "Cannot access the memory card. Please recreate the video management information on the Setting Page" appears when Recorded Video Utility is launched.	<ul style="list-style-type: none"> • Select [Memory Card Information] under [Video Record] > [Memory Card] in the Setting Page to check [Video Management Information Status]. When [Video Management Information Recreation Required] is displayed, click [Exec] in [Recreate Video Management Information] under [Memory Card Operations]. When video management information has been recreated, make sure that [Video Management Information Status] is [Normal].

List of Log Messages

Log Messages on the Camera

This is a list of log messages that appear in the Log Viewer (P. 236).
Log messages are classified into the following types.

Category	Level	Code	Fault level
crit	Error	4xx	Software-level failure (Task operations will stop)
err	Error	3xx	Operational error (Operations will continue)
warning	Warning	2xx	Non-operational error
notice	Warning	1xx	Error external to the system
info	Information	0xx	Information on normal operation

Note

If no content is recorded in a log for approximately two hours, "-- MARK --" will be recorded in the message area.

Error Log

■ System Error

S302 Error on saving settings [err]

Description	Can't update system settings (S302)
Meaning	An error generated while the system was saving a setting. Setting could not be saved.
Countermeasure	Provide enough memory space by deleting unnecessary files in the user memory area, etc.

S303 Error on saving settings [err]

Description	Can't update files of system settings (S303)
Meaning	An error generated while the system was saving a setting. Setting could not be saved.
Countermeasure	Provide enough memory space by deleting unnecessary files in the user memory area, etc.

S307 Error on saving settings [err]

Description	(vbadm.c XXX) Can't update system settings (S307)
Meaning	An error generated while the settings were saved by the setup protocol. Setting could not be saved.
Countermeasure	Provide enough memory space by deleting unnecessary files in the user memory area, etc.

S310 Working error in event service [err]

Description	cannot work event [%1][%2][%3] (S310)
%1	Error number
%2	Cause of error
%3	Error information
Meaning	An error occurred while the event service was running.
Countermeasure	If the problem persists after rebooting, the camera is faulty. Arrange for servicing.

S311 Working error in external input/output service [err]

Description	cannot work extio [%1][%2][%3] (S311)
%1	Error number
%2	Cause of error
%3	Error information
Meaning	An error occurred while the external input/output device service was running.
Countermeasure	If the problem persists after rebooting, the camera is faulty. Arrange for servicing.

S312 Working error in timer service [err]

Description	cannot work timer [%1][%2][%3] (S312)
%1	Error number
%2	Cause of error
%3	Error information
Meaning	An internal error occurred in the timer service.
Countermeasure	If the problem persists after rebooting, the camera is faulty. Arrange for servicing.

S320 PAN/TILT operation error [err]

Description	%1 error occurred. [%2] (S320)
%1	PAN TILT
%2	Warning details
Meaning	An error occurred during operation or stopping of PAN/TILT.
Countermeasure	Check that the camera is not touching the dome, etc. If the error is not caused by problems such as contact with peripheral items, the camera is faulty. Arrange for servicing.

S330 Failure of fan [err]

Description	FAN [%1] failure (S330)
%1	Fan number
Meaning	Detected that the fan is not rotating or the rotation speed has significantly decreased.
Countermeasure	If the problem persists after rebooting, the fan may have failed. Arrange for servicing.

S331 Failure of heater [err]

Description	HEATER [%1] failure (S331)
%1	Heater number
Meaning	An abnormality was detected when using the heater.
Countermeasure	There may be a connection problem with the heater unit you attached, so check the connections (VB-M641VE). If the problem persists after rebooting, the heater may have failed. Arrange for servicing.

S410 Event service initialization error [crit]

Description	event initialization error [%1][%2] (S410)
%1	Error number
%2	Cause of error
Meaning	An error occurred in the initialization of the event service.
Countermeasure	If the problem persists after rebooting, the camera is faulty. Arrange for servicing.

S411 External input/output service initialization error [crit]

Description	extio initialization error [%1][%2] (S411)
%1	Error number
%2	Cause of error
Meaning	An error occurred in the initialization of the external input/output device service.
Countermeasure	If the problem persists after rebooting, the camera is faulty. Arrange for servicing.

S412 Timer service initialization error [crit]

Description	timer initialization error [%1][%2] (S412)
%1	Error number
%2	Cause of error
Meaning	An error occurred in the initialization of the timer service.
Countermeasure	If the problem persists after rebooting, the camera is faulty. Arrange for servicing.

S413 Timer service runtime error [crit]

Description	timer working error [%1] (S413)
%1	Error number
Meaning	An error occurred while the timer service was running.
Countermeasure	If the problem persists after rebooting, the camera is faulty. Arrange for servicing.

S420 External IO controller has failed [err]

Description	external io controller is broken.(S420)
Meaning	The external IO controller has failed.
Countermeasure	The external IO controller firmware must be updated. If the problem persists after updating the firmware, the camera is faulty. Arrange for servicing.

S430 Failure of temperature sensor [crit]

Description	Cannot get temperature (S430)
Meaning	The temperature cannot be acquired from the temperature sensor.
Countermeasure	If the problem persists after rebooting, the circuit board may have failed. Arrange for servicing.

■ Audio server error

B301 Audio device error [err]

Description	cannot use audio device for %1[%2:%3] (B301)
%1	Send/Receive type (rx tx)
%2	Error type (open write flush)
%3	Error number
Meaning	Detected an error in the audio device
Countermeasure	If the problem persists, please arrange for servicing.

B402 Audio server initialization failed [err]

Description	wvaudio initialization error [%1] (B402)
%1	Error number
Meaning	The audio server could not be initialized. The audio server stops.
Countermeasure	If the problem persists after rebooting, the camera is faulty. Arrange for servicing.

B403 Settings change failed [err]

Description	cannot set config [%1:%2] (B403)
%1	Error notification number
%2	Error number
Meaning	The settings could not be updated. The audio server stops.
Countermeasure	If the problem persists after rebooting, the camera is faulty. Arrange for servicing.

■ Video error

V300 Video input error [err]

Description	video %1 warning - %2 (V300)
%1	Video number
Meaning	An error in the video input was detected that may adversely affect the operation of the camera.
Countermeasure	If the problem persists after rebooting, the camera is faulty. Arrange for servicing.

V320 Internal error in intelligent service [err]

Description	cannot work intelligent [%1][%2][%3]. (V320)
%1	Error number
%2	Cause of error
%3	Error information
Meaning	An internal error occurred in intelligent service.
Countermeasure	If the problem persists after rebooting, the camera is faulty. Arrange for servicing.

V321 Pseudo mode setting error in intelligent service [err]

Description	pseudo mode setting fail. (V321)
Meaning	An error occurred in the pseudo mode setting of intelligent service.
Countermeasure	If the problem persists after rebooting, the camera is faulty. Arrange for servicing.

V400 Video input initialization error [crit]

Description	video %1 initialization failure - %2(%3) (V400)
%1	Video number
%2	Process description
%3	Error details
Meaning	The video input function was stopped because the video input system could not be initialized.
Countermeasure	If the problem persists after rebooting, the camera is faulty. Arrange for servicing.

V401 Video input command error [crit]

Description	video %1 command error - %2(%3) (V401)
%1	Video number
%2	Process description
%3	Error details
Meaning	The video input function was stopped because a video input command could not be processed.
Countermeasure	If the problem persists after rebooting, the camera is faulty. Arrange for servicing.

V402 Video input frozen [crit]

Description	video %1 stalled (V402)
%1	Video number
Meaning	The video input function was stopped because video generation stopped.
Countermeasure	If the problem persists after rebooting, the camera is faulty. Arrange for servicing.

V403 Video input error [crit]

Description	video %1 fatal error - %2 (V403)
%1	Video number
%2	Error number
Meaning	The video input function was stopped because an error that does not permit recovery of the video input system was detected.
Countermeasure	If the problem persists after rebooting, the camera is faulty. Arrange for servicing.

V420 Could not start intelligent service [crit]

Description	intelligent initialization error [%1][%2]. (V420)
%1	Error number
%2	Cause of error
Meaning	Failed to initialize intelligent service.
Countermeasure	If the problem persists after rebooting, the camera is faulty. Arrange for servicing.

V421 Intelligent service error [crit]

Description	intelligent working error [%1][%2]. (V421)
%1	Error number
%2	Cause of error
Meaning	An error that does not permit recovery occurred while intelligent service was running.
Countermeasure	If the problem persists after rebooting, the camera is faulty. Arrange for servicing.

■ Uploader error**A470 Uploader initialization failed [crit]**

Description	uploader initialization failure - %1 (A470)
%1	Error number
Meaning	The uploader could not be initialized.
Countermeasure	If the problem persists after rebooting, the camera is faulty. Arrange for servicing.

■ Memory card error**M301 Memory card control module error [err]**

Description	%1 process failure (M301)
%1	mount or unmount
Meaning	Mount or unmount process failed.

M302 Cannot remove invalid file [err]

Description	Invalid file (%1) can not remove. (M302)
%1	Name of removed file
Meaning	The invalid file could not be removed.

M303 Cannot process directory [err]

Description	Can not open directory(%1)(M303)
%1	Directory name
Meaning	Could not open directory to be processed.

M304 Failed to recreate management information [err]

Description	Fail updating management file(%1)(M304)
%1	Management information identification number
Meaning	Process to recreate management information failed.

■ ONVIF error (RTP)

R301 Distribution communication error [err]

Description	message queue open error. %1 (R301)
%1	Modules that generate errors RTP_CTRL_QUEUE RTP_DATA_QUEUE VIDEO_CTRL_QUEUE VIDEO_DATA_QUEUE AUDIO_CTRL_QUEUE AUDIO_DATA_QUEUE EVENT_CTRL_QUEUE RECVQ_META SENDQ_MEDIA
Meaning	A communication error occurred between modules.
Countermeasure	If the problem persists after repeated attempts and rebooting, the camera may be faulty. Arrange for servicing.

R302 Parameter acquisition failure [err]

Description	cannot get parameter: %1 (R302)
%1	user_account: User account IP_address: IP address of the camera profile_media_configuration:MediaCon figuration information RTSP_port_number: RTSP port number
Meaning	Parameter acquisition has failed.

R303 Metadata distribution initialization failure [err]

Description	metadata initialization error (R303)
Meaning	Metadata distribution initialization has failed.

R304 Abnormal termination of client [err]

Description	delete session from some kind of error: client_IP=%1, session_ID=%2 (R304)
%1	Client IP address
%2	Session ID
Meaning	The client session terminated abnormally.

R304 Client disconnected [err]

Description	connection reset by peer: client_IP=%1 (R304)
%1	Client IP address
Meaning	Disconnected from client.

R304 Client disconnected [err]

Description	RTP/HTTP connection closed by client (R304)
Meaning	Disconnected from client.

R305 RTSP processing error [err]

Description	RTSP Error: error_code=500: Internal Server Error (R305)
Meaning	An RTSP processing error occurred.

■ System warning

S220 PAN/TILT operation warning [warning]

Description	%1 warning detected. [%2] (S220)
%1	PAN TILT
%2	Warning details
Meaning	An error occurred during operation or stopping of PAN/TILT.
Countermeasure	Check that the camera is not touching the dome, etc.

S230 Decrease of fan rotation speed [warning]

Description	FAN %1 speed is too slow. (S230)
%1	Fan number
Meaning	Detected decrease in fan rotation speed. If this happens frequently, arrange for servicing.

S231 Heater unit not operating [warning]

Description	A 24 V AC power source is not supplied to the heater unit. (S231)
Meaning	A heater unit is attached but not supplied with a 24 V AC power source.
Countermeasure	The 24 V AC power source required to operate the heater unit is not being supplied. Check the connections.

■ HTTP server warning

H201 Timeout disconnect [warning]

Description	a request for %1 timed out after writing %d seconds (H201)
%1	Request URI
%d	360 (Timeout time)
Meaning	Disconnected due to HTTP server timeout (360 sec.).

■ wvhttp warning

W101 Invalid user name [notice]

Description	user <User name> not found (W101)
Meaning	The camera was accessed by an unauthorized user.

W102 Invalid password [notice]

Description	user <User name> password mismatch (W102)
Meaning	The password is invalid.

W130 Buffer recovered [notice]

Description	stream buffer recovered (W130)
Meaning	Image buffer for stream recording has recovered.

W201 Invalid panorama image [warning]

Description	corrupt panorama image - ignored (W201)
Meaning	Panorama image information acquisition failed.

W230 Buffer overflow [warning]

Description	stream buffer overflowed (W230)
Meaning	The image buffer for the stream recording overflowed and images were discarded.

■ Audio server warning

B101 Received unusual request [notice]

Description	%1 unusual request[%2] (B101)
%1	Client host's IP address
%2	Unusual type (400 404)
Meaning	Refused due to command error (400) and parameter error (404).

B102 Client connection denied [notice]

Description	%1 request denied[%2] (B102)
%1	Client host IP address
%2	Denial type (41 43 ...)
Meaning	Client connection was denied due to an authentication error (41), time specification error (42), insufficient resource (43), specification of unsupported codec (45), specification of unpermitted user level (47), too many clients (49) or invalid operation mode (4a).
Countermeasure	41: Check user name, password or user list used when connecting. 42: Check playtime or maximum connection time settings used when connecting. 43: Reconnect or restart. 45: Use supported client software. 47: Check user level used when connecting. 49: Check client number settings. 4a: Check if usage of audio server is enabled.

B103 Client forcibly disconnected [notice]

Description	%1 access denied[%2] (B103)
%1	Client host IP address
%2	Denial type (41 42 4a)
Meaning	Connection was initially permitted, but the setting has subsequently been changed to prohibit access, thereby triggering a forced disconnection (the denial type is the same with B102).

B201 Event notification failure [warning]

Description	cannot notify %1 event [%2] (B201)
%1	Event type (ald)
%2	Error number
Meaning	Failed to notify event.

B202 Event receive failure [warning]

Description	cannot recv event [%1] (B202)
%1	Error number
Meaning	Failed to receive event.

B203 Audio message send failure [warning]

Description	audio message send error %1 [%2] (B203)
%1	Message type
%2	Error number
Meaning	Failed to send audio message.

B204 Audio message receive error [warning]

Description	audio message rcv error [%1:%2] (B204)
%1	Error number
%2	Reason for error
Meaning	Failed to receive audio message.

■ Camera application warning

C201 Day/Night Mode switching warning [warning]

Description	Can't switch Day/Night mode, because current mode is Auto.(C201)
Meaning	Day/Night Mode could not be switched.
Countermeasure	Set Day/Night Mode to manual.

C211 Camera control command overflow [warning]

Description	command queue overflowed (C211)
Meaning	The camera control command queue overflowed, and some commands were discarded.
Countermeasure	Allow a longer interval (200 ms) for sending the camera control command.

■ Video warning

V200 Video input warning [warning]

Description	video %1 warning - %2 (V200)
%1	Video number
%2	Error number
Meaning	An error that permits recovery of the video input system was detected.
Countermeasure	Change video size or video quality, or decrease data size for each JPEG image.

■ Uploader warning

A274 Event buffer for upload overflowed [warning]

Description	event queue is full (A274)
Meaning	Event buffer for upload overflowed.
Countermeasure	Make adjustments to reduce the number of event occurrences.

A275 Image buffer for upload overflowed [warning]

Description	buffer queue is full (A275)
Meaning	Image buffer for upload overflowed.
Countermeasure	Make adjustments to reduce the number of event occurrences. Also adjust the video quality, video size and frame rate for upload.

■ Memory card warning

M201 Memory card is write-protected [warning]

Description	Readonly filesystem (M201)
Meaning	A write-protected memory card is inserted.

M203 Not enough space on memory card [warning]

Description	There is not available space (M203)
Meaning	Insufficient memory card capacity.

M204 Invalid file removed [warning]

Description	Invalid file %1 was removed. (M204)
%1	Name of removed file
Meaning	An invalid file was removed.

M205 Checking management information file [warning]

Description	%1 checking management file (M205)
%1	Start Finish
Meaning	The memory card may have been removed without being unmounted. Start/finish checking management information file.

M206 Invalid management information removed [warning]

Description	Invalid db information(%1)(%2) was removed(M206)
%1	Name of management information file containing invalid information
%2	ID of invalid information
Meaning	Invalid management information was removed.

Notification log

■ System notification

S001 System started [info]

Description	starting paramd (S001)
Meaning	Parameter management module started.

S002 System settings changed [info]

Description	Updated system settings. (S002)
Meaning	Settings not requiring rebooting were changed.

S010 Event service started [info]

Description	starting event (S010)
Meaning	The event service was started.

S011 Event service shut down [info]

Description	shutdown event (S011)
Meaning	The event service was shut down.

S012 External device service started [info]

Description	starting extio (S012)
Meaning	The external device input/output service was started.

S013 External device service shut down [info]

Description	shutdown extio (S013)
Meaning	The external device input/output service was shut down.

S014 Timer service started [info]

Description	starting timer (S014)
Meaning	The timer service was started.

S015 Timer service shut down [info]

Description	shutdown timer (S015)
Meaning	The timer service was shut down.

S030 Heater unit detected [info]

Description	The heater unit is detected. (S030)
Meaning	A heater unit is attached.

S070 Change to SSL certificate [info]

Description	ssl: succeeded to %1 certificate (S070)
%1	generate load delete restore
Meaning	A certificate was generated/loaded/deleted/restored
Countermeasure	None

■ HTTP server notification

H143 User name specification error [notice]

Description	(http_auth.c.XXX) get_password failed, IP:%1 (H143)
%1	IP address
Meaning	An unknown user was specified in user authentication.

H144 Password specification error [notice]

Description	(http_auth.c.XXX) password doesn't match for %1 username%2, IP:%3 (H144)
%1	URL XSS vulnerability countermeasure implementation (process equivalent to ftpd)
%2	User Name
%3	IP address
Meaning	A wrong password was specified in user authentication.

■ wvhttp notification

W001 Starting and stopping of system [info]

Description	%1 webview (W001)
%1	Starting or stopping
Meaning	wvhttp server (webview) has started or stopped.

W030 Startup and shutdown of WebView Livescope Client [info]

Description	%1%2 host=<Host>, user=<User>, prio=<Priority>(W030)
%1	W: WebView session, V: Session-less video client, N: Session-less event client
%2	+: Connect, -: Disconnect
Meaning	The camera server client was connected or disconnected.

W031 Transmitted video data size [info]

Description	%1= host=<Host>, user=<User>, video=<jpg h264>:<Number of frames> (W031)
1%	W: WebView session, V: Session-less video client
Meaning	When a client disconnected, the total data that was sent to the client displayed in number of frames.

W040 Clearing to external memory [info]

Description	%1 the image storing - %2 (W040)
%1	Starting or stopping
%2	Reason for starting/stopping
Meaning	Started or stopped clearing stream recording to external memory.

■ Audio server notification

B001 Starting and stopping of audio server [info]

Description	%1 audio. (B001)
%1	starting stopping
Meaning	The audio server was started/shut down.

B011 Audio client connected [info]

Description	[%1] %2 connected n=%3 (B011)
%1	Client type (send rcv)
%2	Client host IP address
%3	Total number of clients
Meaning	An audio client was connected.

B012 Audio client closed [info]

Description	[%1] %2 closed n=%3 (B012)
%1	Client type (send rcv)
%2	Client host IP address
%3	Total number of clients
Meaning	An audio client was disconnected.

■ Camera application notification

C001 Starting and stopping of camera control module [info]

Description	%1 camerad (C001)
%1	starting stopping
Meaning	The camera control module started/ stopped.

C002 Camera application started and stopped [info]

Description	starting cameraappl (C002)
Meaning	The camera application started.

■ Video notification

V001 Starting and stopping of video server [info]

Description	%1 video (V001)
%1	Starting or stopping
Meaning	The video server was started/stopped.

V020 Starting intelligent service [info]

Description	starting intelligent. (V020)
Meaning	Intelligent service was started.

V021 Shutting down intelligence service [info]

Description	shutdown intelligent. (V021)
Meaning	Intelligent service was shut down.

■ Uploader notification

A004 Starting and stopping of uploader [info]

Description	%1 uploader (A004)
%1	Starting or stopping
Meaning	The uploader was started or stopped.

A040 Number of uploads (MAIL) [info]

Description	uploader mail: normal=%1 test=%2 (A040)
%1	Number of normal uploads.
%2	Number of test uploads.
Meaning	Shows the number of uploads executed.

A041 Number of uploads (FTP) [info]

Description	uploader ftp: normal=%1 test=%2 (A041)
%1	Number of normal uploads.
%2	Number of test uploads.
Meaning	Shows the number of uploads executed.

A042 Number of uploads (HTTP) [info]

Description	uploader http: normal=%1 test=%2 (A042)
%1	Number of normal uploads.
%2	Number of test uploads.
Meaning	Shows the number of uploads executed.

A120 Resolution of upload destination name failed [notice]

Description	uploader cannot resolve the server name (A120)
Meaning	The name of the upload destination could not be resolved.

A121 Connection to upload destination failed [notice]

Description	uploader cannot connect the server (A121)
Meaning	Execution of connect to upload destination failed.

A122 Connection to upload destination failed [notice]

Description	uploader cannot connect the server (A122)
Meaning	The upload destination could not be connected due to a reason other than A120 and A121.

A134 Invalid upload setting (FTP/HTTP mode) [notice]

Description	ftp/http mode invalid. uploader set <none> forcibly (A134)
Meaning	The upload mode setting is invalid. The upload function was forcibly disabled.

A135 Invalid upload setting (FTP PORT/PASV mode) [notice]

Description	ftp port/pasv mode invalid. uploader set <pasv> forcibly (A135)
Meaning	The PORT/PASV mode setting in connection with FTP upload is invalid. The PASV mode was forcibly set.

A136 Invalid upload setting (HTTP notification only/image mode) [notice]

Description	http notice/image mode invalid. uploader set <image> forcibly (A136)
Meaning	The notification only/image mode setting in connection with HTTP upload is invalid. The image mode was forcibly set.

A137 Invalid upload setting (E-mail notification) [notice]

Description	mode invalid. uploader set <none> forcibly (A137)
Meaning	The e-mail notification setting is invalid. Email notification was forcibly disabled.

A138 Invalid upload setting (E-mail notification authentication mode) [notice]

Description	authentication mode invalid. uploader set <smtp auth> forcibly (A138)
Meaning	The setting for e-mail notification authentication mode is invalid. "SMTP_AUTH" was forcibly set.

Memory card notification

M001 Starting and stopping of memory card control module [info]

Description	%1 sdctrl (M001)
%1	Starting or stopping
Meaning	The memory card control module (sdctrl) has started or stopped.

M002 Valid management information inserted [info]

Description	Valid db information (%1)(%2)(%3) was inserted (M002)
%1	Name of management information file with inserted valid information
%2	Directory number of valid information
%3	File number of valid information
Meaning	Added to management information as it appears to be a valid video file.

M003 Started/finished recreation of management information [info]

Description	%1 updating management file (%2)(M003)
%1	Start Finish
%2	Management information identification number
Meaning	Process to recreate management information finished.

ONVIF notification

RTP

R001 Startup of RTP distribution module [info]

Description	starting media_plane (R001)
Meaning	RTP distribution module started.

R002 Stopping of RTP distribution module [info]

Description	stopping media_plane (R002)
Meaning	RTP distribution module stopped.

R003 RTSP PLAY request received [info]

Description	PLAY received: client_IP=%1, profile=%2, num_of_sessions=%3(V=%4, A=%5, M=%6,BC=%7) (R003)
%1	Client IP address
%2	Profile name of requested PLAY
%3	Total number of client sessions
%4	Total distribution count of Video stream
%5	Total distribution count of Audio stream
%6	Total distribution count of Metadata stream
%7	Total distribution count of AudioBackChannel
Meaning	RTSP PLAY request was received.

R004 RTSP TEARDOWN request received [info]

Description	TEARDOWN received: client_IP=%1, profile=%2, num_of_sessions=%3(V=%4, A=%5, M=%6,BC=%7) (R004)
%1	Client IP address
%2	Profile name of requested TEARDOWN
%3	Total number of client sessions
%4	Total distribution count of Video stream
%5	Total distribution count of Audio stream
%6	Total distribution count of Metadata stream
%7	Total distribution count of AudioBackChannel
Meaning	RTSP TEARDOWN request was received.

R005 Starting multicast [info]

Description	start multicast: profile=%1, num_of_sessions=%2(V=%3, A=%4, M=%5,BC=%6) (R005)
%1	Client IP address
%2	Profile name of requested MulticastStreaming START
%3	Total distribution count of Video stream
%4	Total distribution count of Audio stream
%5	Total distribution count of Metadata stream
%6	Total distribution count of AudioBackChannel
Meaning	Multicast was started.

R006 Stopping multicast [info]

Description	stop multicast: profile=%1, num_of_sessions=%2(V=%3, A=%4, M=%5,BC=%6) (R006)
%1	Client IP address
%2	Profile name of requested MulticastStreaming STOP
%3	Total distribution count of Video stream
%4	Total distribution count of Audio stream
%5	Total distribution count of Metadata stream
%6	Total distribution count of AudioBackChannel
Meaning	Multicast was stopped.

R101 RTP session timeout [notice]

Description	session timeout: session ID=%1 (R101)
%1	Session ID
Meaning	RTP session has timed out.

R102 Information acquisition failure (RTP payload size) [notice]

Description	cannot get parameter: RTP_payload_size (R102)
Meaning	Information acquisition has failed (RTP payload size).

R102 Information acquisition failure (IP address) [notice]

Description	cannot get parameter: IP_address (R102)
Meaning	Information acquisition has failed (IP address).

R103 RTSP authentication failure [notice]

Description	RTSP authorization error (R103)
Meaning	RTSP authentication has failed.



R107 RTSP connection failure [notice]

Description	RTSP Error: error_code=%d: Service Unavailable (R107)
%d	400: Value used for RTSP is invalid. 401: RTSP authentication failure or missing valid authentication information. 457: Playback time for RTSP is invalid. 501: An invalid RTSP option was used. 503: Failure to offer service, due to insufficient resources. The number of maximum RTP sessions, has passed the limit.
Meaning	RTSP connection has failed.

List of Viewer Messages

Messages Displayed in the Information Display

Messages displayed in the information display of the Viewer are classified into the following three types.

Icon	Category	Explanation
	Information Message	Help messages on various buttons, pull-down lists, etc., as well as frame rate and other information from the camera are shown.
	Warning Message	A message will be displayed notifying the user when camera control privileges cannot be obtained, the audio session stops, etc.
	Error Message	Displayed when a system error occurs in the viewer.

Warning Message

Message	Explanation
Could not connect to the camera.	Connection failed due to an invalid IP address, etc.
The camera is busy.	The connection limit was exceeded.
Failed to get camera control privileges.	The request for camera control privileges was denied because the camera was being used by the Admin Viewer, etc.
Failed to establish audio connection.	Connection for audio reception failed.
You are not connected to the camera.	An attempt was made to operate the camera when the camera was not connected.
Please get camera control privileges.	An attempt was made to operate the camera without camera control privileges.
Another user is already connected as an administrator.	The Admin Viewer is already connected to the camera.
The viewer is already connected in another window.	The viewer is already available in another window.
No audio device.	The [Audio] button has been clicked when there is no audio device or the audio device has been disabled in the computer.
Failed to initialize Canon Network Camera Audio Receiver.	ActiveX plugin is not installed within ten seconds after clicking the [Audio] button.
Insufficient memory card capacity.	An attempt was made to recording to a memory card with insufficient capacity.
Recording to memory card is not allowed.	Recording to the memory card failed because [Memory Card Operation Status] > [Operation Settings] was not set to [Save Logs and Videos].
You cannot control the camera unless you exit Viewer PTZ.	The video was clicked with the Viewer PTZ in the ON state while you have control privileges.

Restore Default Settings

If you have forgotten the settings and want to set the camera from the beginning, restore the factory default settings first. It is recommended that you create a backup file using [Back Up Settings] in the Camera Management Tool before restoring the factory default settings.

Note

- For details on using Camera Management Tool, please refer to "Camera Management Tool User Manual".
- For factory default settings, please refer to P. 273.

Restoring the Initial Setting from the Maintenance Page in the Web Browser

- 1 Displays the Setting Page (P. 60).
- 2 On the Setting Menu page, click [Maintenance]

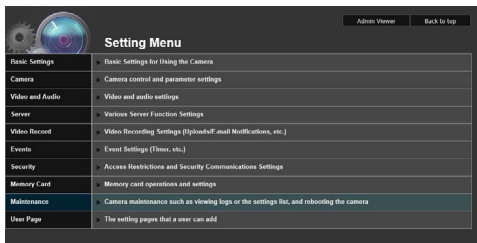

The maintenance page appears.

- 3 Click [Exec] of [Restore Default Settings] in [Tool].

Tool	
View Logs	View
View Current Settings	View
Reboot	Exec
Restore Default Settings	Exec
Back Up Settings	Exec
Restore Settings	Exec
Refresh Drive System	Exec

A confirmation message appears, asking if you want to restore the default settings. To restore the default settings, click [OK].

Except for the following items, all user-defined settings will be discarded and restored to factory default settings after the camera is rebooted.

- Administrator password of the basic settings, LAN, IPv4, IPv6
- Date and Time
- Host access restrictions for security
- SSL/TLS
- 802.1X

Caution

- You must not turn off the camera while it is performing the [Restore Default Settings] operation. Turning off the camera at this stage may result in disabling its ability to boot correctly.
- Once [OK] is clicked, you can no longer stop the process of restoring the default settings.

Restoring Factory Default Settings with the Reset Switch on the Camera

If you have forgotten or do not know the IP address of the camera or your Administrator password, you cannot operate the camera via the network. In this case, reset the camera.

Important

When a camera is initialized by pressing the reset switch, all network related settings including the camera IP address, subnet mask, and default gateway address are restored to the default settings so you will not be able to continue operation from the computer that was connected. Use Camera Management Tool to set a suitable IP address for the operating environment (P. 37).

Prepare the camera for being reset in advance.

In order to press the reset switch or restart switch, it may be necessary to remove such items as the dome case or cover. For details, please refer to the "Installation Guide" included with the camera.

R11 (VB-R11VE) **R10** **M641** **M640** **M741** **M740**

- 1** Hold down the reset switch while pressing the restart switch with a pointed object.
- 2** Release the restart switch after at least 3 seconds while still holding down the reset switch.
- 3** Release the reset switch when the LED starts flashing.

When the LED stops flashing, the reset procedure is complete.

VB-R11VE/VB-R10VE

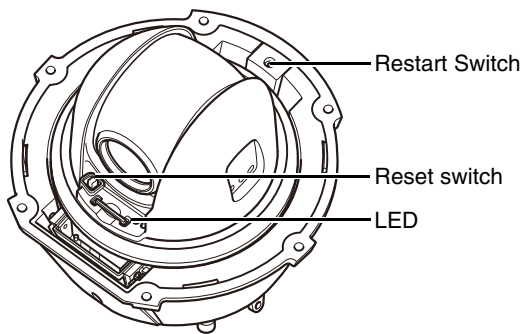

VB-M641VE/VB-M640VE

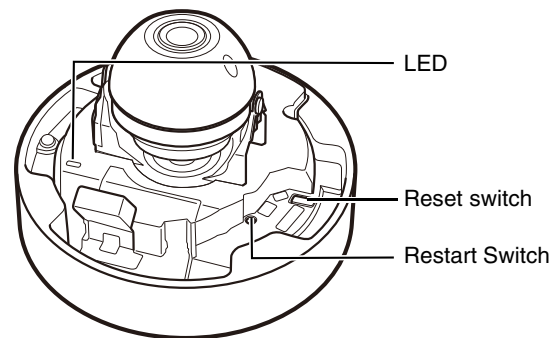

VB-M641V/VB-M640V

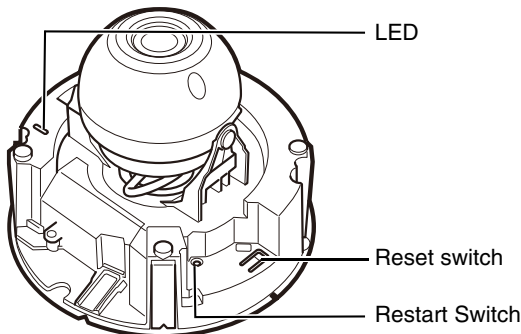

VB-M741LE/VB-M740E

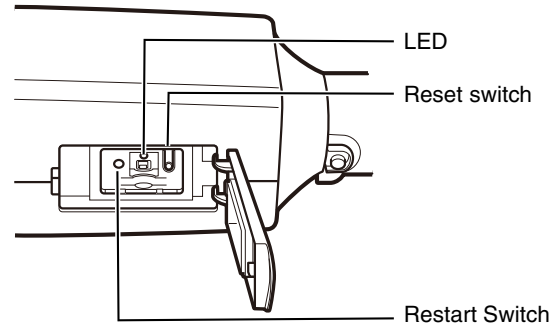

R11 (VB-R11)

- 1** Turn the camera off by disconnecting the power cable.

The camera does not have a power switch. To turn the camera on or off, connect or disconnect the power cable.

- 2** Hold down the reset switch and connect the power cable. Continue to hold the reset switch for five seconds or longer.

The LED will flash.

- 3** Release the reset switch.

When the LED stops flashing, the reset procedure is complete.

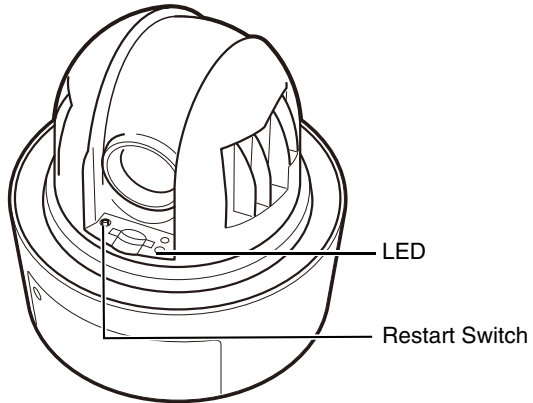

List of Factory Default Settings

Item	Setting
• LAN	
LAN Interface	Auto
Maximum Packet Size	1500
• IPv4	
IPv4 Address Setting Method	Manual
IPv4 Address	192.168.100.1
Subnet Mask	255.255.255.0
IPv4 Default Gateway Address	
AutoIP	Enable
IPv4 Address (AutoIP)	
• IPv6	
IPv6	Enable
Auto (RA)	Enable
Auto (DHCPv6)	Enable
IPv6 Address (Manual)	
Prefix Length	64
IPv6 Default Gateway Address	
IPv6 Address (Auto)	
• DNS	
Name Server Address 1	
Name Server Address 2	
Auto-Setting of Name Server Address	Disable
Host Name	
Host Name Registration with DDNS	Disable
Search Domain	
Search Domain List	
• mDNS	
Use mDNS	Enable
• User Name (Administrator ID)	root
• Administrator Password	camera
• Current Date and Time	
• Setting	
Setting Method	Set manually
Auto-Setting of NTP Server	Disable
NTP Server	
Time zone	(GMT+09:00) Osaka, Sapporo, Tokyo
Daylight Saving Time	Disable

Item	Setting
• All Videos	
Video Size Set	1280x720 / 640x360 / 320x180
• JPEG	
Video Quality: 320x180	6
Video Quality: 640x360	6
Video Quality: 1280x720	6
Video Quality: Digital PTZ M641 M640 M741 M740	6
Video Size: video Transmission	320x180
Maximum Frame Rate: Video Transmission	30.0
Video Size: Upload/ Memory Card	320x180
• H.264(1)	
Video Size	320x180
Bit Rate Control	Use bit rate control
Video Quality	6
Target Bit Rate (kbps)	2048
Frame Rate (fps)	30
I Frame Interval (sec)	1
• H.264(2)	
H.264(2)	Disable
Video Size	320x180
Bit Rate Control	Use bit rate control
Video Quality	6
Target Bit Rate (kbps)	2048
Frame Rate (fps)	30
I Frame Interval (sec)	1
• Camera Name	
Camera Name (alphanumeric characters)	Camera
• Camera Control	
Digital Zoom R11 R10	Disable
Image Stabilizer	Disable
AGC Limit	6
Smart Shade Control Strength (Auto)	Medium
Haze Compensation Strength (Auto)	Medium
Infrared Strength (Auto) M741	Strong

Item	Setting
Pan/Tilt Speed Control R11 R10	Control by zoom position
Auto Flip R11 R10	Enable
• Day/Night (When Auto Is Set)	
Switching Brightness	Standard
Response (sec.)	20
• Installation Conditions	
LED Setting M741 M740	Turn On
Image Flip	Disable
• Camera Position Control	
Restricted to Presets R11 R10	No Restriction
Camera Position without Control	Do not return to Home Position
• External Input Device 1 R11 M641 M741	
Device Name (alphanumeric characters)	
• External Input Device 2 R11 M641 M741	
Device Name (alphanumeric characters)	
• External Output Device 1 R11 M641 M741	
Device Name (alphanumeric characters)	
• External Output Device 2 R11 M641 M741	
Device Name (alphanumeric characters)	
• Initial Camera Settings	
Pan/Tilt/Zoom position	Enable
Focus	Auto
Exposure	Auto
Slow Shutter	Disable
Shutter Speed	1/60
Exposure Compensation	0
Metering Mode	Center-Weighted
Smart Shade Control	Disable
Smart Shade Control level	1 (Mild)
White Balance	Auto
R Gain	255
B Gain	255
Noise Reduction	Standard
Sharpness	3
Color Saturation	4
Haze Compensation	Disable

Item	Setting
Haze Compensation Level	2
Day/Night	Day Mode
Use Infrared M741	Day/Night Operation
• Specified Area	
Area 1 (Pink)	Disable
Area 2 (Purple)	Disable
Area 3 (Blue)	Disable
Area 4 (Cyan)	Disable
Area 5 (Green)	Disable
Area 6 (Yellow)	Disable
Area 7 (Orange)	Disable
Area 8 (White)	Disable
• ADSR	
Use H.264(1)	Disable
Use H.264(2)	Disable
• On-Screen Display	
Date display	Disable
Position of date display	Upper left
Format of date display	YYYY/MM/DD
Time display	Disable
Position of time display	Upper left
Text display	Disable
Position of text display	Upper left
Text string display	
Color of text	White
Background color	Black
Color depth of text and background	Fill text and background color
R11 M641 M741	
• General Sound	
Input Volume	50
Output Volume	50
Echo Cancellor	Disable
Audio Input	Line In
• Sound Clip Upload 1	
Sound Clip Name	
• Sound Clip Upload 2	
Sound Clip Name	
• Sound Clip Upload 3	
Sound Clip Name	
• HTTP Server	
Authentication Method	Digest Authentication

Item	Setting
HTTP Port	80
HTTPS Port	443
• SNMP Server	
SNMP	Disable
Community Name	public
Administrator Contact Information	
Administration Function Name	R11 R10 VB-R11/VB-R11VE/ VB-R10VE M641 M640 VB-M641VE/ VB-M641V/ VB-M640VE/VB-M640V M741 M740 VB-M741LE/VB-M740E
Installation Location	
• FTP Server	
Use FTP Server	Disable
• WS-Security	
Check Time on Authentication	Check
• Video Server	
Maximum Number of Clients	30
Camera Control Queue Length	30
Maximum Connection Time (sec.)	0
Camera Control Time (sec.)	20
R11 M641 M741	
• Audio Server	
Audio Transmission from the Camera	Disable
Voice Activity Detection	Disable
Audio Reception from Viewer	Disable
• RTP Server	
RTP	Enable
RTSP Authentication Method	Digest Authentication
RTSP Port	554
• Audio Multicast	
R11 M641 M741	
Multicast Address	0.0.0.0
Multicast Port Number	0
Multicast TTL	1
• RTP Streaming 1	
Video Size	320x180 JPEG
Frame Rate	5
Multicast Address	0.0.0.0
Multicast Port Number	0
Multicast TTL	1

Item	Setting
Audio Transmission	Disable
R11 M641 M741	
• RTP Streaming 2	
Video Size	320x180 JPEG
Frame Rate	10
Multicast Address	0.0.0.0
Multicast Port Number	0
Multicast TTL	1
Audio Transmission	Disable
R11 M641 M741	
• RTP Streaming 3	
Video Size	320x180 JPEG
Frame Rate	15
Multicast Address	0.0.0.0
Multicast Port Number	0
Multicast TTL	1
Audio Transmission	Disable
R11 M641 M741	
• RTP Streaming 4	
Video Size	320x180 JPEG
Frame Rate	30
Multicast Address	0.0.0.0
Multicast Port Number	0
Multicast TTL	1
Audio Transmission	Disable
R11 M641 M741	
• RTP Streaming 5	
Video Size	H.264(1)
Frame rate	5
Multicast Address	0.0.0.0
Multicast Port Number	0
Multicast TTL	1
Audio Transmission	Disable
R11 M641 M741	
• Video Record Setting	
Video Record Action	Upload
• General Upload	
Upload	Upload Disabled
Video Format	JPEG
Frame Rate	1
Pre-event Buffer (number of frames)	0
Post-event Buffer (number of frames)	0
Pre-event Buffer (sec)	0

Item	Setting
Post-event Buffer (sec)	0
• HTTP Upload	
Notification	Notification Only with HTTP
URI	
User Name	
Proxy Server	
Proxy Port	80
Proxy User Name	
Parameter (query string)	
• FTP Upload	
Notification	Video data upload with FTP
FTP Server	
User Name	
PASV Mode	Enable
File Upload Path	
File Naming	YYYYMMDDHHMMSS ms
Subdirectory Name to Create	
File Name to Create	image.jpg
File Name to Create	video.mov
Maximum Number of Loops	0
• Video Record Setting	
Video Record Action	Upload
• Memory Card Operations	
Operation Settings	Save Logs and Videos
Video Format	JPEG
Pre-event Buffer (number of frames)	0
Post-event Buffer (number of frames)	0
Pre-event Buffer (sec)	0
Post-event Buffer (sec)	0
Overwrite videos	Disable
Auto Video Delete	Disable
Days Saved	30
Delete Time	00:00
• E-mail Notification	
Notification	Text Only
Mail Server Name	
Mail Server Port	25
Sender (From)	
Recipient (To)	

Item	Setting
Authentication	None
User Name	
POP Server	
Subject	
Message Body	
R11 M641 M741	
• External Device Output 1	
Operation Mode	Normally Open
Active Output Format	Continuous
Pulse Output Time (sec)	1
• External Device Output 2	
Operation Mode	Normally Open
Active Output Format	Continuous
Pulse Output Time (sec)	1
• External Device Input	
External Device Input Event	Enable
• External Device Input 1	
Operation Mode	Normally Open
Active Event Operation	Disable
Inactive Event Operation	Disable
Ongoing Active Event Operation	Disable
Preset R11	Not specified
Video Record	Disable
E-mail Notification	Disable
External Device Output for Active Event	Disable
External Device Output for Inactive Event	Disable
Audio Playback at Active Event	Disable
Audio Playback at Inactive Event	Disable
Sound Clip	
Volume	50
Day/Night Mode Switching	Disable
• External Device Input 2	
Operation Mode	Normally Open
Active Event Operation	Disable
Inactive Event Operation	Disable
Ongoing Active Event Operation	Disable
Preset R11	Not specified
Video Record	Disable
E-mail Notification	Disable
External Device Output for Active Event	Disable

Item	Setting
External Device Output for Inactive Event	Disable
Audio Playback at Active Event	Disable
Audio Playback at Inactive Event	Disable
Sound Clip	
Volume	50
Day/Night Mode Switching	Disable
R11 M641 M741	
• Volume Detection	
Volume Detection Event	Disable
Detect Criteria	The reference volume level or above
Reference Volume Level	50
Detect Criteria Duration (sec)	0
ON Event Operation	Disable
OFF Event Operation	Disable
Ongoing ON Event Operation	Disable
Preset R11	Not specified
Video Record	Disable
E-mail Notification	Disable
External Device Output for ON Event	Disable
External Device Output for OFF Event	Disable
• Scream Detection	
Scream Detection Event	Disable
ON Event Operation	Disable
Preset R11	Not specified
Video Record	Disable
E-mail Notification	Disable
External Device Output for ON Event	Disable
• Timer 1	
Timer Event	Disable
24-Hour Continuous Setting	Disable
Start Time	00:00
End Time	00:00
Repeat Interval	None
• Operation	
Start Time Preset R11 R10	Not specified
Video Record	Disable
E-mail Notification	Disable
External Device Output R11 M641 M741	Disable

Item	Setting
Day/Night Mode Switching	Disable
• Timer 2	
Timer Event	Disable
24-Hour Continuous Setting	Disable
Start Time	00:00
End Time	00:00
Repeat Interval	None
• Operation	
Start Time Preset R11 R10	Not specified
Video Record	Disable
E-mail Notification	Disable
External Device Output R11 M641 M741	Disable
• Timer 3	
Timer Event	Disable
24-Hour Continuous Setting	Disable
Start Time	00:00
End Time	00:00
Repeat Interval	None
• Operation	
Start Time Preset R11 R10	Not specified
Video Record	Disable
E-mail Notification	Disable
External Device Output R11 M641 M741	Disable
• Timer 4	
Timer Event	Disable
24-Hour Continuous Setting	Disable
Start Time	00:00
End Time	00:00
Repeat Interval	None
• Operation	
Start Time Preset R11 R10	Not specified
Video Record	Disable
E-mail Notification	Disable
External Device Output R11 M641 M741	Disable
• Day/Night Mode Switching	
Preset when Switching to Day Mode	Not specified
Preset when Switching to Night Mode	Not specified
R11 M641 M741	
• Linked Event 1	

Item	Setting
Linked Event	Disable
Event Linking Method	AND
Event Order	Not specified
Event Interval (sec.)	2
Event 1	
Event Type	External Device Input
External Device Input	Input 1
Status	Active
Event 2	
Event Type	Intelligent Function
Intelligent Function	Setting 1
Status	ON
Operation	
ON Event Operation	Disable
Ongoing ON Event Operation	Disable
OFF Event Operation	Disable
Preset R11	None
Video Record	Disable
E-mail Notification	Disable
External Device Output for ON Event	Disable
External Device Output for OFF Event	Disable
Audio Playback at ON Event	Disable
Audio Playback at OFF Event	Disable
Sound Clip	
Volume	50
• Linked Event 2	
Linked Event	Disable
Event Linking Method	AND
Event Order	Not specified
Event Interval (sec.)	2
Event 1	
Event Type	External Device Input
External Device Input	Input 1
Status	Active
Event 2	
Event Type	Intelligent Function
Intelligent Function	Setting 1
Status	ON
Operation	
ON Event Operation	Disable
Ongoing ON Event Operation	Disable

Item	Setting
OFF Event Operation	Disable
Preset R11	None
Video Record	Disable
E-mail Notification	Disable
External Device Output for ON Event	Disable
External Device Output for OFF Event	Disable
Audio Playback at ON Event	Disable
Audio Playback at OFF Event	Disable
Sound Clip	
Volume	50
• Linked Event 3	
Linked Event	Disable
Event Linking Method	AND
Event Order	Not specified
Event Interval (sec.)	2
Event 1	
Event Type	External Device Input
External Device Input	Input 1
Status	Active
Event 2	
Event Type	Intelligent Function
Intelligent Function	Setting 1
Status	ON
Operation	
ON Event Operation	Disable
Ongoing ON Event Operation	Disable
OFF Event Operation	Disable
Preset R11	None
Video Record	Disable
E-mail Notification	Disable
External Device Output for ON Event	Disable
External Device Output for OFF Event	Disable
Audio Playback at ON Event	Disable
Audio Playback at OFF Event	Disable
Sound Clip	
Volume	50
• Linked Event 4	
Linked Event	Disable
Event Linking Method	AND
Event Order	Not specified

Item	Setting
Event Interval (sec.)	2
Event 1	
Event Type	External Device Input
External Device Input	Input 1
Status	Active
Event 2	
Event Type	Intelligent Function
Intelligent Function	Setting 1
Status	ON
Operation	
ON Event Operation	Disable
Ongoing ON Event Operation	Disable
OFF Event Operation	Disable
Preset R11	None
Video Record	Disable
E-mail Notification	Disable
External Device Output for ON Event	Disable
External Device Output for OFF Event	Disable
Audio Playback at ON Event	Disable
Audio Playback at OFF Event	Disable
Sound Clip	
Volume	50
• Authorized User Account	
User List	
• User Authority	
Authorized User	
Privileged Camera Control	Checked
Camera Control	Checked
Video Distribution	Checked
Audio Distribution R11 M641 M741	Checked
Guest User	
Camera Control	Checked
Video Distribution	Checked
Audio Distribution R11 M641 M741	Checked
• IPv4 Host Access Restrictions	
Apply Host Access Restrictions	Disable
Default Policy	Authorize Access
Network Address / Subnet	01: / 32 Yes 02: / 32 Yes 03: / 32 Yes

Item	Setting
	04: / 32 Yes
	05: / 32 Yes
	06: / 32 Yes
	07: / 32 Yes
	08: / 32 Yes
	09: / 32 Yes
	10: / 32 Yes
	11: / 32 Yes
	12: / 32 Yes
	13: / 32 Yes
	14: / 32 Yes
	15: / 32 Yes
	16: / 32 Yes
	17: / 32 Yes
	18: / 32 Yes
	19: / 32 Yes
	20: / 32 Yes
• IPv6 Host Access Restrictions	
Apply Host Access Restrictions	Disable
Default Policy	Authorize Access
Prefix / Prefix Length	01: / 128 Yes 02: / 128 Yes 03: / 128 Yes 04: / 128 Yes 05: / 128 Yes 06: / 128 Yes 07: / 128 Yes 08: / 128 Yes 09: / 128 Yes 10: / 128 Yes 11: / 128 Yes 12: / 128 Yes 13: / 128 Yes 14: / 128 Yes 15: / 128 Yes 16: / 128 Yes 17: / 128 Yes 18: / 128 Yes 19: / 128 Yes 20: / 128 Yes
• Certificates	
Certificate Status	Not Installed

Item	Setting
Country (C)	
State/Province (ST)	
Locality (L)	
Organization (O)	
Organizational Unit (OU)	
Common Name (CN)	
Validity Period Start Date	
Validity Period End Date	
• Encrypted communications	
SSL Communications	Disable
• 802.1X Authentication	
802.1X Authentication?	Disable
Authentication Status	Stop
• Authentication Method	
Authentication Method	EAP-MD5
User Name	
• IPsec	
IPsec	Auto Key Exchange
• Auto Key Exchange Settings	
IPsec SA Encryption Algorithm	AES->3DES
IPsec SA Authentication Algorithm	HMAC_SHA1_96
IPsec SA Validity Period (min)	480
ISAKMP SA Encryption Algorithm	AES->3DES
ISAKMP SA Authentication Algorithm	SHA1
DH Group	Group 2
ISAKMP SA Validity Period (min)	480
• IPsec Set 1	
IPsec Set	Disable
IPsec Mode	Tunnel Mode
Destination IPv4 Address	
Destination IPv6 Address	
Source IPv4 Address	
Source IPv6 Address	
Security Protocol	ESP
Security Gateway IPv4 Address	
Security Gateway IPv6 Address	
Destination Subnet Mask Length	16
Destination Prefix Length	16
IKE Pre-Shared Key	
SA ESP Encryption Algorithm	AES
SA ESP Authentication Algorithm	HMAC_SHA1_96
SA ESP Encryption Key (outbound)	
SA ESP Authentication Key (outbound)	
SA ESP SPI (outbound)	
SA ESP Encryption Key (inbound)	
SA ESP Authentication Key (inbound)	
SA ESP SPI (inbound)	
SA AH Authentication Algorithm	HMAC_SHA1_96
SA AH Authentication Key (outbound)	
SA AH SPI (outbound)	
SA AH Authentication Key (inbound)	
SA AH SPI (inbound)	

Item	Setting
SA ESP Encryption Key (outbound)	
SA ESP Authentication Key (outbound)	
SA ESP SPI (outbound)	
SA ESP Encryption Key (inbound)	
SA ESP Authentication Key (inbound)	
SA ESP SPI (inbound)	
SA AH Authentication Algorithm	HMAC_SHA1_96
SA AH Authentication Key (outbound)	
SA AH SPI (outbound)	
SA AH Authentication Key (inbound)	
SA AH SPI (inbound)	
• IPsec Set 2	
IPsec Set	Disable
IPsec Mode	Tunnel Mode
Destination IPv4 Address	
Destination IPv6 Address	
Source IPv4 Address	
Source IPv6 Address	
Security Protocol	ESP
Security Gateway IPv4 Address	
Security Gateway IPv6 Address	
Destination Subnet Mask Length	16
Destination Prefix Length	16
IKE Pre-Shared Key	
SA ESP Encryption Algorithm	AES
SA ESP Authentication Algorithm	HMAC_SHA1_96
SA ESP Encryption Key (outbound)	
SA ESP Authentication Key (outbound)	
SA ESP SPI (outbound)	
SA ESP Encryption Key (inbound)	
SA ESP Authentication Key (inbound)	
SA ESP SPI (inbound)	
SA AH Authentication Algorithm	HMAC_SHA1_96
SA AH Authentication Key (outbound)	
SA AH SPI (outbound)	
SA AH Authentication Key (inbound)	
SA AH SPI (inbound)	

Item	Setting
• IPsec Set 3	
IPsec Set	Disable
IPsec Mode	Tunnel Mode
Destination IPv4 Address	
Destination IPv6 Address	
Source IPv4 Address	
Source IPv6 Address	
Security Protocol	ESP
Security Gateway IPv4 Address	
Security Gateway IPv6 Address	
Destination Subnet Mask Length	16
Destination Prefix Length	16
IKE Pre-Shared Key	
SA ESP Encryption Algorithm	AES
SA ESP Authentication Algorithm	HMAC_SHA1_96
SA ESP Encryption Key (outbound)	
SA ESP Authentication Key (outbound)	
SA ESP SPI (outbound)	
SA ESP Encryption Key (inbound)	
SA ESP Authentication Key (inbound)	
SA ESP SPI (inbound)	
SA AH Authentication Algorithm	HMAC_SHA1_96
SA AH Authentication Key (outbound)	
SA AH SPI (outbound)	
SA AH Authentication Key (inbound)	
SA AH SPI (inbound)	
• IPsec Set 4	
IPsec Set	Disable
IPsec Mode	Tunnel Mode
Destination IPv4 Address	
Destination IPv6 Address	
Source IPv4 Address	
Source IPv6 Address	
Security Protocol	ESP
Security Gateway IPv4 Address	
Security Gateway IPv6 Address	
Destination Subnet Mask Length	16
Destination Prefix Length	16
IKE Pre-Shared Key	
SA ESP Encryption Algorithm	AES

Item	Setting
SA ESP Authentication Algorithm	HMAC_SHA1_96
SA ESP Encryption Key (outbound)	
SA ESP Authentication Key (outbound)	
SA ESP SPI (outbound)	
SA ESP Encryption Key (inbound)	
SA ESP Authentication Key (inbound)	
SA ESP SPI (inbound)	
SA AH Authentication Algorithm	HMAC_SHA1_96
SA AH Authentication Key (outbound)	
SA AH SPI (outbound)	
SA AH Authentication Key (inbound)	
SA AH SPI (inbound)	
• IPsec Set 5	
IPsec Set	Disable
IPsec Mode	Tunnel Mode
Destination IPv4 Address	
Destination IPv6 Address	
Source IPv4 Address	
Source IPv6 Address	
Security Protocol	ESP
Security Gateway IPv4 Address	
Security Gateway IPv6 Address	
Destination Subnet Mask Length	16
Destination Prefix Length	16
IKE Pre-Shared Key	
SA ESP Encryption Algorithm	AES
SA ESP Authentication Algorithm	HMAC_SHA1_96
SA ESP Encryption Key (outbound)	
SA ESP Authentication Key (outbound)	
SA ESP SPI (outbound)	
SA ESP Encryption Key (inbound)	
SA ESP Authentication Key (inbound)	
SA ESP SPI (inbound)	
SA AH Authentication Algorithm	HMAC_SHA1_96
SA AH Authentication Key (outbound)	
SA AH SPI (outbound)	
SA AH Authentication Key (inbound)	

Item	Setting
SA AH SPI (inbound)	

Numerics

802.1X Authentication 124

A

Abandoned Object Detection 211, 221
 Access Control 118, 138
 Admin Tools 192
 Admin Tools Certificate 22, 28
 Admin Viewer 138, 140, 141
 Administrator 138
 Administrator Password 36, 68
 ADSR 82
 AGC Limit 75
 Aperture 80, 163
 Area Zoom 150
 Area Zoom/Drag to Move 142
 Audio Detection 107, 185, 213
 Audio Distribution 118, 138
 Audio Input 87
 Audio Multicast 93
 Audio Reception 92, 142
 Audio Server 92
 Audio Transmission 92, 142
 Authentication Method 89, 124
 Authorized Users 118, 138
 Auto Control Settings 177
 Auto Flip 76, 209
 Auto Key Exchange 126
 Auto Tracking 185, 213, 214, 230
 Auto Video Delete 132
 AutoIP 38, 65

B

Back Light Compensation 142, 155
 Back Up Settings 135
 Basic Camera Settings 37
 Bit Rate Control 73

C

Camera Angle Setting Tool 22, 28, 45
 Camera Control 118, 138
 Camera Control Privilege Status Indicator 188
 Camera Control Privileges 142
 Camera Management Tool 21, 28, 36

Camera Name 75
 Camera Search Settings 36
 Camera Tampering Detection 212, 223
 Certificate Information 124
 Certificate Management 122, 125
 Client 124
 Color Saturation 81, 168
 Context Menu 145, 175, 183, 189, 229
 Control for Admin 158, 195
 Control Privileges 147
 Custom Installation 29

D

Date 69
 Day Mode 165
 Day/Night 77, 112, 165
 Day/Night Mode Focus Settings 165
 Daylight Saving Time 71
 Default Gateway Address 65, 66
 Detect Criteria 107
 Detection Areas 234
 Detection Criteria 218, 219
 Detection Lines 224, 234
 Detections Settings 228
 Device Information 134
 Device Name 78
 DHCP 37, 64
 DHCPv6 65
 Digital PTZ 153
 Digital Zoom 75, 148
 Display Options 234
 Display Size 144
 DNS 66
 Download 236
 Log Files 236
 Video 242, 250
 Drag to Move 150

E

Easy Installation 29
 E-mail Notification 102, 106, 108, 109,
 111, 115, 228
 Encrypted Communications 123
 Error Message 269
 Event 227

Event Display	184, 234
Exposure	80, 162
Exposure Compensation	55, 80, 162
External Device Input	104, 184
External Device Output	104, 167
External Input Device	78
External Output Device	78

F

Factory Default Settings	270, 273
Filter	238, 241
Firewall	31
Firmware	134
Focus	54, 80, 161
Format	132
Frame Rate	74, 94, 97
FTP Server	90
FTP Upload	99
Full Screen Display	144

G

Gain	80, 163
Guest Users	118, 138

H

H.264 Video	23, 73, 82, 168, 246
H.264(1)	73
H.264(2)	74
Haze Compensation	81, 160
Haze Compensation Strength	76
Home Position	78, 142, 170, 172
Host Access Restrictions	119, 120
HTTP Port	89
HTTP Server	89
HTTP Upload	97
HTTPS Port	89

I

I Frame Interval	74
Image Detection	184
Image Flip	52, 78
Image Stabilizer	75
Information Display	142, 143
Information Message	269
Infrared	81, 167
Infrared Filter	165
Infrared Illumination Strength	167

Infrared Strength	76
Initial Setting	36, 79, 159, 270
Initial Setting Registration	159
Input Volume	87
Installation Guide	5
Intelligent Function	
Display Options	234
Operation Mode	214
Restart	235
Intelligent Function Setting Tool	210
Intrusion Detection	213, 226
IPsec	126
IPv4	37, 64
IPv4 Address	37
IPv6	65

J

JPEG Video	72, 168, 245
------------------	--------------

L

LAN	64
Language Button	41
LED	78
Linked Event	113, 185
Lock camera position	216
Log	236
Log Code	237
Log Messages	256
Log Viewer	236
Logs	134

M

Maintenance	134
Maximum Frame Rate	73, 168
Maximum Number of Clients	91
Maximum Packet Size	64
Memory Card	20, 101, 130, 142, 250
Memory Card Capacity	133
Memory Card Information	132, 241
Message	
Error Message	269
Information Message	269
Log Message	256
Warning Message	269
Metering Mode	80, 163
Microphone	87, 155
Modifier	252
Mount	131
Moving Object Detection	211, 220

Multicast DNS 67

N

Name Server Address 66
Network 64
Network Address / Subnet 119
Night Mode 165
Noise Reduction 81, 168
NTP Server 69

O

One-shot AF 54, 161
One-shot WB 164
On-screen display 85
Operation Mode 104, 105
Operation Settings 131
Output Volume 87
Overwrite videos 132

P

Pan 53, 147, 148
Panorama Creation Tool 201
Panorama Display Panel 151
Panorama Screen 207
Parameter 98, 100, 103, 252
Passing Detection 212, 224
Password 36, 38, 42, 118
Playback Videos 244
Post-event Buffer 97, 131
Pre-event Buffer 97, 131
Prefix 66, 120
Preset 105, 108, 109, 115, 154, 159, 169
 Advanced Settings 173
 Auto Control 177
 Quick Registration 172
 Register 170
 Start Time of Timer 110
 Tour Route 179
 When switching Day/Night Mode 112
Preset Name 174
Preset Registration Panel 170
Preset Selection Menu 154
Privacy Mask Setting Tool 196
Privilege 138
Privileged Camera Control 118, 138
Pulse 104

R

Reboot 134
Receive Audio 155
Reconnect 142
Recorded Video Utility 187, 240
Recording Manually 186
Recording to Memory Card 186
Recreate Video Management Information 132
Reference Volume Level 107
Refresh Drive System 135
Removed Object Detection 211, 222
Reset Switch 270
Restore Settings 135
Revert to Initial Settings 134
RM-Lite 22
Rotation 53
RTP 93
RTSP 93

S

Scream Detection 108
Self-Signed Certificate 121
Setting Menus 60, 62
Setup CD-ROM 5, 21, 28
Sharpness 81, 168
Shutter Speed 80, 163
Slow Shutter 80, 163
Smart Shade Control 80, 159, 160
Smart Shade Control Strength 76
Snapshot 186
SNMP Server 89
Software Installation 28
Sound Clip Upload 88
Specify the initial camera position 230
SSL Communications 123
SSL/TLS Certificate 121
Subnet Mask 65
Switch Day/Night 106, 111, 112, 177

T

Target Bit Rate 73
Tilt 53, 147, 148
Time 69
Time Zone 71
Timer 110, 177
Top Page 41
Tour Route Settings 179
Tracking Conditions 231

Transmit Audio	156
Troubleshooting	254
Trusted Sites	32, 40
Types of Detection	211, 213, 217

U

Unmount	132
Upload	96
User Account	118
User Authentication	42
User List	118
User Name	42, 118, 138
User Page	63

V

VB Viewer	138, 141, 188
Video Detection	211, 214, 216
Video Distribution	118, 138
Video Format	97, 131, 240
Video Quality	73, 74
Video Record	106, 108, 109, 111, 115
Video Record Action	96, 130
Video Record Setting	101
Video Saving	133
Video Server	91
Video Size	72, 94, 143
Video Size Set	72
View Restriction Setting Tool	206
Viewer	
Admin Viewer	138, 147
RM-Lite Viewer	22
VB Viewer	138, 188
Viewer PTZ	151
Voice Activity Detection	92
Volume	106, 228
Volume Detection	107

W

Warning Message	269
White Balance	81, 164
WS-Security	90

Z

Zoom	54, 147, 148
------------	--------------

Free Manuals Download Website

<http://myh66.com>

<http://usermanuals.us>

<http://www.somanuals.com>

<http://www.4manuals.cc>

<http://www.manual-lib.com>

<http://www.404manual.com>

<http://www.luxmanual.com>

<http://aubethermostatmanual.com>

Golf course search by state

<http://golfingnear.com>

Email search by domain

<http://emailbydomain.com>

Auto manuals search

<http://auto.somanuals.com>

TV manuals search

<http://tv.somanuals.com>