

Canon

PUB.DIM-661

Digital Video Camcorder
Instruction Manual

English

Camescope numérique
Manuel d'instruction

Français

Videocámara digital
Manual de Instrucciones

Español

ZR100

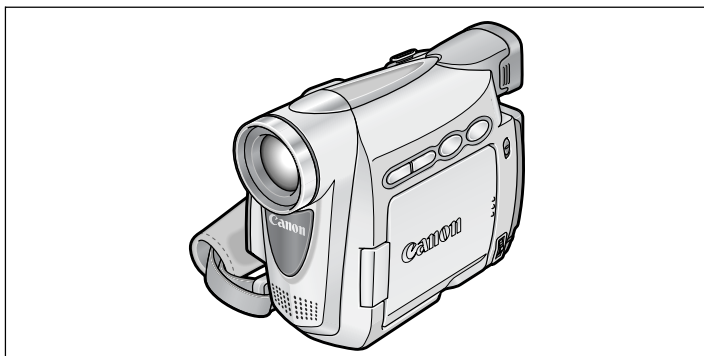

Mini **DV** Digital
Video
Cassette

NTSC

Important Usage Instructions

WARNING!

TO REDUCE THE RISK OF FIRE OR ELECTRIC SHOCK, DO NOT EXPOSE THIS PRODUCT TO RAIN OR MOISTURE.



WARNING!

TO REDUCE THE RISK OF ELECTRIC SHOCK AND TO REDUCE ANNOYING INTERFERENCE, USE THE RECOMMENDED ACCESSORIES ONLY.



COPYRIGHT WARNING:

Unauthorized recording of copyrighted materials may infringe on the rights of copyright owners and be contrary to copyright laws.

Digital Video Camcorder, ZR100 systems

This device complies with Part 15 of the FCC Rules. Operation is subject to the following two conditions: (1) This device may not cause harmful interference, and (2) this device must accept any interference received, including interference that may cause undesired operation.

Note: This equipment has been tested and found to comply with the limits for class B digital device, pursuant to Part 15 of the FCC Rules. These limits are designed to provide reasonable protection against harmful interference in a residential installation. This equipment generates, uses and can radiate radio frequency energy and, if not installed and use in accordance with the instructions, may cause harmful interference to radio communications. However, there is no guarantee that interference will not occur in a particular installation. If this equipment does cause harmful interference to radio or television reception, which can be determined by turning the equipment off and on, the user is encouraged to try to correct the interference by one or more of the following measures:

- Reorient or relocate the receiving antenna.
- Increase the separation between the equipment and receiver.
- Connect the equipment into an outlet on a circuit different from that to which the receiver is connected.
- Consult the dealer or an experienced radio/TV technician for help.

Use of shielded cable is required to comply with class B limits in Subpart B of Part 15 of FCC Rules. Do not make any changes or modifications to the equipment unless otherwise specified in the manual. If such changes or modifications should be made, you could be required to stop operation of the equipment.

Canon U.S.A. Inc.
One Canon Plaza, Lake Success, NY 11042, U.S.A.
Tel No. (516)328-5600

CAUTION:

TO PREVENT ELECTRIC SHOCK, MATCH WIDE BLADE OF PLUG TO WIDE SLOT, FULLY INSERT.

Important Warning



**CAUTION:
TO REDUCE THE RISK OF ELECTRIC SHOCK, DO NOT REMOVE COVER (OR BACK). NO USER-SERVICEABLE PARTS INSIDE. REFER SERVICING TO QUALIFIED SERVICE PERSONNEL.**



The lightning flash with arrowhead symbol, within an equilateral triangle, is intended to alert the user to the presence of uninsulated "dangerous voltage" within the product's enclosure, that may be of sufficient magnitude to constitute a risk of electric shock to persons.

The exclamation point, within an equilateral triangle, is intended to alert the user to the presence of important operating and maintenance (servicing) instructions in the literature accompanying the product.

IMPORTANT SAFETY INSTRUCTIONS

In these safety instructions the word “product” refers to the Canon Digital Video Camcorder ZR100 A and all its accessories.

1. **Read Instructions** — All the safety and operating instructions should be read before the product is operated.
2. **Retain Instructions** — The safety and operating instructions should be retained for future reference.
3. **Heed Warnings** — All warnings on the product and in the operating instructions should be adhered to.
4. **Follow Instructions** — All operating and maintenance instructions should be followed.
5. **Cleaning** — Unplug this product from the wall outlet before cleaning. Do not use liquid or aerosol cleaners. The product should be cleaned only as recommended in this manual.
6. **Accessories** — Do not use accessories not recommended in this manual as they may be hazardous.
7. **Avoid magnetic or electric fields** — Do not use the camera close to TV transmitters, portable communication devices or other sources of electric or magnetic radiation. They may cause picture interference, or permanently damage the camera.
8. **Water and Moisture** — Hazard of electric shock — Do not use this product near water or in rainy/moist situations.
9. **Placing or Moving** — Do not place on an unstable cart, stand, tripod, bracket or table. The product may fall, causing serious injury to a child or adult, and serious damage to the product.
A product and cart combination should be moved with care. Quick stops, excessive force, and uneven surfaces may cause the product and cart combination to overturn.



10. **Power Sources** — The CA-570 Compact Power Adapter should be operated only from the type of power source indicated on the marking label. If you are not sure of the type of power supply to your home, consult your product dealer or local power company. Regarding other power sources such as battery power, refer to instructions in this manual.
11. **Polarization** — The CA-570 Compact Power Adapter is equipped with a polarized 2-prong plug (a plug having one blade wider than the other). The 2-prong polarized plug will fit into the power outlet only one way. This is a safety feature. If you are unable to insert the plug fully into the outlet, try reversing the plug. If the plug still fails to fit, contact your electrician to replace your obsolete outlet. Do not defeat the safety purpose of the polarized plug.
12. **Power Cord Protection** — Power cords should be routed so that they are not likely to be walked on or pinched by items placed upon or against them. Pay particular attention to plugs and the point from which the cords exit the product.
13. **Outdoor Antenna Grounding** — If an outside antenna is connected to the product, be sure the antenna is grounded so as to provide some protection against voltage surges and built-up static charges. Section 810 of the National Electrical Code, ANSI / NFPA No. 70—1984, provides information with respect to proper grounding of the mast and supporting structure, grounding of the lead-in wire to an antenna discharge unit, size of grounding conductors, location of antenna discharge unit, connection to grounding electrodes, and requirements for the grounding electrode. See figure 1.

Fig. 1

EXAMPLE OF ANTENNA GROUNDING
AS PER NATIONAL ELECTRICAL CODE

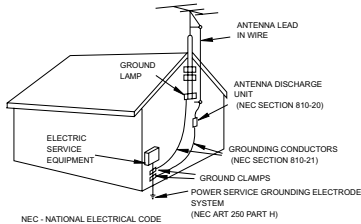

14. Lightning — For added protection of this product during a lightning storm, or when it is left unattended and unused for long periods of time, disconnect it from the wall outlet and disconnect the antenna. This will prevent damage to the product due to lightning and power-line surges.

15. Overloading — Do not overload wall outlets and extension cords as this can result in a risk of fire or electric shock.

16. Objects and Liquid Entry — Never push objects of any kind into this product through openings as they may touch dangerous voltage points or short out parts that could result in a fire or electric shock. Be careful not to spill liquid of any kind onto the product.

17. Servicing — Do not attempt to service this product yourself as opening or removing covers may expose you to dangerous voltage or other hazards. Refer all servicing to qualified service personnel.

18. Damage Requiring Service — Disconnect this product from the wall outlet and all power sources including battery, and refer servicing to qualified service personnel under the following conditions:

- When the power-supply cord or plug is damaged.
- If any liquid has been spilled onto, or objects have fallen into, the product.
- If the product has been exposed to rain or water.
- If the product does not operate normally even if you follow the operating instructions. Adjust only those controls that are covered by the operation instructions. Improper adjustment of other controls may result in damage and will often require extensive work by a qualified technician to restore the product to its normal operation.
- If the product has been dropped or the cabinet has been damaged.
- When the product exhibits a distinct change in performance. This indicates a need for service.

19. Replacement Parts — When replacement parts are required, be sure the service technician has used replacement parts that are specified by Canon or that have the same characteristics as the original part. Unauthorized substitutions may result in fire, electric shock or other hazards.

20. Safety Check — Upon completion of any service or repairs to this product, ask the service technician to perform safety checks to determine that the product is in safe operating order.

When replacement of power supply is required, please return it to the responsible nearest Canon Service Center and please replace it with the same type number CA-570.

The Adapter can be used with a power supply between 100 and 240 V AC. For areas where 120 V AC power is not used, you will need a special plug adapter. Contact your nearest Canon Service Center for further information.

Use only CSA/UL Certified power supply cord set, Polarized, Type SPT-2 or heavier, minimum No. 18 AWG copper, rated 125 or 250 V, minimum P A, minimum 6 ft (1.8 m), maximum 10 ft (3 m) long.



Using this Manual

Thank you for purchasing the Canon ZR100. Please read this manual carefully before you use the camcorder and retain it for future reference.

Change the display language before you begin (64).

E

Symbols and References Used in This Manual

-  : Precautions related to the camcorder operation.
-  : Additional topics that complement the basic operating procedures.
-  : Reference page number.
- Capital letters are used to refer to buttons on the camcorder.
- [] are used to refer to menu items displayed on the screen.
- "Screen" refers to the LCD and the viewfinder screen.

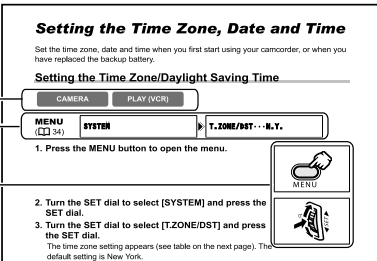

Setting the Time Zone, Date and Time

Set the time zone, date and time when you first start using your camcorder, or when you have replaced the backup battery.

Setting the Time Zone/Daylight Saving Time

Operating modes (see below) — CAMERA PLAY (VCR)

Menu item showing at its default position — MENU SYSTEM T.ZONE/DST ··· N.Y.

Button and switches to be operated —

1. Press the MENU button to open the menu.
2. Turn the SET dial to select [SYSTEM] and press the SET dial.
3. Turn the SET dial to select [T.ZONE/DST] and press the SET dial.
The time zone setting appears (see table on the next page). The default setting is New York.

Introduction

About the Operating Modes

The operating modes are determined by the position of the POWER switch.

Operating Mode	POWER Switch
CAMERA	CAMERA
PLAY (VCR)	PLAY (VCR)

CAMERA : Function can be used in this mode.

CAMERA : Function cannot be used in this mode.

Trademark Acknowledgments

- ^{Min} **DX** is a trademark.
- Windows[®] is either a registered trademark or trademark of Microsoft Corporation in the United States and/or other countries.
- Macintosh and Mac OS are trademarks of Apple Computer, Inc., registered in the United States and other countries.
- Other names and products not mentioned above may be registered trademarks or trademarks of their respective companies.

Table of contents

Introduction

Using this Manual	5
Checking Supplied Accessories	8
Components Guide.....	9

Basic Functions

Preparations

Preparing the Power Supply	12
Loading/Unloading a Cassette	15
Installing the Backup Battery	16
Preparing the Camcorder	17
Adjusting the LCD Screen	18
Setting the Time Zone, Date and Time	19

Recording

Recording Movies on a Tape	22
Zooming.....	26
Tips for Making Better Videos.....	28

Playback

Playing Back a Tape	29
Adjusting the Volume.....	31
Playing Back on a TV Screen.....	32

Advanced Functions

Menus and Settings.....	34
-------------------------	----

Recording

Using the Recording Programs	38
Using the Night Mode	41
Skin Detail Function.....	42
Adjusting the AE Shift.....	43
Adjusting the Focus Manually.....	44
Setting the White Balance	46
Setting the Shutter Speed.....	48
Using the Self-Timer	50
Changing the Recording Mode (SP/LP)	51
Audio Recording	52
Using Digital Effects.....	53
Widescreen TV Recording (16:9)	57

Playback

Magnifying the Image	58
Displaying the Data Code	59
End Search.....	61
Playing Back a Tape with Added Sound	62

Other Functions

Customizing the Camcorder	63
Changing the Display Language	64
Other Camcorder Settings.....	65

Editing

Recording to a VCR or Digital Video Device	67
Recording from Analog Video Devices (VCR, TV or Camcorder)	69
Recording from Digital Video Devices (DV Dubbing)	70
Converting Analog Signals into Digital Signals (Analog-Digital Converter) ...	72
Transferring Video Recordings to a Computer	74





Additional Information

Screen Displays	75
List of Messages	77
Maintenance/Others	78
Troubleshooting	83
System Diagram (Availability differs from area to area)	86
Optional Accessories	87
Specifications	90
Item Codes	92
Index	93

E

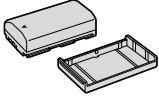
Introduction

Checking Supplied Accessories

<p>CA-570 Compact Power Adapter (incl. power cord)</p> 	<p>NB-2LH Battery Pack</p> 	<p>Lithium Button Battery CR1616</p> 	<p>Lens Cap and Lens Cap Cord</p> 
<p>STV-250N Stereo Video Cable</p> 			

The serial number of this product can be found at the battery attachment unit of the camcorder. Write down the number and other information here and retain this book as a permanent record of your purchase to aid identification in case of theft.

Date of Purchase:

Model Name: ZR100 A

Purchased From:

Serial No.:

Dealer Address:

Dealer Phone No.:



LAMP(S) INSIDE THIS PRODUCT CONTAIN MERCURY AND MUST BE RECYCLED OR DISPOSED OF ACCORDING TO LOCAL, STATE OR FEDERAL LAWS.

Components Guide

ZR100

E

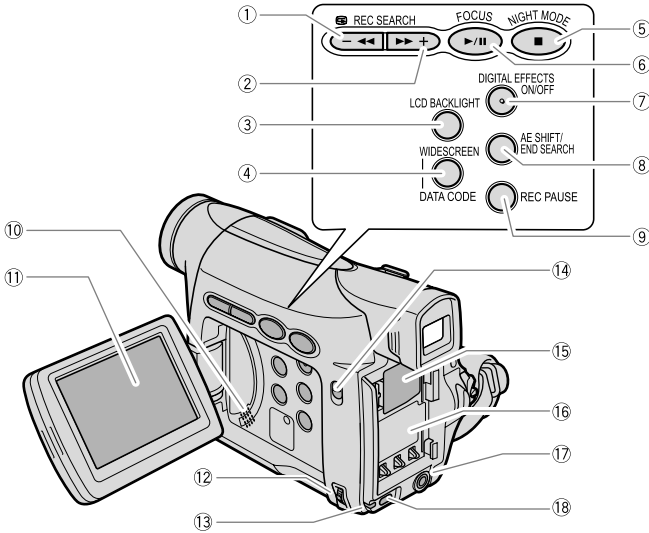

Introduction

- ① REC SEARCH – button (25) /
 (record review) button (25) /
 (rewind) button (29)

- ② REC SEARCH + button (25) /
 (fast forward) button (29)

- ③ LCD BACKLIGHT button (18)

- ④ WIDESCREEN button (57) /
 DATA CODE button (59)

- ⑤ NIGHT MODE button (41) /
 (stop) button (29)

- ⑥ FOCUS button (44) /
 (play/pause) button (29)

- ⑦ DIGITAL EFFECTS ON/OFF button
 (53)

- ⑧ AE SHIFT button (43) /
 END SEARCH button (61)

- ⑨ REC PAUSE button (69)

- ⑩ Speaker (31)

- ⑪ LCD screen (18)

- ⑫ SET dial (34)

- ⑬ CHARGE indicator (12)

- ⑭ Program selector (38)
 EASY Easy recording
 Program AE

- ⑮ Backup battery compartment (16)

- ⑯ Battery attachment unit (12) /
 Serial number

- ⑰ DC IN terminal (12)

- ⑱ MENU button (34)

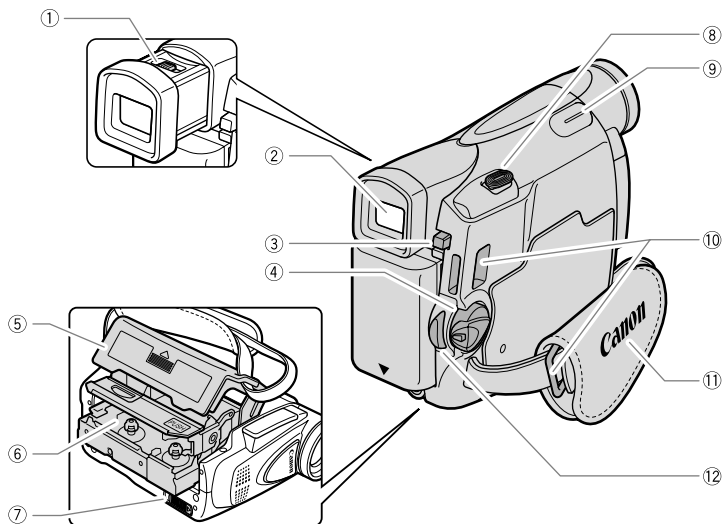

① Dioptic adjustment lever (□ 17)

② Viewfinder (□ 17)

③ BATT. button (□ 12)

④ Power switch (□ 5)

⑤ Cassette compartment cover (□ 15)

⑥ Cassette compartment (□ 15)

⑦ OPEN/EJECT ▲ switch (□ 15)

⑧ Zoom lever (□ 26)

⑨ Finger rest

⑩ Strap mount (□ 88)

⑪ Grip belt (□ 17)

⑫ Start/stop button (□ 22)

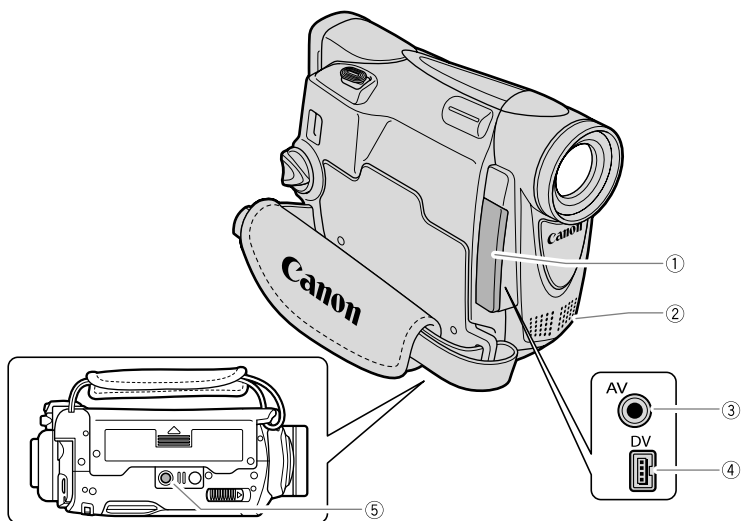

① Terminal cover

② Stereo microphone

③ AV terminal (□ 32)

④ DV terminal (□ 67)

⑤ Tripod socket (□ 28)

Preparing the Power Supply

Attaching the Battery Pack

1. Turn the **POWER** switch to **OFF**.
2. Attach the battery pack to the camcorder.
 - Remove the terminal cover of the battery pack.
 - Press lightly and slide it in the direction of the arrow until it clicks.

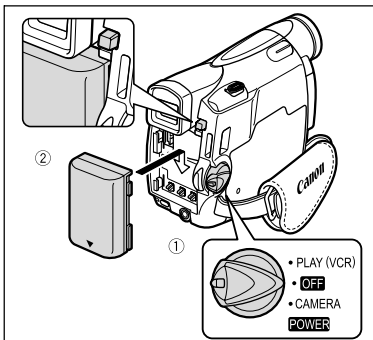

Charging the Battery Pack

1. Connect the power cord to the adapter.
2. Plug the power cord into a power outlet.
3. Connect the power adapter to the camcorder's **DC IN** terminal.
The CHARGE indicator starts flashing. It glows steadily when charging is complete.
4. When charging is complete, disconnect the power adapter from the camcorder. Unplug the power cord from the power outlet and disconnect it from the adapter.

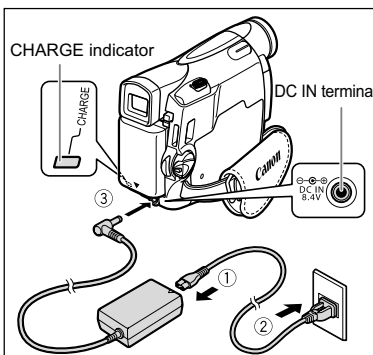

5. Remove the battery pack after use.
Press the **BATT.** button to remove the battery.

Using a Household Power Source

Connect to a household power source to use the camcorder without worrying about the battery power. You can keep the battery pack attached; the battery power will not be consumed.

1. Turn the **POWER** switch to **OFF**.
2. Connect the power cord to the power adapter.
3. Plug the power cord into a power outlet.
4. Connect the power adapter to the camcorder's DC IN terminal.

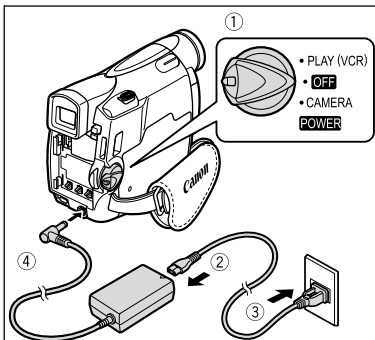

- Turn off the camcorder before connecting or disconnecting the power adapter.
- If the adapter is used close to a TV, it may cause picture interference. Move the adapter away from the TV or the antenna cable.
- Do not connect any products that are not expressly recommended to the camcorder's DC IN terminal or to the power adapter.
- You may hear some noise from the power adapter during use. This is not a malfunction.
- Do not disconnect and reconnect the power cord while charging a battery pack. Charging may stop. The battery pack may not be charged correctly even if the CHARGE indicator glows steady. The battery pack may also not be charged correctly when a power outage occurs during charging. Remove the battery pack and attach it back to the camcorder.



- When the power adapter or battery pack is defective, the CHARGE indicator flashes rapidly (at about 2 flashes/second) and charging stops.
- The CHARGE indicator informs you about the charge status.
 - 0-50%: Flashes once every second
 - More than 50%: Flashes twice every second
 - 100%: Glows steadily

○ **Charging, Recording and Playback Times**

Below times are approximate and vary according to the charging, recording or playback conditions.

Battery Pack		NB-2LH	NB-2L	BP-2L12	BP-2L14
Charging Time		130 min.	115 min.	205 min.	235 min.
Max. Recording Time					
Viewfinder		135 min.	115 min.	245 min.	300 min.
LCD	normal	95 min.	80 min.	170 min.	210 min.
	bright	85 min.	70 min.	145 min.	185 min.
Typical RecordingTime*					
Viewfinder		75 min.	60 min.	130 min.	160 min.
LCD	normal	55 min.	45 min.	95 min.	120 min.
	bright	50 min.	40 min.	85 min.	105 min.
Playback Time		100 min.	85 min.	175 min.	220 min.

* Approximate times for recording with repeated operations such as start/stop, zooming, power on/off. Actual time may be shorter.

- We recommend charging the battery pack in temperatures between 10 °C and 30 °C (50 °F and 86 °F). Outside the temperature range of 0 °C to 40 °C (32 °F to 104 °F), the CHARGE indicator flashes rapidly and charging stops.
- A lithium ion battery pack can be charged at any charge state. Unlike conventional battery packs, you do not need to completely use or discharge it before charging.
- We recommend that you prepare battery packs 2 to 3 times longer than you think you might need.
- To conserve battery power, turn off the camcorder instead of leaving it in record pause mode.

Loading/Unloading a Cassette

Use only videocassettes marked with the ^{Mini} DV logo.

1. Slide the OPEN/EJECT switch and open the cassette compartment cover.

The cassette compartment opens automatically.

2. Load/unload the cassette.

- Load the cassette with the window facing the grip belt.
- Unload the cassette by pulling it straight out.

3. Press the **PUSH mark on the cassette compartment until it clicks.**

4. Wait for the cassette compartment to retract automatically and close the cassette compartment cover.

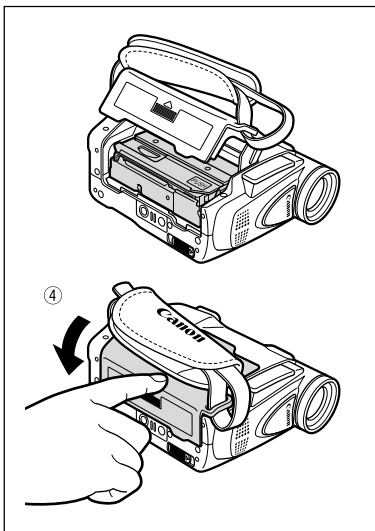
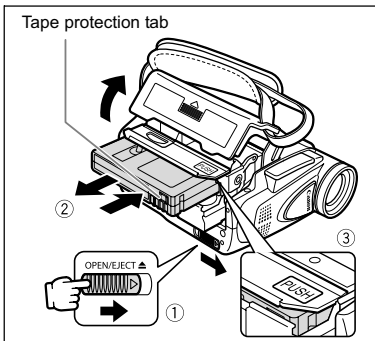

○ Do not interfere with the cassette compartment while it is opening or closing automatically, or attempt to close the cover before the cassette compartment has fully retracted.

○ Be careful not to get your fingers caught in the cassette compartment cover.



If the camcorder is connected to a power source, cassettes can be loaded/unloaded even if the POWER switch is set to OFF.

Installing the Backup Battery

The backup battery (lithium button battery CR1616) allows the camcorder to retain date, time (□ 19) and other camcorder settings while the power source is disconnected.

Connect a power source to the camcorder when replacing the backup battery to retain the settings.

1. Open the backup battery cover.
2. Insert the backup battery with the + side facing outward.

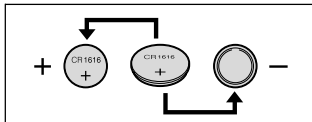

3. Close the cover.

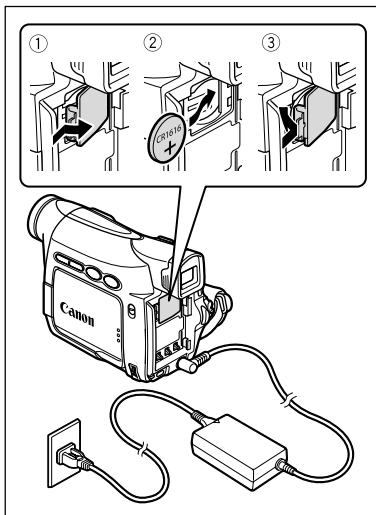

The backup battery has a life span of about a year. “” flashes in red to inform you that it needs to be replaced.

Preparing the Camcorder

E

Adjusting the Viewfinder (Dioptric Adjustment)

1. Turn on the camcorder and keep the LCD panel closed.
2. Pull out the viewfinder.
3. Adjust the dioptic adjustment lever.
4. Push the viewfinder back in.

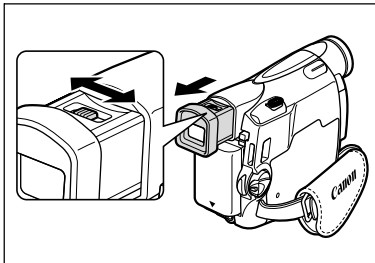

Attaching the Lens Cap

1. Attach the cord to the lens cap.
2. Pass the grip belt through the loop on the cord.

Press the buttons on the lens cap when attaching/removing it. Hook the lens cap on the grip belt while you are recording, and place it over the lens when you have finished.

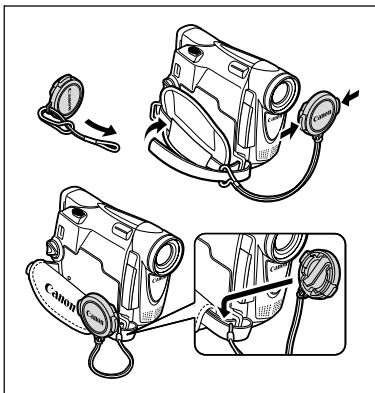

Basic Functions
Preparations

Fastening the Grip Belt

Hold the camcorder with your right hand and adjust the belt with your left.

Adjust the grip belt so that you can reach the zoom lever with your index finger, and the start/stop button with your thumb.

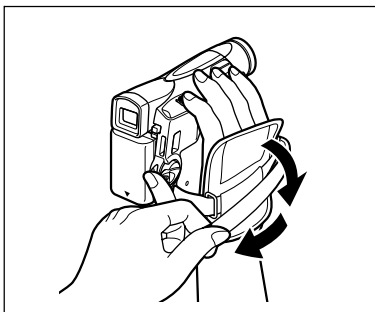

Adjusting the LCD Screen

Rotating the LCD Screen

Open the LCD panel 90 degrees.

- You can rotate the panel by 90 degrees outward.
- You can rotate the panel by 180 degrees inward.

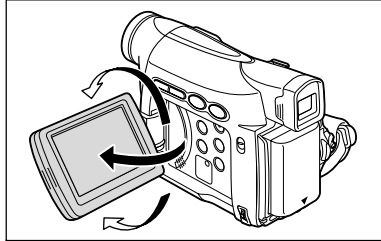

LCD Backlight

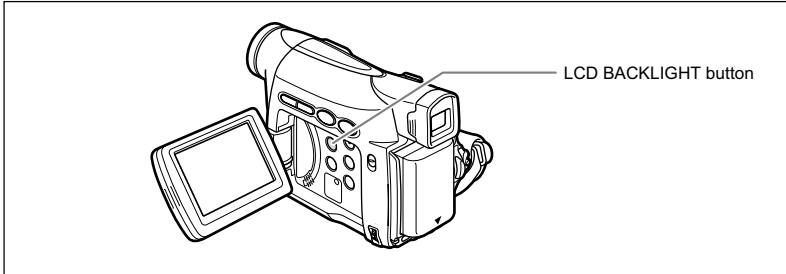

You can switch the brightness of the LCD screen between normal and bright by pressing the LCD BACKLIGHT button. This is useful for outdoor recordings.

Press the LCD BACKLIGHT button.



- This setting does not affect the brightness of the recording or the viewfinder screen.
- When using a battery pack, the camcorder retains the setting even if you change the position of the POWER switch.
- The battery usage time shortens when the LCD screen is set brighter (14).

Setting the Time Zone, Date and Time

Set the time zone, date and time when you first start using your camcorder, or when you have replaced the backup battery.

E

Setting the Time Zone/Daylight Saving Time

CAMERA

PLAY (VCR)

MENU

( 34)

SYSTEM

T.ZONE/DST...N.Y.

1. Press the MENU button to open the menu.

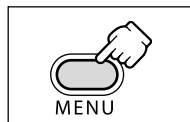

2. Turn the SET dial to select [SYSTEM] and press the SET dial.
3. Turn the SET dial to select [T.ZONE/DST] and press the SET dial.

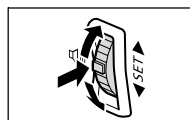

The time zone setting appears (see table on the next page). The default setting is New York.

4. Turn the SET dial to select the setting option that represents your time zone and press the SET dial.

To adjust for daylight saving time, select the time zone with the * next to the area.

Setting the Date and Time

CAMERA

PLAY (VCR)

MENU

( 34)

SYSTEM

D/TIME SET...JAN. 1,2005
12:00 AM

5. Turn the SET dial to select [D/TIME SET] and press the SET dial.

The year display starts to flash.

6. Turn the SET dial to select the year, and press the SET dial.

- The next part of the display starts flashing.
- Set the month, day, hours and minutes in the same way.

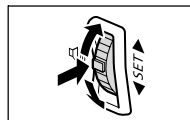

7. Press the MENU button to close the menu and to start the clock.

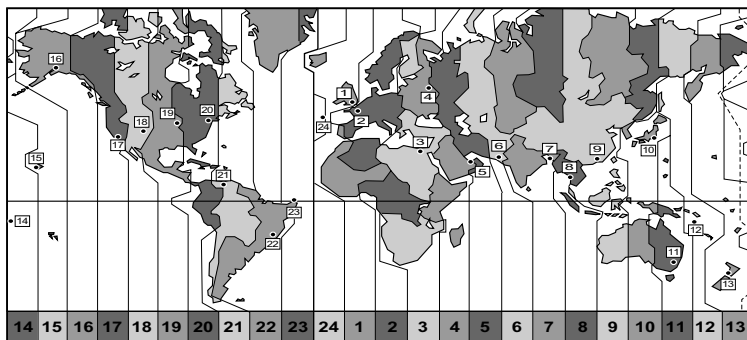
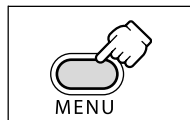

No.	Time zone	No.	Time zone
1	LONDON	13	WELLGTN (Wellington)
2	PARIS	14	SAMOA
3	CAIRO	15	HONOLU. (Honolulu)
4	MOSCOW	16	ANCHOR. (Anchorage)
5	DUBAI	17	L.A. (Los Angeles)
6	KARACHI	18	DENVER
7	DACCA	19	CHICAGO
8	BANGKOK	20	N.Y. (New York)
9	H. KONG (Hong Kong)	21	CARACAS
10	TOKYO	22	RIO (Rio de Janeiro)
11	SYDNEY	23	FERNAN. (Fernando de Noronha)
12	SOLOMON	24	AZORES



Once you have set time zone, date and time, you do not need to reset the clock each time you travel to another time zone. Just set the time zone to the one of your destination, and the camcorder automatically adjusts the clock.

Displaying Date and Time during Recording

You can display the date and time in the lower left corner of the screen.

CAMERA

PLAY (VCR)

E

MENU

( 34)

DISPLAY SETUP/ 

D/T DISPLAY • OFF

1. Press the MENU button to open the menu.

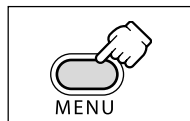

2. Turn the SET dial to select [DISPLAY SETUP/ ] and press the SET dial.

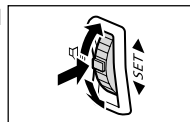

3. Turn the SET dial to select [D/T DISPLAY] and press the SET dial.

4. Turn the SET dial to select [ON].

5. Press the MENU button to close the menu.

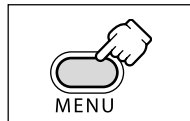

Recording Movies on a Tape

Before You Begin Recording

Make a test recording first to check if the camcorder operates correctly. If necessary, clean the video heads ( 78).

Recording

1. Remove the lens cap.
2. Set the camcorder to CAMERA mode.

Set the POWER switch to CAMERA.

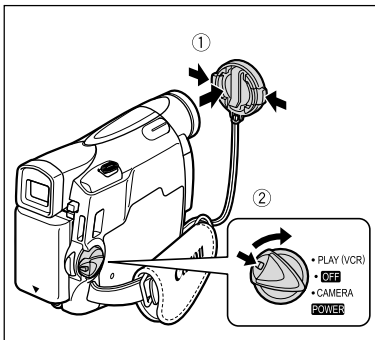

3. Open the LCD panel.
4. Press the start/stop button to begin recording.

Press the start/stop button again to pause recording.

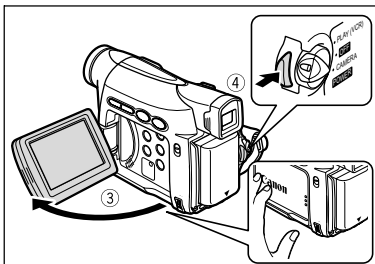

When You Have Finished Recording

1. Turn the POWER switch to OFF.
2. Close the LCD panel.
3. Replace the lens cap.
4. Unload the cassette.
5. Disconnect the power source.

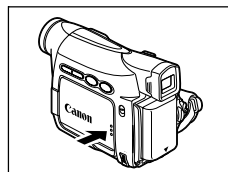



- About the LCD and viewfinder screen: The screens are produced with extremely high-precision manufacturing techniques, with more than 99.99% of the pixels operating to specification. Less than 0.01% of the pixels may occasionally misfire or appear as black or green dots. This has no effect on the recorded image and does not constitute a malfunction.
- The camcorder will shut off after 5 minutes when left in record pause mode to protect tape and video heads. “⚠️ AUTO POWER OFF” appears 20 seconds before shutoff. To continue recording, turn the POWER switch to OFF and then back to CAMERA.
- Wait until the tape counter stops completely before you start recording.
- When you do not remove the cassette, you can record the next scene without producing any noise or blank sections between the recordings even if you turn the camcorder off.
- Bright light may make it difficult to use the LCD screen. In such case, use the viewfinder instead.
- When recording near loud sounds (such as fireworks, drums or concerts), sound may become distorted or may be recorded not in the actual sound level. This is not a malfunction.

Allowing the Subject to Monitor the LCD Screen

You can rotate the LCD panel so that the screen faces in the same direction as the lens. The viewfinder switches on allowing you to use the viewfinder while the subject can monitor the screen.

The image appears mirror reversed (LCD MIRROR ON). However, you can choose to display the image as it is being recorded (LCD MIRROR OFF).

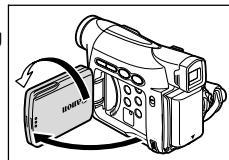

CAMERA

PLAY (VCR)

MENU

(34)

DISPLAY SETUP/

▶ LCD MIRROR...ON

1. Press the MENU button to open the menu.

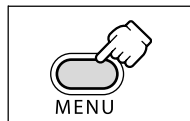

2. Turn the SET dial to select [DISPLAY SETUP/] and press the SET dial.

3. Turn the SET dial to select [LCD MIRROR] and press the SET dial.

4. Turn the SET dial to select [OFF].

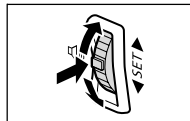

5. Press the MENU button to close the menu.

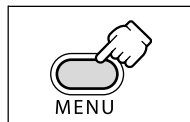

When [LCD MIRROR] is set to [ON], some screen displays appear mirror-reversed.

Screen Displays during Recording



① Time Code

Indicates the recording time in hours, minutes and seconds.

② Remaining tape

Indicates the remaining time of the tape in minutes. "END" flashes when the tape reaches the end.

- When the time left is less than 15 seconds, the remaining tape time may not appear.
- Depending on the type of the tape, the indication may not be displayed correctly.

③ Remaining battery charge

The battery symbol indicates the charge status of the battery pack.



- " " starts flashing in red when the battery pack is empty.
- When you attach an empty battery pack, the power may turn off without displaying " ".
- The actual battery charge may not be indicated accurately depending on the condition under which battery pack and camcorder are used.

④ When " " flashes

" " flashes in red when the lithium button battery is not installed, or when it needs replacing.

⑤ Recording reminder

The camcorder counts from 1 to 10 seconds when you start recording. This is helpful to avoid scenes that are too short.

Reviewing and Searching when Recording

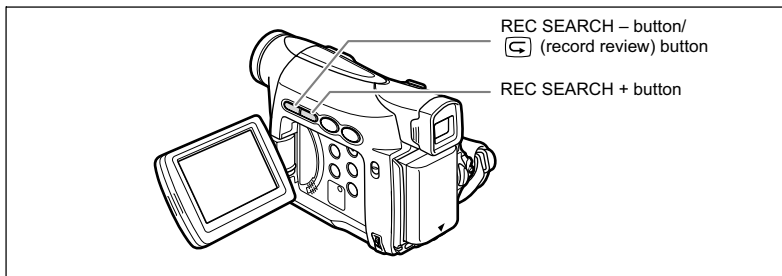

E

Record Review

CAMERA

PLAY (VCR)

In record pause mode, this function allows you to review the last few seconds of your recording to check if it has been recorded properly.

Press and release the G (record review) button.

The camcorder rewinds the tape, plays back the last few seconds, and returns to record pause mode.



Record Search

CAMERA

PLAY (VCR)

In record pause mode, this function allows you to play back the tape (forward or reverse) to locate the point where you wish to begin recording.

Press and hold the REC SEARCH + button (forward) or – button (reverse).

- Release the button at the point you wish to begin recording.
- The camcorder returns to record pause mode.

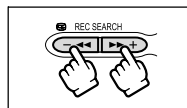

Zooming

The camcorder is equipped with optical zoom and digital zoom.

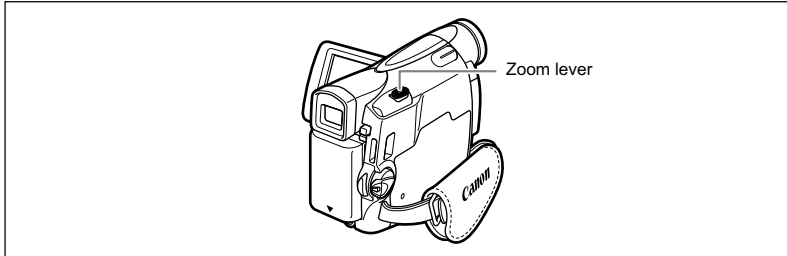
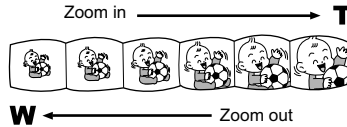

20x Optical Zoom

CAMERA

PLAY (VCR)

Move the zoom lever toward **W to zoom out (wide-angle). Move it toward **T** to zoom in (telephoto).**

Press the zoom lever slightly for a slow zoom. Press harder for a faster zoom.

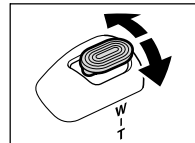

- Keep at least 1 m (3.3 ft.) to the subject. At wide-angle, you can focus on a subject as close as 1 cm (0.39 in.).
- The zoom speed is slightly faster in record pause mode.

80x/400x Digital Zoom

When the digital zoom is activated, the camcorder automatically switches between optical and digital zoom. With digital zoom, image resolution becomes lower the more you zoom in.

E

CAMERA

PLAY (VCR)

MENU

( 34)

CAMERA SETUP

D.ZOOM.....OFF

1. Press the MENU button to open the menu.

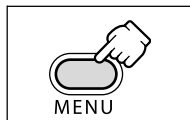

2. Turn the SET dial to select [CAMERA SETUP] and press the SET dial.

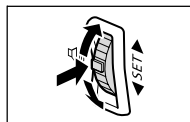

3. Turn the SET dial to select [D.ZOOM] and press the SET dial.

4. Turn the SET dial to select a setting option.

5. Press the MENU button to close the menu.

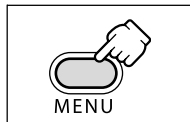

- Digital zoom cannot be used in the Night mode.
- Digital zoom cannot be used when the multi-image screen is selected.
- A zoom indicator appears for 4 seconds. It extends in light blue when the digital zoom is set to 80x, and extends further in dark blue when set to 400x.

Tips for Making Better Videos

Holding the Camcorder

For maximum stability, grip the camcorder in your right hand and keep your right elbow pressed against your body. If necessary, support the camcorder with your left hand. Be careful that your fingers do not touch the microphone or lens.



For More Stability

Lean against a wall



Put the camcorder on a table



Lie on your elbow



Kneel on one knee



Use a tripod



Lighting

When recording outdoors, we recommend recording with the sun at your back.

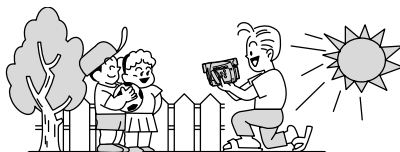

- When using a tripod, do not leave the viewfinder exposed to direct sunlight as it may melt (due to concentration of the light by the lens).

○

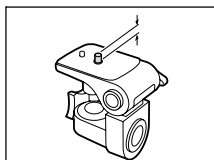

- Do not use tripods with fastening screws longer than 5.5 mm (0.2 in.) as it may damage the camcorder.

Playing Back a Tape

If the playback picture is distorted, clean the video heads using a Canon Head Cleaning Cassette or a commercially available digital video head-cleaning cassette (□ 78).

E

1. Set the camcorder to PLAY (VCR) mode.

Set the POWER switch to PLAY (VCR).

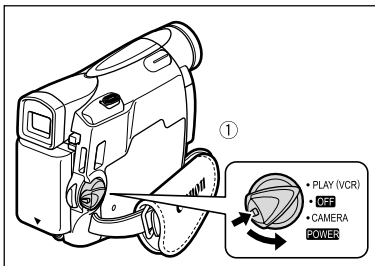

2. Open the LCD panel.

You can also close the LCD panel with the screen facing outward.

3. Press the ◀◀ button to rewind the tape.

4. Press the ▶/|| button to begin playback.

5. Press the ■ button to stop playback.

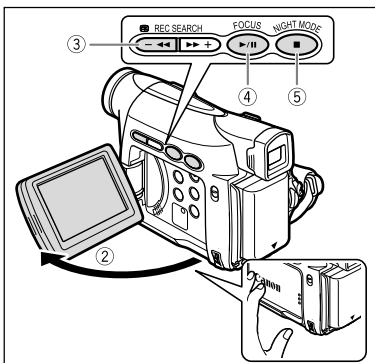

○ To use the viewfinder, close the LCD panel.

○ About the screen display: During playback, the time code gives the hours, minutes, seconds and frames. The remaining tape time may not appear when the time left is less than 15 seconds.

Special Playback Modes

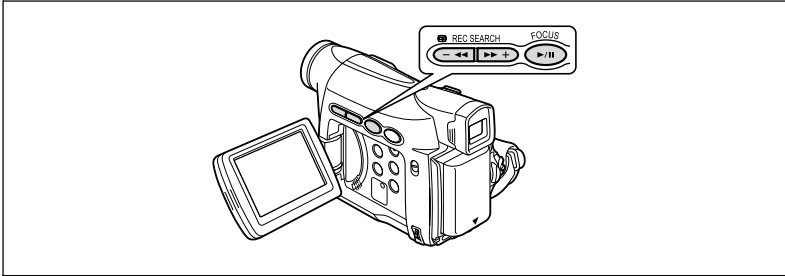

▶/|| (Playback Pause)

To pause playback, press the ▶/|| button during normal playback.

▶▶ (Fast Forward Playback) / ◀◀ (Rewind Playback)

Plays back the tape at 9.5 times normal speed (forward or reverse). Press and hold the button during normal playback or fast forward.



- There is no sound during special playback.
- The picture may become distorted during some special playback modes.
- The camcorder stops the tape automatically after 5 minutes in playback pause mode to protect tape and video heads.

Adjusting the Volume

When you use the LCD screen for playback, the camcorder plays back the sound via built-in speaker. The speaker does not sound when you close the LCD panel.

E

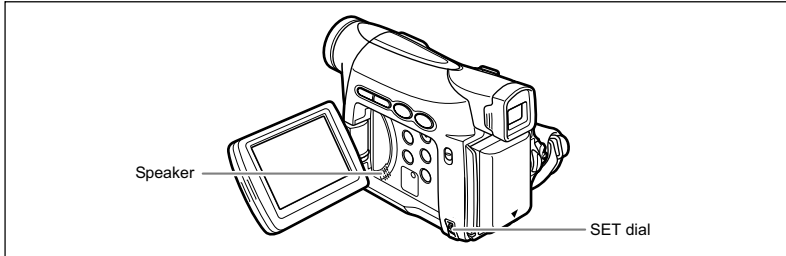

CAMERA

PLAY (VCR)

Turn the SET dial up to increase the volume, and down to lower the volume.

- A volume bar appears for 2 seconds.
- You can turn off the volume completely by turning the SET dial down until [OFF] appears. Turn the SET dial up to increase the volume again.



Basic Functions
Playback

Playing Back on a TV Screen

TVs with Audio/Video Terminals

Refer also to the TV or VCR instruction manual.

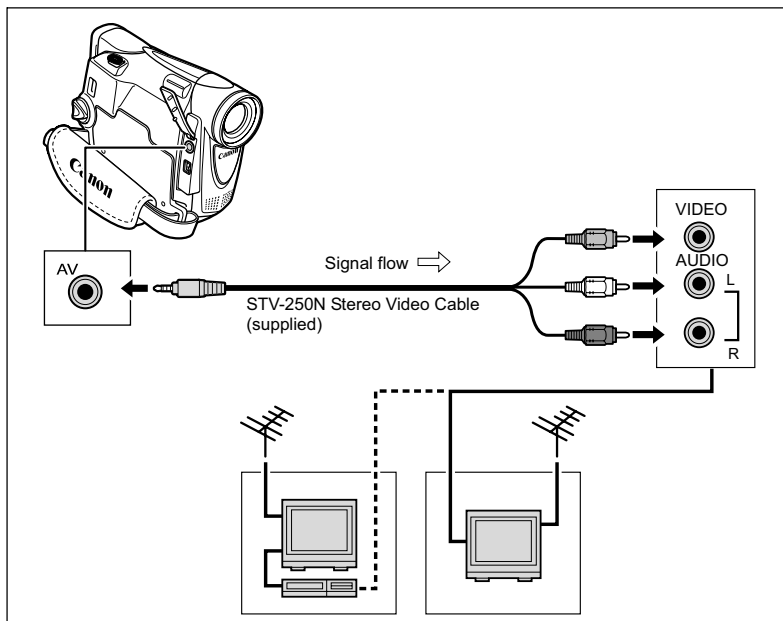

- 1. Turn off all devices before starting the connections.**
- 2. Connect the STV-250N Stereo Video Cable to the camcorder's AV terminal and the audio/video terminals on the TV/VCR.**
Connect the white plug to the white audio terminal L (left), the red plug to the red audio terminal R (right) and the yellow video terminal VIDEO.
- 3. If connecting to a TV, set the input selector to VIDEO. If connecting to a VCR, set the input selector to LINE.**



- We recommend powering the camcorder from a household power source.
- TVs with Video ID-1 system: Recordings made in the widescreen mode will be automatically played back in widescreen mode.

Selecting the Audio Output Channel

You can select the output channels when playing back a tape with audio recorded on two channels.

E

CAMERA

PLAY (VCR)

MENU

( 34)

AUDIO SETUP

▶ OUTPUT CH...L/R

1. Press the **MENU** button to open the menu.

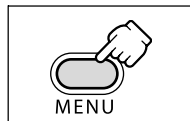

2. Turn the **SET** dial to select [AUDIO SETUP] and press the **SET** dial.

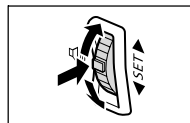

3. Turn the **SET** dial to select [OUTPUT CH] and press the **SET** dial.

4. Turn the **SET** dial to select a setting option.

- L/R: Stereo: L+R channels, Bilingual: Main+Sub.
- L/L: Stereo: L channel, Bilingual: Main.
- R/R: Stereo: R channel, Bilingual: Sub.

5. Press the **MENU** button to close the menu.

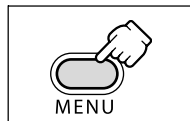

The setting resets to the L/R setting when you turn the camcorder off.

Menus and Settings

Many of the camcorder's advanced functions are selected from menus that appear on the screen.

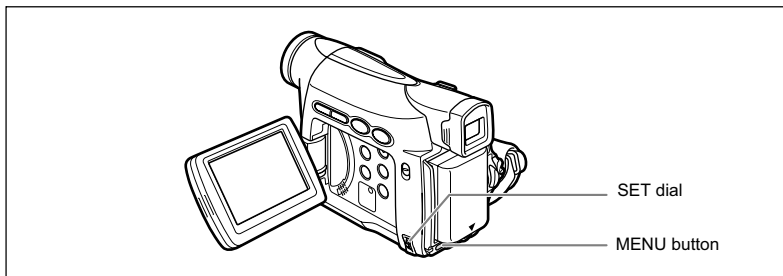

Selecting Menus and Settings

1. Press the MENU button to open the menu.

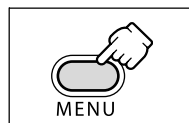

2. Turn the SET dial to select a submenu and press the SET dial.

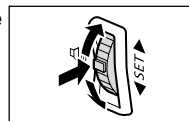

3. Turn the SET dial to select a menu item and press the SET dial.

4. Turn the SET dial to select a setting option.

5. Press the MENU button to close the menu.

When setting the white balance, shutter speed or language, press the SET dial first before pressing the MENU button.

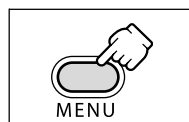

○ Pressing the MENU button at any time closes the menu.

○ Items that are not available appear in purple.

Menu and Default Settings









Default settings are shown in boldface.

CAMERA MENU

CAMERA

PLAY (VCR)

E

Submenu	Menu Item	Setting Options	
D.EFFECT SETUP	D.E.SELECT	Off , FADER, EFFECT, MULTI-S	53
	FADER TYPE	FADE-T , WIPE, CORNER, JUMP, FLIP, PUZZLE, ZIGZAG, BEAM, TIDE	
	EFFECT TYPE	ART , BLACK&WHITE, SEPIA, MOSAIC, BALL, CUBE, WAVE, COLOR MASK, MIRROR	
	M.S.SPEED	MANUAL, FAST, MODERATE , SLOW	
	M.S.SPLIT	4 , 9, 16	
CAMERA SETUP	SHUTTER	AUTO , 1/60, 1/100, 1/250, 1/500, 1/1000, 1/2000	48
	A.SL SHUTTER	ON , OFF	49
	D.ZOOM	OFF , 80X, 400X	27
	IMG STAB 	ON , OFF	66
	WHITE BAL.	AUTO , SET  , INDOOR  , OUTDOOR 	46
	SELF TIMER	ON  , OFF	50
	SKIN DETAIL	SOFT, NORMAL	42
VCR SETUP	REC MODE	SP , LP	51
AUDIO SETUP	WIND SCREEN	AUTO , OFF	52
	AUDIO MODE	16bit, 12bit	52
DISPLAY SETUP/ 	BRIGHTNESS		65
	LCD MIRROR	ON , OFF	23
	TV SCREEN	ON , OFF	75
	D/T DISPLAY	ON, OFF	21
	LANGUAGE 	See list of languages.	64
	DATE FORMAT		64
	DEMO MODE	ON , OFF	66

Submenu	Menu Item	Setting Options	<input type="checkbox"/>
SYSTEM	BEEP	ON, OFF	65
	T.ZONE/DST	See list of time zones.	19
	D/TIME SET		19
MY CAMERA	START-UP IMG	ON, OFF	63
	S-UP SOUND	OFF, PATTERN1 , PATTERN2	63
	OPER.SOUND		
	SELF-T SOUND		

PLAY (VCR) MENU

CAMERA

PLAY (VCR)

E

Submenu	Menu Item	Setting Options	□
D.EFFECT SETUP	D.E.SELECT	Off , FADER, EFFECT, MULTI-S	53
	FADER TYPE	FADE-T , WIPE, CORNER, JUMP, FLIP, PUZZLE, ZIGZAG, BEAM, TIDE	
	EFFECT TYPE	ART , BLACK&WHITE, SEPIA, MOSAIC, BALL, CUBE, WAVE, COLOR MASK, MIRROR	
	M.S.SPEED	MANUAL, FAST, MODERATE , SLOW	
	M.S.SPLIT	4 , 9, 16	
VCR SETUP	REC MODE	SP , LP	51
	AV → DV	ON, OFF	72
AUDIO SETUP	OUTPUT CH	L/R , L/L, R/R	33
	AUDIO MODE	16bit, 12bit	52
	12bit AUDIO	STEREO1 , STEREO2, MIX/FIXED, MIX/VARI.	62
	MIX BALANCE		62
DISPLAY SETUP/ ☺	BRIGHTNESS		65
	TV SCREEN	ON, OFF	75
	DISPLAYS	ON , OFF <PLAYBK>	75
	6SEC.DATE	ON, OFF	60
	DATA CODE	DATE/TIME , CAMERA DATA, CAM.& D/T	59
	D/TIME SEL.	DATE, TIME, DATE & TIME	59
	LANGUAGE ☺	See list of languages.	64
	DATE FORMAT		64
SYSTEM	BEEP	ON , OFF	65
	T.ZONE/DST	See list of time zones.	19
	D/TIME SET		19
MY CAMERA	START-UP IMG	ON , OFF	63
	S-UP SOUND	OFF, PATTERN1 , PATTERN2	63
	OPER.SOUND		
	SELF-T SOUND		

Advanced Functions

Using the Recording Programs

Easy Recording Program

The camcorder adjusts focus, exposure and other settings automatically, allowing you to just point and shoot.



Program AE Modes

Auto

The camcorder adjusts focus, exposure and other settings automatically. However, you have the option of adjusting the settings manually.



Sports

Use this mode to record sports scenes (such as tennis or golf) or moving objects (such as roller coasters).



Portrait

Use this mode to give accent to your subject by blurring the background or foreground. The blur effect increases the more you zoom to telephoto.



Spotlight

Use this mode to record spotlit scenes or fireworks.



Sand & Snow

Use this mode in bright places such as a sunny beach or ski resort. It prevents the subject from being underexposed.



Low Light

Use this mode to record in dimly lit places.



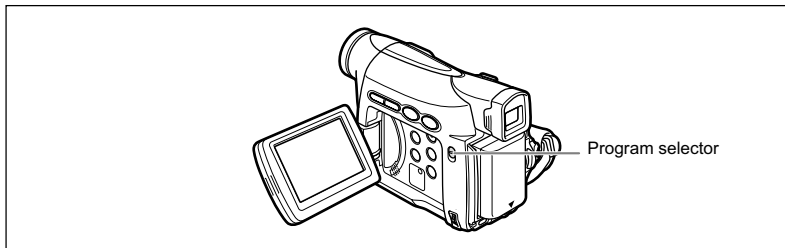

Program selector

Availability of Functions in Each Mode:

Recording Program	<input type="checkbox"/>	A					
Image Stabilizer	× (on)						○
Focus	× (A)						○
White Balance	× (A)						○
Wind screen	× (A)						○
Shutter Speed	× (A)	○					× (A)
AE Shift	×		○			×	○
Digital Effects	×						○

○: Available ×: Not available A: Auto setting

Selecting the Easy Recording Program

CAMERA

PLAY (VCR)

Set the program selector to **EASY**.

“ EASY” appears.

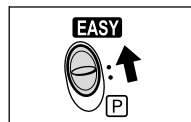

Selecting the Program AE Mode

CAMERA

PLAY (VCR)

1. Set the program selector to **P**.

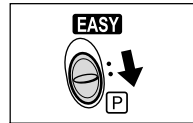

2. Press the **SET** dial.

A list of the program AE modes appears.

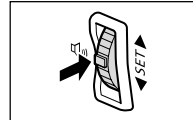

3. Select a mode and press the **SET** dial.

The symbol of the mode appears on the upper left corner of the screen.

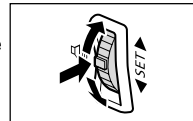

- The setting resets to the Auto mode when you change the position of the program selector.
- Do not change the mode during recording as the brightness of the image may change abruptly.
- Sports/Portrait mode:
 - The picture may not appear smooth when played back.
- Sand & Snow mode:
 - The subject may become overexposed in dark surroundings. Check the image on the screen.
 - The picture may not appear smooth when played back.
- Low Light mode:
 - Moving subjects may leave a trailing afterimage.
 - Picture quality may not be as good as in other modes.
 - The camcorder may have difficulty to focus automatically.

Using the Night Mode

Allows you to record in dark places where lights cannot be used, without sacrificing color.

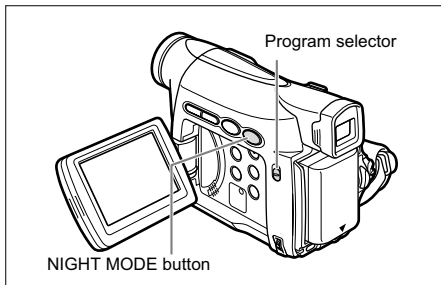

Night Mode

E

1. Set the program selector to **P**.

2. Press the NIGHT MODE button.

- “” appears.
- Pressing the NIGHT MODE button again resets the camcorder to the Auto mode.



- Moving subjects may leave a trailing afterimage.
- Picture quality may not be as good as in other modes.
- White points may appear on the screen.
- Autofocus may not work as well as in other modes. In such case, adjust the focus manually.
- Digital zoom and multi-image screen cannot be used while a night mode is activated.
- The program AE mode cannot be changed while a night mode is activated.

Skin Detail Function

When shooting close-ups of people, the camcorder automatically softens details to reduce the appearance of skin imperfections for a more complimentary appearance.

CAMERA

PLAY (VCR)

MENU

( 34)

CAMERA SETUP



SKIN DETAIL • • NORMAL

Open the menu and select **[CAMERA SETUP]**. Select **[SKIN DETAIL]**, set it to **[SOFT]** and close the menu.



- Skin detail function cannot be used when the program selector is set to EASY.
- [SKIN DETAIL] resets to [NORMAL] when you change the position of the POWER switch or the program selector.
- To obtain the best effect, use this function when recording a person in close-up. Note that areas similar to the skin color may lack in detail.

Adjusting the AE Shift

You can adjust the AE (auto exposure) function to lighten or darken the image. This allows you to compensate for backlit or overexposed scenes. Available Levels: -2 to +2, in 0.25 intervals (excluding -1.75 and +1.75).

E

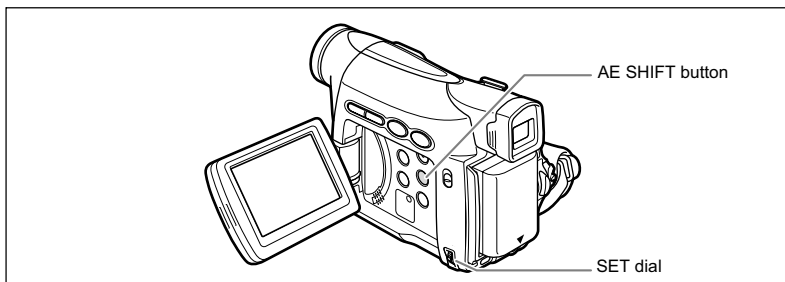

CAMERA

PLAY (VCR)

1. Set the program selector to **P**.

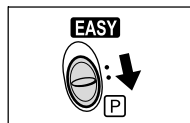

2. Set the program AE mode to a mode other than the Easy Recording, Spotlight or Sand & Snow mode.

3. Press the AE SHIFT button.

"AE ±0" appears in light blue.

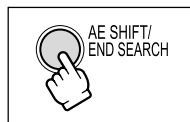

4. Turn the SET dial to adjust the AE shift level.

- Turn the SET dial up to lighten the image, and down to darken the image.
- If "MF" is displayed in light blue, AE shift cannot be adjusted. Press the AE SHIFT button again to display "AE ±0" in light blue.

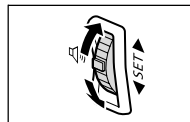

The camcorder retains the setting even if you turn it off or change the program AE mode.

Adjusting the Focus Manually

Autofocus may not work well on the following subjects. In such case, focus manually.

Reflective surfaces



Subjects with low contrast or without vertical lines

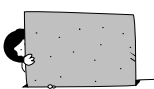

Fast Moving Subjects



Through dirty or wet windows



Night Scenes

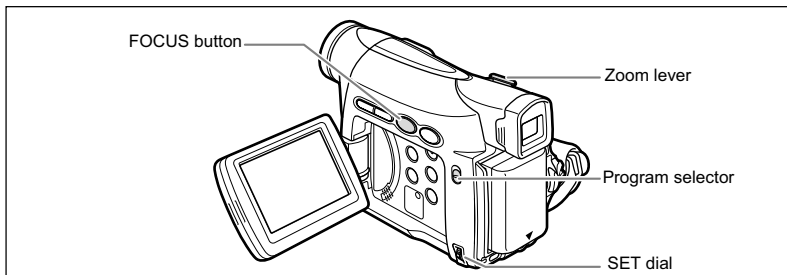

CAMERA

PLAY (VCR)

1. Set the program selector to **P**.

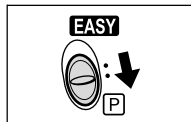

2. Adjust the zoom.

When you operate the zoom after adjusting the focus, the subject may not stay in focus. Adjust the zoom before the focus.

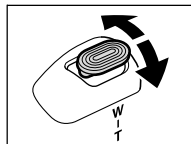

3. Press the **FOCUS** button.

"MF" appears.



4. Turn the **SET** dial to adjust the focus.

- Turn the SET dial up or down until the image appears focused.
- Press the FOCUS button to return to autofocus.

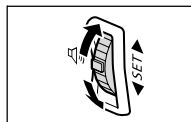

- The setting resets to autofocus when you switch the program selector to EASY.
- Readjust the focus when you have turned off the camcorder.

Infinity Focus

Use this function when you wish to focus on faraway subjects such as mountains or fireworks.

Press the FOCUS button more than 2 seconds after step 2 in *Adjusting the Focus Manually*.

“MF ∞” appears.





When you operate the zoom or turn the SET dial, “∞” disappears and the camcorder changes to manual focus.

E

Setting the White Balance

You can use the preset modes to reproduce colors more accurately, or set a custom white balance to obtain the optimal setting.

AUTO	Auto white balance
SET 	Use the custom white balance setting to make white subjects appear white under colored lighting.
INDOOR 	Use this mode for recording under changing lighting condition, video lights or sodium lamps.
OUTDOOR 	Use this mode for recording night scenes, fireworks, sunrise or sunset.

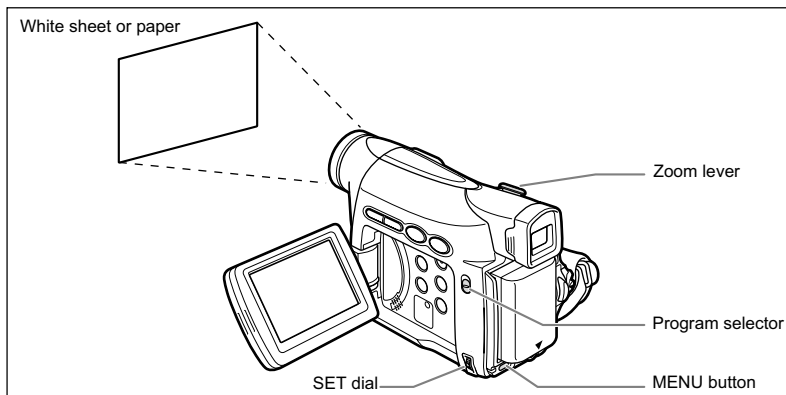



CAMERA

PLAY (VCR)

MENU
( 34)

CAMERA SETUP

WHITE BAL. . . . AUTO

1. Set the program selector to .
2. For custom white balance: Point the camcorder at a white object and zoom in until it fills the whole screen.
Keep the camcorder zoomed at the white object until step 3 is completed.
3. Open the menu and select [CAMERA SETUP]. Select [WHITE BAL.], select a setting option and close the menu.
When you have selected [SET ]: "" flashes and stops flashing when settings is complete.



- Use the auto setting for normal outdoor scenes.
- When the program selector is set to EASY, white balance is preset to [AUTO].
- The camcorder retains the custom white balance setting even if you turn it off.
- When you have set the custom white balance:
 - Depending on the light source, “” may keep flashing. The result will still be better than with the auto setting.
 - Reset the white balance when the lighting condition changes.
 - Turn off the digital zoom.
- Custom white balance may provide better results in the following cases:
 - Changing lighting conditions
 - Close-ups
 - Subjects in a single color (sky, sea or forest)
 - Under mercury lamps or certain types of fluorescent lights

E

Setting the Shutter Speed

You can adjust the shutter speed manually to make stable shots of fast moving subjects. Select from AUTO, 1/60, 1/100, 1/250, 1/500, 1/1000, 1/2000.

CAMERA

PLAY (VCR)

MENU

( 34)

CAMERA SETUP

SHUTTER.....AUTO

1. Set the program selector to **P**.
2. Set the program AE mode to the **A** (Auto) mode.
3. Open the menu and select [CAMERA SETUP].
4. Select [SHUTTER].
5. Select the shutter speed and press the SET dial.
6. Close the menu.



- Do not point the camcorder directly at the sun when the shutter speed is set to 1/1000 or higher.
- The image may flicker when recording with high shutter speeds.
- Recording under fluorescent lights: In Easy Recording, Auto or Night mode, the camcorder automatically detects the flicker of fluorescent lighting and adjusts the shutter speed accordingly. However, if the screen starts to flicker, select AUTO mode and set the shutter speed to 1/100.
- The setting resets to the auto setting when you switch the program selector to EASY, or change the program AE mode.
- Guidelines for Recording with High Shutter Speeds:
 - Outdoor sports such as golf or tennis: 1/2000
 - Moving objects such as cars or roller coasters: 1/1000, 1/500 or 1/250
 - Indoor sports such as basketball: 1/100

Auto Slow Shutter

In Easy Recording mode and when [SHUTTER] is set to [AUTO] in Auto mode, the camcorder uses shutter speeds down to 1/30. This allows you to record brightly in places with insufficient lighting. However, you can set the camcorder not to use a slow shutter speed.

E

CAMERA

PLAY (VCR)

MENU

( 34)

CAMERA SETUP

A.SL SHUTTER·ON

Open the menu and select [CAMERA SETUP]. Select [A.SL SHUTTER], set it to [OFF] and close the menu.



When set to [ON], moving subjects may leave a trailing afterimage.

Using the Self-Timer

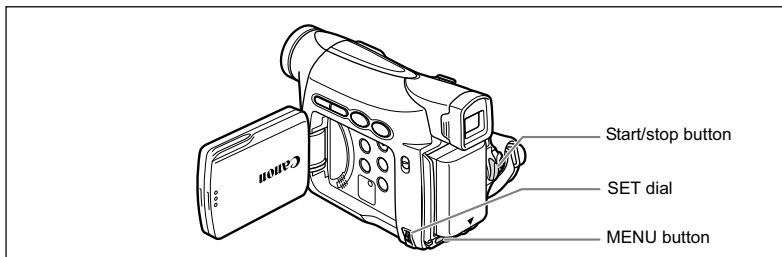

CAMERA

PLAY (VCR)

MENU

(34)

CAMERA SETUP

▶ SELF TIMER...OFF

1. Open the menu and select [CAMERA SETUP]. Select [SELF TIMER], set it to [ON] and close the menu.

"" appears.

2. Press the start/stop button.

The camcorder starts recording after a 10-second countdown. The count down appears on the screen.



- To cancel the self-timer, set [SELF TIMER] to [OFF]. Once the countdown has begun, you can also press the start/stop button to cancel the self-timer.
- The self-timer will be canceled when you turn off the camcorder.

Changing the Recording Mode (SP/LP)

You can choose between SP (standard play) and LP (long play). LP extends the tape usage by 1.5 times.

E

CAMERA

PLAY (VCR)

MENU

( 34)

VCR SETUP



REC MODE.....SP

To change to LP mode, open the menu and select [VCR SETUP]. Select [REC MODE], set it to [LP] and close the menu.



Depending on the nature and usage condition of the tape, picture and sound recorded in LP mode may be distorted. We recommend using the SP mode for important recordings.



- If you record in both SP and LP modes on the same tape, the playback picture may become distorted and the time code may not be written correctly.
- If you play back a tape that has been recorded in LP mode with another digital device on this camcorder, or vice versa, picture and sound may become distorted.

Audio Recording

Changing the Audio Mode

You can record sound in two audio modes—16-bit and 12-bit. The 12-bit mode records sound on two channels (stereo 1), leaving 2 channels free (stereo 2) for adding new sound later with another editing device. Select the 16-bit mode for higher sound quality.

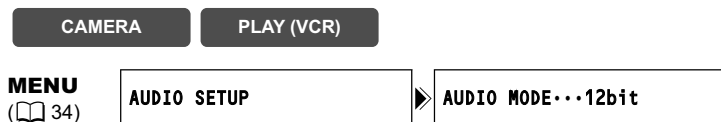

Open the menu and select [AUDIO SETUP]. Select [AUDIO MODE], set it to [16bit] and close the menu.

“16bit” appears for approximately 4 seconds.

Wind Screen

The camcorder reduces wind noise automatically. However, you can turn off the wind screen when recording indoors, or when you want the microphone to be as sensitive as possible.



Open the menu and select [AUDIO SETUP]. Select [WIND SCREEN], set it to [OFF] and close the menu.





“WS  ” appears when you turn the wind screen off.

Using Digital Effects

Faders (☐ 55)

Begin or end scenes with a fade to or from black.



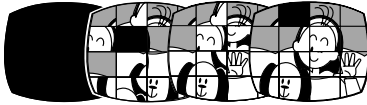
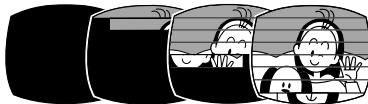
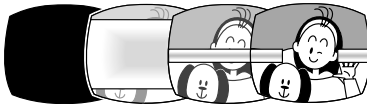
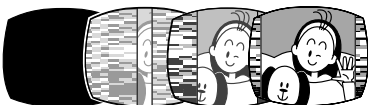





E

Fade Trigger (FADE-T) 	Wipe (WIPE) 
Corner Wipe (CORNER) 	Jump (JUMP) 
Flip (FLIP) 	Puzzle (PUZZLE) 
Zigzag (ZIGZAG) 	Beam (BEAM) 
Tide (TIDE) 	

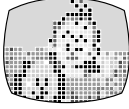
Advanced Functions
Recording

Effects (📖 55)

Add flavor to your recordings.

<p>Art (ART)</p> 	<p>Black and White (BLACK&WHITE)</p> 	<p>Sepia (SEPIA)</p> 
<p>Mosaic (MOSAIC)</p> 	<p>Ball (BALL)</p> 	<p>Cube (CUBE)</p> 
<p>Wave (WAVE)</p> 	<p>Color Mask (COLOR MASK)</p> 	<p>Mirror (MIRROR)</p> 

Multi-Image Screen (📖 56)

Captures moving subjects in 4, 9 or 16 sequences of still images and displays them at one time. Sound will be recorded normally.

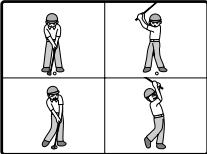
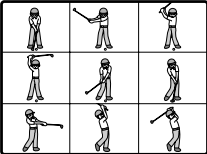
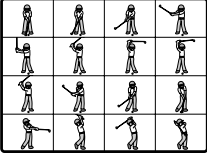
<p>4 Sequences</p> 	<p>9 Sequences</p> 	<p>16 Sequences</p> 
--	--	---

Selecting a Fader

In CAMERA mode, set the program selector to .

CAMERA

PLAY (VCR)

E

1. Open the menu and select [D.EFFECT SETUP].
2. Select [D.E.SELECT] and set it to [FADER].
3. Select [FADER TYPE], select a setting option and close the menu.

The name of the selected fader flashes.

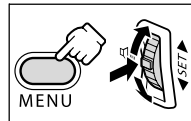

CAMERA mode:

4. **Fade in:** In record pause mode, press the DIGITAL EFFECTS ON/OFF button and begin recording by pressing the start/stop button.
Fade out: During recording, press the DIGITAL EFFECTS ON/OFF button and pause recording by pressing the start/stop button.

The fader can be activated/deactivated by pressing the DIGITAL EFFECTS ON/OFF button.



PLAY (VCR) mode:

4. **Fade in:** In playback pause mode, press the DIGITAL EFFECTS ON/OFF button and begin playback by pressing the ►/II button.
Fade out: During playback, press the DIGITAL EFFECTS ON/OFF button and pause playback by pressing the ►/II button.

The fader can be activated/deactivated by pressing the DIGITAL EFFECTS ON/OFF button.



Advanced Functions
Recording

Selecting an Effect

In CAMERA mode, set the program selector to .

CAMERA

PLAY (VCR)

1. Open the menu and select [D.EFFECT SETUP].
2. Select [D.E.SELECT] and set it to [EFFECT].
3. Select [EFFECT TYPE], select a setting option and close the menu.

The name of the selected effect flashes.

4. Press the DIGITAL EFFECTS ON/OFF button.

- The name of the selected effect stops flashing.
- The effect can be activated/deactivated by pressing the DIGITAL EFFECTS ON/OFF button.

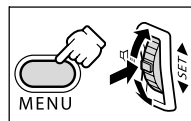

Using the Multi-Image Screen

You can operate the multi-image screen only in the following playback modes:

- When [M.S.SPEED] is set to [MANUAL]: Playback pause, slow forward/reverse playback
- When [M.S.SPEED] is set to [FAST], [MODERATE] or [SLOW]: Playback pause

In CAMERA mode, set the program selector to .

CAMERA

PLAY (VCR)

1. Open the menu and select [D.EFFECT SETUP].
2. Select [D.E.SELECT] and set it to [MULTI-S].
3. Select [M.S.SPEED] and select the transition speed.

Following transition speeds can be selected: fast (every 4 frames), moderate (every 6 frames*), slow (every 8 frames*).

* In Low Light mode: moderate (every 8 frames), slow (every 12 frames).

4. Select [M.S.SPLIT], select the number of sequences and close the menu.

"MULTI-S" flashes.

5. Press the DIGITAL EFFECTS ON/OFF button.

- MANUAL: Images will be captured each time you press the DIGITAL EFFECTS ON/OFF button. The blue frame indicating the next sequence disappears after the last image. Pressing the DIGITAL EFFECTS ON/OFF button for more than 1 second cancels the images one after another.

- FAST, MODERATE, SLOW: The set number of images will be captured at the set speed. To cancel the multi-image screen, press the DIGITAL EFFECTS ON/OFF button.

6. Press the start/stop button to begin recording.

The multi-image screen is recorded on the tape.

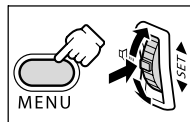

- Turn off the digital effect when you do not use it.
- The camcorder retains the setting even if you turn it off or change the program AE mode.
- The image quality may be slightly lower with digital effects.
- Digital effects cannot be used in the following cases:
 - When the program selector is set to EASY.
 - During DV dubbing.

About the multi-image screen:

- The multi-image screen cannot be used in the following cases:
 - In the Night mode.
 - When the widescreen mode is selected.
- In PLAY (VCR) mode: Pressing any tape operation button (such as play or pause) cancels the multi-image screen.

Widescreen TV Recording (16:9)

The camcorder uses the full width of the CCD providing high-resolution 16:9 recording.

E

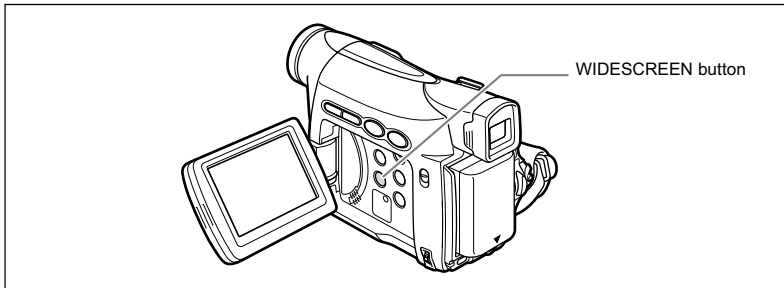

CAMERA

PLAY (VCR)

Press the WIDESCREEN button.

- "WIDE" appears.
- The LCD screen switches to the "letterbox" display. The picture on the viewfinder appears horizontally squeezed.



- The multi-image screen cannot be used when the widescreen mode is selected.
- If you play back a widescreen recording on a normal TV, the image appears horizontally squeezed.
- If you connect the camcorder to a TV with Video ID-1 system, recordings made in the widescreen mode will be automatically played back in widescreen mode.

Advanced Functions
Recording

Magnifying the Image

The playback image can be magnified up to 5 times.

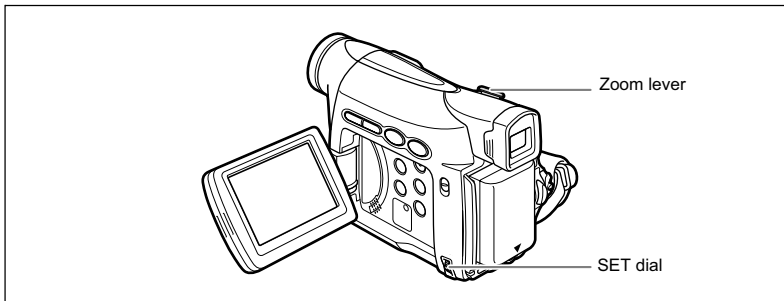

CAMERA

PLAY (VCR)

1. Move the zoom lever toward **T**.

- The image is magnified by 2 times.
- A frame appears indicating the position of the magnified area.
- To further enlarge the image, move the zoom lever toward **T**. To shrink the image below 2 times magnification, move the zoom lever toward **W**.

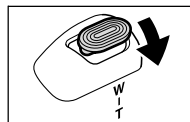

2. Select the magnified area with the SET dial.

- Turn the SET dial to move the image to the right and left, or up and down. Pressing the SET dial switches between the directions.
- To cancel the magnification, move the zoom lever toward **W** until the frame disappears.

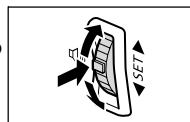

Displaying the Data Code

The camcorder maintains a data code containing recording date and time and other camera data such as shutter speed and exposure (f-stop). When you play back a tape, you can display the data code and select the data code combination you wish to display.

E

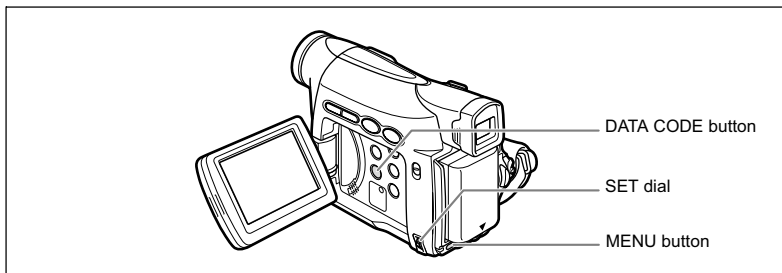

Selecting the Date/Time Display Combination

CAMERA

PLAY (VCR)

MENU
(34)

DISPLAY SETUP/

D/TIME SEL. . . DATE & TIME

Open the menu and select [DISPLAY SETUP/]. Select [D/TIME SEL.], set it to [DATE] or [TIME] and close the menu.

Selecting the Data Code Display Combination

CAMERA

PLAY (VCR)

MENU
(34)

DISPLAY SETUP/

DATA CODE DATE/TIME

Open the menu and select [DISPLAY SETUP/]. Select [DATA CODE], set it to [CAMERA DATA] or [CAM. & D/T] and close the menu.

Displaying the Data Code

CAMERA

PLAY (VCR)

Press the **DATA CODE** button.



The data code will not display the next time you turn on the camcorder.

Six-Second Auto Date

Date and time appear for 6 seconds when you begin playback, or to indicate that date or time zone has changed.

CAMERA

PLAY (VCR)

MENU

(34)

DISPLAY SETUP/

▶ 6SEC.DATE...OFF

Open the menu and select **[DISPLAY SETUP/**]. Select **[6SEC.DATE]**, set it to **[ON]** and close the menu.

End Search

When you have played back a tape, you can use this function to locate the end of the last recorded scene.

E

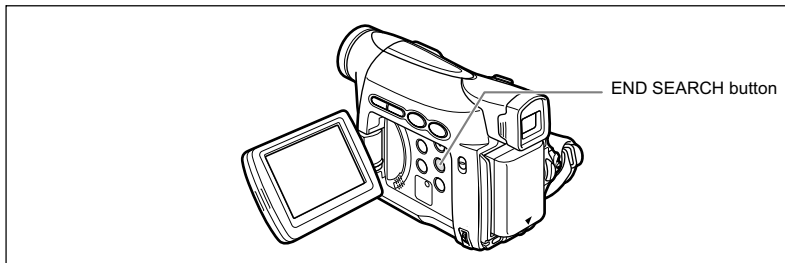

CAMERA

PLAY (VCR)

In stop mode, press the END SEARCH button.

- “END SEARCH” appears.
- The camcorder rewinds/fast forwards the tape, plays back the last few seconds of the recording and stops the tape.
- Pressing the button again cancels the search.



- End search cannot be used once you unload the cassette.
- End search may not work properly if a blank section exists on the tape.

Advanced Functions
Playback

Playing Back a Tape with Added Sound

You can select to play back Stereo 1 (original sound), Stereo 2 (added sound), or adjust the balance of both sounds.

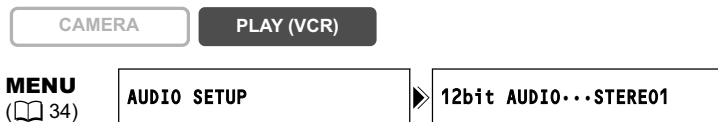

- 1. Open the menu and select [AUDIO SETUP]. Select [12bit AUDIO], select a setting and close the menu.**
 - STEREO1: Plays back the original sound.
 - STEREO2: Plays back the added sound.
 - MIX/FIXED: Plays back Stereo 1 and Stereo 2 in the same level.
 - MIX/VARI.: Plays back Stereo 1 and Stereo 2. The mix balance can be adjusted.
- 2. If you have selected [MIX/VARI.], adjust the mix level: Open the menu and select [AUDIO SETUP]. Select [MIX BALANCE], adjust the balance with the SET dial and close the menu.**

Turn the SET dial down to increase the volume of Stereo 1 and up to increase the volume of Stereo 2.



- The camcorder resets to [STEREO1] when you turn the camcorder off. However, the mix balance is memorized by the camcorder.
- Audio dubbing cannot be performed with your camcorder.

Customizing the Camcorder

You can personalize your camcorder by customizing the start-up image and the sound it makes for start-up, operation and self-timer (collectively called the My Camera settings).

E

Changing the My Camera Settings

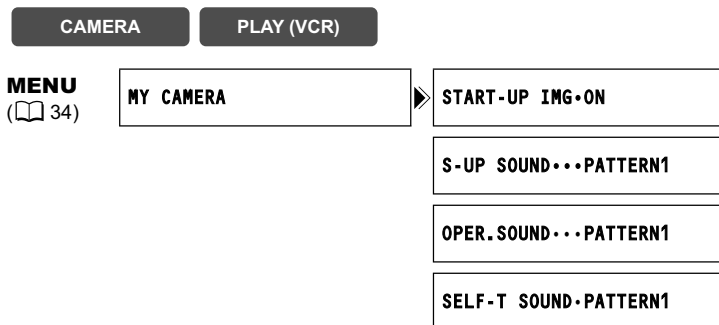

1. Open the menu and select [MY CAMERA].
2. Select the menu item you wish to change.
3. Select a setting option and close the menu.

Changing the Display Language

The language used for screen display and menu items can be changed. The available set of languages varies depending on the region. Follow the procedure below to check which set of languages are provided with your camcorder.

Language Set A (e.g. USA, Canada)	Language Set B (e.g. Asia)
English, German, Spanish, French, Italian, Russian, Simplified Chinese, Japanese	English, Simplified Chinese, Traditional Chinese, Korean

CAMERA



PLAY (VCR)

MENU

( 34)

DISPLAY SETUP/ 

▶ LANGUAGE  ··· ENGLISH

To change the display language, open the menu and select [DISPLAY SETUP/ ]. Select [LANGUAGE ], select a language and close the menu.



- If you have mistakenly changed the language, follow the  mark next to the menu item to change the setting.
- The displays “MENU” and “SET” at the bottom of the screen refer to the button names on the camcorder and will not change when you change the language.

Changing the Date Format

You can select between three date formats. For example, [JAN. 1, 2005], [1. JAN. 2005] and [2005. 1. 1].

CAMERA

PLAY (VCR)

MENU

( 34)

DISPLAY SETUP/ 

▶ DATE FORMAT ··· JAN. 1, 2005

Open the menu and select [DISPLAY SETUP/ ]. Select [DATE FORMAT], select a format and close the menu.

Other Camcorder Settings

E

Beep

You will hear a beep upon camcorder operations such as power on/off, start/stop, self-timer countdown, and unusual conditions of the camcorder.

If you turn off the beep, all camcorder sounds including the ones of the My Camera settings will be turned off.

CAMERA

PLAY (VCR)

MENU

( 34)

SYSTEM

▶ BEEP.....ON

To turn the beep off, open the menu and select [SYSTEM]. Select [BEEP], set it to [OFF] and close the menu.

Adjusting the Brightness of the LCD Screen

CAMERA

PLAY (VCR)

MENU

( 34)

DISPLAY SETUP/ 

▶ BRIGHTNESS...  +

Open the menu and select [DISPLAY SETUP/ ]. Select [BRIGHTNESS], adjust the brightness level and close the menu.



Changing the brightness of the LCD screen does not affect that of the viewfinder or the recordings.

Turning Off the Image Stabilizer

The image stabilizer compensates for camcorder shake even at full telephoto. It tries to compensate for horizontal movements; therefore, you may decide to turn it off when you mount the camcorder on a tripod.



Open the menu and select [CAMERA SETUP]. Select [IMG STAB((📵))], set it to [OFF] and close the menu.

"((📵))" disappears.



- The image stabilizer cannot be turned off when the program selector is set to EASY.
- The image stabilizer is designed to compensate a normal degree of camcorder shake.
- The image stabilizer might not be as effective when using the Night mode.

Demonstration Mode

The demonstration mode displays the camcorder's main features. It starts automatically when you leave the camcorder turned on without loading a recording media for more than 5 minutes. However, you can set the camcorder not to start the demonstration mode.



Open the menu and select [DISPLAY SETUP/(🗨️)]. Select [DEMO MODE], set it to [OFF] and close the menu.



To cancel the demo mode once it has begun, press any button, turn off the camcorder or load a recording media.

Recording to a VCR or Digital Video Device

E

You can copy your recordings by connecting the camcorder to a VCR or a digital video device. If you connect a digital video device, you can copy recordings with virtually no generation loss in image and sound quality.

Connecting the Devices

① Connecting a VCR

See *Playing Back on a TV Screen* (□ 32).

② Connecting a Digital Video Device

Refer also to the instruction manual of the digital video device.

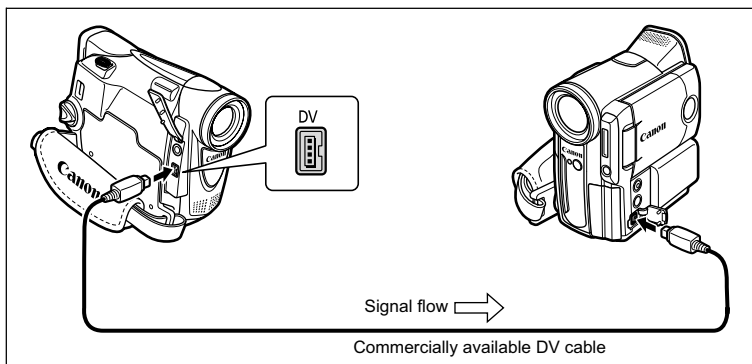

Editing

Recording

CAMERA

PLAY (VCR)

1. Set the camcorder to **PLAY (VCR)** mode and load a recorded cassette.
2. **Connected device:** Load a blank cassette and set the device to record pause mode.
3. Locate the scene you wish to copy and pause playback shortly before the scene.
4. Play back the tape.
5. **Connected device:** Begin recording when the scene you wish to copy appears. Stop recording when copying is complete.
6. Stop playback.



- When connecting a VCR, the quality of the edited tape will be slightly lower than that of the original.
- When connecting a digital video device:
 - If the picture does not appear, reconnect the DV cable or turn the camcorder off and back on again.
 - Proper operation cannot be guaranteed for all digital video devices equipped with a DV terminal. If operation does not work, use the AV terminal.
- We recommend powering the camcorder from a household power source.

Recording from Analog Video Devices (VCR, TV or Camcorder)

E

You can record videos or TV programs from a VCR or analog camcorder on the tape in the camcorder.

CAMERA

PLAY (VCR)

1. Connect the camcorder to the analog video device.

See *Playing Back on a TV Screen* (□□ 32).

2. Set the camcorder to PLAY (VCR) mode and load a blank cassette.

3. Connected device: Load the recorded cassette.

4. Press the REC PAUSE button.

In record pause mode and during recording, you can check the picture on the screen.



5. Connected device: Play back the tape.

6. Press the ►/|| button when the scene you wish to record appears.

Recording starts.

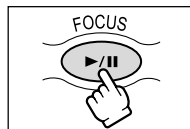

7. Press the ■ button to stop recording.

- Press the ►/|| button to pause recording.
- Press the ►/|| button again to restart recording.



8. Connected device: Stop playback.



Depending on the signal sent from the connected device, dubbing may not work properly (e.g. signals that include copyright protective signals or anomalous signals such as ghost signals).



We recommend powering the camcorder from a household power source.

Editing

Recording from Digital Video Devices (DV Dubbing)

You can record from other digital video devices equipped with a DV terminal with virtually no loss in picture and sound quality.

CAMERA

PLAY (VCR)

1. Connect the camcorder to the digital video device.

See *Connecting a Digital Video Device* (□□ 67).

2. Set the camcorder to PLAY (VCR) mode and load a blank cassette.

Make sure that [AV → DV] is set to [OFF] (□□ 72).

3. Connected device: Load the recorded cassette.

4. Press the REC PAUSE button.

In record pause mode and during recording, you can check the picture on the screen.



5. Connected Device: Play back the tape.

6. Press the ►/|| button when the scene you wish to record appears.

Recording starts.



7. Press the ■ button to stop recording.

- Press the ►/|| button to pause recording.
- Press the ►/|| button again to restart recording.



8. Connected Device: Stop playback.



- Blank sections may be recorded as anomalous picture.
- If the picture does not appear, reconnect the DV cable or turn the camcorder off and back on again.
- You can only record signals from devices with the **DV** logo recording in SD system in SP or LP format (note that signals from identically shaped terminals may be of different format).



We recommend powering the camcorder from a household power source.

Copyright Signal

Certain software tapes are copyright protected. If you attempt to play back such tape, "COPYRIGHT PROTECTED PLAYBACK IS RESTRICTED" appears and you will not be able to view the contents of the tape. If you attempt to record from such tape via the DV terminal, "COPYRIGHT PROTECTED DUBBING RESTRICTED" appears and you will not be able to record the contents of the tape.

E

Editing

Converting Analog Signals into Digital Signals (Analog-Digital Converter)

By connecting the camcorder to a VCR or 8mm video camcorder, you can convert analog video/audio signals to digital signals and output the digital signals via the DV terminal. The DV terminal serves as output terminal only.

Connecting the Devices

Turn off all devices before starting the connections. Unload the tape from the camcorder. Refer also to the instruction manual of the connected device.

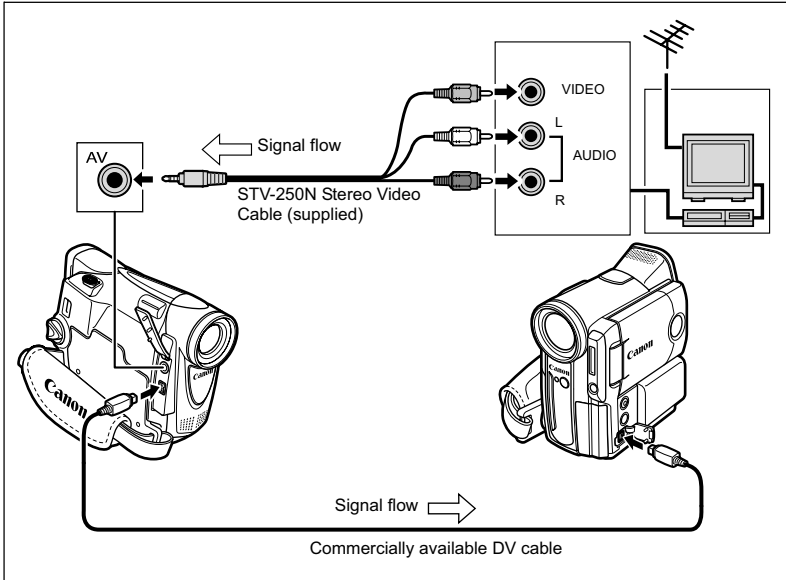

Turning On the Analog-Digital Converter

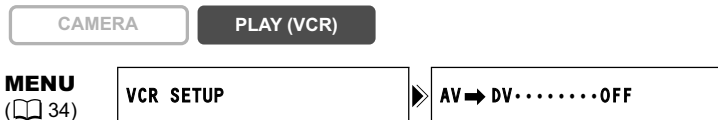

Open the menu and select [VCR SETUP]. Select [AV → DV], set it to [ON] and close the menu.



- Depending on the signal sent from the connected device, the conversion from analog to digital signals might not work properly (e.g., signals that include copyright protective signals or anomalous signals such as ghost signals).
- For normal use, set [AV → DV] to [OFF]. If it is set to [ON], digital signals cannot be input via the camcorder's DV terminal.
- Depending on the software and the specifications of your computer, you may not be able to transfer converted signals via the DV terminal.

E



We recommend powering the camcorder from a household power source.

Transferring Video Recordings to a Computer

Transferring Using a DV Cable

You can transfer recordings to a computer equipped with a IEEE1394 (DV) terminal or IEEE1394 capture board. Use the editing software supplied with your computer/capture board to transfer video recording from tape to computer. Refer to the instruction manual of the software. A driver is preinstalled on Windows operating systems later than Windows 98 Second Edition and Mac operating systems later than Mac OS 9, and will be installed automatically.

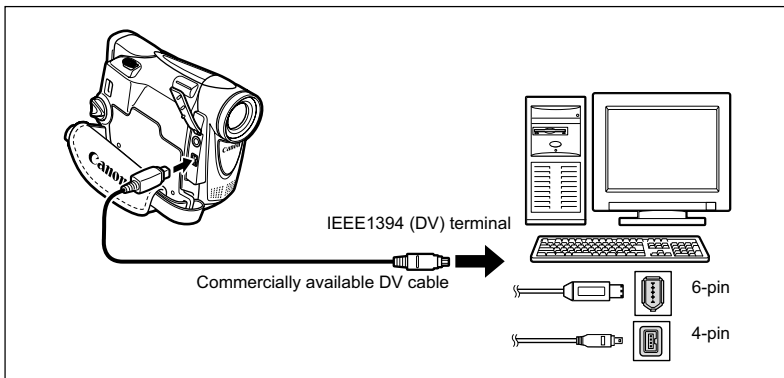

- Operation may not work correctly depending on the software and the specifications/settings of your computer.
- If the computer freezes while you have connected the camcorder, disconnect and reconnect the DV cable. If the problem persists, disconnect the interface cable, turn off camcorder and computer, turn camcorder and computer back on and reconnect them.



- We recommend powering the camcorder from a household power source while it is connected to the computer.
- Refer also to the instruction manual of the computer.
- Users of Windows XP can download the DV Messenger software from below homepage. With DV Messenger, you can perform a videoconference using your camcorder. For details, refer to the *DV Network Software Instruction Manual* supplied with the software.
www.canondv.com
www.canon.ca
www.canon-asia.com

Screen Displays

E

Hiding the Displays on the LCD Screen

You can hide the displays on the LCD screen to have a clear screen for playback.

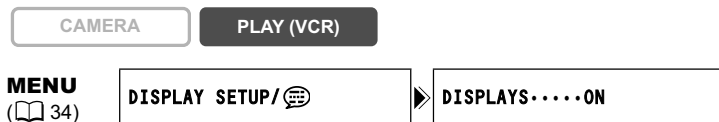

Open the menu and select [DISPLAY SETUP/ [speech bubble icon]]. Select [DISPLAYS], set it to [OFF <PLAYBK>] and close the menu.

- Warning messages still appear, and the data code appears if turned on.
- The displays appear while a playback image is magnified or a digital effect is activated.
- Tape operation displays appear for 2 seconds.

Hiding/Showing the Displays on the TV Screen

When you connect a TV for recording, you can select to hide the camcorder displays on the TV screen. For playback, you can show the camcorder displays on the TV screen.



Open the menu and select [DISPLAY SETUP/ [speech bubble icon]]. Select [TV SCREEN], set it to [OFF] and close the menu.

The displays disappear from the TV screen.

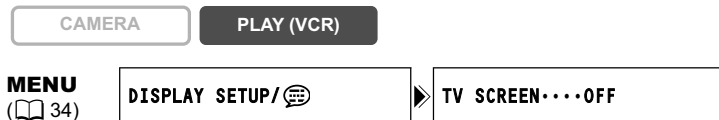

Open the menu and select [DISPLAY SETUP/ [speech bubble icon]]. Select [TV SCREEN], set it to [ON] and close the menu.

The displays appear on the TV screen.

Screen Displays during Recording/Playback

CAMERA Mode (see also 24)

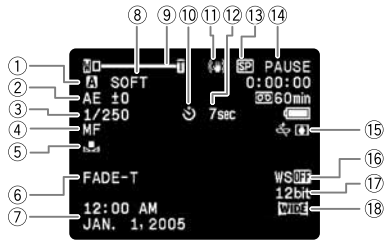

- ① Program AE (38)
- ② AE Shift (43)
- ③ Shutter speed (48)
- ④ Manual focus (44)

- ⑤ White balance (46)
- ⑥ Digital effects (53)
- ⑦ Date and time (19)
- ⑧ Skin detail (42)
- ⑨ Zoom (26)
- ⑩ Self-timer (50)
- ⑪ Image stabilizer (66)
- ⑫ Self-timer countdown (50)
- ⑬ Recording mode (51)
- ⑭ Tape operation
- ⑮ Condensation warning (79)
- ⑯ Wind screen (52)
- ⑰ Audio mode (52)
- ⑱ Widescreen mode (57)

PLAY (VCR) Mode



- ① MIX/VARI.
- ② END SEARCH
- ③ F1.8
1/250
12:00 AM
JAN. 1, 2005
- ④
- ⑤ REC
PAUSE
STOP
EJECT
▶
FF ▶▶
◀◀ REW

- ① 12 bit audio (62)
- ② End search (61)
- ③ Data code (59)
- ④ Volume level of speaker (31)

- ▶▶/◀◀: Fast forward playback/rewind playback (30)
- ▶||: Playback pause (30)

List of Messages

Message	Explanation	
SET THE TIME ZONE, DATE AND TIME	You have not set the time zone, date and time. This message appears each time you turn the power on until you set the time zone, date and time.	19
CHANGE THE BATTERY PACK	Battery pack is exhausted. Replace or charge the battery pack.	12
THE TAPE IS SET FOR ERASURE PREVENTION	Cassette is protected. Replace the cassette or change the position of the protect switch.	81
REMOVE THE CASSETTE	Camcorder stopped operating to protect the tape. Unload and reload the cassette.	15
CHECK THE INPUT	DV cable is not connected, or the connected digital device is turned off.	72
CONDENSATION HAS BEEN DETECTED	Condensation has been detected in the camcorder.	79
TAPE END	Tape reached the end. Rewind the tape or replace the cassette.	-
WRONG FORMAT PLAYBACK NOT POSSIBLE	You attempted to play back a tape recorded in HD format.	-
COPYRIGHT PROTECTED PLAYBACK IS RESTRICTED	You attempted to play back a copyright protected tape.	71
COPYRIGHT PROTECTED DUBBING RESTRICTED	You attempted to dub a copyright protected tape. May also appear when an anomalous signal is received during analog line-in recording, or during analog-digital conversion of a copyright protected tape.	71

E

Maintenance/Others

Camcorder Handling Precautions

- Do not carry the camcorder by the LCD panel or viewfinder.
- Do not leave the camcorder in places subject to high temperatures, such as a sun-heated car, and high humidity.
- Do not use the camcorder near strong electric or magnetic fields such as above TVs, near plasma TVs or mobile phones.
- Do not point the lens or viewfinder at strong light sources. Do not leave the camcorder pointed at a bright subject.
- Do not use the camcorder in dusty or sandy places. Dust or sand getting inside the cassette or camcorder may cause damage. Dust and sand can also damage the lens. Attach the lens cap after use.
- The camcorder is not waterproof. Water, mud or salt getting inside the cassette or camcorder may cause damage.
- Be careful of heat generated by lighting equipment.
- Do not disassemble the camcorder. If the camcorder does not function properly, consult qualified service personnel.
- Handle the camcorder with care. Do not subject the camcorder to shocks or vibration as this may cause damage.
- Avoid sudden changes in temperature. Moving the camcorder rapidly between hot and cold temperatures may cause condensation to form on its internal surfaces (□□ 79).

Storage

- If you do not intend to use the camcorder for a long time, store it in a place free of dust, in low humidity, and at temperatures not higher than 30 °C (86 °F).
- After storage, check the functions of your camcorder to make sure that the camcorder is still working properly.

Cleaning

Camcorder Body and Lens

- Use a soft, dry cloth to clean the camcorder body and lens. Never use chemically treated cloth or volatile solvents such as paint thinner.

LCD Screen

- Clean the LCD screen using a commercially available cleaning cloth for glasses.
- Condensation may form on the surface of the screen when the temperature changes suddenly. Wipe it with a soft dry cloth.
- At cold temperatures, the screen may be darker than usual. This is not a malfunction. The screen returns to normal when the camcorder warms up.

Viewfinder

- Clean the viewfinder screen using a blower brush or a commercially available cleaning cloth for glasses.

Video Heads

- When the playback picture becomes distorted, the video heads need to be cleaned.

- To maintain the best picture quality, we recommend cleaning the video heads frequently with the Canon DVM-CL Digital Video Head Cleaning Cassette or a commercially available dry cleaning cassette.
- Tapes already recorded with dirty video heads may not be played back correctly even when you clean the video heads.
- Do not use wet type cleaning cassettes as this may damage the camcorder.



Condensation

Moving the camcorder rapidly between hot and cold temperature may cause condensation (water droplets) to form on its internal surfaces. Stop using the camcorder if condensation is detected. Continued use may damage the camcorder.

Condensation may form in the following cases:

When the camcorder is moved from an air-conditioned room to warm, humid place



When the camcorder is moved from a cold place to a warm room



When the camcorder is left in a humid room

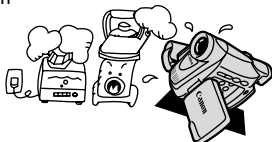

When a cold room is heated rapidly



How to avoid condensation:

- Unload the cassette, place the camcorder in an airtight plastic bag and let it adjust to temperature changes slowly before removing it from the bag.

When condensation is detected:

- The camcorder stops operating and the warning message "CONDENSATION HAS BEEN DETECTED" appears for approx. 4 seconds and "☹" starts flashing.
- If a cassette is loaded, the warning message "REMOVE THE CASSETTE" appears and "☹" starts flashing. Remove the cassette immediately and leave the cassette compartment open. Leaving the cassette in the camcorder may damage the tape.
- A cassette cannot be loaded when condensation is detected.

Resuming use:

- It takes about 1 hour until the water droplets evaporate. After the condensation warning stops flashing, wait for 1 more hour before resuming use.

Battery Pack Handling Precautions

DANGER!

Treat the battery pack with care.

- Keep it away from fire (or it might explode).
- Do not expose the battery pack to temperature higher than 60 °C (140 °F). Do not leave it near a heater or inside a car in hot weather.
- Do not try to disassemble or modify it.
- Do not drop or knock it.
- Do not get it wet.

- Charged battery packs continue to discharge naturally. Therefore, charge them on the day of use, or the day before, to ensure a full charge.
- Attach the terminal cover whenever a battery pack is not in use. Contact to metallic objects may cause a short circuit and damage the battery pack.
- Dirty terminals may cause a poor contact between the battery pack and the camcorder. Wipe the terminals with a soft cloth.
- Since storing a charged battery pack for a long time (about 1 year) can shorten its lifecycle or affect performance, we recommend to discharge the battery pack fully and to store it in a dry place at temperatures no higher than 30 °C (86 °F). If you do not use the battery pack for long periods, charge and discharge it fully at least once a year. If you have more than 1 battery pack, perform these precautions at the same time for all battery packs.
- Although the battery pack's operating temperature range is from 0 °C to 40 °C (32 °F to 104 °F), the optimal range is from 10 °C to 30 °C (50 °F to 86 °F). At cold temperatures, performance will temporarily decline. Warm it in your pocket before use.
- Replace the battery pack if the usable time after full charge diminishes substantially at normal temperatures.

About the battery terminal cover

The battery terminal cover has a []-shaped hole. This is useful when you wish to differentiate between charged and uncharged battery packs. For example, with charged battery packs, attach the terminal cover so that the []-shaped hole shows the blue label.

Back side of the battery pack

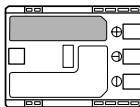

Terminal cover attached
Charged

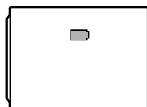

Uncharged



Lithium Button Battery Handling Precautions

E

WARNING!

- The battery used in this device may present a fire or chemical burn hazard if mistreated. Do not recharge, disassemble, heat above 100 °C (212 °F) or incinerate the battery.
- Replace the battery with a CR1616 made by Panasonic, Hitachi Maxell, Sony, Toshiba, Varta or Renata. Use of other batteries may present a risk of fire or explosion.

- Do not pick up the battery using tweezers or other metal tools as this will cause a short circuit.
- Wipe the battery with a clean dry cloth to ensure proper contact.
- Keep the battery out of reach of children. If it is swallowed, seek medical assistance immediately. The battery case may break and the battery fluids may damage stomach and intestines.
- Do not disassemble, heat or immerse the battery in water to avoid the risk of explosion.

Cassette Handling Precautions

- Rewind tapes after use. If the tape becomes slack and damaged, it may cause picture and sound distortion.
- Return cassettes in the case and store them upright.
- Do not leave the cassette in the camcorder after use.
- Do not use spliced tapes or nonstandard cassettes as they may damage the camcorder.
- Do not use tapes that have been jammed as video heads may become dirty.
- Do not insert anything into the small holes of the cassette, or cover them with cellophane tape.
- Handle cassettes with care. Do not drop or subject them to severe impact as this may damage the cassettes.
- Rewind tapes from time to time if they are stored for a long time.
- With cassettes equipped with a memory function, metal plated terminals may become dirty with use. Clean the terminals with a cotton swab after about 10 times of loading/unloading. The memory function is not supported by the camcorder.

Protecting Tapes from Accidental Erasure

To protect your recordings from accidental erasure, slide the tab on the cassette to the left. (This switch position is usually labeled SAVE or ERASE OFF.)

If you load a protected cassette in CAMERA mode, the message "THE TAPE IS SET FOR ERASURE PREVENTION" appears for approx. 4 seconds and "⏮" starts flashing. If you wish to record on that cassette, slide the tab back to the right.

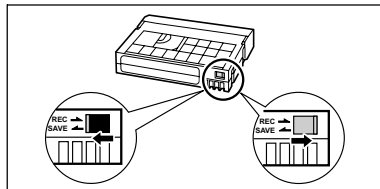

Additional
Information

Using the Camcorder Abroad

Power Sources

You can use the compact power adapter to operate the camcorder and to charge battery packs in any country with power supply between 100 and 240 V AC, 50/60 Hz. Consult the Canon Service Center for information on plug adapters for overseas use.

Playback on a TV Screen

You can only play back your recordings on TVs with NTSC system. The NTSC system is used in the following countries/areas:

American Samoa, Antigua, Aruba, Bahamas, Barbados, Bermuda, Bolivia, Canada, Chile, Columbia, Costa Rica, Cuba, Ecuador, El Salvador, Guam, Guatemala, Greenland, Haiti, Honduras, Jamaica, Japan, Korea, Mexico, Micronesia, Myanmar, Nicaragua, Panama, Peru, Philippines, Puerto Rico, Saint Kitts and Nevis, Saint Lucia, Saint Vincent and the Grenadines, Surinam, Taiwan, Trinidad and Tobago, USA, Venezuela, Virgin Islands.

Troubleshooting



If you have a problem with your camcorder, refer to this checklist. Consult your dealer or a Canon Service Center if the problem persists.

E

Power Source

Problem	Cause	Solution	
Camcorder will not turn on.	Battery pack is exhausted.	Replace or charge the battery pack.	12
	Battery pack is not correctly attached.	Attach the battery pack correctly.	12
The camcorder switches off by itself.	Battery pack is exhausted.	Replace or charge the battery pack.	12
	Power save function has been activated.	Turn on the camcorder.	22
Cassette compartment will not open.	Battery pack is exhausted.	Replace or charge the battery pack.	12
	Cassette compartment cover is not fully open.	Open the cassette compartment cover fully.	15
Cassette compartment stopped during loading/unloading.	Battery pack is exhausted.	Replace or charge the battery pack.	12
	The camcorder malfunctions.	Consult a Canon Service Center.	–
LCD/viewfinder switches on and off.	Battery pack is exhausted.	Replace or charge the battery pack.	12
Battery pack will not charge.	Battery packs will not charge outside the temperature range of 0 °C and 40°C (32 °F and 104 °F).	Charge the battery pack in temperatures between 0 °C and 40 °C (32 °F and 104 °F).	–
	Battery packs become hot with use and may not charge.	Wait until the battery pack temperature is below 40 °C (104 °F) and retry charging.	–
	The battery pack is damaged.	Use a different battery pack.	–

Recording/Playback

Problem	Cause	Solution	
Buttons will not work.	Camcorder is not turned on.	Turn on the camcorder.	22
	Cassette is not loaded.	Load a cassette.	15
"  flashes on the screen.	Cassette is not loaded.	Load a cassette.	15
"  flashes on the screen.	Battery pack is exhausted.	Replace or charge the battery pack.	12
"  flashes on the screen.	Condensation is detected.	See reference page.	79
"REMOVE THE CASSETTE" appears on the screen.	Camcorder stopped operating to protect the tape.	Unload and reload the cassette.	15

Recording

Problem	Cause	Solution	
Image will not appear on the screen.	Camcorder is not set to CAMERA mode.	Set the camcorder to CAMERA mode.	22

Additional Information

Problem	Cause	Solution	
"SET THE TIME ZONE, DATE AND TIME" appears on the screen.	Time zone, date and time are not set.	Set the time zone, date and time.	19
	Backup battery is exhausted.	Replace the backup battery and reset the time zone, date and time.	16
	Battery pack is inserted the wrong way.	Insert the backup battery with the + side facing outward and set the time zone, date and time.	16
Pressing the start/stop button will not start recording.	Camcorder is turned off.	Turn on the power.	22
	Cassette is not loaded.	Load a cassette.	15
	Tape reached the end ("END" flashes on the screen).	Rewind the tape or replace the cassette.	15
	Cassette is protected (" " flashes on the screen).	Change the position of the protect switch.	81
	Camcorder is set to a mode other than the CAMERA mode.	Set the camcorder to CAMERA mode.	22
Camcorder will not focus.	Autofocus does not work on that subject.	Focus manually.	44
	Viewfinder is not adjusted.	Adjust the viewfinder with the dioptic adjustment lever.	17
	Lens is dirty.	Clean the lens.	78
A vertical light bar appears on the screen.	Bright light in a dark scene may cause a vertical light bar (smear) to appear. This is not a malfunction.	---	-
Viewfinder picture is blurred.	Viewfinder is not adjusted.	Adjust the viewfinder with the dioptic adjustment lever.	17
Sound is distorted or recorded in a lower volume than the actual volume.	When recording near loud sound (such as fireworks, drums or concerts), sound may become distorted or may not be recorded in the actual sound level. This is not a malfunction.	---	-

Playback

Problem	Cause	Solution	
Pressing the playback button does not start playback.	Camcorder is turned off, or is not set to PLAY (VCR) mode.	Set the camcorder to PLAY (VCR) mode.	29
	Cassette is not loaded.	Load a cassette.	15
	Tape reached the end ("END" flashes on the screen).	Rewind the tape.	29
Image will not appear on the TV screen.	[AV ➔ DV] is set to [ON].	Set [AV ➔ DV] to [OFF].	72
Tape is running, but image will not appear on the TV screen.	TV/VIDEO selector on the TV is not set to VIDEO.	Set the selector to VIDEO.	32
	Video heads are dirty.	Clean the video heads.	78
	You attempted to play back or dub copyright protected tape.	Stop playback/dubbing.	–
No sound from the built-in speaker.	Speaker volume is turned off.	Adjust the volume with the SET dial.	31

E

Editing

Problem	Cause	Solution	
Dubbing via the camcorder's DV terminal does not work.	[AV ➔ DV] is set to [ON].	Set [AV ➔ DV] to [OFF].	72
	Wrong signal format.	Dubbing may work via the AV terminal. Refer also to the instruction manual of the connected device.	–

System Diagram (Availability differs from area to area)

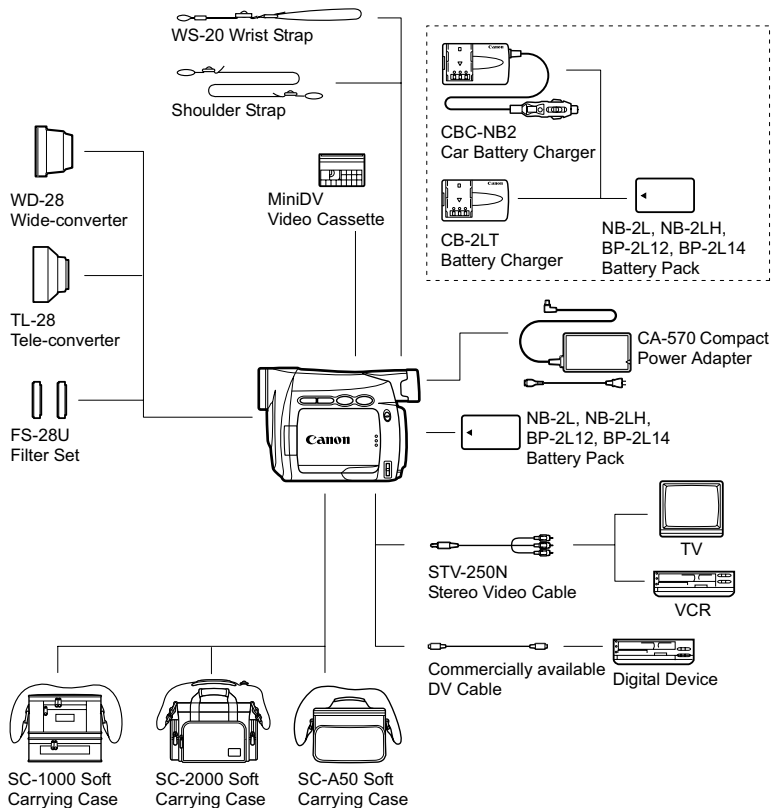

Optional Accessories

Call or visit your local retailer/dealer for genuine Canon video accessories. You can also obtain genuine accessories for your Canon camcorder by calling: 1-800-828-4040, Canon U.S.A. Information Center.

E

Use of genuine Canon accessories is recommended.

This product is designed to achieve excellent performance when used with genuine Canon accessories. Canon shall not be liable for any damage to this product and/or accidents such as fire, etc., caused by the malfunction of non-genuine Canon accessories (e.g., a leakage and/or explosion of a battery pack). Please note that this warranty does not apply to repairs arising out of the malfunction of non-genuine Canon accessories, although you may request such repairs on a chargeable basis.

Battery Packs

When you need extra battery packs, select from the following: NB-2L, NB-2LH, BP-2L12, BP-2L14.

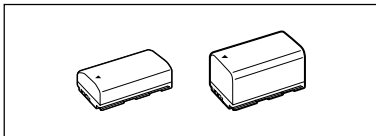

CB-2LT Battery Charger

Use the battery charger for charging the battery packs. It plugs directly into a power outlet without a cable.

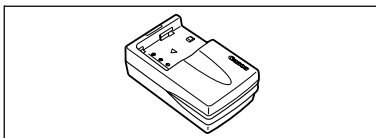

Battery Pack	Charging Time
NB-2LH	90 min.
NB-2L	80 min.
BP-2L12	150 min.
BP-2L14	170 min.

Charging time varies according to the charging condition.

CBC-NB2 Car Battery Charger

Use the car battery charger to charge battery packs on the move. The car battery cable plugs into your car's cigarette lighter and runs off a 12-24 V DC negative ground battery.

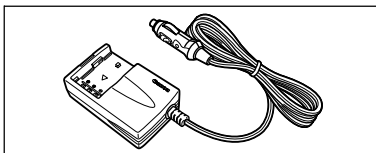

TL-28 Tele-converter

This Tele-converter lens increases the focal length of the camcorder lens by a factor of 1.7.

- The image stabilizer is not as effective when the Tele-converter is attached.
- The minimum focusing distance with the TL-28 is 3 m (9.8 ft.); 3 cm (1.2 in.) at maximum wide angle.

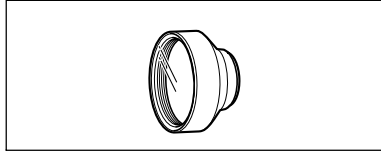

WD-28 Wide-converter

This lens decreases focal length by a factor of 0.7, giving you a wide perspective for indoor shots or panoramic views.

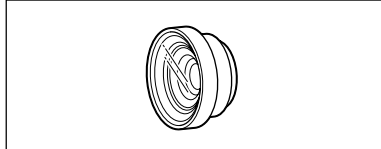

FS-28U Filter Set

Neutral density and MC protector filters help you to control difficult lighting conditions.

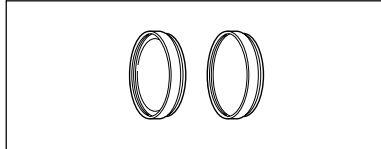

WS-20 Wrist Strap

Use this for extra additional protection for active shooting.

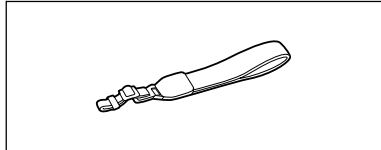

Shoulder Strap

You can attach a shoulder strap for more security and portability. Pass the ends through the strap mount and adjust the length of the strap.

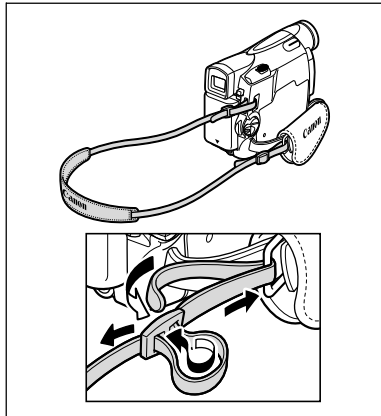

SC-1000/SC-2000 Soft Carrying Case

A handy camcorder bag with padded compartments and plenty of space for accessories.

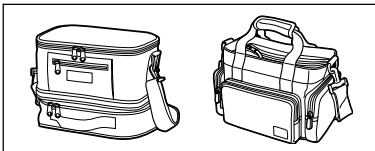

E

SC-A50 Soft Carrying Case

This lightweight bag keeps the camcorder within easy reach without weighing you down or getting in the way.

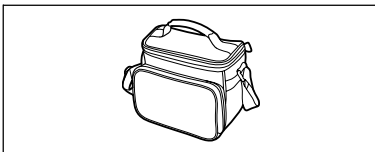

This mark identifies genuine Canon video accessories. When you use Canon video equipment, we recommend Canon-brand accessories or products bearing the same mark.



Specifications

ZR100

System

Video Recording System	2 rotary heads, helical scanning DV system (consumer digital VCR SD system), digital component recording
Audio Recording System	PCM digital sound: 16 bit (48 kHz/2 ch); 12 bit (32 kHz/4 ch)
Television System	EIA standard (525 lines, 60 fields) NTSC color signal
Image Sensor	1/6-inch CCD, approx. 680,000 pixels Effective pixels: approx. 340,000 pixels
Tape Format	Videocassettes bearing the "MiniDV" mark.
Tape Speed	SP: 18.81 mm/s (0.74 ips), LP: 12.56 mm/s (0.49 ips)
Maximum Recording Time (80 min. cassette)	SP: 80 min., LP: 120 min.
Fast Forward/Rewind Time	Approx. 2 min. 20 sec. (with a 60 min. cassette)
LCD Screen	2.4-inch. TFT color, approx. 112,000 pixels
Viewfinder	0.33-inch. TFT color, approx. 113,000 pixels
Microphone	Stereo electret condenser microphone
Lens	f=2.8-56 mm, f/1.6-3.2, 20x power zoom 35mm equivalent: 4:3 recording: 53.5-1070 mm 16:9 recording : 44.2-884 mm
Lens Configuration	11 elements in 8 groups
Filter Diameter	28 mm
AF System	TTL autofocus, manual focusing possible
Minimum Focusing Distance	1 m (3.3 ft.); 1 cm (0.39 in.) on maximum wide angle
White Balance	Auto white balance, pre-set white balance (indoor, outdoor) or custom white balance
Minimum Illumination	2.0 lx (using the Night mode)
Recommended Illumination	More than 100 lx
Image Stabilization	Electronic

Input/Output Terminals

AV Terminal	Ø3,5 mm minijack Video: 1 Vp-p/75 ohms unbalanced Audio output: -10 dBV (47 kohm load)/3 kohms or less Audio input: -10 dBV/40 kohms or more
DV Terminal	Special 4-pin connector (IEEE 1394 compliant)

Power/Others

Power supply (rated)	7.4 V DC
Power consumption (AF on)	2.3W (using viewfinder), 3.1W (using LCD screen in normal brightness)
Operating temperature	0 – 40 °C (32 – 104 °F)
Dimensions (W x H x D)	51 x 93 x 130 mm (2.0 x 3.7 x 5.1 in.) excluding protrusions
Weight (camcorder body only)	430 g (15.2 oz.)

CA-570 Compact Power Adapter

Power supply	100 – 240 V AC, 50/60 Hz
Power consumption	17W
Rated output	8.4 V DC, 1.5 A
Operating temperature	0 – 40 °C (32 – 104 °F)
Dimensions	52 x 90 x 29 mm (2.1 x 3.5 x 1.1 in.)
Weight	135 g (4.8 oz.)

E

NB-2LH Battery Pack

Battery type	Rechargeable Lithium Ion Battery
Rated voltage	7.4 V DC
Operating temperature	0 – 40 °C (32 – 104 °F)
Battery capacity	720 mAh
Dimensions	33.3 x 16.2 x 45.2 mm (1.3 x 0.64 x 1.8 in.)
Weight	43 g (1.5 oz.)

Weight and dimensions are approximate. Errors and omissions excepted. Subject to change without notice.

Item Codes

Provided Accessories

Lens Cap	D52-0300-000
CA-570 Compact Power Adapter	8468A002AA
NB-2LH Battery Pack	9612A001AA
STV-250N Stereo Video Cable	3067A002AA (D82-0590-201)

Optional Accessories

BP-2L12 Battery Pack	7871A002AA
BP-2L14 Battery Pack	9582A002AA
NB-2L Battery Pack	7302A001AA
CB-2LT Battery Charger	7303A001AA
CBC-NB2 Car Battery Charger	7873A002AA
WD-28 Wide-converter	7954A001AA
TL-28 Tele-converter	7953A001AA
FS-28U Filter Set	7952A001AA
WS-20 Wrist Strap	3118A002AA (D81-0190-202)
SC-2000 Soft Carrying Case	9389A001AA
SC-1000 Soft Carrying Case	3083A002AA (D81-1200-201)
SC-A50 Soft Carrying Case	D81-1302-201
DVM-CL DV Cleaning Cassette	3134A002AA (D36-0032-201)

Index

12bit audio	62
16:9 widescreen	57
6-second auto date	60

A

Abroad, using the camcorder	82
Accessories	8, 87
AE Shift	43
Analog line-in	69
Analog-digital converter	72
Audio mode	52
Auto	38
Autofocus	44
AV terminal	32
AV-DV	72

B

Backlight	18
Backup battery	16
Battery charger	87
Battery pack	12
Beep	65
Brightness	65

C

Computer	74
Condensation	79
Connections - TV, VCR	32
Copyright signals	71

D

Data code	59
Date and time	19
Date format	64
Demo mode	66
Digital effects	53
Digital zoom	27
DV dubbing	70
DV terminal	67, 74

E

Easy recording	38
Effects	54
End search	61

F

Faders	53
Fast forward	30
Focusing	44

G

Grip belt	17
-----------	----

I

Image stabilizer	66
Infinity focus	45

L

Language	64
LCD Backlight	18
LCD mirror mode	23
LCD screen	18
Lens cap	17
Low light mode	38
LP mode	51

M

Maintenance	78
Manual focus	44
Menus	34
Multi-image screen	54
My Camera settings	63

N

Night mode	41
------------	----

O

Operating Mode	5
Output channel	33

P

Playback	29
Playback pause	30
Portrait mode	38
Power adapter	12
Program AE	38

E

Additional
Information

R

Record review	25
Record search	25
Recording movies	22
Recording programs	38
Rewind	29

S

Sand & Snow mode	38
Screen displays	75
Self-timer	50
Shoulder strap	88
Shutter speed	48
Skin detail	42
SP mode	51
Speaker	31
Sports mode	38
Spotlight mode	38

T

Tape protection	81
Time code	24
Time zone	19
Tripod	28
Troubleshooting	83
TV Screen	75

V

Video heads	78
Videocassettes	15
Viewfinder	17

W

White balance	46
Widescreen	57
Wind screen	52

Z

Zooming	26
---------------	----

CANON CONSUMER DIGITAL VIDEO EQUIPMENT LIMITED WARRANTY FOR THE UNITED STATES

The warranty set forward below is given by Canon U.S.A., Inc. with respect to equipment purchased in the United States. The limited warranty is only effective upon presentation of your Bill of Sale or other proof of purchase.

Canon consumer digital video equipment is warranted under normal, non-commercial, personal use, against defective materials or workmanship as follows:

Parts: Defective parts will be exchanged for new parts or comparable rebuilt parts for a period of ONE YEAR from the date of original purchase, except for a defective Video Head, which will be exchanged for a period of three months from the date of purchase.

Labor: For a period of ONE YEAR from the date of original purchase, labor will be provided free of charge by our factory service centers or designated service facilities located in the United States.

When returning equipment under this warranty, you must pre-pay the shipping charges, and you must enclose the Bill of Sale or other proof of purchase with a complete explanation of the problem. During your ONE-YEAR warranty period, repairs will be made and the equipment return-shipped to you free of charge. After your warranty period is over, you will be given an estimate of the cost of repair and an opportunity to approve or disapprove of the repair expense before it is incurred. If you approve, repairs will be made and the equipment return-shipped to you. (shipping charges apply). If you disapprove, we will return-ship the equipment at no charge to you.

Non-Canon brand peripheral equipment and software which may be distributed with Canon DV camcorders are sold "AS IS" without warranty of any kind by CUSA, including any implied warranty regarding merchantability or fitness for a particular purpose. The sole warranty with respect to such non-Canon brand items is given by the manufacturer or producer thereof.

CUSA shall have no responsibility under this limited warranty for use of Canon DV Camcorders in conjunction with incompatible peripheral equipment and incompatible software.

In order to obtain warranty service, contact the authorized Canon retail dealer from whom you purchased the DV Camcorder or call the CANON INFORMATION CENTER AT 1-800-628-4040. You will be directed to the nearest service facility for your product.

This Limited Warranty covers all defects encountered in normal use of the equipment and does not apply in the following cases:

- A) Loss or damage to the equipment due to abuse, mishandling, accident, improper maintenance, or failure to follow operating instructions;
- B) If the equipment is defective as a result of leaking batteries, sand, dirt or water damage;
- C) If defects or damages are caused by the use of unauthorized parts or by service other than our authorized agent;
- D) If the equipment is used for commercial or industrial use.

This Limited Warranty does not cover cabinet (exterior finish), video cassette tape, head cleanings, nor does it apply to equipment purchased outside the United States. This warranty does not cover units sold to rental firms, military operations, hotels, schools, hospitals or for other commercial, industrial, or institutional applications.

These uses are covered only by such specific warranty as Canon may issue with such sales.

This Limited Warranty does not apply to accessories or consumables for the DV Camcorder, which are sold "AS IS", without warranty of any kind by CUSA.

Please retain this warranty card and your Bill of Sale as a permanent record of your purchase. This card is most important in order to be sure you are contacted right away should there be a safety inspection, modification or product recall under applicable laws or regulations.

NO IMPLIED WARRANTY, INCLUDING MERCHANTABILITY AND FITNESS FOR A PARTICULAR PURPOSE APPLIES TO THIS EQUIPMENT AFTER THE APPLICABLE PERIOD OF EXPRESS WARRANTY OR GUARANTY, EXCEPT AS MENTIONED ABOVE, GIVEN BY ANY PERSON, FIRM OR CORPORATION WITH RESPECT TO THIS EQUIPMENT SHALL BIND THE UNDERSIGNED. (SOME STATES DO NOT ALLOW LIMITATIONS ON HOW LONG AN IMPLIED WARRANTY LASTS, SO THE ABOVE LIMITATION OR EXCLUSION MAY NOT APPLY TO YOU). CUSA SHALL NOT BE LIABLE FOR LOSS OF REVENUES OR PROFITS, EXPENSE FOR SUBSTITUTE EQUIPMENT OR SERVICE, STORAGE CHARGES, LOSS OF DATA, OR ANY OTHER SPECIAL, INCIDENTAL OR CONSEQUENTIAL DAMAGES CAUSED BY THE USE, MISUSE OR INABILITY TO USE THE DV CAMCORDER, REGARDLESS OF THE LEGAL THEORY ON WHICH THE CLAIM IS BASED, AND EVEN IF CUSA HAS BEEN ADVISED OF THE POSSIBILITY OF SUCH DAMAGES. NOR SHALL RECOVERY OF ANY KIND AGAINST CUSA BE GREATER THAN THE PURCHASE PRICE OF THE DV CAMCORDER SOLD BY CUSA AND CAUSING THE ALLEGED DAMAGE. WITHOUT LIMITING THE FOREGOING, YOU ASSUME ALL RISK AND LIABILITY FOR LOSS, DAMAGE OR INJURY TO YOU AND YOUR PROPERTY AND TO OTHERS AND THEIR PROPERTY ARISING OUT OF USE, MISUSE OR INABILITY TO USE THE DV CAMCORDER NOT CAUSED DIRECTLY BY THE NEGLIGENCE OF CUSA. (SOME STATES DO NOT ALLOW THE EXCLUSION OR LIMITATION OF INCIDENTAL OR CONSEQUENTIAL DAMAGES, SO THE ABOVE LIMITATION MAY NOT APPLY TO YOU). THIS WARRANTY SHALL NOT EXTEND TO ANYONE OTHER THAN THE ORIGINAL PURCHASER OF THIS EQUIPMENT OR THE PERSON FOR WHOM IT WAS PURCHASED AS A GIFT.

This warranty gives you specific legal rights, and you may also have other rights which vary from state to state. CANON U.S.A., INC.

CANON CONSUMER DIGITAL VIDEO EQUIPMENT LIMITED WARRANTY

The limited warranty set forth below is given by Canon Canada Inc. ("Canon Canada") with respect to Canon digital video equipment purchased in Canada. This limited warranty is only effective upon presentation of a bill of sale or other proof of purchase for this Canon digital video equipment to a Canon Service Facility when repairs are required.

Canon consumer video digital equipment is warranted under normal, non-commercial, personal use, against defective materials or workmanship as follows:

Parts: Defective parts will be exchanged for new parts or, at Canon Canada's option, comparable rebuilt parts for a period of one year from the date of original purchase, except Video Heads which will be exchanged for a period of 3 months from the date of purchase.

Labour: For a period of one year from the date of original purchase, labour will be provided free of charge by our Canon Service Facilities in Canada.

This limited warranty covers all defects except where:

(a) The loss or damage to the product results from:

- i) accident, natural disaster, mishandling, abuse, neglect, unauthorized product modification or failure to follow instructions contained in the instruction manual;
- ii) the use of accessories, attachments, products, supplies, parts or devices with this Canon product that do not conform to Canon specifications or that cause abnormally frequent service problems;
- iii) repairs or services performed by any party other than a Canon Service Facility;
- iv) defective batteries or any exposure to water, sand or dirt;
- v) shipping (claim must be presented to the shipper);

(b) Any serial number on the video equipment is altered or removed.

(c) The digital video equipment is used for commercial, professional or industrial purposes.

This limited warranty does not cover the cabinet (exterior finish) of the digital video equipment, video cassette tapes, head cleanings, nor does it apply to digital video equipment purchased outside Canada.

TO OBTAIN WARRANTY SERVICE

Ship your Canon digital video equipment in its original carton, box or equivalent, properly packed, fully insured with shipping charges prepaid, together with a copy of your bill of sale or other proof of purchase and a description of the problem to any of the Canon Service Facilities in Canada.

LIMITATIONS

Except as otherwise required by applicable legislation, this warranty is in lieu of all other warranties, conditions, guarantees or representations, express or implied, statutory or otherwise, relative to this Canon product, including implied warranties or conditions of merchantability or fitness for a particular purpose.

Canon Canada assumes no liability for special, consequential or incidental damages or loss that may arise, whether on account of negligence or otherwise, from the use, misuse or inability to use this Canon product (including loss of profit, revenue, video tapes or enjoyment) or from failure to conform to any express or implied warranties, conditions, guarantees or representations. Any recovery under this limited warranty shall not exceed the purchase price of the product. Canon Canada does not assume or authorize any other person to assume for Canon Canada any other liability with respect to this Canon product.

This warranty does not extend to any person other than the original purchaser of this Canon product or the person for whom it was purchased as a gift and states your exclusive remedy.

NOTICE TO CONSUMER

If you plan to take important videos or if the product has not been used for some time, please check all functions with the instruction book before using it.

Canon

CANON INC.

U.S.A.

CANON U.S.A., INC. NEW JERSEY OFFICE

100 Jamesburg Road, Jamesburg, NJ 08831 USA

CANON U.S.A., INC. CHICAGO OFFICE

100 Park Blvd., Itasca, IL 60143 USA

CANON U.S.A., INC. LOS ANGELES OFFICE

15955 Alton Parkway, Irvine, CA 92618 USA

CANON U.S.A., INC. HONOLULU OFFICE

210 Ward Avenue, Suite 200, Honolulu, HI 96814 USA

- **If you have any questions, call the Canon U.S.A. Information Center toll-free at 1-800-828-4040 (U.S.A. only).**

CANADA

CANON CANADA INC. NATIONAL HEADQUARTERS

6390 Dixie Road, Mississauga, Ontario L5T 1P7

CANON CANADA INC. CALGARY

2828, 16th Street, N.E. Calgary, Alberta T2E 7K7

CANON CANADA INC. MONTREAL

5990 Côte de Liesse, Quebec H4T 1V7

- **If you have any questions, call the Canon Canada Information Center toll-free at 1-800-828-4040 (CANADA only).**
- **Si vous avez des questions, veuillez téléphoner sans frais au Canada 1-800-828-4040 (CANADA seulement).**

MEXICO

CANON MEXICANA, S. DE R.L. DE C.V.

Periferico Sur No. 4124 Col. Ex-Rancho de Anzaldo C.P. 01900

México, D.F., México

CANON U.S.A., INC. NEW JERSEY OFFICE

100 Jamesburg Road, Jamesburg, NJ 08831 USA

CENTRAL Y SURAMÉRICA

CANON LATIN AMERICA, INC.

703 Waterford Way Suite 400 Miami, FL 33126 USA

ASIA

CANON HONGKONG COMPANY LTD.

19/F, The Metropolis Tower, 10 Metropolis Drive, Hunghom, Kowloon, Hong Kong



Printed on 100% reused paper.
Document réalisé avec du papier recyclé à 100%.
El papel aquí utilizado es 100% reciclado.

Free Manuals Download Website

<http://myh66.com>

<http://usermanuals.us>

<http://www.somanuals.com>

<http://www.4manuals.cc>

<http://www.manual-lib.com>

<http://www.404manual.com>

<http://www.luxmanual.com>

<http://aubethermostatmanual.com>

Golf course search by state

<http://golfingnear.com>

Email search by domain

<http://emailbydomain.com>

Auto manuals search

<http://auto.somanuals.com>

TV manuals search

<http://tv.somanuals.com>