

Operation Guide 5602

CASIO®

Contents

Before Getting Started...

Watch Face and Display Indicators

Navigating Between Modes

Mode Overview

Shifting the Hands

Viewing the Face in the Dark

Useful Features

Time Adjustment

Using Watch Operations to Adjust the Time Setting

Using the Watch in a Medical Facility or Aircraft

Using Mobile Link with a Mobile Phone

Getting Ready

Auto Time Adjustment

Mode Customization

Customizing the Timekeeping Mode Screen

Specifying a Port (Fishing Point)

Viewing Step Count Data

Recording Your Current Location (Location Memory)

Checking the Distance and Bearing to a Location Memory Point (Location Indicator)

Auto Altitude Calibration

Configuring World Time Settings

Adjusting Hand Alignment

Phone Finder

Configuring Watch Settings

Changing the Home City Summer Time Setting

Connection

Connecting with a Phone

Disconnecting from a Phone

Using the Watch in a Medical Facility or Aircraft

Unpairing

If you purchase another phone

Digital Compass

Taking a Compass Reading

Calibrating Compass Readings

Calibrating Compass Readings

Setting Up for True North Readings (Magnetic Declination Calibration)

Magnetic North and True North

Digital Compass Reading Precautions

Altitude Measurement

Checking the Current Altitude

Calibrating Altitude Readings (Offset)

Checking the Altitude Differential from a Reference Point

Setting the Auto Measurement Interval

Specifying the Altitude Measurement Unit

Altitude Reading Precautions

Barometric Pressure Measurement

Checking the Current Barometric Pressure

Checking Changes in Barometric Pressure Over Time

Checking the Change in Barometric Pressure between Two Readings

Sudden Barometric Pressure Change Indications

Calibrating Barometric Pressure Readings (Offset)

Specifying the Barometric Pressure Unit

Barometric Pressure Reading Precautions

Temperature Measurement

Checking the Current Temperature

Calibrating Temperature Readings (Offset)

Specifying the Temperature Unit

Temperature Reading Precautions

Using FISH IN TIME

Specifying a Port (Fishing Point)

Checking Today's FISH IN TIME

Checking FISH IN TIME for a Specific Day

Setting the FISH IN TIME ALARM

Setting the FISHING TIMER (FISH IN TIME Countdown)

Recording Catch Conditions (FISH MEMO)

Fishing and Moon Movement

Sunrise and Sunset Times

Specifying a Port (Fishing Point)

Looking Up Today's Sunrise and Sunset Times

Looking Up Sunrise and Sunset Times by Specifying a Day

Checking the Moon Age

Specifying a Port (Fishing Point)

Checking Today's Moon Age

Checking the Moon Age for a Specific Day

Tide Level

Specifying a Port (Fishing Point)

Checking the Current Tide Level in the Specified Port

Checking the Tide Level for a Specific Day

Adjusting High Tide Times

Stopwatch

Measuring Elapsed Time

Measuring a Split Time

Timer

Setting a Start Time

Using the Timer

Alarms and Hourly Time Signal

Configuring Alarm Settings

Configuring the Hourly Time Signal Setting

Turning Off an Alarm or the Hourly Time Signal

World Time

Checking World Time

Specifying a World Time City

Swapping Your Home Time and World Time

Specifying UTC (Coordinated Universal Time) as Your World Time City

Pedometer

Counting Steps

Causes of Incorrect Step Count

Hand Alignment Adjustment

Adjusting Hand Alignment

Other Settings

Enabling the Button Operation Tone

Reflecting Altitude Differential in Activity Measurements

Resetting Watch Settings

Moving to Another Time Zone

Other Information

City Table

Summer Time Table

Supported Phones

Specifications

Mobile Link Precautions

Copyrights and Registered Copyrights

Troubleshooting

Before Getting Started...

This section provides an overview of the watch and introduces convenient ways it can be used.

Important!

- This watch is not a special-purpose measuring instrument. Measurement function readings are intended for general reference only.
- Whenever using the Digital Compass of this watch for serious trekking, mountain climbing, or other activities, be sure to always take along another compass to confirm readings. If the readings produced by the Digital Compass of this watch are different from those of the other compass, perform figure 8 calibration or 2-point calibration of the watch compass to ensure better accuracy.

– Compass readings and calibration will not be possible if the watch is in the vicinity of a permanent magnet (magnetic accessory, etc.), metal objects, high-voltage wires, aerial wires, or electrical household appliances (TV, computer, cellphone, etc.)

Digital Compass

- The watch's Altimeter Mode calculates and displays relative altitude based on barometric pressure readings produced by its pressure sensor. Because of this, altitude values displayed by the watch may be different from your actual elevation and/or sea level elevation indicated for the area where you are located. Regular calibration in accordance with the local altitude (elevation) indications is recommended.

Altimeter Measurement

Note

- The illustrations included in this operation guide have been created to facilitate explanation. An illustration may differ somewhat from the item it represents.

Watch Face and Display Indicators

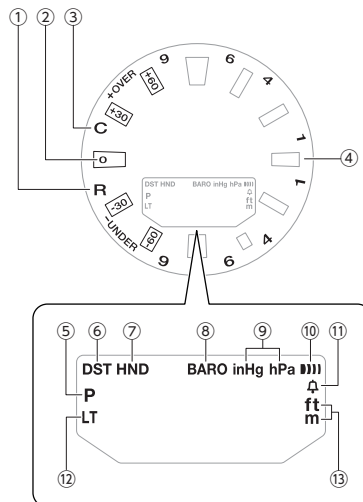

- ① The second hand points to [R] when the watch is standing by for connection with a phone.
- ② With 9 o'clock as the reference point, the second hand indicates either north (compass reading) or the approximate angle differential from your current location to a destination (Location Indicator).
- ③ The second hand points to [C] when the watch is connected with a phone.
- ④ The second hand indicates altitude/ barometric pressure differential.
- ⑤ Displayed during p.m. times while 12-hour timekeeping is being used.
- ⑥ Displayed when the indicated time is summer time.
- ⑦ Flashes while the watch's hands are shifted for easier reading.
- ⑧ Displayed while barometric pressure change indication is enabled.
- ⑨ Shows the barometric pressure measurement unit.
- ⑩ Displayed when an alarm is turned on.
- ⑪ Appears when the hourly time signal is on.
- ⑫ Displayed while Auto Light is enabled.
- ⑬ Shows the altitude and distance measurement unit.

● Battery Replacement

When battery power goes low, will start to flash and some functions will become disabled. If continues to flash, replace the battery.

Request battery replacement from a CASIO service center or your original retailer.

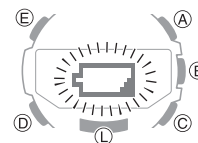

Navigating Between Modes

Your watch has the modes shown below.

- To return to the Timekeeping Mode from any other mode, hold down (D) for at least two seconds.

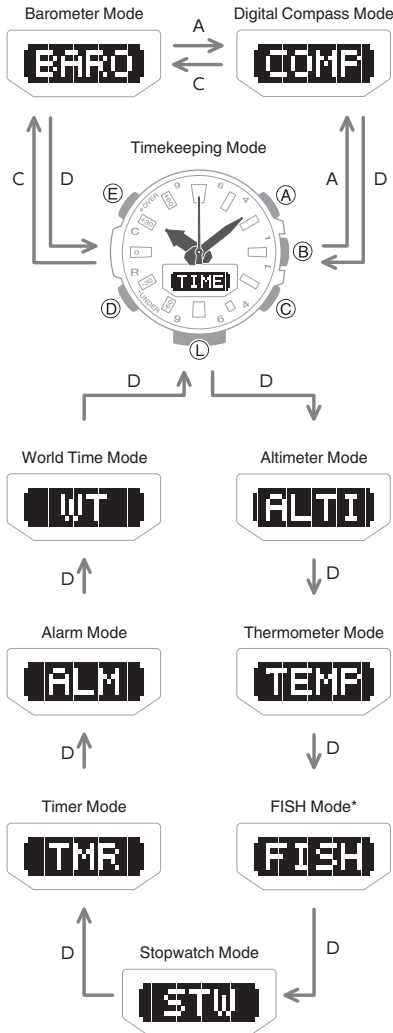

* Shows fishing information for a specified location and date.

Use the buttons in the illustration above to navigate between modes.

Note

- You can use PRO TREK Connected to change the arrangement of modes, or to delete or add modes.
[Mode Customization](#)
- To perform operations with PRO TREK Connected, you first need to pair the watch with the phone where the app is installed.
[Pair the watch with a phone.](#)

Mode Overview

Timekeeping Mode

In this mode, the digital display shows the current day of the week, month, and day. You can also use (E) to scroll display contents through the items below.

- Barometric pressure graph, month, day
- Hour, minute, second
- Step count
- Tide Graph
- Best fishing time (FISH IN TIME)

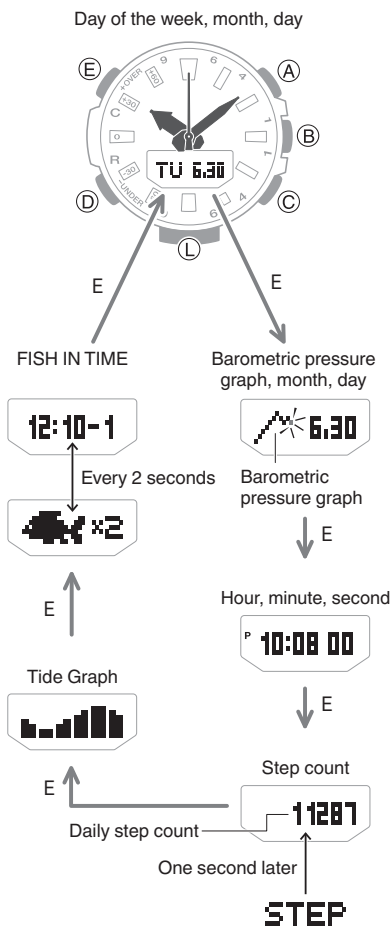

Note

- You can use PRO TREK Connected to add the items below to the display. You can also remove items from the display and rearrange their display locations.
 - Barometric pressure graph
 - World Time hour and minute
 - Sunrise and sunset times for a specified port (fishing point)
 - Moon age[Customizing the Timekeeping Mode Screen](#)
- To perform operations with PRO TREK Connected, you first need to pair the watch with the phone where the app is installed.
[Pair the watch with a phone.](#)

Connecting with a Paired Phone to Adjust the Watch's Time

Press (B).

[Triggering Immediate Time Adjustment](#)

Searching for a Paired Phone

Hold down (B) for about 5 seconds.

[Phone Finder](#)

Digital Compass Mode

Use this mode to take direction and bearing angle readings.

[Digital Compass](#)

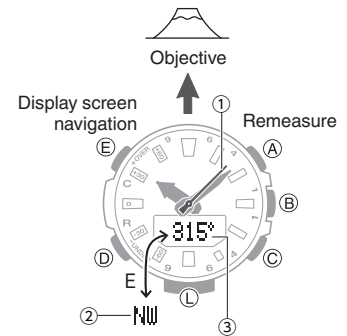

① North indication

② Bearing at 12 o'clock

③ Bearing angle at 12 o'clock

● Barometer Mode

Use this mode to take barometric pressure readings at your current location.

🔗 [Barometric Pressure Measurement](#)

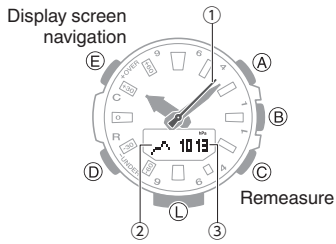

- ① Barometric pressure differential/current time seconds
- ② Barometric pressure graph
- ③ Barometric pressure

● Altimeter Mode

Use this mode to take an altitude reading for your current location.

🔗 [Altitude Measurement](#)

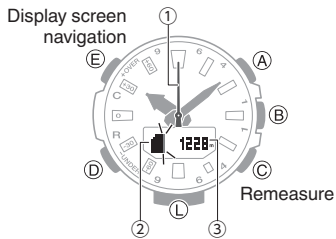

- ① Altitude differential/current time seconds
- ② Altitude graph
- ③ Altitude

● Thermometer Mode

Use this mode to take temperature readings at your current location.

🔗 [Temperature Measurement](#)

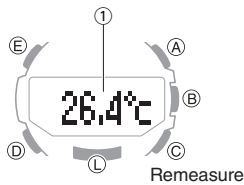

- ① Temperature

● FISH Mode

In this mode, the digital display shows best fishing times (FISH IN TIME) in the port you specify with PRO TREK Connected.

🔗 [Using FISH IN TIME](#)

You can also use (E) to scroll display contents through sunrise and sunset times, Moon Age, tide data, and other fishing information.

🔗 [Sunrise and Sunset Times](#)

🔗 [Checking the Moon Age](#)

🔗 [Tide Level](#)

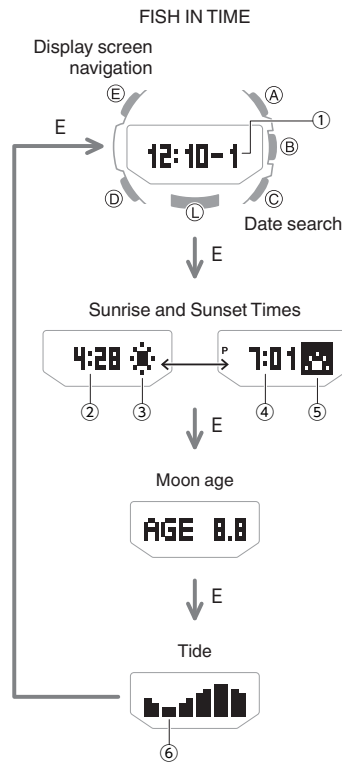

- ① Best fishing time
- ② Sunrise time
- ③ Sunrise indicator
- ④ Sunset time
- ⑤ Sunset indicator
- ⑥ Tide Graph

● Stopwatch Mode

Use this mode to measure elapsed time.

🔗 [Stopwatch](#)

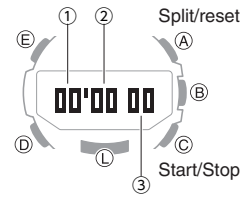

- ① Stopwatch minutes
- ② Stopwatch seconds
- ③ Stopwatch: 1/100 second

● Timer Mode

Use this mode to countdown from a desired start time.

🔗 [Timer](#)

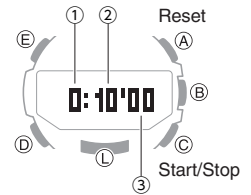

- ① Timer hours
- ② Timer minutes
- ③ Timer seconds

● Alarm Mode

The watch will beep when an alarm time is reached.

🔗 [Alarms and Hourly Time Signal](#)

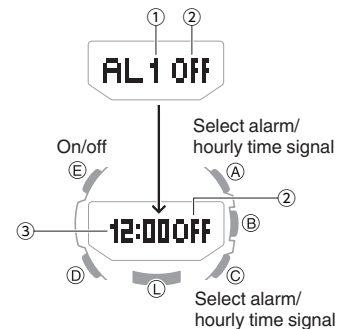

- ① Alarm number
- ② Alarm or hourly time signal status (on/off)
- ③ Alarm hour/minute

● World Time Mode

This mode shows the current time in 38 cities and UTC (Coordinated Universal Time) time.

World Time

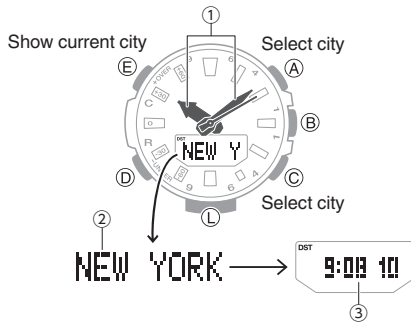

- ① Home City time
- ② World Time City
- ③ World Time City current time

Shifting the Hands

Hand shift moves the hands out of the way for easy viewing of display information.

1. While holding down (L), press (D).
This will shift the analog hands to allow easy viewing of display information.

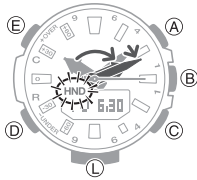

2. To return the hands to their normal timekeeping positions, hold down (L) as you press (D) again, or press (D) to change to another mode.

Note

- The hands will resume normal timekeeping automatically if you change modes or if you leave the watch with its hands shifted and do not perform any operation for about one hour.

Viewing the Face in the Dark

The face of the watch can be illuminated for viewing in the dark.

● To illuminate the face manually

Pressing (L) turns on illumination.

- Illumination will turn off automatically if an alarm starts to sound.



● To illuminate the face when Auto Light is enabled

If Auto Light is enabled, face illumination will turn on automatically whenever the watch is positioned at an angle of 40 degrees or more.

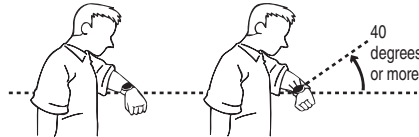

Important!

- Auto Light may not operate properly when the watch is at a horizontal angle of 15 degrees or greater from horizontal as shown in the illustration below.



- Electro-static charge or magnetism can interfere with proper auto light operation. If this happens, try lowering your arm and then angle it towards your face again.
- When moving the watch you may note a slight rattling sound. This is due to operation of the auto light switch, which determines the current orientation of the watch. It does not indicate malfunction.

Note

- Auto Light is disabled when any one of the conditions below exists.
 - Alarm, timer alert, or other beeper sounding
 - Hand movement operation is in progress
 - Watch in the Compass Mode

● Configuring the Auto Light Setting

Holding down (L) for at least three seconds in the Timekeeping Mode toggles Auto Light between enabled and disabled.

- [LT] is displayed while Auto Light is enabled.
- If you do not disable it manually, Auto Light remains enabled for approximately six hours. After that, it becomes disabled automatically.

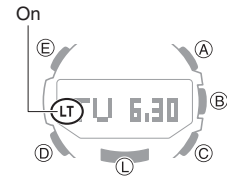

● Specifying the Illumination Duration

You can select either 1.5 seconds or three seconds as the illumination duration.

1. Enter the Timekeeping Mode.
 [Navigating Between Modes](#)
2. Hold down (E) for at least two seconds. Release the button when the name of the currently selected Home City appears on the display.

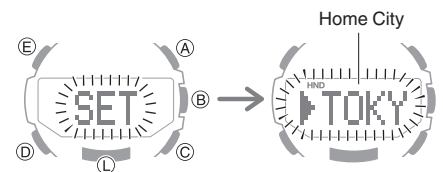

3. Press (D) three times to display [LT].

4. Press (C) to select an illumination duration.

[1]: 1.5-second illumination

[3]: 3-second illumination

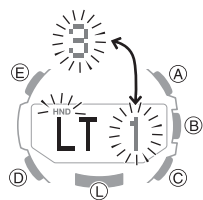

5. Press (E) twice to complete the setting operation.

Useful Features

Pairing the watch with your phone makes a number of the watch's features easier to use.

Auto time adjustment

[Auto Time Adjustment](#)

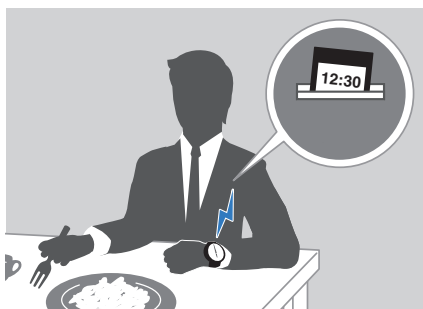

Selection of More Than 300 World Time cities

[Configuring World Time Settings](#)

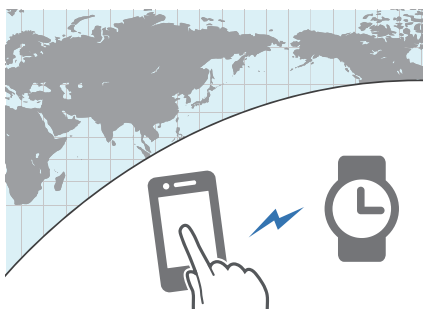

Data transfer to a phone

[Viewing Step Count Data](#)



Use your phone to check the distance and bearing to a point in Location Memory

[Checking the Distance and Bearing to a Location Memory Point \(Location Indicator\)](#)

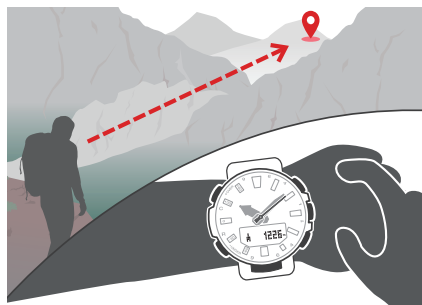

In addition, a number of other watch settings can be configured using your phone.

To transfer data to a watch and to configure settings, you first need to pair the watch with your phone.

[Getting Ready](#)

- Your phone needs to have the CASIO "PRO TREK Connected" app installed to pair with the watch.

Time Adjustment

Your watch can connect with a phone to obtain information that it uses to adjust its date and time setting.

Important!

- Disable Auto Time Adjustment when you are on an aircraft or in any other location where radio signals may cause problems.
 - [Using PRO TREK Connected to Configure Settings](#)
 - [Using Watch Operations to Configure Settings](#)

Referring to the information below, configure the time setting in accordance with the method that suits your own lifestyle.

Do you use a phone?

Time adjustment by connecting with your phone is recommended.

[Auto Time Adjustment](#)



If your phone cannot connect with the watch

You can adjust time settings by performing operations on the watch.

[Using Watch Operations to Adjust the Time Setting](#)

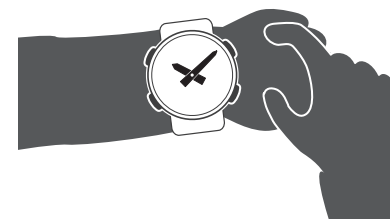

Using Watch Operations to Adjust the Time Setting

If your watch cannot connect with a phone for some reason, you can use watch operations to adjust date and time settings.

● Setting a Home Time City

Use the procedure in this section to select a city to use as your Home City. If you are in an area that observes summer time, you can also enable or disable summer time.

Note

- The initial factory default summer time setting for all cities is [AUTO]. In many cases, the [AUTO] setting lets you use the watch without switching between summer time and standard time.

1. Enter the Timekeeping Mode.
[🔍 Navigating Between Modes](#)

2. Hold down (E) for at least two seconds.
 Release the button when the name of the currently selected Home City appears on the display.

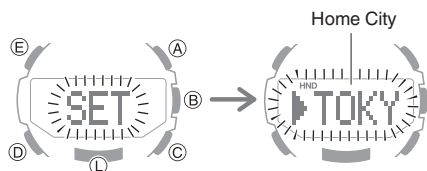

3. Use (A) and (C) to change the Home City.
 - For details refer to the information below.
[🔍 City Table](#)
4. Press (D).
5. Use (C) to change the summer time setting.

Each press of (C) cycles through settings in the sequence shown below.

- [AUTO]
 The watch switches between standard time and summer time automatically.
- [OFF]
 The watch always indicates standard time.
- [ON]
 The watch always indicates summer time.



6. Press (E) twice to complete the setting operation.

● Setting the Time/Date

1. Enter the Timekeeping Mode.
[🔍 Navigating Between Modes](#)
2. Hold down (E) for at least two seconds.
 Release the button when the name of the currently selected Home City appears on the display.

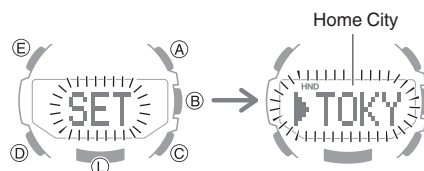

3. Press (E).
 This causes the seconds to flash.
4. Use (D) to display the setting you want to change.
 - Each press of (D) cycles through settings in the sequence shown below.

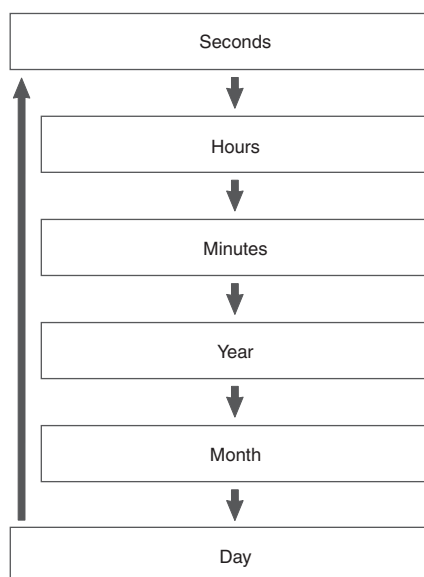

5. Configure the date and time settings.
 - While the seconds are flashing, pressing (C) will reset them to 00. 1 is added to the minutes when the current seconds count is between 30 and 59 seconds.
 - For all the other settings, use (C) and (A) to change the flashing setting.
6. Repeat steps 4 and 5 to configure time and date settings.
7. Press (E) to complete the setting operation.

● Switching between 12-hour and 24-hour Timekeeping

You can specify either 12-hour format or 24-hour format for the time display.

1. Enter the Timekeeping Mode.
[🔍 Navigating Between Modes](#)
2. Hold down (E) for at least two seconds.
 Release the button when the name of the currently selected Home City appears on the display.

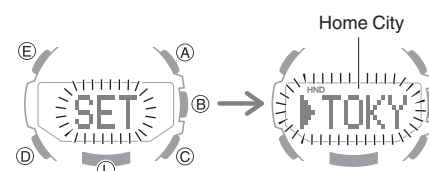

3. Press (D) four times.
 This causes [12H] or [24H] to flash on the display.



4. Press (C) to select [12H] (12-hour timekeeping) or [24H] (24-hour timekeeping).

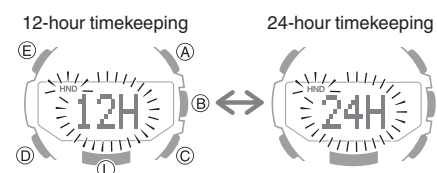

5. Press (E) twice to complete the setting operation.

Using the Watch in a Medical Facility or Aircraft

Whenever you are in a hospital, on an aircraft, or in any other location where connection with a phone may cause problems, you can perform the procedure below to disable auto time adjustment. To re-enable auto time adjustment, perform the same operation again.

1. Enter the Timekeeping Mode.
[🔍 Navigating Between Modes](#)
2. Hold down (E) for at least two seconds. Release the button when the name of the currently selected Home City appears on the display.

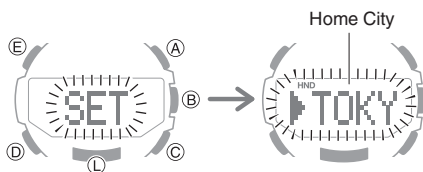

3. Press (D) five times.
 This displays [RCV].



4. Press (C) to change the auto time adjustment setting.
 [OFF]: Auto time adjustment disabled.
 [ON]: Auto time adjustment enabled.
5. Press (E) twice to complete the setting operation.

Note

- If the watch is paired with a phone, PRO TREK Connected can be used to disable auto time adjustment.
[🔍 Using PRO TREK Connected to Disable Auto Time Adjustment](#)

Using Mobile Link with a Mobile Phone

While there is a Bluetooth connection between the watch and phone, the watch time setting is adjusted automatically. You can also change the watch's other settings.

Note

- This function is available only while PRO TREK Connected is running on the phone.
- This section describes watch and phone operations.
 : Watch operation
 : Phone operation

Getting Ready

To use your watch in combination with a phone, you first need to pair them. Perform the steps below to pair the watch with a phone.

- ① **Install the required app on your phone.**

In Google Play or the App Store, search for the CASIO "PRO TREK Connected" app and install it on your phone.

- ② **Configure Bluetooth settings.**

Enable the phone's Bluetooth.

Note

- For details about setting procedures, see your phone documentation.

- ③ **Pair the watch with a phone.**

Before you can use the watch in combination with a phone, you first need to pair them.

1. Move the phone to be paired with close to (within one meter of) the watch.
2. Tap the "PRO TREK Connected" icon.

3. Perform the operation shown on the screen of the phone to be paired with.

- If a pairing prompt message appears, perform the operation shown on the phone screen.
- After pairing starts, the second hand will move to [R]. When pairing is complete, the second hand will move to [C].



- If pairing fails for some reason, the watch will return to the state in step 1 of this procedure. Perform the pairing procedure again from the beginning.

Note

- The first time you start up PRO TREK Connected, a message will appear on your phone asking if you want to enable location information acquisition. Configure settings to allow background use of location information.

Auto Time Adjustment

The watch will connect with a phone at preset times each day and adjust its time settings.

● Using Auto Adjust

Your watch adjusts its time setting four times a day according to a preset schedule. If you leave your watch in the Timekeeping Mode, it will perform the adjustment operation automatically as you go about your daily life, without any operation required by you.

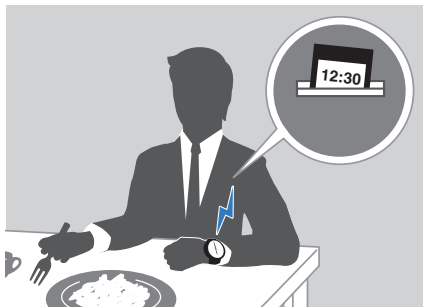

Important!

- The watch may not be able to perform auto time adjustment under the conditions described below.
 - While the watch is too far away from its paired phone
 - While communication is not possible due to radio interference, etc.
 - While the phone is updating its system
 - While PRO TREK Connected is not running on the phone

Note

- If the watch does not indicate the correct time even if it is able to connect with a phone, adjust the hand and day indicator alignment.
 - [Adjusting Hand Alignment](#)
- If there is a World Time City specified with PRO TREK Connected, its time will also be adjusted automatically.
- The watch will connect with the phone and perform auto time adjustment at around 12:30 a.m., 6:30 a.m., 12:30 p.m. and 6:30 p.m. The connection is automatically terminated after auto time adjustment is complete.

● Triggering Immediate Time Adjustment

The watch's time setting will be adjusted automatically whenever you establish a connection between the watch and a phone. Whenever you want to trigger immediate time adjustment, perform the procedure below to connect with a phone.

1. Move the phone close to (within one meter of) the watch.
2. Press (B).

[TIME] flashes to indicate that the watch has started the connection operation. When a connection is established between the watch and phone, [OK] will appear, time information will be acquired, and then the watch's time setting will be adjusted.

Trying to connect

After time adjustment

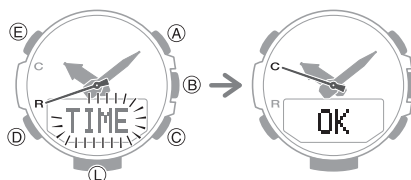

Note

- You can perform the above operation for time adjustment from any watch mode.
- The connection is terminated automatically after time adjustment is complete.
- If time adjustment fails for some reason, [ERR] will appear.

Mode Customization

You can use PRO TREK Connected to customize modes by rearranging them on the screen, and by deleting or adding modes.

○ [Navigating Between Modes](#)

Important!

- You cannot perform mode customization operations on the watch. Use PRO TREK Connected to configure settings.

The modes below can be rearranged or deleted.

- Altimeter Mode
- Thermometer Mode
- FISH Mode (FISH IN TIME, sunrise and sunset times, Moon age, tide)
- Stopwatch Mode
- Timer Mode
- Alarm Mode
- World Time Mode

1. Tap the "PRO TREK Connected" icon.
2. Hold down (B) for at least two seconds until the second hand points to [R] twice. When a connection is established between the watch and phone, [APP] will change to [OK], and the second hand will move from [R] to [C].

Trying to connect

Connection successful

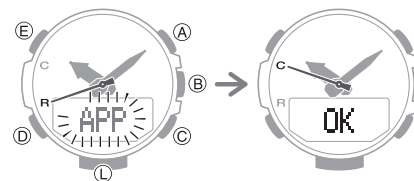

3. Perform the operations shown on the phone screen to configure mode settings.

Note

- Increasing or decreasing the number of modes may change mode functions and/or settings.
- Even if you delete the FISH Mode, you can still display sunrise and sunset times, Moon age, Tide Graph, and best FISH IN TIME on the Timekeeping Mode screen.

● To initialize Mode Customization

Important!

- Initializing Mode Customization also initializes watch settings.

1. Enter the Timekeeping Mode.
 [Navigating Between Modes](#)
2. Hold down (E) for at least two seconds. Release the button when the name of the currently selected Home City appears on the display.

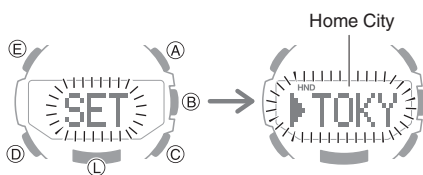

3. Press (E).
This causes the seconds to flash.

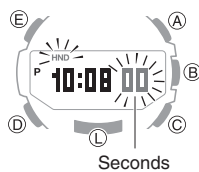

4. Hold down (A) for at least five seconds. Release when [RESET] stops flashing. This initializes Mode Customization.
5. Press (E) to complete the setting operation.

Customizing the Timekeeping Mode Screen

You can use PRO TREK Connected to rearrange display items on the Timekeeping Mode, and to add or remove items.

Important!

- Note that you cannot use watch operations to configure display item settings. Use PRO TREK Connected to configure settings.

The items below can be displayed.

- Day of the week, month, day



- Barometric pressure graph, month, day



- Hour, minute, second



- Step count

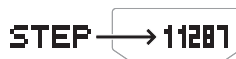

- Tide Graph



- Barometric Pressure Graph *



- World Time hour, minute *



- Sunrise and sunset times for a specified port (fishing point) *

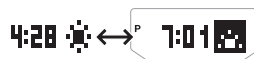

- FISH IN TIME



- Moon age *



* Item that can be added using PRO TREK Connected. These items are not displayed under initial default settings.

1. Tap the “PRO TREK Connected” icon.
2. Hold down (B) for at least two seconds until the second hand points to [R] twice.
When a connection is established between the watch and phone, [APP] will change to [OK], and the second hand will move from [R] to [C].

Trying to connect

Connection successful

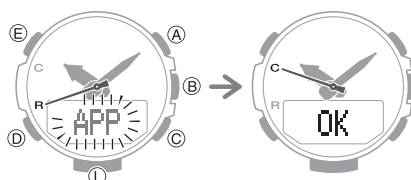

3. Perform the operations shown on the phone screen to configure mode settings.

Specifying a Port (Fishing Point)

After you use PRO TREK Connected to specify a port, you can use the watch to view the current time, best fishing times, sunrise and sunset times, Moon age, and the current tide level at the port.

Note

- You can use PRO TREK Connected to specify any one of 3,300 points around the world as the port.
- You can also use PRO TREK Connected to specify a port using a map.

1. Tap the “PRO TREK Connected” icon.
2. Hold down (B) for at least two seconds until the second hand points to [R] twice.
When a connection is established between the watch and phone, [APP] will change to [OK], and the second hand will move from [R] to [C].

Trying to connect

Connection successful

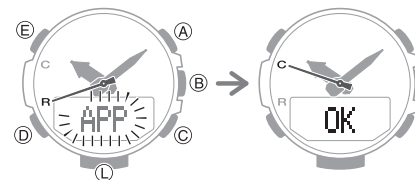

3. Perform the operation shown on the phone screen to specify a port.

Viewing Step Count Data

PRO TREK Connected can be used to view the information below, which is measured by the watch.

- Your step count and physical exertion over the past 24 hours
- Weekly number of steps, calories burned

1. Tap the “PRO TREK Connected” icon.
2. Hold down (B) for at least two seconds until the second hand points to [R] twice.

When a connection is established between the watch and phone, [APP] will change to [OK], and the second hand will move from [R] to [C].

Trying to connect

Connection successful

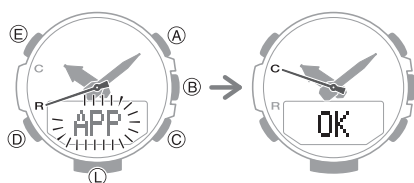

3. Follow the instructions on the screen to display pedometer data.

Note

- You can also use PRO TREK Connected to specify a daily step target.
- Though the step count is displayed on the watch in real time, PRO TREK Connected displays step counts at the time when a connection is established between the watch and phone. Because of this, the step counts displayed by PRO TREK Connected may be different from those displayed by the watch.

Recording Your Current Location (Location Memory)

You can use PRO TREK Connected to record current location information.

1. Tap the “PRO TREK Connected” icon.
2. Enter the Compass Mode.
[Navigating Between Modes](#)
3. Hold (A) for at least five seconds until [MEMORY] starts to flash. Release when the second hand points to [R] twice.

If location information is successfully acquired after a connection is established between the watch and phone, [MEMORY] will change to [OK], and the second hand will move from [R] to [C].

- [ERR] will appear on the display if connection fails for some reason.
- [FAILED]→[POSITION] will appear in sequence if location information acquisition fails for some reason.

Trying to connect

Connection successful

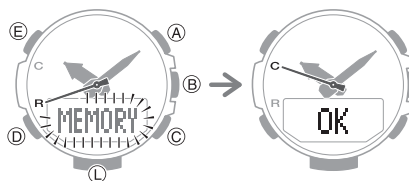

4. Perform the operation shown on the phone screen to view the Location Memory information record.
 - You can have only one location record in memory. Saving location information while there is already a location record in memory will overwrite the existing record with the new information.

Note

- If there is location information stored in Location Memory, you can use Location Indicator to check the distance and bearing to the stored location.
[Checking the Distance and Bearing to a Location Memory Point \(Location Indicator\)](#)

Checking the Distance and Bearing to a Location Memory Point (Location Indicator)

The watch acquires current location information from the phone, and then displays the bearing and distance from your current location to the location recorded in Location Memory.

1. [Recording Your Current Location \(Location Memory\)](#)

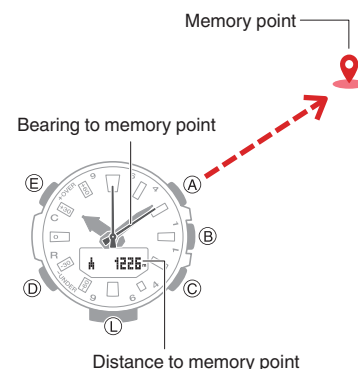

Important!

- Note that PRO TREK Connected operation is disabled while Location Indicator is in use.

1. Tap the “PRO TREK Connected” icon.
2. Enter the Compass Mode.
[Navigating Between Modes](#)

3. Hold down (A) for at least two seconds until [INDICATE] starts to flash. Release the button when the second hand moves to [R].

When a connection is established between the watch and phone and location information acquisition is successful, [INDICATE] will change to [OK], and the second hand will move from [R] to [C].

After two seconds the distance from your current location to the recorded location will appear on the display, and the second hand will indicate the bearing to the destination.

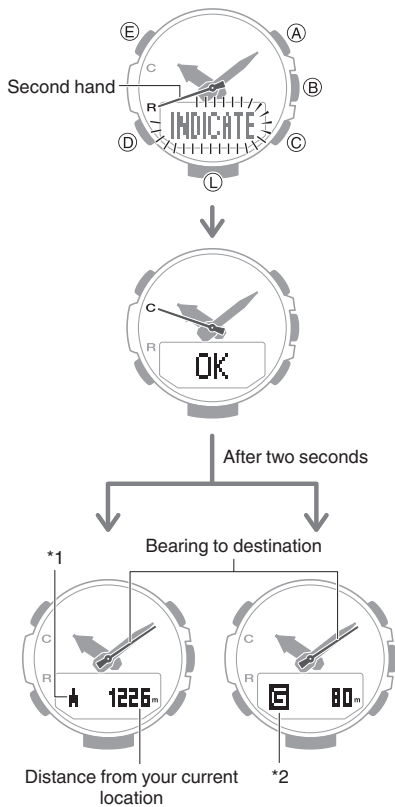

*1
When the second hand is within the range between 55 seconds to 05 seconds (indicating that you are within 30 degrees of the bearing to the destination), will be displayed as a light figure on a dark background.

*2
[G] is shown on the display when you are within 80 meters of the destination. [G] will disappear from the display if you move to a distance of 161 meters or more from the destination.

4. Check the display distance and the bearing to your destination on the display.

Note

- Location Indicator remains enabled for three minutes.
- The watch connects with the phone and acquires location information every 10 seconds or each time (B) is pressed, and uses the information to refresh the distance and the bearing to the point stored in Location Memory.
- Location Indicator will become disabled automatically about three minutes after it is enabled. You can also disable it manually by pressing any button besides (B) or (L).
- Pressing (B) or (L) while Location Indicator is enabled will cause it to remain enabled for three minutes after the button is pressed.
- Pressing (B) to update data causes TRY to appear on the display and remain displayed until data updating is complete.
- FAIL will appear on the display in the cases below.
 - When it has been 30 seconds or more since the last update and location information acquisition fails
 - When it has been 60 seconds or more since the last update
 - When data acquisition fails after you press (B)
- The display range for the distance to a destination is 0 to 99,999 meters (0 to 327,995 feet). ----- will be shown for the distance to the destination when it is outside the display range.
- [ERR] will appear on the display if connection fails for some reason.
- The message [NO-DATA] will appear when there is no data in Location Memory.
- [FAILED]→[POSITION] will appear in sequence if the first location information acquisition fails.
- or [G] will flash on the display if the watch detects abnormal magnetism while Location Indicator is in use.
- ERR will appear on the display if a direction sensor error occurs while Location Indicator is in use.

Auto Altitude Calibration

Enabling auto altitude calibration with PRO TREK Connected will cause altitude values to be acquired by PRO TREK Connected, which will be used to automatically correct the watch's altitude reading.

Important!

- Use PRO TREK Connected to enable or disable auto altitude calibration. It cannot be enabled or disabled on the watch.

Note

- If an altitude value acquired by PRO TREK Connected satisfies accuracy conditions, the watch will automatically correct its altitude reading.
- Auto altitude calibration is performed at the same time as auto time adjustment.
- Auto altitude calibration is not performed for 12 hours after the time setting is adjusted manually.

Configuring World Time Settings

Specifying a World Time City with PRO TREK Connected causes the watch's World Time City to change accordingly. The standard time/summer time setting of the World Time will be adjusted automatically without any watch operation required by you.

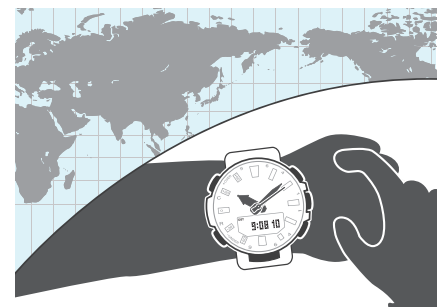

Note

- PRO TREK Connected World Time lets you select from among approximately 300 cities as the World Time City.

● Selecting a World Time City

1. Tap the “PRO TREK Connected” icon.
2. Hold down (B) for at least two seconds until the second hand points to [R] twice. When a connection is established between the watch and phone, [APP] will change to [OK], and the second hand will move from [R] to [C].
 - If connection fails for some reason, [ERR] will appear on the display momentarily and then the watch will return to the mode it was in before you started the connection procedure.

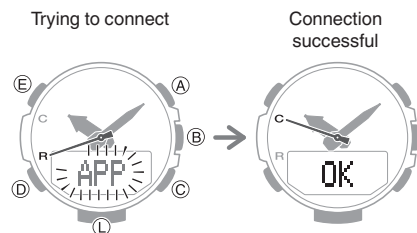

3. Perform the operation shown on the phone screen. The World Time setting will be reflected on the watch.

Note

- You can use PRO TREK Connected to configure settings for user cities that are not included in the watch’s built-in World Time Cities. You must use PRO TREK Connected to select a user city as your World Time City.

● Configuring the Summer Time Setting

1. Tap the “PRO TREK Connected” icon.
2. Hold down (B) for at least two seconds until the second hand points to [R] twice. When a connection is established between the watch and phone, [APP] will change to [OK], and the second hand will move from [R] to [C].
 - If connection fails for some reason, [ERR] will appear on the display momentarily and then the watch will return to the mode it was in before you started the connection procedure.

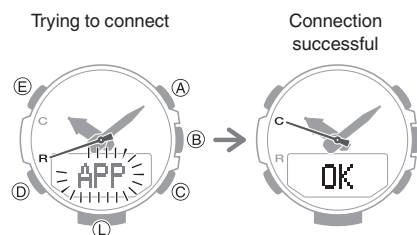

3. Perform the operation shown on the phone screen to select a summer time setting.
 - “Auto”
The watch switches between standard time and summer time automatically.
 - “OFF”
The watch always indicates standard time.
 - “ON”
The watch always indicates summer time.

Note

- While the summer time setting is “Auto”, the watch will switch between standard time and summer time automatically. You do not need to switch between standard time and summer time manually. Even if you are in an area that does not observe summer time, you can leave the watch’s summer time setting as “Auto”.
- For information about summer time periods, refer to the “Summer Time Table” or PRO TREK Connected.

● Swapping Your World Time and Home Time

1. Tap the “PRO TREK Connected” icon.
2. Hold down (B) for at least two seconds until the second hand points to [R] twice. When a connection is established between the watch and phone, [APP] will change to [OK], and the second hand will move from [R] to [C].
 - If connection fails for some reason, [ERR] will appear on the display momentarily and then the watch will return to the mode it was in before you started the connection procedure.

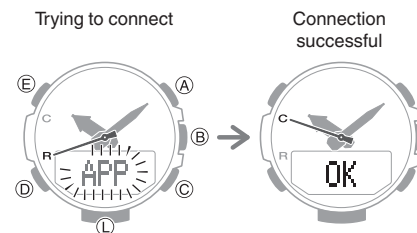

3. Perform the operation shown on the phone screen to swap your Home Time with your World Time.

Note

- The watch will not perform auto time adjustment for 24 hours after you swap your Home Time and World Time.

Adjusting Hand Alignment

If the hands are out of alignment even though auto time adjustment is being performed, use PRO TREK Connected to adjust them.

1. Tap the “PRO TREK Connected” icon.
2. Hold down (B) for at least two seconds until the second hand points to [R] twice. When a connection is established between the watch and phone, [APP] will change to [OK], and the second hand will move from [R] to [C].
 - If connection fails for some reason, [ERR] will appear on the display momentarily and then the watch will return to the mode it was in before you started the connection procedure.

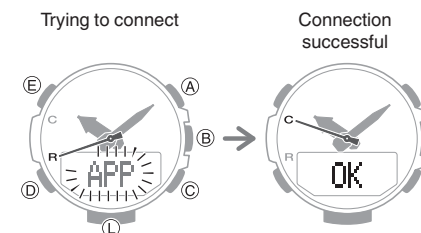

3. Perform the operation shown on the phone screen to correct hand alignment.

Phone Finder

You can use phone finder to trigger a tone on the phone to make it easy to find. The tone is forced to sound even if the phone is in vibrate mode.

Important!

- Do not use this function in areas where phone call tones are restricted.
- The tone sounds at a high volume. Do not use this function when listening to phone output over earphones.

1. If the watch is connected with a phone, press any button besides (L) to terminate the connection.

- After the connection is terminated, the watch will return to the mode it was in before connection was established.

Example: After connecting from the Timekeeping Mode

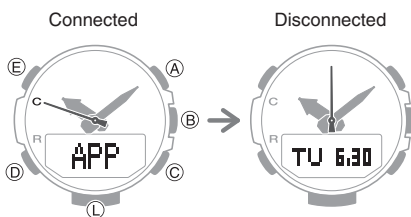

2. Hold down (B) for at least five seconds until the second hand points to [R] three times.

The phone will sound a tone when it establishes a connection with the watch.

- It will take a few seconds before the phone tone sounds.

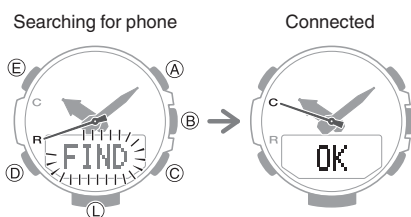

3. Press any button besides (L) to stop the tone.

- You can press any watch button to stop the phone tone only during the first 30 seconds after it starts to sound.

Configuring Watch Settings

You can use PRO TREK Connected to configure the settings below.

- Timer start time
- Alarms
- Digital Compass
- Altimeter
- Barometer
- FISH Mode

1. Tap the "PRO TREK Connected" icon.
2. Hold down (B) for at least two seconds until the second hand points to [R] twice.

When a connection is established between the watch and phone, [APP] will change to [OK], and the second hand will move from [R] to [C].

- If connection fails for some reason, [ERR] will appear on the display momentarily and then the watch will return to the mode it was in before you started the connection procedure.

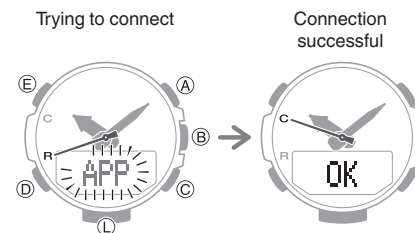

3. Select the setting you want to change and then perform the operation shown on the phone screen.

Changing the Home City Summer Time Setting

1. Tap the "PRO TREK Connected" icon.
2. Hold down (B) for at least two seconds until the second hand points to [R] twice.

When a connection is established between the watch and phone, [APP] will change to [OK], and the second hand will move from [R] to [C].

- If connection fails for some reason, [ERR] will appear on the display momentarily and then the watch will return to the mode it was in before you started the connection procedure.

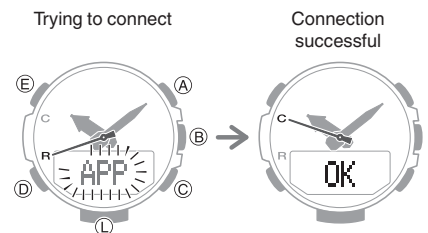

3. Perform the operation shown on the phone screen to change your Home City summer time setting.

Connection

Connecting with a Phone

This section explains how to establish a Bluetooth connection with a phone that is paired with the watch.

- If the watch is not paired with the phone you want to connect with, refer to the information below and pair them.

③ Pair the watch with a phone.

1. Move the phone close to (within one meter of) the watch.

2. Hold down (B) for at least two seconds until the second hand points to [R] twice.

When a connection is established between the watch and phone, [APP] will change to [OK], and the second hand will move from [R] to [C].

- If connection fails for some reason, [ERR] will appear on the display momentarily and then the watch will return to the mode it was in before you started the connection procedure.

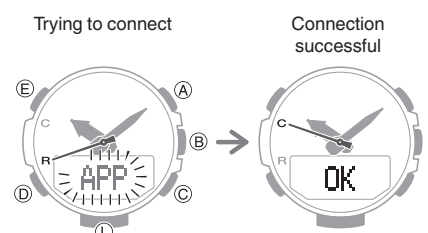

Important!

- If you have problems establishing a connection, it could mean that PRO TREK Connected is not running on the phone. On the phone's Home Screen, tap the "PRO TREK Connected" icon. After the app starts up, hold down the watch's (B) button for at least two seconds.

Note

- The connection will be terminated if you do not perform any operation on the watch or phone for a fixed amount of time. To specify the connection limit time, perform the following operation with PRO TREK Connected: "Watch settings" → "Connection time". Next, select a setting of 3 minutes, 5 minutes, or 10 minutes.

Disconnecting from a Phone

To terminate a Bluetooth connection, press any watch button besides (L).

- After the connection is terminated, the watch will return to the mode it was in before connection was established.

Example: After connecting from the Timekeeping Mode

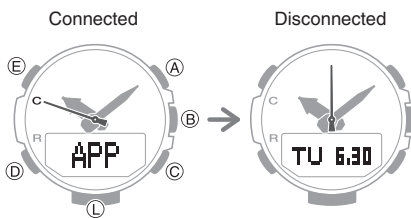

Using the Watch in a Medical Facility or Aircraft

Whenever you are in a hospital, on an aircraft, or in any other location where connection with a phone may cause problems, you can perform the procedure below to disable auto time adjustment. To re-enable auto time adjustment, perform the same operation again.

1. Tap the "PRO TREK Connected" icon.
2. Hold down (B) for at least two seconds until the second hand points to [R] twice.

When a connection is established between the watch and phone, [APP] will change to [OK], and the second hand will move from [R] to [C].

- If connection fails for some reason, [ERR] will appear on the display momentarily and then the watch will return to the mode it was in before you started the connection procedure.

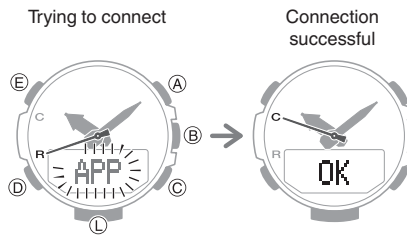

3. Perform the operation shown on the phone screen to enable or disable auto time adjustment.

Unpairing

Unpairing the watch from a phone requires both PRO TREK Connected and watch operations.

Deleting Pairing Information from PRO TREK Connected

1. If the watch is connected with a phone, press any button besides (L) to terminate the connection.
 - After the connection is terminated, the watch will return to the mode it was in before connection was established.

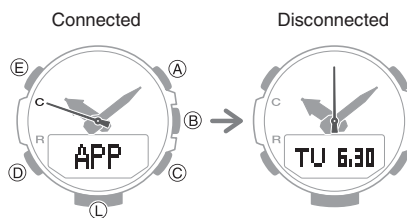

2. Tap the "PRO TREK Connected" icon.
3. Perform the operation shown on the phone screen to unpair.

Deleting Pairing Information from the Watch

1. Hold down (D) for at least two seconds to enter the Timekeeping Mode.
2. Hold down (E) for at least two seconds. Release the button when the name of the currently selected Home City appears on the display.

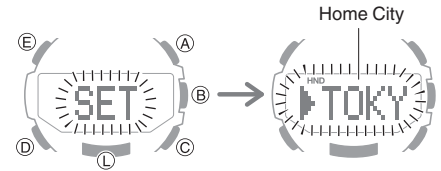

3. Press (E).

This causes the seconds to flash.

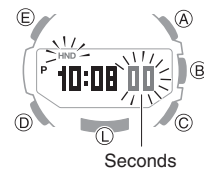

4. Hold down (A) for at least two seconds. Release when [PAIR CLR] stops flashing. This deletes the pairing information from the watch.



5. Press (E) to return to the Timekeeping Mode.

If you purchase another phone

You need to perform the pairing operation whenever you want to establish a Bluetooth connection with a phone for the first time.

3. Pair the watch with a phone.

Digital Compass

You can use the Digital Compass Mode to determine the direction of north, and to check your bearing to a destination.



Important!

- Check the information at the link below to find out how to ensure correct readings.
 - 🔗 [Calibrating Compass Readings](#)
 - 🔗 [Digital Compass Reading Precautions](#)

Taking a Compass Reading

1. Enter the Compass Mode.
 - 🔗 [Navigating Between Modes](#)
 - Entering the Compass Mode starts compass readings.
2. Keeping the watch level, point 12 o'clock in the direction of your desired objective.
 - The second hand will point North. The digital display will show one of 16 literal direction indications or the bearing angle.
 - You can toggle between literal direction indications and bearing angle display by pressing (E).
 - To retrigger the compass operation, press (A).

Interpreting Bearing Readings

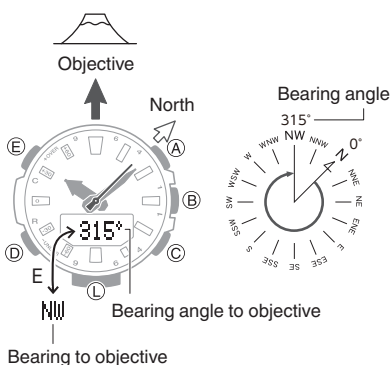

Directions: N (North), E (East), W (West), S (South)

Note

- Normally the Compass Mode indicates magnetic north. You can also configure settings to indicate true north.
 - 🔗 [Setting Up for True North Readings \(Magnetic Declination Calibration\)](#)
 - 🔗 [Magnetic North and True North](#)
- After the initial reading is displayed, the watch will continue to take readings about every second for about the next 60 seconds. The watch will return to the Timekeeping Mode automatically about 60 seconds after you press (A).
- Auto Light will not illuminate the face while a compass operation is in progress.
- If an alarm or other beeper sounds, or if you turn on illumination by pressing (L) while a compass operation is in progress, the compass operation will be suspended momentarily. The compass operation will resume when the beeper stops or illumination turns off.
- You can use PRO TREK Connected to record location information and then use the watch to display the distance and bearing to the recorded location.
 - 🔗 [Recording Your Current Location \(Location Memory\)](#)
 - 🔗 [Checking the Distance and Bearing to a Location Memory Point \(Location Indicator\)](#)

● Aligning a Map with Actual Surroundings (Setting a Map)

Setting a map means to align the map so the directions indicated on it are aligned with the actual directions of your location. Once you set a map, you can more easily get a grasp of the relationship between map markings and actual geographic contours. To set a map with this watch, align north on the map with the north indication of the watch. Once you set the map, you can compare your bearing on the map with your surroundings, which will help you determine your current location and destination.

- Note that map reading skills and experience are required to determine your current location and destination on a map.

Calibrating Compass Readings

Calibrating Compass Readings

Perform figure 8 or two-point calibration whenever you notice the watch's compass readings are different from those of another compass, or before setting out on a climb or trek.

- Note that accurate compass readings and/or calibration will not be possible in an area where strong magnetism is present.
 - 🔗 [Digital Compass Reading Precautions](#)

Figure 8 calibration

1. Enter the Compass Mode.
 - 🔗 [Navigating Between Modes](#)
2. Hold down (E) for at least two seconds. Release the button when [SET] starts flashing and then ∞ appears on the display.

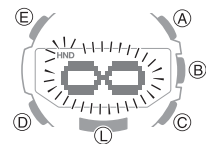

3. Press (A).
 - Move your arm in a figure 8 pattern as shown in the illustrations below.

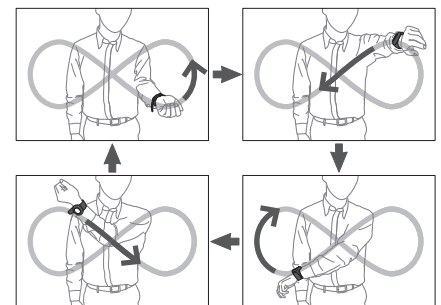

- Allow your wrist to twist.
- Keep your arm as far as possible from your body as you move it.
- The ∞ symbol will stop flashing on the display while calibration is in progress.
- When calibration is successful, [OK] will appear on the display and the watch will return to the Digital Compass screen. This completes the calibration operation.

Note

- If [ERR] is displayed, press any button besides (E) and then perform this procedure again from step 3.

2-Point Calibration

1. Enter the Compass Mode.
[🔗 Navigating Between Modes](#)
2. Hold down (E) for at least two seconds. Release the button when [SET] starts flashing and then ∞ appears on the display.

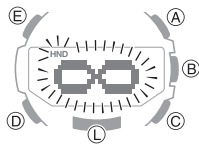

3. Press (D).
 This causes [↑ 1] to appear on the display.

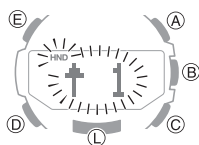

4. While keeping the watch horizontal, press (A).
 This starts calibration of the first point, which causes [WAIT] to appear on the display. When calibration is successful, indicators will appear on the display in the following sequence: [OK] → [TURN] → [180°] → [↓ 2].
5. Rotate the watch 180 degrees, taking care to be as exact as possible.

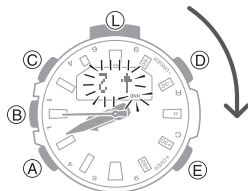

6. Press (A).
 - This starts calibration of the second point, which causes [WAIT] to appear on the display.
 - When calibration is successful, [OK] will appear on the display and the watch will return to the Digital Compass screen. This completes the calibration operation.

Note

- [ERR] will appear if calibration fails for some reason. If this happens, restart the above procedure from step 2.

Auto Calibration

Your watch performs auto bearing calibration.

- When bearing calibration starts, the second hand will move to 12 o'clock, and the digital display contents will flash.

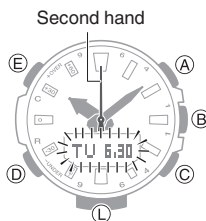

Note

- Auto bearing calibration is performed when the conditions below exist.
 - Watch is worn on the wrist.
 - Watch is in the Timekeeping Mode.
 - You are walking
- After calibration is successful, auto calibration will not be performed again for 24 hours.

Setting Up for True North Readings (Magnetic Declination Calibration)

If you want the watch to indicate true north instead of magnetic north, you need to specify your current location's magnetic declination direction (east or west) and declination angle.

🔗 Magnetic North and True North

- The magnetic declination angle value can be set in 1° (degree) units only. Use a value that is closest to the angle you want to set. Example: For an angle of 7.4°, set 7°. Example: For an angle of 7°40' (7 degrees, 40 minutes), set 8°.

Note

- Magnetic declination angles (east or west) and angle degree values for specific locations can be found on geographic maps, mountain climbing maps, and other maps that include contour lines.

1. Enter the Compass Mode.
[🔗 Navigating Between Modes](#)
2. Hold down (E) for at least two seconds. Release the button when [SET] starts flashing and then ∞ appears on the display.

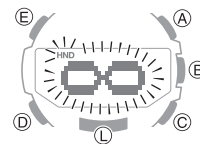

3. Press (D).
 [DEC] will appear on the display, followed by [0°].

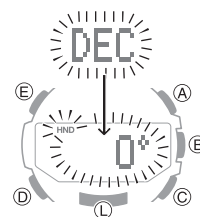

4. Use (C) (East) and (A) (West) to change the magnetic declination direction and angle.

Setting range: 90° west to 90° east

[0° (OFF)]: Magnetic north

[E]: East declination (Magnetic north is east of true north.)

[W]: West declination (Magnetic north is west of true north.)

- To return the setting to [0° (OFF)], press (A) and (C) at the same time.

Magnetic declination direction

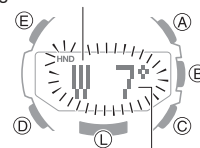

Magnetic declination angle

5. Press (E) to complete the setting operation.

Magnetic North and True North

There are actually two types of north: magnetic north and true north.

Magnetic north: North indicated by the needle of a compass

True north: Direction to the North Pole

As shown in the illustration below, magnetic north and true north are not the same.

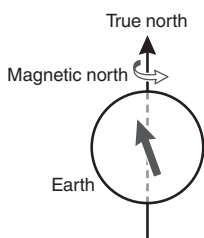

Note

- The north indicated on commercially available maps is normally true north.

Digital Compass Reading Precautions

Location During Use

Taking readings near sources of strong magnetism can cause reading error. Keep the watch away from the following types of items.

Permanent magnets (magnetic accessories, etc.), metal objects, high-voltage wires, aerial wires, electrical household appliances (TVs, computers, cellphones, etc.)

- Note that correct direction readings are not possible indoors, especially inside of reinforced concrete structures.
- Accurate direction readings are not possible in motor vehicles, on boats, on aircraft, etc.

Storage Location

Exposure of the watch to magnetism can affect the accuracy of digital compass readings. Keep the watch away from the types of items below.

Permanent magnets (magnetic accessories, etc.), metal objects, electrical household appliances (TVs, computers, cellphones, etc.)

Altitude Measurement

The watch takes altitude readings and displays results based on air pressure measurements taken by a built-in pressure sensor.

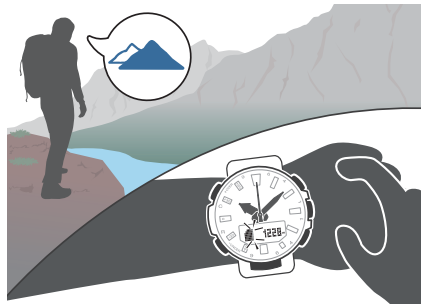

Important!

- The altitude readings displayed by the watch are relative values that are calculated based on barometric pressure measured by the watch's pressure sensor. This means that barometric pressure changes due to weather can cause altitude readings taken at the same location to be different. Also note that the value displayed by the watch may be different from the actual elevation and/or sea level elevation indicated for the area where you are located. When using the watch's altimeter while mountain climbing, it is recommended that you regularly calibrate its readings in accordance with local altitude (elevation) indications.

[Calibrating Altitude Readings \(Offset\)](#)

- The altitude correction value you specify and/or barometric pressure changes may cause a negative value to be displayed.
- Check the information at the link below to find out about how to minimize differences between readings produced by the watch, and values provided by local altitude (elevation) indications.

[Altitude Reading Precautions](#)

Checking the Current Altitude

- Enter the Altimeter Mode.

[Navigating Between Modes](#)

Entering the Altitude Mode will start altitude measurement and display the altitude at your current location.

- You can navigate between display screens by pressing (E).

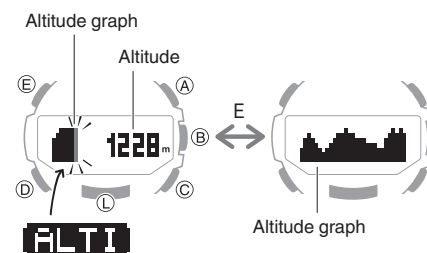

- The watch takes altitude readings every second for about the first three minutes. After that, it takes readings according to the watch's auto measurement interval setting.
- Check the information at the link below to find out how to configure the auto measurement interval. [Setting the Auto Measurement Interval](#)
- To retrigger measurement, press (C).
- To return to the Timekeeping Mode, hold down (D) for at least two seconds.

Note

- When you enter the Altitude Mode, the second hand will indicate either timekeeping seconds, or the differential between altitude measurements (whichever was indicated the last time you were in the Altitude Mode). You can change what information is indicated by the second hand. [Checking the Altitude Differential from a Reference Point](#)
- Measurement range: -700 to 10,000 meters (-2,300 to 32,800 feet) (Measurement unit: 1 meter (5 feet)) Note that calibrating altitude readings will cause a change in the measurement range.
- [--] will appear for the measured value if it is outside the allowable range.

Interpreting Altitude Graph Contents

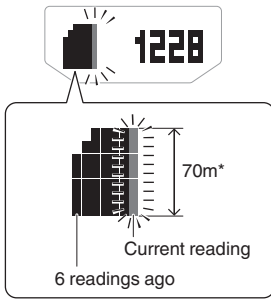

Calibrating Altitude Readings (Offset)

To minimize the difference between locally indicated and measured values, you should update the reference altitude value (offset) before setting off and during treks or any other activities where you take altitude readings.

Also, you can ensure accurate measurements by checking a map local altitude indications or some other source for your current location's altitude, and regularly calibrating watch readings with the latest information while mountain climbing.

Note

- You can find out the altitude at your current location from signs, maps, on the Internet, etc.
- Differences between actual altitude and watch readings can be caused by the factors below.
 - Changes in barometric pressure
 - Changes in temperature caused by variations in barometric pressure and by elevation
- Though altitude readings can be taken without calibration, doing so may produce readings that are very different from indications by altitude markers, etc.

- Enter the Altimeter Mode.
[🔍 Navigating Between Modes](#)
- Hold down (E) for at least two seconds. Keep the button depressed when [SET] starts to flash. Release the button when [SET] disappears from the display.
 This displays the current altitude and enters the Altitude Offset Mode.

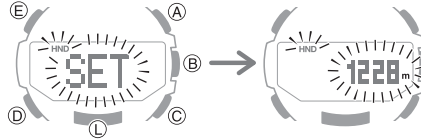

- Use (A) and (C) to change the altitude value to an elevation value obtained from another source.
 Setting range: -3,000 to 10,000 meters
 Setting unit: 1 meter
 - To return the altitude setting to its initial factory default, press (A) and (C) at the same time.
- Press (E) to complete the setting operation.

Checking the Altitude Differential from a Reference Point

After you set a reference altitude, the second hand of the watch will indicate the difference between your current altitude and the reference altitude. This makes it easy to measure the altitude difference between two points while climbing or trekking.

● Changing the Information Indicated by the Second Hand

- Enter the Altimeter Mode.
[🔍 Navigating Between Modes](#)
- Hold down (E) for at least two seconds. Keep the button depressed when [SET] starts to flash. Release the button when [SET] disappears from the display.
 This displays the altitude for your current location.

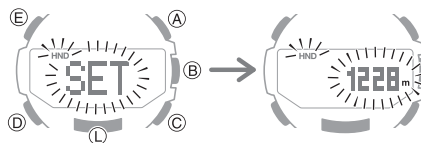

- Press (D) three times.
 This causes the display to show [HAND] → [DIFF] or [SEC].

- Use (C) to select [DIFF].
 Each press of (C) cycles through the settings shown below.
 [DIFF]: Second hand indicates altitude differential.
 [SEC]: Second hand indicates the current time seconds.
- Press (E) to complete the setting operation.

● Setting the Altitude Differential Measurement Range

- Enter the Altimeter Mode.
[🔍 Navigating Between Modes](#)
- Hold down (E) for at least two seconds. Keep the button depressed when [SET] starts to flash. Release the button when [SET] disappears from the display.
 This displays the altitude for your current location.

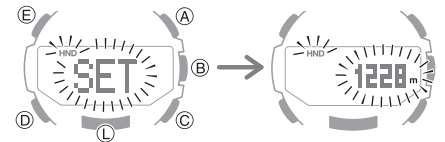

- Press (D) twice.
 This displays the altitude differential measurement range.

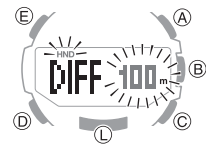

- Press (C) to select [100m] or [1000m].
 [100m]: ±100 meters (±328 feet) in 5-meter (16-foot) units
 [1000m]: ±1000 meters (±3280 feet) in 50-meter (164-foot) units
- Press (E) to complete the setting operation.

● Measuring Altitude

- Use the contour lines on your map to determine the altitude differential between your current location and your destination.
- Change the information indicated by the second hand to [DIFF].
[🔍 Changing the Information Indicated by the Second Hand](#)
- Take an altitude reading of your current location.
[🔍 Checking the Current Altitude](#)

- Hold down (L) for at least two seconds to set your current location's altitude as the reference altitude.

This causes [DIFF CLR] to stop flashing and displays the altitude at your current location.

- The second hand (Altitude Differential Indicator) will indicate the difference between the reference altitude and the current altitude reading. At this time the second hand should indicate ± 0 m (± 0 feet).

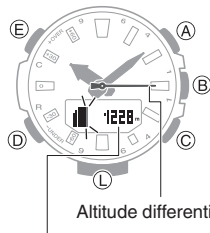

Altitude differential indicator
Current location altitude

- While comparing the difference between the altitude you found on the map and the altitude differential indicated by the watch's second hand, advance towards your destination.

- When the altitude differential you found on the map is the same as that indicated by the second hand, it means you are close to your destination.

Example: Altitude differential of -30 m (-98 feet) (-300 m (-984 feet))

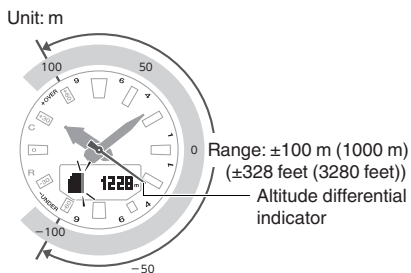

Note

- If the altitude differential is outside of the specified range, the second hand will indicate [OVER] or [UNDER]. If either of these is indicated while using the ± 100 m (328 feet) measurement range, change the range setting to ± 1000 m (3280 feet).
- The second hand will move to 9 o'clock if a reading is outside the allowable altitude measurement range (-700 m to 10,000 m (-2,300 to 32,800 feet)), or if a reading error occurs.

Setting the Auto Measurement Interval

You can select an auto measurement interval of either five seconds or two minutes.

- Enter the Altimeter Mode.
[Navigating Between Modes](#)

- Hold down (E) for at least two seconds. Keep the button depressed when [SET] starts to flash. Release the button when [SET] disappears from the display.

This displays the altitude for your current location.

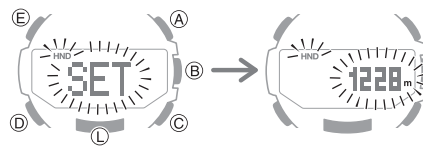

- Press (D).

This causes the auto measurement interval to appear on the display.



- Press (C) to toggle the auto measurement interval between [0'05] and [2'00].

[0'05]: Readings taken every second for the first three minutes, and then every five seconds for about the next one hour.

[2'00]: Readings taken every second for the first three minutes, and then every two minutes for about the next 12 hours.

- Press (E) to complete the setting operation.

Note

- The watch will automatically return to the Timekeeping Mode if you do not perform any operation in the Altimeter Mode for about one hour while [0'05] is selected as the measurement interval or about 12 hours while [2'00] is selected.

Specifying the Altitude Measurement Unit

You can select either meters (m) or feet (ft) as the Altimeter Mode display unit.

Important!

- When Tokyo (TOKYO) is set as the Home City, the altitude unit is fixed as meters (m) and cannot be changed.

- Enter the Timekeeping Mode.
[Navigating Between Modes](#)

- Hold down (E) for at least two seconds. Release the button when the name of the currently selected Home City appears on the display.

Example: When your Home City is Los Angeles

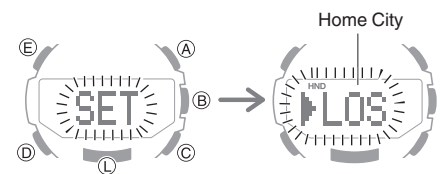

- Press (D) seven times.

This causes [UNIT] to appear, with [m] or [ft] flashing.



- Use (C) to select an altitude unit.

[m]: Meters

[ft]: Feet

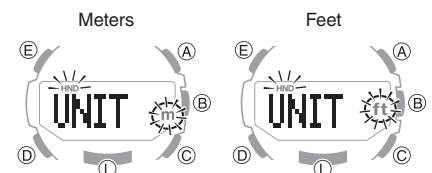

- Press (E) twice to complete the setting operation.

Altitude Reading Precautions

Effects of Temperature

When taking altitude readings, take the steps below to keep the watch at as stable a temperature as possible. Changes in temperature can affect altitude readings.

- Take readings with the watch on your wrist.
- Take readings in an area where temperature is stable.

Altitude Readings

- Do not use this watch while skydiving, hang gliding, paragliding, gyrocopter flying, glider flying, or engaged in other activities where altitude changes suddenly.
- Altitude readings produced by this watch are not intended for special-purpose or industrial level use.
- In an aircraft, the watch measures the in-cabin pressurized air pressure, so readings will not match altitudes announced by the crew.

Altitude Readings (Relative Altitude)

This watch uses International Standard Atmosphere (ISA) relative altitude data defined by the International Civil Aviation Organization (ICAO). Barometric pressure generally becomes lower as altitude increases.

Correct measurement may not be possible under the conditions below.

- During unstable atmospheric conditions
- During sudden temperature changes
- After the watch has been subjected to strong impact

Barometric Pressure Measurement

You can use the Barometer Mode to take a reading of the barometric pressure at your current location, and to track reading changes and trends.

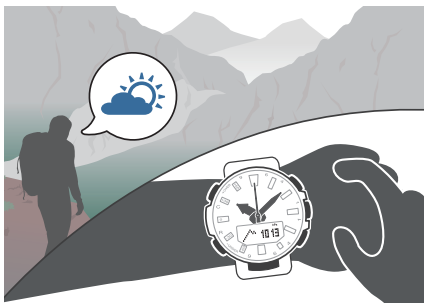

Important!

- Check the information at the link below to find out how to ensure correct readings.
[Barometric Pressure Reading Precautions](#)

Checking the Current Barometric Pressure

1. Enter the Barometer Mode.

🔗 Navigating Between Modes

Entering the Barometer Mode starts measurement, and displays the barometric pressure at your current location and a barometric pressure graph.

- After you enter the Barometer Mode, the watch takes readings about every five seconds for three minutes. After that, a measurement is taken about every two minutes or every five seconds.

You can change the measurement interval, if you want.

🔗 Changing the Measurement Interval of the Barometric Pressure Graph



- You can navigate between display screens by pressing (E).

🔗 Checking Changes in Barometric Pressure Over Time

Barometric pressure graph

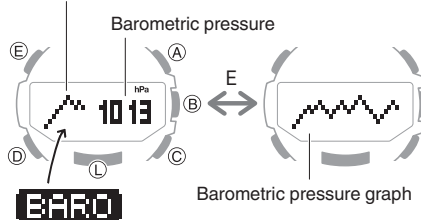

- To retrigger measurement, press (C).
- To return to the Timekeeping Mode, hold down (D) for at least two seconds.

Note

- When you enter the Barometer Mode, the second hand will indicate either timekeeping seconds, or the differential between barometer measurements (whichever was indicated the last time you were in the Barometer Mode). You can change what information is indicated by the second hand.

🔗 Checking the Change in Barometric Pressure between Two Readings

- The watch will automatically return to the Timekeeping Mode from the Barometer mode if you do not perform any operation for about one hour.
- The measurement range is 260 hPa to 1,100 hPa (7.65 inHg to 32.45 inHg) (1 hPa (0.05 inHg) units). [- -] will appear for the measured value if it is outside the allowable range.

Checking Changes in Barometric Pressure Over Time

The watch can be configured to show a graph of pressure readings taken every two hours or every two minutes.

You can display a graph of barometric pressure readings for the past 20 hours or the past 20 minutes. The square (■) at the far right of the graph indicates the latest barometric pressure reading.

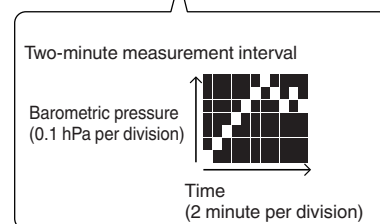
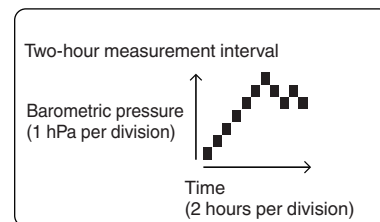

● Changing the Measurement Interval of the Barometric Pressure Graph

You can select a measurement interval of two hours or two minutes for the barometric pressure graph.

1. Enter the Barometer Mode.
[🔗 Navigating Between Modes](#)

2. Hold down (E) for at least two seconds. Keep the button depressed when [SET] starts to flash. Release the button when [SET] disappears from the display.

This displays the current barometric pressure and enters the Barometric Pressure Offset Mode.

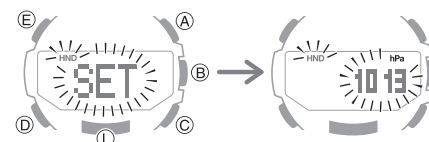

3. Press (D) twice.

4. Use (C) to change the measurement interval.

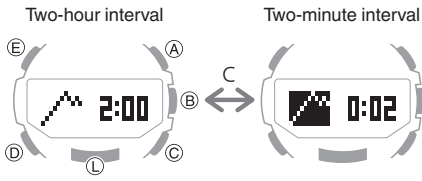

- When the measurement interval of the barometric pressure graph is two hours, measurements are taken every two minutes.
- When the measurement interval of the barometric pressure graph is two minutes, measurements are taken every five seconds.

5. Press (E) to complete the setting operation.

Note

- If you switch to the two-minute measurement interval graph, the watch will automatically return to the two-hour measurement interval graph after 24 hours.
- Note that the graph will not be displayed immediately after it is switched to a two-minute measurement interval graph.

● **Predicting Upcoming Weather**

A trend like this:	Means this:
	Rising barometric pressure, which indicates that upcoming weather probably will be fair.
	Falling barometric pressure, which indicates that upcoming weather probably will be bad.

Note

- Large changes in barometric pressure and/or temperature can cause past data readings to be plotted outside of the visible area of the graph. Though plots are not visible, the data is still maintained in watch memory.
 - The barometric pressure graph is not displayed while Barometric Pressure Change Indications are displayed.
- [Sudden Barometric Pressure Change Indications](#)

Checking the Change in Barometric Pressure between Two Readings

When you perform the procedure below in the Barometer Mode, the second hand will indicate the difference between the current barometric pressure measurement and the last auto measurement value (taken at two-hour or two-minute intervals).

1. Enter the Barometer Mode.
[Navigating Between Modes](#)
2. Hold down (E) for at least two seconds. Keep the button depressed when [SET] starts to flash. Release the button when [SET] disappears from the display. This displays the current barometric pressure and enters the Barometric Pressure Offset Mode.

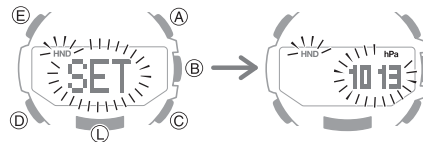

3. Press (D).
This causes the display to show [HAND] → [DIFF] or [SEC].
4. Use (C) to select [DIFF].
Each press of (C) cycles through the settings shown below.
[DIFF]: Second hand indicates barometric pressure (Barometric Pressure Differential Indicator)
[SEC]: Second hand indicates the current time seconds.
Example: Barometric pressure differential of -3 hPa (two-hour measurement interval)

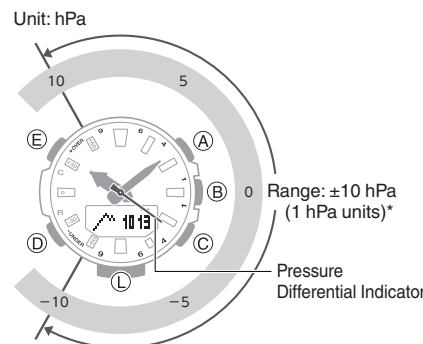

- * Two-hour Measurement Interval: ±10 hPa (1 hPa units)
- Two-minute Measurement Interval: ±1 hPa (0.1 hPa units)

5. Press (E) to complete the setting operation.

Note

- If the barometric pressure differential is greater than +10 hPa (when the measurement interval is two hours) or +1 hPa (when the measurement interval is two minutes), the second hand will point to [OVER]. If it is less than -10 hPa (when the measurement interval is two hours) or -1 hPa (when the measurement interval is two minutes), the second hand will point to [UNDER].
- A reading that is outside the allowable measurement range of 260 hPa to 1,100 hPa (7.65 inHg to 32.45 inHg), or any measurement error will cause the second hand to move to 9 o'clock.

Sudden Barometric Pressure Change Indications

Whenever the watch detects a significant change in air pressure readings (due to sudden ascent or descent, or to the passage of a low pressure or high pressure area), it will beep to let you know. An arrow will also flash on the display at this time if the watch is in the Barometer Mode, or if it is in the Timekeeping Mode with the barometric pressure graph displayed. The arrow that appears shows the direction of the pressure change. These alerts are called “Barometric Pressure Change Indications”.

This indicator:	Means this:
	Sudden drop in pressure
	Sudden rise in pressure
	Sustained rise in pressure, shifting to a fall
	Sustained fall in pressure, shifting to a rise

Important!

- To ensure correct barometric pressure change indicator operation, enable it in a location where the altitude is constant (such as a lodge, camp area, or on the ocean).
- A change in altitude causes a change in air pressure. Because of this, correct readings are impossible. Do not take readings while ascending or descending a mountain, etc.

- Enter the Barometer Mode.
[Navigating Between Modes](#)

- Hold down (C) for at least two seconds.
If this turns on barometric pressure change indication, [INFO ON] will stop flashing and then the [BARO] indicator will appear on the display.

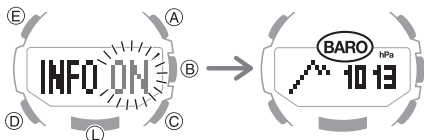

- To disable barometric pressure change indication, hold down (C) again for at least two seconds.

Note

- If Barometric Pressure Change Indications are on, barometric pressure readings are taken every two minutes even while the watch is not in the Barometer Mode.
- The barometric pressure change indicator becomes disabled automatically 24 hours after it is enabled.
- You will not be able to turn on barometric pressure change indication if the watch's battery level is low.
- Low battery power will also cause barometric pressure change indication to turn off automatically.

Calibrating Barometric Pressure Readings (Offset)

The watch's pressure sensor is adjusted at the factory and normally does not require calibration. However, you can calibrate the displayed value if you notice major errors in readings.

Important!

- The watch will not be able to produce correct barometric pressure readings if you make a mistake during the calibration procedure. Check to make sure that the value you use for calibration produces correct pressure readings.

- Enter the Barometer Mode.
[Navigating Between Modes](#)

- Hold down (E) for at least two seconds. Keep the button depressed when [SET] starts to flash. Release the button when [SET] disappears from the display.
This displays the current barometric pressure and enters the Barometric Pressure Offset Mode.

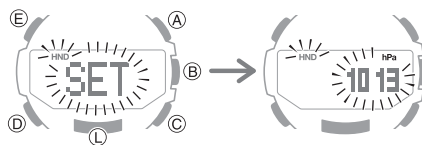

- Use (A) and (C) to change the value.
Setting range: 260 to 1,100 hPa
Setting unit: 1 hPa
 - To return the barometric pressure setting to its initial factory default, press (A) and (C) at the same time.
- Press (E) to complete the setting operation.

Specifying the Barometric Pressure Unit

You can specify either hectopascals (hPa) or inches of mercury (inHg) as the display unit for barometric pressure values.

Important!

- When Tokyo (TOKYO) is the Home City, the altitude unit is fixed as hectopascals (hPa) and cannot be changed.

- Enter the Timekeeping Mode.
[Navigating Between Modes](#)
- Hold down (E) for at least two seconds. Release the button when the name of the currently selected Home City appears on the display.
Example: When your Home City is Los Angeles

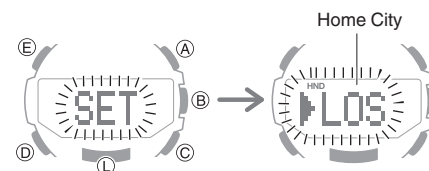

- Press (D) eight times.
This causes [UNIT] to appear, with [hPa] or [inHg] flashing.

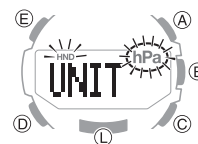

- Use (C) to select a barometric pressure unit.

[hPa]: Hectopascals

[inHg]: Inches of mercury

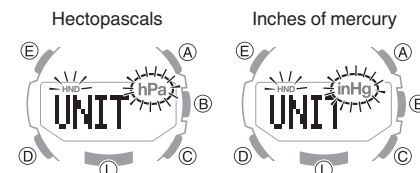

- Press (E) twice to complete the setting operation.

Barometric Pressure Reading Precautions

- The barometric pressure graph produced by this watch can be used to obtain an idea of upcoming weather conditions. However, this watch should not be used in place of precision instruments required for official weather prediction and reporting.
- Pressure sensor readings can be affected by sudden changes in temperature. Because of this, there may be some error in the readings produced by the watch.

Temperature Measurement

The watch can be used to take current air temperature readings.

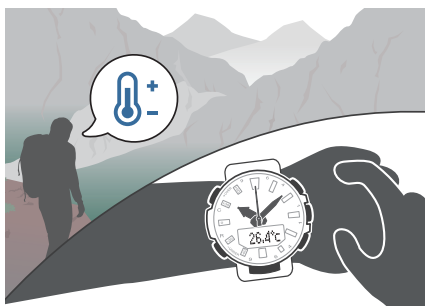

Important!

- Check the information at the link below to find out how to ensure correct readings.

[Temperature Reading Precautions](#)

Checking the Current Temperature

1. Enter the Temperature Mode.

[Navigating Between Modes](#)

Entering the Temperature Mode will start temperature measurement and display the result.

- After you enter the Temperature Mode, the watch takes readings about every five seconds for three minutes. After that, a measurement is taken about every two minutes.
- To retrigger measurement, press (C).



Note

- The watch will automatically return to the Timekeeping Mode if you do not perform any operation in the Temperature Mode for about one hour.
- The measuring range is -10.0 °C to 60.0 °C (14.0 °F to 140.0 °F) (0.1 °C (0.2 °F) units). [- - .-] will appear for the measured value if it is outside the allowable range.
- To return to the Timekeeping Mode, hold down (D) for at least two seconds.

Calibrating Temperature Readings (Offset)

The watch's temperature sensor is adjusted at the factory and normally does not require calibration. However, you can calibrate the displayed value if you notice major errors in readings.

Important!

- Check to make sure that the value you use for calibration produces correct temperature readings.
- Before calibrating the temperature reading, remove the watch from your wrist and leave it in the area where you plan to measure temperature for about 20 or 30 minutes to allow the case temperature to become the same as the air temperature.

1. Enter the Temperature Mode.

[Navigating Between Modes](#)

2. Hold down (E) for at least two seconds. Keep the button depressed when [SET] starts to flash. Release the button when [°C] stops flashing.

This displays the current temperature and enters the Temperature Offset Mode.

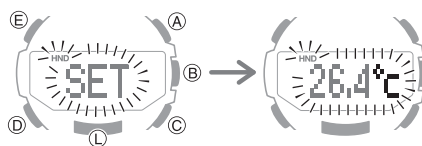

3. Use (A) and (C) to calibrate the temperature.

Calibration unit: 0.1 °C (0.2 °F)

- To return the barometric pressure setting to its initial factory default, press (A) and (C) at the same time.

4. Press (E) to complete the setting operation.

Specifying the Temperature Unit

You can select either Celsius (°C) or Fahrenheit (°F) as the temperature display unit.

Important!

- When Tokyo (TOKYO) is the Home City, the unit is fixed as Celsius (°C) and cannot be changed.

1. Enter the Timekeeping Mode.
[Navigating Between Modes](#)

2. Hold down (E) for at least two seconds. Release the button when the name of the currently selected Home City appears on the display.

Example: When your Home City is Los Angeles

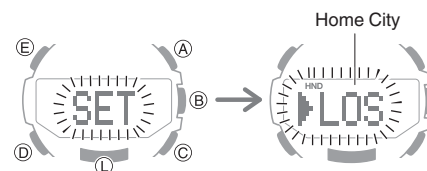

3. Press (D) nine times.

This will display [UNIT °C] with [°C] flashing, or [UNIT °F] with [°F] flashing.



4. Use (C) to select a temperature unit.

[°C]: Celsius

[°F]: Fahrenheit

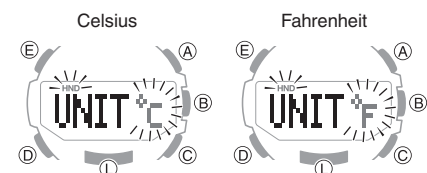

5. Press (E) twice to complete the setting operation.

Temperature Reading Precautions

Body temperature, direct sunlight, and humidity all have an effect on temperature readings. To help ensure more accurate temperature readings, remove the watch from your wrist, wipe it dry of any moisture, and place it in a well-ventilated location not exposed to direct sunlight. You should be able to take temperature readings after about 20 to 30 minutes.

Using FISH IN TIME

You can use the watch to check best fishing times (FISH IN TIME) at a port you specify with PRO TREK Connected.

A FISH IN TIME ALARM and FISHING TIMER are also provided to alert you when a fishing time is reached.

Note

- FISH IN TIME is when the lunar observation direction (lunar hour angle) is overhead (hour angle 00:00), 90° west from overhead (hour angle 06:00), directly below (hour angle 12:00), or 90° east from overhead (hour angle 18:00).

[Lunar Observation Direction \(Hour Angle\)](#)

Specifying a Port (Fishing Point)

Use PRO TREK Connected to select the port whose best fishing times (FISH IN TIME) you want to view.

[Using PRO TREK Connected to Configure Settings](#)

Important!

- Use PRO TREK Connected to specify a port. Check the information at the link below to find out how to set a port using watch operations.

[Setting a Fishing Point on the Watch](#)

Checking Today's FISH IN TIME

- Enter the FISH Mode.

[Navigating Between Modes](#)

This displays [FISH]. After about one second, the today's date appears.

After another two seconds, today's first FISH IN TIME (hour angle 00:00) appears, along with a Fishing Mark count that indicates fishing probability for that time.

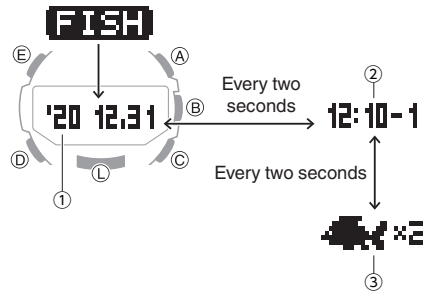

- Date
- FISH IN TIME (hour angle 00:00)
- Fishing Mark count

- Use (A) to cycle between the different FISH IN TIME and their Fishing Mark counts.

Each press of (A) cycles through FISH IN TIME as shown below.

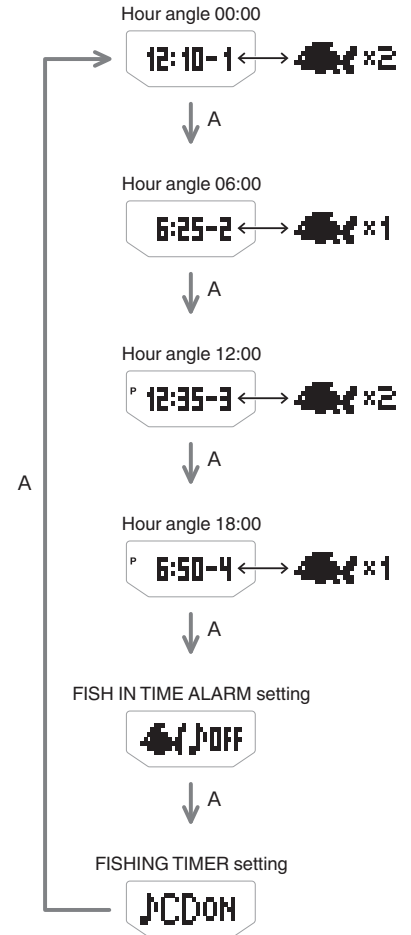

If there is no fishing probability information available a long bar ([-----]) will be shown in place of the Fishing Mark count.

Checking FISH IN TIME for a Specific Day

1. Enter the FISH Mode.
[🔍 Navigating Between Modes](#)
2. Use (C) to change the date.

About two seconds after you change the date, its first FISH IN TIME (hour angle 00:00) appears, along with a Fishing Mark count that indicates fishing probability for that time.

- To display today's date, press (A) and (C) at the same time. After that, you can advance day-by-day by pressing (C).
 - Holding down (C) while changing the date will change at high speed.
 - You can select a date in the range of January 1, 2000 to December 31, 2099.
3. Use (A) to cycle between the different FISH IN TIME (hour angles 06:00, 12:00, 18:00) and their Fishing Mark counts.

Setting the FISH IN TIME ALARM

Fishing Mark counts are refreshed at the top and bottom of each hour.

The watch will beep when a best fishing time (FISH IN TIME) is approached.

Note

- This can be set separately from the FISHING TIMER. You can also set the FISH IN TIME ALARM notification only or the FISHING TIMER hand only.
- Press any button to stop the FISH IN TIME ALARM after it starts to sound.

1. Enter the FISH Mode.
[🔍 Navigating Between Modes](#)
2. Press (A) four times to display the FISH IN TIME ALARM setting screen.

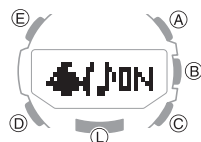

3. Press (C) to toggle the FISH IN TIME ALARM setting between ON and OFF.

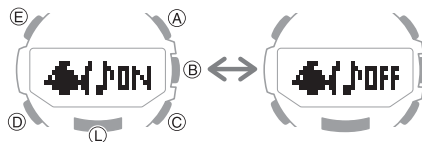

4. Press (D) to complete the setting operation.

Setting the FISHING TIMER (FISH IN TIME Countdown)

The countdown from the FISH IN TIME start time to the end time is indicated by the second hand.

Note

- This can be set separately from the FISH IN TIME ALARM. You can also set the FISH IN TIME ALARM notification only or the FISHING TIMER hand only.

Hour angle 00:00 or 12:00: Hand takes two hours to move from 7 o'clock to 11 o'clock

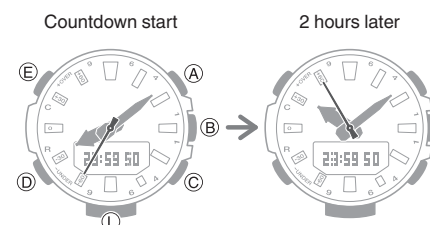

Hour angle 06:00 or 18:00: Hand takes one hour to move from 8 o'clock to 10 o'clock

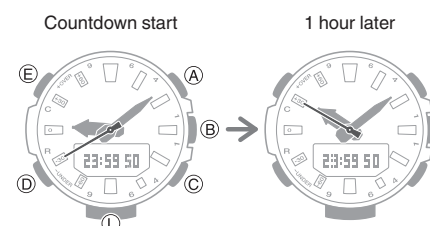

1. Enter the FISH Mode.
[🔍 Navigating Between Modes](#)
2. Press (A) five times to display the FISHING TIMER setting screen.

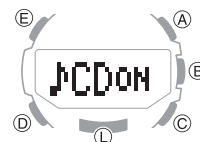

3. Press (C) to toggle the FISHING TIMER setting between ON and OFF.

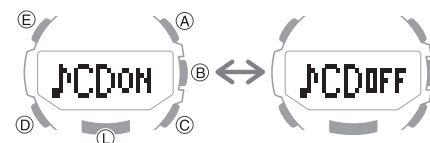

4. Press (D) to complete the setting operation.

Recording Catch Conditions (FISH MEMO)

You can use FISH MEMO to keep a record of conditions for your catches.

Note

- Data you record is sent to your phone. After that, you can use PRO TREK Connected to view the information below.
 - Date and time
 - Barometric pressure tendency
 - Tide Graph
 - FISH IN TIME and fishing probability (Fishing Mark count)
 - Moon age
 - Sunrise and Sunset Times
 - Latitude and longitude
- Barometric tendency, Tide Graph, and FISH IN TIME information recorded with PRO TREK Connected is calculated based on the specified port (fishing point).

[Specifying a Port \(Fishing Point\)](#)

- In any mode, hold down (D) for at least five seconds.

When the watch and phone connect successfully, the digital display will return from [REC] to the Timekeeping Mode screen.

- [ERR] will appear on the display if connection fails for some reason.

Example: When the current time was displayed in the Timekeeping Mode

Trying to connect

Connection successful

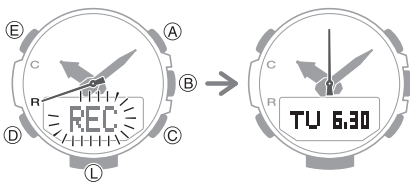

This records current fishing information for the specified port.

Note

- If a connection between the watch and phone cannot be established for some reason, the data will be transferred the next time they are connected.
- The watch has enough memory for six data records.

Fishing and Moon Movement

Lunar Observation Direction (Hour Angle)

The lunar observation direction is expressed as an hour angle, with an angle of 00:00 when the Moon is directly overhead, 06:00 when it is 90° to the west from overhead, 12:00 when it is directly below, and 18:00 when it is 90° to the east from overhead. The Moon takes an average of approximately 24 hours and 50 minutes to perform one revolution around the Earth.

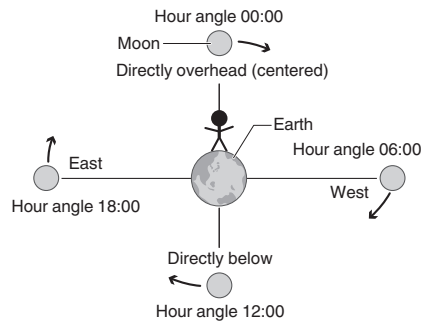

Interpreting the Fishing Mark Count

	Hour angle 00:00/ 12:00	Hour angle 06:00/ 18:00	Other
New Moon, Full Moon	🐟 ×4	🐟 ×3	🐟 ×2
Last Quarter, First Quarter	🐟 ×3	🐟 ×2	🐟 ×1
Other	🐟 ×2	🐟 ×1	—

Note

- On a monthly basis, fishing is said to be best during a New Moon or Full Moon phase, and next best during a Last Quarter or First Quarter phase.
- On a daily (hour angle) basis, fishing is said to be best during hour angles 00:00 and 12:00, and next best during hour angles 06:00 and 18:00.
- The watch uses Fishing Mark counts (×1, ×2, ×3, ×4) to indicate best fishing times based on New Moon/Full Moon and 00:00/12:00 hour angle combinations.

Important!

- Note that the season of the year, water temperature and other factors greatly influence fish behavior, so the indications produced by this watch are intended for general reference only.

Sunrise and Sunset Times

You can view sunrise and sunset times for the port you specified with PRO TREK Connected.

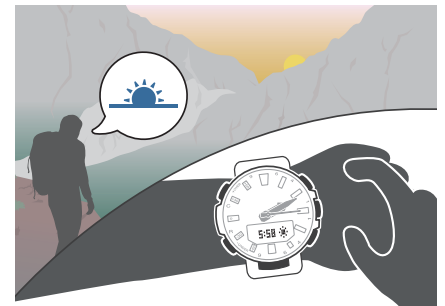

Specifying a Port (Fishing Point)

Use PRO TREK Connected to select the port whose sunrise and sunset times you want to view.

[Using PRO TREK Connected to Configure Settings](#)

Important!

- Use PRO TREK Connected to specify a port. Check the information at the link below to find out how to set a port using watch operations.
 - [Setting a Fishing Point on the Watch](#)

Looking Up Today's Sunrise and Sunset Times

- In the FISH Mode, display today's sunrise/sunset times.

[Navigating Between Modes](#)

[FISH Mode](#)

The display alternates at two-second intervals between the sunrise and sunset times of the port you specified with PRO TREK Connected.

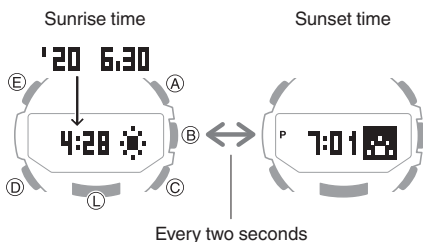

Looking Up Sunrise and Sunset Times by Specifying a Day

- In the FISH Mode, display today's sunrise/sunset times.

[Navigating Between Modes](#)

[FISH Mode](#)

- Use (C) to change the selected date.

This displays the sunrise and sunset times for the day you specified.

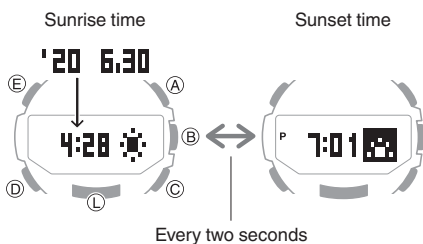

Checking the Moon Age

You can view the current Moon Age for the port you specified with PRO TREK Connected.



Specifying a Port (Fishing Point)

Use PRO TREK Connected to select the port whose Moon age you want to view.

[Using PRO TREK Connected to Configure Settings](#)

Important!

- Use PRO TREK Connected to specify a port. Check the information at the link below to find out how to set a port using watch operations. [Setting a Fishing Point on the Watch](#)

Checking Today's Moon Age

- In the FISH Mode, display the Moon age.

[Navigating Between Modes](#)

[FISH Mode](#)

Today's date will appear, followed by today's Moon age for the port you specified with PRO TREK Connected.

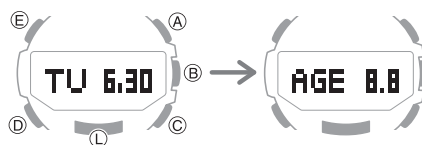

Checking the Moon Age for a Specific Day

- In the FISH Mode, display the Moon age.

[Navigating Between Modes](#)

[FISH Mode](#)

- Use (C) to change the date setting.

This displays the Moon age for the date you specified.



Tide Level

You can use the watch to check the current tide level in a port that you specify with PRO TREK Connected.

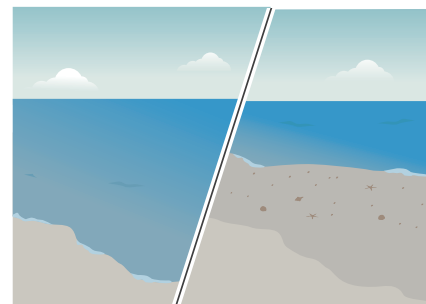

Important!

- Displayed information is intended for reference only. Do not use it for maritime navigation, etc.
- To check a tide level, use PRO TREK Connected to specify a port (fishing point). The tide level (Tide Graph) will not appear if you do not have a fishing point specified.

When there is no fishing point specified



- Check the information at the link below to find out how to set a port using watch operations.

[Setting a Fishing Point on the Watch](#)

Specifying a Port (Fishing Point)

Use PRO TREK Connected to select the port whose tide level information you want to view.

[Using PRO TREK Connected to Configure Settings](#)

Important!

- Use PRO TREK Connected to specify a port. Check the information at the link below to find out how to set a port using watch operations. [Setting a Fishing Point on the Watch](#)

Checking the Current Tide Level in the Specified Port

Displaying the tide screen in the FISH Mode will display a Tide Graph for the currently specified port (fishing point).

- In the FISH Mode, display the current tide information.

[Navigating Between Modes](#)

[FISH Mode](#)

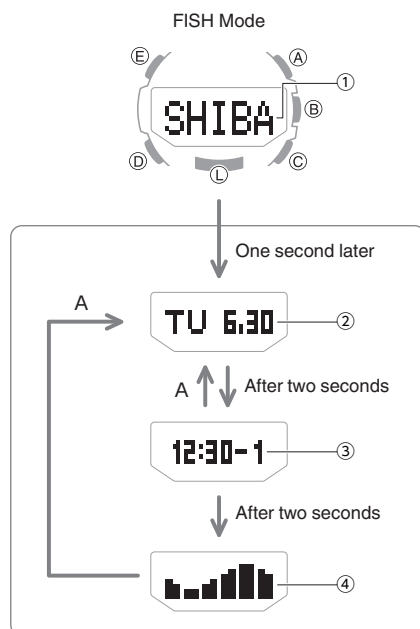

- Specified port
- Date at the specified port
- Current time in the specified port
- Tide conditions in the specified port

Note

- The tide level is based on the summer time setting of the port that was specified when you displayed the tide screen.

● Interpreting Displayed Tide Conditions

The graph shows tide levels at the specified port.

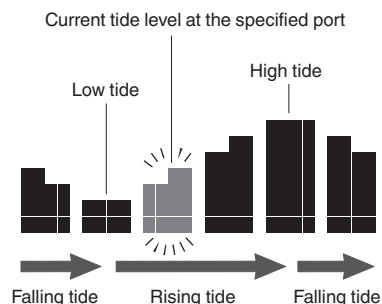

Note

- The graph shows tides for approximately 12 hours as one of six levels.
- If the tide level is not being indicated correctly, adjust the high tide time. [Adjusting High Tide Times](#)

Checking the Tide Level for a Specific Day

- In the FISH Mode, display the current tide information.

[Navigating Between Modes](#)

[FISH Mode](#)

- Use (C) to change the date setting.

After about two seconds the display switches to the time screen.



- Use (C) to change the time setting.

The Tide Graph will show information for the date and time you specify.



Adjusting High Tide Times

You can improve the accuracy of the displayed high tide by adjusting the high tide time in accordance with information available on the internet or in a newspaper.

- Enter the FISH Mode.

[Navigating Between Modes](#)

- Hold down (E) for at least two seconds. Release the button when [SET] starts to flash and then disappears from the display.

After the high tide time for that day appears, the minutes digits will become selected so you can change them.

- Use (A) and (C) to change the high tide time minute setting.

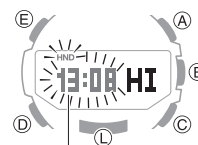

High tide time in the specified port

- Press (D).

This causes the hours digits to become selected.

- Use (A) and (C) to change the high tide time hour setting.

- Use (D) to navigate between setting items.

Each press of the button cycles through setting items as shown below.

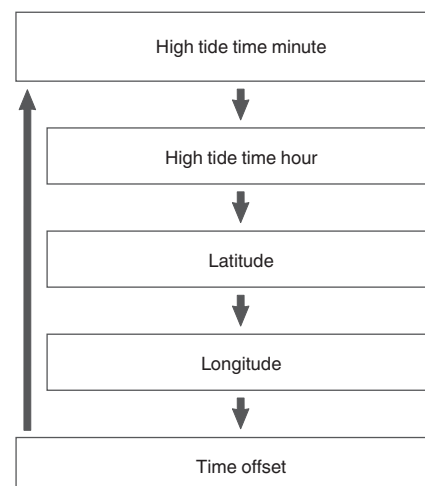

- Use (A) and (C) to specify the latitude, longitude, and time offset.

- Press (E) to register the high tide time.

Note

- For a location where there are two high tides per day, set the time of the first high tide. The watch will automatically calculate the time of the second high tide.
- If the specified port is in a time zone that is different from your current time zone, there may be cases when the date in the port is different from the displayed date.
- If summer time is in effect in the specified port, you should also use summer time when specifying the high tide time.

Important!

- Adjusting high tide times on the watch may cause a fishing point set with the watch to be different from the point set with PRO TREK Connected.

Stopwatch

The stopwatch measures elapsed time in 1/100-second units for the first hour, and in 1-second units after that for up to 24 hours.

It can also measure split times.



Measuring Elapsed Time

1. Enter the Stopwatch Mode.
[Navigating Between Modes](#)
2. Use the operations below to measure elapsed time.

- ⓐ Start
- ↓
- ⓐ Stop
- ↓
- ⓐ Resume
- ↓
- ⓐ Stop

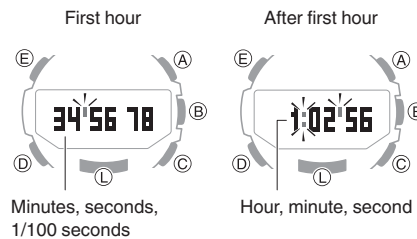

3. Press (A) to reset the stopwatch to all zeros.

Measuring a Split Time

1. Enter the Stopwatch Mode.
[Navigating Between Modes](#)
2. Use the operations below to measure elapsed time.

- ⓐ Start
- ↓
- ⓐ Split
- ↓
- ⓐ Split release
- ↓
- ⓐ Stop

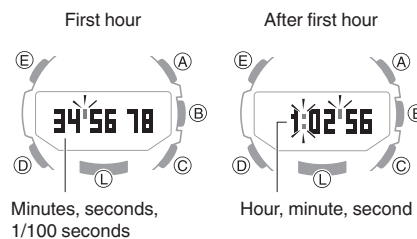

3. Press (A) to reset the stopwatch to all zeros.

Timer

The timer counts down from a start time specified by you. A beeper sounds when the end of the countdown is reached.

- The beeper will not sound if battery power is low.

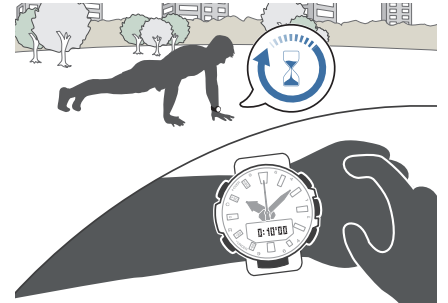

Setting a Start Time

The countdown start time can be set in 1-minute units up to 24 hours.

1. Enter the Timer Mode.
[Navigating Between Modes](#)
2. Hold down (E) for at least two seconds. Release the button when the minutes setting starts to flash.

This causes the minutes digit to flash.

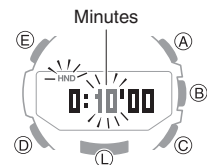

3. Use (A) and (C) to change the timer minutes setting.

4. Press (D).

This causes the hours digit to flash.

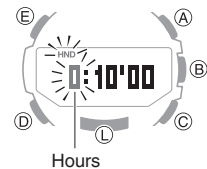

5. Use (A) and (C) to change the timer hours setting.

6. Press (E) to complete the setting operation.

Note

- You can also use PRO TREK Connected to configure timer settings.

Using the Timer

1. Enter the Timer Mode.
[🔍 Navigating Between Modes](#)
2. Use the operations below to perform a timer operation.

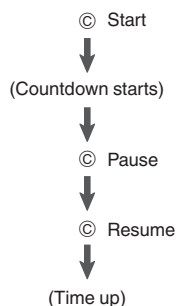

- A beeper will sound for 10 seconds to let you know when the end of a countdown is reached.
 - You can reset a paused countdown to its start time, by pressing (A).
3. Press any button to stop the tone.

Alarms and Hourly Time Signal

The watch will beep when an alarm time is reached. You can set up to five different alarms. The hourly time signal causes the watch to beep every hour on the hour.

- The beeper will not sound if battery power is low.



Configuring Alarm Settings

1. Enter the Alarm Mode.
[🔍 Navigating Between Modes](#)
2. Use (A) and (C) to display the number ([AL1] to [AL5]) of the alarm whose settings you want to change.

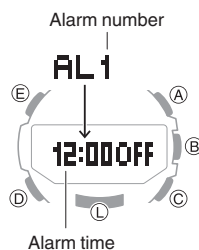

3. Hold down (E) for at least two seconds. Release the button when the hour setting starts to flash.
 - The (alarm) indicator is displayed when any alarm is turned on.

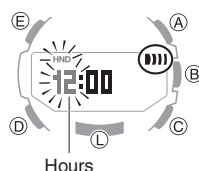

4. Use (A) and (C) to change the hour setting.
 - If you are using 12-hour timekeeping, [P] indicates p.m.



5. Press (D).
 This causes the minutes digits to flash.

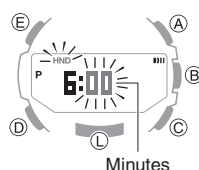

6. Use (A) and (C) to change the minute setting.
7. Press (E) to complete the setting operation.
8. Hold down (D) for at least two seconds to return to the Timekeeping Mode.

• To stop the alarm

To stop the alarm after it starts to sound when an alarm time is reached, press any button.

Note

- A beeper sounds for 10 seconds when an alarm time is reached.
- You can also use PRO TREK Connected to configure alarm time settings.

Configuring the Hourly Time Signal Setting

1. Enter the Alarm Mode.
[🔍 Navigating Between Modes](#)
2. Press (A) or (C) to display the hourly time signal screen ([SIG]).

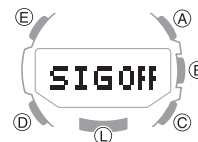

3. Press (E) to toggle the hourly time signal between enabled (on) and disabled (off).
 - (hourly time signal) is shown on the display while the hourly time signal is enabled.



Note

- You can also use PRO TREK Connected to configure the hourly time signal setting.

Turning Off an Alarm or the Hourly Time Signal

To stop an alarm or the hourly time signal from sounding, perform the steps below to turn it off.

- To have an alarm or hourly time signal sound again, turn it back on.

Note

- Indicators are displayed while any of the alarms or the hourly time signal is turned on.
- The applicable indicators are not displayed while all of the alarms are turned off and/or the hourly time signal is turned off.

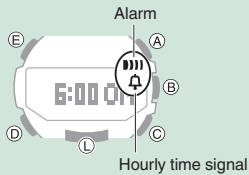

- Enter the Alarm Mode.

[Navigating Between Modes](#)

- Use (A) and (C) to scroll through alarm numbers ([AL1] to [AL5]) and the hourly time signal ([SIG]) screens until the one whose setting you want to change is displayed.

Alarm number or hourly time signal

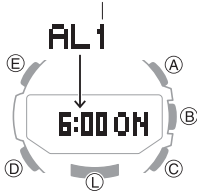

- Press (E) to turn off the displayed alarm or the hourly time signal.

- Each press of (E) toggles between ON and OFF.
- Turning off all alarms will cause **|||||** (alarm) to disappear from the display, while disabling the hourly time signal causes **🔔** (hourly time signal) to disappear from the display.



Note

- If **|||||** (alarm) is still displayed, it means that another alarm is still turned on. To turn off all of the alarms, repeat steps 2 and 3 until the **|||||** (alarm) indicator is no longer displayed.

World Time

World Time lets you look up the current time in any one of 38 cities around the globe, and UTC (Coordinated Universal Time).

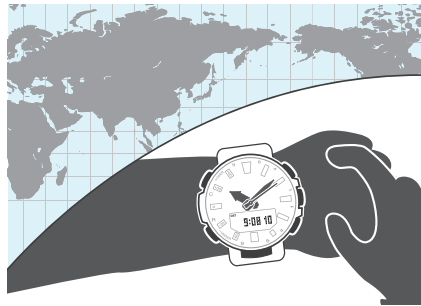

Note

- World Time cities that can be selected only by using PRO TREK Connected operations.

[Configuring World Time Settings](#)

Checking World Time

- Enter the World Time Mode.

[Navigating Between Modes](#)

After the currently selected World Time City name appears, the watch will display the current time in that city.

- You can display the World Time City while in the World Time Mode by pressing (E).

World Time City

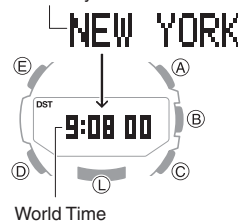

World Time

Specifying a World Time City

Use the procedure in this section to select a World Time city. If you are in an area that observes summer time, you can also enable or disable summer time.

Note

- The initial factory default summer time setting for all cities is [AUTO]. In many cases, the [AUTO] setting lets you use the watch without switching between summer time and standard time.

- Enter the World Time Mode.

[Navigating Between Modes](#)

- Use (A) and (C) to display the city you want.

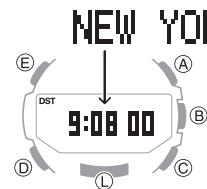

- To change the summer time setting, hold down (E) for at least two seconds. Release the button when [AUTO], [OFF], or [ON] starts to flash.



- Use (C) to change the summer time setting.

Each press of (C) cycles through settings in the sequence shown below.

- [AUTO]
The watch switches between standard time and summer time automatically.
- [OFF]
The watch always indicates standard time.
- [ON]
The watch always indicates summer time.

- Press (E) to complete the setting operation.

Note

- While [UTC] is selected as the city, you will not be able to change or check the summer time setting.
- If you select a World Time City with PRO TREK Connected and then change to a different city with a watch operation, the PRO TREK Connected city information is deleted from the watch.
[Configuring World Time Settings](#)

Swapping Your Home Time and World Time

In the World Time Mode, hold down (L) for at least two seconds until **HT\leftrightarrowWT** starts to flash and the hands start to move. This will swap your Home City Time and World Time.

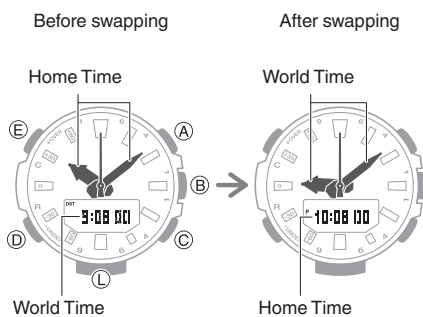

Note

- This function comes in handy when you need to move to another time zone. For details about how to use it, go to the section below.
[Moving to Another Time Zone](#)

Specifying UTC (Coordinated Universal Time) as Your World Time City

In the World Time Mode, pressing (A) and (C) at the same time will set UTC (Coordinated Universal Time) as the World Time City and display its current time.

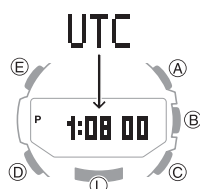

Pedometer

You can use the pedometer to keep track of your step count while walking, engaging in your normal daily activities, etc.

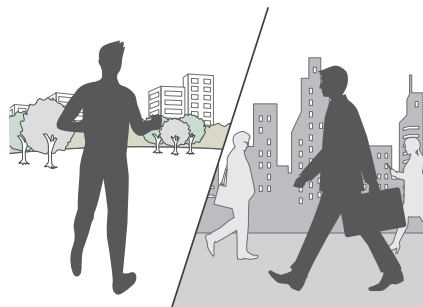

Counting Steps

If you are wearing the watch correctly, the pedometer will count your steps as you walk or engage in your normal daily activities.

Important!

- Since this watch's pedometer is a wrist-worn device, it may detect non-step movements and count them as steps. Also, abnormal arm movements while walking may cause a miss count of steps.

Getting Ready

To enable the most accurate step count, wear the watch with the face on the outside of your wrist and tighten the band securely. A loose band may make it impossible to obtain correct measurement.



Counting Steps

The pedometer will start counting your steps when you start walking.

To check the step count

Displaying the step count screen.

[Mode Overview](#)

Note

- The step count can show a value up to 999,999 steps. If the step count exceeds 999,999, the maximum value (999,999) remains on the display.
- To prevent miscounts, the displayed count does not increase for about 10 seconds after you start walking. After you have been walking for about 10 seconds, the correct count appears, including the steps you took during the previous 10 seconds.
- The step count is reset to zero at midnight each day.
- To save power, step counting stops automatically if you take off the watch (no detectable watch movement) and you do not perform any operation for two or three minutes.

Causes of Incorrect Step Count

Any of the conditions below may make proper counting impossible.

- Walking while wearing slippers, sandals, or other footwear that encourages a shuffling gait
- Walking on tile, carpeting, snow, or other surface that causes a shuffling gait
- Irregular walking (in a crowded location, in a line where walking stops and starts at short intervals, etc.)
- Extremely slow walking or extremely fast running
- Pushing a shopping cart or baby stroller
- In a location where there is a lot of vibration, or riding on a bicycle or in a vehicle
- Frequent movement of the hand or arm (clapping, fanning movement, etc.)
- Walking while holding hands, walking with a cane or stick, or engaging in any other movement in which your hand and leg movements are not coordinated with each other
- Normal daily non-walking activities (cleaning, etc.)
- Wearing the watch on your dominant hand
- Walking for 10 seconds or less

Hand Alignment Adjustment

Strong magnetism or impact can cause the time indicated by the analog hands to become different from the time on the digital display. If this happens, adjust hand alignment.

Adjusting Hand Alignment

1. Enter the Timekeeping Mode.
 Navigating Between Modes

2. Hold down (E) for at least five seconds. Release the button when [00] starts to flash.

This enables adjustment of second hand alignment.

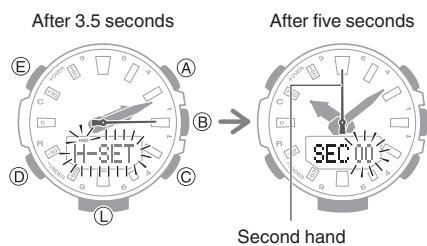

3. If the second hand is not at 12 o'clock, use (A) and (C) to align it.

4. Press (D).

This enables adjustment of the hour and minute hands.

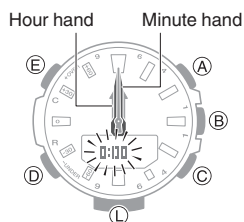

5. If the hour hand and minute hand are not at 12 o'clock, use (A) and (C) to align them.

6. Press (E) to complete the setting operation.

Other Settings

This section explains other watch settings you can configure.

Enabling the Button Operation Tone

Use the procedure below to enable or disable the tone that sounds when you press a button.

1. Enter the Timekeeping Mode.
 Navigating Between Modes

2. Hold down (E) for at least two seconds. Release the button when the name of the currently selected Home City appears on the display.

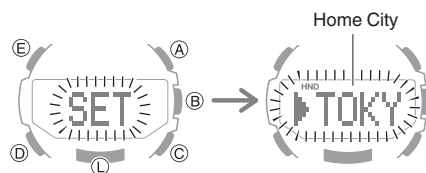

3. Press (D) twice.

This causes [KEY ♪] or [MUTE] to flash on the display.



4. Press (C) to select [KEY ♪] or [MUTE].

[KEY ♪]: Operation tone enabled.

[MUTE]: Operation tone muted.

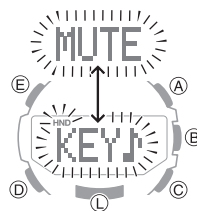

5. Press (E) twice to complete the setting operation.

Note

- Note that alarm and timer tones will still sound even while the operation tone is muted.

Reflecting Altitude Differential in Activity Measurements

You can use the procedure below to specify whether or not you want to reflect altitude differential in physical exertion measurements.

Note

- Reflecting altitude differential information in activity measurements makes it possible to obtain more accurate activity calculations.
- PRO TREK Connected is used to specify your height and weight, and to calculate physical exertion. This information is not displayed on the watch.

1. Enter the Timekeeping Mode.
 Navigating Between Modes

2. Hold down (E) for at least two seconds. Release the button when the name of the currently selected Home City appears on the display.

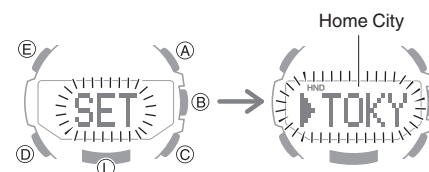

3. Press (D) six times.

This will display [SLOPE], followed by a flashing [ON] or [OFF].

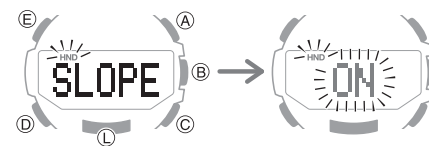

4. Press (C) to select [ON] or [OFF].

[ON]: Altitude differential reflected in physical exertion measurements.

[OFF]: Altitude differential not reflected in physical exertion measurements.

5. Press (E) twice to complete the setting operation.

Resetting Watch Settings

This section explains how to return the watch settings below to their initial factory defaults.

- Watch Settings
- Compass
- Altimeter
- Barometer
- Thermometer
- FISH Mode Settings
- Step count data
- Stopwatch
- Timer
- Alarm

1. Enter the Timekeeping Mode.
[Navigating Between Modes](#)

2. Hold down (E) for at least two seconds. Release the button when the name of the currently selected Home City appears on the display.

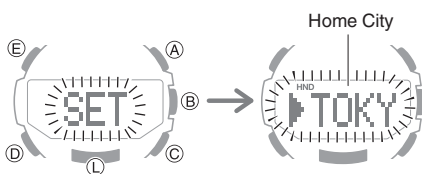

3. Press (E).
This causes the seconds to flash.

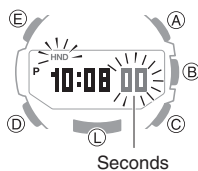

4. Hold down (A) for at least five seconds. Release when [RESET] stops flashing.



5. Press (E) to complete the setting operation.

Note

- Resetting the watch will also delete information for pairing the watch with a phone, and unpair them.

Moving to Another Time Zone

Use the procedure below to easily change day and time settings of the watch to a destination location.

● Before Boarding

1. Configure the World Time to the current time at your destination.

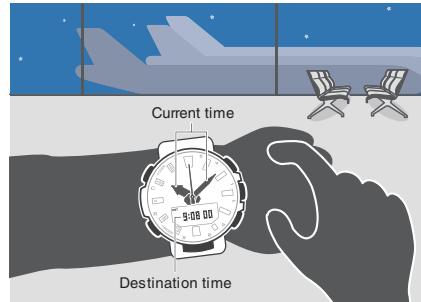

- [Using PRO TREK Connected to Configure Settings](#)
- [Using Watch Operations to Configure Settings](#)

2. Disable auto time adjustment.

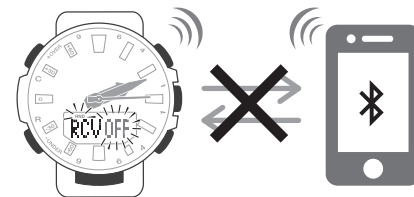

- [Using PRO TREK Connected to Configure Settings](#)
- [Using Watch Operations to Configure Settings](#)

● After Arriving

1. Swap the origin time zone time with the destination time zone time.

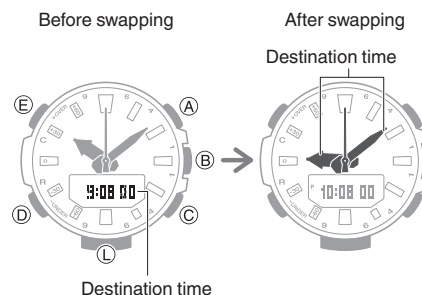

- [Using PRO TREK Connected to Configure Settings](#)
- [Using Watch Operations to Configure Settings](#)

2. Enable auto time adjustment.
[Using PRO TREK Connected to Configure Settings](#)
[Using Watch Operations to Configure Settings](#)
3. Adjust the time setting.
[Triggering Immediate Time Adjustment](#)

Other Information

This section provides non-operational information you also need to know. Refer to this information as required.

City Table

City	Offset
UTC	Coordinated Universal Time 0
LONDON	London 0
PARIS	Paris +1
ATHENS	Athens +2
JEDDAH	Jeddah +3
TEHRAN	Tehran +3.5
DUBAI	Dubai +4
KABUL	Kabul +4.5
KARACHI	Karachi +5
DELHI	Delhi +5.5
KATHMANDU	Kathmandu +5.75
DHAKA	Dhaka +6
YANGON	Yangon +6.5
BANGKOK	Bangkok +7
HONG KONG	Hong Kong +8
EUCLA	Eucla +8.75
TOKYO	Tokyo +9
ADELAIDE	Adelaide +9.5
SYDNEY	Sydney +10
LORD HOWE ISLAND	Lord Howe Island +10.5
NOUMEA	Noumea +11
WELLINGTON	Wellington +12
CHATHAM ISLANDS	Chatham Islands +12.75
NUKU'ALOFA	Nuku'alofa +13
KIRITIMATI	Kiritimati +14
BAKER ISLAND	Baker Island -12
PAGO PAGO	Pago Pago -11
HONOLULU	Honolulu -10
MARQUESAS ISLANDS	Marquesas Islands -9.5
ANCHORAGE	Anchorage -9
LOS ANGELES	Los Angeles -8
DENVER	Denver -7
CHICAGO	Chicago -6
NEW YORK	New York -5
HALIFAX	Halifax -4
ST. JOHN'S	St. John's -3.5
RIO DE JANEIRO	Rio de Janeiro -3
F. DE NORONHA	Fernando de Noronha -2
PRAIA	Praia -1

- The information in the above table is current as of January 2020.
- Time zones may change and UTC differentials may become different from those shown in the table above. If this happens, connect the watch with a phone to update the watch with the latest time zone information.

Summer Time Table

When [AUTO] is selected for a city that observes summer time, switching between standard time and summer time will be performed automatically at the timing shown in the table below.

Note

- Summer time start and end dates for your current location may be different from those shown below. If this happens, you can have new summer time information for your Home City and World Time city sent to the watch by connecting the watch with a phone. If the watch is not connected with a phone, you can change the summer time setting manually.

City Name	Summer Time Start	Summer Time End
London	01:00, last Sunday in March	02:00, last Sunday in October
Paris	02:00, last Sunday in March	03:00, last Sunday in October
Athens	03:00, last Sunday in March	04:00, last Sunday in October
Tehran	00:00, March 22 or 21	00:00, September 22 or 21
Sydney, Adelaide	02:00, first Sunday in October	03:00, first Sunday in April
Lord Howe Island	02:00, first Sunday in October	02:00, first Sunday in April
Wellington	02:00, last Sunday in September	03:00, first Sunday in April
Chatham Islands	02:45, last Sunday in September	03:45, first Sunday in April
Anchorage	02:00, second Sunday in March	02:00, first Sunday in November
Los Angeles	02:00, second Sunday in March	02:00, first Sunday in November
Denver	02:00, second Sunday in March	02:00, first Sunday in November
Chicago	02:00, second Sunday in March	02:00, first Sunday in November
New York	02:00, second Sunday in March	02:00, first Sunday in November
Halifax	02:00, second Sunday in March	02:00, first Sunday in November
St. John's	02:00, second Sunday in March	02:00, first Sunday in November

- The information in the above table is current as of January 2020.

Supported Phones

For information about phones that can connect with the watch, visit the CASIO website.

https://world.casio.com/os_mobile/wat/

Specifications

Accuracy :

±15 seconds per month average when time adjustment by communication with a phone is not possible.

Basic Functions :

Analog

Hour, minute (moves every 10 seconds), second

Digital

Hour, minute, second, month, day, day of the week

p.m. (P), 24-hour timekeeping

Full Auto Calendar (2000 to 2099)

Digital Compass :

Measurement range: 0° to 359°

Measurement Units: LCD: 1°, Analog: 6°

Continuous Bearing Measurement (1 minute)

North Indication Hand

Bearing calibration (2-point calibration, figure 8 calibration, magnetic declination calibration)

Auto bearing calibration

Barometer :

Measurement range: 260 to 1,100 hPa (or 7.65 to 32.45 inHg)

Display range: 260 to 1,100 hPa (or 7.65 to 32.45 inHg)

Measurement unit: 1 hPa (or 0.05 inHg)

Barometric pressure graph

Barometric pressure indicator (-10 to +10 hPa/-1 to +1 hPa (or -0.25 to +0.25 inHg/-0.05 to +0.05 inHg))

Barometric Pressure Change Indications

Altimeter (relative altitude) :

Measuring range: -700 to 10,000 m (or -2,300 to 32,800 ft.)

Display range: -3,000 to 10,000 m (or -9,840 to 32,800 ft.)

(Altitude calibration can be used to display any 10,700 m within the range above.)

Measuring unit: 1 m (or 5 ft.)

Auto measurement interval (2 minutes, 5 seconds)

Altitude calibration

Altitude graph

Altitude differential measurement (-100 to +100 m/-1,000 to +1,000 m (or -325 to +325 ft./-3,280 to +3,280 ft.))

Temperature :

Measuring range: -10.0 °C to 60.0 °C (or 14.0 °F to 140.0 °F)

Display range: -10.0 °C to 60.0 °C (or 14.0 °F to 140.0 °F)

Measuring unit: 0.1 °C (or 0.2 °F)

Temperature Correction

Sensor Accuracy :

Direction sensor

Measurement accuracy: Within $\pm 10^\circ$
(Guaranteed accuracy temperature range: 10°C to 40°C (50°F to 104°F))
Bearing hand indication: Within ± 2 gradations

Pressure sensor

Measurement accuracy: Within ± 3 hPa (0.1 inHg)
(Altimeter measurement accuracy: Within ± 75 m (246 ft.))

- Guaranteed accuracy temperature range: -10°C to 40°C (14°F to 104°F)
- Strong impact or prolonged exposure to temperature extremes may negatively affect accuracy.

Temperature Sensor

Measurement accuracy: Within $\pm 2^\circ\text{C}$ (3.6°F)
(Guaranteed accuracy temperature range: -10°C to 60°C (14°F to 140°F))

Pedometer :

Step count measurement using a 3-axis accelerometer

Step count display range: 0 to 999,999 steps

Step count reset: Auto reset at midnight each day

Step count accuracy: $\pm 3\%$ (According to vibration testing)

Power Saving

Tide/Moon :

Tide Level (Tide Graph)

Moon age

Time, date selection

High tide time correction

Fishing :

FISH IN TIME (monthly hour angle 00:00, 06:00, 12:00, 18:00)

Fishing Mark

Date selection

FISH IN TIME ALARM

FISHING TIMER

Sunrise/Sunset Functions :

Sunrise and sunset times

Date selection

Stopwatch :

Measuring units: 1/100 seconds (first hour); 1 second (after first hour)

Measuring capacity: 23:59'59" (24 hours)

Measurement functions: Elapsed time, split times

Timer :

Setting unit: 1 minute

Countdown range: 1 minute to 24 hours

Countdown unit: 1 second

Time up alert duration: 10 seconds

Alarm :

Time alarms

Number of alarms: 5

Setting units: Hours, minutes

Alarm tone duration: 10 seconds

Hourly time signal: Beep every hour on the hour

World Time :

Current time in 38 cities (38 time zones), and UTC (Coordinated Universal Time) time

Auto summer time setting

Swapping with Home City

One-touch UTC display

Mobile Link :

Auto Time Adjustment

Time setting adjusted automatically at preset time.

One-touch Time Correction

Manual connection and time adjustment

Phone finder

Watch operation sounds the alert sound of the phone.

World Time

A selection of more than 300 World Time cities

Auto Daylight Saving Time (summer time) switching

Automatic switching between standard time and summer time.

FISH Mode setting

Selection from among 3,300 world ports to view its fishing information

FISH MEMO

Records locations and dates of catches.

Location Indicator

Shows the bearing and distance to a location registered on the watch.

Auto altitude calibration

Automatic altitude calibration at a preset time

Timer Settings

Alarm Settings

Mode sort sequence and number of modes setting

Timekeeping Mode display item setting

Altimeter settings

Barometer settings

Compass settings

Step count data transfer

Calories burned calculation (speed information + altitude information)

Hand alignment correction

Communication Specifications

Bluetooth®

Frequency band: 2400MHz to 2480MHz

Maximum transmission power: 0 dBm (1 mW)

Communication range: Up to 2 meters (depends on environment)

Other :

High-brightness DOUBLE LED light (Auto Light, afterglow); illumination duration setting; low battery alert; operation tone ON/OFF; hand shift feature

Power Supply :

CR2025 x 1 (battery sold separately)

Battery life: Approximately 2 years

Conditions

Auto Time Adjustment: 4 times/day

Alarm: Once (10 seconds)/day

Illumination: Once (1.5 seconds)/day

Direction readings: 60 seconds

continuous, 20 times/month

Fishing: 1 time/month

– Barometric Pressure Change Indications

Every second for 3 minutes + every 2 minutes for 23 hours and 57 minutes

– Location Indicator Measurement

10 times for 3 minutes each

Step counting: 12 hours/day

Auto bearing calibration measurements: 10 times/day

Barometric pressure graph

measurements: 12 times/day

Altitude measurement: Every second for 3 minutes + Every 5 seconds for 57 minutes

Specifications are subject to change without notice.

Mobile Link Precautions

● Legal Precautions

- This watch complies with or has received approval under the radio laws of various countries and geographical areas. Using this watch in an area where it does not comply with or has not received approval under applicable radio laws may be a criminal offense. For details, visit the CASIO Website.
<https://world.casio.com/ce/BLE/>

- Use of this watch inside of aircraft is restricted under the aviation laws of each country. Be sure to follow the instructions of airline personnel.

● Precautions when using Mobile Link

- When using this watch in combination with a phone, keep the watch and phone close to each other. A range of two meters is recommended as a guideline, but the local environment (walls, furniture, etc.), the structure of a building, and other factors may require a much closer range.
- This watch can be affected by other devices (electrical devices, audio-visual equipment, office equipment, etc.) In particular, it can be affected by operation of a microwave oven. The watch may not be able to communicate normally with a phone if a microwave oven is operating nearby. Conversely, this watch may cause noise in radio reception and the video image of a TV.
- Bluetooth of this watch uses the same frequency band (2.4 GHz) as wireless LAN devices, and use of such devices in close proximity of this watch may result in radio interference, slower communication speeds and noise for the watch and the wireless LAN device, or even communication failure.

● Stopping Radio Wave Emission by This Watch

The watch is emitting radio waves whenever the second hand is pointing to [R] or [C].

Also, the watch connects with a phone automatically as described below.

- Auto adjust (4 times/day)

When in a hospital, on an aircraft, or in any other area where the use of radio waves is not allowed, use the operation below to stop radio wave generation.

- Stopping Radio Wave Generation
Press any button besides (L) to terminate the Bluetooth connection.

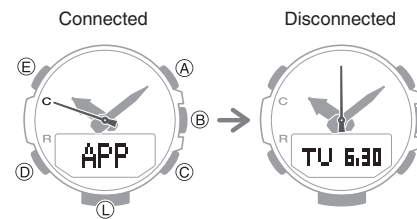

- Disabling Auto Time Adjustment
Configure PRO TREK Connected settings to disable time adjustment between the watch and phone.
🔗 [Using PRO TREK Connected to Disable Auto Time Adjustment](#)

Copyrights and Registered Copyrights

- The Bluetooth® word mark and logos are registered trademarks owned by the Bluetooth SIG, Inc. and any use of such marks by CASIO Computer Co., Ltd. is under license.
- iPhone and App Store are trademarks of Apple Inc. in the United States and other countries.
- iOS is a trademark or registered trademark of Cisco Systems, Inc.
- GALAXY is a registered trademark of Samsung Electronics Co., Ltd.
- Android and Google Play™ are trademarks or registered trademarks of Google LLC.
- Other company names and product names used herein are trademarks or registered trademarks of their respective companies.

Troubleshooting

I can't pair the watch with a phone.

Q1 I've never been able to establish a (pairing) connection between the watch and phone.

Are you using a supported phone model?

Check if the phone model and its operating system are supported by the watch.
For information about supported phone models, visit the CASIO Website.

https://world.casio.com/os_mobile/wat/

Did you install PRO TREK Connected on your phone?

PRO TREK Connected needs to be installed on your phone in order to connect with the watch.

🔗 [① Install the required app on your phone.](#)

Are your phone's Bluetooth settings configured correctly?

Configure the phone's Bluetooth settings. For details about setting procedures, see your phone documentation.

iPhone Users

- "Settings" → "Bluetooth" → On
- "Settings" → "Privacy" → "Bluetooth Sharing" → "PRO TREK Connected" → On

Android Users

- Enable Bluetooth.

Other than the above.

Some phones need to have BT Smart disabled to use PRO TREK Connected. For details about setting procedures, see your phone documentation.

On the Home Screen, tap: "Menu" → "Settings" → "Bluetooth" → "Menu" → "BT Smart settings" → "Disable".

I can't reconnect the watch and phone.

Q1 The watch will not re-connect with the phone after they are disconnected.

Is PRO TREK Connected running?

The watch cannot re-connect with the phone unless PRO TREK Connected is running on the phone. On the phone's Home Screen, tap the "PRO TREK Connected" icon. Then on the watch, hold down (B) for at least two seconds until the second hand points to [R] twice.

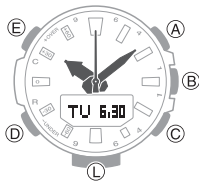

Have you tried turning your phone off and then back on again?

Turn the phone off and then back on, and then tap the "PRO TREK Connected" icon. Then on the watch, hold down (B) for at least two seconds until the second hand points to [R] twice.

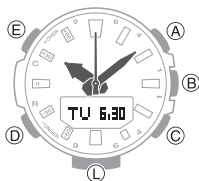

Is a timer countdown operation in progress?

Connection with a phone is not possible while there is 30 seconds or less remaining on a countdown timer operation. Stop the countdown operation before connecting with the phone.

Q2 I can't connect while my phone is in the Airplane Mode.

Connection with the watch is not possible while the phone is in the Airplane Mode. After exiting the phone's Airplane Mode, go to the Home Screen and tap the "PRO TREK Connected" icon. Then on the watch, hold down (B) for at least two seconds until the second hand points to [R] twice.

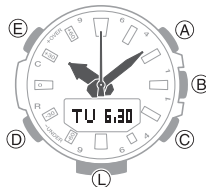

Q3 I changed the phone's Bluetooth from enabled to disabled, and now I can't connect anymore.

On the phone, turn Bluetooth off and then back on, and then tap the "PRO TREK Connected" icon on the Home Screen. Then on the watch, hold down (B) for at least two seconds until the second hand points to [R] twice.

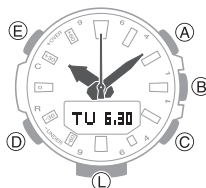

Q4 I can't connect after turning off the phone.

Turn on the phone and then tap the "PRO TREK Connected" icon. Then on the watch, hold down (B) for at least two seconds until the second hand points to [R] twice.

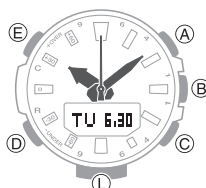

Phone-Watch Connection

Q1 I can't establish a connection between the phone and watch.

Have you tried turning your phone off and then back on again?

Turn the phone off and then back on, and then tap the "PRO TREK Connected" icon. Then on the watch, hold down (B) for at least two seconds until the second hand points to [R] twice.



Has the watch been re-paired with the phone?

After deleting pairing information from PRO TREK Connected, re-pair them.

[Unpairing](#)

[③ Pair the watch with a phone.](#)

If you are unable to establish a connection...

Use the procedure below to delete the pairing information from the watch, and then re-pair the watch and phone.

- ① Hold down (D) for at least two seconds to enter the Timekeeping Mode.
- ② Hold down (E) for at least two seconds. Release the button when the name of the currently selected Home City appears on the display.
- ③ Press (E) to cause the seconds digits to flash.
- ④ Hold down (A) for at least two seconds. Release when [PAIR CLR] stops flashing. This deletes the pairing information from the watch.
- ⑤ Press (E) to return to the Timekeeping Mode.

Changing to a Different Phone Model

Q1 Connecting the current watch to another phone.

Pair the watch with the phone.

[If you purchase another phone](#)

Auto Time Adjustment by Bluetooth Connection (Time Adjustment)

Q1 When does the watch adjust its time?

The watch will connect with the phone and perform auto time adjustment at around 12:30 a.m., 6:30 a.m., 12:30 p.m. and 6:30 p.m. The connection is automatically terminated after auto time adjustment is complete.

Q2 Auto time adjustment is performed, but the time setting is not correct.

Is auto time adjustment not being performed according to its normal schedule?

Note that auto time adjustment is not performed for 24 hours after swapping of the Home Time and World Time, or after the time setting is adjusted manually on the watch. Auto time adjustment will resume 24 hours after either of the above operations is performed.

Is auto time adjustment enabled?

Auto time adjustment will not be performed at the scheduled times unless it is enabled. Enable auto time adjustment.

[Using the Watch in a Medical Facility or Aircraft](#)

Q3 Time is not displayed correctly.

If your phone is unable to receive a signal because you are outside its service range or for some other reason, the watch may not be able to display the correct time. If this happens, connect the phone to its network and then adjust the time setting.

Altitude Measurement

Q1 Readings produce different results at the same location.
Watch readings are different from altitude information available from other sources.
Correct altitude readings are not possible.

Relative altitude is calculated based on changes in barometric pressure measured by the watch's pressure sensor. This means that barometric pressure changes can cause readings taken at the same location to be different. Also note that the value displayed by the watch may be different from the actual elevation and/or sea level elevation indicated for the area where you are located. When using the watch's altimeter while mountain climbing, it is recommended that you regularly calibrate its readings in accordance with local altitude (elevation) indications.

[Calibrating Altitude Readings \(Offset\)](#)

Q2 Following a relative altitude reading, the watch's second hand points to 9 o'clock.

The second hand will move to 9 o'clock if a reading is outside the allowable altitude measurement range (-700 m to 10,000 m (-2,300 to 32,800 feet)). If [ERR] is displayed, there may be a problem with the sensor.

[Checking the Altitude Differential from a Reference Point](#)

Q3 [ERR] appears during measurement.

There may be a problem with the sensor. Try taking another measurement.

If [ERR] keeps appearing after multiple measurement attempts, contact a CASIO service center or your original retailer.

Digital Compass

Q1 The entire display is flashing.

Abnormal magnetism has been detected. Move away from any potential source of strong magnetism and try taking a reading again.

[Digital Compass Reading Precautions](#)

- If the display flashes again, it could mean that the watch itself has become magnetized. Move away from any potential source of strong magnetism, perform figure 8 calibration or 2-point calibration, and then try taking a reading again.

[Calibrating Compass Readings](#)

Q2 [ERR] appears during measurement.

There is a problem with the sensor or there may be a source strong magnetic force nearby. Move away from any potential source of strong magnetism and try taking a reading again. If [ERR] keeps appearing after multiple measurement attempts, contact a CASIO service center or your original retailer.

[Digital Compass Reading Precautions](#)

Q3 [ERR] displayed following figure 8 or 2-point calibration.

[ERR] on the display could indicate a sensor problem.

- If [ERR] disappears after about one second, try performing 2-point calibration again.
- If [ERR] keeps appearing after multiple attempts, contact a CASIO service center or your original retailer.

Q4 Direction information indicated by the watch is different from that indicated by a backup compass.

Move away from any potential source of strong magnetism, perform 2-point calibration, and then try taking a reading again.

[Calibrating Compass Readings](#)

[Digital Compass Reading Precautions](#)

Q5 Readings at the same location produce different results.
Cannot take readings indoors.

Move away from any potential source of strong magnetism and try taking a reading again.

[Digital Compass Reading Precautions](#)

Location Memory

Q1 Location Memory does not work.

Is the watch paired with a phone?

The watch needs to be paired with a phone for Location Memory to work. Pair the watch with a phone.

🔗 ③ [Pair the watch with a phone.](#)

Are phone settings configured to acquire location information?

The phone needs to be used to allow use of PRO TREK Connected location information for Location Memory to work. Allow use of location information.

Are phone settings configured to acquire GPS information?

You may experience problems acquiring GPS information in environments like the ones described below.

- Where the view of the sky above is narrow
- Near trees or buildings
- Near a train station, airport, or other congested areas
- Locations where there is heavy traffic and radio wave interference
- Near railway aerial wires, high-voltage lines, TV towers, etc.

Signal reception is not possible in the locations described below.

- Where the sky is not visible
- Underground, in a tunnel, under water
- Indoors (Reception may be possible near a window.)
- Near radio communication equipment or other devices that generate electromagnetic waves

Location Indicator

Q1 Location Indicator does not appear on the display.

Is the watch paired with a phone?

The watch needs to be paired with a phone for Location Indicator to work. Pair the watch with a phone.

🔗 ③ [Pair the watch with a phone.](#)

Is Location Memory information being recorded?

Location information needs to be recorded in Location Memory for Location Indicator to work. Record location information in Location Memory.

🔗 [Recording Your Current Location \(Location Memory\)](#)

Are phone settings configured to acquire location information?

The phone needs to be used to allow use of PRO TREK Connected location information for Location Indicator to work. Allow use of location information.

Are phone settings configured to acquire GPS information?

You may experience problems acquiring GPS information in environments like the ones described below.

- Where the view of the sky above is narrow
- Near trees or buildings
- Near a train station, airport, or other congested areas
- Locations where there is heavy traffic and radio wave interference
- Near railway aerial wires, high-voltage lines, TV towers, etc.

Signal reception is not possible in the locations described below.

- Where the sky is not visible
- Underground, in a tunnel, under water
- Indoors (Reception may be possible near a window.)
- Near radio communication equipment or other devices that generate electromagnetic waves

Barometric Pressure Measurement

Q1 Following a relative barometric pressure reading, the watch's second hand points to 9 o'clock.

The second hand will move to 9 o'clock if a reading is outside the allowable barometric pressure measurement range (260 hPa to 1,100 hPa (7.65 inHg to 32.45 inHg)). If [ERR] appears on the display, there may be a problem with the sensor.

🔗 [Checking the Change in Barometric Pressure between Two Readings](#)

Q2 [ERR] appears during measurement.

There may be a problem with the sensor. Try taking another measurement. If [ERR] keeps appearing after multiple measurement attempts, contact a CASIO service center or your original retailer.

Temperature Measurement

Q1 [ERR] appears during measurement.

There may be a problem with the sensor. Try taking another measurement. If [ERR] keeps appearing after multiple measurement attempts, contact a CASIO service center or your original retailer.

World Time

Q1 The time for a World Time City is not correct.

The summer time setting (standard time/summer time) may be wrong.

🔗 [Specifying a World Time City](#)

Pedometer

Q1 Displayed step count is not correct.

While the watch is on your wrist, the pedometer may detect non-step movements and count them as steps.

[Pedometer](#)

Also, step count problems can also be caused by how the watch is being worn and abnormal arm movement while walking.

[Causes of Incorrect Step Count](#)

Q2 The step count does not increase.

To avoid miscounting of non-walking movements, the step count is not displayed at the beginning of a walk.

It appears only after you have continued walking for about 10 seconds, with the number of steps you took during the first 10 seconds included in to the total.

Q3 [ERR] appears when using the pedometer.

[ERR] (error) indicates that sensor operation is disabled because of sensor or internal circuitry malfunction.

If the indicator remains on the display for more than three minutes or if it frequently appears, it could indicate a faulty sensor.

Contact a CASIO service center or your original retailer.

Alarm

Q1 The alarm does not sound.

Is the alarm setting turned on? If it isn't, turn it on so it will sound.

[Configuring Alarm Settings](#)

Hand Movement and Watch Screen Indications

Q1 I don't know what mode the watch is in.

You can determine the current mode by checking the watch display. Use (D) to navigate between modes.

[Navigating Between Modes](#)

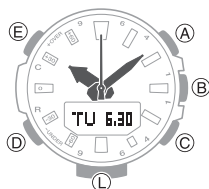

Q2 All hands are stopped and buttons do not work.

The battery is dead. Have the battery replaced.

[Battery Replacement](#)

Q3 The hands suddenly start moving at high speed.

This is due to one of the reasons below, and does not indicate malfunction. Simply wait until normal hand movement resumes.

- Watch is connected with a phone to adjust its time setting.

[Auto Time Adjustment](#)

Q4 The current time indicated by the watch is off by one hour or 30 minutes.

The summer time setting may not be correct. Select the correct setting.

[Changing the Home City Summer Time Setting](#)

Q5 The time indicated by the hands is different from the digital time.

Strong magnetism or impact can cause the hands to go out of alignment. Adjust hand alignment.

[Adjusting Hand Alignment](#)

- Check the information below to find out how to align the hands manually.

[Hand Alignment Adjustment](#)

Fishing Point

Q1 Can this watch be used for freshwater fishing, too?

You can use PRO TREK Connected to set a favorite location as a fishing point.

With the exception of Tide Graph, correct information for the location you specify will be displayed. You can also disable display of the Tide Graph on the watch. Even if you do not display the Tide Graph on the watch, you can still view it using PRO TREK Connected's FISH MEMO.

[Mode Customization](#)

[Recording Catch Conditions \(FISH MEMO\)](#)

Q2 Can a fishing point be set using watch operations?

A fishing point can be set manually using watch operations.

You can improve the accuracy of the displayed information by configuring settings accordance with information available on the internet or in a newspaper.

- 1 Enter the FISH Mode.

[Navigating Between Modes](#)

- 2 Hold down (E) for at least two seconds. Release the button when [SET] starts to flash and then disappears from the display.

After the high tide time for that day appears, the minutes digits will become selected so you can change them.

- 3 Use (A) and (C) to change the high tide time minute setting.

- 4 Press (D).

This causes the hours digits to become selected.

- 5 Use (A) and (C) to change the high tide time hour setting.

- 6 Use (D) to navigate between setting items. Each press of the button cycles through setting items as shown below.

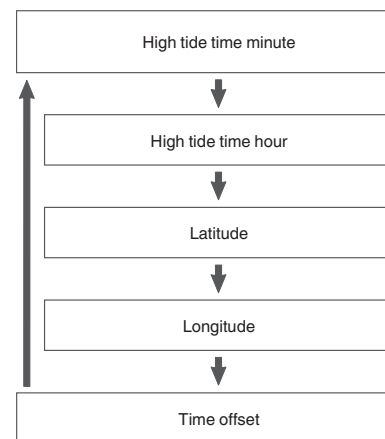

- 7 Use (A) and (C) to specify the latitude, longitude, and time offset.

- 8 Press (E) to complete the setting operation.

- If you set a fishing point using watch operations, the watch fishing point may be different from the PRO TREK Connected fishing point.

FISH MEMO

Q1 The sunrise and sunset times of FISH MEMO are different from the watch's sunrise and sunset times.

The FISH MEMO sunrise and sunset times are calculated from the day's latest FISH MEMO location information, which is obtained by PRO TREK Connected.

Because of this, if a FISH MEMO is obtained for a location that is different from the Fishing Point set on the watch, the sunrise and sunset times of the obtained FISH MEMO may end up being different from watch's Fishing Point sunrise and sunset times.

Before obtaining a FISH MEMO, it is recommended you ensure that the watch's Fishing Point is the same location as the FISH MEMO.

Battery

Q1  is flashing on the digital display.

This indicates that battery power is getting low.

Have the battery replaced.

[🔗 Battery Replacement](#)

Q2 [RECOVER] is flashing on the digital display.

[RECOVER] may appear on the display when the watch's battery power is low, or if you use the light or other function a number of times during a short period, which momentarily causes the battery level to go low. If this happens, all watch functions, except for timekeeping, are disabled.

If [RECOVER] remains on the display or if it keeps appearing, it may indicate that the battery needs to be replaced.

Free Manuals Download Website

<http://myh66.com>

<http://usermanuals.us>

<http://www.somanuals.com>

<http://www.4manuals.cc>

<http://www.manual-lib.com>

<http://www.404manual.com>

<http://www.luxmanual.com>

<http://aubethermostatmanual.com>

Golf course search by state

<http://golfingnear.com>

Email search by domain

<http://emailbydomain.com>

Auto manuals search

<http://auto.somanuals.com>

TV manuals search

<http://tv.somanuals.com>