

CELVIANO

AP-260

USER'S GUIDE

GUÍA DEL USUARIO

Please keep all information for future reference.
Guarde toda información para tener como referencia futura.

Safety Precautions

Before trying to use the piano, be sure to read the separate "Safety Precautions".

Precauciones de seguridad

Antes de intentar usar el piano, asegúrese de leer las "Precauciones de seguridad" separadas.

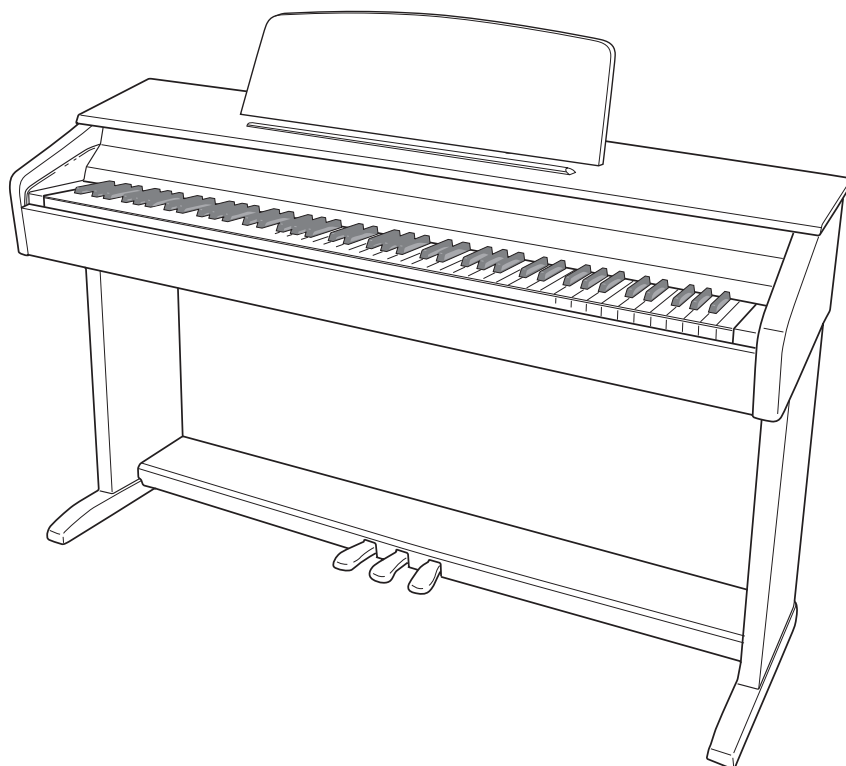

IMPORTANT SAFETY INSTRUCTIONS

1. Read these instructions.
2. Keep these instructions.
3. Heed all warnings.
4. Follow all instructions.
5. Do not use this apparatus near water.
6. Clean only with dry cloth.
7. Do not block any ventilation openings. Install in accordance with the manufacturer's instructions.
8. Do not install near any heat sources such as radiators, heat registers, stoves, or other apparatus (including amplifiers) that produce heat.
9. Do not defeat the safety purpose of the polarized or grounding-type plug. A polarized plug has two blades with one wider than the other. A grounding type plug has two blades and a third grounding prong. The wide blade or the third prong are provided for your safety. If the provided plug does not fit into your outlet, consult an electrician for replacement of the obsolete outlet.
10. Protect the power cord from being walked on or pinched particularly at plugs, convenience receptacles, and the point where they exit from the apparatus.
11. Only use attachments/accessories specified by the manufacturer.
12. Use only with the cart, stand, tripod, bracket, or table specified by the manufacturer, or sold with the apparatus. When a cart is used, use caution when moving the cart/apparatus combination to avoid injury from tip-over.
13. Unplug this apparatus during lightning storms or when unused for long periods of time.
14. Refer all servicing to qualified service personnel. Servicing is required when the apparatus has been damaged in any way, such as power-supply cord or plug is damaged, liquid has been spilled or objects have fallen into the apparatus, the apparatus has been exposed to rain or moisture, does not operate normally, or has been dropped.



The apparatus shall not be exposed to dripping or splashing and that no objects filled with liquids, such as vases, shall be placed on the apparatus.

The  (Power) indicator being unlit does not mean the apparatus is completely disconnected from the MAINS. When you need to have the apparatus completely disconnected from the MAINS, you must unplug the power cord. For that purpose, locate the apparatus in a way that secures easy access to the power cord.

NOTICE

This equipment has been tested and found to comply with the limits for a Class B digital device, pursuant to Part 15 of the FCC Rules. These limits are designed to provide reasonable protection against harmful interference in a residential installation. This equipment generates, uses and can radiate radio frequency energy and, if not installed and used in accordance with the instructions, may cause harmful interference to radio communications. However, there is no guarantee that interference will not occur in a particular installation. If this equipment does cause harmful interference to radio or television reception, which can be determined by turning the equipment off and on, the user is encouraged to try to correct the interference by one or more of the following measures:

- Reorient or relocate the receiving antenna.
- Increase the separation between the equipment and receiver.
- Connect the equipment into an outlet on a circuit different from that to which the receiver is connected.
- Consult the dealer or an experienced radio/TV technician for help.

FCC CAUTION

Changes or modifications not expressly approved by the party responsible for compliance could void the user's authority to operate the equipment.

Declaration of Conformity

Model Number: AP-260
Trade Name: CASIO COMPUTER CO., LTD.
Responsible party: CASIO AMERICA, INC.
Address: 570 MT. PLEASANT AVENUE, DOVER, NEW JERSEY 07801
Telephone number: 973-361-5400

This device complies with Part 15 of the FCC Rules, Operation is subject to the following two conditions:

(1) This device may not cause harmful interference, and (2) this device must accept any interference received, including interference that may cause undesired operation.

Important!

Please note the following important information before using this product.

- Before using the AD-A12150LW Adaptor to power the unit, be sure to check the AC Adaptor for any damage first. Carefully check the power cord for breakage, cuts, exposed wire and other serious damage. Never let children use an AC adaptor that is seriously damaged.
- The product is not intended for children under 3 years.
- Use only CASIO AD-A12150LW adaptor.
- The AC adaptor is not a toy.
- Be sure to disconnect the AC adaptor before cleaning the product.

Declaration of Conformity According to EU Directive



This mark applies in EU countries only.



Manufacturer:
CASIO COMPUTER CO., LTD.
6-2, Hon-machi 1-chome, Shibuya-ku, Tokyo 151-8543, Japan
Responsible within the European Union:
CASIO EUROPE GmbH
Casio-Platz 1, 22848 Norderstedt, Germany

Contents

Assembling the Stand..... EN-37

Unpacking.....	EN-37	To install the music stand.....	EN-40
To assemble the stand	EN-37	Removing the Protective Tape	
To connect the pedal cord	EN-40	from the Keyboard.....	EN-40

General Guide EN-4

FUNCTION Button.....	EN-5
Saving Settings and Using Operation Lock	EN-6
Returning the Digital Piano to Its Factory Default Settings.....	EN-6

Getting Ready EN-7

Power Outlet.....	EN-7
Using an AC Adaptor.....	EN-7
Turning Power On or Off.....	EN-8
Connections.....	EN-8
Connecting Headphones.....	EN-8
Connecting Audio Equipment or an Amplifier.....	EN-9
Bundled and Optional Accessories.....	EN-9

Playing with Different Tones EN-10

Selecting and Playing a Tone.....	EN-10
Layering Two Tones.....	EN-12
Using Effects.....	EN-13
Using the Digital Piano's Pedals.....	EN-14
Using the Metronome.....	EN-15
Playing a Piano Duet.....	EN-16

Using Built-in Songs (Concert Play, Music Library, Demo Tunes)..... EN-18

Performing Demo Play.....	EN-18
Concert Play.....	EN-19
Practicing with a Concert Play Song.....	EN-19
Music Library.....	EN-21
Playing Back a Specific Music Library Song.....	EN-21
Practicing with a Music Library Song.....	EN-21

Recording and Play Back..... EN-22

Tracks.....	EN-22
To record to a specific track of a song.....	EN-23
To record to one track of a song while listening to the playback of the other track.....	EN-24
Playing Back from Digital Piano Memory.....	EN-24
Deleting Recorded Data.....	EN-25

Configuring Settings with the Keyboard EN-26

To configure settings with the keyboard.....	EN-26
Keyboard Keys Used for Configuring Settings.....	EN-28
Parameter List.....	EN-29
Reverb (REVERB).....	EN-29
Tone selection.....	EN-29
Chorus (CHORUS).....	EN-29
Brilliance (BRILLIANCE).....	EN-29
Layer balance.....	EN-29
Duet pan.....	EN-29
Bass damper effect.....	EN-29
Damper noise.....	EN-29
Music Library song select (MUSIC LIBRARY SELECT).....	EN-30
Tempo (TEMPO).....	EN-30
Beat (BEAT).....	EN-30
Metronome tempo (METRONOME TEMPO).....	EN-30
Metronome beat (METRONOME BEAT).....	EN-30
Concert Play song Play/Stop (CONCERT PLAY ▶/■).....	EN-30
Listen (LISTEN).....	EN-30
Lesson (LESSON).....	EN-30
Play (PLAY).....	EN-30
Concert Play song select (SELECT +/-).....	EN-30
Concert Play volume (VOLUME +/-).....	EN-30
Music Library volume (ML Volume).....	EN-30
Metronome volume.....	EN-30
Temperament.....	EN-31
Temperament Base note.....	EN-31
Temperament select.....	EN-31
Touch response (TOUCH RESPONSE).....	EN-31
Keyboard key (Transpose) (TRANSPOSE).....	EN-31
Keyboard tuning (Tuning).....	EN-31
Octave shift.....	EN-31
USB device mode.....	EN-32
Local control.....	EN-32
Send channel.....	EN-32
Operation tone.....	EN-32
Back up.....	EN-32
Operation lock.....	EN-32

Connecting to a Computer..... EN-33

Minimum Computer System Requirements.....	EN-33
Connecting the Digital Piano to Your Computer.....	EN-33
Using MIDI.....	EN-34
Transferring Song Data with a Computer.....	EN-34

Reference EN-41

Troubleshooting	EN-41
Product Specifications	EN-42
Operating Precautions	EN-43

Appendix A-1

Tone List	A-1
Concert Play List	A-1
Music Library List	A-1

MIDI Implementation Chart

Company and product names used in this manual may be registered trademarks of others.

General Guide

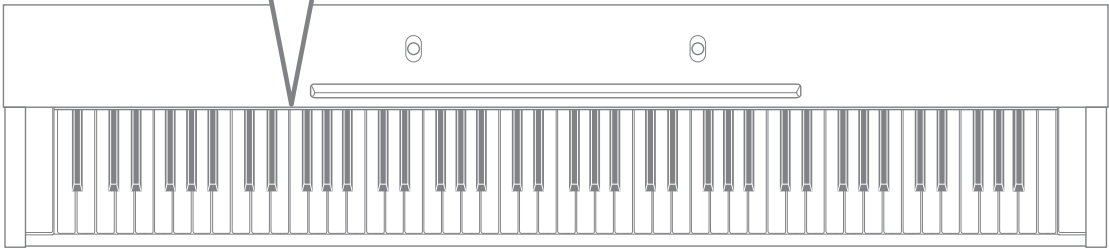
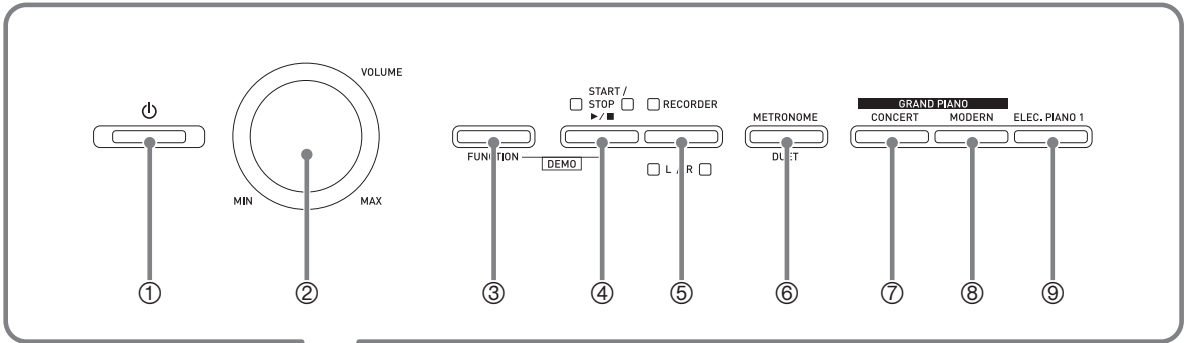

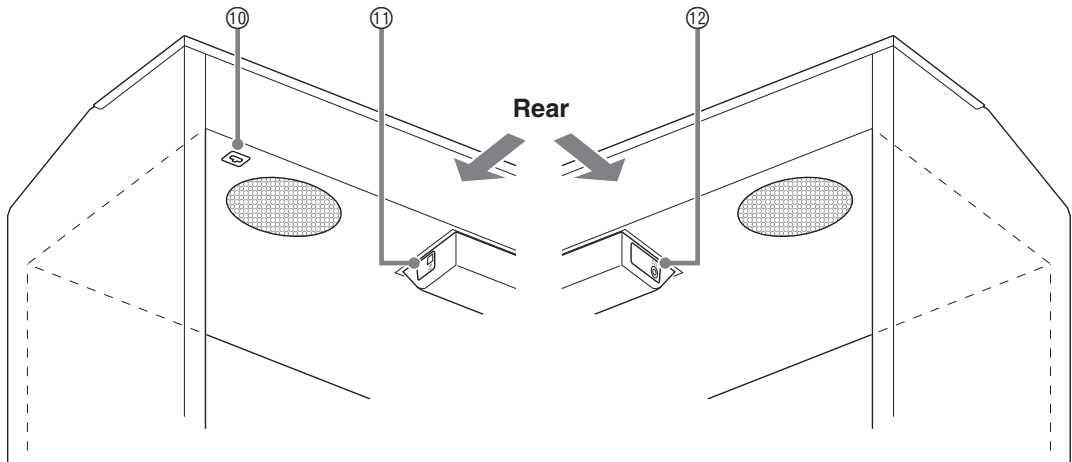

Bottom

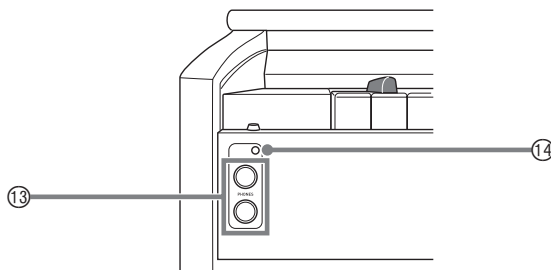

Front



 **NOTE**

- The names shown here are always indicated in bold when they appear within the text of this manual.
- | | |
|--|--------------------------------------|
| ①  (Power) button | ⑧ GRAND PIANO (MODERN) button |
| ② VOLUME controller | ⑨ ELEC. PIANO 1 button |
| ③ FUNCTION button | ⑩ Pedal connector |
| ④ START/STOP  , DEMO button | ⑪ USB port |
| ⑤ RECORDER (L/R) button | ⑫ DC 12V terminal |
| ⑥ METRONOME, DUET button | ⑬ PHONES jacks |
| ⑦ GRAND PIANO (CONCERT) button | ⑭ Power lamp |

FUNCTION Button

The **FUNCTION** button is used when configuring a variety of different Digital Piano settings. The following are **FUNCTION** button basics.

- To change a setting, hold down the **FUNCTION** button as you press the keyboard key that is assigned the setting you want to select. An operation confirmation tone will sound whenever you press a keyboard key to configure a setting.

Example: "To select a tone" on page EN-10

 **NOTE**

- For details about operations and settings, see "Configuring Settings with the Keyboard" on page EN-26.
- The following table shows how pressing the **FUNCTION** button changes the operation of certain buttons.



This button:	Does this while FUNCTION button is depressed:
START/STOP 	Starts and stops demo tune play.
RECORDER	Selects the left-hand part and the right-hand part.
METRONOME	Toggles Duet on and off.

Saving Settings and Using Operation Lock

Your Digital Piano lets you save its current settings and lock its buttons to protect against operation errors. For details, see “Parameter List” on pages EN-29 - EN-32.

Returning the Digital Piano to Its Factory Default Settings

Perform the following procedure when you want to return the Digital Piano’s stored data and settings to their initial factory defaults.

1. Turn off the Digital Piano.
2. While holding down both the **ELEC. PIANO 1** and **FUNCTION** buttons, press the  (Power) button.
3. Keep the **ELEC. PIANO 1** button and **FUNCTION** button depressed as the Digital Piano performs the operation described below.
 - (1) The **GRAND PIANO (CONCERT)**, **GRAND PIANO (MODERN)**, and **ELEC. PIANO 1** button indicator lamps start to flash in sequence.
 - (2) The flashing sequence gradually increases in speed.
 - (3) After some time, the flashing will stop.
4. Release the **ELEC. PIANO 1** button and **FUNCTION** button.
 - The Digital Piano will initialize its internal system. You will be able to use the Digital Piano in a short while.

NOTE

- See “Turning Power On or Off” (page EN-8) for information about turning power on and off.

Getting Ready

Power Outlet

Your Digital Piano runs on standard household power. Be sure to turn off power whenever you are not using the Digital Piano.

Using an AC Adaptor

Use only the AC adaptor (JEITA Standard, with unified polarity plug) that comes with this Digital Piano. Use of a different type of AC adaptor can cause malfunction of the Digital Piano.

Specified AC Adaptor: AD-A12150LW

- Use the supplied power cord to connect the AC adaptor as shown in the illustration below.
- Secure the AC adaptor cord with the clip you affixed next to the power terminal (page EN-39).

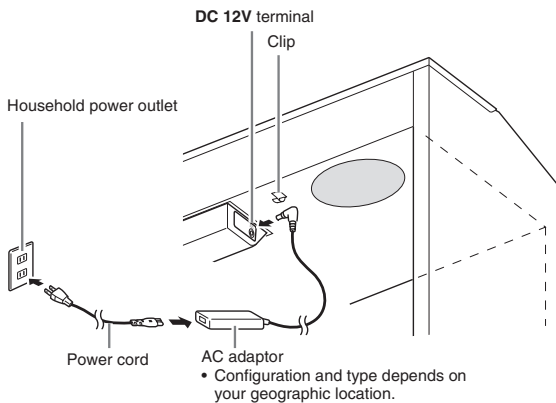

■ To fasten the clip

As shown in the illustration, press down on (a) to force the tip of the clip into the slot. Press down until you hear the clip click securely into place.

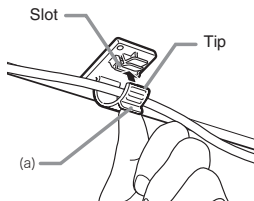

■ To release the clip

As shown in the illustration, press (b) in the direction indicated by the arrow.

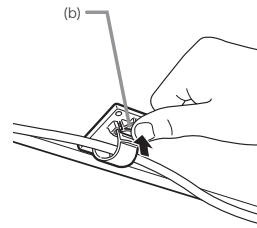

Note the following important precautions to avoid damage to the power cord.

During Use

- Never pull on the cord with excessive force.
- Never repeatedly pull on the cord.
- Never twist the cord at the base of the plug or connector.

During Movement

- Before moving the Digital Piano, be sure to unplug the AC adaptor from the power outlet.

During Storage

- Loop and bundle the power cord, but never wind it around the AC adaptor.

IMPORTANT!

- Never connect the AC adaptor (JEITA Standard, with unified polarity plug) that comes with this Digital Piano to any other device besides this piano. Doing so creates the risk of malfunction.
- Make sure the Digital Piano is turned off before plugging in or unplugging the AC adaptor.
- The AC adaptor will become warm to the touch after very long use. This is normal and does not indicate malfunction.

Turning Power On or Off

1. Press the  (Power) button to turn on Digital Piano power.

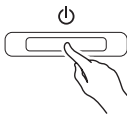

- This causes the  (Power) button to light.
- When you turn on the Digital Piano, it performs a power up operation in order to initialize its system. During system initialization the tone button lamps cycle on and off in the sequence for about five seconds to let you know that system initialization is in progress.

2. To turn off the Digital Piano, hold down the  (Power) button until its light goes out.

NOTE



- Pressing the  (Power) button to turn off power actually puts the Digital Piano into a standby state. Minute amounts of current continue to flow within the Digital Piano in the standby state. If you do not plan to use the Digital Piano for a long time or if there is a lightning storm in your area, be sure to unplug the AC adaptor from the power outlet.

Auto Power Off

This Digital Piano is designed to turn off automatically to avoid wasting power after no operation is performed for a preset amount of time. The Auto Power Off trigger time is about four hours.

- You also can use the procedure below to temporarily suspend Auto Power Off.

■ To disable Auto Power Off

1. While the Digital Piano is turned on, press the  (Power) button to turn it off.
2. While holding down the **FUNCTION** button, press the  (Power) button to turn on the Digital Piano.



- Auto Power Off will be disabled at this time.

NOTE

- Turning off the Digital Piano after performing the above steps will re-enable Auto Power Off.

Connections

IMPORTANT!

- Whenever connecting something to the Digital Piano, first use the **VOLUME** controller to set the volume to a low level. After connecting, you can adjust the volume to the level you want.

Connecting Headphones

Front

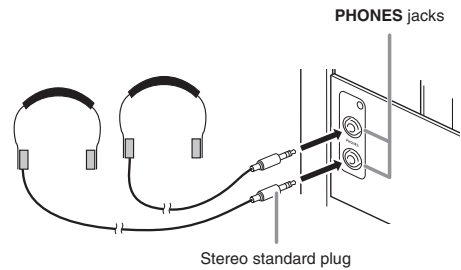

Connecting headphones to either of the **PHONES** jack cuts off output to the speakers, which means you can practice even late at night without bothering others. To protect your hearing, make sure that you do not set the volume level too high when using headphones.

NOTE

- Be sure to push the headphones plug into the **PHONES** jacks as far as it will go. If you don't, you may hear sound from only one side of the headphones.
- If the plug of the headphones you are using does not match the **PHONES** jacks, use the applicable commercially available adaptor plug.
- If you are using headphones that require an adaptor plug, make sure you do not leave the adaptor plugged in when you unplug the headphones. If you do, nothing will sound from the speakers when you play.

Connecting Audio Equipment or an Amplifier

You can connect audio equipment or a music amplifier to the Digital Piano and then play through external speakers for more powerful volume and better sound quality.

To either of the Digital Piano's **PHONES** jack

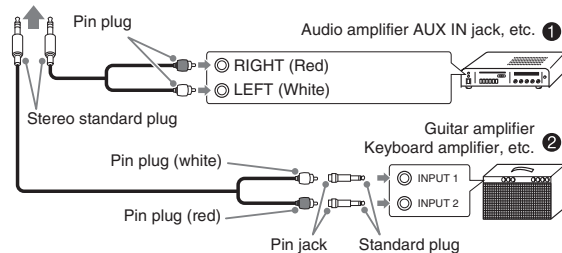

Connecting Audio Equipment (Figure ①)

Use commercially available connecting cords (Standard Plug × 1, Pin Plugs × 2) to connect as shown in Figure ①. Make sure that the end of the cord that you connect to the Digital Piano is a stereo standard plug. A monaural standard plug will result in output of only one of the two stereo channels. Normally, you should set the input selector of the audio equipment to the terminal where the Digital Piano is connected (AUX IN, etc.) Adjust volume using the Digital Piano's **VOLUME** controller.

Connecting a Music Amplifier (Figure ②)

Connect the connecting cord* to one of the types of amplifiers shown in Figure ②. Adjust volume using the Digital Piano's **VOLUME** controller.

* Digital Piano: Stereo standard plug

Amplifier : Inputs signals for the left and right channels. Not connecting either plug will result in output of only one of the two stereo channels.

Bundled and Optional Accessories

Use only accessories that are specified for use with this Digital Piano.

Use of unauthorized accessories creates the risk of fire, electric shock, and personal injury.

NOTE

- You can get information about accessories that are sold separately for this product from the CASIO catalog available from your retailer, and from the CASIO website at the following URL.

<http://world.casio.com/>

Playing with Different Tones

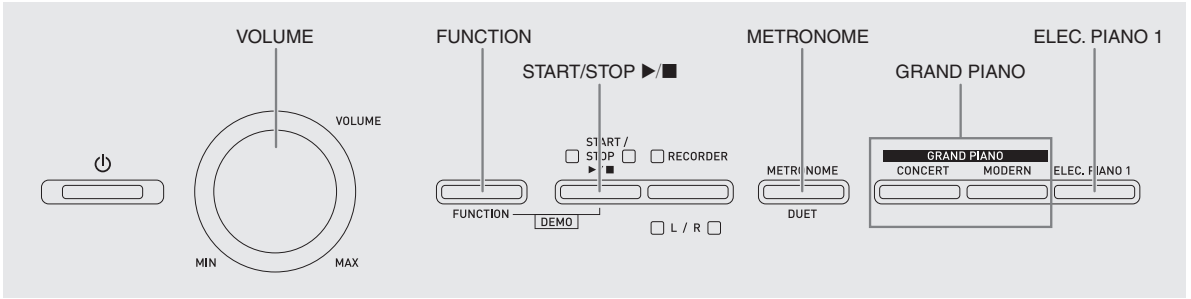

Selecting and Playing a Tone

The piano comes with 18 built-in tones.

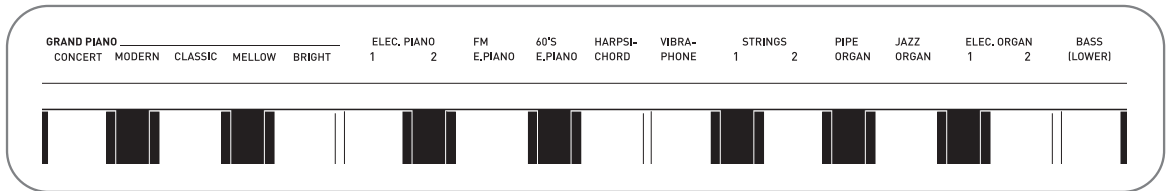

- The names of the tones are marked above the keyboard keys to which they are assigned.

To select a tone

1. Select the tone you want.

- To select GRAND PIANO (CONCERT or MODERN) or ELEC. PIANO 1
 - Press one of the **GRAND PIANO** buttons (CONCERT or MODERN) or the **ELEC. PIANO 1** button to select the one you want.

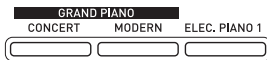

- The button lamp of the selected tone will light.

- To select one of the other tones
 - While holding down the **FUNCTION** button, press the keyboard key that corresponds to the tone you want to select.

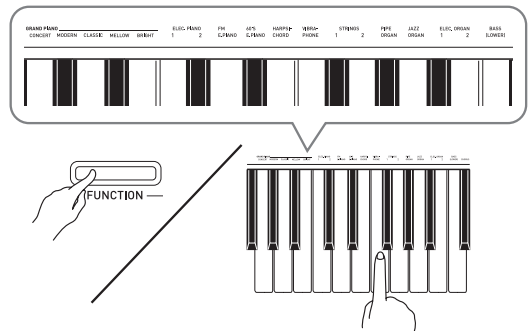

2. Use the **VOLUME** controller to adjust the volume.

 **NOTE**

- Of the Digital Piano's 18 built-in tones, the first five are grand piano tone. Each tone has its own distinctive merits, so you should select the tone that suits the song you are playing along with or your own personal preferences. The CONCERT and MODERN tones are assigned to buttons for quick and easy selection.

Tone Name	Characteristics
CONCERT	This is a full concert grand piano tone that uses Linear Morphing* for dynamic and natural tone changes. This tone is designed to reproduce damper, resonance, and other piano nuances, which makes it ideal for virtually any type of piano performance.
MODERN	This tone provides a bright grand piano sound. The volume and timbre of this tone is quick to respond to different keyboard pressures, and it has relatively deep reverb. This tone is a good choice for dynamic and lively performances.
CLASSIC	This is a natural piano tone that closely resembles the sound of an acoustic piano. Though reverb and other flashy effects are subdued for this tone, resonance is more pronounced, which enables expression of delicate nuances. This tone is a good choice for lesson and practice sessions.
MELLOW	Warm and mellow piano tone
BRIGHT	Bright and clear piano tone

* Feature that applies computer morphing technology to enable seamless changes between sounds sampled at various dynamics from a full concert grand piano.

Bass Tone (BASS)

Selecting BASS (LOWER) tone in step 1 of the above procedure will assign the selected bass tone to the low range (left side) of the keyboard. The high range (right side) will be assigned the tone that was selected when you pressed the BASS (LOWER) key.

- BASS (LOWER) lets you effectively split the keyboard between two different tones.

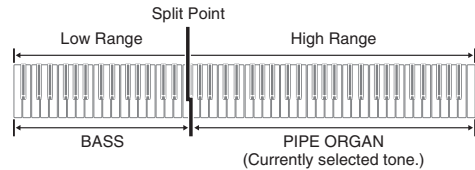
 **NOTE**

- To return the keyboard to a single tone, select any tone other than BASS (LOWER).
- You cannot select BASS (LOWER) when recording to Track 2.
- You can configure settings to sustain reverberation of the BASS (LOWER) tone while the damper pedal or sostenuto pedal is pressed. For more information, see "Bass damper effect" (page EN-29).

Layering Two Tones

Use the following procedure to layer two tones, so they sound at the same time.

When specifying two tones for layering, first tone you select will be the main tone, while the second tone will be the layered tone.

1. While holding down the **FUNCTION** button, press down the keyboard key for the first tone you want to layer and then the key for the second tone.

Example: First press the **HARPSICHORD** key and then the **ELEC.ORGAN 1** key.

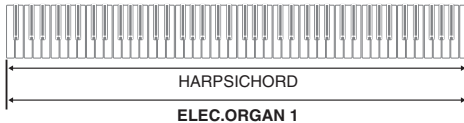
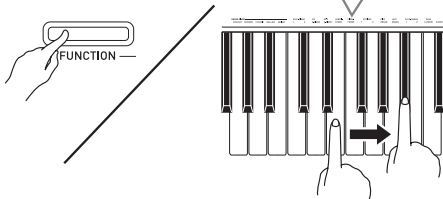
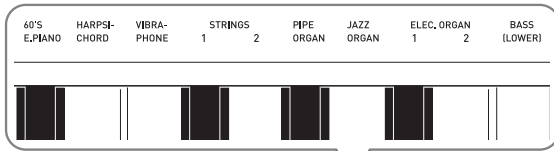

2. To unlayer the keyboard, select another tone by pressing the **GRAND PIANO** button or by using the procedure under “Selecting and Playing a Tone” (page EN-10).

NOTE

- You cannot layer the BASS (LOWER) tone with another tone.
- You cannot perform the layer operation when recording to Track 2.

To adjust the volume balance between two layered tones

1. While holding down the **FUNCTION** button, use the keyboard keys shown below to adjust the volume of the layered tones.

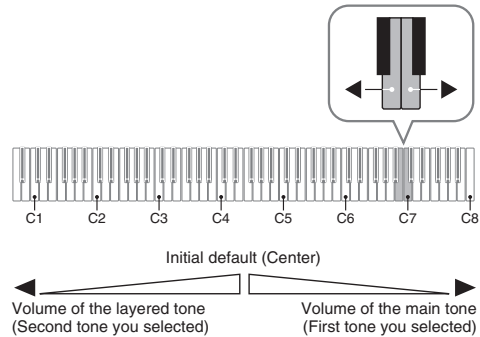

- To return the volume setting to its initial default, hold down the **FUNCTION** button and press both of the keys at the same time.

Using Effects

Reverb : Makes your notes resonate.

Chorus: Adds more breadth to your notes.

To apply reverb

1. While holding down the **FUNCTION** button, press the keyboard key that corresponds to the type of reverb you want to select.

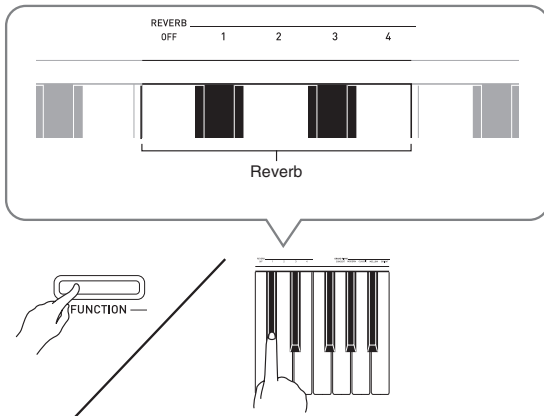

Keyboard Key	Setting
OFF	Off (OFF)
1	Room
2	Small Hall
3	Large Hall
4	Stadium

To apply chorus to a tone

1. While holding down the **FUNCTION** button, use the **CHORUS** keyboard key to cycle through the available settings.
 - Each press of the CHORUS keyboard key causes the Digital Piano to beep according to which setting is selected, as shown in the table below.

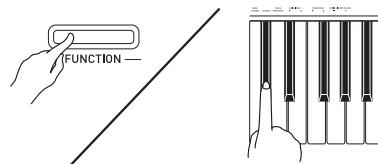
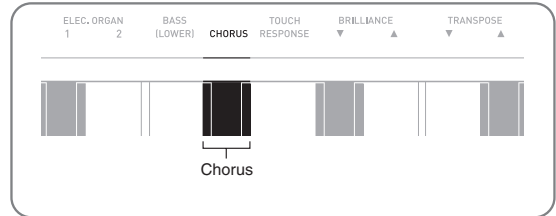

Number of Beeps	Setting
1 (long)	Off (OFF)
1 (short)	Light Chorus
2	Medium Chorus
3	Deep Chorus
4	Flanger (whooshing effect)

■ About DSP

DSP makes it possible to digitally produce complex acoustic effects. The DSP is assigned to each tone whenever you turn on Digital Piano power.

Using the Digital Piano's Pedals

Your Digital Piano comes equipped with three pedals: damper, soft, and sostenuto.

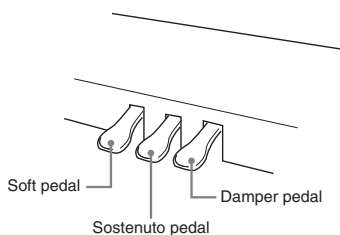

Pedal Functions

● Damper Pedal

Pressing the damper pedal while playing will cause the notes you play to reverberate for a long time.

- When a GRAND PIANO tone (CONCERT/MODERN/CLASSIC/MELLOW/BRIGHT) is selected as the tone, pressing this pedal will cause notes to reverberate (with damper resonance) just like the damper pedal on an acoustic grand piano. Half-pedal operation (pressing the pedal part way) is also supported.

● Soft Pedal

Pressing this pedal while playing suppresses notes played on the keyboard after the pedal was pressed, and makes them sound softer.

● Sostenuto Pedal

Only the notes of the keys that are depressed when this pedal is pressed are sustained until the pedal is released.

NOTE

- If pressing the pedal does not produce the desired effect, it could mean that the pedal cord is not connected properly. Refer to step 1 under "To connect the pedal cord" (page EN-40).

Disabling Damper Noise Output

Damper noise is a slight metallic ringing sound that is generated as the damper of an acoustic piano separates from the wires pedal when the damper pedal is pressed. The damper resonance of your Digital Piano normally includes damper noise, but you can perform the procedure below to disable its output.

1. While holding down the **FUNCTION** button, press the Damper Noise keyboard key (page EN-28).

- Each press of the key toggles the setting and causes the Digital Piano to beep as described below.
 - Long beep: Damper noise output disabled
 - Short beep: Damper noise output enabled
- See "Damper noise" on page EN-29 for more information.

Using the Metronome

1. Press the **METRONOME** button.
 - This starts the metronome.
 - The lamp above the **START/STOP** ►/■ button flash in time with the metronome beat.
2. While holding down the **FUNCTION** button, press the **METRONOME BEAT** keyboard key.

Keep the **FUNCTION** button depressed as you advance to step 3.
3. With the **FUNCTION** button still depressed from the previous step, press one of the **BEAT** keyboard keys (0 to 9) to specify a beat value.

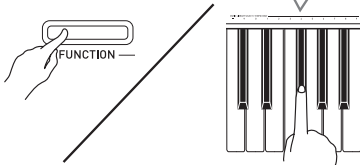
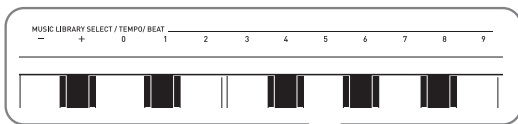

- You can specify a beat value in the range of 0 to 9 (beats per measure). A chime will sound on the first beat of each measure, and clicks will sound for the remaining beats. Specifying 0 plays a straight click, without any chime. This setting lets you practice with a steady beat.

4. Release the **FUNCTION** button and then hold it down again as you press the **METRONOME TEMPO** keyboard key.

Keep the **FUNCTION** button depressed as you advance to step 5.

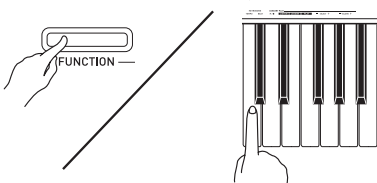
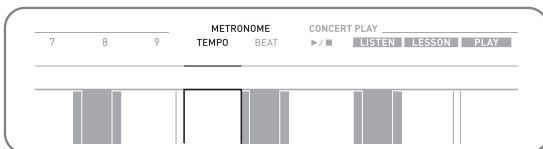

5. While holding down the **FUNCTION** button, use the **TEMPO** keys to specify a tempo value in the range of 20 to 255 beats per minute.

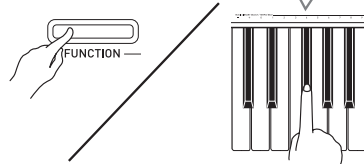
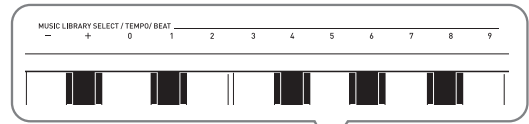

- Each press of the + or – key raises or lowers the tempo value by 1.
- You can use the value input keys (0 to 9) to enter a specific tempo value.

6. Press the **METRONOME** button or **START/STOP** ►/■ button to turn off the metronome.

NOTE

- If you used the value input keys (0 to 9) to input beat and/or tempo values and the values are within the allowable setting ranges, the Digital Piano will emit a high pitch beep when you release the **FUNCTION** button. If a value is outside the allowable range, a low-pitch sound will be emitted.
- You could also use the procedure below in place of steps 4 and 5 of the above procedure to specify a tempo value.
 - While holding down the **METRONOME** button, use the **TEMPO** keyboard keys to specify a tempo value in the range of 20 to 255 (beats per minute).
- In step 5 of the above procedure, pressing the + and – keys at the same time will set the tempo of the Concert Play lesson tune or Music Library tune that was last selected on the Digital Piano. Pressing + and – while recording will return the tempo value to 120.

To adjust the metronome volume

You can perform the following procedure at any time, regardless of whether or not the metronome is sounding.

1. While holding down the **FUNCTION** button, use the Metronome Volume keys to specify a volume value in the range of 0 to 42.
 - For details about using the keyboard keys for settings, see “Keyboard Keys Used for Configuring Settings” on page EN-28.
 - Each press of the ▼ or ▲ key raises or lowers the metronome volume value by 1.

NOTE

- To return to the initial default setting, press ▼ and ▲ at the same time.

Playing a Piano Duet

You can use the Duet Mode to split the piano’s keyboard in the center so two people can play a duet. The left and right side keyboards have virtually the same range. The left pedal operates as the left side damper pedal, while the right pedal is the right side damper pedal.

This makes it possible to configure the keyboard so, for example, the teacher can play on the left and the student can follow along on the right. Or one person can play the left hand part on the left, while another plays the right hand part on the right.

Keyboard

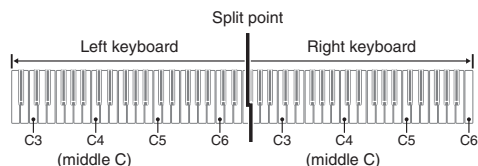

Pedal Operation when Playing a Duet

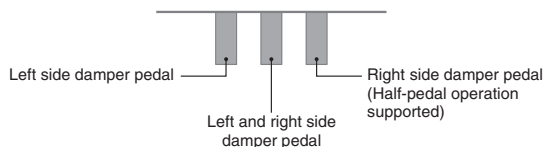

NOTE

- Only the damper pedal for the right side keyboard supports half-pedal operations.

1. Select the piano tone you want to use for the duet.

Example: GRAND PIANO (MODERN)

2. While holding down the **FUNCTION** button, press the **METRONOME** button to toggle duet on and off.

IMPORTANT!

- You cannot use the Duet Mode while recording (page EN-22).

NOTE

- You can configure the piano to output the left side keyboard tone from the left speaker and the right side keyboard tone from the right speaker while duet is turned on. For more information, see “Duet pan” (page EN-29).

Changing the Octaves of the duet keyboards

You can change the ranges of the left and right keyboards in octave units from their initial default settings. This comes in handy, for example, if the initial default range is not enough when one person is playing the left hand part and another person is playing the right hand part.

1. While holding down the **FUNCTION** and **METRONOME** buttons, press the keyboard C key that you want located at C4 (middle C) of the left keyboard.

Keep the **FUNCTION** and **METRONOME** buttons depressed as you advance to step 2, below.

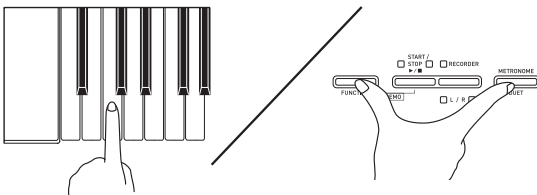

Example: Press the keyboard key of the leftmost C (C4) will assign the range shown below.

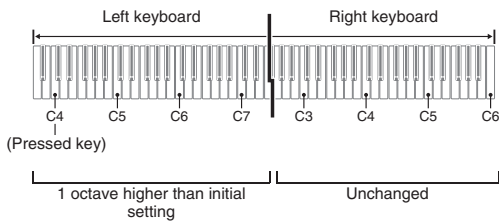

2. While still holding down the **FUNCTION** and **METRONOME** buttons, press the keyboard C key that you want located at C4 (middle C) of the right keyboard.

NOTE

- You can return the keyboards to their initial default ranges by exiting and then re-entering the Duet Mode.

Using Built-in Songs (Concert Play, Music Library, Demo Tunes)

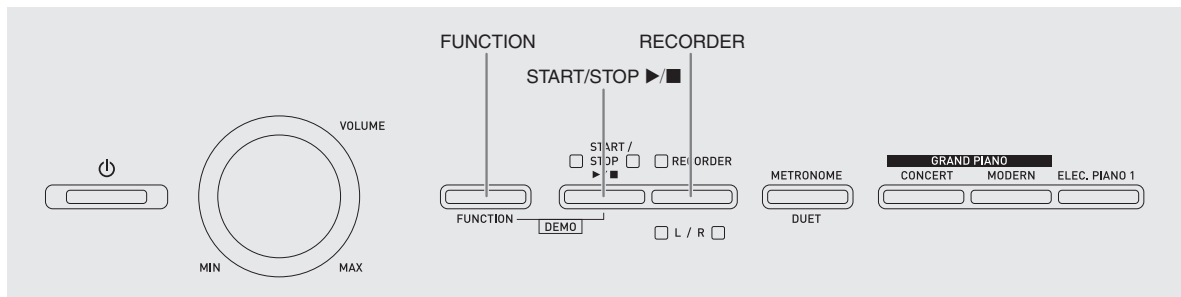

Your Digital Piano comes with 10 built-in piano and orchestra tunes (Concert Play 1 through 10), and 60 piano solos (Music Library 1 to 60).

Concert Play lets you enjoy playing along with orchestral accompaniment. You can use Music Library to practice famous piano pieces.

- You can play all 10 Concert Play tunes in sequence, from beginning to end for your listening enjoyment.

IMPORTANT!

- After you select a built-in song, it can take a number of seconds for the song data to be loaded. While the data is being loaded, the keyboard keys and button operations will be disabled. If you are playing something on the keyboard, the following operation will cause output to stop.

Performing Demo Play

1. While holding down the **FUNCTION** button, press the **START/STOP** button.
 - This will start Concert Play playback from song 1.
 - Songs are played in their Concert Play number sequence.
 - You can play along with a song on the keyboard as it is playing. The tone assigned to the keyboard is the one that is preset for the song that is playing.

2. To change demo playback to a different song, hold down the **FUNCTION** button as you use the **CONCERT PLAY SELECT** keyboard keys (+ and -) to specify a song number.

- Each press of the + or - key raises or lowers the song number by 1.
- For information about Concert Play songs, see the "Concert Play List" on page A-1.

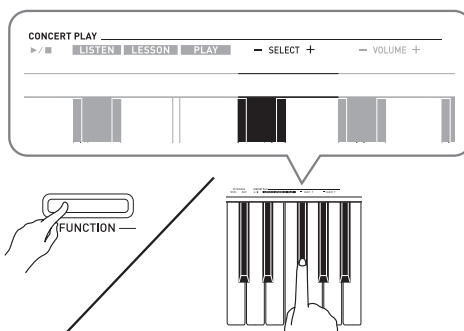

3. Press the **START/STOP** button again to stop built-in song play.

NOTE

- The tune selection and playback stop operations described above are the only operations that are possible during demo tune play.

Concert Play

Concert Play has recordings of a live orchestra, which you can use to play along with authentic accompaniment.

You can also use Concert Play for 3-step practice.

Step 1: LISTEN

Listen to playback of the piano and orchestra to familiarize yourself with the music.

Step 2: LESSON

Practice the Concert Play piano part.

- You can turn off the left hand part or right hand part of a built-in song and play along on the piano.

Step 3: PLAY

Play along with the orchestra accompaniment.

- The Concert Play includes 10 songs, numbered 1 through 10.
- The Concert Play contains actual recordings of an orchestra. Because of this, the instrument sounds are different from the tones that can be selected with this piano (page EN-10). This also means that Concert Play playback includes breath sounds and performance noises.

Practicing with a Concert Play Song

To listen to a Concert Play song (LISTEN)

- While holding down the **FUNCTION** button, use the **CONCERT PLAY SELECT +** and **-** keyboard keys to scroll song numbers in sequences (from 1 to 10).

- For information about Concert Play songs, see the "Concert Play List" on page A-1.

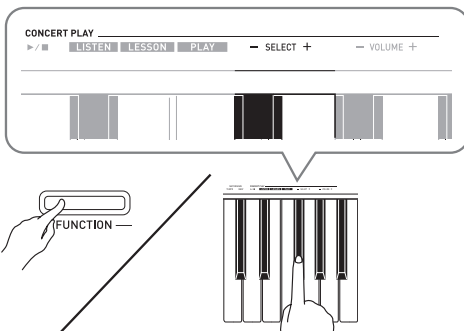

- While holding down the **FUNCTION** button, press the **LISTEN** keyboard key.

- This enters the Listen Mode for listening to the piano and orchestra performance.
- Playback tempo is fixed and cannot be changed during Listen Mode playback.

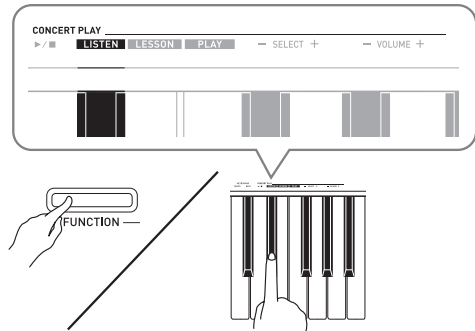

- While holding down the **FUNCTION** button, press the **CONCERT PLAY ▶/■** keyboard key to start playback.

- Playback will stop automatically when the end of the song is reached.

- To stop playback, hold down the **FUNCTION** button as you press the **CONCERT PLAY ▶/■** keyboard key again.

NOTE

- You can use adjust the volume level of the playback, if you want. See "Configuring Settings with the Keyboard" (page EN-26) for more information.

To practice the piano part (LESSON)

PREPARATION

- You can change tempo of the playback, if you want. See "Configuring Settings with the Keyboard" (page EN-26) for more information.
- A number of tunes have tempo changes part way through in order to produce specific musical effects.

1. While holding down the **FUNCTION** button, press the **LESSON** keyboard key.

- This enters the Lesson Mode, which allows simple play along with the piano part.

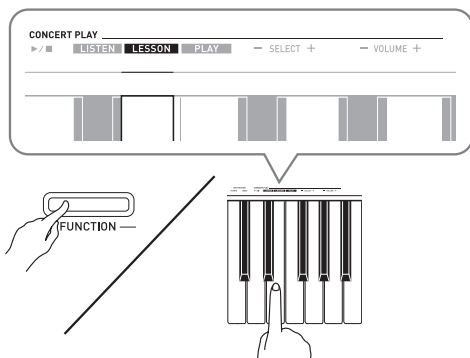

2. While holding down the **FUNCTION** button, press the **RECORDER (L/R)** button to select the part you want to turn off.

- Pressing a button toggles its part on (button lamp on) and off (button lamp off).

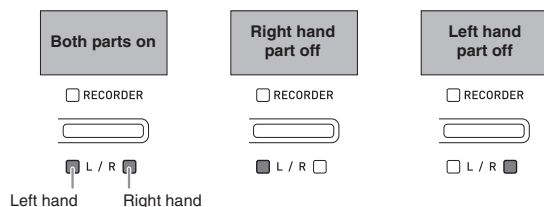

3. While holding down the **FUNCTION** button, press the **CONCERT PLAY ►/■** keyboard key.

- This starts playback, without the part you turned off in step 1.

4. Play the missing part on the keyboard.

5. To stop playback, hold down the **FUNCTION** button as you press the **CONCERT PLAY ►/■** keyboard key again.

To play along with the orchestra accompaniment (PLAY)

1. While holding down the **FUNCTION** button, press the **PLAY** keyboard key.

- This will enter the Play Mode, which plays the orchestra part without the piano part.

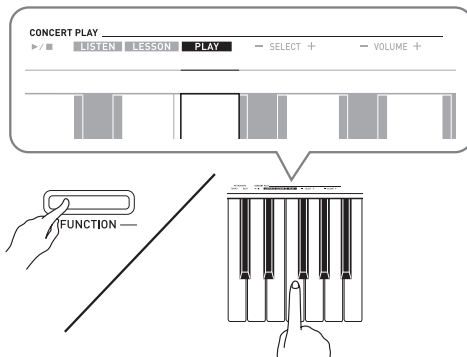

2. While holding down the **FUNCTION** button, press the **CONCERT PLAY ►/■** keyboard key to start playback.

- Playback tempo is fixed and cannot be changed during Play Mode playback.

3. Play the piano part on the keyboard.

4. To stop playback, hold down the **FUNCTION** button as you press the **CONCERT PLAY ►/■** keyboard key again.

Music Library

You can use the Music Library for your listening enjoyment or to practice piano songs.

- The Music Library includes 60 songs, numbered 1 through 60.
- You can also import up to 10 songs* from a computer to Digital Piano memory, and assign them Music Library song numbers 61 through 70.

* You can download music data from the Internet and then transfer it from your computer to Digital Piano memory. See "Transferring Song Data with a Computer" on page EN-34 for more information.

Playing Back a Specific Music Library Song

1. Find the song number of the song you want to play in the "Music Library List" on page A-1.
2. To change to another song, hold down the **FUNCTION** button as you use the **MUSIC LIBRARY SELECT (+, -, 0 to 9)** keys to specify a song number.
 - Each press of the + or - key raises or lowers the song number by 1.
 - You can use the value input keys (0 to 9) to enter a specific song number.

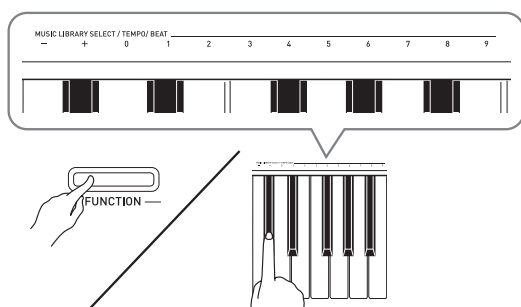

3. Press the **START/STOP ▶/■** button.
 - This starts the playback of the song.
4. To stop playback, press the **START/STOP ▶/■** button again.
 - Playback will stop automatically when the end of the song is reached.

NOTE

- Pressing the + and - keys at the same time will select song number 1.
- You also can adjust the playback tempo and volume of the song. See "Configuring Settings with the Keyboard" on page EN-26 for more information.

Practicing with a Music Library Song

You can turn off the left hand part or right hand part of a song and play along on the piano.

NOTE

- The Music Library includes a number of duets. While a duet is selected, you can turn off the first piano <Primo> or second piano <Secondo> tone and play along with the song.

PREPARATION

- Select the song you want to practice and adjust the tempo. See "Configuring Settings with the Keyboard" on page EN-26.
- A number of tunes have tempo changes part way through in order to produce specific musical effects.

1. While holding down the **FUNCTION** button, press the **RECORDER (L/R)** button to select the part you want to turn off.
 - Pressing a button toggles its part on (button lamp on) and off (button lamp off).

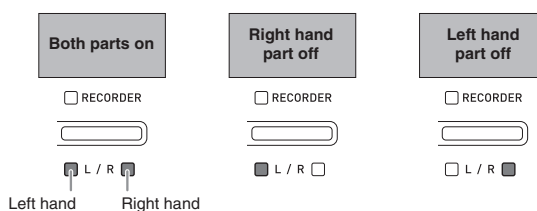

2. Press the **START/STOP ▶/■** button.
 - This starts playback, without the part you turned off in step 1.
3. Play the missing part on the keyboard.
4. To stop playback, press the **START/STOP ▶/■** button again.

Recording and Play Back

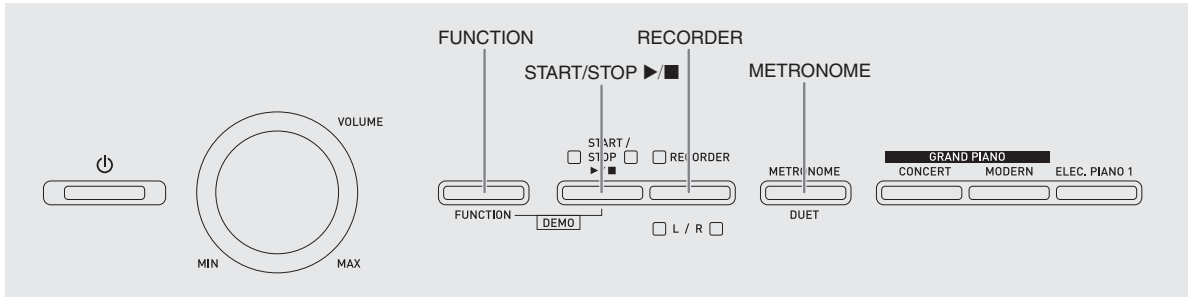

You can store the notes you play in Digital Piano memory for later playback.

Tracks

A track is a container of recorded data, and a song consists of two tracks: Track 1 and Track 2. You can record each track separately and then combine them so they play back together as a single song.

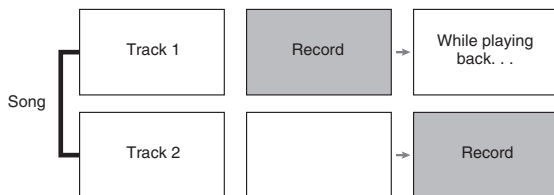

Memory Capacity

- You can record approximately 5,000 notes in Digital Piano memory.
- The **RECORDER** button lamp will flash at high speed when memory runs low.
- Recording stops automatically if the number of notes in memory exceeds the maximum.

Recorded Data

- Keyboard play
- Tone used
- Pedal operations
- Reverb and chorus settings (Track 1 only)
- Tempo setting (Track 1 only)
- Layer setting (Track 1 only)
- Split setting (Track 1 only)
- Temperament and base note settings (Track 1 only)
- Octave shift setting (Track 1 only)

Recording Data Storage

- Starting a new recording deletes any data that was previously recorded in memory.
- If power to the Digital Piano is cut off while recording is in progress, everything you recorded up to that point will be deleted. Take care so power is not turned off accidentally during recording operations.

IMPORTANT!

- CASIO COMPUTER CO., LTD. takes no responsibility for any damages, lost profits, or claims by third parties arising from the deletion of recorded data due to malfunction, repair, or for any other reason.

Using the RECORDER Button

Each press of the **RECORDER** button cycles through the recording options in the sequence shown below.

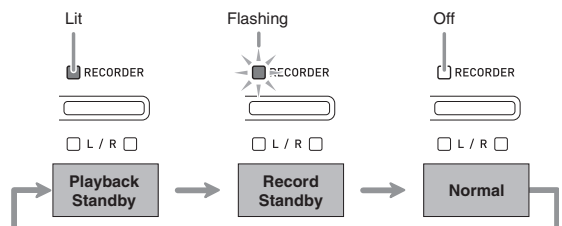

To record to a specific track of a song

After recording to either of the tracks of a song, you can record to the other track while listening to playback what you recorded in the first track.

1. Press the **RECORDER** button twice so its lamp is flashing.



- At this time the L lamp will flash to indicate that the Digital Piano is standing by for recording to Track 1.

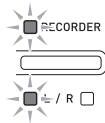

2. To change the recording track, hold down the **FUNCTION** button as you press the **RECORDER (L/R)** button.

- Make sure that the indicator lamp for the record track is flashing.
Track 1: L lamp
Track 2: R lamp

Example: Track 1 selected

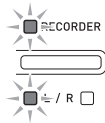

3. Select the tone and effects (Track 1 only) you want to use in your recording.

- Tone (page EN-10)
- Effects (page EN-13)

NOTE

- If you want the metronome to sound while you are recording, configure the beat and tempo settings, and then press the **METRONOME** button. See “Using the Metronome” on page EN-15 for more information.

4. Start playing something on the keyboard.
 - Recording will start automatically.
5. To stop recording, press the **START/STOP** ►/■ button.
 - This will cause the **RECORDER** button lamp and the lamp of the track you recorded to change from flashing to lit.
 - To play back the track you just recorded, press the **START/STOP** ►/■ button.
6. After you are finished recording or playing back, press the **RECORDER** button so its lamp goes out.

To record to one track of a song while listening to the playback of the other track

1. Press the **RECORDER** button so its lamp is lit.



2. While holding down the **FUNCTION** button, press the **RECORDER (L/R)** button to select the track you want to play back while recording.

3. Press the **RECORDER** button so its lamp is flashing.
 - This will cause the L lamp to flash.

4. While holding down the **FUNCTION** button, press the **RECORDER (L/R)** button to select the track you want to record.
 - Make sure that the indicator lamp for the record track is flashing.

Example: To listen to playback of Track 1 as you record to Track 2

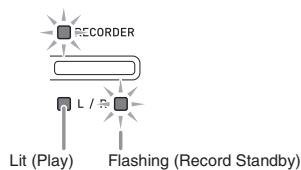

5. Select the tone and effects (Track 1 only) you want to use for your recording.
6. Press the **START/STOP** button or play something on the keyboard.
 - This will start both playback of the recorded track and recording to the other track.
7. To stop recording, press the **START/STOP** button.

Playing Back from Digital Piano Memory

1. Press the **RECORDER** button so its lamp is lit.

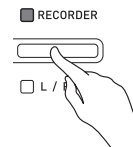

NOTE

- When a song has something recorded in both tracks, you can turn off one track and play back just the other track, if you want.

2. Press the **START/STOP** button.

- This starts playback of the song and/or track you selected.

NOTE

- You can change the tempo setting as a track is playing.
- Press the **START/STOP** button again to stop playback.

Deleting Recorded Data

The following procedure deletes a specific track of a song.

IMPORTANT!

- The procedure below deletes all of the data of the selected track. Note that the delete operation cannot be undone. Check to make sure you really do not need the data in Digital Piano memory before you perform the following steps.

1. Press the **RECORDER** button twice so its lamp is flashing.

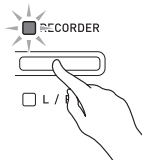

2. While holding down the **FUNCTION** button, press the **RECORDER (L/R)** button to select the track you want to delete.

3. Press the **RECORDER** button until its lamp is lit.

- This will cause the lamp of the track you selected in step 2 of this procedure to flash.

Example: If you selected Track 2 for deletion

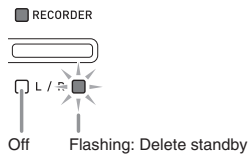

4. Once again, hold down the **FUNCTION** button as you press the **RECORDER (L/R)** button.

- This deletes the selected track and enters playback standby.
- To cancel the delete operation at any time, press the **RECORDER** button twice so its lamp is unlit.

NOTE

- Only the Digital Piano's **RECORDER (L/R)** button is operational from step 3 until you actually perform the delete operation in step 4. No other button operation can be performed.

Configuring Settings with the Keyboard

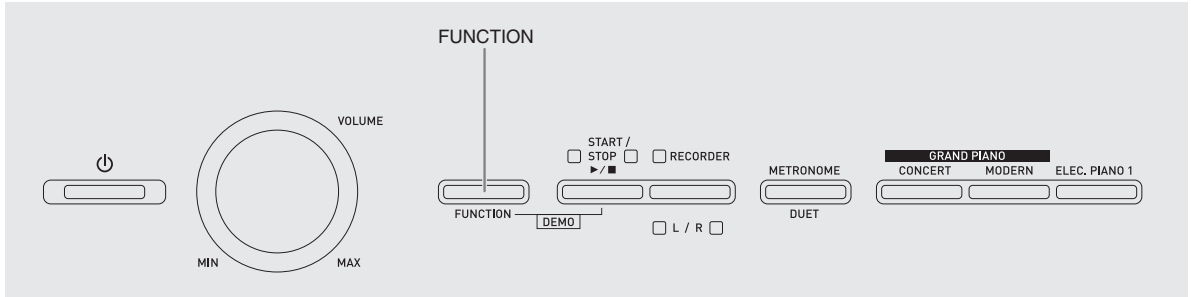

In addition to selecting tones and songs (Concert Play or Music Library), you also can use the **FUNCTION** button in combination with the keyboard keys to configure effect, keyboard touch, and other settings.

To configure settings with the keyboard

1. Use the “Parameter List” on pages EN-29 - EN-32 to find the setting you want to configure, and note its details.
2. Use “Keyboard Keys Used for Configuring Settings” on page EN-28 to find the location on the keyboard for configuring the setting you want.
3. While holding down the **FUNCTION** button, press the keyboard key for the setting you want to configure.
 - The Digital Piano will sound an operation tone after it configures the setting.

Example: To lower the transpose setting by one semitone

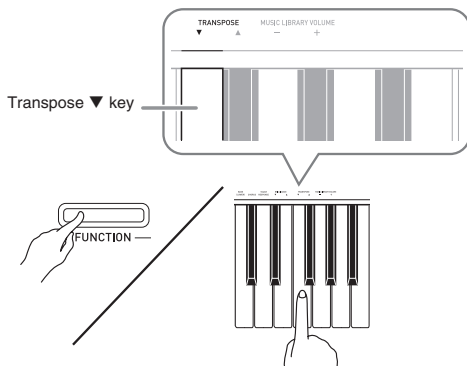

4. Release the **FUNCTION** button to complete the setting procedure.

NOTE

- You can configure the Digital Piano so no operation tone sounds in step 3. For details, see “@ Operation Tone” under “Parameter List” on pages EN-29 - EN-32.

Keyboard Setting Operation Types

There are four types of operations that you can perform while configuring settings with the keyboard keys: Type A, Type B, Type C, and Type D.

Type A: Direct input

Example: Pressing the STRINGS keyboard key to select the STRINGS 1 tone

Type B: Raising or lowering a setting using the + and – or ▼ and ▲ keyboard keys

- Holding down a key raises or lowers the setting at high speed.
- To return to the initial default setting, press both keys at the same time.

Type C: Value input using the numeric keys (0 to 9)

Example: To enter “120”, press keys 1, 2, 0.

Type D: Toggling or cycling through settings by pressing a keyboard key

- When you press a key, the Digital Piano will beep to let you know which setting is selected.
- A long beep indicates that the applicable setting is turned off.

Example: While chorus is turned off, pressing the CHORUS keyboard key twice will cause the Digital Piano to beep twice, which indicates that the Medium Chorus setting is selected.

NOTE

- You can find out what operation type applies to each setting by checking the “Operation Type” in the “Parameter List” on pages EN-29 - EN-32.

Keyboard Keys Used for Configuring Settings

- The numbers ① through ⑳ correspond to the same numbers in the "Parameter List" on pages EN-29 - EN-32.

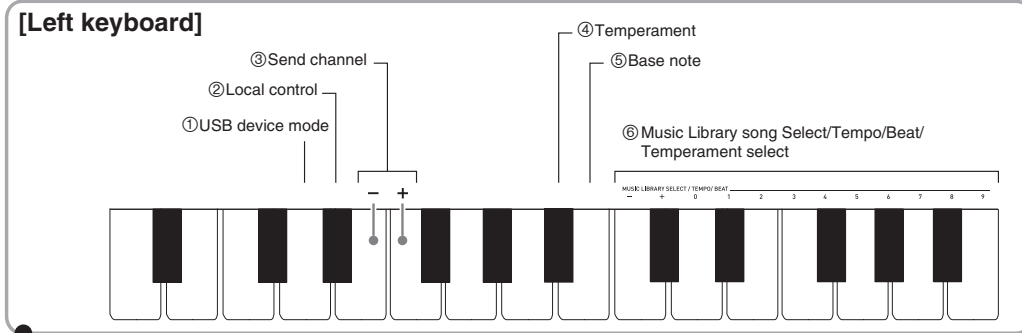

[Overall]

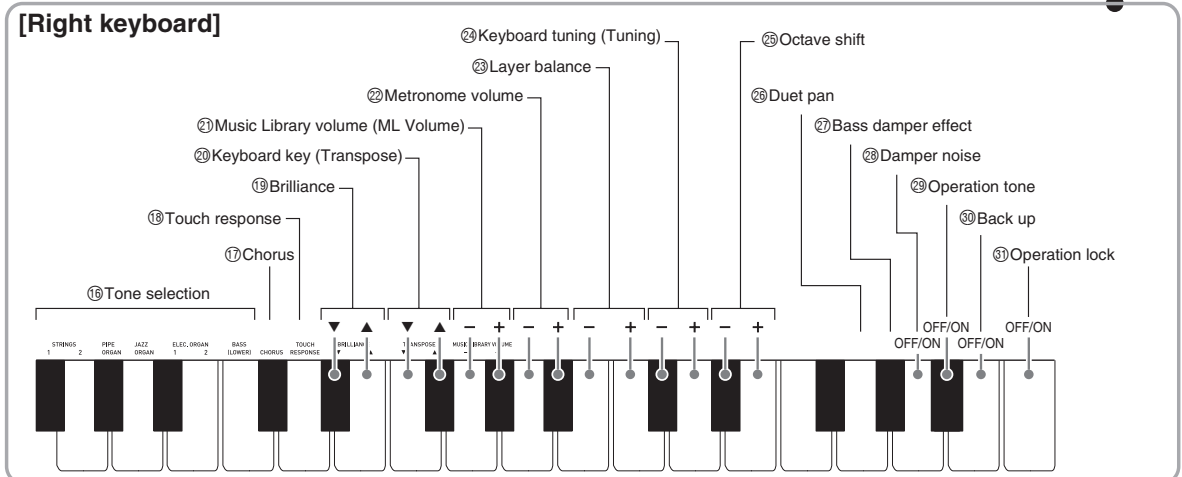
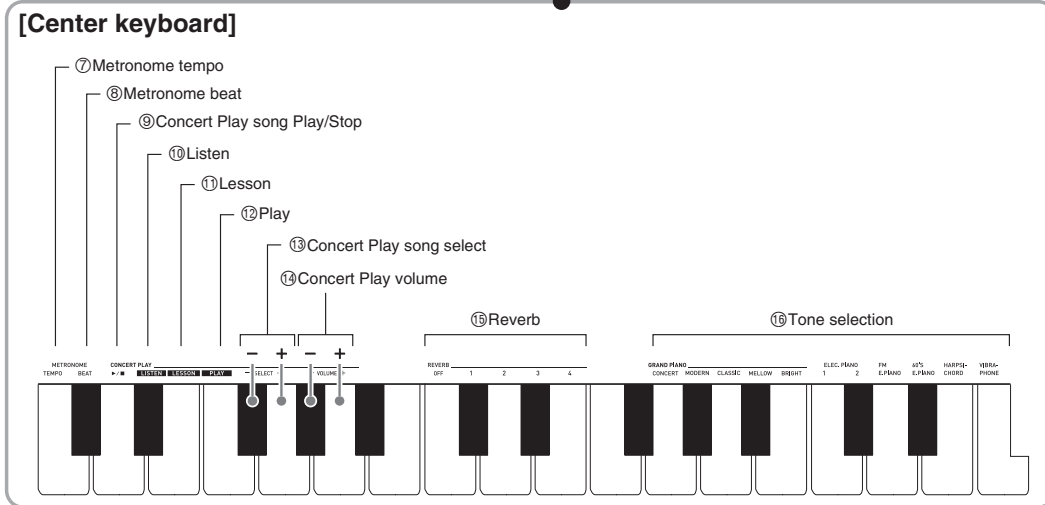

Parameter List

■ Tones

Parameter	Settings	Operation Type (page EN-27)	Description	Remarks
⑮ Reverb (REVERB)	Off (OFF), 1 to 4 Default: 2	A	Specifies the reverb of notes. (page EN-13)	
⑯ Tone selection	See page EN-10. Default: GRAND PIANO (CONCERT)	A	Assigns a tone to the keyboard. (page EN-10)	
⑰ Chorus (CHORUS)	Off (OFF), 1 to 4 Default: Off	D	Controls the breadth of notes. (page EN-13)	
⑱ Brilliance (BRILLIANCE)	-3 to 0 to 3 Default: 0	B	Specifies the brilliance of notes. Pressing [+] makes notes brighter and harder. Pressing [-] makes notes mellower and softer.	<ul style="list-style-type: none"> To return the setting to its initial default (0), press [+] and [-] at the same time.
㉓ Layer balance	-24 to 0 to 24 Default: -10	B	Specifies the volume balance between the main tone and the layered tone. (page EN-12)	<ul style="list-style-type: none"> To return the setting to its initial default (-10), press [+] and [-] at the same time.
㉔ Duet pan	Off (OFF), On (ON) Default: Off	D	When turned on, outputs the left side keyboard tone from the left speaker and the right side keyboard tone from the right speaker while duet is turned on. (page EN-16)	<ul style="list-style-type: none"> Supported only when a piano tone is being used. Reverb is not applied when this parameter is turned on.
㉕ Bass damper effect	Off (OFF), On (ON) Default: Off	D	When turned on and the BASS (LOWER) tone is selected, pressing the damper pedal or sostenuto pedal will apply sustained reverberation to the BASS (LOWER) tone. (page EN-11)	
㉖ Damper noise	Off (OFF), On (ON) Default: On	D	Enables/disables damper noise output. (page EN-14)	

■ Song/Metronome

Parameter	Settings	Operation Type (page EN-27)	Description	Remarks
⑥ Music Library song select (MUSIC LIBRARY SELECT)	1 to 70 Default: 1	B C	Selects a Music Library tune. (page EN-21)	<ul style="list-style-type: none"> This setting cannot be changed while recording. This setting cannot be changed while Concert Play playback is in progress.
⑥ Tempo (TEMPO)	20 to 255 Default: 120	B C	Specifies the tempo of Concert Play Lesson Mode songs, Music Library songs, the metronome, recording and playback, etc. (page EN-15)	<ul style="list-style-type: none"> During recording, pressing + and – at the same time sets a value of 120.
⑥ Beat (BEAT)	0 to 9 Default: 4	C	Specifies the metronome beat. (page EN-15)	
⑦ Metronome tempo (METRONOME TEMPO)	–	–	Enters a setting mode for specifying the metronome tempo with keyboard keys. Use the ⑥ TEMPO keyboard keys to input a tempo value. (page EN-15)	<ul style="list-style-type: none"> The metronome tempo setting cannot be configured while playback of a Concert Play song is in progress in the LISTEN mode or PLAY mode.
⑧ Metronome beat (METRONOME BEAT)	–	–	Enters a setting mode for specifying the metronome beat with keyboard keys. Use the ⑥ BEAT keyboard keys to input a beat value. (page EN-15)	<ul style="list-style-type: none"> The metronome beat setting cannot be changed while Concert Play or Music Library playback is in progress.
⑨ Concert Play song Play/Stop (CONCERT PLAY ►/■)	Play, Stop	D	Toggles a Concert Play song between play and stop. (page EN-19)	<ul style="list-style-type: none"> This setting cannot be changed while recording.
⑩ Listen (LISTEN)	–	A	Enters the Concert Play Listen Mode. (page EN-19)	<ul style="list-style-type: none"> This setting cannot be changed while recording. This setting cannot be changed while Music Library playback is in progress.
⑪ Lesson (LESSON)	–	A	Enters the Concert Play Lesson Mode. (page EN-20)	<ul style="list-style-type: none"> This setting cannot be changed while recording. This setting cannot be changed while Music Library playback is in progress.
⑫ Play (PLAY)	–	A	Enters the Concert Play Play Mode. (page EN-20)	<ul style="list-style-type: none"> This setting cannot be changed while recording. This setting cannot be changed while Music Library playback is in progress.
⑬ Concert Play song select (SELECT +/-)	1 to 10 Default: 1	B	Specifies a Concert Play song number. (page EN-19)	<ul style="list-style-type: none"> This setting cannot be changed while recording. This setting cannot be changed while Music Library playback is in progress.
⑭ Concert Play volume (VOLUME +/-)	0 to 42 Default: 42	B	Sets the volume level of Concert Play playback.	<ul style="list-style-type: none"> This setting cannot be changed while recording. This setting cannot be changed while Music Library playback is in progress.
⑰ Music Library volume (ML Volume)	0 to 42 Default: 42	B	Sets the volume level of Music Library playback.	<ul style="list-style-type: none"> This setting cannot be changed while recording. This setting cannot be changed while Concert Play playback is in progress.
⑱ Metronome volume	0 to 42 Default: 36	B	Specifies the metronome volume. (page EN-16)	

Keyboard

Parameter	Settings	Operation Type (page EN-27)	Description	Remarks
④ Temperament ⑤ Temperament Base note ⑥ Temperament select	Temperament: 0 to 16 Base note: -, +, 0 to 9 (C to B) Defaults: Temperament: 0 (Equal Temperament) Base note: C	<p><Selecting a Temperament> While holding down the FUNCTION button, press the applicable keyboard keys as described below.</p> <ol style="list-style-type: none"> 1. Press the ④ Temperament keyboard key. 2. Use the ⑥ Temperament Select keyboard keys to select the desired temperament. <ul style="list-style-type: none"> • If you want to advance directly base note selection from here, release the FUNCTION button and continue with the procedure below. <p><Selecting a Base Note> While holding down the FUNCTION button, press the applicable keyboard keys as described below.</p> <ol style="list-style-type: none"> 1. Press the ⑤ Base Note keyboard key. 2. Use the ⑥ numeric input (-, +, 0 to 9) keyboard keys to specify a base note. 	You can change the scale (tuning system) of the keyboard from standard equal temperament to another tuning that is more suitable for playing Indian music, Arabic music, classical pieces, etc. <ul style="list-style-type: none"> • When you select any temperament other than "Equal", you must also configure a base note (base note of the temperament of the song being performed) setting. • For details about temperament, refer to a book that covers music theory. 	<p><Temperaments> 0: Equal / 1: Pure Major / 2: Pure Minor / 3: Pythagorean / 4: Kirnberger 3 / 5: Werckmeister / 6: Mean-Tone / 7: Rast / 8: Bayati / 9: Hijaz / 10: Saba / 11: Dashti / 12: Chahargah / 13: Segah / 14: Gurjari Todi / 15: Chandrakauns / 16: Charukeshi</p> <p><Base notes> -: C / +: C[#] / 0: D / 1: E^b / 2: E / 3: F / 4: F[#] / 5: G / 6: A^b / 7: A / 8: B^b / 9: B</p> <ul style="list-style-type: none"> • This setting cannot be changed while Concert Play playback is in progress.
⑩ Touch response (TOUCH RESPONSE)	Off (OFF), 1 to 3 Default: 2	D	Specifies the relative touch of the keyboard keys. Setting a smaller value causes lighter touch to produce more powerful sound.	Each press of the keyboard key causes it to beep the number of times shown below to indicate the current setting. Once (long): Off Once (short): 1 Twice: 2 Three times: 3
⑳ Keyboard key (Transpose) (TRANSPOSE)	-12 to 0 to 12 Default: 0	B	Raises or lowers the tuning of the Digital Piano in semitone steps.	<ul style="list-style-type: none"> • The transpose setting cannot be configured while Concert Play or Music Library playback is in progress, or while in the Duet Mode. • Raising the key of the Digital Piano can cause notes the highest part of the range to become distorted.
㉑ Keyboard tuning (Tuning)	415.5Hz to 440.0Hz to 465.9Hz Default: 440.0Hz	B	Raises or lowers the overall pitch of the Digital Piano in 0.1Hz steps from the standard pitch of A4 = 440.0Hz.	<ul style="list-style-type: none"> • The pitch setting cannot be changed while Concert Play or Music Library playback is in progress.
㉒ Octave shift	-2 to 0 to 2 Default: 0	B	Change the range of the keyboard in octave units.	<ul style="list-style-type: none"> • You can configure octave shift settings for the main tone part and layered tone part. • You cannot configure octave shift settings for split tone parts.

■ MIDI and Other Settings

Parameter	Settings	Operation Type (page EN-27)	Description	Remarks
① USB device mode	MIDI, Storage Default: MIDI	D	The Digital Piano enters MIDI mode automatically when it is connected to a computer by a USB cable. Select storage when saving Recorder memory song data to a computer or when loading computer song data to Digital Piano memory. (page EN-34)	<ul style="list-style-type: none"> While Storage is selected for this setting, the GRAND PIANO (CONCERT, MODERN) and ELEC. PIANO 1 button lamps flash, and all other lamps are unlit. All Digital Piano operations are disabled at this time. Each press of the USB device mode keyboard key toggles between the MIDI and storage modes.
② Local control	Off, On Default: On	D	Selecting "Off" for Local control cuts off the Digital Piano's sound source, so no sound is produced by the Digital Piano when keys are pressed.	<ul style="list-style-type: none"> The Local control setting cannot be changed while Concert Play or Music Library playback is in progress.
③ Send channel	1 to 16 Default: 1	B	Specifies one of the MIDI channels (1 through 16) as the Send channel, which is used for sending MIDI messages to an external device.	
④ Operation tone	Off, On Default: On	D	Selecting "Off" disables sounding of the operation tone whenever a keyboard key is pressed while the FUNCTION is depressed.	<ul style="list-style-type: none"> This setting is retained even when the Digital Piano is turned off. The operation tone setting cannot be changed while Concert Play or Music Library playback is in progress, while the metronome is sounding, and during recording.
⑤ Back up	Off, On Default: Off	D	When "On" is selected for this setting, the Digital Piano will remember <u>its current settings</u> ^{*1} , and restore them when it is turned on again. When "Off" is selected, settings ^{*2} are reset to their initial defaults whenever the Digital Piano is turned on.	<ul style="list-style-type: none"> The back up setting cannot be changed while Concert Play or Music Library playback is in progress, while the metronome is sounding, in the Duet Mode, and during recording. <p>*1 The following settings are not remembered.</p> <ul style="list-style-type: none"> Duet Mode Tune LR (part) Local control <p>*2 Except for the operation tone on/off setting.</p>
⑥ Operation lock	Off, On Default: Off	D	Selecting "On" for this setting locks the Digital Piano's buttons (except for the ⏻ (Power) button and the buttons required for unlock), so no operation can be performed. Turn on operation lock when you want to protect against unintentional button operations.	<ul style="list-style-type: none"> The operation lock setting cannot be changed while Concert Play or Music Library playback is in progress, while the metronome is sounding, and during recording.

Connecting to a Computer

You can connect the Digital Piano to a computer and exchange MIDI data between them. You can send play data from the Digital Piano to commercially available music software running on your computer, or you can send MIDI data from your computer to the Digital Piano for playback.

Minimum Computer System Requirements

The following shows the minimum computer system requirements for sending and receiving MIDI data. Check to make sure that your computer complies with these requirements before connecting the Digital Piano to it.

● Operating System

- Windows® XP (SP2 or later) *1
- Windows Vista® *2
- Windows® 7 *3
- Windows® 8 *4
- Windows® 8.1*5
- Mac OS® X (10.3.9, 10.4.11, 10.5.X, 10.6.X, 10.7.X, 10.8.X, 10.9.X)

*1: Windows XP Home Edition
Windows XP Professional (32-bit)

*2: Windows Vista (32-bit)

*3: Windows 7 (32-bit, 64-bit)

*4: Windows 8 (32-bit, 64-bit)

*5: Windows 8.1 (32-bit, 64-bit)

● USB port

IMPORTANT!

- Never connect to a computer that does not conform to the above requirements. Doing so can cause problems with your computer.

Connecting the Digital Piano to Your Computer

IMPORTANT!

- Make sure you follow the steps of the procedure below exactly. Connecting incorrectly can make data send and receive impossible.

1. Turn off the Digital Piano and then start up your computer.

- Do not start up the music software on your computer yet!

2. After starting up your computer, use a commercially available USB cable to connect it to the Digital Piano.

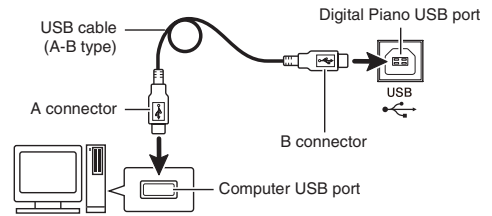

3. Turn on the Digital Piano.

- If this is the first time you are connecting the Digital Piano to your computer, the driver software required to send and receive data will be installed on your computer automatically.

4. Start up commercially available music software on your computer.

5. Configure the music software settings to select one of the following as the MIDI device.

CASIO USB-MIDI: For Windows Vista, Windows 7, Windows 8, Windows 8.1, Mac OS X

USB Audio Device: For Windows XP

- For information about how to select the MIDI device, see the user documentation that comes with the music software you are using.

IMPORTANT!

- Be sure to turn on the Digital Piano first before starting up your computer's music software.

NOTE

- Once you are able to connect successfully, there is no problem with leaving the USB cable connected when you turn off your computer and/or Digital Piano.
- For detailed specifications and connections that apply to MIDI data send and receive by this Digital Piano, see the latest support information provided by the website at the following URL.
<http://world.casio.com/>

Using MIDI

What is MIDI?

The letters MIDI stand for Musical Instrument Digital Interface, which is the name of a worldwide standard for digital signals and connectors that makes it possible to exchange musical data between musical instruments and computers (machines) produced by different manufacturers.

NOTE

- For detailed information about MIDI Implementation, visit the CASIO website at: <http://world.casio.com/>.

See “Send channel” and “Local control” on page EN-32.

Transferring Song Data with a Computer

Use the procedures in this section to transfer Recorder memory data to a computer for storage, and to load songs to user song memory (Music Library 61 to 70).

IMPORTANT!

- Turning off the Digital Piano while it is exchanging data with a computer can cause data in Digital Piano memory to become corrupted. If this happens, a memory format operation will start the next time you turn on the Digital Piano. Note that it takes about 20 seconds for the format operation to finish, and you will not be able to perform any operation during that time.

1. Perform steps 1 through 3 of the procedure under “Connecting the Digital Piano to Your Computer” on page EN-33.

2. Change the Digital Piano’s USB device mode to storage.

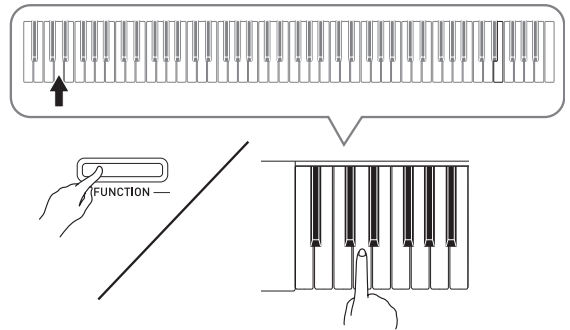

- While holding down the **FUNCTION** button, press the keyboard key that corresponds to the USB device mode.
- After this setting is changed, the **GRAND PIANO (CONCERT, MODERN)** and **ELEC. PIANO 1** button lamps flash, and all other lamps are unlit.
- See “USB device mode” on page EN-32 for more information.

3. On your computer, perform the required operation to display your computer’s storage devices.

If your computer is running this operating system:	Do this:
Windows XP	Double-click “My Computer”.
Windows Vista, Windows 7	Double-click “Computer”.
Windows 8	Open any folder. On the navigation window, click “Computer”.
Windows 8.1	Open any folder. On the navigation window, click “PC”.
Mac OS	Skip step 3 and double-click “PIANO” on your Mac desktop.

- The memory of this Digital Piano will appear as “PIANO” under “Devices with Removable Storage”.

4. Double-click “PIANO”.

- “PIANO” contains folders named “MUSICLIB” and “RECORDER”.
- To transfer a user song to the Digital Piano from your computer, open the “MUSICLIB” folder and put the song into one of the numbered subfolders (61 through 70). Each subfolder corresponds to a Music Library number: Subfolder 61 to Music Library 61, and so on.
- The files in the “RECORDER” folder are songs that have been recorded with the Digital Piano’s recorder function. You can move files from the “RECORDER” folder to another location on your computer, and you can return recorded song files to the Digital Piano by placing them into the “RECORDER” folder.

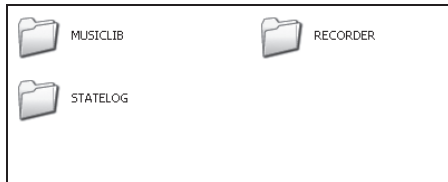

Data Type	Folder Name	File Name and Extension*
User songs	MUSICLIB	.MID: SMF format data (format 0/1) .CM2: CASIO original format data
Recorder memory data	RECORDER	BIDREC01.CSR: CASIO original format data

* Before starting a store or load operation, first check the file name extension to ensure it matches the ones shown in this column.

In the case of a song recorded with the Digital Piano’s recorder function, change its file name to one of the names and extensions shown in this column.

- The initial default configuration for Windows XP, Windows Vista, Windows 7, Windows 8, and Windows 8.1 is to hide file name extensions. Perform one of the following operations on your computer to show file name extensions.
 1. To show file name extensions under Windows XP
 1. Open the folder you want.
 2. On the [Tools] menu, click [Folder Options].
 3. Click the [View] tab. In the [Advanced settings] list, clear the check box next to [Hide extensions for known file types].
 4. Click [OK].

- To show file name extensions under Windows Vista or Windows 7
 1. Open Folder Options by clicking the [Start] button, clicking [Control Panel], clicking [Appearance and Personalization], and then clicking [Folder Options].
 2. Click the [View] tab. Under [Advanced settings] clear the [Hide extensions for known file types] check box.
 3. Click [OK].
- To show file name extensions under Windows 8 or Windows 8.1
 1. Open any folder.
 2. Click the [View] menu and then select the [File name extensions] check box in the [Show/hide] group.

■ To load a song into user song memory (Music Library 61 to 70)

1. Open the MUSICLIB folder.
2. Copy the song file (.MID or .CM2) to the number-named subfolder (61 to 70) whose name matches the number of the Music Library location to which you want to load the song.
 - If there are two files with the filename extensions .MID and .CM2 in the MUSICLIB folder, only the .MID data will be loaded into user song memory.

■ To transfer Recorder memory data between the Digital Piano and your computer

To transfer the Digital Piano’s current Recorder memory data to your computer, copy the contents of the RECORDER folder to your computer.

To return Recorder data you previously saved to your computer back to Recorder memory, copy it back to the RECORDER folder (and replace the current RECORDER folder contents).

5. After the file copy operation is complete, return the USB device mode to MIDI.
- If you are using a Macintosh, perform the eject operation (drag them to the trash can).
 - While holding down the **FUNCTION** button, press the applicable keyboard key. See “USB device mode” on page EN-32 for more information.
 - Returning the USB device mode to MIDI will load the contents of MUSICLIB into user song memory and the contents of RECORDER into Recorder memory.

**IMPORTANT!**

- A data conversion error is indicated when both of the **START/STOP ▶/■** button lamps, and the **GRAND PIANO (CONCERT, MODERN)** and **ELEC. PIANO 1** button lamps are all lit, and all other lamps are unlit.

Copyrights

The rights of creators and copyright holders of music, images, computer programs, databases, and other data are protected by copyright laws. You are allowed to reproduce such works for personal or non-commercial use only. For any other purpose, all reproduction (including data format conversion), modification, transfer of reproductions, distribution over a network, or any other use without permission of the copyright holder exposes you to claims for damages and criminal prosecution for copyright infringement and violation of the author's personal rights. Be sure to reproduce and otherwise use copyrighted works only in accordance with applicable copyright laws.

Assembling the Stand

Unpacking

PREPARATION

- Before starting assembly, check to make sure that you have all the parts shown below.
- This stand does not include any of the tools required for assembly. It is up to you to prepare a large Philips head (+) screwdriver for assembly.

IMPORTANT!

- Do not use any screws other than those that come with the stand. Doing so risks damage to the stand and/or Digital Piano.
- You can find the screws in a plastic bag inside of the packing material.
- If anything is missing or damaged, contact your local CASIO service provider.

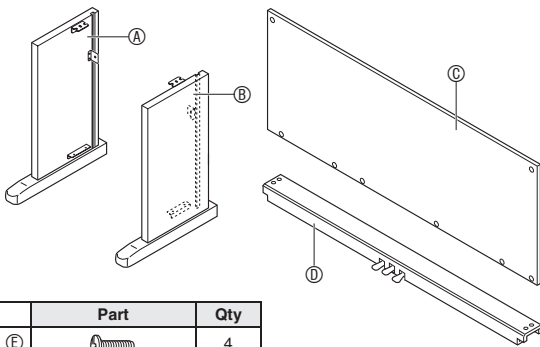

	Part	Qty
(E)		4
(F)		6
(G)		1
(H)		2
(I)		2
(J)		4
(K)		1

To assemble the stand

⚠ CAUTION

- Assembly of the stand should be performed by at least two people working together.
- This stand should be assembled on a flat surface.
- Do not remove the tape securing the keyboard cover in place until assembly is complete. Removing the tape can cause the keyboard cover to open and close during assembly, creating the risk of personal injury to your hands and fingers.
- Take care that you do not pinch your fingers between parts when assembling them.
- Be sure to insert felt or other material between the rubber feet and flooring. Do not allow direct contact between them. Some types of flooring material may become discolored or damaged by direct contact with the rubber feet.

📌 NOTE

- Be sure to follow the proper procedure when assembling the stand.

PREPARATION

- Pull the pedal unit cable out from the crosspiece ①.

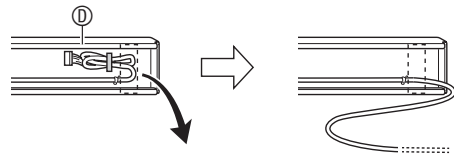

1. Attach side panels (A) and (B) to crosspiece (D).
Secure the side panels using four (E) screws.

- When installing parts (2), slide the brackets (3) into the slots in either end of crosspiece (D). If the brackets (3) are not inserted into the ends of the crosspiece (D) as far as they will go, the screws (E) will not be able to enter into the screw holes of the brackets (3), which can strip the threads of the screws.
- Cover the screw heads with the caps (J).

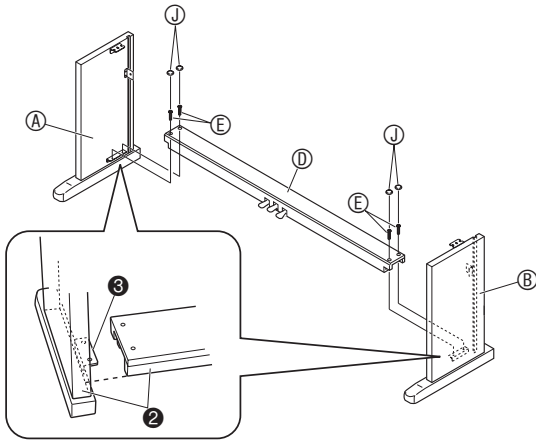

2. Slide back panel (C) into the grooves (4) of the side panels.

IMPORTANT!

- Make sure that the back panel (C) is positioned correctly as described below when installing it.
 - Before sliding back panel (C) into place, make sure that the widely spaced screw holes along the bottom of the panel are on the left (when viewed from the front of the stand), and the narrowly spaced holes are on the right.

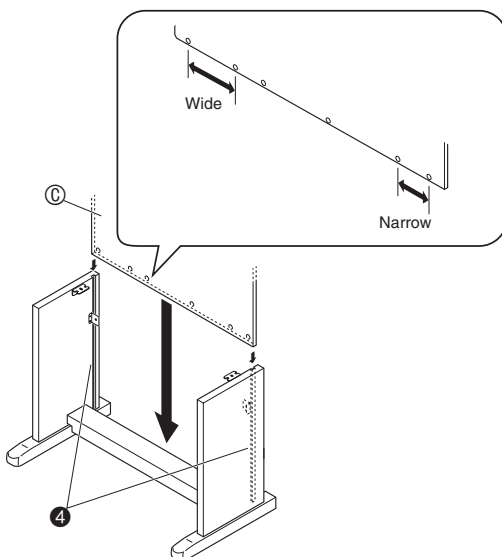

3. Use the two screws (I) to secure the top left and right edges of the back panel (C) to the brackets (5) of side panels (A) and (B).

- At location (6), slip the clip (G) onto the screw (I) before installing the screw.

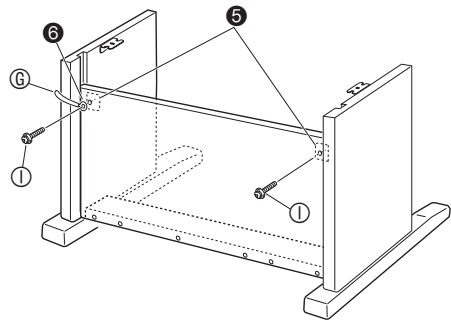

4. Next, secure the bottom of the back panel (C) with the six screws (F).

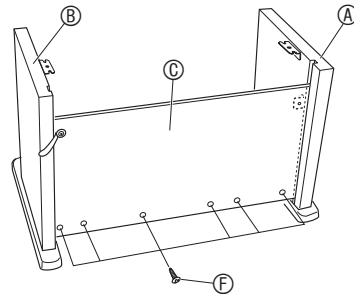

5. Adjust the height adjustment screw (7) to provide support so crosspiece (D) does not bow downwards when the pedals are pressed.

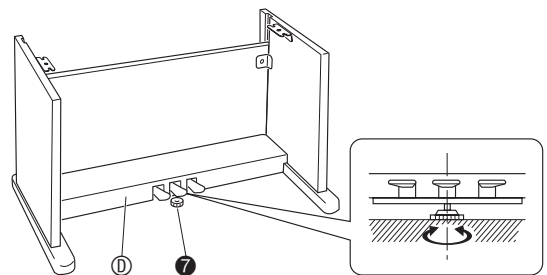

IMPORTANT!

- Pressing the pedals without adjusting height adjustment screw (7) can result in damage to crosspiece (D). Always make sure you adjust height adjustment screw (7) before operating the pedals.

6. Place the piano onto the stand.

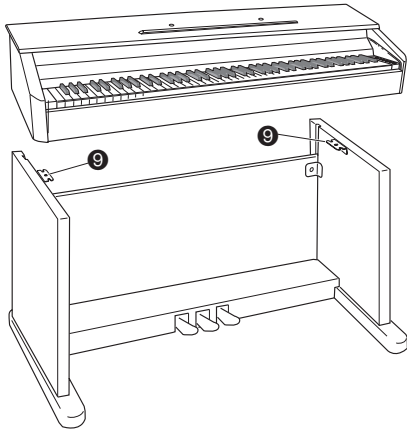

- At this time the screws on the bottom of the piano 8 should hook into the cutouts in the stand brackets 9.

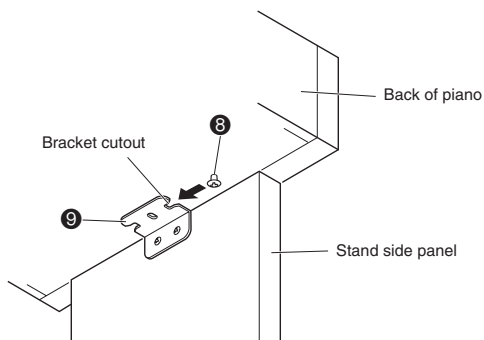

7. Use the two screws ⑧ to secure the piano to the stand.

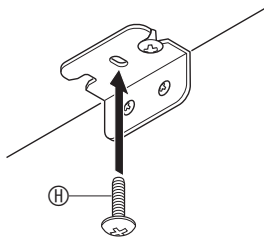

IMPORTANT!

- The screws keep the piano from slipping off the stand. Never use the piano without the screws installed.

8. Affix the adaptor cord clip ⑩ next to the power terminal (DC12V).

- For information about securing the cord, see "Getting Ready" on page EN-7.

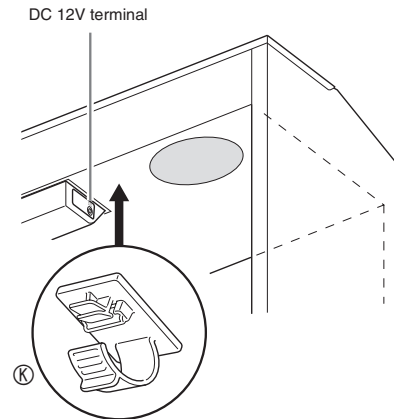

To connect the pedal cord

1. Orienting the pedal plug as shown in the illustration, plug it into the pedal connector on the bottom of the piano.
 - a. Press the plug fully into the connector as far as it will go.
 - b. Secure the pedal cord with the clip ⑥.

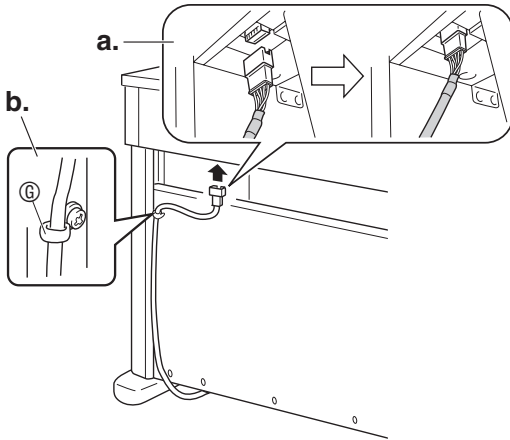

To install the music stand

1. Install the music stand by inserting its pegs into the holes in the top of the piano.

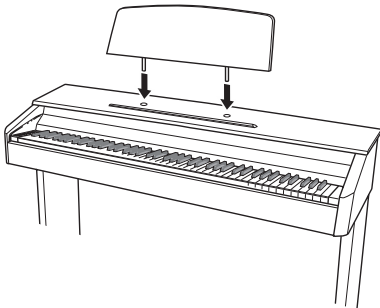

Removing the Protective Tape from the Keyboard

Protective tape is affixed to the front edges of the keyboard keys to protect them during shipment. Remove the protective tape before using the Digital Piano.

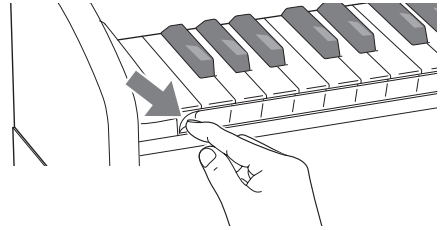

Troubleshooting

Problem	Cause	Action	See Page
No sound is produced when I press a keyboard key.	<ol style="list-style-type: none"> 1. The VOLUME controller is set to "MIN". 2. Headphones or an adaptor plug is plugged into one of the PHONES jacks. 3. MIDI Local control is turned off. 	<ol style="list-style-type: none"> 1. Rotate the VOLUME controller more towards "MAX". 2. Disconnect whatever is connected to the PHONES jacks. 3. Turn on the Local control setting. 	<p>☞ EN-10</p> <p>☞ EN-8</p> <p>☞ EN-32</p>
The pitch of the Digital Piano is off.	<ol style="list-style-type: none"> 1. The Digital Piano's key setting is something other than "0". 2. Digital Piano tuning is incorrect. 3. Octave shift is enabled. 4. A non-standard temperament setting is being used. 	<ol style="list-style-type: none"> 1. Change the key setting to "0", or turn Digital Piano power off and then back on again. 2. Adjust Digital Piano tuning, or turn the Digital Piano off and then back on again. 3. Change the octave shift setting to 0. 4. Change the temperament setting to "0:Equal", which is the standard modern tuning. 	<p>☞ EN-31</p> <p>☞ EN-31</p> <p>☞ EN-31</p> <p>☞ EN-31</p>
Nothing happens when I press a pedal.	<ol style="list-style-type: none"> 1. The pedal unit cable is not connected. 2. The pedal unit cable plug is not plugged in completely. 	<ol style="list-style-type: none"> 1. Connect the cable correctly. 2. Make sure that the pedal unit cable plug is inserted as far as it will go into the pedal connector on the bottom of the Digital Piano. 	☞ EN-40
<p>Tones and/or effects sound strange. Turning power off and then back on again does not eliminate the problem.</p> <p><i>Example: Note intensity does not change even though I alter key pressure.</i></p>	The "Back up" feature is turned on.	Turn off "Back up". Next, turn power off and then back on again.	☞ EN-32
I cannot transfer data after connecting the Digital Piano to a computer.	—	<ol style="list-style-type: none"> 1. Check to make sure that the USB cable is connected to the Digital Piano and computer, and that the correct device is selected with your computer's music software. 2. Turn off the Digital Piano and then exit the music software on your computer. Next, turn the Digital Piano back on and then restart the music software on your computer. 	☞ EN-33
It takes a long time before I can use the Digital Piano after I turn it on.	Digital Piano memory data was corrupted because a data transfer operation with a computer was in progress the last time you turned off the piano. When this happens, the Digital Piano performs a memory format operation the next time you turn it on. You cannot perform any other operation while a format operation is in progress.	It takes about 20 seconds after you turn on power to perform the memory format operation. Wait until the format operation is complete. Note that you should take care to avoid turning off the Digital Piano while a data transfer operation with a computer is in progress.	☞ EN-34
A tone's quality and volume sounds slightly different depending where it is played on the keyboard.	This is an unavoidable result of the digital sampling process,* and does not indicate malfunction. * Multiple digital samples are taken for the low range, middle range, and high range of the original musical instrument. Because of this, there may be very slight differences in tonal quality and volume between sample ranges.		
When I press a button, the note that is sounding cuts out momentarily or there is a slight change in how effects are applied.	This happens when the sounds of multiple parts are sounding at the same time while using layer, using the Duet Mode, playing back a built-in tune, recording, etc. Pressing a button when one of these conditions exists will cause the effect setting that is built into the tone to change automatically, which causes notes to cut out momentarily or causes a slight change in how effects are being applied.		

Product Specifications

Model	AP-260BK/AP-260BN
Keyboard	88-key piano keyboard, with Touch Response
Maximum Polyphony	128 notes
Tones	18 <ul style="list-style-type: none"> • Layer (excluding a bass tone) • Split (A low-range bass tone only)
Effects	Brilliance (–3 to 0 to 3), Reverb (4 types), Chorus (4 types), DSP, Damper Resonance (Damper noise enable/disable)
Metronome	<ul style="list-style-type: none"> • Beats: 0 to 9 • Tempo Range: 20 to 255
Duet	Adjustable tone range (–1 to 2 octaves)
Concert Play	<ul style="list-style-type: none"> • Number of Songs: 10 • Song volume: Adjustable • Part On/Off: L, R (in the Lesson Mode only) • 3 Modes: LISTEN, LESSON, PLAY
Music Library	<ul style="list-style-type: none"> • Number of Songs: 60, User Songs: 10 songs (Up to approximately 90KB per song, approximately 900KB for 10 songs)* * Based on 1 KB = 1024 bytes, 1 MB = 1024² bytes • Song volume: Adjustable • Part On/Off: L, R
Recorder	<ul style="list-style-type: none"> • Functions: Real-time recording, playback • Number of Song: 1 • Number of Tracks: 2 • Capacity: Approximately 5,000 notes total • Recorded Data Protection: Built-in flash memory
Pedals	Damper (with half-pedal operation), soft, sostenuto
Other Functions	<ul style="list-style-type: none"> • Touch Select: 3 types, Off • Transpose: 2 octaves (–12 to 0 to 12) • Tuning: A4 = 415.5Hz to 440.0Hz to 465.9Hz (variable) • Temperament • Octave shift • Operation lock
MIDI	16-channel multi-timbre receive
Inputs/Outputs	<ul style="list-style-type: none"> • PHONES jacks: Stereo standard jacks × 2 Output impedance: 3Ω Output Voltage: 1.5V (RMS) MAX • Power: 12V DC • USB port: TYPE B • Pedal connector
Speakers	Ø12cm × 2 (Output 8W + 8W)
Power Requirements	AC Adaptor: AD-A12150LW <ul style="list-style-type: none"> • Auto Power Off: Approximately 4 hours after last operation. Auto Power Off can be disabled. • The AC adaptor can be used safely in areas up to 4,000 meters above sea level.
Power Consumption	12V $\overline{\text{---}}$ 18W
Dimensions	Digital Piano and Stand: 137.7 (W) × 43.2 (D) × 84.0 (H) cm (54 1/4 × 17 × 33 1/8 inch)
Weight	Digital Piano and Stand: approximately 39.5kg (87.1 lbs)

- Specifications and designs are subject to change without notice.

Operating Precautions

Be sure to read and observe the following operating precautions.

■ Location

Avoid the following locations for this product.

- Areas exposed to direct sunlight and high humidity
 - Areas subjected to temperature extremes
 - Near a radio, TV, video deck, or tuner
- The above devices will not cause malfunction of the product, but the product can cause interference in the audio or video of a nearby device.

■ User Maintenance

- Never use benzene, alcohol, thinner, or other chemical agents to clean the product.
- To clean the product or its keyboard, wipe with a soft cloth moistened in a weak solution of water and a mild neutral detergent. Wring all excess moisture from the cloth before wiping.

■ Included and Optional Accessories

Use only accessories that are specified for use with this product. Use of unauthorized accessories creates the risk of fire, electric shock, and personal injury.

■ Weld Lines

Lines may be visible on the exterior of the product. These are “weld lines” that result from the plastic molding process. They are not cracks or scratches.

■ Musical Instrument Etiquette

Always be aware of others around you whenever using this product. Be especially careful when playing late at night to keep the volume at levels that do not disturb others. Other steps you can take when playing late at night are closing the window and using headphones.

- Any reproduction of the contents of this manual, either in part or its entirety, is prohibited. Except for your own, personal use, any other use of the contents of this manual without the consent of CASIO is prohibited under copyright laws.
- IN NO EVENT SHALL CASIO BE LIABLE FOR ANY DAMAGES WHATSOEVER (INCLUDING, WITHOUT LIMITATION, DAMAGES FOR LOSS OF PROFITS, BUSINESS INTERRUPTION, LOSS OF INFORMATION) ARISING OUT OF THE USE OF OR INABILITY TO USE THIS MANUAL OR PRODUCT, EVEN IF CASIO HAS BEEN ADVISED OF THE POSSIBILITY OF SUCH DAMAGES.
- The contents of this manual are subject to change without notice.

■ AC Adaptor Handling Precautions

- Use a power outlet that is easily accessible so you can unplug the AC adaptor when a malfunction occurs or whenever else you need to do so.
- The AC adaptor is intended for indoor use only. Do not use it where it might be exposed to splashing or moisture. Do not place any container, such as a flower vase, that contains liquid on the AC adaptor.
- Store the AC adaptor in a dry place.
- Use the AC adaptor in an open, well-ventilated area.
- Never cover the AC adaptor with newspaper, a table cloth, a curtain, or any other similar item.
- Unplug the AC adaptor from the power outlet if you do not plan to use the Digital Piano for a long time.
- Never try to repair the AC adaptor or modify it in any way.
- AC adaptor operating environment
 Temperature: 0 to 40°C
 Humidity: 10% to 90% RH
- Output polarity: 

AC Adaptor Handling Precautions

Model: AD-A12150LW

1. Read these instructions.
2. Keep these instructions on hand.
3. Heed all warnings.
4. Follow all instructions.
5. Do not use this product near water.
6. Clean only with a dry cloth.
7. Do not install near radiators, heat registers, stoves, or any other source of heat (including amplifiers).
8. Use only attachments and accessories specified by the manufacturer.
9. Refer all servicing to qualified service personnel. Servicing is required after any of the following occurs: when the product is damaged, when the power supply cord or plug is damaged, when liquid is spilled into the product, when a foreign object falls into the product, when the product is exposed to rain or moisture, when the product does not operate normally, when the product is dropped.
10. Do not allow the product to be exposed to dripping or splashing liquid. Do not place any object containing liquid on the product.
11. Do not allow the electrical load output to exceed the label rating.
12. Make sure the surrounding area is dry before plugging into a power source.
13. Make sure the product is oriented correctly.
14. Unplug the product during lightning storms or when you do not plan to use it for a long time.
15. Do not allow product ventilation openings to become blocked. Install the product in accordance with the manufacturer's instructions.
16. Take care the power cord is located where it will not be stepped upon or bent severely, particularly in locations close to plugs and convenience receptacles, and in locations where it exits from the product.
17. The AC adaptor should be plugged into a power outlet as close to the product as possible to allow immediate disconnection of the plug in case of emergency.

The symbol below is an alert indicating un-insulated hazardous voltage inside the product's enclosure, which may be sufficient to constitute the risk of electric shock to users.



The symbol below is an alert indicating the presence of important operating and maintenance (servicing) instructions in the documentation that accompanies the product.



Appendix/Apéndice

Tone List/Lista de tonos

Tone Name/ Nombre de tonos	Program Change/ Cambio de programa	Bank Select MSB/ MSB de selección de banco
GRAND PIANO CONCERT	0	0
GRAND PIANO MODERN	0	1
GRAND PIANO CLASSIC	0	2
GRAND PIANO MELLOW	0	3
GRAND PIANO BRIGHT	0	4
ELEC.PIANO 1	4	0
ELEC.PIANO 2	4	1
FM E.PIANO	5	0
60'S E.PIANO	4	2
HARPSICHORD	6	0
VIBRAPHONE	11	0
STRINGS 1	49	0
STRINGS 2	48	0
PIPE ORGAN	19	0
JAZZ ORGAN	17	0
ELEC.ORGAN 1	16	0
ELEC.ORGAN 2	16	1
BASS (LOWER)	32	0

Concert Play List/ Lista de Interpretación de concierto

Song No./ Núm. de canción	Song Name/Nombre de la canción
1	Je Te Veux
2	Vltava (Má vlast)
3	Canon
4	Tableaux d'Une Exposition "Promenade"
5	Piano Concerto No.20 K.466 2nd Mov.
6	Polovetian Dance (Prince Igor)
7	Sonate K.331 1st Mov.
8	Violin Concerto 1st Mov.
9	Jesus, Bleibet Meine Freude
10	Melody In F

Music Library List/ Lista de la biblioteca musical

Song No./ Núm. de canción	Song Name/Nombre de canciones
1	Nocturne Op.9-2
2	Fantaisie-Impromptu Op.66
3	Étude Op.10-3 "Chanson de l'adieu"
4	Étude Op.10-5 "Black Keys"
5	Étude Op.10-12 "Revolutionary"
6	Étude Op.25-9 "Butterflies"
7	Prélude Op.28-7
8	Valse Op.64-1 "Petit Chien"
9	Valse Op.64-2
10	Moments Musicaux 3
11	Impromptu Op.90-2
12	Marche Militaire 1 (Duet)
13	Frühlingslied [Lieder Ohne Worte Heft 5]
14	Fröhlicher Landmann [Album für die Jugend]

Song No./ Núm. de canción	Song Name/Nombre de canciones
15	Von fremden Ländern und Menschen [Kinderszenen]
16	Träumerei [Kinderszenen]
17	Tambourin
18	Menuet BWV Anh.114 [Clavierbüchlein der Anna Magdalena Bach]
19	Inventio 1 BWV 772
20	Inventio 8 BWV 779
21	Inventio 13 BWV 784
22	Praeludium 1 BWV 846 [Das Wohltemperierte Klavier I]
23	Le Coucou
24	Gavotte
25	Sonatina Op.36-1 1st Mov.
26	Sonatine Op.20-1 1st Mov.
27	Sonate K.545 1st Mov.
28	Sonate K.331 3rd Mov. "Turkish March"
29	Rondo K.485
30	Für Elise
31	Marcia alla Turca
32	Sonate Op.13 "Pathétique" 1st Mov.
33	Sonate Op.13 "Pathétique" 2nd Mov.
34	Sonate Op.13 "Pathétique" 3rd Mov.
35	Sonate Op.27-2 "Moonlight" 1st Mov.
36	Rhapsodie 2
37	Waltz Op.39-15 (Duet)
38	Liebesträume 3
39	Blumenlied
40	La Prière d'une Vierge
41	Csikos Post
42	Humoresque Op.101-7
43	Melodie [Lyrische Stücke Heft 2]
44	Sicilienne Op.78
45	Berceuse [Dolly] (Duet)
46	Arabesque 1
47	La Fille aux Cheveux de Lin [Préludes]
48	Passepied [Suite bergamasque]
49	Gymnopédie 1
50	Je Te Veux
51	Salut d'Amour
52	The Entertainer
53	Maple Leaf Rag
54	L'arabesque [25 Étüden Op.100]
55	La Styrienne [25 Étüden Op.100]
56	Ave Maria [25 Étüden Op.100]
57	Le retour [25 Étüden Op.100]
58	La chevaleresque [25 Étüden Op.100]
59	No.13 [Études de Mécanisme Op.849]
60	No.26 [Études de Mécanisme Op.849]

MIDI Implementation Chart

Function	Transmitted	Recognized	Remarks
Basic Channel Default Changed	1 - 16 1 - 16	1 - 16 1 - 16	
Mode Default Messages Altered	Mode 3 X * * * * * * * * * *	Mode 3 X * * * * * * * * * *	
Note Number True voice	0 - 127 * * * * * * * * * *	0 - 127 0 - 127*1	*1 : Depends on tone *1 : Depende del tono
Velocity Note ON Note OFF	0 9nH v = 1 - 127 X 8nH v = 64	0 9nH v = 1 - 127 X 9nH v = 0, 8nH v = **	** : no relation ** : sin relación
After Touch Key's Ch's	X X	X O	
Pitch Bender	X	O	
Control Change 0,32 1 5 6, 39 7 10 11 16 17 18 19 64 65	O X X X O X X X X X X X X X O X	O O O O O O O O O O O O O O O	Bank select Modulation Portamento Time Data entry LSB, MSB *2 Volume Pan Expression DSP-Parameter0 *2 DSP-Parameter1 *2 DSP-Parameter2 *2 DSP-Parameter3 *2 Tempo Portamento Switch

66 67 76 77 78 80 81 82 83 84 88 91 93 100, 101	Sostenido Soft Pitch rate Vibrato rate Vibrato depth Vibrato delay DSP Parameters ^{4,2} Parameters ^{5,*2} DSP Parameters ⁶ DSP Parameters ^{7,2} Portamento Control High resolution velocity prefix ³ Reverb send Chorus send RPN LSB, MSB ²	○○○○○○○○○○○○○○○○○ ○ 0 - 127 ○ X X X X X ○ ○ ○ ○ X ○ X ○ X X X	○○○○○○○○○○○○○○○○○ ○ ○ ○ X X X ○ ○ X ○ X ○ X X X	*2: For details, see MIDI Implementation at http://world.casio.com/ . *2: Si desea más información, vea Implementación MIDI en http://world.casio.com/ . *3: Note on only *3: Sólo notas activas
Program Change	: True #			
System Exclusive				
System Common	: Song Pos : Song Sel : Tune			
System Real Time	: Clock : Commands			
Aux Messages	: All sound off : Reset all controller : Local ON/OFF : All notes OFF : Active Sense : Reset			
Remarks				

Mode 1 : OMNI ON, POLY
Mode 3 : OMNI OFF, POLY

Mode 2 : OMNI ON, MONO
Mode 4 : OMNI OFF, MONO

O : Yes
X : No



This recycle mark indicates that the packaging conforms to the environmental protection legislation in Germany.

Esta marca de reciclaje indica que el empaquetado se ajusta a la legislación de protección ambiental en Alemania.

CASIO®



Free Manuals Download Website

<http://myh66.com>

<http://usermanuals.us>

<http://www.somanuals.com>

<http://www.4manuals.cc>

<http://www.manual-lib.com>

<http://www.404manual.com>

<http://www.luxmanual.com>

<http://aubethermostatmanual.com>

Golf course search by state

<http://golfingnear.com>

Email search by domain

<http://emailbydomain.com>

Auto manuals search

<http://auto.somanuals.com>

TV manuals search

<http://tv.somanuals.com>