

THE ASSEMBLY INSTRUCTION OF ARROW GAZEBO



"WARNING: KEEP ALL FLAME AND HEAT SOURCES AWAY FROM THIS GAZEBO FABRIC. This Gazebo is made with fabric that meets CPAI – 84 specifications for flame resistance. It is not fire proof. The fabric will burn if left in continuous contact with any flame source. The application of any foreign substance to the gazebo fabric may render the flame-resistant properties ineffective."

Yotrio Corporation
4550 San Pablo Ave, Suite B, Emeryville, CA 94608.
Country of Original: China
Code #: Yotrio 2009



DO NOT RETURN TO RETAILER

IF YOU HAVE ANY QUESTIONS OR CONCERNS
PLEASE VISIT OUR WEBSITE AT :

www.yotrioint.com











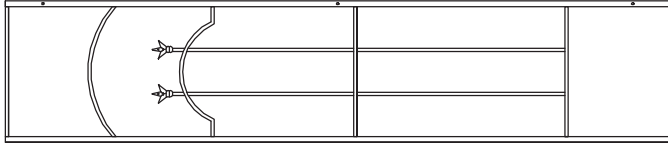
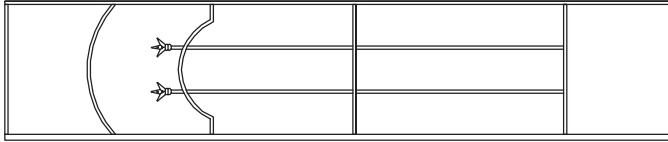



OR TOLL FREE AT:

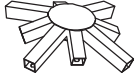







1-866-905-4107

MONDAY-FRIDAY 9:00 AM TO 5:30 PM PST

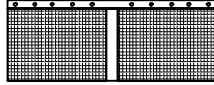
YOTRIO CUSTOMER CARE

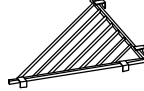
618221-C Arrow Gazebo

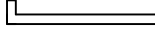
PART	QTY	DESCRIPTION	NAME
A	4PCS		Panel A
B	4PCS		Panel B
C	4PCS		Beam
D	4PCS		Canopy Spoke
E	4PCS		Canopy Frame
F	8PCS		Track Tube
G	4PCS		Short Canopy Spoke
H	1PC		Lower Canopy Hub
I	4PCS		Corner Connector
J	1PC		Upper Canopy Spoke
K	8PCS		M6X20 Bolt & Nut
L	12PCS		M6X35 Bolt & Nut
M	4PCS		M6X15 Bolt
N	4PCS		M6X10 Bolt & Nut
O	16PCS		M6X28 Bolt & Nut

P	1PC		Small Fabric Cover
Q	1PC		Large Fabric Cover
R	4PCS		Netting
S	48PCS		Plastic Ring
T	4PCS		Corner Shelf
U	1PC		Top Arrow
V	4PCS		Corner Arrow
W	8PCS		Ground pike
X	1PC		Lantern

Step 1: Fix the Panel (A) onto the Panel (B) by using M6X35 Bolts & Nuts (L). Repeat 3 times. See Figure 1.

Step 2: Fix the 4 Corner Connectors (I) onto the top 4 corners of the Assembled Panels (A + B) by using M6X20 Bolts & Nuts (K). See Figure 2.

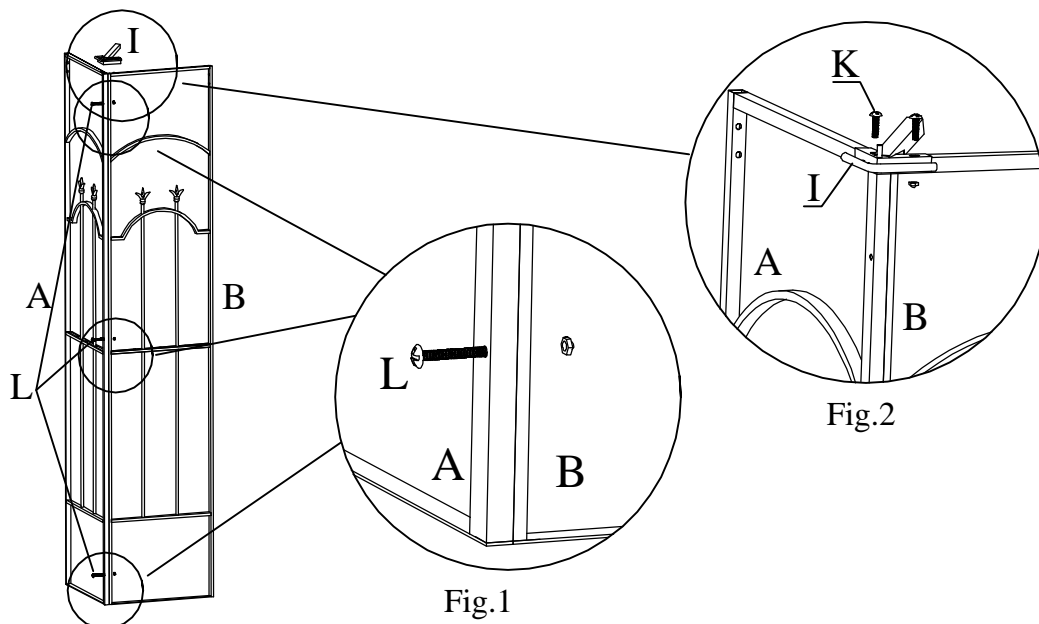

Step 3: Line up the bolt holes on the two ends of the Beam (C) with the corresponding bolt holes on the side tubes of Panel (A) and Panel (B). Screw assembled panels by using M6X28 Bolts & Nuts (O). Repeat for the remaining Beams (C), Panels (A) and Panels (B) 3 times. See Figure 3.

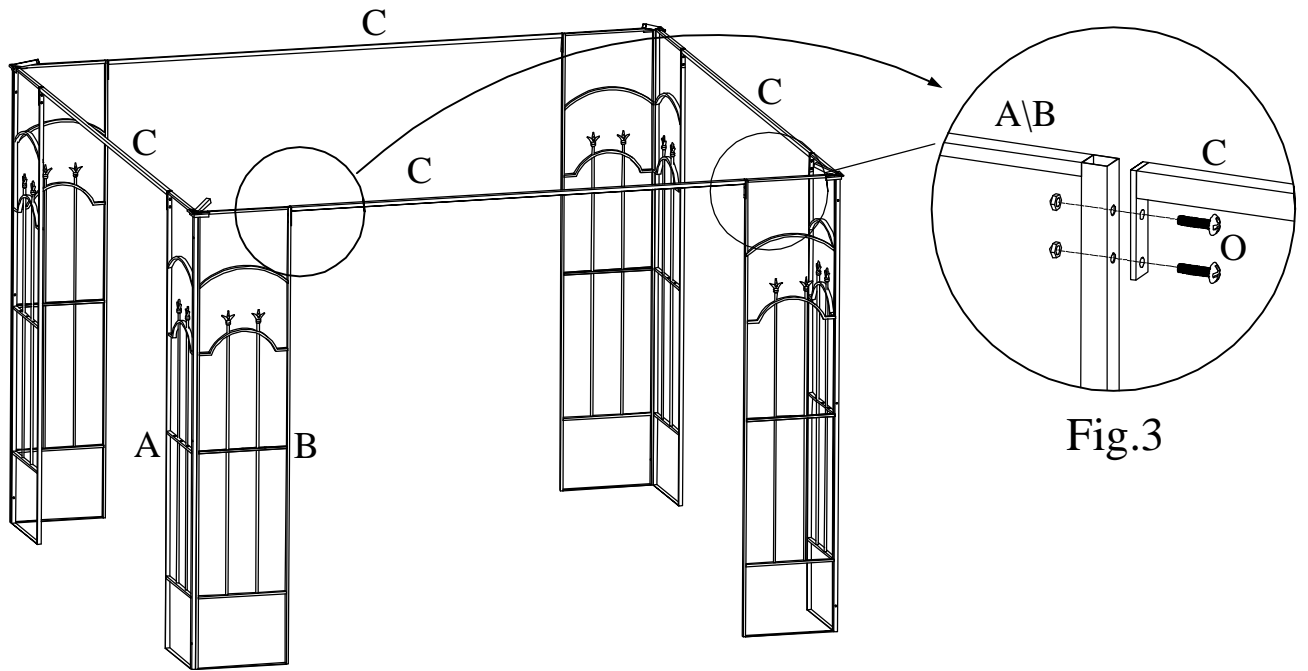

Step 4: Insert the 4 Canopy Spokes (D) into the 4 long tubes of the Lower Canopy Hub (H). Insert the 4 Canopy Frames (E) into the 4 short tubes of the Lower Canopy Hub (H). Make sure all push pins are in place. See Figure 4

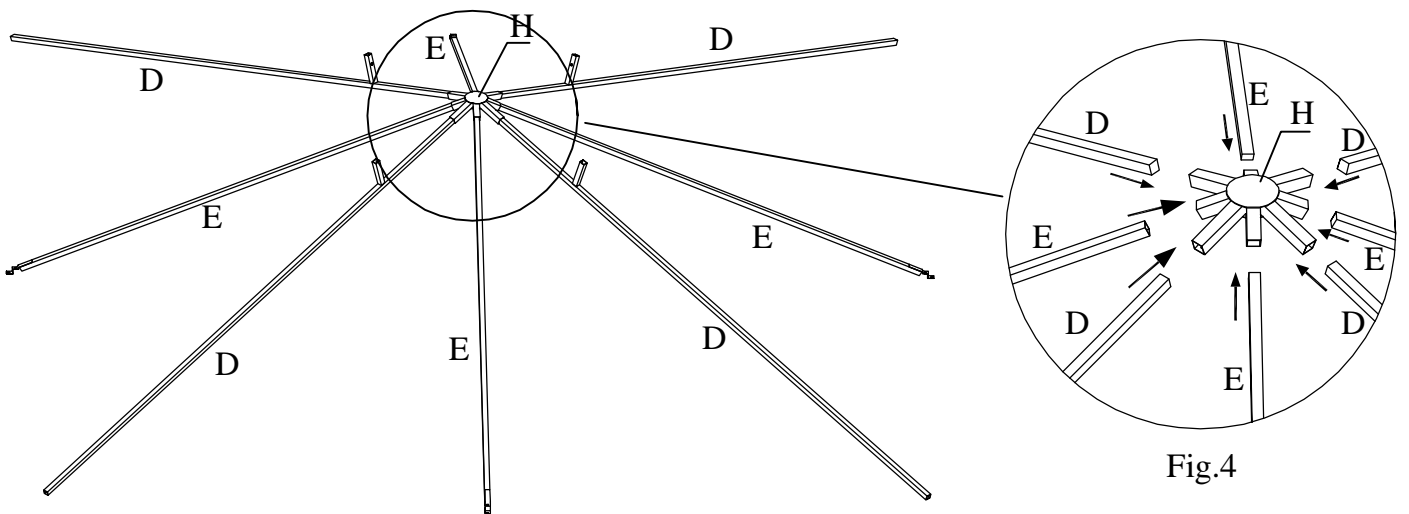

Step 5: Place the Large Fabric Cover (Q) on the top frames assembled in **Step 4**. But do not tighten it in place. See Figure 5.

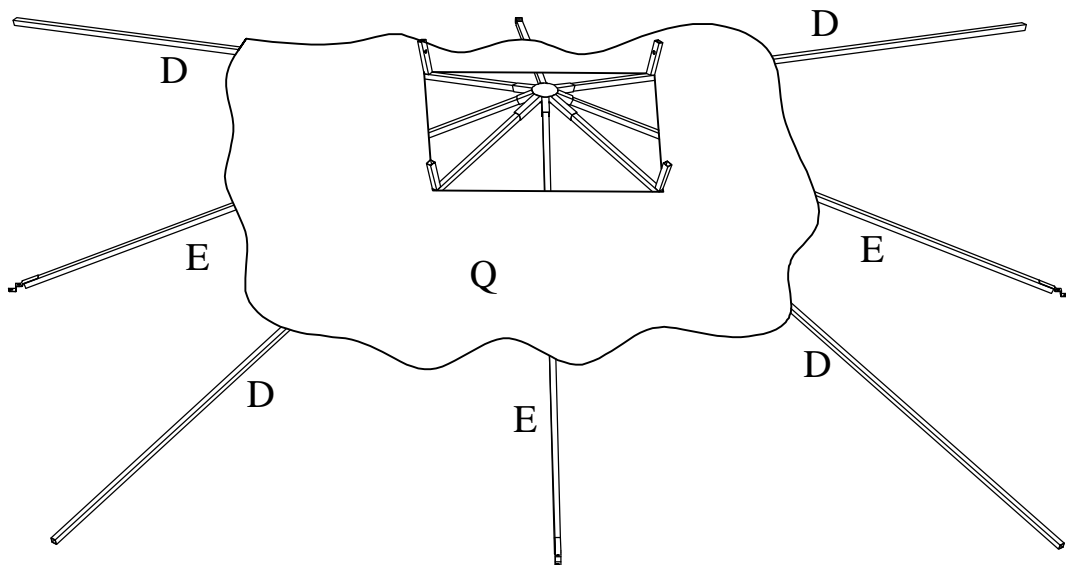

- Step 6:**
- Insert 3 Short Canopy Spokes (G) into the Upper Canopy Hub (J) first. See Figure 6.
 - Then install the Small Fabric Cover (P) on the 3 Short Canopy Spokes (G) and pull the 3 corresponding pouches of the Small Fabric Cover (O) onto the ends of the 3 Short Canopy Spokes (G). See Figure 7.
 - Pull the remaining pouch of the Small Fabric Cover (O) onto the end of the remaining Short Canopy Spoke (G). See Figure 8.
 - Then insert the remaining Short Canopy Spoke (G) into the Upper Canopy Hub (J). See Figure 9.
- Make sure all snap buttons are in place. Screw the Top Finial (U) on the Upper Canopy Hub (J). See Figure 10.

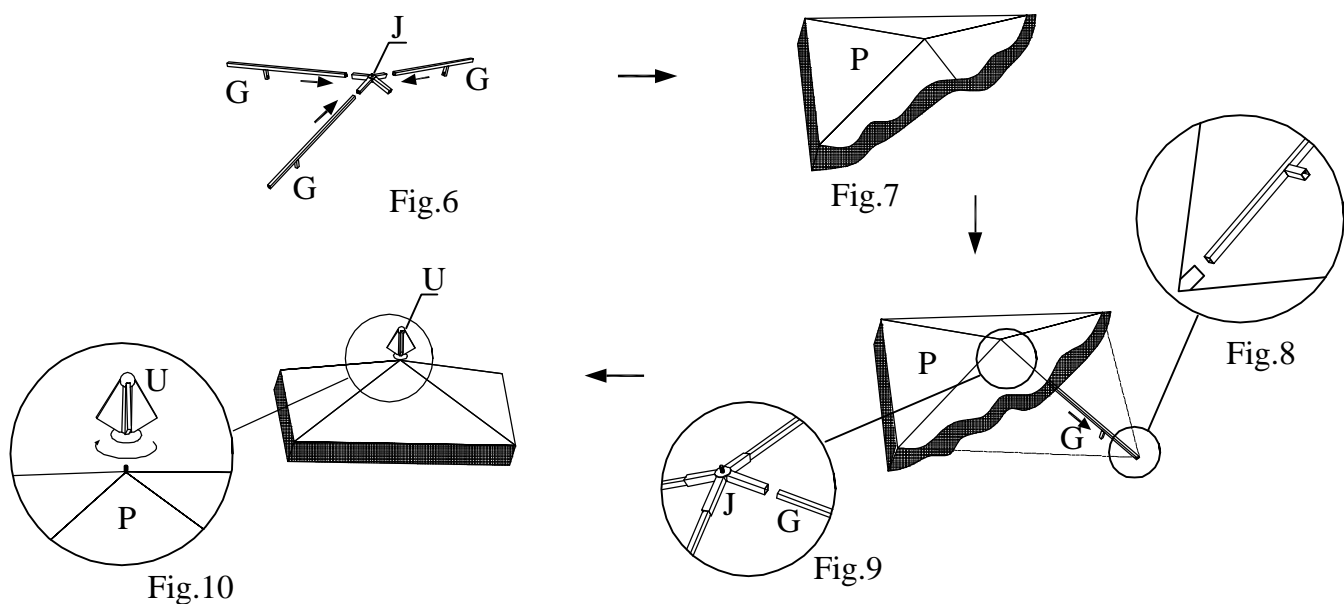

Step 7: Insert the tubes of the 4 Short Canopy Spokes (G) into the tubes of each Canopy Spokes (D). Make sure all push pins are in place. See Figure 11

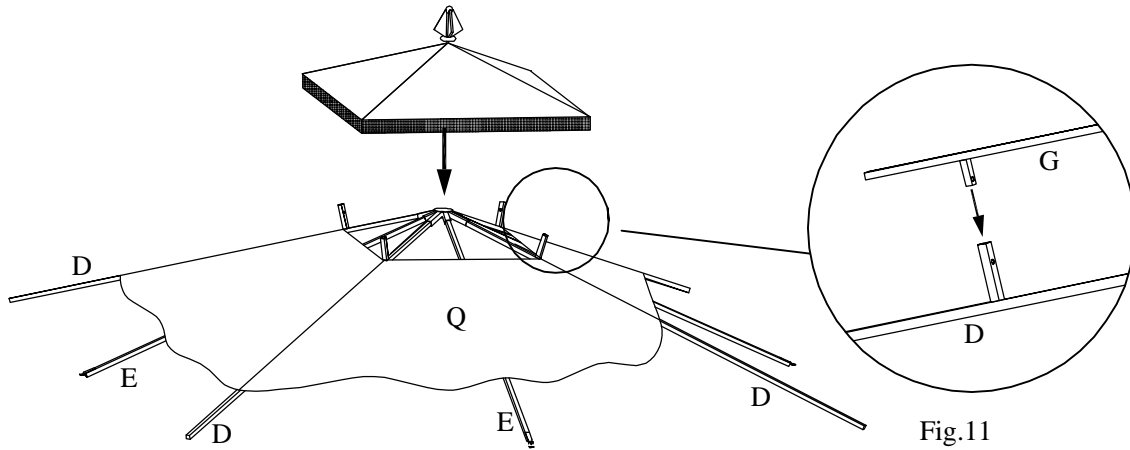

Step 8: Place the assembled structure in **Step 7** on top of the assembled panel structure on **Step 3**. Insert the 4 Canopy Spokes (D) into the 4 Corner Connectors (I). Make sure all push pins are in place. See Figure 12. Fix the metal pieces on the ends of each Canopy Frames (E) onto the 4 Beams (C) by using M6X16 Bolts (M). See Figure 13. Place the Corner Shelves (S) on the assembled panel . See Figure 14.

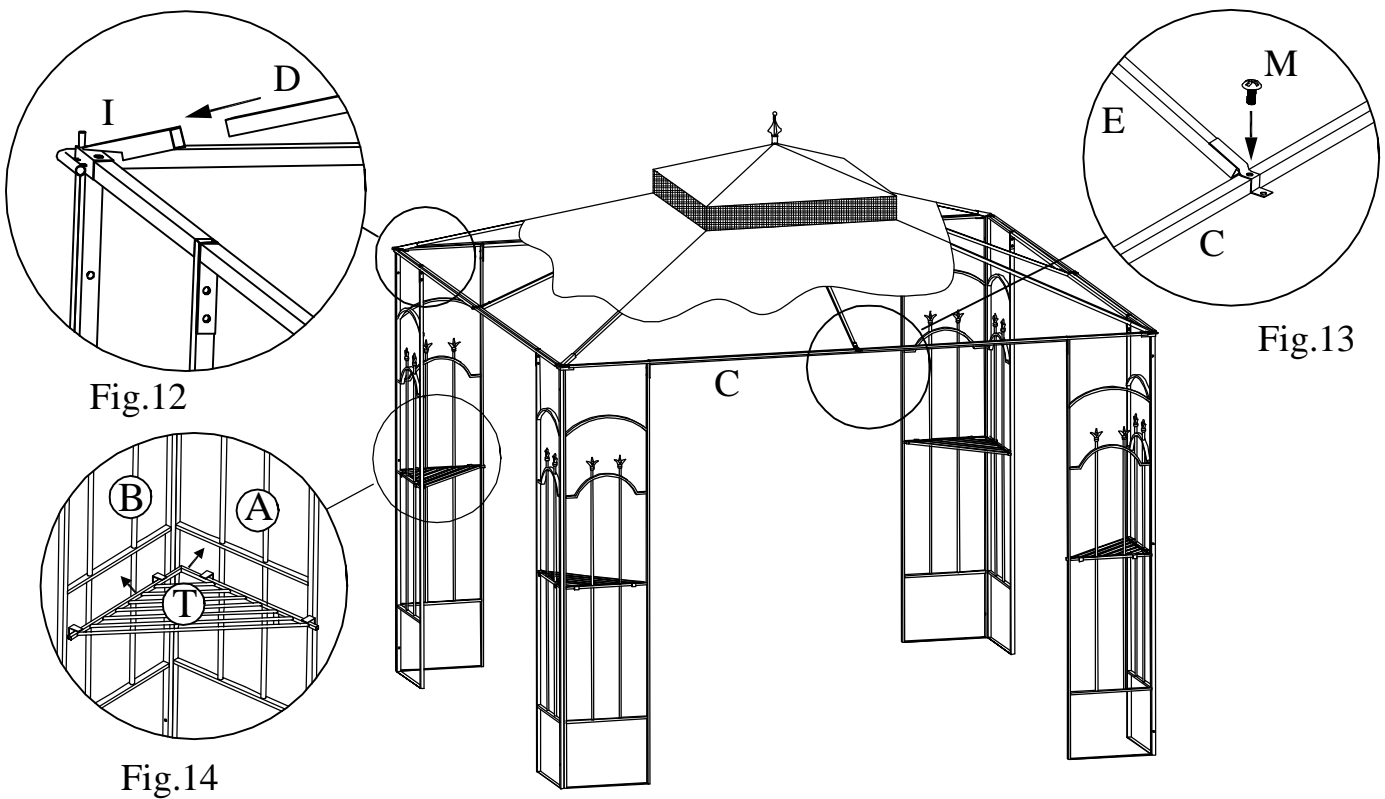

Step 9: Insert the end of the Track Tube (F) into the Corner Connector (I). See Figure 15. Insert the other end of the Track Tube (F) into the bracket on the end of the Canopy Frame (E) and fix them together by using M6X10 Bolts & Nuts (N). Repeat for the remaining Track Tubes (F) 7 times. See Figure 16.

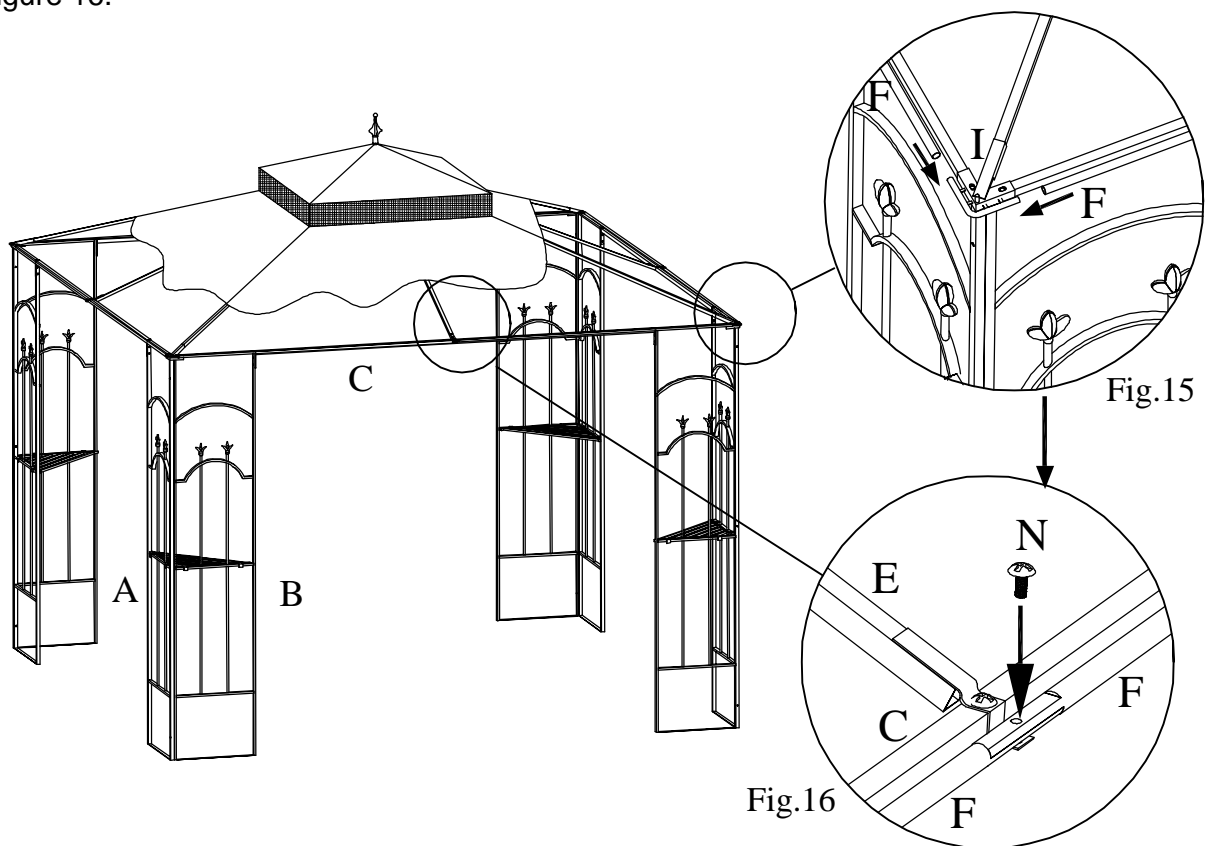

Step 10: Put up the Nettings (R) onto the Track Tubes (F) by using the Plastic Rings (S). Hang the fabric buckles in the middle of the Nettings (R) onto the bolts of the Corner Connectors (I). See figure 17.

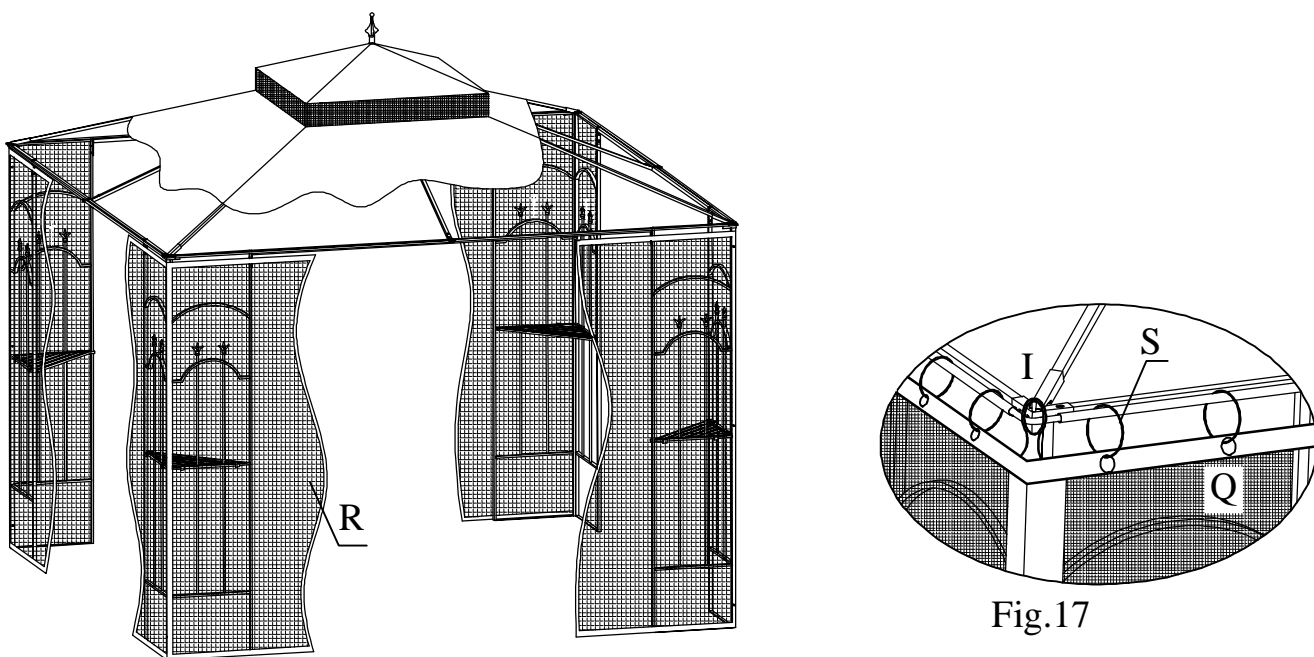

Step 11: Pull the Large Fabric Cover (Q) onto the Corner Connectors (I). Attach all the Velcro of the Large Fabric Cover (Q) on the top frames and the top bars of the Panels (A & B). See the Figure 18. Screw the 4 Corner Arrows (V) onto the 4 Corner Connectors (I). See Figure 19. Hammer the ground spikes to the ground through the holes on the flat bars on the bottom of the assembled panels . See Figure 20

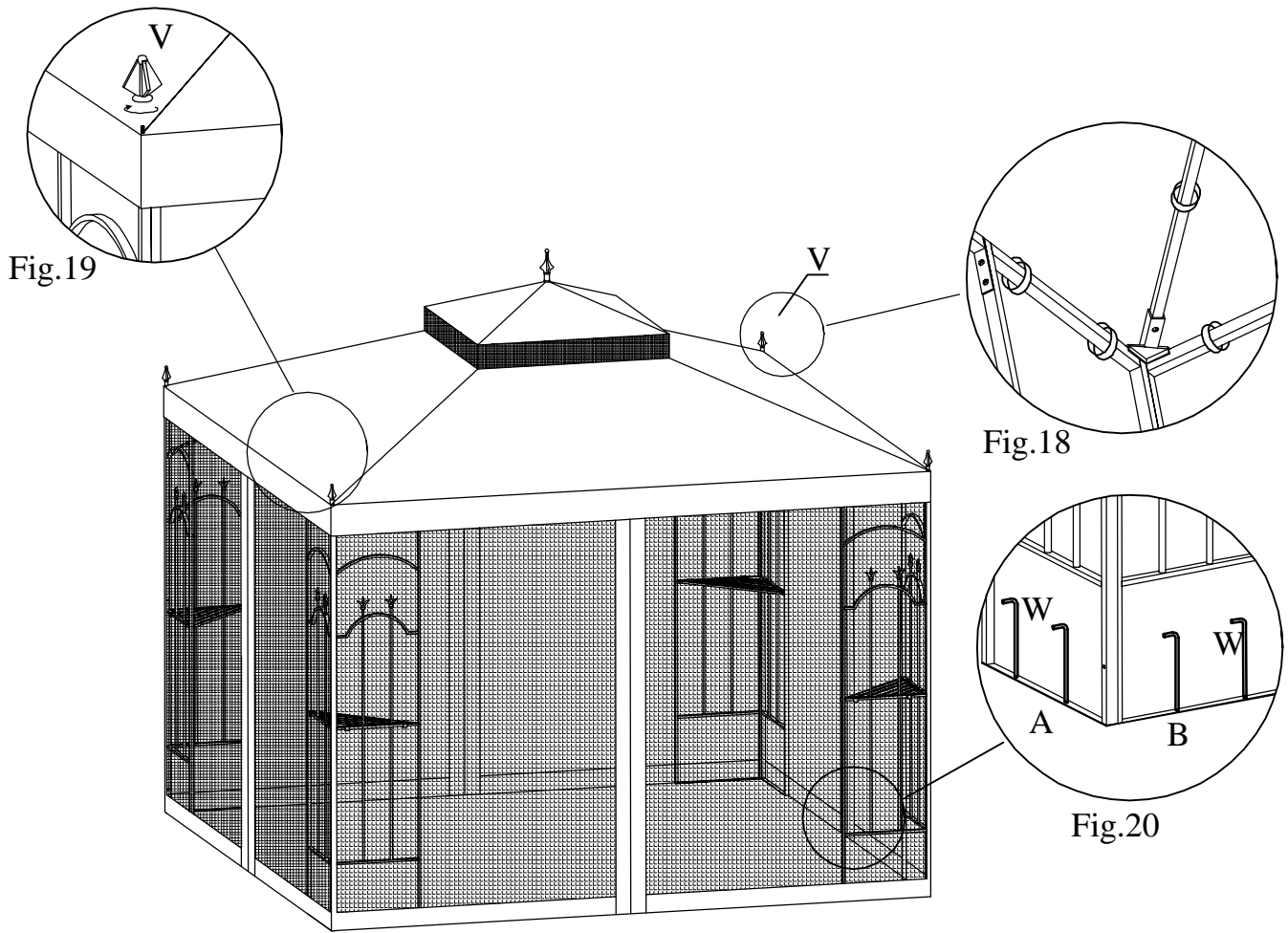

Step12: Hanging on the lantern(X) to the hook under part "H" by the "S", shape hook on the chain. see Fig 21

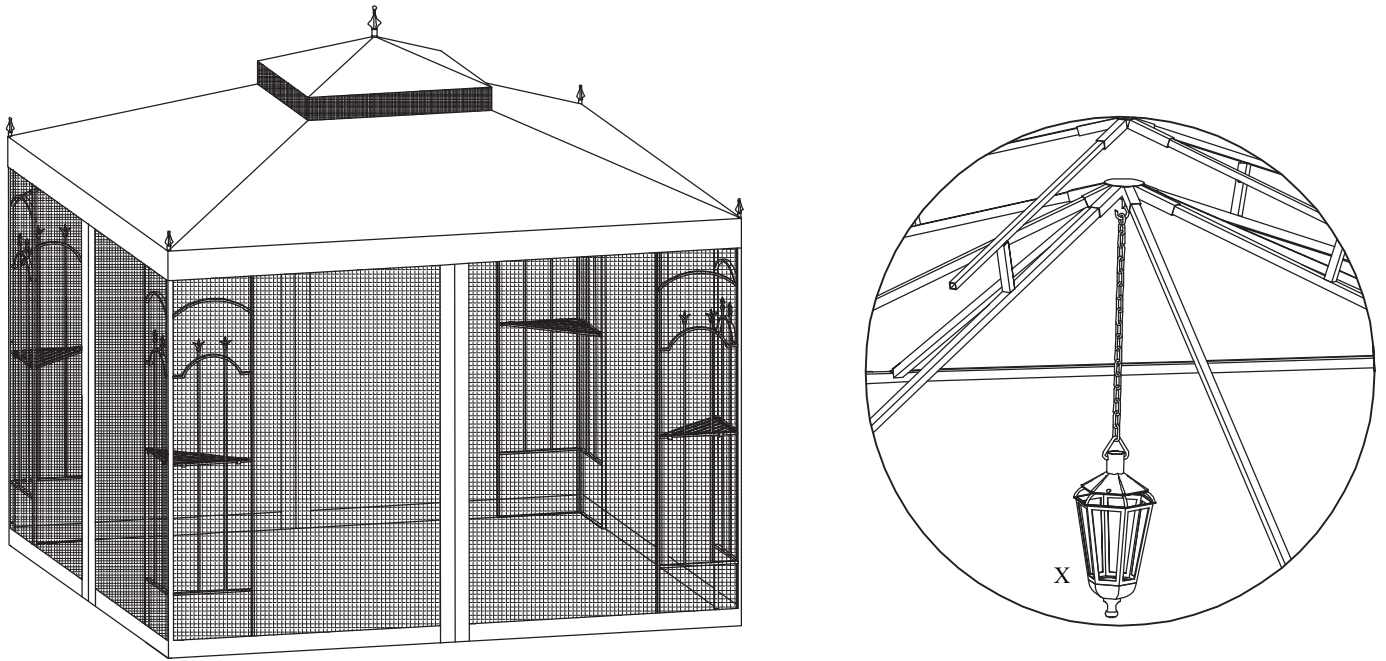
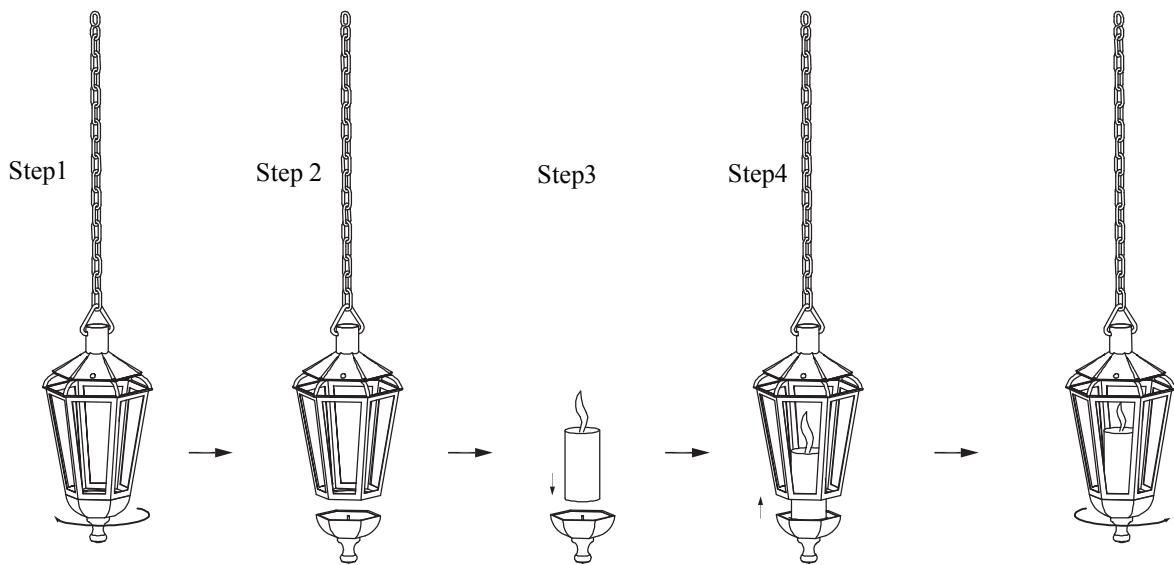

Fig. 21



Hanging Lantern Assembly instructions. (see Fig.22)

Step1: To loose the bottom plate.

Step2: To fix the candle on the nail which in middle of the plate. Lighten on.

Step3: Put back the bottom plate with the candle.

Step4: Fix with the frame.

Attnetion:

- 1, Candles are not provided and need to be purchased separately.
- 2, NEVER leave lit candles unattended at any time.
- 3, When the latern is in use with a lit candle children are not to play around the gazebo and must have adult supervision.
- 4, The Lanterns are not toy's and need to be handled by adults only.
- 5, To avoid damage to your lantern and gazebo the candle in your lantern must not exceed the dimensions of 1.5" diameter and 1.75" height.

Free Manuals Download Website

<http://myh66.com>

<http://usermanuals.us>

<http://www.somanuals.com>

<http://www.4manuals.cc>

<http://www.manual-lib.com>

<http://www.404manual.com>

<http://www.luxmanual.com>

<http://aubethermostatmanual.com>

Golf course search by state

<http://golfingnear.com>

Email search by domain

<http://emailbydomain.com>

Auto manuals search

<http://auto.somanuals.com>

TV manuals search

<http://tv.somanuals.com>