

fx-100MS
fx-570MS
fx-991MS
(2nd edition / S-V.P.A.M.)

User's Guide

CASIO Worldwide Education Website

<https://edu.casio.com>

Manuals are available in multi languages at

<https://world.casio.com/manual/calc/>

Table of Contents

Before Using the Calculator	4
About this Manual.....	4
Initializing the Calculator.....	4
Precautions.....	4
Getting Started.....	5
Removing the Hard Case.....	5
Turning Power On and Off.....	6
Adjusting Display Contrast.....	6
Key Markings.....	6
Reading the Display.....	7
Calculation Modes and Calculator Setup	9
Calculation Mode.....	9
Configuring the Calculator Setup.....	10
Initializing the Calculation Mode and Other Settings.....	12
Basic Calculations	13
Inputting Expression and Values.....	13
Making Corrections During Input.....	13
Arithmetic Calculations.....	14
Number of Decimal Places and Number of Significant Digits.....	15
Omitting a Final Closed Parenthesis.....	15
Fraction Calculations.....	16
Decimal ↔ Fraction Conversion.....	16
Mixed Fraction ↔ Improper Fraction Conversion.....	17
Percent Calculations.....	17
Degree, Minute, Second (Sexagesimal) Calculations.....	19
Inputting Sexagesimal Values.....	19
Sexagesimal Calculations.....	19
Converting Values between Sexagesimal and Decimal.....	20
Multi-Statements.....	20
Using Engineering Notation.....	20
Using Engineering Symbols.....	21
Calculation History and Replay.....	23
Calculation History.....	23
Replay Copy.....	23
Replay.....	24
Using Memory Functions.....	24
Answer Memory (Ans).....	24
Variables (A, B, C, D, E, F, M, X, Y).....	25
Independent Memory (M).....	26
Clearing the Contents of All Memories.....	26

Function Calculations.....	27
Pi (π), Natural Logarithm Base e	27
Pi (π).....	27
Natural Logarithm Base e	27
Trigonometric Functions, Inverse Trigonometric Functions.....	28
Trigonometric Functions.....	28
Inverse Trigonometric Functions.....	28
Hyperbolic Functions, Inverse Hyperbolic Functions.....	29
Angle Unit Conversion.....	29
Exponential Functions, Logarithmic Functions.....	29
Exponential Functions.....	29
Logarithmic Functions.....	30
Power Functions and Power Root Functions.....	30
Integration Calculations.....	31
Differential Calculations.....	32
Rectangular-Polar Coordinate Conversion.....	32
Factorial (!).....	33
Random Number (Ran#).....	33
Permutation (nPr) and Combination (nCr).....	34
Rounding function (Rnd).....	34
Using CALC.....	34
Using SOLVE.....	35
Scientific Constants (fx-570MS/fx-991MS only).....	37
Metric Conversion (fx-570MS/fx-991MS only).....	39
Using Calculation Modes.....	42
Complex Number Calculations (CMPLX).....	42
CMPLX Mode Calculation Examples.....	42
Using a Command to Specify the Calculation Result Format.....	43
Statistical Calculations (SD, REG).....	43
Standard Deviation (SD).....	43
Regression Calculations (REG).....	46
Normal Distribution (SD).....	51
Base- n Calculations (BASE).....	52
Specifying the Number Mode of a Particular Input Value.....	53
Converting a Calculation Result to another Type of Value.....	53
Base- n Calculation Examples.....	54
Logical and Negation Operations.....	54
Equation Calculations (EQN).....	55
Quadratic and Cubic Equations.....	55
Simultaneous Equations.....	57
Matrix Calculations (MAT) (fx-570MS/fx-991MS only).....	59
Matrix Answer Memory.....	60
Assigning and Editing Matrix Variable Data.....	60
Matrix Calculation Examples.....	61
Vector Calculations (VCT) (fx-570MS/fx-991MS only).....	62

Vector Answer Memory.....	63
Assigning and Editing Vector Variable Data.....	63
Vector Calculation Examples.....	64
Technical Information.....	66
Errors.....	66
Error Messages.....	66
Before Assuming Malfunction of the Calculator.....	67
Replacing the Battery.....	68
Calculation Priority Sequence.....	68
Stacks.....	70
Calculation Ranges, Number of Digits, and Precision.....	71
Calculation Range and Precision.....	71
Function Calculation Input Ranges and Precision.....	71
Specifications.....	73

Before Using the Calculator

About this Manual

- In no event shall CASIO Computer Co., Ltd. be liable to anyone for special, collateral, incidental, or consequential damages in connection with or arising out of the purchase or use of this product and items that come with it.
- Moreover, CASIO Computer Co., Ltd. shall not be liable for any claim of any kind whatsoever by any other party arising out of the use of this product and the items that come with it.
- Unless specifically stated, all sample operations in this manual assume that the calculator is in its initial default setup. Use the procedure under "Initializing the Calculator" to return the calculator to its initial default setup.
- The contents of this manual are subject to change without notice.
- The displays and illustrations (such as key markings) shown in this manual are for illustrative purposes only, and may differ somewhat from the actual items they represent.
- Company and product names used in this manual may be registered trademarks or trademarks of their respective owners.

Initializing the Calculator

Perform the following procedure when you want to initialize the calculator and return the calculation mode and setup to their initial default settings. Note that this operation also clears all data currently in calculator memory.

ON **SHIFT** **MODE** (CLR) **3** (All) **☰**

Precautions

Be sure to read the following safety precautions before using the calculator.

Safety Precautions

Battery

- Keep batteries out of the reach of small children.
- Use only the type of battery specified for this calculator in this manual.

Handling Precautions

- Even if the calculator is operating normally, replace the battery according to the schedule shown below. Continued use after the specified number of years may result in abnormal operation. Replace the battery immediately after display figures become dim.
 - fx-100MS/fx-570MS: Every two years
 - fx-991MS: Every three years
- A dead battery can leak, causing damage to and malfunction of the calculator. Never leave a dead battery in the calculator.
- **The battery that comes with the calculator is for factory testing, and it discharges slightly during shipment and storage. Because of these reasons, its battery life may be shorter than normal.**
- Do not use a nickel-based primary battery with this product. Incompatibility between such batteries and product specifications can result in shorter battery life and product malfunction.
- Avoid use and storage of the calculator in areas subjected to temperature extremes, and large amounts of humidity and dust.
- Do not subject the calculator to excessive impact, pressure, or bending.
- Never try to take the calculator apart.
- Use a soft, dry cloth to clean the exterior of the calculator.
- Whenever discarding the calculator or batteries, be sure to do so in accordance with the laws and regulations in your particular area.

Getting Started

Removing the Hard Case

Before using the calculator, slide its hard case downwards to remove it, and then affix the hard case to the back of the calculator as shown in the illustration below.

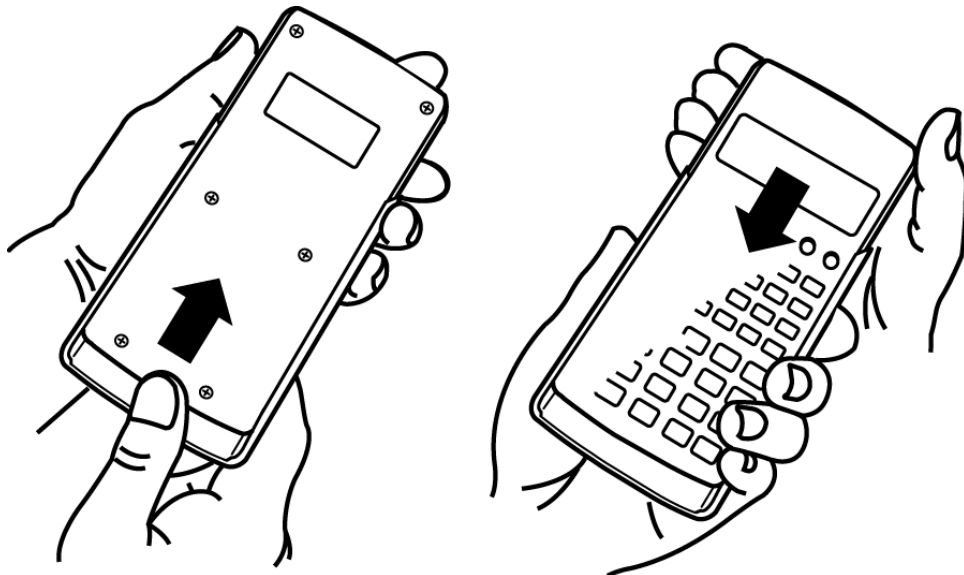

Turning Power On and Off

- Press **ON** to turn on the calculator.
- Press **SHIFT AC** (OFF) to turn off the calculator.

Note

- The calculator also will turn off automatically after approximately 10 minutes of non-use. Press the **ON** key to turn the calculator back on.

Adjusting Display Contrast

1. Press **MODE MODE MODE MODE MODE MODE**.
 - This displays the display setup screen.

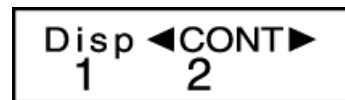

2. Press **2**.
3. Use **◀** and **▶** to adjust display contrast.
4. After the setting is the way you want, press **AC**.

Important!

- If adjusting display contrast does not improve display readability, it probably means that battery power is low. Replace the battery.

Key Markings

Pressing the **SHIFT** or **ALPHA** key followed by a second key performs the alternate function of the second key. The alternate function is indicated by the text printed above the key.



(1) Keycap function (2) Alternate function

- The following shows what the different colors of the alternate function key text mean.

If key marking text is this color:	It means this:
Yellow	Press SHIFT and then the key to access the applicable function.
Red	Press ALPHA and then the key to input the applicable variable, constant, function, or symbol.
Purple (or enclosed in purple brackets)	Enter the CMPLX Mode to access the function.
Blue (or enclosed in blue brackets)	Enter the SD Mode and REG Mode to access the function.
Green	Enter the BASE Mode to access the function.

- The following shows an example of how an alternate function operation is represented in this manual.

Example: **SHIFT** **sin** $(\sin^{-1})^*$ 1 **□**

* Indicates the function that is accessed by the key operation (**SHIFT** **sin**) before it. Note that this is not part of the actual key operation you perform.

- The following shows an example of how a key operation to select an on-screen menu item is represented in this manual.

Example: **1** **(COMP)***

* Indicates the menu item that is selected by the number key operation (**1**) before it. Note that this is not part of the actual key operation you perform.

- The cursor key is marked with four arrows, indicating direction, as shown in the illustration nearby. In this manual, cursor key operation is indicated as **▲**, **▼**, **◀**, and **▶**.

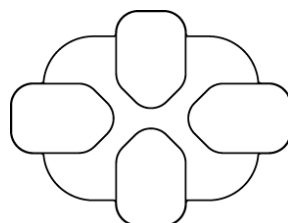

Reading the Display

The two-line display makes it possible to view both the calculation formula and its result at the same time.



(1) Calculation formula

(2) Calculation result

(3) Indicators

- The table below describes some of the typical indicators that appear at the top of the screen (3).

This indicator:	Means this:
S	The keypad has been shifted by pressing the SHIFT key. The keypad will unshift and this indicator will disappear when you press a key.
A	The alpha input mode has been entered by pressing the ALPHA key. The alpha input mode will be exited and this indicator will disappear when you press a key.
D/R/G	Indicates the current setting of Angle Unit (D : Degree, R : Radian, or G : Gradian) on the setup menu.
FIX	A fixed number of decimal places is in effect.
SCI	A fixed number of significant digits is in effect.
M	There is a value stored in independent memory.
STO	The calculator is standing by for input of a variable name to assign a value to the variable. This indicator appears after you press SHIFT RCL (STO).
RCL	The calculator is standing by for input of a variable name to recall the variable's value. This indicator appears after you press RCL .

Calculation Modes and Calculator Setup

Calculation Mode

Before starting a calculation, you must first enter the correct mode as indicated in the table below.

fx-100MS

When you want to perform this type of operation:	Perform this key operation:
General calculations	MODE 1 (COMP)
Complex number calculations	MODE 2 (CMPLX)
Standard deviation	MODE MODE 1 (SD)
Regression calculations	MODE MODE 2 (REG)
Calculations involving specific number systems (binary, octal, decimal, hexadecimal)	MODE MODE 3 (BASE)
Equation solution	MODE MODE MODE 1 (EQN)

fx-570MS/fx-991MS

When you want to perform this type of operation:	Perform this key operation:
General calculations	MODE 1 (COMP)
Complex number calculations	MODE 2 (CMPLX)
Standard deviation	MODE MODE 1 (SD)
Regression calculations	MODE MODE 2 (REG)

When you want to perform this type of operation:	Perform this key operation:
Calculations involving specific number systems (binary, octal, decimal, hexadecimal)	MODE MODE 3 (BASE)
Equation solution	MODE MODE MODE 1 (EQN)
Matrix calculations	MODE MODE MODE 2 (MAT)
Vector calculations	MODE MODE MODE 3 (VCT)

Note

- The initial default calculation mode is the COMP Mode.
- Mode indicators appear in the upper part of the display, except for the BASE indicators, which appear in the exponent part of the display.
- Engineering symbols are automatically turned off while the calculator is the BASE Mode.
- You cannot make changes to the angle unit or other display format (Disp) settings while the calculator is in the BASE Mode.
- The COMP, CMPLX, SD, and REG Modes can be used in combination with the angle unit settings.
- Be sure to check the current calculation mode (SD, REG, COMP, CMPLX) and angle unit setting (Deg, Rad, Gra) before beginning a calculation.

Configuring the Calculator Setup

Pressing the **MODE** key more than three times displays additional setup screens.

Underlined () settings are initial defaults.

Deg	Rad	Gra
<u>1</u>	<u>2</u>	<u>3</u>

1 Deg **2** Rad **3** Gra

Specifies degrees, radians or grads as the angle unit for value input and calculation result display.

(90° = $\pi/2$ radians = 100 grads)

Fix	Sci	Norm
<u>1</u>	<u>2</u>	<u>3</u>

1 Fix **2** Sci **3** Norm

Specifies the number of digits for display of a calculation result.

Fix: The value you specify (from 0 to 9) controls the number of decimal places for displayed calculation results. Calculation results are rounded off to the specified digit before being displayed.

Example: $100 \div 7 = 14.286$ (Fix 3)
 14.29 (Fix 2)

Sci: The value you specify (from 1 to 10) controls the number of significant digits for displayed calculation results. Calculation results are rounded off to the specified digit before being displayed.

Example: $1 \div 7 = 1.4286 \times 10^{-1}$ (Sci 5)
 $1.428571429 \times 10^{-1}$ (Sci 0)

Norm: Selecting one of the two available settings (Norm 1, Norm 2) determines the range in which results will be displayed in exponential format. Outside the specified range, results are displayed using non-exponential format.

Norm 1: $10^{-2} > |x|, |x| \geq 10^{10}$

Norm 2: $10^{-9} > |x|, |x| \geq 10^{10}$

Example: $1 \div 200 = 5 \times 10^{-3}$ (Norm 1)
 0.005 (Norm 2)

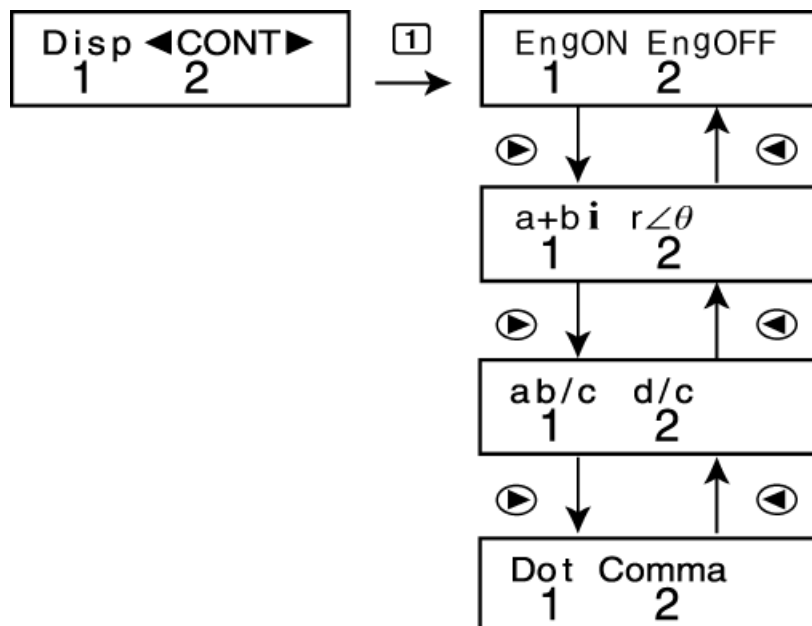

1 EngON 2 EngOFF

Specifies whether engineering symbols are used (EngON) or not used (EngOFF) during value input. The "Eng" indicator is displayed while EngON is selected.

1 a+bi 2 r θ (CMPLX Mode/EQN Mode only)

Specifies either rectangular coordinates ($a + bi$) or polar coordinates ($r \angle \theta$) for CMPLX Mode/EQN Mode solutions. The " $r \angle \theta$ " indicator is displayed while polar coordinates ($r \angle \theta$) are selected.

1 ab/c **2** d/c

Specifies either mixed fraction (ab/c) or improper fraction (d/c) for display of fractions in calculation results.

1 Dot **2** Comma

Specifies whether to display a dot or a comma for the calculation result decimal point. A dot is always displayed during input.

Dot: Period decimal point, comma separator

Comma: Comma decimal point, period separator

Note

- To close the setup menu without selecting anything, press **AC**.

Initializing the Calculation Mode and Other Settings

Performing the following procedure initializes the calculation mode and other setup settings as shown below.

ON **SHIFT** **MODE** (CLR) **2** (Mode) **☰**

This setting:	Is initialized to this:
Calculation Mode	COMP
Angle Unit	Deg
Exponential Display Format	Norm 1, EngOFF
Complex Number Display Format	$a+bi$
Fraction Display Format	a b/c
Decimal Point Character	Dot

- To cancel initialization without doing anything, press **AC** (Cancel) instead of **☰**.

Basic Calculations

Use the **MODE** key to enter the COMP Mode when you want to perform basic calculations.

MODE **1** (COMP) **-** **0.**

Inputting Expression and Values

Example: $4 \times \sin 30 \times (30 + 10 \times 3) = 120$ (Angle unit: Deg)

4 **×** **sin** 30 **×** (30 **+** 10 **×** 3) **=** **4xsin 30x(30**
120.

Note

- The memory area used for calculation input can hold 79 "steps". One step is taken up each time you press a number key or arithmetic operator key (**+**, **-**, **×**, **÷**). A **SHIFT** or **ALPHA** key operation does not take up a step, so inputting **SHIFT** **∧** (\sqrt{x}), for example, takes up only one step.
- You can input up to 79 steps for a single calculation. Whenever you input the 73rd step of any calculation, the cursor changes from "_" to "■" to let you know memory is running low. If you need to input more than 79 steps, you should divide your calculation into two or more parts.
- Pressing the **Ans** key recalls the last result obtained, which you can use in a subsequent calculation. See "Using Memory Functions - Answer Memory" for more information about using the **Ans** key.

Making Corrections During Input

- Use **◀** and **▶** to move the cursor to the location you want.
- Press **DEL** to delete the number or function at the current cursor position.
- Press **SHIFT** **DEL** (INS) to change to an insert cursor **⏏**. Inputting something while the insert cursor is on the display inserts the input at the insert cursor position.
- Pressing **SHIFT** **DEL** (INS), or **=** returns to the normal cursor from the insert cursor.

Example 1: To correct cos60 so it becomes sin60

cos 60 **cos 60_** **0.**

◀◀◀ [sin] sin 60 0.

Example 2: To correct the expression $369 \times \times 2$ so it becomes 369×2

369 [x] [x] 2 369××2_ 0.

◀◀ [DEL] 369×2 0.

Example 3: To correct 2.36^2 so it becomes $\sin 2.36^2$

2 [.] 36 [x²] 2.36²_ 0.

◀◀◀◀◀ [SHIFT] [DEL] (INS) [sin] sin 2.36² 0.

Clearing all of the calculation you are inputting
Press [AC].

Arithmetic Calculations

- Negative values inside of calculations must be enclosed within parentheses. For details, see "Calculation Priority Sequence."
- It is not necessary to enclose a negative exponent within parentheses.

$\sin 2.34 \times 10^{-5} \rightarrow$ [sin] 2 [.] 34 [x10ⁿ] [(-)] 5

Example 1: $23 + 4.5 - 53 = -25.5$

23 [+] 4 [.] 5 [-] 53 [=] -25.5

Example 2: $56 \times (-12) \div (-2.5) = 268.8$

56 [x] [(] [(-)] 12 [)] [÷] [(] [(-)] 2 [.] 5 [)] [=] 268.8

Example 3: $2 \div 3 \times (1 \times 10^{20}) = 6.666666667 \times 10^{19}$

2 [÷] 3 [x] 1 [x10ⁿ] 20 [=] 6.666666667×10¹⁹

Example 4: $7 \times 8 - 4 \times 5 = 36$

7 [x] 8 [-] 4 [x] 5 [=] 36.

Example 5: $\frac{6}{4 \times 5} = 0.3$

$$6 \div (4 \times 5) =$$

0.3

Example 6: $2 \times [7 + 6 \times (5 + 4)] = 122$

$$2 \times (7 + 6 \times (5 + 4)) =$$

122.

Number of Decimal Places and Number of Significant Digits

To change the settings for the number of decimal places, the number of significant digits, or the exponential display format, press the **MODE** key a number of times until you reach the setup screen shown below.

Fix	Sci	Norm
1	2	3

Press the number key (**1**, **2**, or **3**) that corresponds to the setup item you want to change.

- 1** (Fix): Number of decimal places
- 2** (Sci): Number of significant digits
- 3** (Norm): Exponential display format

Example 1: $200 \div 7 \times 14 =$

$$200 \div 7 \times 14 =$$

400.

(Specifies three decimal places.)

$$\text{MODE} \dots \text{1 (Fix) 3}$$

FIX
400.000

- Press **MODE** \dots **3** (Norm) **1** to clear the Fix specification.

Example 2: $1 \div 3$, displaying result with two significant digits (Sci 2)

$$\text{MODE} \dots \text{2 (Sci) 2} \quad 1 \div 3 =$$

SCI
3.3⁻⁰¹

- Press **MODE** \dots **3** (Norm) **1** to clear the Sci specification.

Omitting a Final Closed Parenthesis

Example: $(2 + 3) \times (4 - 1) = 15$

$$(2 + 3) \times (4 - 1) =$$

15.

Fraction Calculations

Example 1: $\frac{2}{3} + \frac{1}{5} = \frac{13}{15}$

2 $\frac{a}{b}$ 3 + 1 $\frac{a}{b}$ 5 =

13_15.

Example 2: $3\frac{1}{4} + 1\frac{2}{3} = 4\frac{11}{12}$

3 $\frac{a}{b}$ 1 $\frac{a}{b}$ 4 + 1 $\frac{a}{b}$ 2 $\frac{a}{b}$ 3 =

4_11_12.

Example 3: $\frac{1}{2} + 1.6 = 2.1$

1 $\frac{a}{b}$ 2 + 1 . 6 =

2.1

Note

- Values are displayed in decimal format automatically whenever the total number of digits of a fractional value (integer + numerator + denominator + separator marks) exceeds 10.
- Results of calculations that mix fraction and decimal values are always decimal.

Decimal ↔ Fraction Conversion

To switch a calculation result between fraction and decimal format:

Press $\frac{a}{b}$.

Example 1: $2.75 = 2\frac{3}{4}$ (Decimal → Fraction)

2 . 75 =

2.75

$\frac{a}{b}$

2_3_4.

= $\frac{11}{4}$

SHIFT $\frac{a}{b}$ (d/c)

11_4.

Example 2: $\frac{1}{2} \leftrightarrow 0.5$ (Fraction ↔ Decimal)

1 $\frac{a}{b}$ 2 =

1_2.

$\frac{a}{b}$

0.5

$\frac{a}{b}$

1_2.

Mixed Fraction ↔ Improper Fraction Conversion

To switch a calculation result between improper fraction and mixed fraction format:

Press SHIFT $\frac{a}{b}$ (d/c).

Example 1: $1\frac{2}{3} \leftrightarrow \frac{5}{3}$

$1\frac{2}{3}$	$\frac{5}{3}$
SHIFT $\frac{a}{b}$ (d/c)	$1\frac{2}{3}$
SHIFT $\frac{a}{b}$ (d/c)	$\frac{5}{3}$

Note

- You can use the display setup (Disp) screen to specify the display format when a fraction calculation result is greater than one.
- To change the fraction display format, press the MODE key a number of times until you reach the setup screen shown below.

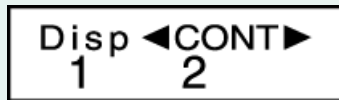

Display the selection screen.

1 (Disp) ▶

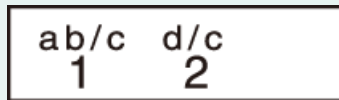

Press the number key (1 or 2) that corresponds to the setting you want to use.

1 (ab/c): Mixed fraction

2 (d/c): Improper fraction

- An error occurs if you try to input a mixed fraction while the d/c display format is selected.

Percent Calculations

Calculation Type	Calculation Formula	Calculation Method and Key Operations
Percentage Example 1	$\frac{A \times B}{100}$	What is B percent of A? $A \times B \text{SHIFT} \text{=}$ (%)

Calculation Type	Calculation Formula	Calculation Method and Key Operations
Ratio Example 2	$\frac{A}{B} \times 100$	What percent of B is A? A $\boxed{\div}$ B $\boxed{\text{SHIFT}} \boxed{=}$ (%)
Premium Example 3	$A + \frac{A \times B}{100}$	What is A increased by B percent? A $\boxed{\times}$ B $\boxed{\text{SHIFT}} \boxed{=}$ (%) $\boxed{+}$
Discount Example 4 Example 5	$A - \frac{A \times B}{100}$	What is A decreased by B percent? A $\boxed{\times}$ B $\boxed{\text{SHIFT}} \boxed{=}$ (%) $\boxed{-}$
Rate of Change (1) Example 6	$\frac{A + B}{B} \times 100$	If A is added to B, by what percent does B change? A $\boxed{+}$ B $\boxed{\text{SHIFT}} \boxed{=}$ (%)
Rate of Change (2) Example 7	$\frac{A - B}{B} \times 100$	If B becomes A, by what percent does B change? A $\boxed{-}$ B $\boxed{\text{SHIFT}} \boxed{=}$ (%)

Example 1: To calculate 12% of 1500 (180)

$$1500 \boxed{\times} 12 \boxed{\text{SHIFT}} \boxed{=} (\%) \quad 180.$$

Example 2: To calculate what percentage of 880 is 660 (75%)

$$660 \boxed{\div} 880 \boxed{\text{SHIFT}} \boxed{=} (\%) \quad 75.$$

Example 3: To increase 2500 by 15% (2875)

$$2500 \boxed{\times} 15 \boxed{\text{SHIFT}} \boxed{=} (\%) \boxed{+} \quad 2875.$$

Example 4: To decrease 3500 by 25% (2625)

$$3500 \boxed{\times} 25 \boxed{\text{SHIFT}} \boxed{=} (\%) \boxed{-} \quad 2625.$$

Example 5: To decrease the sum of 168, 98, and 734 by 20% (800)

$$168 \boxed{+} 98 \boxed{+} 734 \boxed{=} \boxed{\text{Ans}} \boxed{\text{SHIFT}} \boxed{\text{RCL}} (\text{STO}) \boxed{\leftarrow} (\text{A})$$

$$\boxed{\text{ALPHA}} \boxed{\leftarrow} (\text{A}) \boxed{*} 20 \boxed{\text{SHIFT}} \boxed{=} (\%) \boxed{-} \quad 800.$$

* As shown here, if you want to use the current Answer Memory value in a mark up or discount calculation, you need to assign the Answer Memory value into a variable and then use the variable in the mark up/discount calculation. This is because the calculation performed when $\boxed{\text{M}}(\%)$ is pressed stores a result to Answer Memory before the $\boxed{\text{M}}$ key is pressed.

Example 6: 300 grams are added to a test sample originally weighing 500 grams, producing a final test sample of 800 grams. What percent of 500 grams is 800 grams? (160%)

$$300 \boxed{+} 500 \boxed{\text{SHIFT}} \boxed{\text{M}} (\%) \quad 160.$$

Example 7: What is the percentage change when a value is increased from 40 to 46? How about to 48? (15%, 20%)

$$46 \boxed{-} 40 \boxed{\text{SHIFT}} \boxed{\text{M}} (\%) \quad 15.$$

$$\boxed{\leftarrow} \boxed{\leftarrow} \boxed{\leftarrow} \boxed{\leftarrow} \boxed{\leftarrow} \boxed{\leftarrow} 8 \boxed{\text{M}} \quad 20.$$

Degree, Minute, Second (Sexagesimal) Calculations

You can perform calculations using sexagesimal values, and convert values between sexagesimal and decimal.

Inputting Sexagesimal Values

The following is the syntax for inputting a sexagesimal value.

{Degrees} $\boxed{^{\circ}}$ {Minutes} $\boxed{'}$ {Seconds} $\boxed{''}$

- Note that you must always input something for the degrees and minutes, even if they are zero.

Example: Input 2°0'30"

$$2 \boxed{^{\circ}} 0 \boxed{' } 30 \boxed{''} \boxed{\text{M}} \quad 2^{\circ}0'30.$$

Sexagesimal Calculations

Performing the following types of sexagesimal calculations produces a sexagesimal result.

- Addition or subtraction of two sexagesimal values
- Multiplication or division of a sexagesimal value and a decimal value

Example 1: 2°20'30" + 39'30"

2 [°] 20 ['] 30 ["] + 0 [°] 39 ['] 30 ["] [=]

3°0'0"

Example 2: $12^{\circ}34'56'' \times 3.45$

12 [°] 34 ['] 56 ["] × 3 [.] 45 [=]

43°24'31.2"

Converting Values between Sexagesimal and Decimal

Example: To convert the decimal value 2.258 to a sexagesimal value and then back to a decimal value

2 [.] 258 [=]

2.258

[SHIFT] [°] (←)

2°15'28.8"

[°]

2.258

Multi-Statements

You can use the colon character (:) to connect two or more expressions and execute them in sequence from left to right when you press [=].

Example: To add 2 + 3 and then multiply the result by 4

2 [+] 3 [ALPHA] [∫dx] (:) [Ans] [×] 4 [=]

2+3	5. Disp
-----	---------

[=]

Ans×4	20.
-------	-----

Using Engineering Notation

A simple key operation transforms a displayed value to engineering notation.

Example 1: To convert 56088 meters to kilometers → 56.088×10^3 (km)

56088 [=] [ENG]



56.088×10⁰³

Example 2: To convert 0.08125 grams to milligrams → 81.25×10^{-3} (mg)





0 [.] 08125 [=] [ENG]

81.25×10⁻⁰³

Example 3: Transform the value 1234 to engineering notation, shifting the decimal point to the right.

1234 	1234.
	1.234×10^3
	$1234. \times 10^0$

Example 4: Transform the value 123 to engineering notation, shifting the decimal point to the left.

















123 	123.
  (←)	0.123×10^3
  (←)	0.000123×10^6

Note

- The calculation result shown above is what appears when EngOFF is selected for the engineering symbol setting.

Using Engineering Symbols

The following are the nine symbols that can be used when engineering symbols are turned on.

To input this symbol:	Perform this key operation:	Unit
k (kilo)	  (k)	10^3
M (Mega)	  (M)	10^6
G (Giga)	  (G)	10^9
T (Tera)	  (T)	10^{12}
m (milli)	  (m)	10^{-3}
μ (micro)	  (μ)	10^{-6}
n (nano)	  (n)	10^{-9}
p (pico)	  (p)	10^{-12}

To input this symbol:	Perform this key operation:	Unit
f (femto)	(f)	10 ⁻¹⁵

Note

- For displayed values, the calculator selects the engineering symbol that makes the numeric part of the value fall within the range of 1 to 1000.
- Engineering symbols cannot be used when inputting fractions.

To display calculation results with engineering symbols

1. Press the key a number of times until you reach the display setup screen.

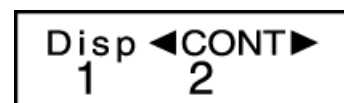

2. Press .

- This displays the engineering symbol setting screen.



3. Press (EngON).

- An indicator "Eng" is displayed at top of the screen.

Example 1: 100 m (milli) × 5 μ (micro) = 500 n (nano)



Example 2: 9 ÷ 10 = 0.9 m (milli)

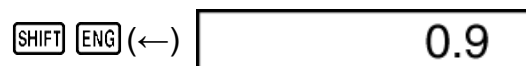
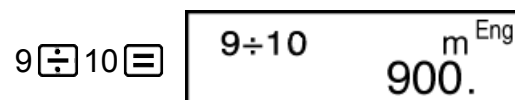

When engineering symbols are turned on, even standard (non-engineering) calculation results are displayed using engineering symbols.

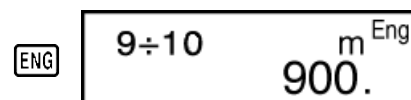

Calculation History and Replay

Calculation History

In the COMP, CMPLX, or BASE Mode, the calculator remembers up to approximately 150 bytes of data for the newest calculation.

An ▲ and/or ▼ at the top of the display indicates that there is more calculation history content above and/or below.

You can scroll through calculation history contents using ▲ and ▼.

Example:

1 + 1 = 2	1 $\boxed{+}$ 1 $\boxed{=}$	2.
2 + 2 = 4	2 $\boxed{+}$ 2 $\boxed{=}$	4.
3 + 3 = 6	3 $\boxed{+}$ 3 $\boxed{=}$	6.
	(Scrolls back.) ▲	4.
	(Scrolls back again.) ▲	2.

Note

- Calculation history data is all cleared whenever you press \boxed{ON} , when you change to a different calculation mode, or whenever you initialize modes and settings.

Replay Copy

Replay copy lets you recall multiple expressions from replay so they are connected as a multi-statement on the screen.

Example:

Replay memory contents:

1 + 1
2 + 2
3 + 3
4 + 4
5 + 5
6 + 6

Multi-statement: 4 + 4 : 5 + 5 : 6 + 6

Use ▲ and ▼ to display the expression 4 + 4.

Press \boxed{SHIFT} ▲ (COPY).

1 $\boxed{+}$ 1 $\boxed{=}$ 2 $\boxed{+}$ 2 $\boxed{=}$ 3 $\boxed{+}$ 3 $\boxed{=}$ 4 $\boxed{+}$ 4 $\boxed{=}$	6+6	▲
5 $\boxed{+}$ 5 $\boxed{=}$ 6 $\boxed{+}$ 6 $\boxed{=}$	12.	

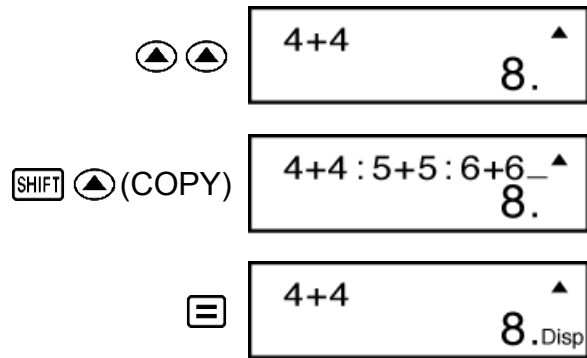

Note

- You can also edit expressions on the display and perform other multi-statement operations. For more details about using multi-statements, see "Multi-statements."
- Only the expressions in replay memory starting from the currently displayed expression and continuing to the last expression are copied. Anything before the displayed expression is not copied.

Replay

While a calculation result is on the display, you can press \blacktriangleleft or \blacktriangleright to edit the expression you used for the previous calculation.

Example: $4 \times 3 + 2 = 14$
 $4 \times 3 - 7 = 5$

$4 \times 3 + 2 = 14.$

(Continuing) \blacktriangleleft DEL DEL $- 7 = 5.$

Using Memory Functions

Answer Memory (Ans)

- Whenever you press $=$ after inputting values or an expression, the calculated result automatically updates Answer Memory contents by storing the result.
- In addition to $=$, Answer Memory contents are also updated with result whenever you press $\text{SHIFT} \text{ } =$ (%), $\text{M}+$, $\text{SHIFT} \text{ } \text{M}+$ (M-), or $\text{SHIFT} \text{ } \text{RCL}$ (STO) followed by a letter (A through F, or M, X, or Y).
- You can recall Answer Memory contents by pressing Ans .
- Answer Memory can store up to 15 digits for the mantissa and two digits for the exponent.
- Answer Memory contents are not updated if the operation performed by any of the above key operations results in an error.

Consecutive Calculations

- You can use the calculation result that is currently on the display (and also stored in Answer Memory) as the first value of your next calculation. Note that pressing an operator key while a result is displayed causes the displayed value to change to Ans, indicating it is the value that is currently stored in Answer Memory.
- The result of a calculation can also be used with a subsequent Type A function (x^2 , x^3 , x^{-1} , $x!$, DRG \blacktriangleright), $+$, $-$, x^y , $\sqrt[x]{}$, \times , \div , nPr and nCr .

Example 1: To divide the result of 3×4 by 30

$$3 \times 4 = 12.$$

(Continuing) $\div 30 = 0.4$

Ans $\div 30$	0.4
---------------	-----

Example 2: To perform the calculations shown below:

$$123 + 456 = 579 \quad 789 - 579 = 210$$

$$123 + 456 = 579.$$

(Continuing) $789 - \text{Ans} = 210.$

Variables (A, B, C, D, E, F, M, X, Y)

Your calculator has nine preset variables named A, B, C, D, E, F, M, X, and Y. You can assign values to variables and use the variables in calculations.

Example:

To assign the result of $3 + 5$ to variable A

$$3 + 5 \text{ [SHIFT] [RCL] (STO) (A)} = 8.$$

To multiply the contents of variable A by 10

$$\text{(Continuing) [ALPHA] (A) \times 10 = 80.}$$

To recall the contents of variable A

$$\text{(Continuing) [RCL] (A) = 8.}$$

To clear the contents of variable A

$$0 \text{ [SHIFT] [RCL] (STO) (A)} = 0.$$

Independent Memory (M)

You can add calculation results to or subtract results from independent memory.

The "M" indicator appears on the display when there is any value other than zero stored in independent memory.

Example 1:

To clear the contents of M

0 **SHIFT** **RCL** (STO) **M+** (M) 0.

To add the result of 10×5 to M

(Continuing) 10 **×** 5 **M+** 50.

To subtract the result of $10 + 5$ from M

(Continuing) 10 **+** 5 **SHIFT** **M+** (M-) 15.

To recall the contents of M

(Continuing) **RCL** **M+** (M) 35.

Example 2:

23 + 9 = 32
53 - 6 = 47
-) 45 × 2 = 90
99 ÷ 3 = 33
(Total) 22

23 **+** 9 **SHIFT** **RCL** (STO) **M+** (M) 32.

53 **-** 6 **M+** 47.

45 **×** 2 **SHIFT** **M+** (M-) 90.

99 **÷** 3 **M+** 33.

RCL **M+** (M) 22.

Clearing the Contents of All Memories

Independent memory and variable contents are retained even if you press **AC**, or turn off the calculator.

Perform the following procedure when you want to clear the contents of all memories.

ON **SHIFT** **MODE** (CLR) **1** (Mcl) **=**

Function Calculations

Use the **MODE** key to enter the COMP Mode when you want to perform function calculations.

MODE **1** (COMP) **-** **0.**

Using functions can slow down a calculation, which may delay display of the result. To interrupt an ongoing calculation before its result appears, press **AC**.

Pi (π), Natural Logarithm Base e

Pi (π)

You can input pi (π) into a calculation.

The following shows the required key operations and the values this calculator uses for pi (π).

$$\pi = 3.14159265358980 \text{ (} \text{SHIFT} \text{ } \times 10^0 \text{) (} \pi \text{)}$$

π is displayed as 3.141592654, but $\pi = 3.14159265358980$ is used for internal calculations.

- You can use π in any calculation mode except for BASE.

Natural Logarithm Base e

You can input natural logarithm base e into a calculation.

The following shows the required key operations and the values this calculator uses for e .

$$e = 2.71828182845904 \text{ (} \text{ALPHA} \text{ } \ln \text{) (} e \text{)}$$

e is displayed as 2.718281828, but $e = 2.71828182845904$ is used for internal calculations.

- You can use e in any calculation mode except for BASE.

Trigonometric Functions, Inverse Trigonometric Functions

Trigonometric Functions

- To change the default angle unit (degrees, radians, grads), press the **MODE** key a number of times until you reach the angle unit setup screen shown below.

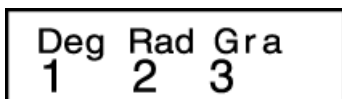

- Press the number key (**1**), (**2**), or (**3**) that corresponds to the angle unit you want to use.
($90^\circ = \pi/2$ radians = 100 grads)

Example 1: $\sin 30^\circ = 0.5$ (Angle unit: Deg)

MODE **1** (Deg) **sin** 30 **=** 0.5

Example 2: $\cos(\frac{\pi}{3}) = 0.5$ (Angle unit: Rad)

MODE **2** (Rad) **cos** (**SHIFT** **x10^π** (**π**) **÷** 3) **=** 0.5

Example 3: $\tan(-35) = -0.612800788$ (Angle unit: Gra)

MODE **3** (Gra) **tan** ((**←**) 35) **=** -0.612800788

Inverse Trigonometric Functions

Example 1: $\sin^{-1} 0.5 = 30^\circ$ (Angle unit: Deg)

MODE **1** (Deg) **SHIFT** **sin** (**sin**⁻¹) 0 **·** 5 **=** 30.

Example 2: $\cos^{-1} \frac{\sqrt{2}}{2} = 0.25\pi (= \frac{\pi}{4})$ (Angle unit: Rad)

MODE **2** (Rad) **SHIFT** **cos** (**cos**⁻¹) ((**√**) 2 **÷** 2) **=** **Ans** **÷** **SHIFT** **x10^π** (**π**) **=** 0.25

Example 3: $\tan^{-1} 0.741 = 36.53844577^\circ$ (Angle unit: Deg)

MODE **1** (Deg)

SHIFT **tan** (\tan^{-1}) **0** **7** **4** **1** **=**

36.53844577

Hyperbolic Functions, Inverse Hyperbolic Functions

Example 1: $\sinh 3.6 = 18.28545536$

hyp **sin** (\sinh) **3** **.** **6** **=**

18.28545536

Example 2: $\sinh^{-1} 30 = 4.094622224$

hyp **SHIFT** **sin** (\sinh^{-1}) **3** **0** **=**

4.094622224

Angle Unit Conversion

Press **SHIFT** **Ans** (**DRG** \blacktriangleright) to display the following menu.

D	R	G
1	2	3

Pressing **1**, **2**, or **3** converts the displayed value to the corresponding angle unit.

Example: To convert the 4.25 radians to degrees

MODE **1** (Deg)

4 **.** **2** **5** **SHIFT** **Ans** (**DRG** \blacktriangleright) **2** (**R**) **=**

4.25 ^r
243.5070629

Exponential Functions, Logarithmic Functions

Exponential Functions

Example 1: $e^{10} = 22026.46579$

SHIFT **In** (e^x) **1** **0** **=**

22026.46579

Example 2: $10^{1.5} = 31.6227766$

SHIFT **log** (10^x) **1** **.** **5** **=**

31.6227766

Example 3: $2^{-3} = 0.125$

2 $\sqrt{\square}$ \leftarrow 3 \square

0.125

Example 4: $(-2)^4 = 16$

$\left(\leftarrow 2 \right) \sqrt{\square} 4 \square$

16.

Note

- Negative values inside of calculations must be enclosed within parentheses. For details, see "Calculation Priority Sequence."

Logarithmic Functions

Example 1: $\log 1.23 = 0.089905111$

$\log 1 \cdot 23 \square$

0.089905111

Example 2: $\ln 90 (= \log_e 90) = 4.49980967$

$\ln 90 \square$

4.49980967

Example 3: $\ln e = 1$

$\ln \text{ALPHA} \ln (e) \square$

1.

Power Functions and Power Root Functions

Example 1: $\sqrt{2} + \sqrt{3} \times \sqrt{5} = 5.287196909$

$\sqrt{\square} 2 \square + \sqrt{\square} 3 \square \times \sqrt{\square} 5 \square$

5.287196909

Example 2: $\sqrt[3]{5} + \sqrt[3]{-27} = -1.290024053$

fx-100MS:

$\text{SHIFT} \sqrt{x^3} (\sqrt[3]{\square}) 5 \square + \text{SHIFT} \sqrt{x^3} (\sqrt[3]{\square}) \left(\leftarrow 27 \right) \square \square$

-1.290024053

fx-570MS/fx-991MS:

$\text{SHIFT} \sqrt{\square} (\sqrt[3]{\square}) 5 \square + \text{SHIFT} \sqrt{\square} (\sqrt[3]{\square}) \left(\leftarrow 27 \right) \square \square$

-1.290024053

Example 3: $\sqrt[7]{123} (= 123^{\frac{1}{7}}) = 1.988647795$

7 $\text{SHIFT} \sqrt{\square} (\sqrt[3]{\square}) 123 \square$

1.988647795

Example 4: $123 + 30^2 = 1023$

$$123 \oplus 30 x^2 \equiv$$

1023.

Example 5: $12^3 = 1728$

fx-100MS:

$$12 x^3 \equiv$$

1728.

fx-570MS/fx-991MS:

$$12 \text{SHIFT} x^2 (x^3) \equiv$$

1728.

Example 6: $\frac{1}{\frac{1}{3} - \frac{1}{4}} = 12$

$$(3 x^1 - 4 x^1) x^1 \equiv$$

12.

Integration Calculations

The procedure described below obtains the definite integral of a function. The following four inputs are required for integration calculations: a function with the variable x ; a and b , which define the integration range of the definite integral; and n , which is the number of partitions (equivalent to $N = 2^n$) for integration using Simpson's rule.

$$\int dx \text{ expression } a b n$$

Example: $\int_1^5 (2x^2 + 3x + 8) dx = 150.6666667$ (Number of partitions $n = 6$)

$$\int dx 2 \text{ALPHA} (X) x^2 \oplus 3 \text{ALPHA} (X)$$

$$\oplus 8 , 1 , 5 , 6) \equiv$$

150.6666667

Note

- Integration calculations can be performed in the COMP Mode only.
- You can specify an integer in the range of 1 to 9 as the number of partitions, or you can skip input of the number of partitions entirely, if you want.
- Internal integration calculations may take considerable time to complete.
- Display contents are cleared while an integration calculation is being performed internally.
- Select Rad (Radian) for the angle unit setting when performing trigonometric function integration calculations.

Differential Calculations

The procedure described below obtains the derivative of a function. Three inputs are required for the differential expression: the function of variable x , the point (a) at which the differential coefficient is calculated, and the change in x (Δx).

SHIFT $\int dx$ (d/dx) expression , a , Δx)

Example: To determine the derivative at point $x = 2$ for the function $y = 3x^2 - 5x + 2$, when the increase or decrease in x is $\Delta x = 2 \times 10^{-4}$ (Result: 7)

SHIFT $\int dx$ (d/dx) 3 ALPHA) (X) x^2 - 5 ALPHA) (X) +
 2 , 2 , 2 $\times 10^{-4}$ (-) 4) = 7.

Note

- Differential calculations can be performed in the COMP Mode only.
- You can omit input of Δx , if you want. The calculator automatically substitutes an appropriate value for Δx if you do not input one.
- Discontinuous points and extreme changes in the value of x can cause inaccurate results and errors.
- Select Rad (Radian) for the angle unit setting when performing trigonometric function differential calculations.

Rectangular-Polar Coordinate Conversion

Pol converts rectangular coordinates to polar coordinates, while Rec converts polar coordinates to rectangular coordinates.

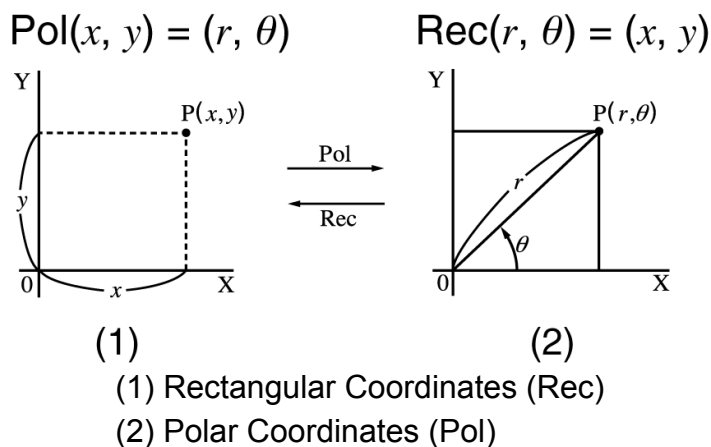

Specify the angle unit before performing calculations.

Calculation result θ is displayed in the range of $-180^\circ < \theta \leq 180^\circ$.

Calculation results are automatically assigned to variables E and F.

Example 1: To convert polar coordinates ($r = 2$, $\theta = 60^\circ$) to rectangular coordinates (x , y) (Angle unit: Deg)

$$x = 1$$

$$\text{[SHIFT] [2nd] (Rec) 2 [2nd] 60 [2nd] [=]} \quad 1.$$

$$y = 1.732050808$$

$$\text{[RCL] [tan] (F)} \quad 1.732050808$$

- Press [RCL] [cos] (E) to display the value of x , or [RCL] [tan] (F) to display the value of y .

Example 2: To convert rectangular coordinates (1 , $\sqrt{3}$) to polar coordinates (r , θ) (Angle unit: Rad)

$$r = 2$$

$$\text{[SHIFT] [+] (Pol) 1 [2nd] [sqrt] 3 [2nd] [=]} \quad 2.$$

$$\theta = 1.047197551$$

$$\text{[RCL] [tan] (F)} \quad 1.047197551$$

- Press [RCL] [cos] (E) to display the value of r , or [RCL] [tan] (F) to display the value of θ .

Factorial (!)

This function obtains the factorials of a value that is zero or a positive integer.

Example: $(5 + 3)! = 40320$

$$\text{[(] 5 [+] 3 [)] [SHIFT] [x!] (x!) [=]} \quad 40320.$$

Random Number (Ran#)

Function that generates a pseudo random number in the range of 0.000 to 0.999.

Example: Generate three 3-digit random numbers.

The random 3 digit decimal values are converted to 3-digit integer values by multiplying by 1000.

Note that the values shown here are examples only. Values actually generated by your calculator will be different.

$$1000 \text{[SHIFT] [Ran#] [=]} \quad 634.$$

\equiv 92.

\equiv 175.

Permutation ($n P r$) and Combination ($n C r$)

These functions make it possible to perform permutation and combination calculations.

n and r must be integers in the range of $0 \leq r \leq n < 1 \times 10^{10}$.

Example 1: To determine how many different 4-digit values can be produced using the numbers 1 through 7

- Numbers cannot be duplicated within the same 4-digit value (1234 is allowed, but 1123 is not).

7 [SHIFT] [X] ($n P r$) 4 [=] 840.

Example 2: To determine how many different 4-member groups can be organized in a group of 10 individuals

10 [SHIFT] [C] ($n C r$) 4 [=] 210.

Rounding function (Rnd)

Using the Rnd function causes decimal fraction values of the argument to be rounded in accordance with the current number of display digits setting (Norm, Fix, Sci). With Norm 1 or Norm 2, the argument is rounded off to 10 digits.

Example: To perform the following calculations when Fix 3 is selected for the number of display digits: $10 \div 3 \times 3$ and $\text{Rnd}(10 \div 3) \times 3$

[MODE] [1] (Fix) [3]

10 $\text{[}\div\text{]}$ 3 $\text{[}\times\text{]}$ 3 [=] 10.000

10 $\text{[}\div\text{]}$ 3 [=] [SHIFT] [0] (Rnd) $\text{[}\times\text{]}$ 3 [=] 9.999

Using CALC

CALC lets you input calculation expressions that include one or more variable, assign values to the variables, and calculate the result. CALC can be used in the COMP Mode and CMPLX Mode.

You can use CALC to save the types of expressions below.

- Expressions that contain variables
Example: $2X + 3Y$, $2AX + 3BY + C$, $A + B$;
- Multi-statements
Example: $X + Y : X(X + Y)$
- Expressions with a single variable on the left
Example: {variable} = {expression}
The expression on the right of the equals sign (input using $\boxed{\text{ALPHA}}$ $\boxed{\text{CALC}}$ (=)) can contain variables.
Example: $Y = 2X$, $Y = X^2 + X + 3$
- To start a CALC operation after inputting an expression, press the $\boxed{\text{CALC}}$ key.

Example: To store $3A + B$ and then substitute the following values to perform the calculation: $(A, B) = (5, 10)$, $(7, 20)$

$3 \boxed{\text{ALPHA}} \boxed{\leftarrow} (A) \boxed{+} \boxed{\text{ALPHA}} \boxed{\text{''''}} (B)$

	3A+B_
$\boxed{\text{CALC}}$	A? 0.
	(1) (2)

- (1) Prompts for input of a value for A
(2) Current value of A

$5 \boxed{=}$ $10 \boxed{=}$	3A+B 25.
$\boxed{\text{CALC}}$ (or $\boxed{=}$)	A 5.
$7 \boxed{=}$ $20 \boxed{=}$	3A+B 41.

To exit CALC: $\boxed{\text{AC}}$

- Note the expression you store is cleared whenever you start another operation, change to another mode, or turn off the calculator.

Using SOLVE

SOLVE lets you solve an expression using variable values you want, without the need to transform or simplify the expression. Note that SOLVE can be used in the COMP Mode only.

Scientific Constants (fx-570MS/ fx-991MS only)

Your calculator comes with 40 built-in scientific constants that can be used in any mode besides BASE. Each scientific constant is displayed as a unique symbol (such as π), which can be used inside of calculations. To input a scientific constant into a calculation, press **CONST** and then input the two-digit number that corresponds to the constant you want.

Example: To input the scientific constant c_0 (speed of light in a vacuum), and display its value.

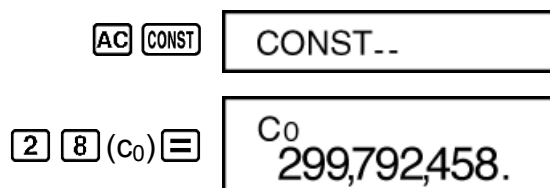

The following shows the two-digit numbers for each of the scientific constants.

01	(m_p) proton mass
02	(m_n) neutron mass
03	(m_e) electron mass
04	(m_μ) muon mass
05	(a_0) Bohr radius
06	(h) Planck constant
07	(μ_N) nuclear magneton
08	(μ_B) Bohr magneton
09	(\hbar) Planck constant, rationalized
10	(α) fine-structure constant
11	(r_e) classical electron radius
12	(λ_c) Compton wavelength
13	(γ_p) proton gyromagnetic ratio

14	(λ_{cp}) proton Compton wavelength
15	(λ_{cn}) neutron Compton wavelength
16	(R_{∞}) Rydberg constant
17	(u) atomic mass unit
18	(μ_p) proton magnetic moment
19	(μ_e) electron magnetic moment
20	(μ_n) neutron magnetic moment
21	(μ_{μ}) muon magnetic moment
22	(F) Faraday constant
23	(e) elementary charge
24	(N_A) Avogadro constant
25	(k) Boltzmann constant
26	(V_m) molar volume of ideal gas
27	(R) molar gas constant
28	(c_0) speed of light in vacuum
29	(c_1) first radiation constant
30	(c_2) second radiation constant
31	(σ) Stefan-Boltzmann constant
32	(ϵ_0) electric constant
33	(μ_0) magnetic constant
34	(Φ_0) magnetic flux quantum
35	(g) standard acceleration of gravity
36	(G_0) conductance quantum
37	(Z_0) characteristic impedance of vacuum

38	(t) Celsius temperature
39	(G) Newtonian constant of gravitation
40	(atm) standard atmosphere (SI unit: Pa)

The values are based on CODATA recommended values (2010).

Metric Conversion (fx-570MS/ fx-991MS only)

The calculator's built-in metric conversion commands make it simple to convert values from one unit to another. You can use the metric conversion commands in any calculation mode except for BASE.

To input a metric conversion command into a calculation, press **SHIFT** **CONST** (CONV) and then input the two-digit number that corresponds to the command you want. When inputting a negative value, enclose it within parentheses **(**, **)**.

Example: To convert -31°C into Fahrenheit

AC **(** **(←)** 31 **)** **SHIFT** **CONST** (CONV) **3** **8** ($^{\circ}\text{C}$ **▶** $^{\circ}\text{F}$) **☰** $(-31)^{\circ}\text{C} \blacktriangleright ^{\circ}\text{F}$
 -23.8

The following shows the two-digit numbers for each of the metric conversion commands.

01	in \blacktriangleright cm
02	cm \blacktriangleright in
03	ft \blacktriangleright m
04	m \blacktriangleright ft
05	yd \blacktriangleright m
06	m \blacktriangleright yd
07	mile \blacktriangleright km
08	km \blacktriangleright mile
09	n mile \blacktriangleright m

10	m ► n mile
11	acre ► m ²
12	m ² ► acre
13	gal (US) ► ℓ
14	ℓ ► gal (US)
15	gal (UK) ► ℓ
16	ℓ ► gal (UK)
17	pc ► km
18	km ► pc
19	km/h ► m/s
20	m/s ► km/h
21	oz ► g
22	g ► oz
23	lb ► kg
24	kg ► lb
25	atm ► Pa
26	Pa ► atm
27	mmHg ► Pa
28	Pa ► mmHg
29	hp ► kW
30	kW ► hp
31	kgf/cm ² ► Pa
32	Pa ► kgf/cm ²
33	kgf • m ► J

34	J ► kgf • m
35	lbf/in ² ► kPa
36	kPa ► lbf/in ²
37	°F ► °C
38	°C ► °F
39	J ► cal
40	cal ► J

Note

- Conversion formula data is based on the "NIST Special Publication 811 (2008)".
- The J ► cal command performs conversion for values at a temperature of 15°C.

Using Calculation Modes

Complex Number Calculations (CMPLX)

Use the **MODE** key to enter the CMPLX Mode when you want to perform basic calculations that include complex numbers.

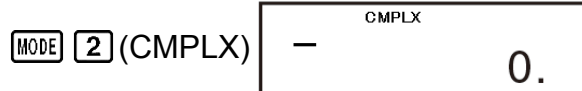

You can use either rectangular coordinates ($a+bi$) or polar coordinates ($r \angle \theta$) to input complex numbers.

Complex number calculation results are displayed in accordance with the complex number format setting on the setup menu.

Example: $(2 + 6i) \div (2i) = 3 - i$ (Complex number format: $a+bi$)

Calculator sequence: $(2 + 6i) \div (2i)$ **MODE** **2** **(CMPLX)** **=** Real part = 3
SHIFT **=** (Re \leftrightarrow Im) Imaginary part = -i

Example: $\sqrt{2} \angle 45 = 1 + i$ (Angle unit: Deg, Complex number format: $a+bi$)

Calculator sequence: $\sqrt{2} \angle 45$ **MODE** **2** **(CMPLX)** **=** Real part = 1
SHIFT **=** (Re \leftrightarrow Im) Imaginary part = i

Note

- You can use variables A, B, C, and M only in the CMPLX Mode. Variables D, E, F, X, and Y are used by the calculator, which frequently changes their values. You should not use these variables in your expressions.
- The indicator "Re \leftrightarrow Im" is displayed while a complex number calculation is on the display. Press **SHIFT** **=** (Re \leftrightarrow Im) to toggle the display between the real part (a) and imaginary part (b), and the absolute value (r) and argument (θ).
- If you are planning to perform input and display of the calculation result in polar coordinate format, specify the angle unit before starting the calculation.
- The θ value of the calculation result is displayed in the range of $-180^\circ < \theta \leq 180^\circ$.

CMPLX Mode Calculation Examples

Example 1: To obtain the conjugate complex number of $2 + 3i$ (Complex number format: $a+bi$)

- Input data is used to calculate values for n , Σx , Σx^2 , \bar{x} , σ_n and s_x , which you can recall using the key operations noted nearby.

To recall this type of value:	Perform this key operation:
Σx^2	$\boxed{\text{SHIFT}} \boxed{1} (\text{S-SUM}) \boxed{1} (\Sigma x^2)$
Σx	$\boxed{\text{SHIFT}} \boxed{1} (\text{S-SUM}) \boxed{2} (\Sigma x)$
n	$\boxed{\text{SHIFT}} \boxed{1} (\text{S-SUM}) \boxed{3} (n)$
\bar{x}	$\boxed{\text{SHIFT}} \boxed{2} (\text{S-VAR}) \boxed{1} (\bar{x})$
σ_x	$\boxed{\text{SHIFT}} \boxed{2} (\text{S-VAR}) \boxed{2} (\sigma_x)$
s_x	$\boxed{\text{SHIFT}} \boxed{2} (\text{S-VAR}) \boxed{3} (s_x)$

Example: To calculate s_x , σ_x , \bar{x} , n , Σx , and Σx^2 for the following data :
55, 54, 51, 55, 53, 53, 54, 52

In the SD Mode:

$\boxed{\text{SHIFT}} \boxed{\text{MODE}} (\text{CLR}) \boxed{1} (\text{Sci}) \boxed{\text{=}} (\text{Stat clear})$

55 $\boxed{\text{DT}}$

$n = \overset{\text{SD}}{\quad} 1.$

Each time you press $\boxed{\text{DT}}$ to register your input, the number of data input up to that point is indicated on the display (n value).

54 $\boxed{\text{DT}}$ 51 $\boxed{\text{DT}}$ 55 $\boxed{\text{DT}}$ 53 $\boxed{\text{DT}}$ $\boxed{\text{DT}}$ 54 $\boxed{\text{DT}}$ 52 $\boxed{\text{DT}}$

Sample Standard Deviation (s_x) = 1.407885953

$\boxed{\text{SHIFT}} \boxed{2} (\text{S-VAR}) \boxed{3} (s_x) \boxed{\text{=}}$ 1.407885953

Population Standard Deviation (σ_x) = 1.316956719

$\boxed{\text{SHIFT}} \boxed{2} (\text{S-VAR}) \boxed{2} (\sigma_x) \boxed{\text{=}}$ 1.316956719

Arithmetic Mean (\bar{x}) = 53.375

$\boxed{\text{SHIFT}} \boxed{2} (\text{S-VAR}) \boxed{1} (\bar{x}) \boxed{\text{=}}$ 53.375

Number of Data (n) = 8

$\boxed{\text{SHIFT}} \boxed{1} (\text{S-SUM}) \boxed{3} (n) \boxed{\text{=}}$ 8.

Sum of Values (Σx) = 427

$\boxed{\text{SHIFT}} \boxed{1} (\text{S-SUM}) \boxed{2} (\Sigma x) \boxed{\text{=}}$ 427.

Sum of Squares of Values (Σx^2) = 22805

$\boxed{\text{SHIFT}} \boxed{1} (\text{S-SUM}) \boxed{1} (\Sigma x^2) \boxed{=}$ 22805.

Data Input Precautions

- $\boxed{\text{DT}} \boxed{\text{DT}}$ inputs the same data twice.
- You can also input multiple entries of the same data using $\boxed{\text{SHIFT}} \boxed{,}$ (;). To input the data 110 ten times, for example, press 110 $\boxed{\text{SHIFT}} \boxed{,}$ (;) 10 $\boxed{\text{DT}}$.
- You can perform the above key operations in any order, and not necessarily that shown above.
- While inputting data or after inputting data is complete, you can use the $\boxed{\blacktriangle}$ and $\boxed{\blacktriangledown}$ keys to scroll through data you have input. If you input multiple entries of the same data using $\boxed{\text{SHIFT}} \boxed{,}$ (;) to specify the data frequency (number of data items) as described above, scrolling through data shows both the data item and a separate screen for the data frequency (Freq).
- You can then edit the displayed data, if you want. Input the new value and then press the $\boxed{=}$ key to replace the old value with the new one. This also means that if you want to perform some other operation (calculation, recall of statistical calculation results, etc.), you should always press the $\boxed{\text{AC}}$ key first to exit data display.
- Pressing the $\boxed{\text{DT}}$ key instead of $\boxed{=}$ after changing a value on the display registers the value you input as a new data item, and leaves the old value as it is.
- You can delete a data value displayed using $\boxed{\blacktriangle}$ and $\boxed{\blacktriangledown}$ by pressing $\boxed{\text{SHIFT}} \boxed{\text{M+}}$ (CL). Deleting a data value causes all values following it to be shifted up.
- Data values you register are normally stored in calculator memory. The message "Data Full" appears and you will not be able to input any more data if there is no memory left for data storage. If this happens, press the $\boxed{=}$ key to display the screen shown below.

Ed i tOFF ESC
1 2

Press $\boxed{2}$ to exit data input without registering the value you just input.

Press $\boxed{1}$ if you want to register the value you just input, without saving it in memory. If you do this, however, you will not be able to display or edit any of the data you have input.

- To delete data you have just input, press $\boxed{\text{SHIFT}} \boxed{\text{M+}}$ (CL).
- After inputting statistical data in the SD Mode or REG Mode, you will be unable to display or edit individual data items any longer after perform either the following operations.
 - Changing to another mode
 - Changing the regression type (Lin, Log, Exp, Pwr, Inv, Quad)

Regression Calculations (REG)

Use the **MODE** key to enter the REG Mode when you want to perform statistical calculations using regression.

MODE **MODE** **2** (REG) Lin Log Exp →
1 2 3

- In the SD Mode and REG Mode, the **M+** key operates as the **DT** key.
- Entering the REG Mode displays screens like the ones shown below.

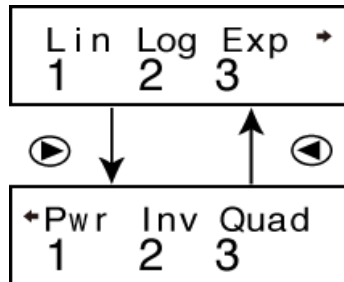

- Press the number key (**1**, **2**, or **3**) that corresponds to the type of regression you want to use.
 - 1** (Lin) : Linear regression
 - 2** (Log) : Logarithmic regression
 - 3** (Exp) : Exponential regression
 - ▶ 1** (Pwr) : Power regression
 - ▶ 2** (Inv) : Inverse regression
 - ▶ 3** (Quad) : Quadratic regression
- Always start data input with **SHIFT** **MODE** (CLR) **1** (ScI) **≡** to clear statistical memory.
- Input data using the key sequence shown below.

$\langle x \text{-data} \rangle$ **▣** $\langle y \text{-data} \rangle$ **DT**
- The values produced by a regression calculation depend on the values input, and results can be recalled using the key operations shown in the table below.

To recall this type of value:	Perform this key operation:
Σx^2	SHIFT 1 (S-SUM) 1 (Σx^2)
Σx	SHIFT 1 (S-SUM) 2 (Σx)
n	SHIFT 1 (S-SUM) 3 (n)
Σy^2	SHIFT 1 (S-SUM) ▶ 1 (Σy^2)
Σy	SHIFT 1 (S-SUM) ▶ 2 (Σy)

To recall this type of value:	Perform this key operation:
Σxy	SHIFT 1 (S-SUM) ► 3 (Σxy)
\bar{x}	SHIFT 2 (S-VAR) 1 (\bar{x})
σ_x	SHIFT 2 (S-VAR) 2 (σ_x)
s_x	SHIFT 2 (S-VAR) 3 (s_x)
\bar{y}	SHIFT 2 (S-VAR) ► 1 (\bar{y})
σ_y	SHIFT 2 (S-VAR) ► 2 (σ_y)
s_y	SHIFT 2 (S-VAR) ► 3 (s_y)
Regression coefficient A	SHIFT 2 (S-VAR) ► ► 1 (A)
Regression coefficient B	SHIFT 2 (S-VAR) ► ► 2 (B)
Regression calculation other than quadratic regression	
Correlation coefficient r	SHIFT 2 (S-VAR) ► ► 3 (r)
\hat{x}	SHIFT 2 (S-VAR) ► ► ► 1 (\hat{x})
\hat{y}	SHIFT 2 (S-VAR) ► ► ► 2 (\hat{y})

- The following table shows the key operations you should use to recall results in the case of quadratic regression.

To recall this type of value:	Perform this key operation:
Σx^3	SHIFT 1 (S-SUM) ► ► 1 (Σx^3)
Σx^2y	SHIFT 1 (S-SUM) ► ► 2 (Σx^2y)
Σx^4	SHIFT 1 (S-SUM) ► ► 3 (Σx^4)
Regression coefficient C	SHIFT 2 (S-VAR) ► ► 3 (C)
\hat{x}_1	SHIFT 2 (S-VAR) ► ► ► 1 (\hat{x}_1)
\hat{x}_2	SHIFT 2 (S-VAR) ► ► ► 2 (\hat{x}_2)
\hat{y}	SHIFT 2 (S-VAR) ► ► ► 3 (\hat{y})

- The values in the above tables can be used inside of expressions the same way you use variables.

Linear Regression

- The regression formula for linear regression is: $y = A + Bx$.

Example: Atmospheric Pressure vs. Temperature

Perform linear regression to determine the regression formula terms and correlation coefficient for the data below.

Temperature	Atmospheric Pressure
10°C	1003 hPa
15°C	1005 hPa
20°C	1010 hPa
25°C	1011 hPa
30°C	1014 hPa

Next, use the regression formula to estimate atmospheric pressure at -5°C and temperature at 1000 hPa. Finally, calculate the coefficient of determination (r^2) and sample covariance ($\frac{\sum xy - n \cdot \bar{x} \cdot \bar{y}}{n - 1}$).

In the REG Mode:

1 (Lin)

SHIFT **MODE** (CLR) **1** (ScI) **≡** (Stat clear)

10 **,** 1003 **DT**

n=	REG
	1.

Each time you press **DT** to register your input, the number of data input up to that point is indicated on the display (n value).

15 **,** 1005 **DT** 20 **,** 1010 **DT** 25 **,** 1011 **DT** 30 **,** 1014 **DT**

Regression Coefficient A = 997.4

SHIFT **2** (S-VAR) **▶▶** **1** (A) **≡**

997.4

Regression Coefficient B = 0.56

SHIFT **2** (S-VAR) **▶▶** **2** (B) **≡**

0.56

Correlation Coefficient r = 0.982607368

SHIFT **2** (S-VAR) **▶▶** **3** (r) **≡**

0.982607368

Atmospheric Pressure at 5°C = 994.6

((←) 5) (SHIFT) 2 (S-VAR) (▶) (▶) (▶) 2 (y') (≡) 994.6

Temperature at 1000 hPa = 4.642857143

1000 (SHIFT) 2 (S-VAR) (▶) (▶) (▶) 1 (x') (≡) 4.642857143

Coefficient of Determination = 0.965517241

(SHIFT) 2 (S-VAR) (▶) (▶) 3 (r) (x²) (≡) 0.965517241

Sample Covariance = 35

((SHIFT) 1 (S-SUM) (▶) 3 (Σxy) (−)
 (SHIFT) 1 (S-SUM) 3 (n) (×)
 (SHIFT) 2 (S-VAR) 1 (x̄) (×)
 (SHIFT) 2 (S-VAR) (▶) 1 (ȳ) () (÷)
 ((SHIFT) 1 (S-SUM) 3 (n) (−) 1 () (≡) 35.

Logarithmic, Exponential, Power, and Inverse Regression

- Use the same key operations as linear regression to recall results for these types of regression.
- The following shows the regression formulas for each type of regression.

Logarithmic Regression	$y = A + B \cdot \ln x$
Exponential Regression	$y = A \cdot e^{B \cdot x}$ ($\ln y = \ln A + Bx$)
Power Regression	$y = A \cdot x^B$ ($\ln y = \ln A + B \ln x$)
Inverse Regression	$y = A + B \cdot 1/x$

Quadratic Regression

- The regression formula for quadratic regression is: $y = A + Bx + Cx^2$.

Example:

Perform quadratic regression to determine the regression formula terms for the data below.

x_i	y_i
29	1.6

50	23.5
74	38.0
103	46.4
118	48.0

Next, use the regression formula to estimate the values for \hat{y} (estimated value of y) for $x_i = 16$ and \hat{x} (estimated value of x) for $y_i = 20$.

In the REG Mode:

\blacktriangleright $\boxed{3}$ (Quad)

$\boxed{\text{SHIFT}} \boxed{\text{MODE}} \boxed{\text{CLR}} \boxed{1} \boxed{\text{Sci}} \boxed{\text{=}} \boxed{\text{Stat clear}}$

29 $\boxed{,}$ 1 $\boxed{\cdot}$ 6 $\boxed{\text{DT}}$ 50 $\boxed{,}$ 23 $\boxed{\cdot}$ 5 $\boxed{\text{DT}}$ 74 $\boxed{,}$ 38 $\boxed{\cdot}$ 0 $\boxed{\text{DT}}$ 103 $\boxed{,}$ 46 $\boxed{\cdot}$ 4 $\boxed{\text{DT}}$ 118
 $\boxed{,}$ 48 $\boxed{\cdot}$ 0 $\boxed{\text{DT}}$

Regression Coefficient A = -35.59856934

$\boxed{\text{SHIFT}} \boxed{2} \boxed{\text{(S-VAR)}} \blacktriangleright \blacktriangleright \boxed{1} \boxed{\text{(A)}} \boxed{\text{=}}$ -35.59856934

Regression Coefficient B = 1.495939413

$\boxed{\text{SHIFT}} \boxed{2} \boxed{\text{(S-VAR)}} \blacktriangleright \blacktriangleright \boxed{2} \boxed{\text{(B)}} \boxed{\text{=}}$ 1.495939413

Regression Coefficient C = $-6.71629667 \times 10^{-3}$

$\boxed{\text{SHIFT}} \boxed{2} \boxed{\text{(S-VAR)}} \blacktriangleright \blacktriangleright \boxed{3} \boxed{\text{(C)}} \boxed{\text{=}}$ $-6.71629667 \times 10^{-3}$

\hat{y} when x_i is 16 = -13.38291067

16 $\boxed{\text{SHIFT}} \boxed{2} \boxed{\text{(S-VAR)}} \blacktriangleright \blacktriangleright \blacktriangleright \boxed{3} \boxed{\text{(\hat{y})}} \boxed{\text{=}}$ -13.38291067

\hat{x}_1 when y_i is 20 = 47.14556728

20 $\boxed{\text{SHIFT}} \boxed{2} \boxed{\text{(S-VAR)}} \blacktriangleright \blacktriangleright \blacktriangleright \boxed{1} \boxed{\text{(\hat{x}_1)}} \boxed{\text{=}}$ 47.14556728

\hat{x}_2 when y_i is 20 = 175.5872105

20 $\boxed{\text{SHIFT}} \boxed{2} \boxed{\text{(S-VAR)}} \blacktriangleright \blacktriangleright \blacktriangleright \boxed{2} \boxed{\text{(\hat{x}_2)}} \boxed{\text{=}}$ 175.5872105

Data Input Precautions

- $\boxed{\text{DT}} \boxed{\text{DT}}$ inputs the same data twice.
- You can also input multiple entries of the same data using $\boxed{\text{SHIFT}} \boxed{,}$ (;). To input the data "20 and 30" five times, for example, press 20 $\boxed{,}$ 30 $\boxed{\text{SHIFT}} \boxed{,}$ (;) 5 $\boxed{\text{DT}}$.
- The above results can be obtained in any order, and not necessarily that shown above.

- Precautions when editing data input for standard deviation also apply for regression calculations.
- Do not use variables A through F, X, or Y to store data when performing statistical calculations. These variables are used for statistical calculation temporary memory, so any data you may have assigned to them may be replaced by other values during statistical calculations.
- Entering the REG Mode and selecting a regression type (Lin, Log, Exp, Pwr, Inv, Quad) clear variables A through F, X, and Y. Changing from one regression type to another inside the REG Mode also clears these variables.

Normal Distribution (SD)

Use the **MODE** key to enter the SD Mode when you want to perform a calculation involving normal distribution.



- In the SD Mode and REG Mode, the **M+** key operates as the **DT** key.
- Press **SHIFT 3** (DISTR), which produces the screen shown below.

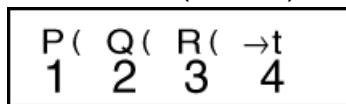

Input a value from **1** to **4** to select the probability distribution calculation you want to perform.

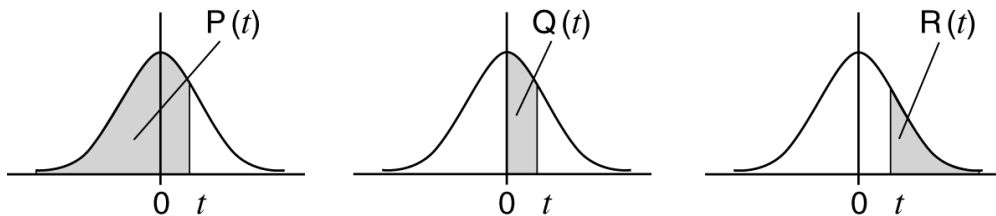

$$x \blacktriangleright t = \frac{x - \bar{x}}{\sigma_x}$$

Example: To determine the normalized variate ($\blacktriangleright t$) for $x = 53$ and normal probability distribution $P(t)$ for the following data: 55, 54, 51, 55, 53, 53, 54, 52

($\blacktriangleright t = -0.284747398$, $P(t) = 0.38974$)

In the SD Mode:

SHIFT MODE (CLR) **1** (Scl) **≡** (Stat clear)

55 **DT** 54 **DT** 51 **DT** 55 **DT** 53 **DT** **DT** 54 **DT** 52 **DT**

53 **SHIFT 3** (DISTR) **4** ($\blacktriangleright t$) **≡** -0.284747398

Base-*n* Calculations (BASE)

Use the **MODE** key to enter the BASE Mode when you want to perform calculations using Base-*n* values.

MODE **MODE** 3 (BASE) — 0. ^d

The initial default number mode when you enter the BASE Mode is decimal, which means input and calculation results use the decimal number format. Press one of the following keys to switch number modes: **x²** (DEC) for decimal, **∧** (HEX) for hexadecimal, **log** (BIN) for binary, or **In** (OCT) for octal.

Example: To enter the BASE Mode, switch to the binary mode, and calculate $11_2 + 1_2$

log (BIN) 0. ^b

11 **+** 1 **=** 100. ^b

Note

- Use the following keys to input the letters A through F for hexadecimal values: **(←)** (A), **''''** (B), **hyp** (C), **sin** (D), **cos** (E), **tan** (F).
- In addition to decimal values, calculations can be performed using binary, octal and hexadecimal values.
- You can specify the default number system to be applied to all input and displayed values, and the number system for individual values as you input them.
- You cannot use scientific functions in binary, octal, decimal, and hexadecimal calculations. You cannot input values that include decimal part and an exponent.
- If you input a value that includes a decimal part, the unit automatically cuts off the decimal part.
- Negative binary, octal, and hexadecimal values are produced by taking the two's complement.
- You can use the following logical operators between values in Base-*n* calculations: and (logical product), or (logical sum), xor (exclusive or), xnor (exclusive nor), Not (bitwise complement), and Neg (negation).
- The following are the allowable ranges for each of the available number systems.

Base- <i>n</i> Mode	Input/Output Ranges
Binary	Positive: $0 \leq x \leq 011111111$ Negative: $100000000 \leq x \leq 111111111$
Octal	Positive: $0 \leq x \leq 377777777$ Negative: $400000000 \leq x \leq 777777777$

Base- <i>n</i> Mode	Input/Output Ranges
Decimal	$-2147483648 \leq x \leq 2147483647$
Hexadecimal	Positive: $0 \leq x \leq 7FFFFFFF$ Negative: $80000000 \leq x \leq FFFFFFFF$

Specifying the Number Mode of a Particular Input Value

You can input a special command immediately following a value to specify the number mode of that value. The special commands are: d (decimal), h (hexadecimal), b (binary), and o (octal).

Example: To calculate $10_{10} + 10_{16} + 10_2 + 10_8$ and display the result as a decimal value

\boxed{AC} $\boxed{x^2}$ (DEC) $\boxed{x^1}$ (LOGIC) $\boxed{x^1}$ (LOGIC) $\boxed{x^1}$ (LOGIC) $\boxed{1}$ (d) 10 $\boxed{+}$
 $\boxed{x^1}$ (LOGIC) $\boxed{x^1}$ (LOGIC) $\boxed{x^1}$ (LOGIC) $\boxed{2}$ (h) 10 $\boxed{+}$
 $\boxed{x^1}$ (LOGIC) $\boxed{x^1}$ (LOGIC) $\boxed{x^1}$ (LOGIC) $\boxed{3}$ (b) 10 $\boxed{+}$
 $\boxed{x^1}$ (LOGIC) $\boxed{x^1}$ (LOGIC) $\boxed{x^1}$ (LOGIC) $\boxed{4}$ (o) 10 $\boxed{=}$

36

Converting a Calculation Result to another Type of Value

You can use any one of the following key operations to convert the currently displayed calculation result to another type of value: $\boxed{x^2}$ (DEC) (decimal), $\boxed{\wedge}$ (HEX) (hexadecimal), $\boxed{\log}$ (BIN) (binary), $\boxed{\ln}$ (OCT) (octal).

Example: To calculate $15_{10} \times 3_{10}$ in the decimal mode, and then convert the result to hexadecimal, binary, and octal

\boxed{AC} $\boxed{x^2}$ (DEC) 15 $\boxed{\times}$ 3 $\boxed{=}$ 45
 $\boxed{\wedge}$ (HEX) 2d
 $\boxed{\log}$ (BIN) 101101
 $\boxed{\ln}$ (OCT) 55

Note

- You may not be able to convert a value from a number system whose calculation range is greater than the calculation range of the resulting number system.
- The message "Math ERROR" indicates that the result has too many digits (overflow).

Base-*n* Calculation Examples

Example 1: To calculate $10111_2 + 11010_2$ in binary (110001_2)

AC **log** (BIN) 10111 **+** 11010 **=** 110001

Example 2: To calculate $7_8 + 1_8$ in octal (10_8)

AC **In** (OCT) 7 **+** 1 **=** 10

Example 3: To calculate $1F_{16} + 1_{16}$ in hexadecimal (20_{16})

AC **^** (HEX) 1 **tan** (F) **+** 1 **=** 20

Example 4: To convert the decimal value 30_{10} to binary, octal, and hexadecimal

AC **x²** (DEC) 30 **=** 30

log (BIN) 11110

In (OCT) 36

^ (HEX) 1E

Example 5: To transform the result of $5_{10} + 5_{16}$ to binary

AC **log** (BIN) **x¹** (LOGIC) **x¹** (LOGIC) **x¹**
(LOGIC) **1** (d) 5 **+**

x¹ (LOGIC) **x¹** (LOGIC) **x¹** (LOGIC) **2** (h) 5 **=** 1010

Logical and Negation Operations

Your calculator provides you with logical operators (And, Or, Xor, Xnor) and functions (Not, Neg) for logical and negation operations on binary values. Use the menu that appears when you press **x¹** (LOGIC) to input these logical operators and functions.

Note

- In the case of a negative binary, octal or hexadecimal value, the calculator converts the value to binary, takes the two's complement, and then converts back to the original number base. For decimal values, the calculator merely adds a minus sign.

Examples

All of the examples below are performed in the binary mode.

Example 1: To determine the logical AND of 1010_2 and 1100_2 (1010_2 and 1100_2)

AC 1010 **x¹**(LOGIC) **1**(And) 1100 **=** 1000

Example 2: To determine the logical OR of 1011_2 and 11010_2 (1011_2 or 11010_2)

AC 1011 **x¹**(LOGIC) **2**(Or) 11010 **=** 11011

Example 3: To determine the logical XOR of 1010_2 and 1100_2 (1010_2 xor 1100_2)

AC 1010 **x¹**(LOGIC) **x¹**(LOGIC) **1**(Xor) 1100 **=** 110

Example 4: To determine the logical XNOR of 1111_2 and 101_2 (1111_2 xnor 101_2)

AC 1111 **x¹**(LOGIC) **3**(Xnor) 101 **=** 111110101

Example 5: To determine the bitwise complement of 1010_2 (Not(1010_2))

AC **x¹**(LOGIC) **x¹**(LOGIC) **2**(Not) 1010 **=** 111110101

Example 6: To negate (take the two's complement) of 101101_2 (Neg(101101_2))

AC **x¹**(LOGIC) **x¹**(LOGIC) **3**(Neg) 101101 **=** 1111010011

Equation Calculations (EQN)

The EQN Mode lets you solve equations up to three degrees and simultaneous linear equations with up to three unknowns.

Use the **MODE** key to enter the EQN Mode when you want to solve an equation.

MODE **MODE** **MODE** **1**(EQN)

Unknowns? **+**
2 3

Quadratic and Cubic Equations

Quadratic Equation: $ax^2 + bx + c = 0$

Cubic Equation: $ax^3 + bx^2 + cx + d = 0$

Entering the EQN Mode and pressing **▶** displays the initial quadratic/cubic equation screen.

← Degree?
2 3

Use this screen to specify 2 (quadratic) or 3 (cubic) as the degree of the equation, and input values for each of the coefficients.

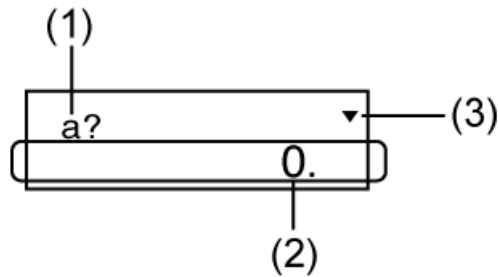

(1) Coefficient name

(2) Element value

(3) Arrow indicates direction you should scroll to view other elements.

- Any time until you input a value for the final coefficient (c for a quadratic equation, d for a cubic equation), you can use the \blacktriangle and \blacktriangledown keys to move between coefficients on the screen and make changes, if you want.
- Note that you cannot input complex numbers for coefficients.

Calculation starts and one of the solutions appears as soon as you input a value for the final coefficient.

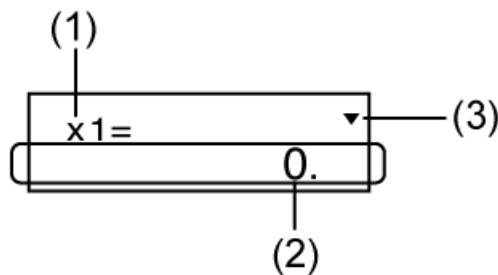

(1) Variable name

(2) Solution

(3) Arrow indicates direction you should scroll to view other solutions.

- Press the \blacktriangledown key to view other solutions. Use \blacktriangle and \blacktriangledown to scroll between all of the solutions for the equation.
- Pressing the $\boxed{\text{AC}}$ key at this point returns to the coefficient input screen.
- Certain coefficients can cause calculation to take more time.

Example 1: To solve the equation

$$x^3 - 2x^2 - x + 2 = 0 \quad (x = 2, -1, 1)$$

(Degree?)	3
(a ?)	1 $\boxed{=}$
(b ?)	$\boxed{(-)}$ 2 $\boxed{=}$
(c ?)	$\boxed{(-)}$ 1 $\boxed{=}$
(d ?)	2 $\boxed{=}$
($x1 =$)	\blacktriangledown

$$(x_2 = -1)$$



$$(x_3 = 1)$$

- If a result is a complex number, the real part of the first solution appears first. This is indicated by the "R↔I" symbol on the display. Press **SHIFT** **⇄** (Re↔Im) to toggle the display between the real part and imaginary part of a solution.

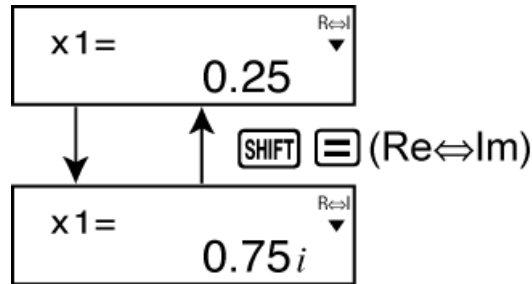

Example 2: To solve the equation

$$8x^2 - 4x + 5 = 0 \quad (x = 0.25 \pm 0.75i)$$

(Degree?)

2

(a?)

8 **⇄**

(b?)

(-)4 **⇄**

(c?)

5 **⇄**

(x1 = 0.25 + 0.75i)



(x2 = 0.25 - 0.75i)

Simultaneous Equations

Simultaneous Linear Equations with Two Unknowns:

$$a_1x + b_1y = c_1$$

$$a_2x + b_2y = c_2$$

Simultaneous Linear Equations with Three Unknowns:

$$a_1x + b_1y + c_1z = d_1$$

$$a_2x + b_2y + c_2z = d_2$$

$$a_3x + b_3y + c_3z = d_3$$

Entering the EQN Mode displays the initial simultaneous equation screen.

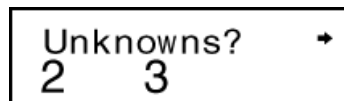

Use this screen to specify 2 or 3 as the number of unknowns, and input values for each of the coefficients.

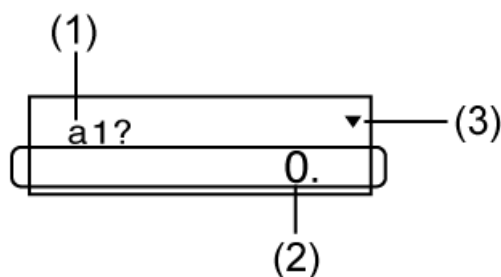

- (1) Coefficient name
- (2) Element value
- (3) Arrow indicates direction you should scroll to view other elements.
 - Any time until you input a value for the final coefficient (c_2 for two unknowns, d_3 for three unknowns), you can use the \blacktriangle and \blacktriangledown keys to move between coefficients on the screen and make changes, if you want.
 - Note that you cannot input complex numbers for coefficients.

Calculation starts and one of the solutions appears as soon as you input a value for the final coefficient.

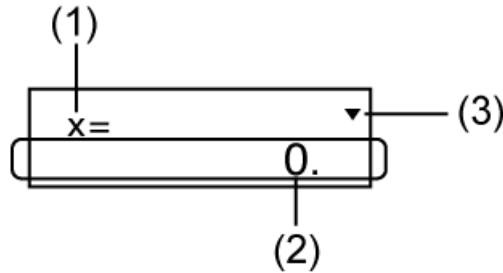

- (1) Variable name
- (2) Solution
- (3) Arrow indicates direction you should scroll to view other solutions.
 - Press the \blacktriangledown key to view other solutions. Use \blacktriangle and \blacktriangledown to scroll between all of the solutions for the equation.
 - Pressing the $\boxed{\text{AC}}$ key at this point returns to the coefficient input screen.

Example: To solve the following simultaneous equations

$$2x + 3y - z = 15$$

$$3x - 2y + 2z = 4$$

$$5x + 3y - 4z = 9 \quad (x = 2, y = 5, z = 4)$$

(Unknowns?)	3
($a_1?$) ($d_1?$)	2 $\boxed{=}$ 3 $\boxed{=}$ $\boxed{(-)}$ 1 $\boxed{=}$ 15 $\boxed{=}$
($a_2?$) ($d_2?$)	3 $\boxed{=}$ $\boxed{(-)}$ 2 $\boxed{=}$ 2 $\boxed{=}$ 4 $\boxed{=}$
($a_3?$) ($d_3?$)	5 $\boxed{=}$ 3 $\boxed{=}$ $\boxed{(-)}$ 4 $\boxed{=}$ 9 $\boxed{=}$
($x = 2$)	\blacktriangledown
($y = 5$)	\blacktriangledown
($z = 4$)	

Matrix Calculations (MAT) (fx-570MS/ fx-991MS only)

Use the **MODE** key to enter the MAT Mode when you want to perform matrix calculations.

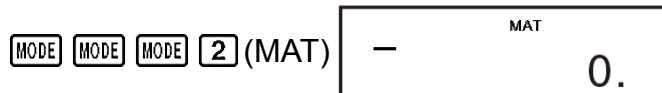

Use the MAT Mode to perform calculations involving matrices of up to 3 rows by 3 columns. To perform a matrix calculation, you first assign data to special matrix variables (MatA, MatB, MatC), and then use the variables in the calculation as shown in the example below.

Note

- Matrix calculations can use up to two levels of the matrix stack. Squaring a matrix, cubing a matrix, or inverting a matrix uses one stack level. See "Stacks" for more information.

Example 1: To assign $\begin{bmatrix} 2 & 1 \\ 1 & 1 \end{bmatrix}$ to MatA and $\begin{bmatrix} 2 & -1 \\ -1 & 2 \end{bmatrix}$ to MatB, and then perform the following calculations: $\begin{bmatrix} 2 & 1 \\ 1 & 1 \end{bmatrix} \times \begin{bmatrix} 2 & -1 \\ -1 & 2 \end{bmatrix}$ (MatA \times MatB), $\begin{bmatrix} 2 & 1 \\ 1 & 1 \end{bmatrix} + \begin{bmatrix} 2 & -1 \\ -1 & 2 \end{bmatrix}$ (MatA + MatB)

- Press **SHIFT** **4** (MAT) **1** (Dim) **1** (A).

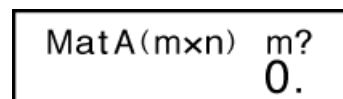

- Input the dimensions of MatA: **2** **2**.

- This will display the Matrix Editor for input of the elements of the 2×2 matrix you specified for MatA.

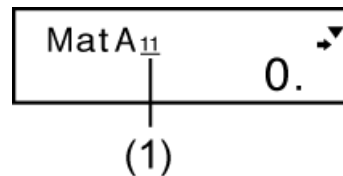

(1) Shows the row number and column number of the element.
(Example: MatA₂₃ indicates row 2, column 3 of MatA.)

- Input the elements of MatA: **2** **1** **1** **1**.

- Perform the following key operation: **SHIFT** **4** (MAT) **1** (Dim) **2** (B) **2** **2**.

- This will display the Matrix Editor for input of the elements of the 2×2 matrix you specified for MatB.

- Input the elements of MatB: **2** **1** **1** **2**.

6. Press $\boxed{\text{AC}}$ to advance to the calculation screen, and perform the first calculation (MatA \times MatB):

$\boxed{\text{SHIFT}} \boxed{4} \boxed{(\text{MAT})} \boxed{3} \boxed{(\text{Mat})} \boxed{1} \boxed{(\text{A})} \boxed{\times} \boxed{\text{SHIFT}} \boxed{4} \boxed{(\text{MAT})} \boxed{3} \boxed{(\text{Mat})} \boxed{2} \boxed{(\text{B})} \boxed{=}$.

- This will display the MatAns screen with the calculation results.

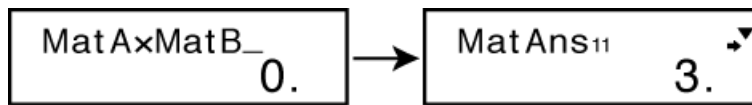

Note: "MatAns" stands for "Matrix Answer Memory".

7. Perform the next calculation (MatA + MatB): $\boxed{\text{AC}} \boxed{\text{SHIFT}} \boxed{4} \boxed{(\text{MAT})} \boxed{3} \boxed{(\text{Mat})}$

$\boxed{1} \boxed{(\text{A})} \boxed{+} \boxed{\text{SHIFT}} \boxed{4} \boxed{(\text{MAT})} \boxed{3} \boxed{(\text{Mat})} \boxed{2} \boxed{(\text{B})} \boxed{=}$.



Matrix Answer Memory

Whenever the result of a calculation executed in the MAT Mode is a matrix, the MatAns screen will appear with the result. The result also will be assigned to a variable named "MatAns".

The MatAns variable can be used in calculations as described below.

- To insert the MatAns variable into a calculation, perform the following key operation: $\boxed{\text{SHIFT}} \boxed{4} \boxed{(\text{MAT})} \boxed{3} \boxed{(\text{Mat})} \boxed{4} \boxed{(\text{Ans})}$.
- Pressing any one of the following keys while the MatAns screen is displayed will switch automatically to the calculation screen: $\boxed{+}$, $\boxed{-}$, $\boxed{\times}$, $\boxed{\div}$, $\boxed{x^1}$, $\boxed{x^2}$, $\boxed{\text{SHIFT}} \boxed{x^2}$ (x^3). The calculation screen will show the MatAns variable followed by the operator or function for the key you pressed.

Assigning and Editing Matrix Variable Data

Important: The following operations are not supported by the Matrix Editor: $\boxed{\text{M+}}$, $\boxed{\text{SHIFT}} \boxed{\text{M+}}$ (M-), $\boxed{\text{SHIFT}} \boxed{\text{RCL}}$ (STO). Pol, Rec, and multi-statements also cannot be input with the Matrix Editor.

To assign new data to a matrix variable:

1. Press $\boxed{\text{SHIFT}} \boxed{4} \boxed{(\text{MAT})} \boxed{1} \boxed{(\text{Dim})}$, and then, on the menu that appears, select the matrix variable to which you want to assign data.
2. On the next menu that appears, input the dimensions.
3. Use the Matrix Editor that appears to input the elements of the matrix.

Example 2: To assign $\begin{bmatrix} 1 & 0 & -1 \\ 0 & -1 & 1 \end{bmatrix}$ to MatC

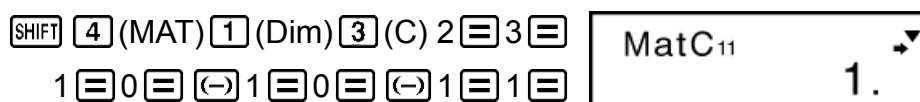

To edit the elements of a matrix variable:

1. Press SHIFT $\boxed{4}$ (MAT) $\boxed{2}$ (Edit), and then, on the menu that appears, select the matrix variable you want to edit.
2. Use the Matrix Editor that appears to edit the elements of the matrix.
 - Use the \blacktriangle , \blacktriangledown , \blacktriangleleft , and \blacktriangleright keys to display the element you want to edit. Input a new value and then press = .

Matrix Calculation Examples

The following examples use $\text{MatA} = \begin{bmatrix} 2 & 1 \\ 1 & 1 \end{bmatrix}$ and $\text{MatB} = \begin{bmatrix} 2 & -1 \\ -1 & 2 \end{bmatrix}$ from Example 1, and $\text{MatC} = \begin{bmatrix} 1 & 0 & -1 \\ 0 & -1 & 1 \end{bmatrix}$ from Example 2. You can input a matrix variable into a key operation by pressing SHIFT $\boxed{4}$ (MAT) $\boxed{3}$ (Mat) and then pressing one of the following number keys: $\boxed{1}$ (A), $\boxed{2}$ (B), $\boxed{3}$ (C).

Example 3: $3 \times \text{MatA}$ (Matrix scalar multiplication). (Result: $\begin{bmatrix} 6 & 3 \\ 3 & 3 \end{bmatrix}$)

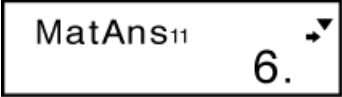
$$\text{AC} \boxed{3} \times \text{MatA} \text{=}$$

Example 4: Obtain the determinant of MatA (Det(MatA)).

$$\text{AC} \text{SHIFT} \boxed{4} \text{(MAT)} \blacktriangleright \boxed{1} \text{(Det)} \text{MatA} \text{=}$$
 1.

Example 5: Obtain the transposition of MatC (Trn(MatC)). (Result:

$$\begin{bmatrix} 1 & 0 \\ 0 & -1 \\ -1 & 1 \end{bmatrix}$$

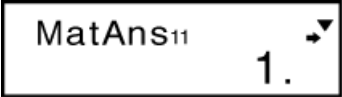
$$\text{AC} \text{SHIFT} \boxed{4} \text{(MAT)} \blacktriangleright \boxed{2} \text{(Trn)} \text{MatC} \text{=}$$

Example 6: Obtain the inverse matrix of MatA (MatA^{-1}). (Result:

$$\begin{bmatrix} 1 & -1 \\ -1 & 2 \end{bmatrix}$$

Note: You cannot use ^ for this input. Use the x^{-1} key to input " -1 ".

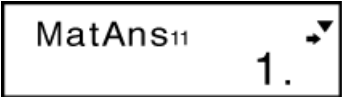
$$\text{AC} \text{MatA} \text{x}^{-1} \text{=}$$

Example 7: Obtain the absolute value of each element of MatB

(Abs(MatB)). (Result: $\begin{bmatrix} 2 & 1 \\ 1 & 2 \end{bmatrix}$)

$$\text{AC} \text{SHIFT} \boxed{)} \text{(Abs)} \text{MatB} \text{=}$$

Example 8: Determine the square and cube of MatA (MatA^2 , MatA^3).

(Result: $\text{MatA}^2 = \begin{bmatrix} 5 & 3 \\ 3 & 2 \end{bmatrix}$, $\text{MatA}^3 = \begin{bmatrix} 13 & 8 \\ 8 & 5 \end{bmatrix}$)

Note: You cannot use \square for this input. Use \square to specify squaring, and $\square \square$ (x^3) to specify cubing.

\square **MatA** \square \square MatAns11 5.

\square **MatA** \square \square (x^3) \square MatAns11 13.

Vector Calculations (VCT) (fx-570MS/ fx-991MS only)

Use the \square key to enter the VCT Mode when you want to perform vector calculations.

\square \square \square \square (VCT) - ^{VCT} 0.

Use the VCT Mode to perform 2-dimensional and 3-dimensional vector calculations. To perform a vector calculation, you first assign data to special vector variables (VctA, VctB, VctC), and then use the variables in the calculation as shown in the example below.

Example 1: To assign (1, 2) to VctA and (3, 4) to VctB, and then perform the following calculation: $(1, 2) + (3, 4)$

1. Press \square \square (VCT) \square (Dim) \square (A).

VctA(m) m?
0.

2. Input the dimensions of VctA: \square .

- This will display the Vector Editor for input of the 2-dimensional vector for VctA.

VctA1 0.

(1) (2)

(1) Dimensions of vector

(2) Arrow indicates direction you should scroll to view other elements.

3. Input the elements of VctA: \square \square .

- Perform the following key operation: $\boxed{\text{SHIFT}} \boxed{5} (\text{VCT}) \boxed{1} (\text{Dim}) \boxed{2} (\text{B}) \boxed{2} \boxed{=}$.
 - This will display the Vector Editor for input of the 2-dimensional vector for VctB.
- Input the elements of VctB: $3 \boxed{=}$ $4 \boxed{=}$.
- Press $\boxed{\text{AC}}$ to advance to the calculation screen, and perform the calculation (VctA + VctB): $\boxed{\text{SHIFT}} \boxed{5} (\text{VCT}) \boxed{3} (\text{Vct}) \boxed{1} (\text{A}) \boxed{+} \boxed{\text{SHIFT}} \boxed{5} (\text{VCT}) \boxed{3} (\text{Vct}) \boxed{2} (\text{B}) \boxed{=}$.
 - This will display the VctAns screen with the calculation results.

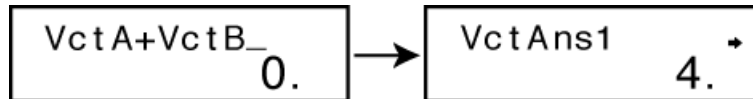

Note: "VctAns" stands for "Vector Answer Memory". See "Vector Answer Memory" for more information.

Vector Answer Memory

Whenever the result of a calculation executed in the VCT Mode is a vector, the VctAns screen will appear with the result. The result also will be assigned to a variable named "VctAns".

The VctAns variable can be used in calculations as described below.

- To insert the VctAns variable into a calculation, perform the following key operation: $\boxed{\text{SHIFT}} \boxed{5} (\text{VCT}) \boxed{3} (\text{Vct}) \boxed{4} (\text{Ans})$.
- Pressing any one of the following keys while the VctAns screen is displayed will switch automatically to the calculation screen: $\boxed{+}$, $\boxed{-}$, $\boxed{\times}$, $\boxed{\div}$. The calculation screen will show the VctAns variable followed by the operator for the key you pressed.

Assigning and Editing Vector Variable Data

Important: The following operations are not supported by the Vector Editor: $\boxed{\text{M+}}$, $\boxed{\text{SHIFT}} \boxed{\text{M+}} (\text{M-})$, $\boxed{\text{SHIFT}} \boxed{\text{RCL}} (\text{STO})$. Pol, Rec, and multi-statements also cannot be input with the Vector Editor.

To assign new data to a vector variable:

- Press $\boxed{\text{SHIFT}} \boxed{5} (\text{VCT}) \boxed{1} (\text{Dim})$, and then, on the menu that appears, select the vector variable to which you want to assign data.
- On the next menu that appears, input the dimensions.
- Use the Vector Editor that appears to input the elements of the vector.

Example 2: To assign (2, -1, 2) to VctC

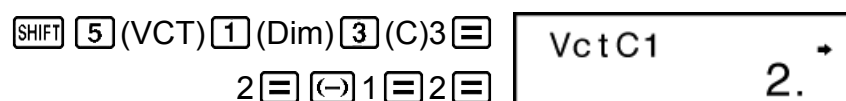

To edit the elements of a vector variable:

1. Press SHIFT 5 (VCT) 2 (Edit), and then, on the menu that appears, select the vector variable you want to edit.
2. Use the Vector Editor that appears to edit the elements of the vector.
 - Use the ◀ and ▶ keys to display the element you want to edit.
Input a new value and then press = .

Vector Calculation Examples

The following examples use $\text{VctA} = (1, 2)$ and $\text{VctB} = (3, 4)$ from Example 1, and $\text{VctC} = (2, -1, 2)$ from Example 2. You can input a vector variable into a key operation by pressing SHIFT 5 (VCT) 3 (Vct) and then pressing one of the following number keys: 1 (A), 2 (B), 3 (C).

Example 3: $3 \times \text{VctA} = (3, 6)$ (Vector scalar multiplication), $3 \times \text{VctA} - \text{VctB} = (0, 2)$ (Calculation example using VctAns)

$$\text{AC } 3 \times \text{VctA } = \begin{array}{|l|} \hline \text{VctAns1} \\ \hline 3. \rightarrow \\ \hline \end{array}$$
$$= \text{VctB } = \begin{array}{|l|} \hline \text{VctAns1} \\ \hline 0. \rightarrow \\ \hline \end{array}$$

Example 4: $\text{VctA} \cdot \text{VctB}$ (Vector dot product)

$$\text{AC } \text{VctA } \text{SHIFT } \text{5} \text{ (VCT) } \text{▶ } \text{1} \text{ (Dot) } \text{VctB } = \begin{array}{|l|} \hline \text{VctA} \cdot \text{VctB} \\ \hline 11. \\ \hline \end{array}$$

Example 5: $\text{VctA} \times \text{VctB} = (0, 0, -2)$ (Vector cross product)

$$\text{AC } \text{VctA } \times \text{VctB } = \begin{array}{|l|} \hline \text{VctAns1} \\ \hline 0. \rightarrow \\ \hline \end{array}$$

Example 6: Obtain the absolute values of VctC.

$$\text{AC } \text{SHIFT } \text{)} \text{ (Abs) } \text{VctC } = \begin{array}{|l|} \hline \text{Abs VctC} \\ \hline 3. \\ \hline \end{array}$$

Example 7: Determine the angle formed by VctA and VctB to three decimal places (Fix 3). (Angle unit: Deg) ($\cos \theta = \frac{(\text{A} \cdot \text{B})}{|\text{A}||\text{B}|}$, which becomes $\theta = \cos^{-1} \left(\frac{(\text{A} \cdot \text{B})}{|\text{A}||\text{B}|} \right)$)

MODE 1 (Fix) 3
 AC ((VctA SHIFT 5 (VCT) ► 1 (Dot) VctB
) ÷
 ((SHIFT) (Abs) VctA SHIFT) (Abs) VctB)
 = (VctA·VctB)÷
 0.984
 SHIFT COS (cos⁻¹) Ans =
 cos⁻¹ Ans
 10.305

Technical Information

Errors

The calculator will display an error message whenever an error occurs for any reason during a calculation.

- Press ◀ or ▶ to return to the calculation screen. The cursor will be positioned at the location where the error occurred, ready for input. Make the necessary corrections to the calculation and execute it again.
- Press **AC** to return to the calculation screen. Note that this also clears the calculation that contained the error.

Error Messages

Math ERROR

Cause:

- The intermediate or final result of the calculation you are performing exceeds the allowable calculation range.
- Your input exceeds the allowable input range.
- The calculation you are performing contains an illegal mathematical operation (such as division by zero).

Action:

- Check the input values and reduce the number of digits.
- When using independent memory or a variable as the argument of a function, make sure that the memory or variable value is within the allowable range for the function.

Stack ERROR

Cause:

- The calculation you are performing has caused the capacity of the numeric stack or the command stack to be exceeded.
- The calculation you are performing has caused the capacity of the matrix or vector stack to be exceeded.

Action:

- Simplify the calculation expression.
- Try splitting the calculation into two or more parts.

Syntax ERROR

Cause:

- There is a problem with the format of the calculation you are performing.

Action:

- Make necessary corrections.

Arg ERROR

Cause:

- Improper use of an argument.

Action:

- Make necessary corrections.

Dim ERROR (MAT and VCT Modes only)

Cause:

- The matrix or vector you are trying to use in a calculation was input without specifying its dimension.
- You are trying to perform a calculation with matrices or vectors whose dimensions do not allow that type of calculation.

Action:

- Specify the dimension of the matrix or vector and then perform the calculation again.
- Check the dimensions specified for the matrices or vectors to see if they are compatible with the calculation.

Can't solve Error (SOLVE feature only)

Cause:

- The calculator could not obtain a solution.

Action:

- Check for errors in the equation that you input.
- Input a value for the solution variable that is close to the expected solution and try again.

Before Assuming Malfunction of the Calculator...

Perform the following steps whenever an error occurs during a calculation or when calculation results are not what you expected.

Note that you should make separate copies of important data before performing these steps.

1. Check the calculation expression to make sure that it does not contain any errors.
2. Make sure that you are using the correct mode for the type of calculation you are trying to perform.
3. If the above steps do not correct your problem, press the **ON** key.
4. Initialize all modes and settings by performing the following operation:
ON **SHIFT** **MODE** (CLR) **2** (Mode) **≡**.

Replacing the Battery

The battery needs to be replaced after a specific number of years. Also, replace the battery immediately after display figures become dim. A low battery is indicated by a dim display, even if contrast is adjusted, or by failure of figures to appear on the display immediately after you turn on the calculator. If this happens, replace the battery with a new one.

Important!

- Removing the battery will cause all of the calculator's memory contents to be deleted.

1. Press **SHIFT** **AC** (OFF) to turn off the calculator.
2. On the back of the calculator, remove the screws and the cover.

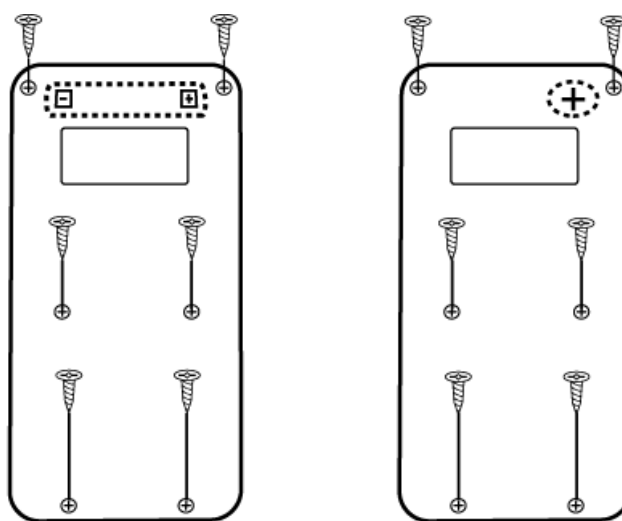

fx-100MS/fx-570MS

fx-991MS

3. Remove the battery, and then load a new battery with its plus (+) and minus (-) ends facing correctly.
4. Replace the cover.
5. Initialize the calculator: **ON** **SHIFT** **MODE** (CLR) **3** (All) **=**.
 - Do not skip the above step!

Calculation Priority Sequence

The calculator performs calculations according to a calculation priority sequence.

When the priority of two expressions is the same, the calculation is performed from left to right.

Stacks

This calculator uses memory areas, called "stacks," to temporarily store values (numeric stack) and commands (command stack) according to their precedence during calculations. The numeric stack has 10 levels and the command stack has 24 levels. A stack error (Stack ERROR) occurs whenever you try to perform a calculation that is so complex that the capacity of a stack is exceeded.

- Matrix calculations use up to two levels of the matrix stack. Squaring a matrix, cubing a matrix, or inverting a matrix uses one stack level. (fx-570MS, fx-991MS only)

Example:

$$2 \times ((3 + 4 \times (5 + 4) \div 3) \div 5) + 8 =$$

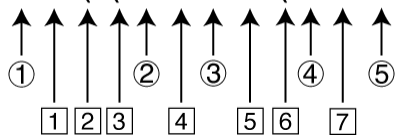

Numeric Stack

①	2
②	3
③	4
④	5
⑤	4
⋮	

Command Stack

[1]	×
[2]	(
[3]	(
[4]	+
[5]	×
[6]	(
[7]	+
⋮	

- Calculations are performed in sequence according to "Calculation Priority Sequence." Commands and values are deleted from the stack as the calculation is performed.

Calculation Ranges, Number of Digits, and Precision

The calculation range, number of digits used for internal calculation, and calculation precision depends on the type of calculation you are performing.

Calculation Range and Precision

Calculation Range	$\pm 1 \times 10^{-99}$ to $\pm 9.999999999 \times 10^{99}$ or 0
Number of Digits for Internal Calculation	15 digits
Precision	In general, ± 1 at the 10th digit for a single calculation. Precision for exponential display is ± 1 at the least significant digit. Errors are cumulative in the case of consecutive calculations.

Function Calculation Input Ranges and Precision

Functions	Input Range	
$\sin x$ $\cos x$	Deg	$0 \leq x < 9 \times 10^9$
	Rad	$0 \leq x < 157079632.7$
	Gra	$0 \leq x < 1 \times 10^{10}$
$\tan x$	Deg	Same as $\sin x$, except when $ x = (2n-1) \times 90$.
	Rad	Same as $\sin x$, except when $ x = (2n-1) \times \pi/2$.
	Gra	Same as $\sin x$, except when $ x = (2n-1) \times 100$.
$\sin^{-1} x, \cos^{-1} x$	$0 \leq x \leq 1$	
$\tan^{-1} x$	$0 \leq x \leq 9.999999999 \times 10^{99}$	

Functions	Input Range
$\sinh x, \cosh x$	$0 \leq x \leq 230.2585092$
$\sinh^{-1} x$	$0 \leq x \leq 4.999999999 \times 10^{99}$
$\cosh^{-1} x$	$1 \leq x \leq 4.999999999 \times 10^{99}$
$\tanh x$	$0 \leq x \leq 9.999999999 \times 10^{99}$
$\tanh^{-1} x$	$0 \leq x \leq 9.999999999 \times 10^{-1}$
$\log x, \ln x$	$0 < x \leq 9.999999999 \times 10^{99}$
10^x	$-9.999999999 \times 10^{99} \leq x \leq 99.99999999$
e^x	$-9.999999999 \times 10^{99} \leq x \leq 230.2585092$
\sqrt{x}	$0 \leq x < 1 \times 10^{100}$
x^2	$ x < 1 \times 10^{50}$
x^{-1}	$ x < 1 \times 10^{100}; x \neq 0$
$\sqrt[3]{x}$	$ x < 1 \times 10^{100}$
$x!$	$0 \leq x \leq 69$ (x is an integer)
nPr	$0 \leq n < 1 \times 10^{10}, 0 \leq r \leq n$ (n, r are integers) $1 \leq \{n!/(n-r)!\} < 1 \times 10^{100}$
nCr	$0 \leq n < 1 \times 10^{10}, 0 \leq r \leq n$ (n, r are integers) $1 \leq n!/r! < 1 \times 10^{100}$ or $1 \leq n!/(n-r)! < 1 \times 10^{100}$
$\text{Pol}(x, y)$	$ x , y \leq 9.999999999 \times 10^{99}$ $\sqrt{x^2 + y^2} \leq 9.999999999 \times 10^{99}$
$\text{Rec}(r, \theta)$	$0 \leq r \leq 9.999999999 \times 10^{99}$ θ : Same as $\sin x$

Functions	Input Range
$a^{\circ} b' c''$ $\circ, ''$	$a^{\circ} b' c''$: $ a , b, c < 1 \times 10^{100}$; $0 \leq b, c$ The display seconds value is subject to an error of ± 1 at the second decimal place.
\leftarrow $\circ, ''$	$ x < 1 \times 10^{100}$ Decimal \leftrightarrow Sexagesimal Conversions $0^{\circ} 0' 0'' \leq x \leq 99999999^{\circ} 59'$
x^y	$x > 0$: $-1 \times 10^{100} < y \log x < 100$ $x = 0$: $y > 0$ $x < 0$: $y = n, \frac{1}{2n+1}$ (n is an integer) However: $-1 \times 10^{100} < y \log x < 100$
$x\sqrt[y]{y}$	$y > 0$: $x \neq 0, -1 \times 10^{100} < 1/x \log y < 100$ $y = 0$: $x > 0$ $y < 0$: $x = 2n+1, \frac{1}{n}$ ($n \neq 0$; n is an integer) However: $-1 \times 10^{100} < 1/x \log y < 100$
$a^{b/c}$	Total of integer, numerator, and denominator must be 10 digits or less (including division marks).

- Precision is basically the same as that described under "Calculation Range and Precision", above.
- Calculations that use any of the functions or settings shown below require consecutive internal calculations to be performed, which can cause accumulation of error that occurs with each calculation.
 $x^y, x\sqrt[y]{y}, \sqrt[3]{y}, x!, nPr, nCr; ^{\circ}, ', ''$ (Angle unit: Rad); σ_x, s_x , regression coefficient.
- Error is cumulative and tends to be large in the vicinity of a function's singular point and inflection point.
- During statistical calculation, error is cumulative when data values have a large number of digits and the differences between data values is small. Error will be large when data values are greater than six digits.

Specifications

fx-100MS/fx-570MS

Power Requirements:

AAA-size battery R03 (UM-4) \times 1

Approximate Battery Life:

Two years (based on one hour of operation per day)

Power Consumption:

0.0001 W

Operating Temperature:

0°C to 40°C (32°F to 104°F)

Dimensions

13.8 (H) × 77 (W) × 161.5 (D) mm

½" (H) × 3" (W) × 6³/₈" (D)

Approximate Weight:

105 g (3.7 oz) including the battery

fx-991MS**Power Requirements:**

Built-in solar cell; button battery LR44 × 1

Approximate Battery Life:

Three years (based on one hour of operation per day)

Operating Temperature:

0°C to 40°C (32°F to 104°F)

Dimensions:

11.1 (H) × 77 (W) × 161.5 (D) mm

¾" (H) × 3" (W) × 6³/₈" (D)

Approximate Weight:

95 g (3.4 oz) including the battery

CASIO®

Free Manuals Download Website

<http://myh66.com>

<http://usermanuals.us>

<http://www.somanuals.com>

<http://www.4manuals.cc>

<http://www.manual-lib.com>

<http://www.404manual.com>

<http://www.luxmanual.com>

<http://aubethermostatmanual.com>

Golf course search by state

<http://golfingnear.com>

Email search by domain

<http://emailbydomain.com>

Auto manuals search

<http://auto.somanuals.com>

TV manuals search

<http://tv.somanuals.com>