

NOVEMBER 2014



Precision 60



SpeakerTrack 60

Camera guide

for Cisco TelePresence Precision 60 and Cisco TelePresence SpeakerTrack 60

Thank you for choosing Cisco!

Your Cisco product has been designed to give you many years of safe, reliable operation.

This guide is supposed to make you comfortable with the Precision 60 and SpeakerTrack 60 cameras.

We recommend to visit the Cisco web site regularly for updated versions of the user documentation.

The user documentation can be found on:

▶ <http://www.cisco.com/go/telepresence/docs>

How to use this guide

The top menu bar and the entries in the Table of contents are all hyperlinks. You can click on them to go to the topic.

Table of Contents

Introduction	3
About this guide.....	4
User documentation	4
Software	4
Physical interface	5
Precision 60.....	6
SpeakerTrack 60.....	7
Connecting to a codec	8
Codec compatibility.....	9
Connect Precision 60 to SX80 Codec	10
Connect SpeakerTrack 60 to SX80 Codec	11
Connect SpeakerTrack 60 to Codec C40	12
Connect SpeakerTrack 60 to Codec C60	13
Connect SpeakerTrack 60 to Codec C90	14
Factory reset	15
Precision 60.....	16
SpeakerTrack 60.....	17
Reset the device.....	17
Reset the cameras.....	18
Appendix	19
Technical specifications.....	20
Precision 60	20
SpeakerTrack 60	21
Contact us	22

CHAPTER 1

Introduction

About this guide

This user guide describes the information needed to install and use the Cisco TelePresence Precision 60 and Cisco TelePresence SpeakerTrack 60 cameras.

User documentation

The user documentation for the Cisco TelePresence systems, running the TC software, have several guides aimed at various user groups.

- Video conference room primer
- Video conference room acoustics guidelines
- Getting started guide for the TelePresence systems
- User guide for the TelePresence systems
- Administrator guides for the TelePresence systems
- API reference guides for the C Series and Codec SX80
- TC Console user guide for the C Series and Codec SX80
- Physical interfaces guides for the C Series and Codec SX80
- Regulatory compliance and safety information guides
- Legal and licensing information for products using TC software

Download the user documentation

Go to: ► <http://www.cisco.com/go/telepresence/docs> and select your product to see the user documentation for your product.

Software

The camera software is automatically upgraded through the codec.

Minimum software version requirement is TC 7.1.

CHAPTER 2

Physical interface

Precision 60

Video

- HDMI is the main video source. The maximum resolution is 1080p60.
- 3G-SDI is the secondary video source. The maximum resolution is 1080p30.
- In multiple camera scenarios, the HDMI output should be used.
- For long cable lengths, HDMI extenders supporting EDID should be used. The extender must not alter the SPA address or any EDID information incorrectly.

Power

- Connect power (12 V_{DC}, 2.5 A).
- Always use the provided cables and adapter.

Ethernet

For camera control and software upgrades.

 Do **NOT** connect a camera control cable to the Ethernet codec port of the device. This will destroy the system.

Kensington lock

The Kensington lock may be used to prevent the camera from being moved from its place or to prevent theft.

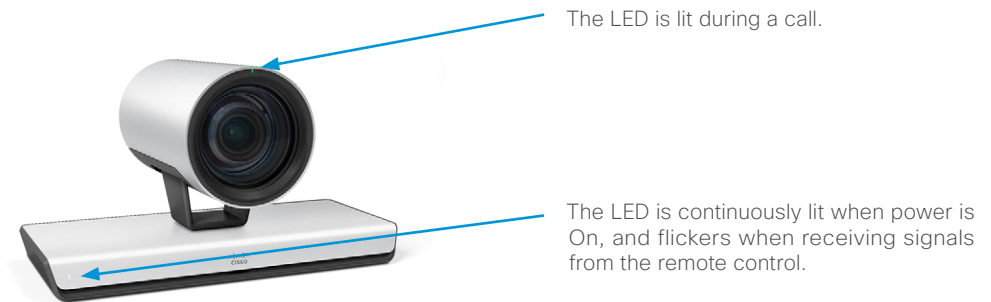
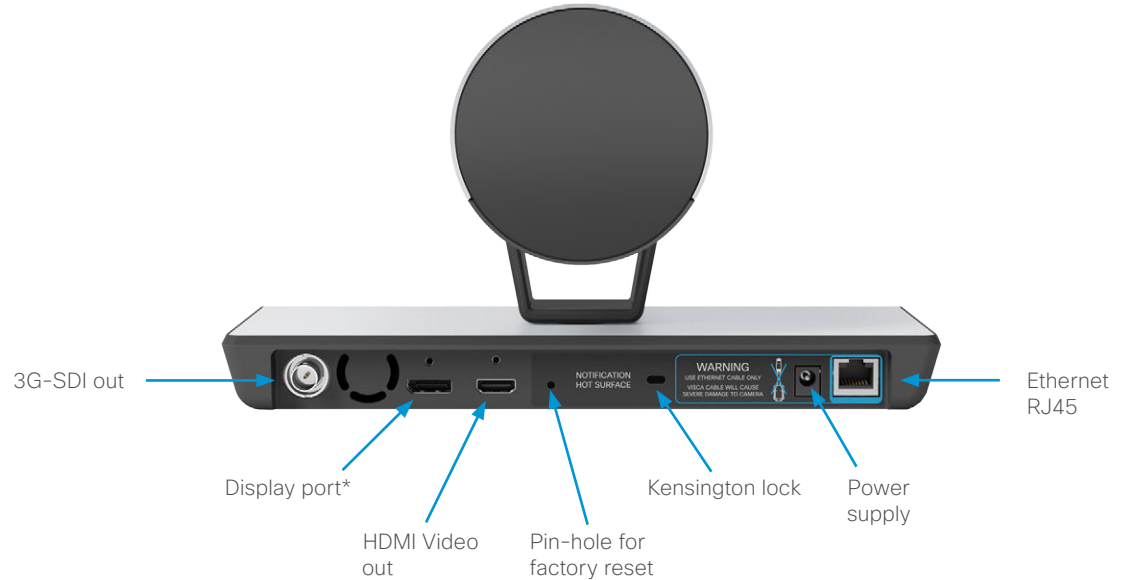

* For future use

SpeakerTrack 60

Video

- Two HDMI cables from the cameras.

Power

- Power out to cameras (internal connection).
- Power in: 12 V_{DC}, 6.5 A
Always use the provided cables and adapter.

Ethernet

Two Ethernet ports are used for the internal camera control connection. The third connector is used for connecting the codec.

 Do **NOT** connect a camera control cable to the Ethernet codec port of the device. This will destroy the system.

Microphone connectors

The right set is used for internal connection to the microphone panel. The left set of connectors is intended for future use.

Kensington lock

The Kensington lock may be used to prevent the camera from being moved from its place or to prevent theft.

For more information about the internal connection setup, please see the SpeakerTrack 60 installation guide:

▶ <http://www.cisco.com/go/telepresence/docs>

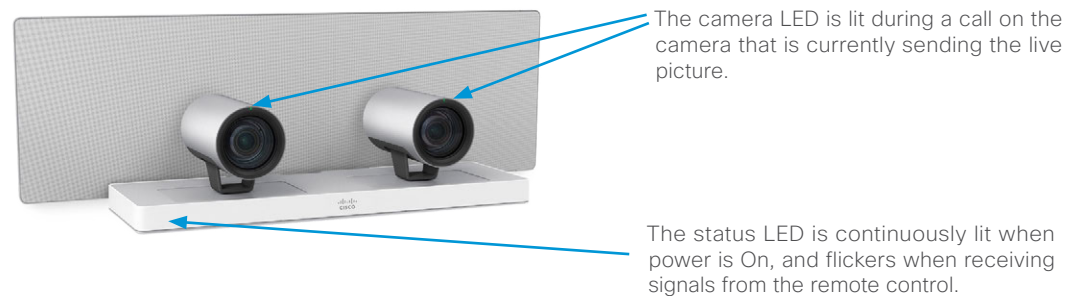
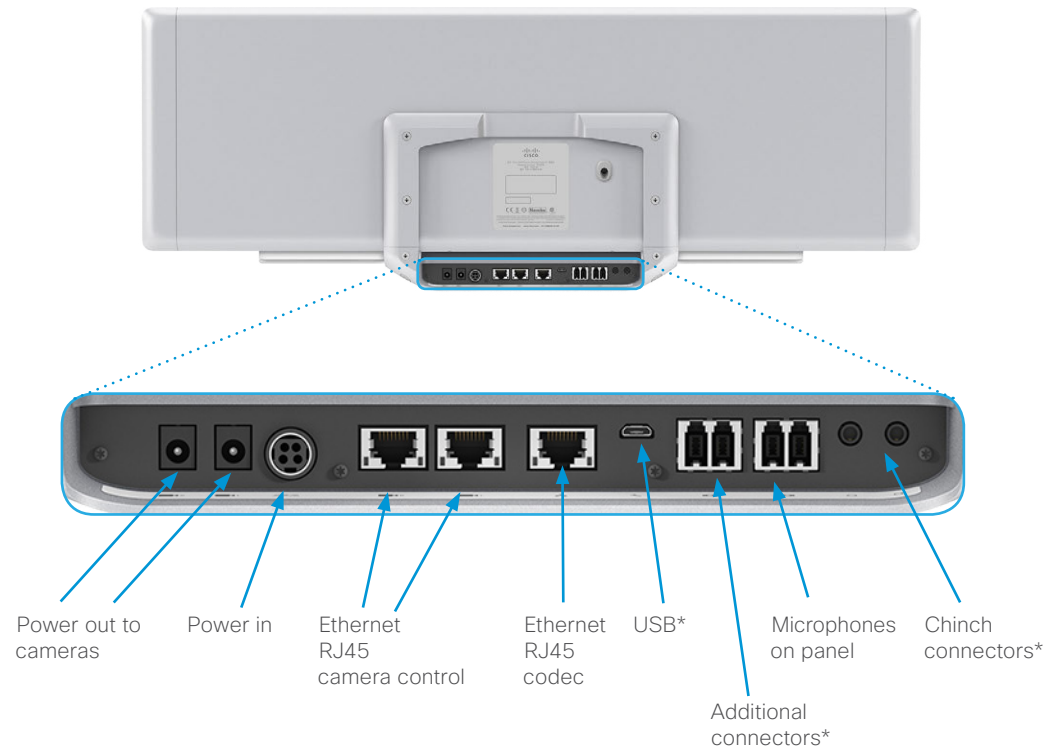

The camera LED is lit during a call on the camera that is currently sending the live picture.

The status LED is continuously lit when power is On, and flickers when receiving signals from the remote control.

* For future use

CHAPTER 3

Connecting to a codec

Codec compatibility

Precision 60

The Precision 60 camera is compatible with the Cisco TelePresence SX80 codec.

SpeakerTrack 60

The SpeakerTrack 60 system is compatible with the following codecs:

- Cisco TelePresence SX80 codec
- Cisco TelePresence C90 codec
- Cisco TelePresence C60 codec
- Cisco TelePresence C40 codec

The codec has to run TC 7.1 software or a later version.



Cisco TelePresence SX80



Codec C40/C60



Codec C90

Connect Precision 60 to SX80 Codec

- Connect the video cable to one of the codec's camera inputs (HDMI). We recommend using the 1st camera input for the main camera.
- Connect Ethernet to the codec's 2nd or 3rd Ethernet port.
- Connect to power.

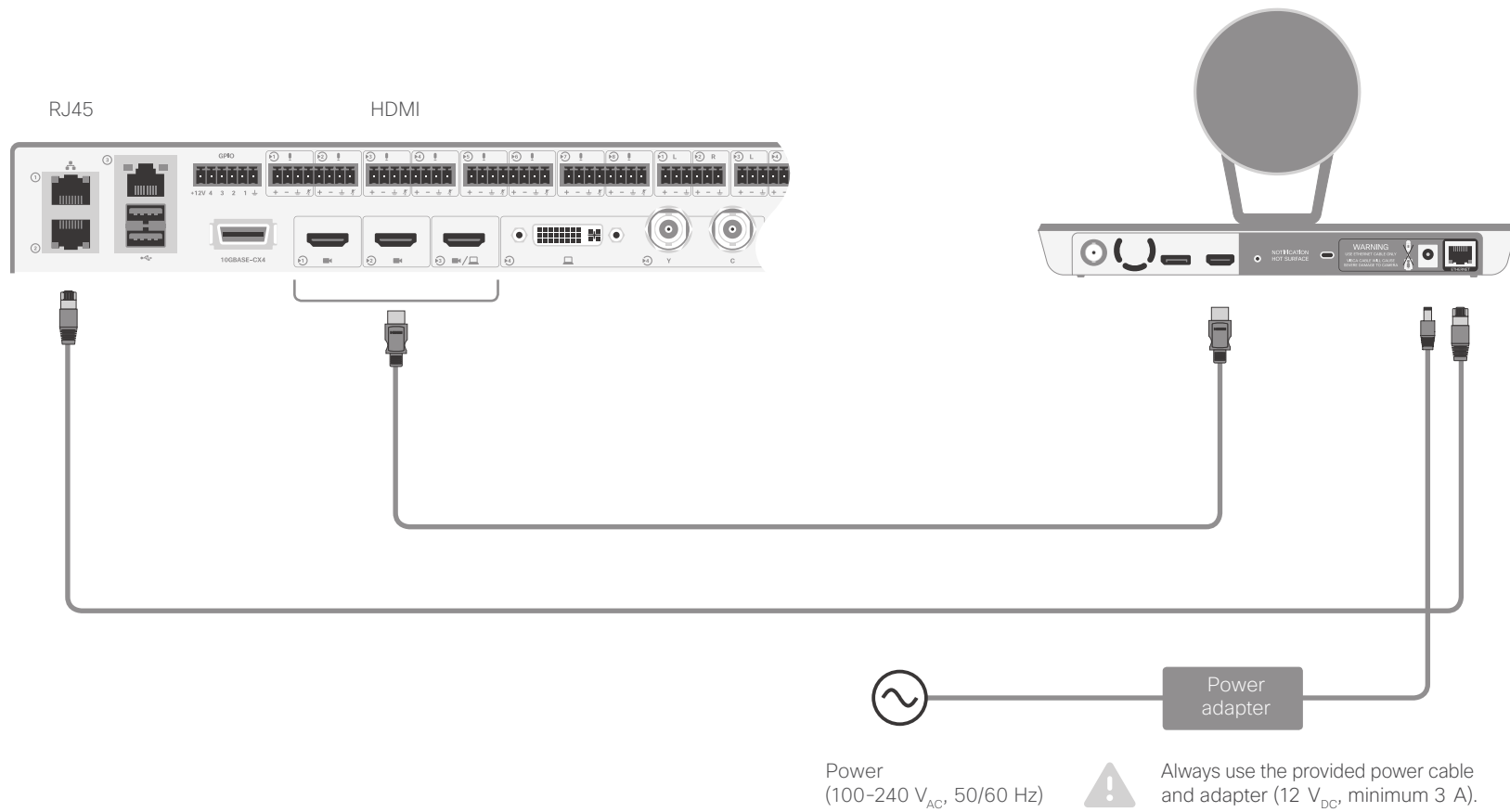

Connect SpeakerTrack 60 to SX80 Codec

- Connect the video cables to the codec's camera inputs (HDMI 1 and 2).
- Connect Ethernet to the codec's 2nd or 3rd Ethernet port.
- Connect to power.

For further information about camera assembly and cabling, refer to the SpeakerTrack 60 installation guide:

<http://www.cisco.com/go/telepresence/docs>

 When using a SpeakerTrack 60 with a C Series codec, the codec cannot be controlled with a Cisco Remote Control TRC5. Instead, a Cisco TelePresence Touch 8 user interface or an external control device must be used.

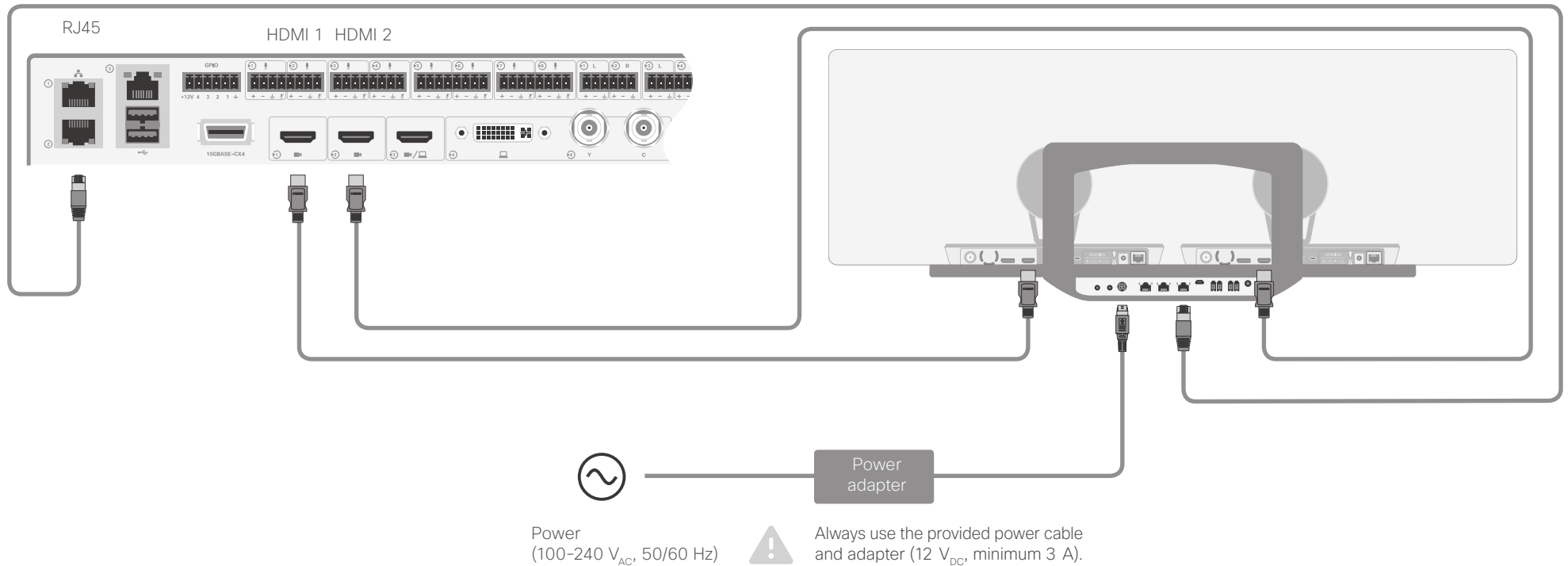

Connect SpeakerTrack 60 to Codec C40

- Connect the video cables to the codec's camera inputs (HDMI 1 and 2).
- Connect Ethernet to the codec's 2nd or 3rd Ethernet port.
- Connect to power.

For further information about camera assembly and cabling, refer to the SpeakerTrack 60 installation guide:

<http://www.cisco.com/go/telepresence/docs>

 When using a SpeakerTrack 60 with a C Series codec, the codec cannot be controlled with a Cisco Remote Control TRC5. Instead, a Cisco TelePresence Touch 8 user interface or an external control device must be used.

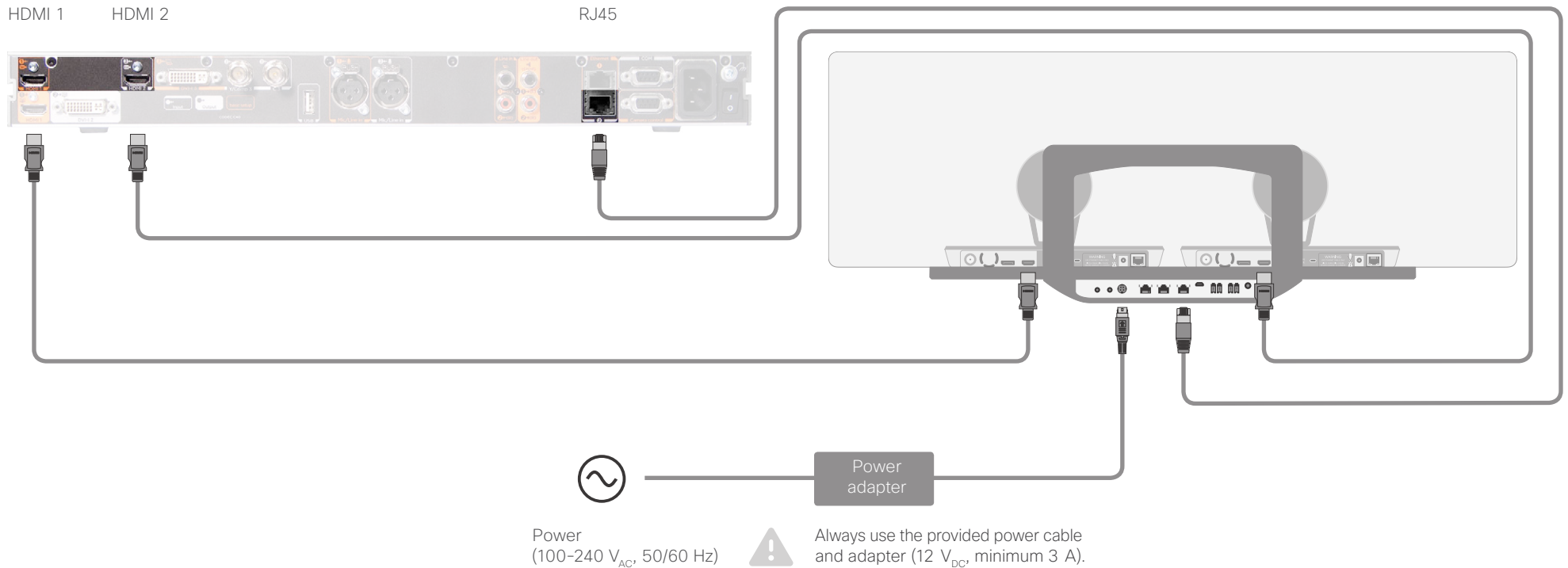

Connect SpeakerTrack 60 to Codec C60

- Connect the video cables to the codec's camera inputs (HDMI 1 and 2).
- Connect Ethernet to the codec's 2nd or 3rd Ethernet port.
- Connect to power.

For further information about camera assembly and cabling, refer to the SpeakerTrack 60 installation guide:

<http://www.cisco.com/go/telepresence/docs>

 When using a SpeakerTrack 60 with a C Series codec, the codec cannot be controlled with a Cisco Remote Control TRC5. Instead, a Cisco TelePresence Touch 8 user interface or an external control device must be used.

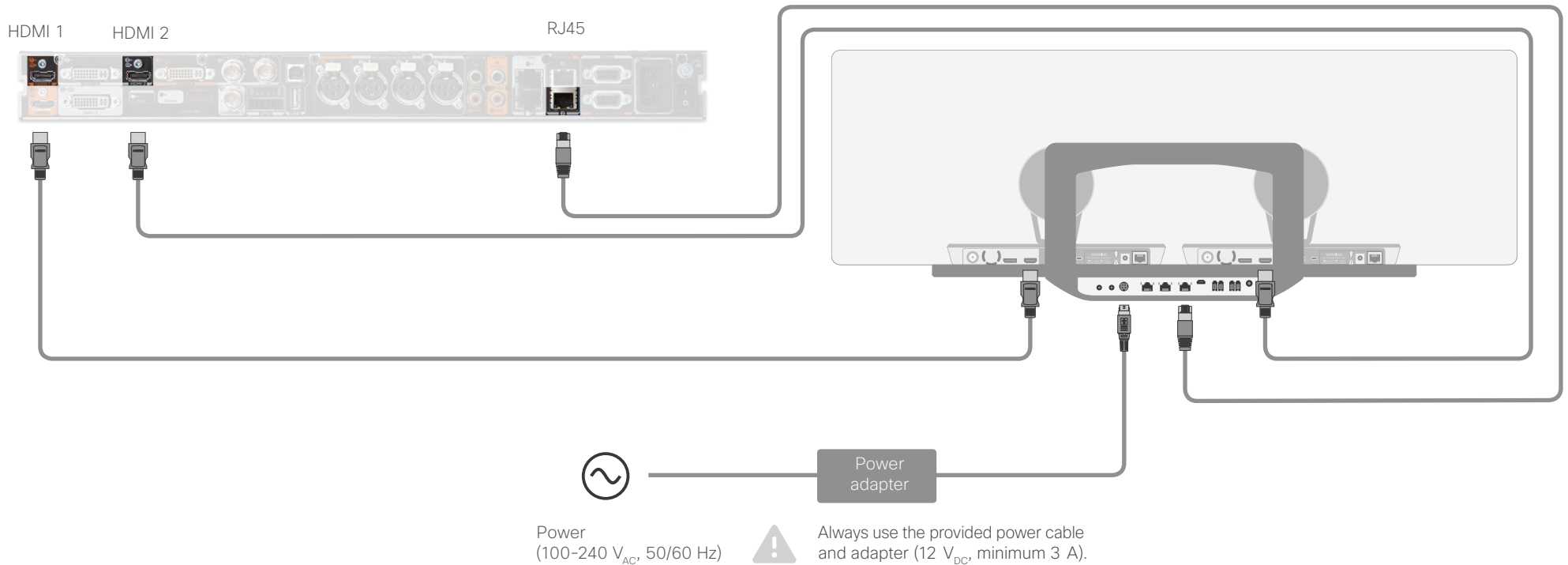

Connect SpeakerTrack 60 to Codec C90

- Connect the video cables to the codec's camera inputs (HDMI 1 and 2).
- Connect Ethernet to the codec's 2nd Ethernet port.
- Connect to power.

For further information about camera assembly and cabling, refer to the SpeakerTrack 60 installation guide:

<http://www.cisco.com/go/telepresence/docs>

i When using a SpeakerTrack 60 with a C Series codec, the codec cannot be controlled with a Cisco Remote Control TRC5. Instead, a Cisco TelePresence Touch 8 user interface or an external control device must be used.

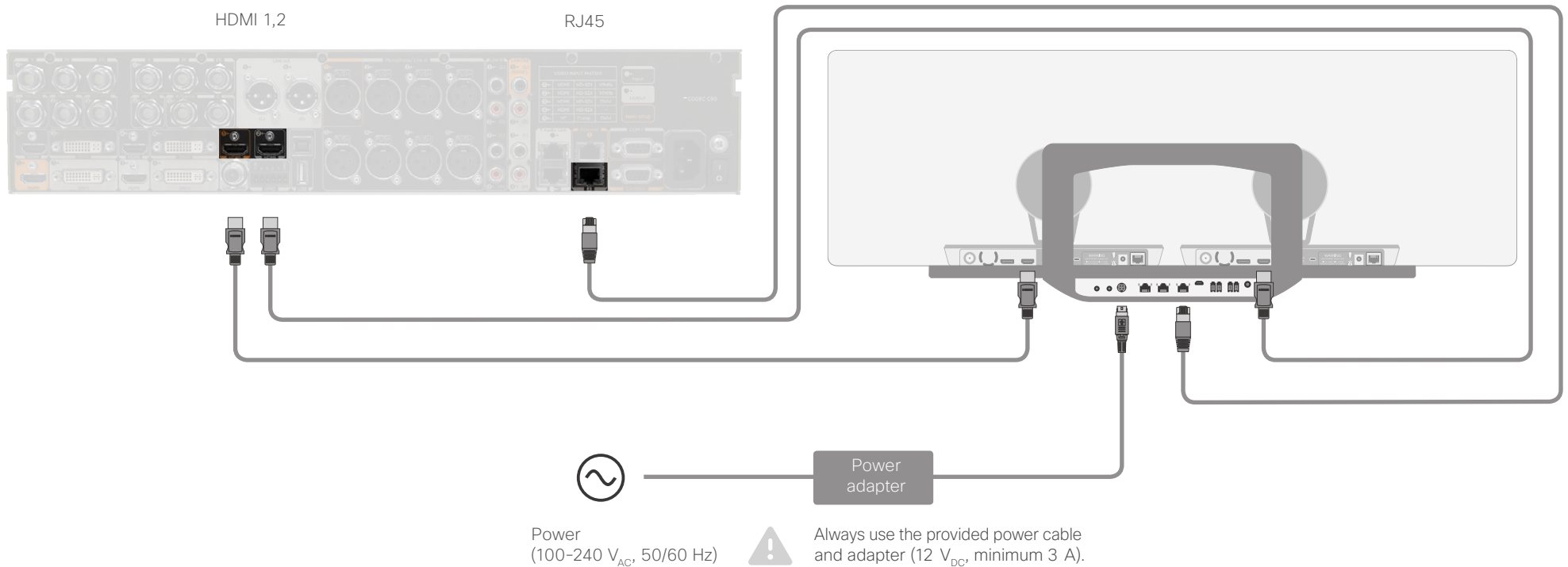

CHAPTER 4

Factory reset

Precision 60

A factory reset should only be performed by a system administrator or in contact with Cisco technical support.

The camera will be reset to factory defaults, and all configuration and logs will be erased.

 It is *not* possible to undo a factory reset.

To perform a factory reset:

1. Locate the pin hole button at the back of the camera.
2. Use a pen or similar to press and hold the factory reset button for 10 seconds.
3. The camera LED will be lit red during the factory reset.

 Do not unplug power.

4. When the factory reset is complete, the camera restarts and the camera LED lights up.

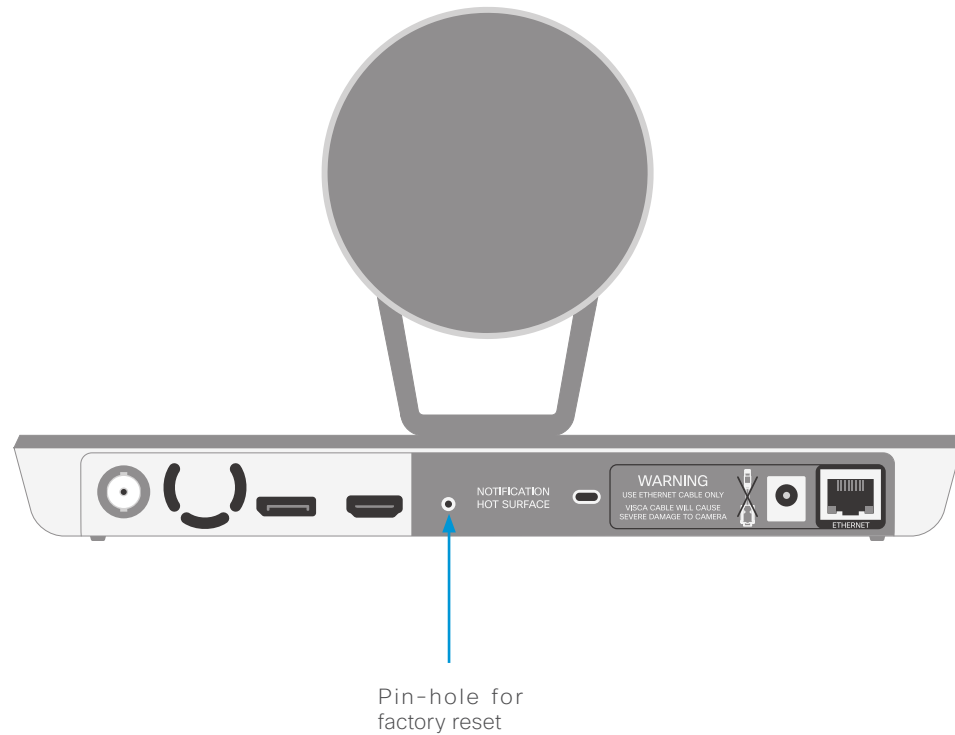

SpeakerTrack 60

Factory resetting the device

A factory reset should only be performed by a system administrator or in contact with Cisco technical support.

The device will be reset to factory defaults, and all configuration and logs will be erased.

If errors continue to occur, the cameras might have to be reset, too. See the next page for instructions on how to reset the cameras.

 It is *not* possible to undo a factory reset.

To perform a factory reset:

1. Remove the top cover of the SpeakerTrack 60 device.
2. Locate the pin hole button at the top of the SpeakerTrack 60.
3. Use a pen or similar to press and hold the factory reset button for 10 seconds.
4. The camera LED will be lit red during the factory reset.

 Do not unplug power.

5. When the factory reset is complete, the device restarts and the LED lights up.

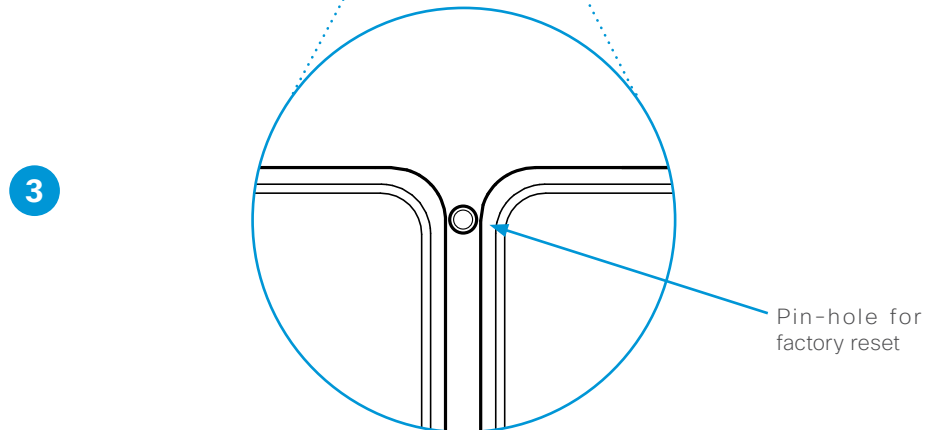
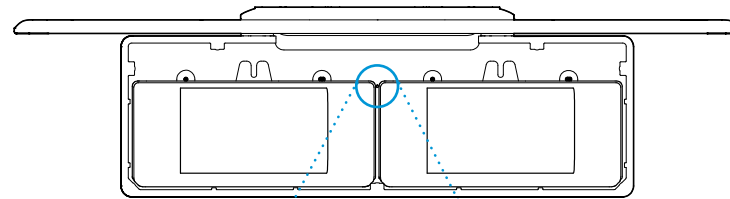
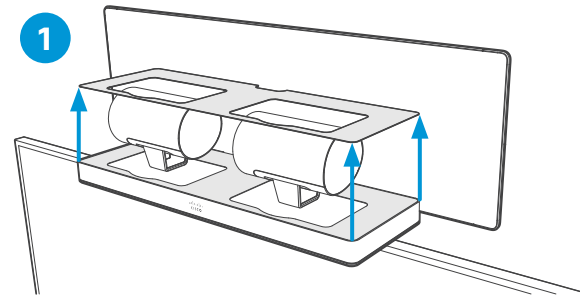

SpeakerTrack 60

Factory resetting the cameras

In order to reset the cameras, they have to be lifted from the carrier tray, to access to the pin-hole button on the back panel of the camera.

A factory reset should only be performed by a system administrator or in contact with Cisco technical support.

The cameras will be reset to factory defaults, and all configuration and logs will be erased.

 It is *not* possible to undo a factory reset.

To perform a factory reset:

1. Remove the top cover of the SpeakerTrack 60 device.
2. Unscrew the wing nut that fastens one of the cameras.
3. Locate the pin hole button at the back of the camera. See also [factory reset on Precision60](#).
4. Use a pen or similar to press and hold the factory reset button for 10 seconds.
5. The camera LED will be lit red during the factory reset.

 Do not unplug power.

6. When the factory reset is complete, the camera restarts and the camera LED lights up.
7. Set the camera back to the tray and tighten the wing nut (see picture 2 on the right).
8. Repeat steps 2-7 with the other camera.
9. Set back the top cover.

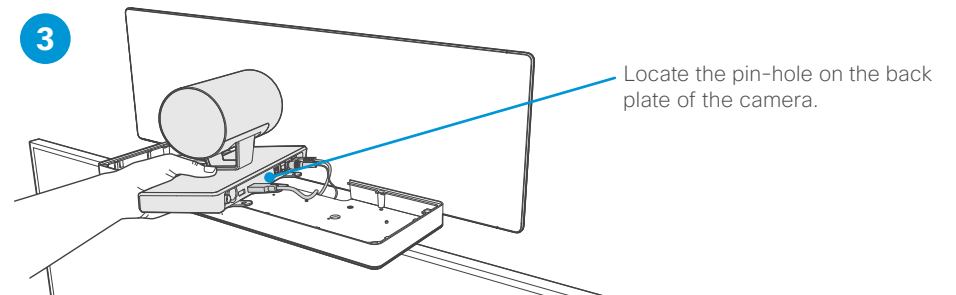
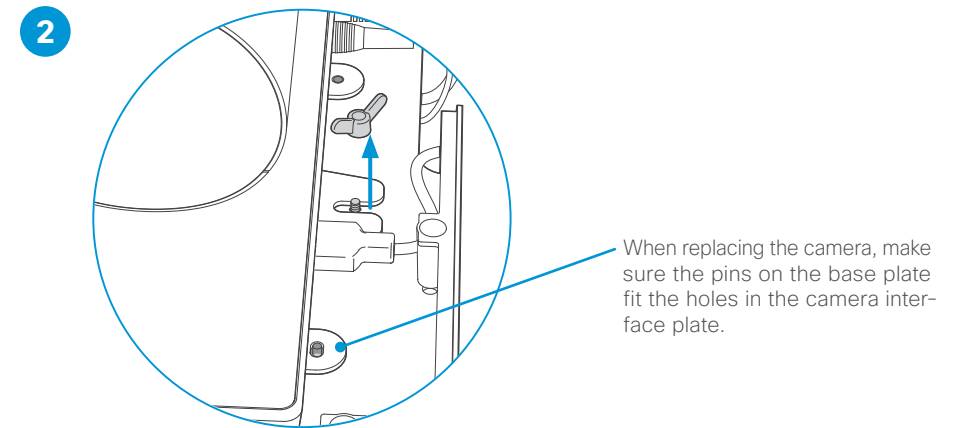
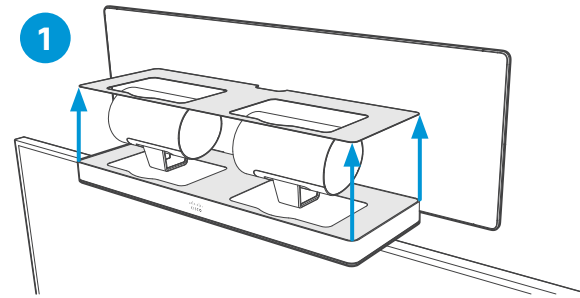

CHAPTER 5

Appendix

Technical specifications

Precision 60

- 1080p60 Full High Definition
- 10x optical zoom
- 2x digital zoom
- 20x zoom combined
- Pan range: -100° to +100°
- Tilt range: -20° to +20°
- 80° horizontal field of view
- 48.8° vertical field of view
- Focus distance: 1.0m-∞ (wide)
- F number: 1.5
- Camera control over Ethernet
- Automatic or manual focus, brightness and white balance
- IP network features:
 - DNS lookup for service configuration
 - Date and Time support via NTP
 - TCP/IP
 - DHCP
- LAN/Ethernet (RJ45) 10/100 Mbit network interface
- HDMI and 3G-SDI video interfaces
- Power adapter:
 - Input: 100-120 or 200-240 VAC; 50 or 60 Hz
 - Output: 12 V / 6.5 A
- Operating temperature and humidity:
 - 0°C to 40°C (32°F to 104°F)
 - 10 to 90% relative humidity
- Storing and transport temperature and humidity:
 - -20°C to 60°C (-4°F to 140°F)
 - 10 to 90 % relative humidity, non condensing
- Height: 152 mm/6.0 in
- Width: 268 mm/10.6 in
- Depth: 163 mm/6.4 in
- Weight: 2.5 kg/5.5 lbs
- Part number: CTS-CAM-P60=



SpeakerTrack 60

- 1080p60 Full High Definition
- 10x optical zoom
- 2x digital zoom
- 20x zoom combined
- Pan range: -100° to +100°
- Tilt range: -20° to +20°
- 80° horizontal field of view (FoV)
- 48.8° vertical FoV
- Tracking horizontal FoV: 80°
- Focus distance: 1.0m-∞ (wide)
- F-value: 1.5
- Camera control over Ethernet
- Automatic or manual focus, brightness and white balance
- IP network features:
 - DNS lookup for service configuration
 - Date and Time support via NTP
 - TCP/IP
 - DHCP
- LAN/Ethernet (RJ45) 10/100 Mbit network interface
- HDMI 1.4 video interface
- Power adapter:
 - Input: 100-120 or 200-240 VAC; 50 or 60 Hz
 - Output: 12 V / 6.5 A
- Operating temperature and humidity:
 - 0°C to 40°C (32°F to 104°F)
 - 10 to 90 % relative humidity
- Storing and transport temperature and humidity:
 - -20°C to 60 °C (-4°F to 140°F)
 - 10 to 90 % relative humidity, non condensing
- Compatibility information:
 - Compatible with C40, C60, C90 and SX80 codecs
 - Requires a Cisco Touch 8 or Touch 10 user interface (unless a control system is used)
- Height: 292 mm/11.5 in
- Width: 800 mm/31.5 in
- Depth: 210 mm/8.3 in
- Weight: 11.5 kg/25.4 lbs
- Part number: CTS-SPKER-TRACK60



THE SPECIFICATIONS AND INFORMATION REGARDING THE PRODUCTS IN THIS MANUAL ARE SUBJECT TO CHANGE WITHOUT NOTICE. ALL STATEMENTS, INFORMATION, AND RECOMMENDATIONS IN THIS MANUAL ARE BELIEVED TO BE ACCURATE BUT ARE PRESENTED WITHOUT WARRANTY OF ANY KIND, EXPRESS OR IMPLIED. USERS MUST TAKE FULL RESPONSIBILITY FOR THEIR APPLICATION OF ANY PRODUCTS.

THE SOFTWARE LICENSE AND LIMITED WARRANTY FOR THE ACCOMPANYING PRODUCT ARE SET FORTH IN THE INFORMATION PACKET THAT SHIPPED WITH THE PRODUCT AND ARE INCORPORATED HEREIN BY THIS REFERENCE. IF YOU ARE UNABLE TO LOCATE THE SOFTWARE LICENSE OR LIMITED WARRANTY, CONTACT YOUR CISCO REPRESENTATIVE FOR A COPY.

The Cisco implementation of TCP header compression is an adaptation of a program developed by the University of California, Berkeley (UCB) as part of UCB's public domain version of the UNIX operating system. All rights reserved. Copyright © 1981, Regents of the University of California.

NOTWITHSTANDING ANY OTHER WARRANTY HEREIN, ALL DOCUMENT FILES AND SOFTWARE OF THESE SUPPLIERS ARE PROVIDED "AS IS" WITH ALL FAULTS. CISCO AND THE ABOVE-NAMED SUPPLIERS DISCLAIM ALL WARRANTIES, EXPRESSED OR IMPLIED, INCLUDING, WITHOUT LIMITATION, THOSE OF MERCHANTABILITY, FITNESS FOR A PARTICULAR PURPOSE AND NONINFRINGEMENT OR ARISING FROM A COURSE OF DEALING, USAGE, OR TRADE PRACTICE.

IN NO EVENT SHALL CISCO OR ITS SUPPLIERS BE LIABLE FOR ANY INDIRECT, SPECIAL, CONSEQUENTIAL, OR INCIDENTAL DAMAGES, INCLUDING, WITHOUT LIMITATION, LOST PROFITS OR LOSS OR DAMAGE TO DATA ARISING OUT OF THE USE OR INABILITY TO USE THIS MANUAL, EVEN IF CISCO OR ITS SUPPLIERS HAVE BEEN ADVISED OF THE POSSIBILITY OF SUCH DAMAGES.

Any Internet Protocol (IP) addresses and phone numbers used in this document are not intended to be actual addresses and phone numbers. Any examples, command display output, network topology diagrams, and other figures included in the document are shown for illustrative purposes only. Any use of actual IP addresses or phone numbers in illustrative content is unintentional and coincidental.

All printed copies and duplicate soft copies are considered un-Controlled copies and the original on-line version should be referred to for latest version.

Cisco has more than 200 offices worldwide. Addresses, phone numbers, and fax numbers are listed on the Cisco website at www.cisco.com/go/offices.

TANDBERG is now a part of Cisco. TANDBERG® is a registered trademark belonging to Tandberg ASA.

Cisco and the Cisco logo are trademarks or registered trademarks of Cisco and/or its affiliates in the U.S. and other countries. To view a list of Cisco trademarks, go to this URL: www.cisco.com/go/trademarks. Third-party trademarks mentioned are the property of their respective owners. The use of the word partner does not imply a partnership relationship between Cisco and any other company. (1110R)

Contact us

Cisco contacts

On our web site you will find an overview of the worldwide Cisco contacts.

Go to: [▶ http://www.cisco.com/web/siteassets/contacts](http://www.cisco.com/web/siteassets/contacts)

Corporate Headquarters
Cisco Systems, Inc.
170 West Tasman Dr.
San Jose, CA 95134 USA

Free Manuals Download Website

<http://myh66.com>

<http://usermanuals.us>

<http://www.somanuals.com>

<http://www.4manuals.cc>

<http://www.manual-lib.com>

<http://www.404manual.com>

<http://www.luxmanual.com>

<http://aubethermostatmanual.com>

Golf course search by state

<http://golfingnear.com>

Email search by domain

<http://emailbydomain.com>

Auto manuals search

<http://auto.somanuals.com>

TV manuals search

<http://tv.somanuals.com>