

Operator's Manual

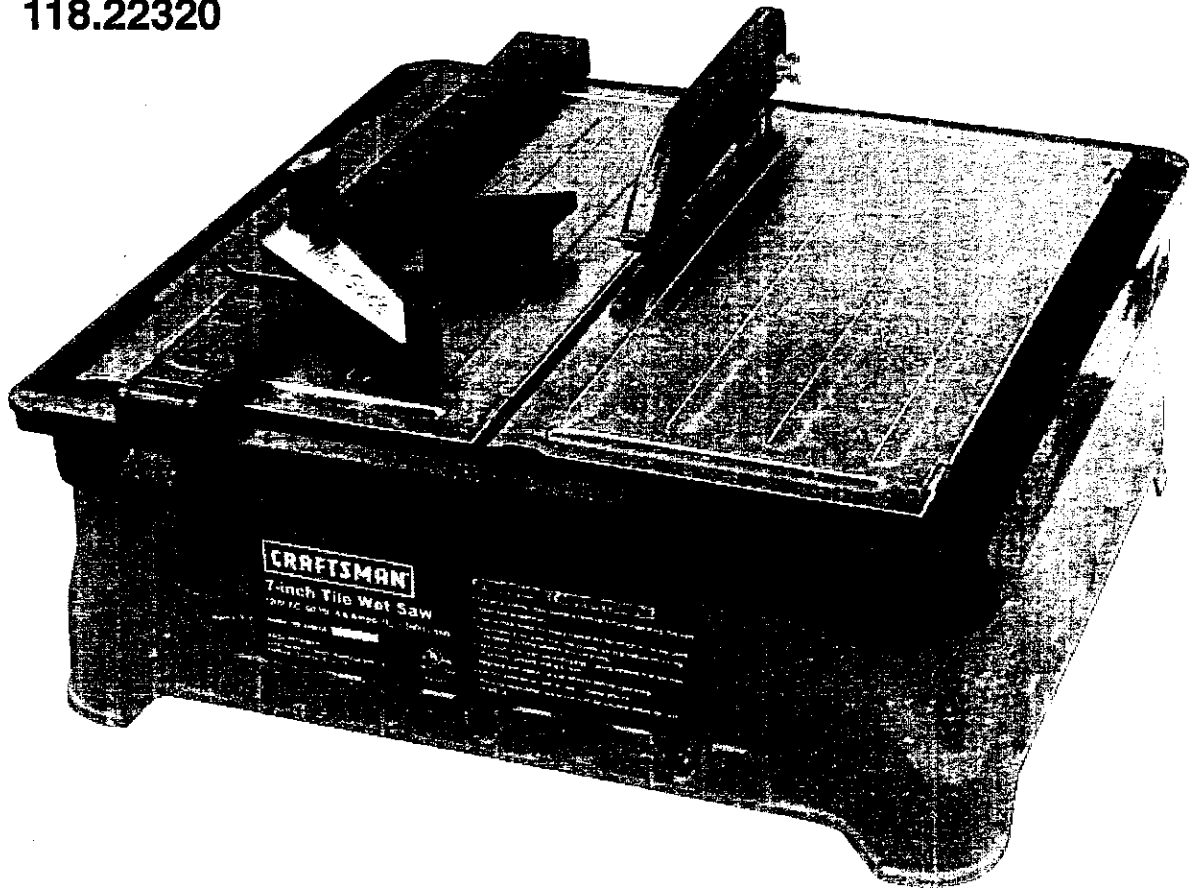

7-in. TILE WET SAW

Model No.
118.22320



⚠ CAUTION: Read, understand and follow all Safety Rules and Operating Instructions in this manual before using this product.

- SAFETY
- OPERATION
- MAINTENANCE

Sears, Roebuck and Co., Hoffman Estates, IL 60179 U.S.A.

TABLE OF CONTENTS

Warranty.....	Page 2
Safety Instructions.....	Pages 3-8
Safety Symbols.....	Page 8
Description.....	Page 9
Assembly.....	Page 10
Operation.....	Pages 11-12
Maintenance.....	Page 13
Repair Parts.....	Page 14-15
Service Numbers.....	Back Cover

ONE YEAR FULL WARRANTY ON CRAFTSMAN TOOL

If this Craftsman Tool fails to give complete satisfaction within one year from the date of purchase, **RETURN IT TO THE NEAREST SEARS STORE OR SEARS PARTS AND REPAIR CENTER IN THE UNITED STATES**, and Sears will repair it, free of charge.

If this Craftsman Tool is used for commercial or rental purposes, this warranty applies for only 90 days from the date of purchase.

This warranty gives you specific legal rights, and you may also have other rights which vary from state to state.

Sears, Roebuck and Co., Dept. 817 WA, Hoffman Estates, IL 60179

SAVE THESE INSTRUCTIONS!
READ ALL INSTRUCTIONS!

SAFETY INSTRUCTIONS

 **WARNING: BE SURE** to read and understand all instructions. Failure to follow all instructions listed below may result in electric shock, fire and/or serious personal injury.

WORK AREA SAFETY

1. **ALWAYS** keep your work area clean and well lit. Cluttered and dark areas invite accidents.
2. **DO NOT** operate power tools in explosive atmospheres, such as in the presence of flammable liquids, gases, or dust. Power tools create sparks which may ignite the dust or fumes.
3. **ALWAYS** keep bystanders, children and visitors away while operating a power tool. Distractions can cause you to lose control.

PERSONAL SAFETY

1. **ALWAYS** stay alert, watch what you are doing and use common sense when operating a power tool. **DO NOT** use tool while tired or under the influence of drugs, alcohol or medication. A moment of inattention while operating power tools may result in serious personal injury.
2. **ALWAYS** dress properly. **DO NOT** wear loose clothing or jewelry. Pull back long hair. Keep your hair, clothing and gloves away from moving parts. Loose clothing, jewelry or long hair can be caught in moving parts.
3. **ALWAYS** avoid accidental starting. **BE SURE** switch is in the "Off" position before plugging in. **DO NOT** carry tools with your finger on the switch. Carrying tools with your finger on the switch or plugging in tools that have the switch in the "On" position invites accidents.
4. **ALWAYS** remove adjusting keys or wrenches before turning the tool on. A wrench or a key that is left attached to a rotating part of the tool may result in personal injury.
5. **DO NOT** overreach. **ALWAYS** keep proper footing and balance at all times. Proper footing and balance enables better control of the tool in unexpected situations.
6. **ALWAYS** use safety equipment. Always wear eye protection. Dust mask, non-skid safety shoes, hard hat, or hearing protection must be used for appropriate conditions
7. **NEVER** stand on tool. Serious injury could occur if the tool is tipped or if the blade is accidentally contacted.
8. **ALWAYS** avoid accidental starting. **BE SURE** switch is in the "Off" position before plugging in.

SAFETY INSTRUCTIONS cont.

TOOL USE AND CARE SAFETY

⚠ WARNING: BE SURE to read and understand all instructions before operating this saw. Failure to follow all instructions listed below may result in electric shock, fire and/or serious personal injury.

1. **ALWAYS** use a splash hood in every operation in which it can be used.
2. **DO NOT** directly wash the bottom of the motor.
3. **DO NOT** force the material being cut. **ALWAYS** let the blade cut at its own speed.
4. **DO NOT** force the tool. **Use the correct tool for your application.** The correct tool will do the job better and safer at the rate for which it is designed.
5. **ALWAYS** be sure that you are using the correct blade for the job you are doing.
6. **ALWAYS** disconnect the saw **BEFORE** servicing, changing cutting wheels and cleaning
7. **BE SURE** the cutting edges are smooth and free of opening and grooves **BEFORE** using this tool.
8. **ALWAYS** replace damaged cutting wheels **BEFORE** using.
9. **ALWAYS** use clamps or other practical ways to secure and support the workpiece to a stable platform. Holding the work by hand or against your body is unstable and may lead to loss of control.
10. **DO NOT** use the tool if the switch does not turn it "On" or "Off". Any tool that cannot be controlled with the switch is dangerous and must be repaired.
11. **ALWAYS** disconnect the plug from the power source before making adjustments, changing accessories or storing the tool. Such preventive safety measures reduce the risk of starting the tool accidentally.
12. **ALWAYS** keep guards in place and in good working order.
13. **DO NOT** use in dangerous environment. **DO NOT** use in damp or wet locations, or expose to rain.
14. **ALWAYS** maintain tools with care. Keep tools sharp and clean for best and safest performance. Read instructions for lubricating and changing accessories.
15. **REDUCE THE RISK OF ACCIDENTAL STARTING. ALWAYS** make sure the switch is in the OFF position **BEFORE** plugging in.
16. **ALWAYS** store idle tools out of the reach of children and other untrained persons. Tools are dangerous in the hands of untrained users.
17. **ALWAYS** maintain tools with care. **Keep cutting tools sharp and clean.** Properly maintained tools with sharp cutting edges are less likely to bind and are easier to control.
18. **ALWAYS** check for misalignment or binding of moving parts, breakage of parts, and any other condition that may affect the tool's operation. If damaged, have the tool serviced before using. Many accidents are caused by poorly maintained tools.

⚠ WARNING: USE OF ACCESSORIES THAT ARE NOT RECOMMENDED FOR USE WITH THIS TOOL MAY CREATE A HAZARDOUS CONDITION.

19. **ALWAYS** use only accessories that are recommended for this tool. Accessories that may be suitable for one tool can become hazardous when used on another tool.

SAFETY INSTRUCTIONS cont.

ELECTRICAL SAFETY

IMPORTANT: We recommend using a GFCI (Ground Fault Circuit Interrupter) protected receptacle because the blade of this saw is used in close proximity to water.

1. This tile saw is equipped with a 3-prong electrical plug. **DO NOT** alter the plug or use a 2-prong receptacle.
2. The plug supplied on your tool may not fit into the outlet you are planning to use.
3. Your local electrical code may require slightly different power cord plug connections. **If These Differences Exist**, refer to and make the proper adjustments per your local code **BEFORE** your tool is plugged in and turned on.
4. In the event of a malfunction or breakdown, grounding provides a path of least resistance for electric current to reduce the risk of electric shock.
5. This tool is equipped with an electric cord having an equipment-grounding conductor and a grounding plug, as shown in Figure 1. The plug must be plugged into a GFCI protected matching outlet that is properly installed and grounded in accordance with all local codes and ordinances
6. **DO NOT** modify the plug provided. If it will not fit the outlet, have the proper outlet installed by a qualified electrician.
7. A temporary GFCI protected adapter may be used to connect this plug to a 2-prong outlet, if a properly grounded 3-prong outlet is not available.
8. This temporary adapter **Should Be Used Only Until** a properly grounded 3-prong outlet can be installed by a qualified electrician.
9. The green-colored (with or without yellow stripes) is the equipment-grounding conductor and must be connected to a permanent ground, such as a properly grounded outlet box.
10. **Improper connection of the equipment-grounding adapter can result in a risk of electrical shock.**
11. If repair or replacement of the electric cord or plug is necessary, **DO NOT** connect the equipment-grounding adapter to a live terminal.
12. **If you do not fully understand the grounding instructions, or if you are in doubt as to whether the tool is properly grounded, check with a qualified electrician or service person.**
13. **ONLY USE** 3-wire extension cords that have 3-prong grounding plugs and 3-pole receptacles that will accept the tool's plug.
14. **ALWAYS** repair or replace damaged or worn cords immediately.
15. **ALWAYS** avoid the possibility of getting the plug or receptacle wet.
See Positioning the Saw on page 6.
16. **ONLY USE** UL Listed extension cords with this product. Other extension cords may not supply sufficient power causing the tool to overheat. **BE SURE** that the extension cord you use will supply sufficient power to the tool.

⚠ WARNING: Do not permit fingers to touch the terminals of plug when installing or removing the plug to or from the outlet.

⚠ WARNING: If not properly grounded and GFCI protected this tool can cause an electrical shock, particularly when used in damp locations, in proximity to plumbing, or out of doors. If an electrical shock occurs there is the potential of a secondary hazard, such as your hands contacting the saw blade.

SAFETY INSTRUCTIONS cont.

EXTENSION CORDS

ALWAYS periodically inspect tool cord and extension cords for damage. Have damaged tool cord repaired at a Sears Service Center. Discard damaged extension cords. **BE SURE** to stay constantly aware of the cord location and keep it well away from the moving blade.

ALWAYS use the proper extension cord, and **MAKE SURE** the cord is in good condition. **ONLY USE** a cord that is heavy enough to carry the current your tool will draw. An undersized cord will cause a current drop in line voltage resulting in a loss of power and overheating. A wire gauge size AWG (American Wire Gauge) of at least 18 is recommended for an extension cord 25 feet or less in length. If in doubt, use the next heavier size. Smaller gauge wires, have greater capacity (14 gauge wire has more capacity than 16 gauge wire).

DO NOT abuse the cord. **NEVER** use the cord to pull the plug from the outlet. Keep cord away from heat, oil, sharp edges or moving parts. Replace damaged cords immediately. Damaged cords increase the risk of electric shock.

When operating a power tool outside, **ALWAYS** use an outdoor extension cord marked "W-A" or "W". These cords are rated for outdoor use and reduce the risk of electric shock.

GROUNDING INSTRUCTIONS (See Figure 1)

IMPORTANT: We recommend using a GFCI (Ground Fault Circuit Interrupter) protected receptacle because the blade of this saw is used in close proximity to water. This tool is equipped with an electric cord having an equipment-grounding conductor and a grounding plug.

It must be plugged into a GFCI protected matching outlet that is properly installed and grounded in accordance with all local codes and ordinances.

1. **DO NOT** try to modify the plug provided. If it will not fit into the outlet, have the proper outlet installed by a qualified electrician.
2. The green-colored wire (with or without yellow stripes) is the equipment-grounding conductor and must be connected to a permanent ground, such as a properly grounded outlet box.
3. **Improper connection of the equipment-grounding adapter can result in a risk of electrical shock.**
4. If repair or replacement of the electric cord or plug is necessary, **DO NOT** connect the equipment-grounding adapter to a live terminal.
5. **If you do not fully understand the grounding instructions, or if you are in doubt as to whether the tool is properly grounded, check with a qualified electrician or service person.**

Grounded, corded tools are intended for use on supply circuits having a nominal rating of less than 150 volts.

SAFETY INSTRUCTIONS cont.

GROUNDING INSTRUCTIONS (See Figure 1) cont.

This tool is intended for use in an outlet resembling (A) in Figure 1 below. A temporary adapter resembling (B) in Figure 1 may be used to connect it to a 2-pole receptacle, if a properly grounded outlet is not available.

NOTE: The temporary adapter should only be used until a properly-grounded outlet can be installed by a qualified electrician. The green-colored rigid ear, lug, etc. extending from the adapter **MUST BE** connected to a permanent ground, such as a properly-grounded outlet box.

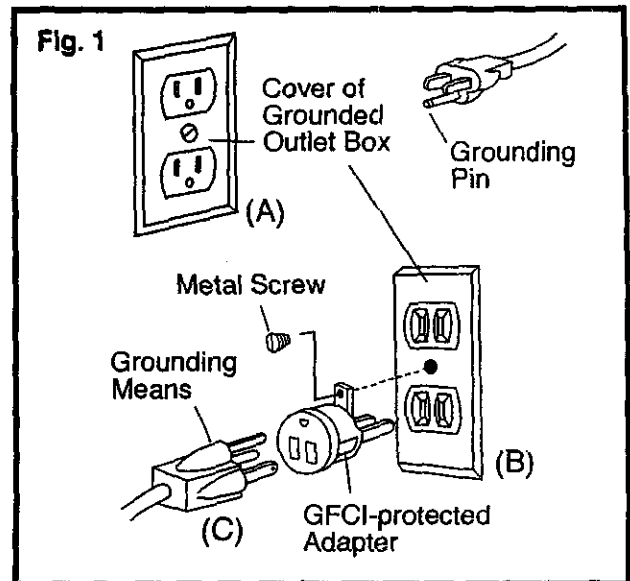

POSITIONING THE TILE SAW (see Figure 2)

1. To help prevent the plug or receptacle from getting wet **ALWAYS** place the tile saw to one side of a wall-mounted receptacle to prevent water from dripping into the receptacle or plug.
2. **ALWAYS** arrange a drip loop so that part of the cord is below the receptacle or a connector (if extension cord is used) to prevent water from traveling along the cord that is in contact with the receptacle.
3. If the plug or receptacle does get wet, **DO NOT** unplug the cord. Disconnect the fuse or circuit breaker that is supplying power to the tool. Then unplug and examine to see if water is present in the receptacle.

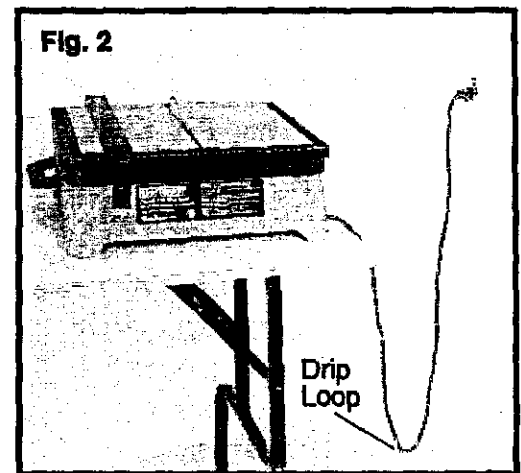

SERVICE SAFETY

1. If any part of this saw is missing or should break, bend, or fail in any way; or should any electrical component fail to perform properly: **ALWAYS** shut off the power switch and remove the saw plug from the power source and have the missing, damaged or failed parts replaced **BEFORE** resuming operation.
2. Tool service must be performed only at a Sears Service Center. Service or maintenance performed by unqualified personnel could result in a risk of injury.
3. When servicing a tool, **ALWAYS** use only identical replacement parts. Follow instructions in the Maintenance Section of this manual. Use of unauthorized parts or failure to follow Maintenance Instructions may create a risk of electric shock or injury.

SAFETY INSTRUCTIONS cont.

SERVICE SAFETY cont.

⚠ WARNING: Some dust particles created by power sanding, sawing, grinding, drilling and other construction jobs contain chemicals known to cause cancer, birth defects or other reproductive harm. Some examples of these chemicals are:

- Lead from lead-based paints.
- Crystalline silica from bricks and cement and other masonry products.
- Arsenic and chromium from chemically-treated lumber.

Your risk from these exposures varies, depending upon how often you do this type of work. To reduce your exposure to these chemicals:

- Work in a well-ventilated area.
- Work with approved safety equipment, such as those dust masks that are specially designed to filter out microscopic particles.



⚠ WARNING: The operation of any saw can result in foreign objects being thrown into your eyes, which can result in severe eye damage. Before beginning power tool operation, **ALWAYS** wear safety goggles or safety glasses with side shield and a full face shield when needed. We recommend A Wide Vision Safety Mask for use over eyeglasses or standard safety glasses with side shield, available at Sears Retail Stores.

SAFETY SYMBOLS

The label on your tool may include the following symbols.

- V.....Volts
- A.....Amps
- Hz.....Hertz
- W.....Watts
- min.....Minutes
- ~.....Alternating current
- no.....No-load speed
- ☐.....Class II construction
- RPM.....Revolutions or Strokes per minute
- ⚠.....Indicates danger, warning or caution.
It means attention! Your safety is involved.

IMPORTANT! READ ALL INSTRUCTIONS

DESCRIPTION

Before attempting to use any tool, be sure to familiarize yourself with all the operating features and safety instructions.

⚠ WARNING: DO NOT let familiarity with your saw make you careless. Remember that a careless fraction of a second is sufficient to cause severe injury.

KNOW YOUR SAW (See Fig. 3)

Your Tile Saw has many built-in convenience features for fast, efficient cutting of ceramic, marble, slate or limestone wall or floor tile. The durable 7-inch blade cuts tile up to 1¹/₄-in. (33mm) thick. The adjustable rip and miter guides allow 90° rip cuts and 0° to 45° miter cuts on both the right and left sides. The left cutting table is hinged so it can be adjusted for 15°, 30° and 45° miter cuts. The right table has a built-in water reservoir for cooling the blade. The water reservoir has a side overflow hole for proper water level. The built-in handle allows easy transporting. The convenient storage area on bottom holds accessories.

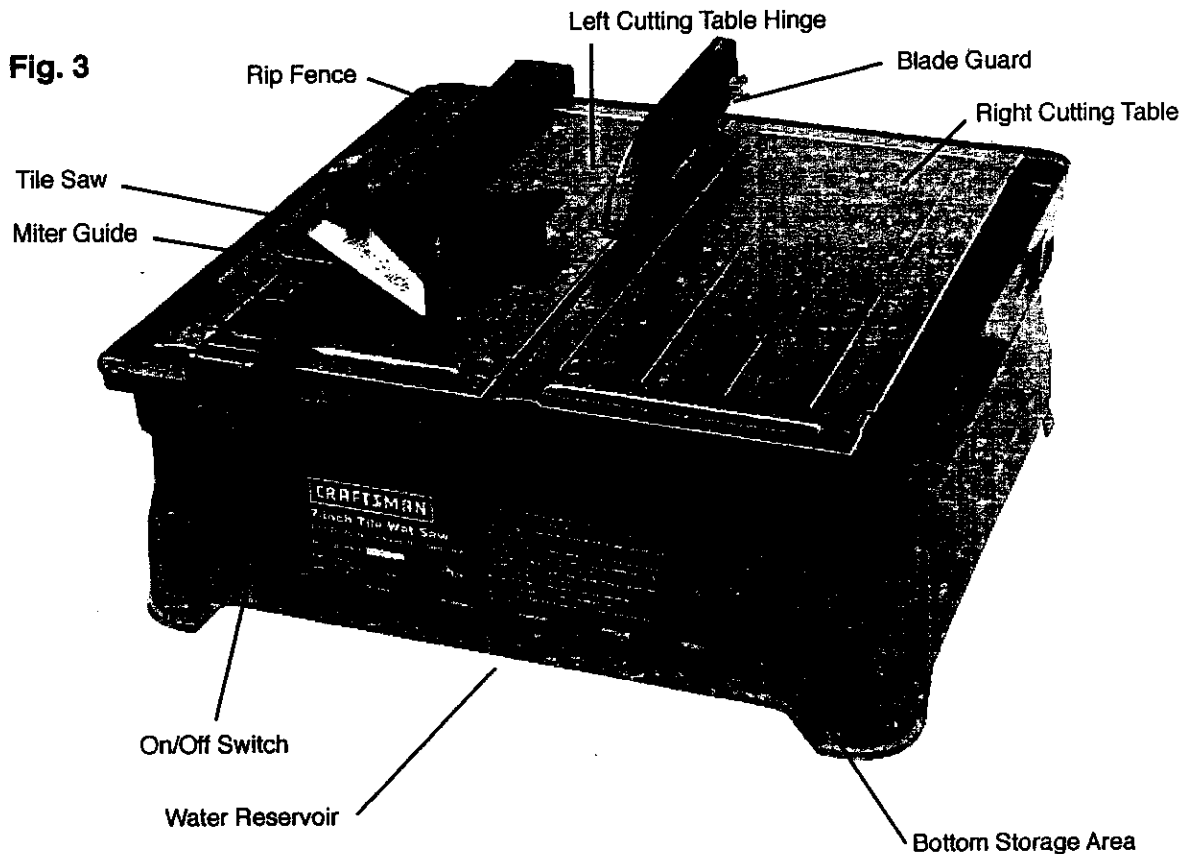

PRODUCT SPECIFICATIONS	
Input	4.8 Amps
Output	3/4-Peak HP
Blade Diameter	7 in. (33mm)
Depth of Cut	1 ¹ / ₄ in. (33mm)
Rating	120 volts, 60 Hz AC
No-load Speed	3600 RPM

ASSEMBLY

UNPACKING

1. Remove all packing materials from around your saw.
2. Carefully lift the saw from carton and place it on a level work surface.
3. Do not discard the packing materials until you have carefully inspected the saw for loose or damaged parts.
4. Inspect the saw carefully to make sure that no breakage or damage has occurred during shipping. If any parts are damaged or missing return the saw to your nearest Sears Store to have it replaced.

⚠ WARNING: If any parts are damaged or missing, **DO NOT** attempt to operate this saw. Operating this saw with damaged or missing parts could result in possible serious personal injury.

⚠ CAUTION: Follow all of the assembly and installation instructions in this manual before connecting the tile saw to a power source or turning it on.

The follows items are included in box with your tile saw:

7-in. Diamond Blade, Blade Guard, Rip Guide, Miter Gauge, Universal Wrench and Operator's Manual

INSTALLING THE BLADE (Figure 4)

⚠ WARNING: Use only continuous rim blades with this saw. **DO NOT** use segmented, "turbo" blades, wood sawing blades, blades with openings, or any other cutting devices with this tile saw. Using these blades could result in serious personal injury and damage to the saw.

1. Carefully place the blade onto the shaft and push it against the inner flange.
2. Be sure the side of the blade with the directional arrow is facing towards you.
3. Place the outer flange and the blade shaft nut onto blade.
4. Firmly tighten the blade shaft nut with the included wrench, but do not over tighten.

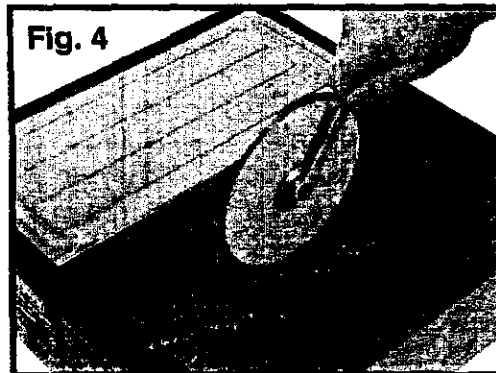

Fig. 4

INSTALLING THE BLADE GUARD (Figure 5)

1. Place the guard support into the socket.
2. Be sure the support is parallel to the blade.
3. Place blade guard onto the support and tighten wing nut.

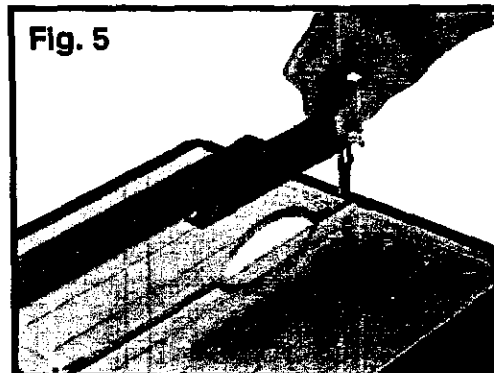

Fig. 5

ASSEMBLY cont.

INSTALLING THE RIP FENCE (Figure 6)

1. Place rip fence on the top of the cutting table and clamp both ends.

NOTE: The rip fence can be placed on either the left or right side.

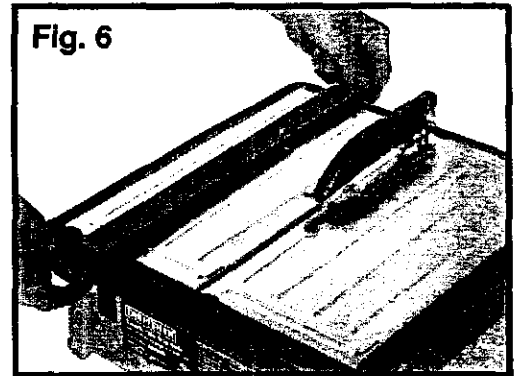

INSTALLING THE MITER GUIDE (Figure 7)

1. The miter guide is designed to fit on top of the rip fence. Simply place notch in miter guide onto the top of the rip fence.

NOTE: The miter guide can be placed on either the left or right side.

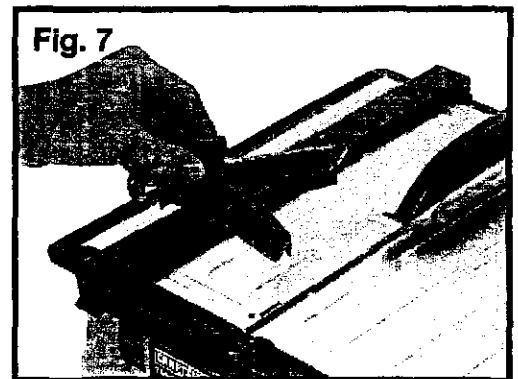

OPERATION

IMPORTANT: ALWAYS turn off the saw and remove the plug from the outlet **BEFORE** adding or removing accessories and making adjustments.

⚠ WARNING: Failure to unplug the saw could result in accidental starting causing possible serious personal injury.

BEFORE STARTING THE SAW (Figure 8)

1. Remove the blade guard.
2. Open the right cutting table and fill the water reservoir to the recommended level. **DO NOT** fill above the lines.

NOTE: ALWAYS keep enough water in the reservoir when operating the saw. **DO NOT** let the saw run dry.

3. Re-attach the blade guard and close the right cutting table.

IMPORTANT: ALWAYS completely drain the water reservoir after each use.

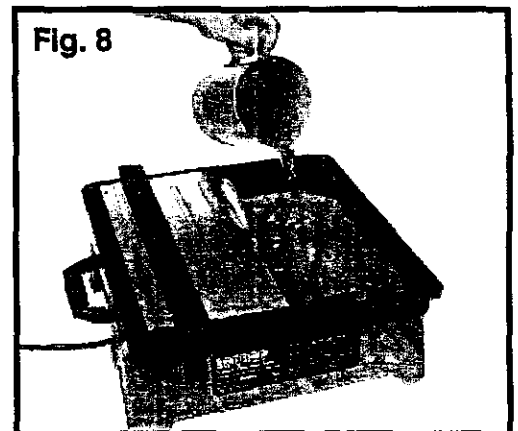

OPERATION cont.

TO START THE SAW (Figure 9)

1. Remove cord from compartment under the saw and connect it to a GFCI (Ground Fault Circuit Interrupter) protected outlet.
2. Push On/Off switch to the "On" position.

IMPORTANT: ALWAYS let the blade cut at its own speed. **DO NOT** force the material being cut. **ALWAYS** check the blade for cracks or damage **BEFORE** each use.

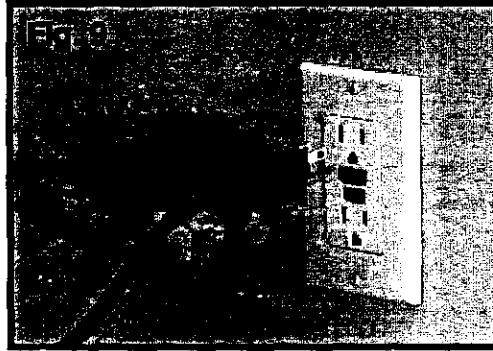

MAKING RIP, ANGLE AND MITER CUTS (Figures 10 - 12)

The edge of the cutting table has easy-to-see dimensions (in both inches and centimeters) for cutting accuracy.

MAKING 90° RIP CUTS (Figure 10)

1. Install the rip fence and position it at the desired angle.
2. Place the material to be cut against the tile guide.
3. Carefully feed the material into the blade.

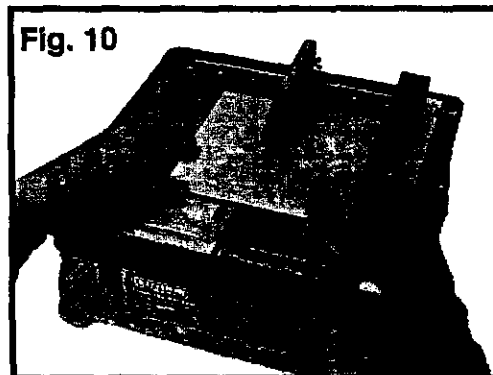

MAKING 0° - 45° ANGLE CUTS (Figure 11)

1. Install the miter guide on the top of the rip fence.
2. Select desired angle and tighten the adjustment knob.
3. Carefully push the miter guide and material towards the blade.

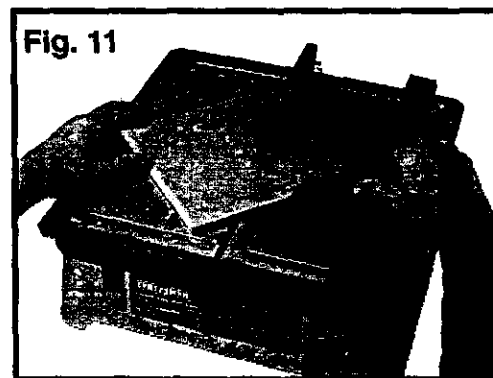

MAKING MITER CUTS (Figure 12)

1. Raise the left cutting table to the desired angle.
- NOTE:** Choose 15°, 30° or 45° angles.
2. Place the 2 stands into the grooves to hold the cutting table in place.
 3. Place the material to be cut face down onto left cutting table.
 4. Carefully push the miter guide and material towards the blade.

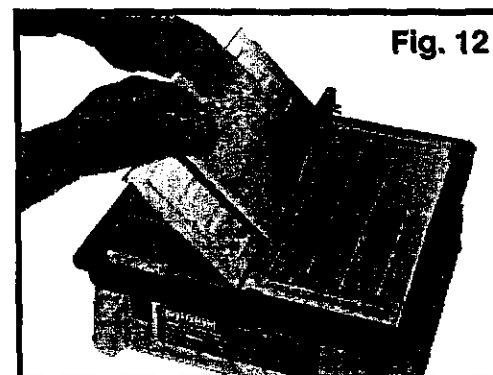

MAINTENANCE

⚠ WARNING: To avoid accidents, **ALWAYS** disconnect the tool from the power source **BEFORE** cleaning or performing any maintenance.

All parts represent an important part of the double insulation system and should be serviced only at a Sears Service Center.

Avoid using solvents when cleaning plastic parts. Most plastics are susceptible to damage from various types of commercial solvents and may be damaged by their use. Use clean cloths to remove dirt, carbon dust, etc.

⚠ WARNING: DO NOT at any time let brake fluids, gasoline, petroleum-based products, penetrating oils, etc. come in contact with plastic parts. They contain chemicals that can damage, weaken or destroy plastic.

1. **ALWAYS** clean the tile saw after each use and store it in a dry location.
2. **ALWAYS** wipe off all exterior surfaces and keep the cutting table clean and free of all debris.
3. **ALWAYS** check the blade for cracks or damage **BEFORE** each use.
4. **ALWAYS** store the cord in the compartment underneath the saw after each use.

TILE SAW – MODEL NUMBER 118.22320

The Model Number will be found on the Nameplate.
Always mention the Model Number in all correspondence regarding your tool.

Parts No.	Part Description	Qty.
22320-1	Blade Guard Set (w/ Screw, Wing Nut, Washer & Guard Support)	1
22320-2	Miter Guide Set (w/Adjustment Knob & Hex Nut)	1
22320-3	Rip Fence	1
22320-4	Left Cutting Table	1
22320-5	Right Cutting Table	1
22320-6	Upper Frame	1
22320-7	Blade Lock Nut	1
22320-8	Outer Flange	1
22320-9	7" Continuous Rim Blade	1
22320-10	Inner Flange	1
22320-11	Oil Seal for Motor	1
22320-12	Motor (w/Screw*5)	1
22320-13	Capacitor (w/Screw)	1
22320-14	Main Frame (w/Screw*6)	1
22320-15	Waterproof Switch (w/Waterproof Rubber Cover)	1
22320-16	Carrying Handle	1
22320-17	Rubber Base	4
22320-18	Power Cord	1
22320-19	Strain Relief Bushing	1
22320-20	Power Cord Shelter	1
22320-21	Universal Wrench	1
22320-22	Blade Guard	1
22320-23	Carton	1

SEE BACK PAGE FOR PARTS ORDERING INSTRUCTIONS

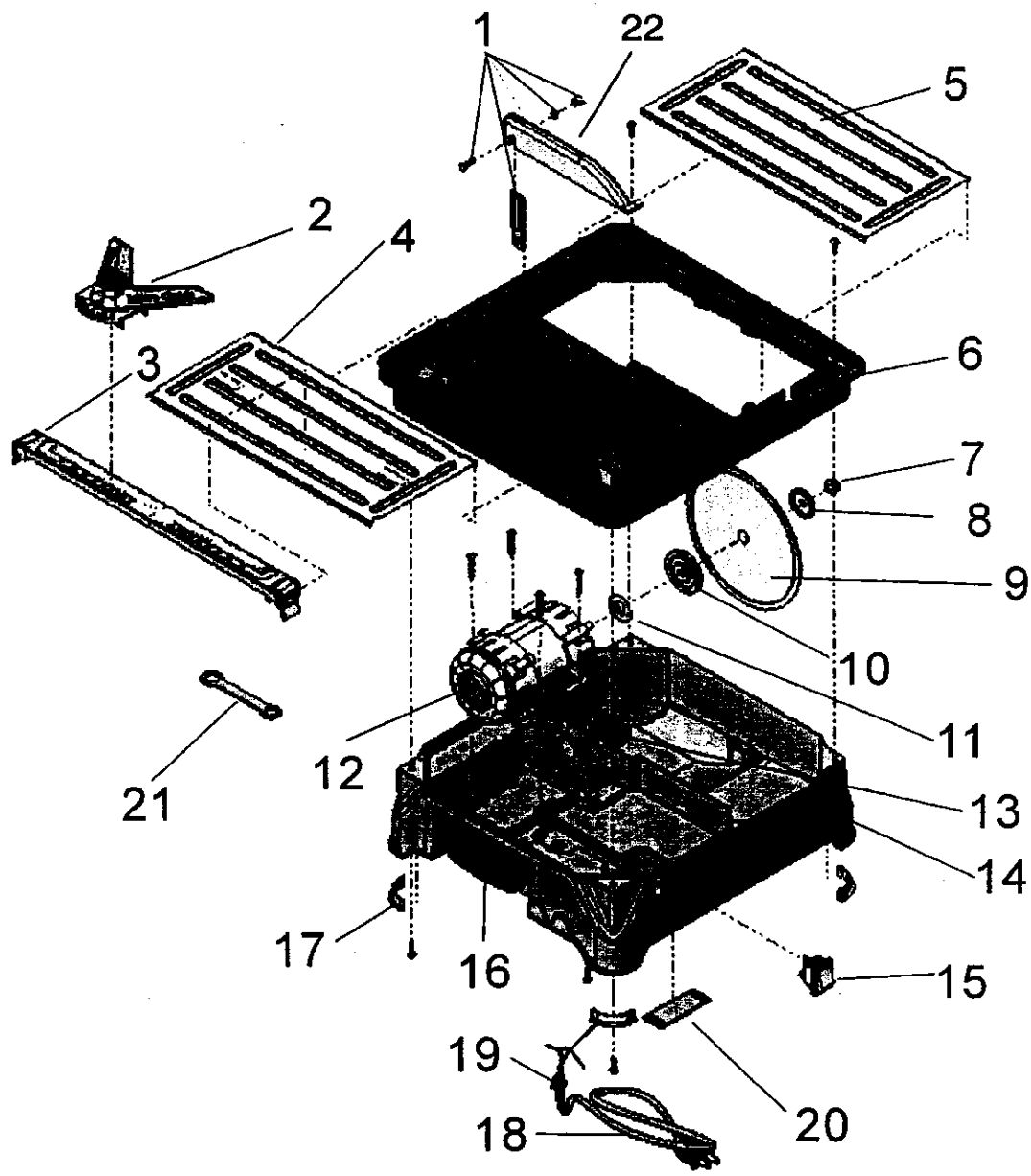

Get it fixed, at your home or ours!

Your Home

For repair in your home of all major brand appliances, lawn and garden equipment, or heating and cooling system, **no matter who made it, no matter who sold it!**

For the replacement parts, accessories and owner's manuals that you need to do-it-yourself.

For Sears professional installation of home appliances and the items like garage door openers and water heaters.

1-800-4-MY-HOME®
(1-800-469-4663)
www.sears.com

Anytime, day or night
(U.S.A. and Canada)
www.sears.com

Our Home

For repair of carry-in products like vacuums, lawn equipment, and electronic, call or go on-line for the nearest **Sears Parts and Repair Center.**

1-800-488-1222 Anytime, day or night (U.S.A.)
www.sears.com

To purchase a protection agreement (U.S.A.) or maintenance agreement (Canada) on a product serviced by Sears:

1-800-827-6655 (U.S.A.) **1-800-361-6665** (Canada)

Para pedir servicio de reparación a domicilio, y para ordenar piezas:

1-888-SU-HOGARSM
(1-888-784-6427)

Au Canada pour service en français:

1-800-LE-FOYER^{MC}
(1-800-533-6937)
www.sears.ca



© Sears, Roebuck and Co.

® Registered Trademark / ™ Trademark / SM Service Mark of Sears, Roebuck and Co.

® Marca Registrada / ™ Marca de F-brica / SM Marca de Servicio de Sears, Roebuck and Co.

^{MC} Marque de commerce / ^{MD} Marque déposée de Sears, Roebuck and Co.

Free Manuals Download Website

<http://myh66.com>

<http://usermanuals.us>

<http://www.somanuals.com>

<http://www.4manuals.cc>

<http://www.manual-lib.com>

<http://www.404manual.com>

<http://www.luxmanual.com>

<http://aubethermostatmanual.com>

Golf course search by state

<http://golfingnear.com>

Email search by domain

<http://emailbydomain.com>

Auto manuals search

<http://auto.somanuals.com>

TV manuals search

<http://tv.somanuals.com>