

Operator's Manual

CRAFTSMAN®

5.0 Amp Variable Speed Orbital Sabre Saw

Model No.
320.2190

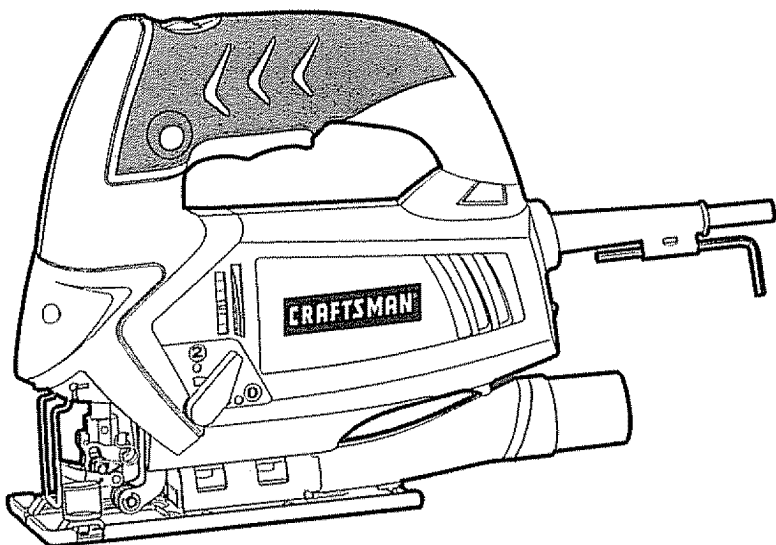

⚠ CAUTION Read, understand and follow all Safety Rules and Operating Instructions in this Manual before using this product.

Sears Brands Management Corporation
Visit our Craftsman website: www.craftsman.com

- WARRANTY
- SAFETY
- UNPACKING
- DESCRIPTION
- ASSEMBLY
- OPERATION
- ADJUSTMENTS
- MAINTENANCE

TABLE OF CONTENTS

Warranty	Page 2
Safety Symbols	Page 3
Safety Instructions	Pages 4-9
Glossary of Terms	Pages 9-10
Unpacking	Pages 10-11
Description	Pages 11-12
Assembly	Pages 13-14
Operation	Pages 14-20
Maintenance	Pages 20-21
Accessories	Page 21
Exploded View and Part List	Page 22-23
Sears Repair Parts Phone Numbers	Back Cover

CRAFTSMAN FULL WARRANTY

If this Craftsman product fails to provide complete satisfaction within one year from the date of purchase, return it to any Sears store, or other Craftsman outlet in the United States for free replacement.

This warranty does not include expendable parts such as blades.

This warranty applies for only 90 days from the date of purchase if this product is ever used for commercial or rental purposes.

This warranty gives you specific legal rights, and you may also have other rights which vary from state to state.

Sears, Roebuck and Co., Hoffman Estates, IL 60179

⚠ WARNING: Some dust created by using power tools contains chemicals known to the state of California to cause cancer and birth defects or other reproductive harm.

**SAVE THESE INSTRUCTIONS!
READ ALL INSTRUCTIONS!**

SAFETY SYMBOLS

The purpose of safety symbols is to attract your attention to possible dangers. The safety symbols, and the explanations with them, deserve your **careful attention and understanding**. The symbol warnings **DO NOT** by themselves eliminate any danger. The instructions and warnings they give are no substitutes for proper accident prevention measures.

 **WARNING:** BE SURE to read and understand all safety instructions in this manual, including all safety alert symbols such as "DANGER", "WARNING" and "CAUTION", BEFORE using this saw. Failure to follow all instructions listed below may result in electric shock, fire and/or serious personal injury.

SYMBOL MEANING

 **SAFETY ALERT SYMBOL:** Indicates DANGER, WARNING, OR CAUTION. May be used in conjunction with other symbols or pictographs.

 **DANGER**

DANGER: Failure to obey this safety warning **WILL** result in death or serious injury to yourself or to others. Always follow the safety precautions to reduce the risk of fire, electric shock and personal injury.

 **WARNING**

Failure to obey this safety warning **CAN** result in death or serious injury to yourself or to others. Always follow the safety precautions to reduce the risk of fire, electric shock and personal injury.

 **CAUTION**

Failure to obey this safety warning **MAY** result in personal injury to yourself or others or property damage. Always follow the safety precautions to reduce the risk of fire, electric shock and personal injury.

DAMAGE PREVENTION AND INFORMATION MESSAGES

These inform user of important information and/or instructions that could lead to equipment or other property damage if not followed. Each message is preceded by the word "NOTE:" as in the example below:

NOTE: Equipment and/or property damage may result if these instructions are not followed.



 **WARNING:** The operation of any sabre saw can result in foreign objects being thrown into your eyes, which can result in severe eye damage. Before beginning power tool operation, **ALWAYS** wear safety goggles or safety glasses with side shield and a full-face shield when needed. We recommend a Wide Vision Safety Mask for use over eyeglasses or standard safety glasses with side shield, available at Sears Stores or other Craftsman Outlets.

SAFETY INSTRUCTIONS

⚠ WARNING: BE SURE to read and understand all instructions in this manual before using this sabre saw. Failure to follow all instructions may result in electric shock, fire and/or serious personal injury.

WORK AREA SAFETY

1. **Keep your work area clean and well lit.** Cluttered workbenches and dark areas invite accidents.
2. **DO NOT operate power tools in explosive atmospheres, such as in the presence of flammable fluids, gases, or dust.** Power tools create sparks which may ignite the dust or fumes.
3. **Keep bystanders, children and visitors away while operating a power tool.** Distractions can cause you to lose control.
4. **Make your workshop childproof** with padlocks and master switches. Lock tools away when not in use.
5. **MAKE SURE the work area has ample lighting** so you can see the work and that there are no obstructions that will interfere with safe operation **BEFORE** using your saw.

PERSONAL SAFETY

1. **KNOW your power tool.** Read the operator's manual carefully. Learn the saw's applications and limitations, as well as the specific potential hazards related to this tool.
2. **STAY ALERT,** watch what you are doing and use common sense when operating a power tool.
3. **DO NOT** use tool while tired or under the influence of drugs, alcohol or medication. A moment of inattention while operating power tools may result in serious personal injury.
4. **DRESS properly. DO NOT** wear loose clothing or jewelry. Pull back long hair. Keep your hair, clothing, and gloves away from moving parts. Air vents often cover moving parts and should also be avoided. Loose clothing, jewelry or long hair can be caught in moving parts.
5. **AVOID** accidental starting. Be sure switch is in "OFF" position before plugging in. **DO NOT** carry tools with your finger on the switch. Carrying tools with your finger on the switch or plugging in tools that have the switch in the "ON" position invites accidents.
6. **REMOVE** adjusting keys or wrenches before turning the tool "ON". A wrench that is left attached to a rotating part of the tool may result in personal injury.
7. **Do not overreach. Keep proper footing and balance at all times.** Proper footing and balance enables better control of the tool in unexpected situations.
8. **ALWAYS SECURE YOUR WORK.** Use clamps or a vise to hold work when practical. It is safer than using your hand and frees both hands to operate tool.
9. **USE SAFETY EQUIPMENT.** Always wear eye protection. Dust mask, non-skid safety shoes, hard hat, or hearing protection must be used for appropriate conditions.
10. **DO NOT USE ON A LADDER or unstable support.** Stable footing on a solid surface enables better control of the tool in unexpected situations.

SAFETY INSTRUCTIONS cont.

TOOL USE AND CARE SAFETY

⚠ WARNING: BE SURE to read and understand all instructions before operating this saw. Failure to follow all instructions listed below may result in electric shock, fire and/or serious personal injury.

- 1 ALWAYS use clamps or other practical ways to secure and support the workpiece to a stable platform. Holding the work by hand or against your body is unstable and may lead to loss of control.
- 2 DO NOT force the tool. Use the correct tool and blade for your application. The correct tool and blade will do the job better and safer at the rate for which it is designed.
3. DO NOT use the tool if switch does not turn it "On" or "Off". Any tool that cannot be controlled with the switch is dangerous and must be repaired.
- 4 DISCONNECT the plug from the power source before making any adjustments, changing accessories or storing the tool. Such preventive safety measures reduce the risk of starting the tool accidentally.
- 5 NEVER leave the tool running. ALWAYS turn it off. DO NOT leave the tool until it comes to a complete stop.
- 6 STORE idle tools out of the reach of children and other untrained persons. Tools are dangerous in the hands of untrained users.
- 7 MAINTAIN tools with care. Keep cutting tools sharp and clean. Properly maintained tools with sharp cutting edges are less likely to bind and are easier to control.
- 8 CHECK for misalignment or binding of moving parts, breakage of parts, and any other condition that may affect the tool's operation. If damaged, have the tool serviced before using. Many accidents are caused by poorly maintained tools.
- 9 USE ONLY accessories that are recommended for this tool. Accessories that may be suitable for one tool may become hazardous when used on another tool.
- 10 Keep handles dry, clean, and free from oil and grease.

ELECTRICAL SAFETY

⚠ WARNING: Do not permit fingers to touch the terminals of plug when installing or removing the plug from the outlet.

- 1 Double insulated tools are equipped with a polarized plug (one blade is wider than the other). This plug will fit in a polarized outlet only one way. If the plug does not fit fully in the outlet, reverse the plug. If it still does not fit, contact a qualified electrician to install a polarized outlet. Do not change the plug in any way.
- 2 Double insulation eliminates the need for the three-wire grounded power cord and grounded power supply system. Applicable only to Class II (double-insulated) tools. This sabre saw is a double insulated tool.

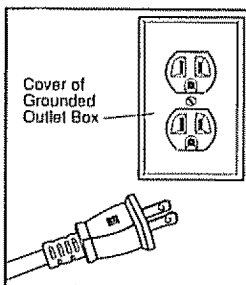

SAFETY INSTRUCTIONS cont.

ELECTRICAL SAFETY cont.

⚠ WARNING: Double insulation **DOES NOT** take the place of normal safety precautions when operating this tool.

- BEFORE** plugging in the tool, **BE SURE** that the outlet voltage supplied is within the voltage marked on the tool's data plate. **DO NOT** use "AC only" rated tools with a DC power supply.
- AVOID** body contact with grounded surfaces, such as pipes, radiators, ranges and refrigerators. There is an increased risk of electric shock if your body is grounded.
- DO NOT** expose power tools to rain or wet conditions or use power tools in wet or damp locations. Water entering a power tool will increase the risk of electric shock.
- INSPECT** tool cords for damage. Have damaged tool cords repaired at a Sears Service Center. **BE SURE** to stay constantly aware of the cord location and keep it well away from the moving blade.
- DO NOT** abuse the cord. **NEVER** use the cord to carry the tool by or pull the plug from the outlet. Keep cord away from heat, oil, sharp edges or moving parts. Replace damaged cords immediately. Damaged cords increase the risk of electric shock.

EXTENSION CORDS

Use a proper extension cord. **ONLY** use cords listed by Underwriters Laboratories (UL). Other extension cords can cause a drop in line voltage, resulting in a loss of power and overheating of tool. For this tool an AWG (American Wire Gauge) size of at least 14-gauge is recommended for an extension cord of 25-ft. or less in length. Use 12-gauge for an extension cord of 50-ft. Extension cords 100-ft. or longer are not recommended. Remember, a smaller wire gauge size has greater capacity than a larger number (14-gauge wire has more capacity than 16-gauge wire; 12-gauge wire has more capacity than 14-gauge). When in doubt use the smaller number.

When operating a power tool outdoors, use an outdoor extension cord marked "W-A" or "W". These cords are rated for outdoor use and reduce the risk of electric shock.





⚠ CAUTION: Keep the extension cord clear of the working area. Position the cord so that it will not get caught on lumber, tools or other obstructions while you are working with a power tool.

⚠ WARNING: Check extension cords before each use. If damaged replace immediately. Never use tool with a damaged cord since touching the damaged area could cause electrical shock, resulting in serious injury.

SAFETY INSTRUCTIONS cont.

SAFETY SYMBOLS FOR YOUR TOOL

The label on your tool may include the following symbols.

V	Volts
A	Amps
Hz	Hertz
W	Watts
min	Minutes
	Alternating current
	Direct current
n_0	No-load speed
 /min	Class II construction, Double Insulated Revolutions or Strokes per minute
	Indicates danger, warning or caution. It means attention! Your safety is involved.

SERVICE SAFETY

- 1 If any part of this saw is missing or should break, bend, or fall in any way; or should any electrical component fail to perform properly: **SHUT OFF** the power switch and remove the saw plug from the power source and have the missing, damaged or failed parts replaced **BEFORE** resuming operation
- 2 Tool service must be performed only at a Sears Parts and Repair Center. Service or maintenance performed by unqualified personnel could result in a risk of injury.
- 3 When servicing a tool, use only identical replacement parts. Follow instructions in the maintenance section of this manual. Use of unauthorized parts or failure to follow maintenance instructions may create a risk of electric shock or injury.

SAFETY RULES FOR SABRE SAWS

⚠ DANGER Keep hands away from cutting area and blade. Keep one hand on the handle/trigger switch and your other on the front, top of the saw's handle/motor housing. If both hands are holding the saw, the blade cannot cut them.

⚠ CAUTION: Blades coast after saw is switched off.

- 1 **KEEP** your body positioned to either side of the saw blade and not in direct line with the saw blade.
- 2 **DO NOT** reach under the workpiece. The blade extends under the workpiece when saw is cutting.
- 3 **DO NOT** touch the blade or the workpiece immediately after operation; they may be extremely hot and could burn your skin.
- 4 **DO NOT** cut an oversized workpiece.
- 5 **CHECK** for the proper clearance under the workpiece before cutting so that the blade will not strike the workbench or material under the workpiece.

SAFETY INSTRUCTIONS cont.

SAFETY RULES FOR SABRE SAWS cont.

- 6 **MAKE SURE** the blade is not contacting the workpiece before the switch is turned on.
- 7 **HOLD TOOL** by insulated gripping surfaces (handles) when performing an operation where the cutting tool may contact hidden wiring or its own cord. Contact with a "live" wire will make the exposed metal parts of the tool "live" and shock the operator.
- 8 **SECURE MATERIAL** before cutting. Never hold a workpiece in your hand or across your legs. Small or thin material may flex or vibrate with the blade, causing loss of control.
- 9 When ripping, **ALWAYS USE** a rip fence or straight edge guide. This improves the accuracy of the cut and reduces the chance of the blade binding.
- 10 **NEVER** cut more than one piece at a time. **DO NOT STACK** more than one workpiece on the worktable at a time.
- 11 **AVOID** awkward operations and hand positions where a sudden slip could cause your hand to move into the blade.
- 12 **NEVER** reach into the cutting path of the blade.
- 13 **BLADE GUIDE ROLLERS** must support the blade when cutting. The rollers must rest against the back edge of blade. **THE ONLY** cutting operation when rollers **DO NOT** support the blade is the scrolling mode. **WHEN SCROLLING** the blade must swivel as it is guided to follow scroll patterns. **ALWAYS** move the base back and blade guide up and back away from blade in scrolling mode.
- 14 **ALWAYS** use blades that have the correct size and shape. Blades that do not match the mounting hardware of the saw will run erratically and will cause loss of control.
- 15 **ALWAYS BE SURE** that all adjusting screws and the blade holder are fastened lightly **BEFORE** making a cut. Loose adjusting screws can cause the tool to slip and loss of control may result.

⚠ WARNING: Use of this tool can generate dust containing chemicals known to cause cancer, birth defects or other reproductive harm. Some examples of these chemicals are:

- Lead from lead-based paints.
- Crystalline silica from bricks and cement and other masonry products.
- Arsenic and chromium, from chemically treated lumber.

Your risk from these exposures varies, depending upon how often you do this type of work. To reduce your exposure to these chemicals:

- Work in a well-ventilated area.
- Work with approved safety equipment, such as those dust masks that are specially designed to filter out microscopic particles.

Avoid prolonged contact with dust from power sanding, sawing, grinding, drilling and other construction activities. Wear protective clothing and wash exposed areas with soap and water.

Allowing dust to get into your mouth, eyes, or lay on the skin may promote absorption of harmful chemicals.

⚠ WARNING: Use of this tool can generate and/or disburse dust, which may cause serious and permanent respiratory or other injury. Always use NIOSH/OSHA approved respiratory protection appropriate for the dust exposure. Direct particles away from face and body.

SAFETY INSTRUCTIONS cont.

ADDITIONAL RULES FOR SAFE OPERATION

⚠ WARNING: BE SURE to read and understand all instructions. Failure to follow all instructions listed below may result in electric shock, fire and/or serious personal injury.

1. **Know your power tool. Read operator's manual carefully.** Learn the applications and limitations, as well as the specific potential hazards related to this tool. Following this rule will reduce the risk of electric shock, fire or serious injury
2. **ALWAYS wear safety glasses or eye shields when using this saw.** Everyday eyeglasses have only impact-resistant lenses; they are **NOT** safety glasses.
3. **PROTECT your lungs.** Wear a face mask or dust mask if the operation is dusty.
4. **PROTECT your hearing.** Wear appropriate personal hearing protection during use. Under some conditions noise from this product may contribute to hearing loss.
5. **ALL VISITORS AND BYSTANDERS MUST** wear the same safety equipment that the operator of the saw wears.
6. **INSPECT the tool cords periodically and if damaged have them repaired at your nearest Sears Service Center. BE AWARE of the cord location.**
7. **ALWAYS check the tool for damaged parts.** Before further use of the tool, a guard or other part that is damaged should be carefully checked to determine if it will operate properly and perform its intended function. Check for misalignment or binding of moving parts, breakage of parts, and any other condition that may affect the tool's operation. A guard or other part that is damaged should be properly repaired or replaced at a Sears Service Center.
8. **INSPECT and remove all nails from lumber before sawing.**
9. **SAVE THESE INSTRUCTIONS.** Refer to them frequently and use them to instruct others who may use this tool. If someone borrows this tool, make sure they have these instructions also.

GLOSSARY OF TERMS FOR WOODWORKING

Saw Blade Path

The area over, under, behind or in front of the blade, as it applies to the workpiece. That area which will be or has been cut by the blade.

Set

The distance that the saw blade tooth is bent (or set) outward from the face of the blade.

Strokes per Minute or Stroke Speed

The blade speed of a sabre saw, which can be varied, usually from 800 to 3000 strokes per minute.

Cross cut

A cutting or shaping operation made against the grain of the work piece

Bevel Cut

A cutting operation made with the blade at any angle other than 90° to the base

Ripping or Rip Cut

A cutting operation along the length of the workpiece

GLOSSARY OF TERMS FOR WOODWORKING cont.

Freehand Cut

Performing a cut without using a fence, miter gauge, fixture, work clamp, or other proper device to keep the workpiece from twisting or moving during the cut.

Orbital Sawing

In addition to the up and down movement of a sabre saw's blade, there is orbital action which thrusts the blade forward on the cutting stroke and greatly increases the cutting speed over conventional sabre saws.

Scrolling

Allows the blade to swivel for intricate pattern cutting.

Through Sawing

Any cutting operation where the blade extends completely through the thickness of the workpiece.

Kerf

The material removed by the blade in a through cut or the slot produced by the blade in a non-through or partial cut.

Workpiece or Material

The item on which the cutting operation is being done. The surfaces of a workpiece are commonly referred to as faces, ends and edges.

Gum

A sticky, sap-based residue from wood products.

Resin

A sticky, sap-based substance that has hardened.

UNPACKING

 **WARNING:** Your saw should NEVER be connected to the power source when you are assembling parts, making adjustments, installing or removing blades, cleaning or when it is not in use. Disconnecting the saw will prevent accidental starting, which could cause serious personal injury.

1. The **Two Blades** are stored in the blade storage compartment located in the rear of the saw's base.
2. The **Vac Adapter** is attached to the saw.
3. Carefully lift the saw out of the color box and place on a stable flat surface.
4. Inspect the saw carefully to make sure that no breakage or damage has occurred during shipping. If any of the items mentioned are missing (refer to Fig. 1 on page 11) return the saw to your nearest Sears store or Craftsman outlet to have the saw replaced.

 **WARNING:** If any parts are broken or missing, **DO NOT** attempt to plug in the power cord or operate saw until the broken or missing parts are replaced. Failure to do so could result in possible serious injury.

UNPACKING cont.

PARTS LIST (Fig. 1)

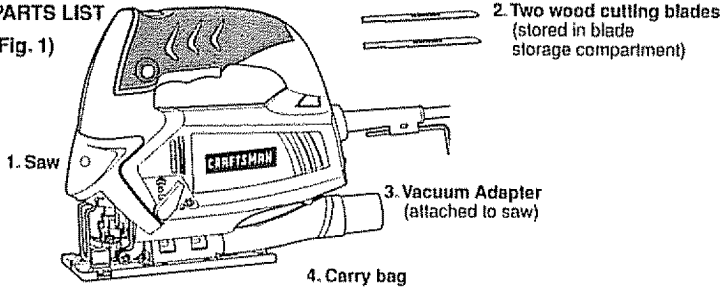

DESCRIPTION

KNOW YOUR SABRE SAW (Fig. 2)

NOTE: Before attempting to use your saw, familiarize yourself with all of the operating features and safety requirements.

Your sabre saw has a precision built electric motor and it should only be connected to a 120-volt, 60-Hz AC ONLY power supply (normal household current). **DO NOT** operate on direct current (DC). This large voltage drop will cause a loss of power and the motor will overheat. If the saw does not operate when plugged into a correct 120-volt, 60-Hz AC ONLY outlet, check the power supply. This saw has an 8-ft. 2-wire power cord (no adapter needed).

This Sabre Saw has the following features:

1. 5.0 Amp, Variable Speed Motor, 800 to 3000 SPM strokes per minute (no-load speed).
2. Variable Speed is controlled by the speed dial located on the top front of the trigger switch handle
3. 3 Position Orbital Action
4. Blade Guide Support Roller provides added blade control 11/16 inch blade stroke for smooth cutting.
5. Durable Epoxy Coated Steel Base glides smoothly over workpiece. Bevel scale for easy adjustments.
6. Bevel Cutting Capacity 0° to 45° left and right.
7. Quick Blade Changes with No Tools.
8. LED Worklight illuminates cutting area.
9. "Live Tool Indicator" Light is green when saw is plugged into power source
10. Extended Length Trigger Switch with Power Lock-On Button.
11. Sawdust Removal: Vacuum adapter on bottom of saw attaches to 1 1/4-inch adapter and then to wet/dry vac (both sold separately) for removal of sawdust and chips from the cutting area.
12. Permanently Lubricated 100% Ball Bearings for smooth operation, long life.
13. Includes carry bag for easy carrying and storage.

DESCRIPTION cont.

This Sabre Saw has the following features: cont. (Fig. 2)

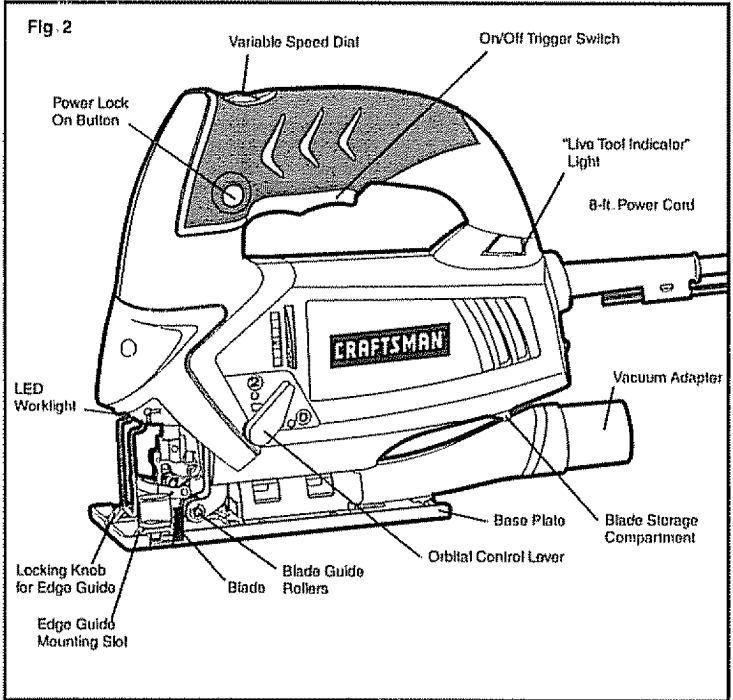

PRODUCT SPECIFICATIONS	
Rating	5.0 Amps
No Load Speed	800 - 3000 SPM (strokes per min.)
Input	120-volts, 60-Hz AC
Bevel Cutting Angle Range	0° to 45° left and right
Blade Stroke	1 1/16-Inch
Cutting Depth in Wood	2 3/16-in. (55mm)
Cutting Depth in Steel	1/4-in. (6mm)

ASSEMBLY

BLADE STORAGE (Fig. 3 and 4)

Your sabre saw comes with 2 wood cutting blades that are stored in the blade storage compartment located on the very back of the saw under the power cord inlet (see Fig. 3).

To open blade storage door, remove the vac adapter tube (see Fig. 4). Lift the vac adapter tube up slightly (to release tab from base plate) and pull vac adapter tube straight out to remove. Pull tab on blade storage door down to open and turn saw upside down to remove blades (see Fig. 3).

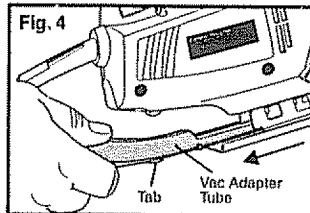
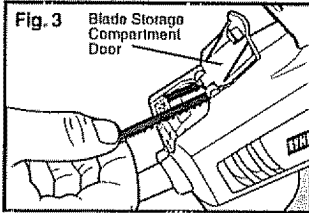

Remember to always use the proper blade for the material being cut.

TOOL-LESS BLADE INSTALLATION (Fig. 5, 6 and 7)

Tool-less blade change allows you to remove and replace the saw blade quickly and easily without the use of additional tools.

1. Unplug the saw

⚠ WARNING: ALWAYS unplug saw from the power source before changing blades or making any adjustments. Failure to unplug the saw could result in accidental starting which can cause serious personal injury.

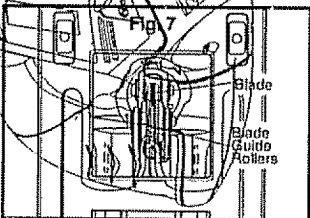
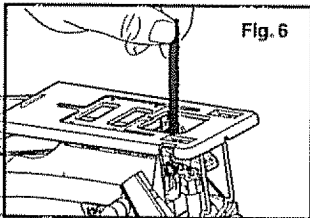
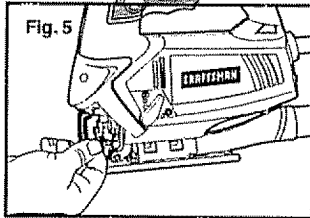

2. Turn the saw upside down so you can access to the blade clamp
3. Lift the tool-less blade-change lever up (Fig. 7a), then insert the blade into the slot of tool-less blade change holder (Fig. 7b). The teeth of the blade should be facing to the front and pointing up (when saw is right side up, in cutting position), and the back of the blade must rest in the groove of the blade guide rollers
4. Release the tool-less blade-change lever to lock the blade.
5. Pull the blade to make sure it is securely locked in place.

ASSEMBLY cont.

TOOL-LESS BLADE INSTALLATION cont.

6. Pull down on the blade to make sure the blade is securely locked in place.

NOTE: For use with both "T" and "U" shanked blades.

⚠ CAUTION: Once the blade is installed in the saw, it is always exposed. There is no lower blade guard. Use caution when handling the saw so that the blade does not catch clothing, skin, etc. Each time you set the saw down take care not to bend the blade. Always set saw down on its side when blade is installed. ALWAYS remove blade when saw is not being used.

REMOVING THE BLADE

1. Unplug the saw.

⚠ WARNING: ALWAYS unplug saw from the power source before changing blades or making any adjustments. Failure to unplug the saw could result in accidental starting which can cause serious personal injury.

2. Follow steps 1 through 4 on the tool-less blade installation (see pages 13 and 14).
3. Carefully remove the blade (or change the blade).

NOTE: When storing your saw, ALWAYS remove the cutting blade.

OPERATION

LED WORKLIGHT (Fig. 8)

Your sabre saw has an LED worklight that turns "ON" automatically when the saw is plugged into a power source. The light helps provide easy visibility of the cutting line.

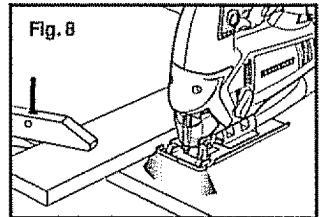

"LIVE TOOL INDICATOR" LIGHT (Fig. 9)

Your saw has a "Live Tool Indicator" green light that turns "ON" automatically when the saw is plugged into a power source. The light is located on both sides of the base of the trigger-switch handle near the body of the saw.

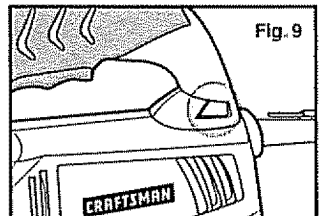

OPERATION cont.

POWER ON-OFF TRIGGER SWITCH and POWER "LOCK-ON" BUTTON

1. Connect the plug of your saw to a standard household power outlet.
2. Start the tool by squeezing the **on/off trigger switch** (see Fig. 10)
3. To stop the tool, release the **on/off trigger switch**.
4. To lock the **on/off trigger switch** in the "on" position, press trigger switch and while holding it "on", press in the **lock-on button**, located on the left side of the handle (see Fig. 10)
5. The power lock-on button allows the operator to keep the sabre saw running without squeezing the trigger switch. This is useful for continuous sawing applications.
6. To release the power lock-on button, press and release the trigger switch. This will turn the tool off.

⚠ WARNING: If the lock-on button is continuously being depressed, the trigger switch cannot be released.

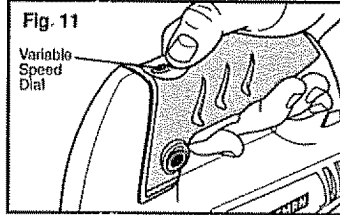
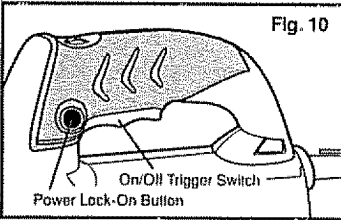

ADJUSTING THE CUTTING SPEED WITH THE VARIABLE SPEED DIAL (Fig. 11)

The variable speed feature of this saw allows you to match the proper cutting speed to the material being cut, enhancing the overall performance of your saw and helping to save the blades from undue wear.

The speeds can be adjusted from 800 to 3000 SPM (strokes per minute) no-load speed, by adjusting the variable speed dial located on top of the trigger switch handle.

The speed dial is numbered "1" through "6", with number "1" the slowest speed and number "6" the fastest speed (see Fig. 11).

The proper blade speed will differ depending on the type and thickness of the workpiece.

As a general rule, slower speeds are for denser materials and faster speeds are for soft materials.

High speeds will allow you to cut workpieces faster, but blade life will be reduced.

The following chart can help you pick the proper speed.

Workpiece to be cut	Number on Variable Speed Dial
Wood	5-6
Mild Steel	3-6
Stainless Steel	3-4
Aluminum	3-6
Plastics	2-5

Remember to **ALWAYS** use the proper cutting blade for the cutting application and the material you are cutting.

OPERATION cont.

ORBITAL ACTION (Fig. 12)

This saw has an orbital control lever (see Fig. 12) that regulates the three cutting modes of the saw. Positions "1", "2" and "0". The orbital blade action thrusts the blade forward on the cutting stroke (see position 1 and 2), and greatly increases the cutting speed over the normal up and down blade action of position 0

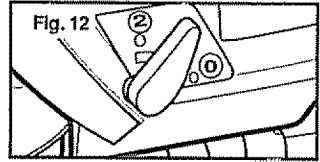

POSITION 2 is for maximum orbital action (MOST AGGRESSIVE)

POSITION 1 is for minimum orbital action (LEAST AGGRESSIVE)

POSITION 0 is normal up and down blade motion of sabre saw (NO ORBITAL ACTION).

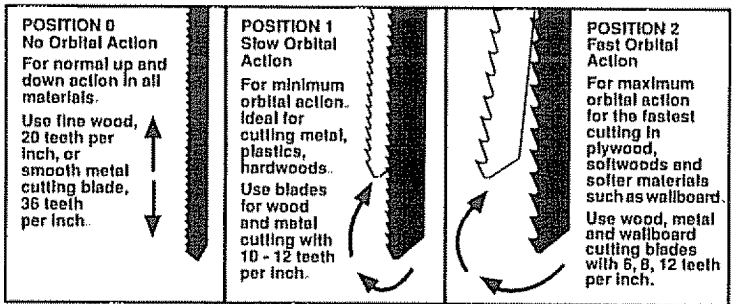

ALWAYS test the cutting modes on a piece of scrap material before making your finished cut.

NOTE: Select the right blade for your cutting application. Blades are available for fine woodcutting, medium and fast woodcutting, and fast metal or smooth metal cutting. A general guide to use when selecting a blade is: The more teeth per inch on the blade, the smoother the cuts, and the less teeth per inch on the blade, the faster and rougher the cuts.

See page 21, ACCESSORIES, for more information on selecting the right blade for the job.

SAWDUST REMOVAL (Fig. 13)

⚠ WARNING: ALWAYS unplug saw from the power source BEFORE making any adjustments or attaching accessories.

Your sabre saw comes with a 1/4-inch vac adapter tube that can be attached to a wet/dry vac hose with a 1/4-inch hose adapter and then to a wet/dry vac (all sold separately).

This will help remove dust, chips and cutting debris away from the cutting area

The vac adapter tube will need to be removed from the saw for access to blade storage compartment and when setting and cutting bevels. To remove the vac adapter tube, lift up to release tab from saw's base and pull straight out. To re-attach, just slide back into position and engage tab

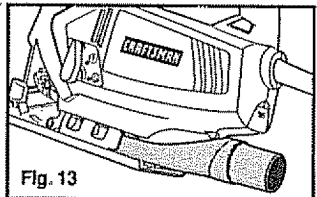

OPERATION cont.

GENERAL CUTTING TIPS

1. Always place the best or "finished" side of your workpiece "face down" so it does not get scraped or abused while sawing. **ALWAYS CLAMP** workpiece securely before sawing.
2. Draw your cutting lines, patterns or designs on the "backside" facing you. **This means they would be reversed or backwards from the way they will appear on the "finished" side.**
3. Always select the correct blade type for your cutting application.
4. Place front edge of saw base on the material to be cut and line up the blade with your cutting line.
5. Hold saw firmly and turn it on. Let blade reach selected speed before starting cut.
6. Press down (to keep saw base flat against the workpiece) as you slowly push the saw in the direction of the cut.
7. Gradually build up the blade speed, cutting as close to the line as possible (unless you want to leave enough room for finished sanding).
8. As you cut, you may need to reposition the vise or clamps to keep the workpiece stable.
9. **DO NOT** force the saw because the blade teeth may rub and wear without cutting, which may result in breaking the blade.
10. Let the saw do most of the work.
11. **ALWAYS** cut slowly when following curves, so the blade can cut through cross grain. This will provide an accurate cut and will prevent the blade from wandering.

NOTE: ALWAYS apply a steady firm "DOWN" pressure on the front and body of the saw as you cut. This will keep the saw blade from JUMPING out of the workpiece.

⚠ WARNING: ALWAYS clamp and support workpiece securely. ALWAYS maintain proper control of saw. Failure to clamp and support workpiece and loss of control of saw could result in serious injury.

CUTTING METAL

When cutting metal **ALWAYS** clamp down the metal workpiece and **ALWAYS** use a **METAL** cutting blade. Be extremely careful to move the saw very slowly as you cut. Use the **LOW** speeds (Position 1, 2 or 3 on the variable speed dial). Also use the **"LOW"** position on the orbital control lever. **DO NOT** twist, bend or force the blade. If the saw jumps or bounces as you cut, change to a blade with finer teeth. If the blade begins to clog when cutting soft metal, change to a blade with coarser teeth.

For easier cutting, lubricate the blade with a stick of cutting wax (if available) or cutting oil when cutting steel. Thin metal should be sandwiched between two pieces of wood or tightly clamped on a single piece of wood (wood on top of the metal). Draw the cut lines or design on the top piece of wood.

When cutting aluminum extrusion or angle iron, clamp the work in a bench vise and saw close to the vise jaws.

When sawing tubing with a diameter larger than the blade is deep, cut through the wall of the tubing and then insert the blade into the cut, rotating the tube as you saw.

1. When cutting metals, a suitable cooling / cutting oil must be used.
2. Spread the oil onto the blade or workpiece at regular intervals during cutting in order to reduce wear or overheating of the blade.
3. Don't make bevel cut when cutting metal.

⚠ WARNING: ALWAYS unplug saw from the power source BEFORE making any adjustments or attaching accessories.

OPERATION cont.

CUTTING WITH A STRAIGHTEDGE (Fig. 14)

- 1 Mark the position of the side edge of the saw base and then clamp the straightedge on the mark and parallel to the cut.
- 2 As you cut, keep the saw base edge flush against the straightedge and flat on the workpiece

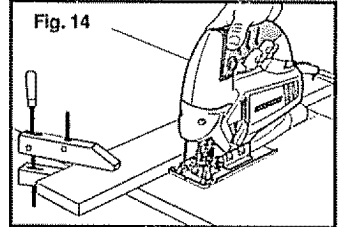

⚠ WARNING: ALWAYS clamp and support workpiece securely. ALWAYS maintain proper control of saw. Failure to clamp and support workpiece and loss of control of saw could result in serious injury.

PLUNGE CUTTING (Fig. 15)

One of the most useful features of this type of tool is the ability to start a cut anywhere on the workpiece surface - without the need of drilling a starting hole. Plunge cutting is useful and time saving for making rough openings in soft materials. It makes it unnecessary to drill a hole for an inside or pocket cut.

- 1 Draw lines for the opening you want to cut.
- 2 Hold saw firmly and tilt it forward so only the toe of the saw base rests on the workpiece.
- 3 **MAKE SURE** that the blade is well clear of the workpiece.
- 4 Start the saw and then gradually lower the blade into the workpiece, firmly holding the toe of the saw base to prevent side wobble.
- 5 Slowly pivot the saw downward like a hinge until the blade cuts through and the base rests flat on the workpiece.
- 6 Begin sawing in the usual manner along the cut line.

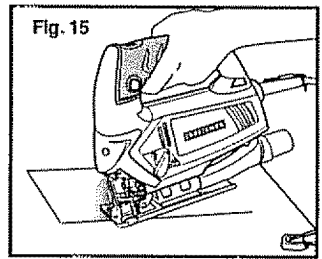

NOTE: DO NOT use a scroll blade for plunge cutting.

IMPORTANT: DO NOT try to plunge cut into hard materials, such as hardwoods like oak or maple, or metals such as steel.

TO MAKE SHARP CORNERS

- 1 Cut up to the corner, then back up slightly before rounding short of the corner.
- 2 After the opening is complete, go back to each corner and cut from the opposite direction to square it off.

OPERATION cont.

TO ADJUST BASE PLATE FOR BEVEL CUTTING (Fig. 16 and 16a)

⚠ WARNING: ALWAYS unplug saw from the power source BEFORE making any adjustments or attaching accessories.

NOTE: ALWAYS remove the blade before adjusting the cutting angle.

- 1 After removing the blade from the saw, remove the vac adapter from under the base (see Sawdust Removal, Page 16).
- 2 To adjust the cutting angle, first turn the tool upside down and use the hex key provided on the power cord to loosen the hex screws that hold the blade guide rollers/assembly and saw base in place (Fig. 16).
- 3 Move the base of the saw slightly forward and tilt it to the desired angle between 0° and 45° left or right, using the scale marked on the base bracket.
- 4 Install a cutting blade.
- 5 Slide the blade guide rollers/assembly until the blade guide rollers rest against the back edge of the blade.
- 6 Re-tighten the hex screws. For accurate work, it is necessary to make a trial cut, measure the work, and reset the angle until the correct setting is achieved (Fig. 16a).

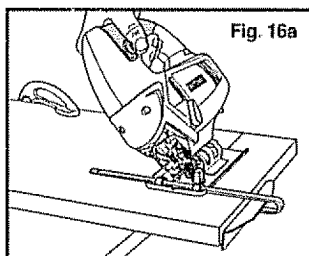
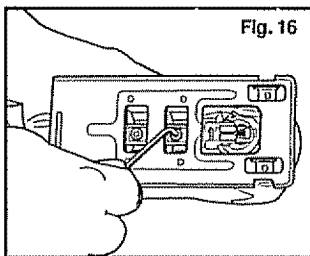

⚠ WARNING: ALWAYS clamp and support workpiece securely. ALWAYS maintain proper control of saw. Failure to clamp and support workpiece and loss of control of saw could result in serious injury.

OPERATION cont.

USING THE EDGE GUIDE (Sold separately) (Fig. 17 and 17a)

⚠ WARNING: ALWAYS unplug saw from the power source BEFORE making any adjustments or attaching accessories.

1. Insert the bar of the edge guide (sold separately) through the slots in the base of the sabre saw (see Fig. 17). The edge guide (sold separately) can be inserted from either side of the base, with the guide edge facing down.
2. Screw the edge guide (sold separately) locking knob into the threaded hole in the base to tighten the edge guide bar in place.
3. Measure the distance from the edge of the workpiece to the line of cut. Slide the edge guide (sold separately) to this desired distance and tighten the locking knob to secure edge guide (sold separately) in place (see Fig. 17a) and make your cut.

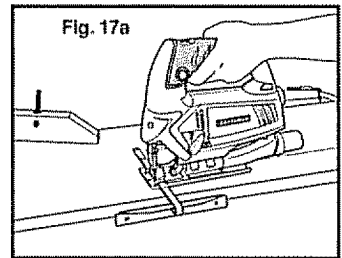
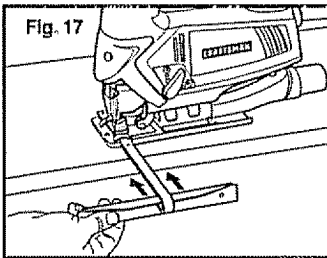

⚠ WARNING: ALWAYS clamp and support workpiece securely. ALWAYS maintain proper control of saw. Failure to clamp and support workpiece and loss of control of saw could result in serious injury.

MAINTENANCE

⚠ WARNING: Preventive maintenance performed by unauthorized personnel may result in misplacing of internal wires and components, which could cause a serious hazard.

SERVICE

1. When servicing a tool, use only identical replacement parts. Use of unauthorized parts or failure to follow maintenance instructions may create a risk of electrical shock or serious personal injury.
2. All service that requires opening the sabre saw **MUST ONLY** be performed by a Sears Service Center. All motor parts represent an important part of the double insulation system and **MUST ONLY** be serviced by a Sears Service Center. Service performed by unqualified personnel could result in a risk of injury.
3. Avoid using solvents when cleaning plastic parts. Most plastics are susceptible to damage from various types of commercial solvents and may be damaged by their use. Use clean cloths to remove dirt, carbon dust, etc.

MAINTENANCE cont.

GENERAL

⚠ WARNING: ALWAYS disconnect the tool from the power source BEFORE cleaning or performing any maintenance.

⚠ WARNING: DO NOT at any time let brake fluids, gasoline, petroleum-based products, penetrating oils, etc. come in contact with plastic parts. Chemicals can damage, weaken or destroy plastic, which may result in serious personal injury.

It has been found that electric tools are subject to accelerated wear and possible premature failure when they are used to work on fiber glass boats and sports cars, wallboard, spackling compounds or plaster. The chips and grindings from these materials are highly abrasive to electrical tool parts, such as bearings, brushes, commutators, etc. Consequently, it is not recommended that this tool be used for extended work on any fiberglass material, wallboard, spackling compound or plaster. During any use on these materials, it is extremely important that the tool is cleaned frequently by blowing with an air jet.

⚠ WARNING: Always wear safety goggles or safety glasses with side shields during power tool operations, or when blowing dust. If operation is dusty, also wear a dust mask.

LUBRICATION

All of the bearings in this tool are lubricated with a sufficient amount of high-grade lubricant for the life of the tool under normal operating conditions. Therefore, no further lubrication is required.

ACCESSORIES

⚠ WARNING: The use of attachments or accessories that are not recommended for this tool might be dangerous and could result in serious injury.

Sears and other Craftsman outlets have a large selection of Craftsman sabre saw blades designed for specific cutting applications.

Sabre saw blades are available for super fine wood scrolling, and smooth, medium and fast wood cutting. Select metal cutting blades for fast or for smooth cutting, or knife blades designed to cut vinyl, leather, rubber, cork and carpet.

There are special blades available for cutting abrasive materials such as plaster and wallboard, and most all blades are available in individual packs or variety and assorted sets.

Sears and other Craftsman outlets also offer safety equipment, sawhorses, work stands, straight edges, cutting guides and a large selection of clamps to help you with all your sawing needs.

Visit your local Sears store or other Craftsman outlets or shop www.craftsman.com

PARTS LIST

5.0 Amp ORBITAL SABRE SAW MODEL NUMBER 320.2190

The Model Number will be found on the Nameplate attached to the handle of the Sabre Saw. Always mention the Model Number when ordering parts for this tool.

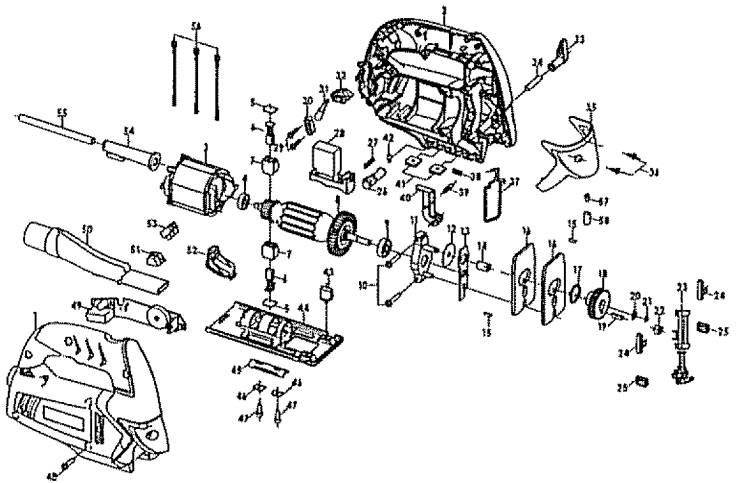

PARTS LIST

5.0 Amp ORBITAL SABRE SAW MODEL NUMBER 320.2190

The Model Number will be found on the Nameplate attached to the handle of the Sabre Saw. Always mention the Model Number when ordering parts for this tool.

No	Part No	Part Name	QTY
1	3320276000	Right Housing Assy	1
2	3320275000	Left Housing Assy	1
3	2740101000	Stator	1
4	5700004000	Ball Bearing	1
5	3700491000s	Flash Board	2
6	4960015000	Carbon Brush	2
7	2800022000	Brush Holder	2
8	2750854000	Rotor	1
9	5700005000	Ball Bearing	1
10	5610044000	Tapping Screw	2
11	2820114000	Bearing Support ASSY	1

No	Part No	Part Name	QTY
12	3700214000	Washer	1
13	3700229000	Pendulum Plate	1
14	5700184000	Needle Bearing	1
15	3550147000	Needle Pin	2
16	3700213000	Counterweight	2
17	3700147000	Washer C	1
18	3550216000	Gear	1
19	3550215000	Gear Pin	1
20	3700197000	Washer	1
21	5660004000	Circlips For Shaft	1
22	3520126000	Crank Roller	1
23	2820854000	Guiding Rod Set	1
24	3520060000	Bushing	2
25	3520061000	Sliding Block	2
26	3123014000	Switch Lock	1
27	3660245000	Spring	1
28	4870099000	Switch	1
29	5610024000	Tapping Screw	2
30	3120234000	Cord Anchorage	1
31	4540017000	Power Supply Indicator	1
32	3121733000	Left Indicator Cover	1
33	3121732000	Pendulum Lever	1
34	3700231000	Pendulum Lever Shaft	1
35	3124601001	Cover	1
36	5610021000	Tapping Screw	2
37	3650097000s	Wire Guard	1
38	3660060000	Spring	1
39	3550194000	Guiding Roller Support Axis	1
40	2821972000	Roller Support Set	1
41	3700164000	Square Nut	2
42	3550146000	Located Pin	1
43	3400175000	Knob	1
44	2821924000	Base Plate Assy	1
45	3700232000	Clamp Washer	1
46	3700149000	Square Washer	2
47	5620011000	Hexagon Socket Screw	2
48	5610106000	Tapping Screw	9
49	4900253000	Speed Adjustor	1
50	3320385000	Vaccum Adapter	1
51	3121734000	Right Indicator Cover	1
52	3121682000	Blade Cover	1
53	4930004000	Connector	1
54	3121037000	Cord Guard	1
55	4810002598	Power Cord & Plug	1
56	2820752000	Internal Wire ASSY 1	3
57	4360001000	LED	1
58	3120470000	Transparent Guard	1

Get it fixed, at your home or ours!

Your Home

For troubleshooting, product manuals and expert advice:



www.managemylife.com

For repair – in your home – of all major brand appliances, lawn and garden equipment, or heating and cooling systems, no matter who made it, no matter who sold it!

For the replacement parts, accessories and owner's manuals that you need to do-it-yourself.

For Sears professional installation of home appliances and items like garage door openers and water heaters.

1-800-4-MY-HOME®

(1-800-469-4663)

www.sears.com

Call anytime, day or night

(U.S.A. and Canada)

www.sears.ca

Our Home

For repair of carry-in items like vacuums, lawn equipment, and electronics, call anytime for the location of the nearest Sears Parts & Repair Service Center

1-800-488-1222 (U.S.A.)

www.sears.com

1-800-469-4663 (Canada)

www.sears.ca

To purchase a protection agreement on a product serviced by Sears:

1-800-827-6655 (U.S.A.)

1-800-361-6665 (Canada)

Para pedir servicio de reparación a domicilio, y para ordenar piezas:

1-888-SU-HOGAR®

(1-888-784-6427)

www.sears.com

Au Canada pour service en français:

1-800-LE-FOYER^{MC}

(1-800-533-6937)

www.sears.ca

Sears

® Registered Trademark / ™ Trademark of KCD IP, LLC in the United States, or Sears Brands, LLC in other countries

® Marca Registrada / ™ Marca de Fábrica de KCD IP, LLC en Estados Unidos, o Sears Brands, LLC in otros países

® Marque de commerce / ™ Marque déposée de Sears Brands, LLC

Free Manuals Download Website

<http://myh66.com>

<http://usermanuals.us>

<http://www.somanuals.com>

<http://www.4manuals.cc>

<http://www.manual-lib.com>

<http://www.404manual.com>

<http://www.luxmanual.com>

<http://aubethermostatmanual.com>

Golf course search by state

<http://golfingnear.com>

Email search by domain

<http://emailbydomain.com>

Auto manuals search

<http://auto.somanuals.com>

TV manuals search

<http://tv.somanuals.com>