

Panasonic®

CD Stereo System

Operating Instructions

Model No. **SC-AK58**

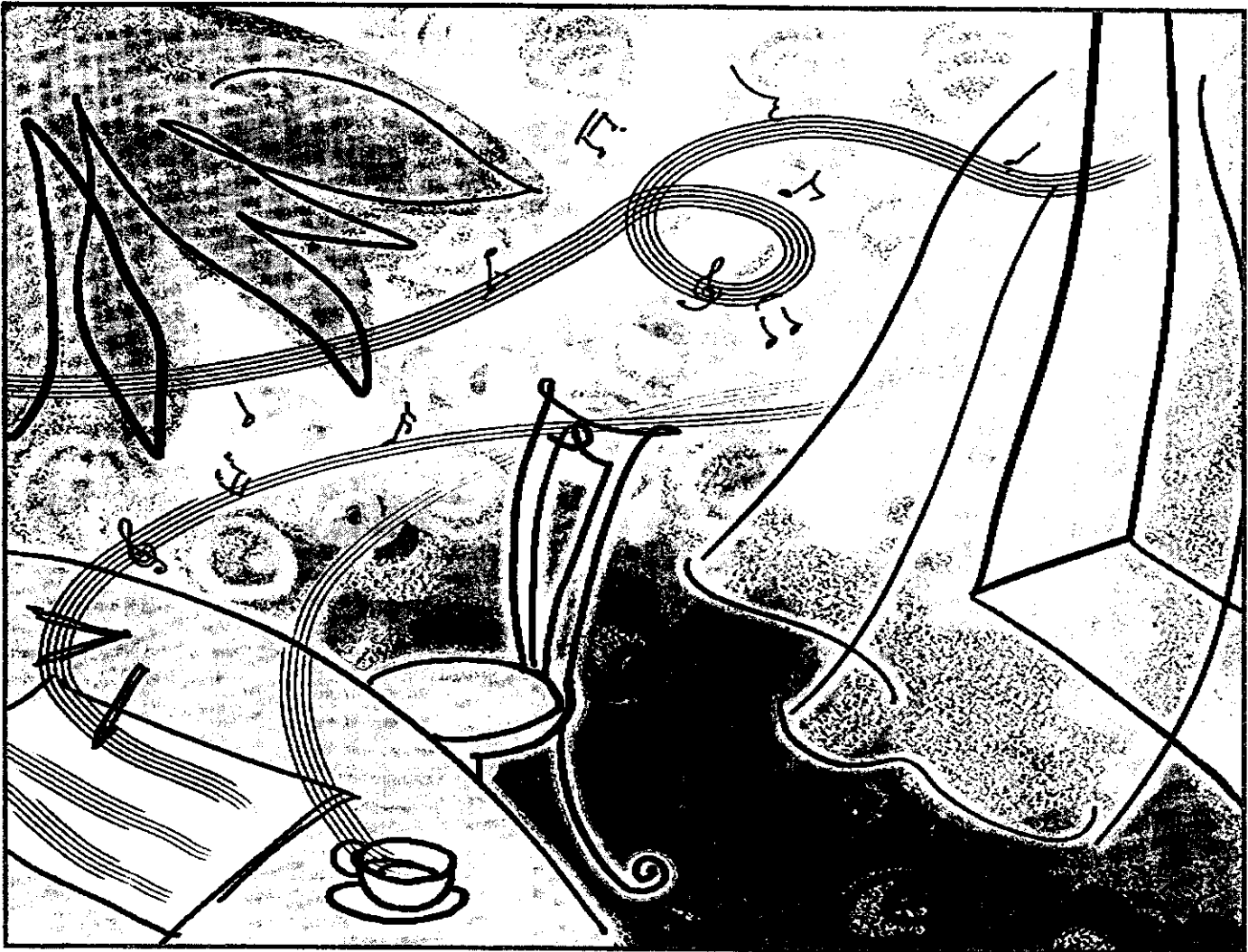
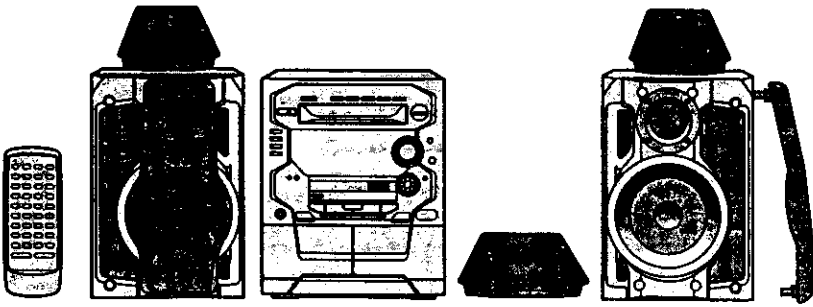

COMPACT
disc
DIGITAL AUDIO

Before connecting, operating or adjusting this product, please read these instructions completely.

Please keep this manual for future reference.

Dear customer

Thank you for purchasing this product.
For optimum performance and safety, please read these instructions carefully.

These operating instructions are applicable to the following system.

System		SC-AK58
Main unit		SA-AK58
Speakers	Front	SB-AK58
	Surround	SB-PS55
	Center	SB-PC55

Before use

The model number and serial number of this product can be found on either the back or the bottom of the unit. Please note them in the space provided below and keep for future reference.

MODEL NUMBER _____

SERIAL NUMBER _____

User memo:

DATE OF PURCHASE _____

DEALER NAME _____

DEALER ADDRESS _____

TELEPHONE NUMBER _____

CAUTION!

THIS PRODUCT UTILIZES A LASER. USE OF CONTROLS OR ADJUSTMENTS OR PERFORMANCE OF PROCEDURES OTHER THAN THOSE SPECIFIED HEREIN MAY RESULT IN HAZARDOUS RADIATION EXPOSURE. DO NOT OPEN COVERS AND DO NOT REPAIR YOURSELF. REFER SERVICING TO QUALIFIED PERSONNEL.

CAUTION:

TO PREVENT ELECTRIC SHOCK MATCH WIDE BLADE OF PLUG TO WIDE SLOT, FULLY INSERT.

Before use

Supplied accessories 2
 Precautions 4
 Concerning the remote control 5
 Placement of speakers 6
 Connections 7
 Front panel controls 10

Preparations

Turning the demo function off (DEMO) 12
 ECO mode (MODE) 12
 Setting the time 13
 Auto power-off 13

Radio operation

Presetting radio broadcasts 14
 Listening to radio broadcasts 15

CD operation

Listening to compact discs 16
 Loading and checking CDs 16
 Sequential play 17
 Random play 18
 Repeat play 18
 Direct access play 18
 Program play 19
 To listen to special CDs and tracks (CD Manager function) 20

Tape deck operation

Listening to tapes 21

Recording operation

Before recording (Deck 2 only) 22
 Recording from radio broadcasts 23
 Recording from compact discs 24
 Sequential recording 24
 To record special CDs and tracks (CD Manager function) 25
 Tape-to-tape recording 26

Supplied accessories

Please check and identify the supplied accessories. Use numbers indicated in parentheses when asking for replacement parts.
(Only for U.S.A.)
 To order accessories contact 1-800-332-5368 or web site (<http://www.panasonic.com>).



AC power supply cord (RJA0065-A) 1 pc.



Note

The included AC power supply cord is for use with this unit only. Do not use it with other equipment.

FM indoor antenna (R5A0066U) 1 pc.



Sound quality / sound field operations

Boosting the super woofer	27
Using the built-in sound quality/sound field settings	27
Varying the sound quality with the manual equalizer (Manual EQ)	28
Varying the sound quality with the acoustic image (AI) equalizer (3D AI EQ)	29
Enjoying sound with DOLBY PRO LOGIC (DOLBY PRO LOGIC)	30
To playback a Dolby Surround source with Dolby Pro Logic	30

Timer and others

Using the timer	31
Using the play timer	31
Using the record timer	32
Using the play/record timer	33
Using the sleep timer	33
Using an external unit	34
Convenient functions	34

Reference

Concerning compact discs	35
Concerning cassette tapes	35
Troubleshooting guide	36
Maintenance	37
Specifications	38
Product service	39
Servicenter List (US)	39

THE FOLLOWING APPLIES ONLY IN THE U.S.A.:

CAUTION:

This equipment has been tested and found to comply with the limits for a Class B digital device, pursuant to Part 15 of the FCC Rules.

These limits are designed to provide reasonable protection against harmful interference in a residential installation. This equipment generates, uses and can radiate radio frequency energy and, if not installed and used in accordance with the instructions, may cause harmful interference to radio communications. However, there is no guarantee that interference will not occur in a particular installation. If this equipment does cause harmful interference to radio or television reception, which can be determined by turning the equipment off and on, the user is encouraged to try to correct the interference by one of the following measures:

- Reorient or relocate the receiving antenna.
- Increase the separation between the equipment and receiver.
- Connect the equipment into an outlet on a circuit different from that to which the receiver is connected.
- Consult the dealer or an experienced radio/TV technician for help.

Any unauthorized changes or modifications to this equipment would void the user's authority to operate this device.

This device complies with Part 15 of the FCC Rules. Operation is subject to the following two conditions: (1) This device may not cause harmful interference, and (2) this device must accept any interference received, including interference that may cause undesired operation.

WARNING:

TO REDUCE THE RISK OF FIRE, ELECTRIC SHOCK OR PRODUCT DAMAGE, DO NOT EXPOSE THIS APPLIANCE TO RAIN, SPLASHING, DRIPPING OR MOISTURE.



CAUTION: TO REDUCE THE RISK OF ELECTRIC SHOCK, DO NOT REMOVE SCREWS. NO USER-SERVICEABLE PARTS INSIDE. REFER SERVICING TO QUALIFIED SERVICE PERSONNEL.



The lightning flash with arrowhead symbol, within an equilateral triangle, is intended to alert the user to the presence of uninsulated "dangerous voltage" within the product's enclosure that may be of sufficient magnitude to constitute a risk of electric shock to persons.



The exclamation point within an equilateral triangle is intended to alert the user to the presence of important operating and maintenance (servicing) instructions in the literature accompanying the appliance.

- AM loop antenna (RSA0029) 1 pc.

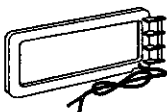

- Remote control transmitter (RAK-SC961WK) 1 pc.



- Remote control batteries 2 pcs.

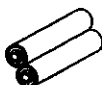

Before use

Precautions

Before using this unit please read these operating instructions carefully. Take special care to follow the warnings indicated on the unit itself as well as the safety suggestions listed below. Afterwards keep them handy for future reference.

Before use

Safety

- 1. Power Source**—The unit should be connected to power supply only of the type described in the operating instructions or as marked on the unit.
- 2. Polarization**—If the unit is equipped with a polarized AC power plug (a plug having one blade wider than the other), that plug will fit into the AC outlet only one way. This is a safety feature. If you are unable to insert the plug fully into the outlet, try reversing the plug. If the plug should still fail to fit, contact your electrician to replace your obsolete outlet. Do not defeat the safety purpose of the polarized plug.
- 3. Power Cord Protection**—AC power supply cords should be routed so that they are not likely to be walked on or pinched by items placed upon or against them. Never take hold of the plug or cord if your hand is wet, and always grasp the plug body when connecting or disconnecting it.
- 4. Nonuse Periods**—When the unit is not used, turn the power off. When left unused for a long period of time, the unit should be unplugged from the household AC outlet.

Installation

Environment

- 1. Outdoor Antenna Grounding**—If an outside antenna is connected to the receiver, be sure the antenna system is grounded so as to provide some protection against voltage surges and built-up static charges. Section 810 of the National Electrical Code, ANSI/NFPA No. 70-1990, provides information with respect to proper grounding of the mast and supporting structure, grounding of the lead-in wire to an antenna discharge unit, size of grounding conductors, location of antenna-discharge unit, connection to grounding electrodes, and requirements for the grounding electrode. See figure below.

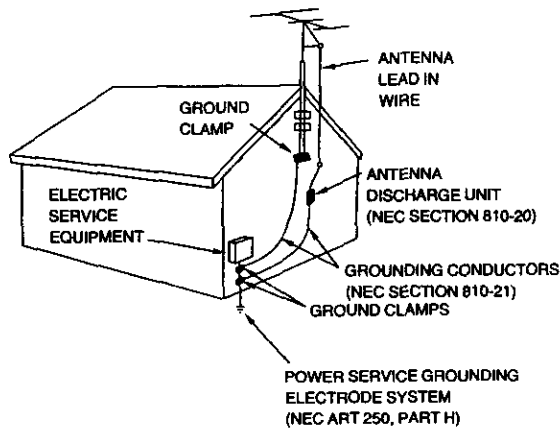

NEC—NATIONAL ELECTRICAL CODE

- 2. Water and Moisture**—Do not use this unit near water—for example, near a bathtub, washbowl, swimming pool, or the like. Damp basements should also be avoided.

- 3. Heat**—The unit should be situated away from heat sources such as radiators and the like. It also should not be placed in temperatures less than 5°C (41°F) or greater than 35°C (95°F).
- 4. Condensation**—Moisture may form on the lens in the following conditions...
 - immediately after a heater has been turned on.
 - in a steamy or very humid room.
 - when the unit is suddenly moved from a cold environment to a warm one.If moisture forms inside this unit, it may not operate properly. To correct this problem, turn on the power and wait about one hour for the moisture to evaporate.

Placement

- 1. Ventilation**—The unit should be situated so that its location or position does not interfere with its proper ventilation. Allow 10 cm (4") clearance from the rear of the unit.
- 2. Foreign Material**—Care should be taken so that objects do not fall into and liquids are not spilled into the unit. Do not subject this unit to excessive smoke, dust, mechanical vibration, or shock.
- 3. Magnetism**—The unit should be situated away from equipment or devices that generate strong magnetic fields.
- 4. Stacking**—Do not place heavy objects, other than system components, on top of the unit.
- 5. Surface**—Place the unit on a flat, level surface.
- 6. Carts and Stands**—The unit should be used only with a cart or stand that is recommended by the manufacturer. The unit and cart combination should be moved with care. Quick stops, excessive force, and uneven surfaces may cause the unit and cart combination to overturn.
- 7. Wall or Ceiling Mounting**—The unit should not be mounted to a wall or ceiling, unless specified in this operating instructions.



Maintenance

(See page 37 for details.)

Clean the cabinet, panel and controls with a soft cloth lightly moistened with mild detergent solution. Do not use any type of abrasive pad, scouring powder or solvent such as alcohol or benzene.

Service

- 1. Damage Requiring Service**—The unit should be serviced by qualified service personnel when:
 - (a) The AC power supply cord or the plug has been damaged; or
 - (b) Objects have fallen or liquid has been spilled into the unit; or
 - (c) The unit has been exposed to rain; or
 - (d) The unit does not appear to operate normally or exhibits a marked change in performance; or
 - (e) The unit has been dropped, or the enclosure damaged.
- 2. Servicing**—The user should not attempt to service the unit beyond that described in the operating instructions. All other servicing should be referred to an authorized service personnel.

For the address of an authorized servicer:
In the U.S.A. 1-800-211-7262 or web site
(<http://www.panasonic.com>)
In Canada 905-624-5505 or web site
(www.panasonic.ca)

Listening caution



Selecting fine audio equipment such as the unit you've just purchased is only the start of your musical enjoyment. Now it's time to consider how you can maximize the fun and excitement your equipment offers. This manufacturer and the Electronic Industries Association's Consumer Electronics Group want you to get the most out of your equipment by playing it at a safe level. One that lets the sound come through loud and clear without annoying blaring or distortion—and, most importantly, without affecting your sensitive hearing.

We recommend you to avoid prolonged exposure to excessive noise.

Sound can be deceiving. Over time your hearing "comfort level" adapts to higher volumes of sound. So what sounds "normal" can actually be loud and harmful to your hearing.

Guard against this by setting your equipment at a safe level BEFORE your hearing adapts.

To establish a safe level:

- Start your volume control at a low setting.
- Slowly increase the sound until you can hear it comfortably and clearly, and without distortion.

Once you have established a comfortable sound level:

- Set the dial and leave it there.

Taking a minute to do this now will help to prevent hearing damage or loss in the future. After all, we want you listening for a lifetime.

Battery installation

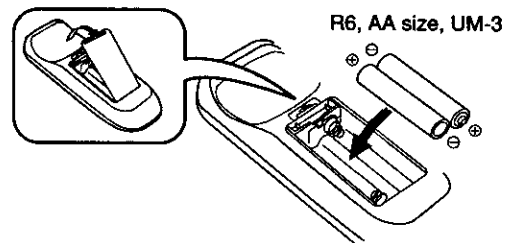

Insert the batteries observing the correct polarities (+, -).

Use of batteries

- Align the poles (+ and -) properly when inserting the batteries.
- Do not mix old and new batteries or different types of batteries.
- Do not recharge ordinary dry cell batteries.
- Do not heat or disassemble the batteries. Do not allow them to contact flame or water.
- Remove the batteries if the unit is not to be used for a long time.
- Do not keep together with metallic objects such as necklaces.
- Do not use rechargeable type batteries.
- Do not use batteries if the covering has been peeled off.

Mishandling of batteries can cause electrolyte leakage which can damage items the fluid contacts and may cause a fire.

If electrolyte leaks from the batteries, consult your dealer.

Wash thoroughly with water if electrolyte comes in contact with any part of your body.

Correct method of use

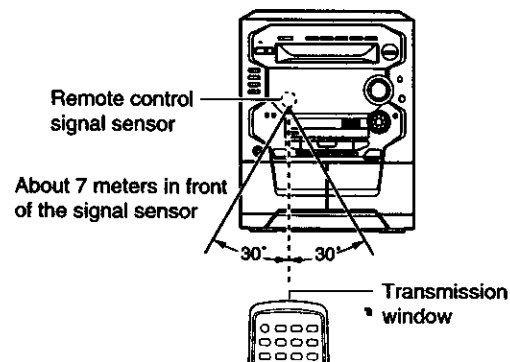

Operation notes

- Do not place obstacles between the remote control signal sensor and remote control unit.
- Do not expose the remote control signal sensor to direct sunlight or to the bright light of a fluorescent light.
- Take care to keep the remote control signal sensor and end of the remote control unit free from dust.
- If this system is installed in a rack with glass doors, the glass doors' thickness or color might make it necessary to use the remote control a shorter distance from the system.

To prevent damage

- Never place heavy items on top of the unit.
- Do not disassemble or reconstruct the unit.
- Do not spill water or other liquids into the unit.

A

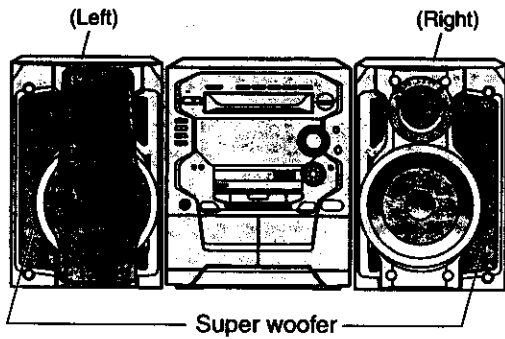

B

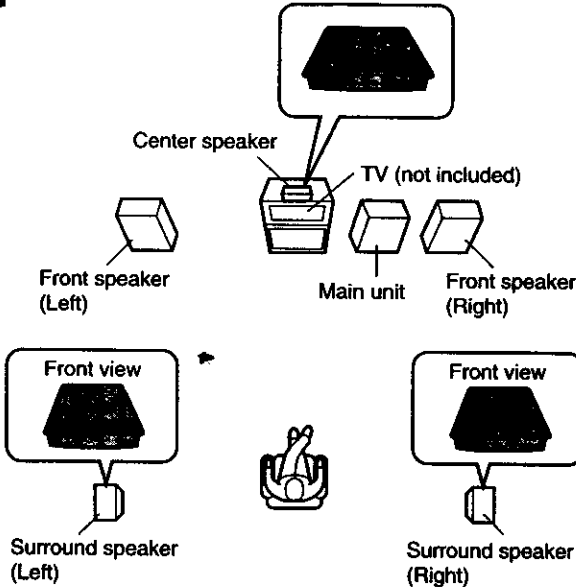

C

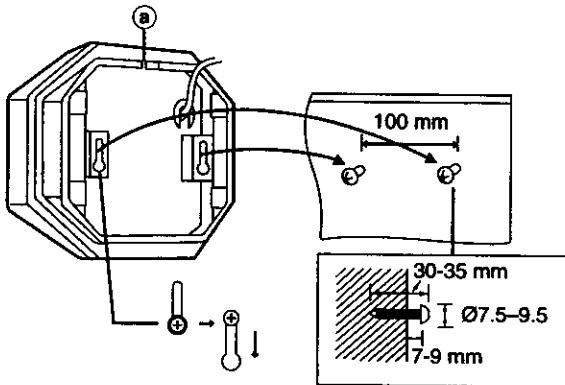

Placement of speakers

A Placement of front speakers

Place the speakers so that the super woofer is on the outside.

Note

- Keep your speakers at least 10 mm (¹³/₃₂) away from the system for proper ventilation.
- To avoid damage to the speakers, do not touch the speaker cones if you have taken the nets off.

B Placement of center/surround speakers

Center speaker

Place the center speaker above your TV, as close to it as possible.

Note

Do not place the center speaker on this unit as sound quality will be affected.

Surround speakers

As well as enjoying normal stereo reproduction with the left and right front speakers, surround speakers can also be connected to the system in order to enjoy a feeling of depth and movement of sound. Place the speakers with the Panasonic logo facing toward the listening position.

We recommend that surround speakers be placed on the side of, or slightly behind, the listener at ear level.

However, the position should be adjusted to your personal preference, because the effect varies to some degree depending upon the type of music and the music source.

Attaching to a wall

Set speaker onto screws and slide through bracket to lock into position.

Note

The wall or pillar on which the speaker systems are to be attached should be capable of supporting a weight of 5 kg.

For your reference

To fix the wire, feed it through slit (a) in the center-bottom of the speaker.

Caution



- Use the speakers only with the recommended system. Failure to do so may lead to damage to the amplifier and/or the speakers, and may result in the risk of fire. Consult a qualified service person if damage has occurred or if you experience a sudden change in performance.
- Do not attempt to attach these speakers to walls using methods other than those described in this manual.

If irregular coloring occurs on your television

The front and center speakers are designed to be used close to a television, but the picture may be affected with some televisions and set-up combinations.

If this occurs, turn the television off for about 30 minutes.

The television's demagnetizing function should correct the problem. If it persists, move the speakers further away from the television.

Note

Surround speakers do not have magnetic shielding. Do not place them near televisions, personal computers or other devices easily influenced by magnetism.

Connections

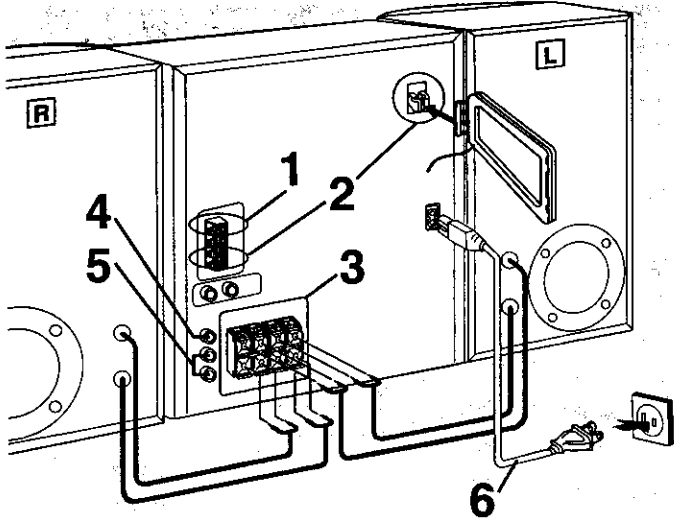

Basic connections (for supplied accessories)

- Plug the AC power cord into a household AC outlet only after all other connections have been made.
- To prepare the antenna wires and speaker cords, twist the vinyl cover tip and pull off.

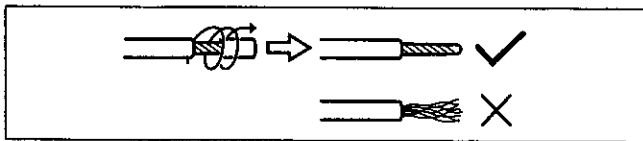

Before use

1

2

3

4

5

1. Connect the FM indoor antenna.

Tape the antenna to a wall or column, in a position where radio signals are received with the least amount of interference.

Note

For best reception:
An FM outdoor antenna is recommended. (→ page 8.)

2. Connect the AM loop antenna.

After attaching the antenna, turn on the system and tune in a broadcast station. Then, turn the antenna to the angle of best reception and least interference.

3. Connect the front speakers.

Connect each end of the speaker cables to the terminal levers of the same color.

Use only the supplied front speakers.

The combination of the main unit and front speakers provide the best sound. Using other front speakers can damage the unit and sound quality will be negatively affected.

Caution

To prevent damage to circuitry, never short-circuit positive (+) and negative (-) speaker wires.

4. Connect the center speaker.

5. Connect the surround speakers.

Note

If only one of the surround speakers is connected, no sound will come out.
Be sure to connect both speakers.

6. Connect the AC power cord.

Optional antenna connections

You may need an outdoor antenna if you use this system in a mountainous region or inside a reinforced-concrete building, etc.

A FM outdoor antenna

Disconnect the FM indoor antenna if an FM outdoor antenna is installed.

- ① Remove a piece of the outer vinyl insulator.
- ② Twist the shield braid.
- ③ Expose the core wire.

Note

An outdoor antenna should be installed by a qualified technician only.

B AM outdoor antenna

Connect the outdoor antenna without removing the AM loop antenna. Run 5 to 12 m of vinyl-covered wire horizontally along a window or other convenient location.

Note

When the unit is not in use, disconnect the outdoor antenna to prevent possible damage that may be caused by lightning. Never use an outdoor antenna during an electrical storm.

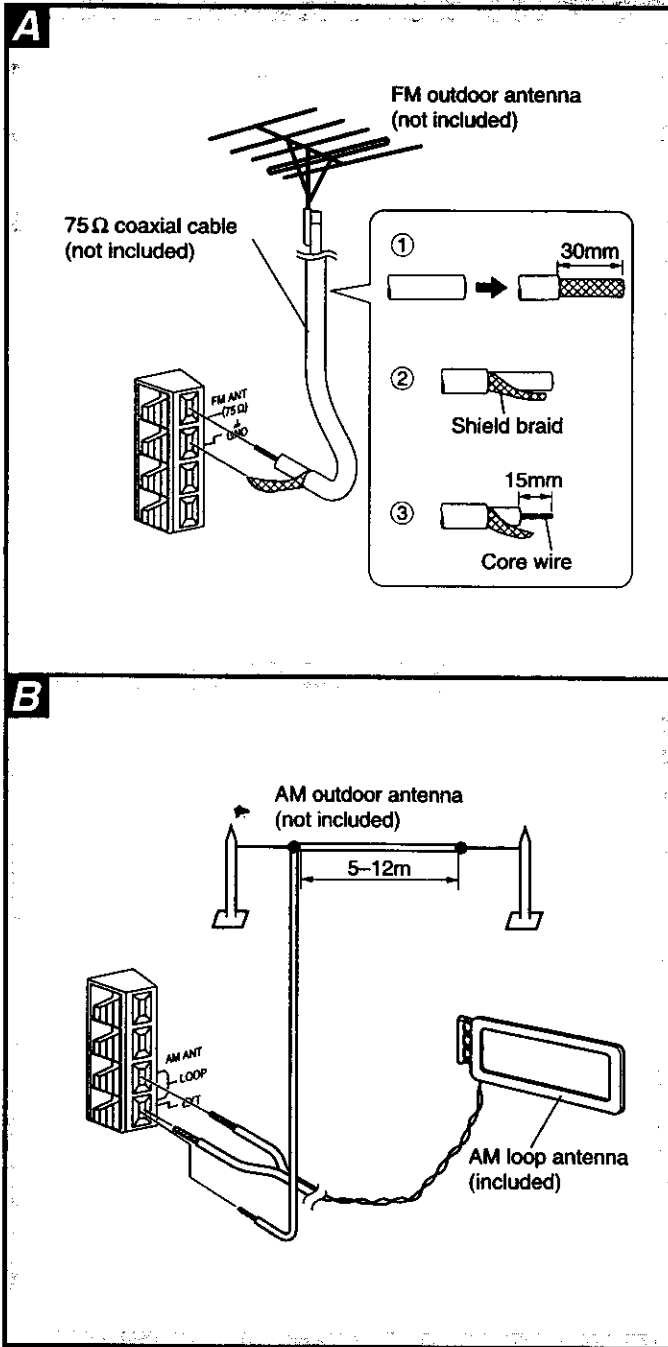

Before use

External unit connection

- For details, refer to the manual of the units which are to be connected.
- When units other than those described below are to be connected, please consult with your dealer.

A Video cassette recorder

You can enjoy only sound of the video cassette recorder.

B Record player

Sound cannot be produced unless an phono equalizer (not included) is connected.

A record player with a built-in phono equalizer is recommended.

Before use

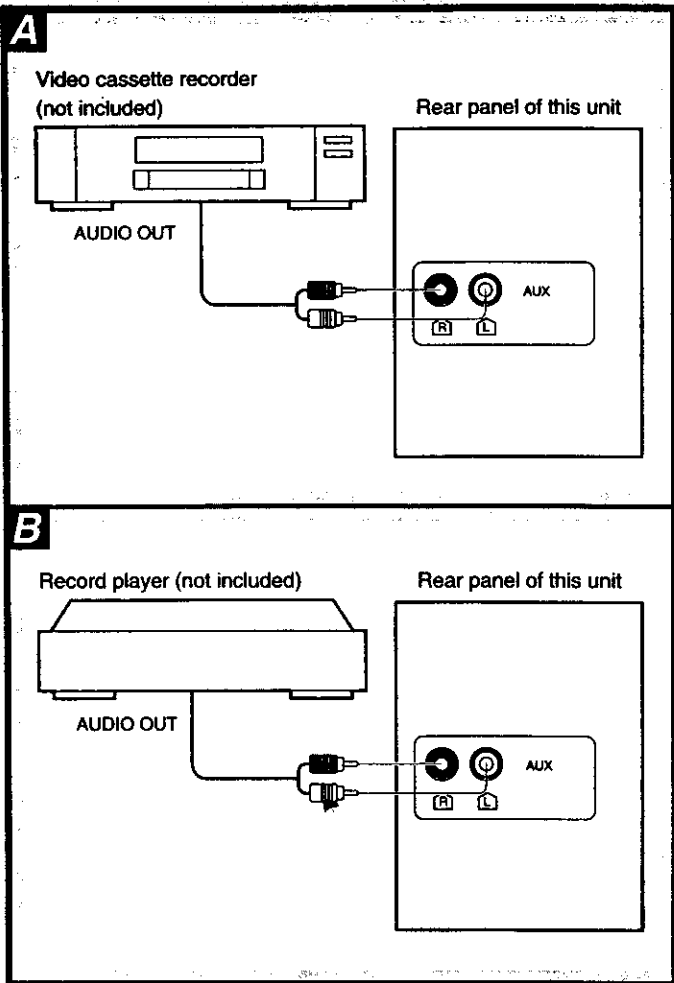

Before use

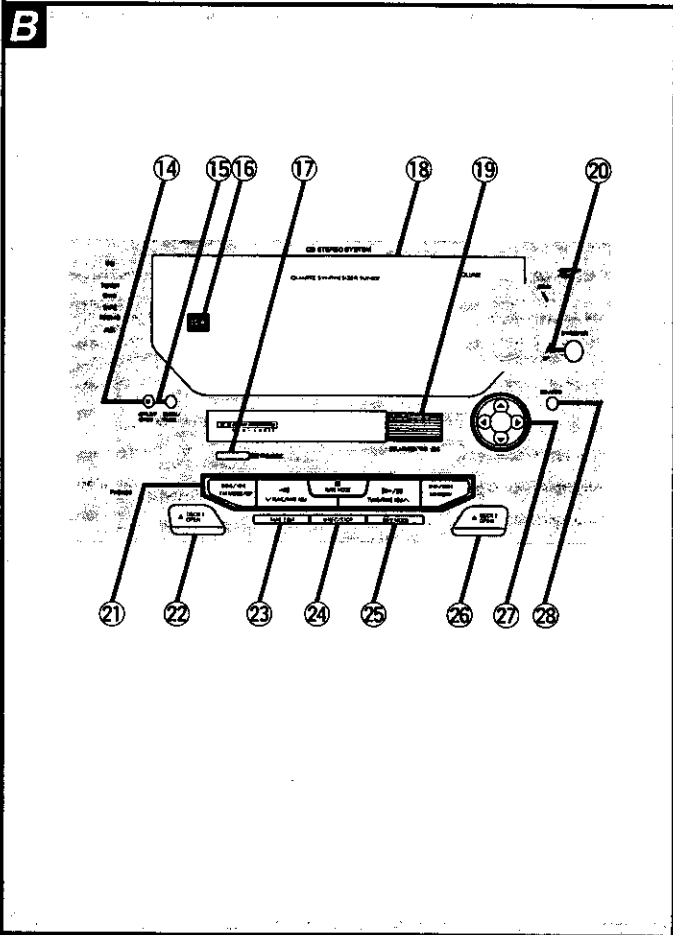
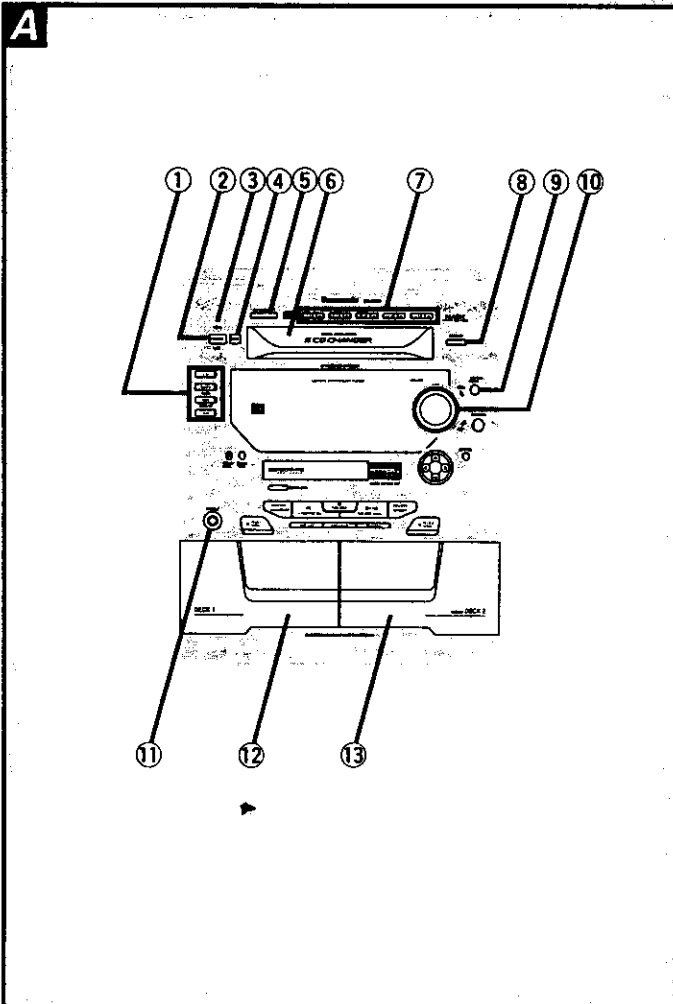

A Main unit

No.	Name	Ref. page
①	Input select buttons and indicators (CD, TUNER BAND, TAPE DECK 1/2, AUX)	14, 17, 21, 34
②	Standby/on switch (⏻/⏻, POWER)	12
③	AC supply indicator (AC IN)	12
④	ECO mode button (MODE)	12
⑤	CD manager button (CD MANAGER)	20
⑥	Disc tray	16
⑦	Disc select, disc tray open/close buttons (CD 1-CD 5 CD DIRECT PLAY, △ OPEN)	16, 17
⑧	Random play button (RANDOM)	18
⑨	Display select/demonstration button (-DISPLAY/-DEMO)	12, 34
⑩	Volume control (VOLUME)	15
⑪	Headphones jack (PHONES)	34
⑫	Deck 1 cassette holder	21
⑬	Deck 2 cassette holder	21

B Center console

⑭	Play timer/record timer button and indicator (⏻/⏻)	31, 32
⑮	Clock/timer button (CLOCK/TIMER)	13, 31, 32, 33
⑯	3D AI lamp (3D AI)	
⑰	DOLBY PRO LOGIC on/off button and indicator (⏻ PRO LOGIC)	30
⑱	Display	
⑲	Jog control (SOUND CONTROL JOG)	27
⑳	Super woofer on/off button and indicator (S.WOOFER)	27
㉑	Basic operating buttons	Functions change according to the source.
㉒	Deck 1 open button (△ DECK 1 OPEN)	21
㉓	Tape edit button (TAPE EDIT)	26
㉔	Recording start/stop button (● REC/STOP)	23
㉕	Reverse mode select button (REV MODE)	21
㉖	Deck 2 open button (△ DECK 2 OPEN)	21
㉗	Joy stick (⏻, ⏻, ⏻, ⏻)	28
㉘	3D AI EQ button (3D AI EQ)	29

Front panel controls

Remote control

Buttons such as ② function is exactly the same way as the buttons on the main unit.

No.	Name	Ref. page
②	Standby/on button (⏻)	12
⑲	Auto power-off (AUTO OFF)	13
⑳	Numeric buttons (≥10, 1-0)	15, 18
㉑	Program button (PROGRAM)	19
㉒	Cancel button (CANCEL)	19
①	Input select buttons (TAPE, CD, TUNER, AUX)	14, 17, 21, 34
㉓	EQ select button (EQ)	27
㉔	Super woofer on/off button (S.WOOFER)	27
⑰	DOLBY PRO LOGIC on/off button (□ PRO LOGIC)	30
㉕	Channel select button (CH SELECT)	30
㉖	Channel level select button (- CH LEVEL +)	30
㉗	Muting button (MUTING)	34
㉘	Sleep button (SLEEP)	33
㉙	Disc button (DISC)	18
③	Random button (RANDOM)	18
㉚	Repeat button (REPEAT)	18
④	Reverse side playback/preset channel select button (◀/∨)	15, 21
⑤	Skip/search buttons (⏮/⏪, ⏩/⏭)	17, 22
⑥	Play/pause/preset channel select button (▶/⏸/∧)	15, 17, 21
⑦	Stop button (■)	17, 21
④	Test signal output button (TEST)	30
⑩	Volume buttons (- VOLUME +)	15

Before use

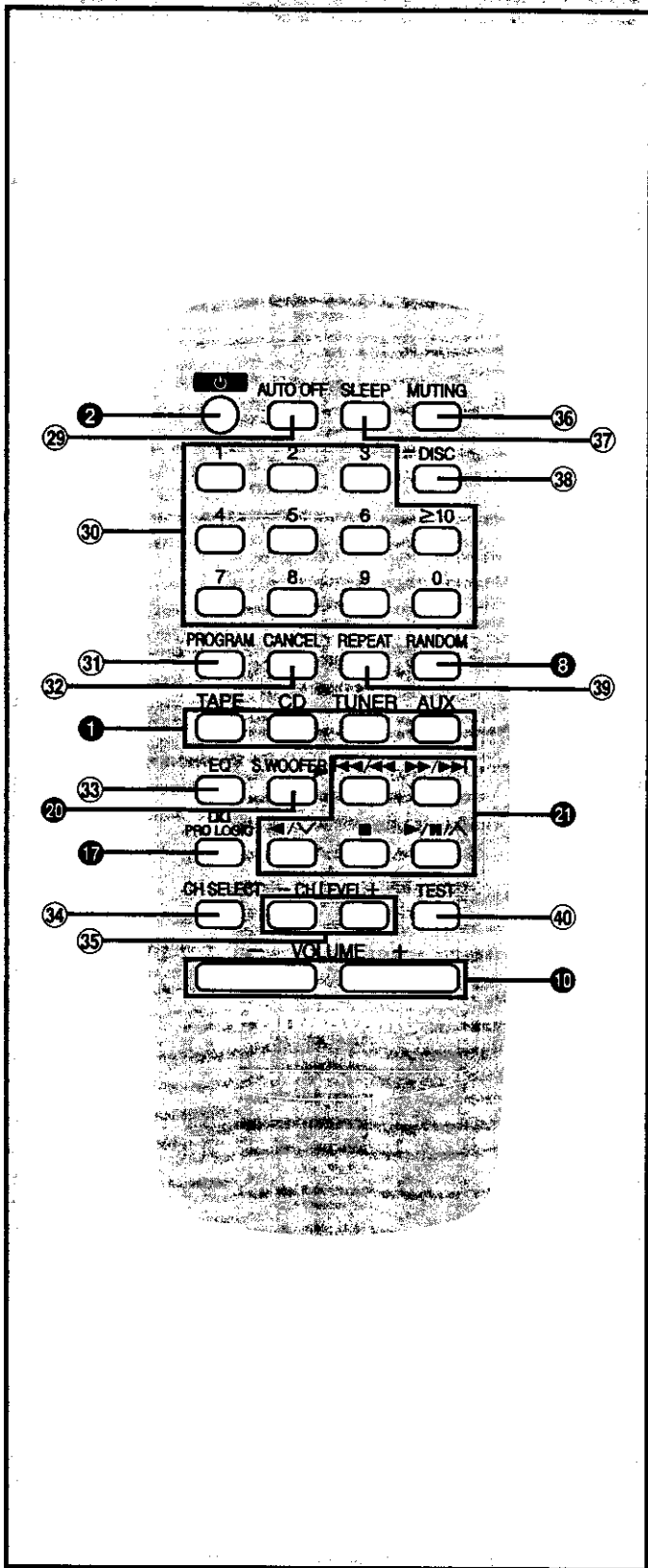

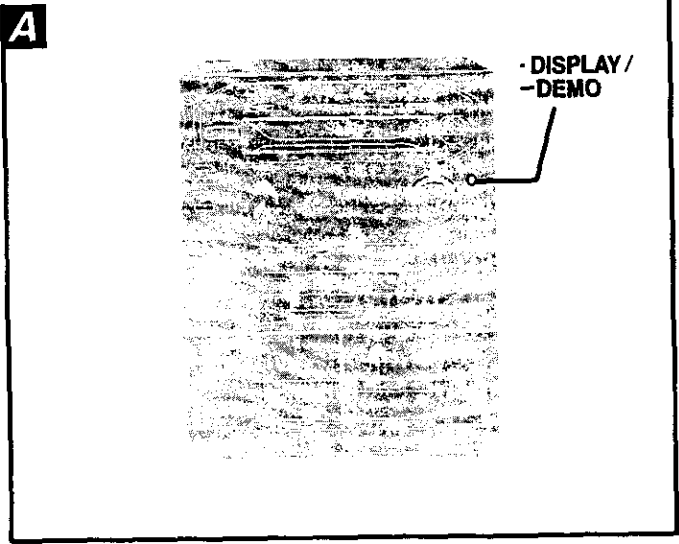

- DISPLAY / - DEMO

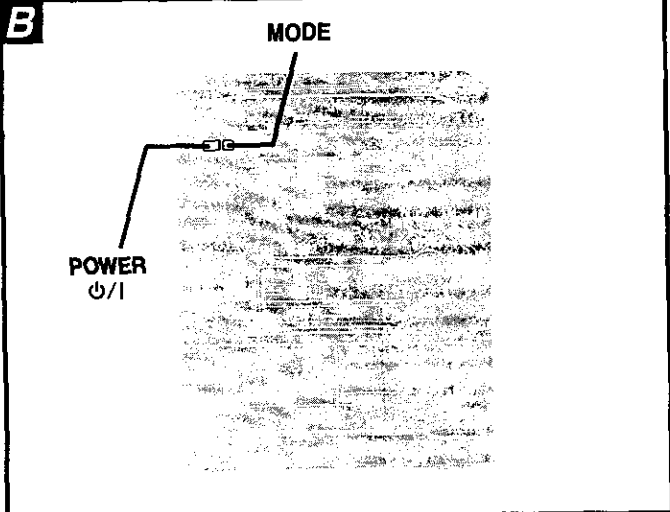
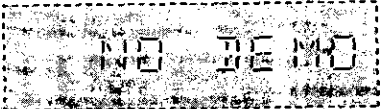

POWER
⏻/⏻

AC IN

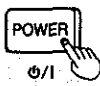

⏻/⏻



MODE

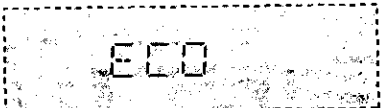
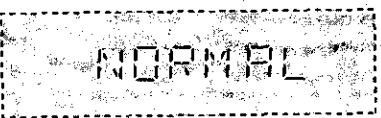

A Turning the demo function off (DEMO)

If the clock has not been set, a demonstration of the display is shown when the unit is off. This function is set to on at the time of purchase.

To get the most from the eco mode (see below), turn the demo function off.

Press and hold [-DISPLAY/-DEMO] until "NO DEMO" is displayed.

Every time you press and hold the button;

NO DEMO (off) ↔ DEMO (on)

B ECO mode (MODE)

When this mode is used, the power consumed when the unit is switched to standby mode reduces from a maximum of 18 W to 0.25 W. This mode is set to on at the time of purchase.

	NORMAL	ECO(on)
Display	Clock display, etc.	Blank
Power consumption in standby mode	18 W	0.25 W

To get the most from this mode, turn the demo function off or set the clock.

Turning ECO on and off:

Press [⏻/⏻, POWER] to turn the unit on.
Press [MODE].

The display changes each time the button is pressed:

NORMAL (off) ↔ ECO (on)

When ECO is on:

When the unit is turned off, the display panel remains blank but the AC IN indicator stays to show the unit is still connected to the AC power output.

Conserving power

The unit consumes 0.25 W even when it is turned off with [⏻/⏻, POWER] or Auto-off function and ECO mode is turned on. To save power when the unit is not to be used for a long time, unplug it from the household AC outlet. Remember to reset the radio stations and any other memory items before using the unit again.

Note

When the unit is off, the mode can be switched from NORMAL to ECO, but not the other way.

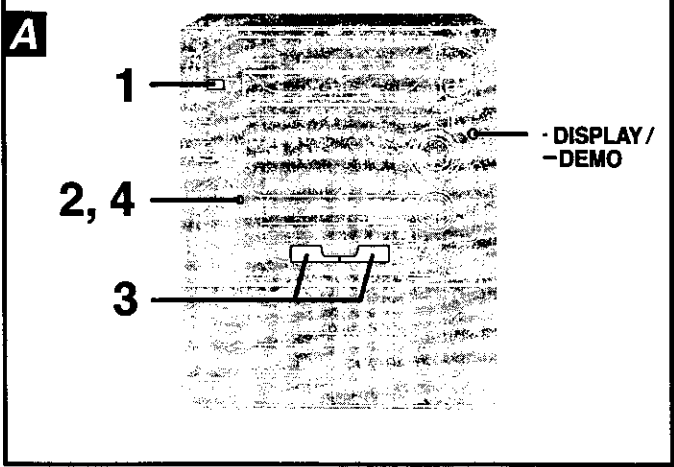

A Setting the time

The example in the figure shows how to set the time for 4:25 p.m.

1. Press [POWER] to turn the unit on.
2. Press [CLOCK/TIMER] to select "CLOCK".

Every time you press the button;
 CLOCK → ⓄPLAY → ⓄREC → Previous display

3. (Within 5 seconds or so)
 Press [TUNE/TIME ADJ (∨ or ∧)] to set the present time.

4. Press [CLOCK/TIMER] to finish setting the time.

The display will return to whatever was displayed before you set the time.

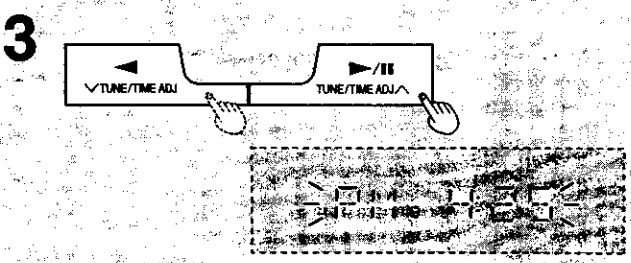
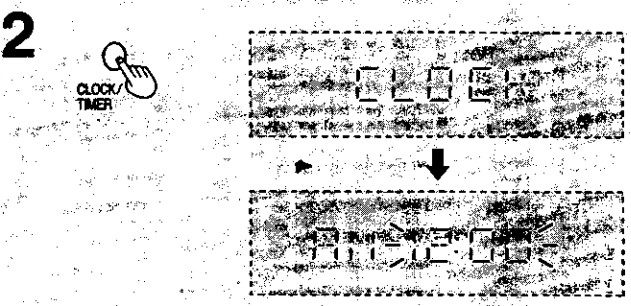
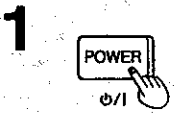

Displaying the clock

When the unit is off.

When ECO mode is off;
 The clock is displayed constantly.
 When ECO mode is on;
 Press [-DISPLAY/-DEMO].

The clock is displayed for about 5 seconds and then the display goes blank again.

When the unit is on

Press [CLOCK/TIMER] so "CLOCK" is shown.

The clock is shown for about 5 seconds then the previous display is restored.

B Auto power-off

by remote control only

When CD or tape is selected as the source.

To save power, the unit turns off if it is left unused for four minutes.

This function does not work if the source is tuner or AUX.

Press [AUTO OFF].

"AUTO OFF" is displayed.

To cancel

Press [AUTO OFF] again.

For your reference

The setting is maintained even if the unit is turned off. When the unit is turned on again, the unit functions as described above.

If you select tuner or AUX as the source, "AUTO OFF" goes out. It comes on again when you select CD or tape.

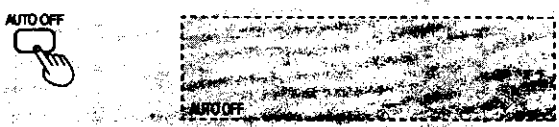
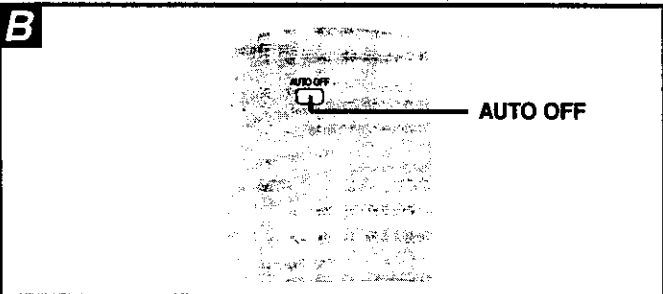

Presetting radio broadcasts

- Up to 12 stations can be set in each band with automatic or manual presetting.
- If broadcast frequencies are preset in the memory, you can easily tune in any of these frequencies from the system or remote control unit.
- You can preset just those stations you like. (See "Presetting only your favorite stations" below.)

1. Press [TUNER BAND] to select band.

The power will come on automatically.
Every time you press the button; "FM" → "AM".

2. Press [■, TUNE MODE] to select "MANUAL".

Every time you press the button; "MANUAL" → "PRESET".

3. Press [TUNE/TIME ADJ (∨ or ∧)] until the display shows the frequency from which you want to begin automatic memory presetting.

Tips on tuning in radio stations

- ① Hold down either [TUNE/TIME ADJ (∨ or ∧)] until the frequency numbers start scrolling.
- ② When near to the frequency you are looking for, press [TUNE/TIME ADJ (∨ or ∧)] repeatedly until the station is tuned in.

4. Press and hold [▶▶/▶▶, MEMORY] until the frequency begins to change.

This will start presetting automatically. When finished, the radio will tune in the last station memorized.

If auto presetting is not possible because radio signals are weak or for some other reason, do the following.

Presetting only your favorite stations

Preset the stations one at a time.

1. Perform step 1 above. Then, press [▶▶/▶▶, MEMORY] ("PRGM" flashes) and select a station with [TUNE/TIME ADJ (∨ or ∧)].
2. While "PRGM" is flashing press [▶▶/▶▶, MEMORY] again and select a preset channel with [TUNE/TIME ADJ (∨ or ∧)].
3. Press [▶▶/▶▶, MEMORY] to preset the station.

Memory retention

The preset stations are retained in memory for about 2 weeks even if the system is unplugged.

FM allocation settings:

This system comes equipped with an electronic digital tuner that divides the broadcast band into many small steps. These steps match the assignable broadcast frequencies and intervals in between.

Each country allocates broadcast bands according to their particular needs.

By adjusting the allocation, you can enable the tuner to receive FM broadcasts allocated in 0.1 MHz steps.

Press and hold [TUNER/BAND]. After a few seconds the display will change to a flashing display of the current minimum frequency. If you continue to hold [TUNER/BAND] down, the minimum frequency will change. Release the button at this time.

To return to the original frequency indication, repeat above.

Note

After changing the allocation setting, the frequencies you previously preset in the memory will be cleared.

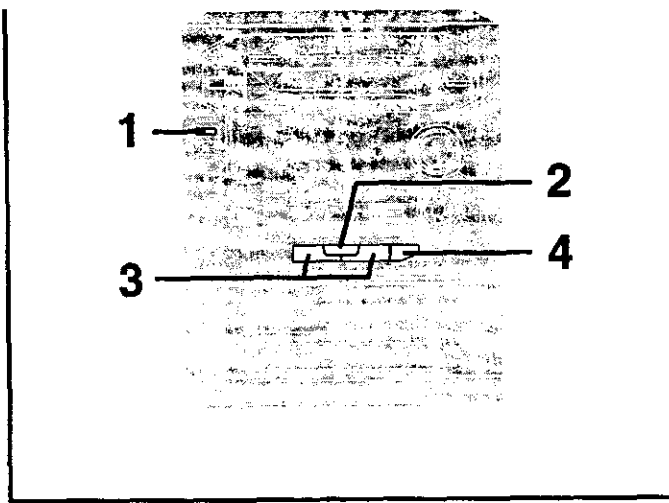

1

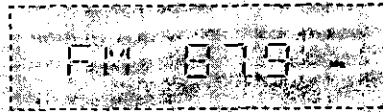

2



3

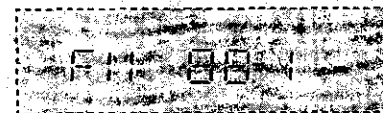
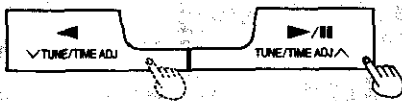

4

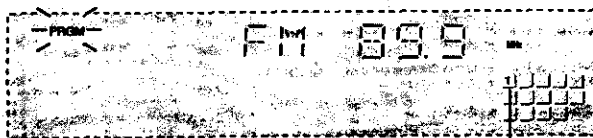
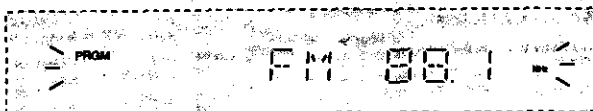

Preset channel

Listening to radio broadcasts

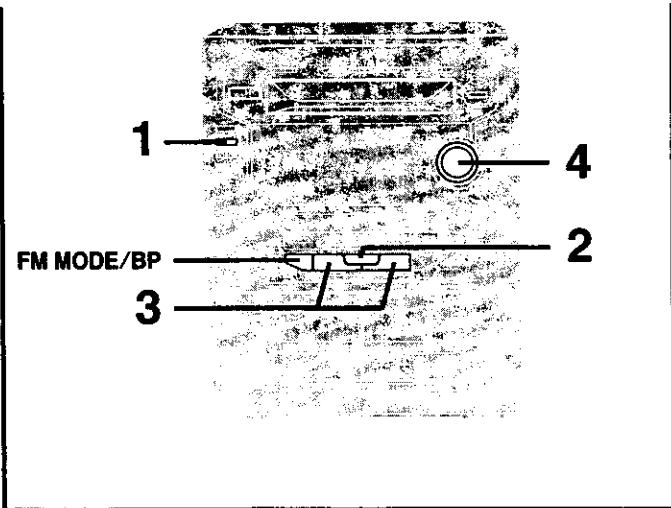

1. Press [TUNER BAND] to select band.

The unit comes on and the radio begins to play. Every time you press the button; "FM" ↔ "AM".

2. Press [TUNE MODE] to select "PRESET" or "MANUAL".

Every time you press the button; "MANUAL" ↔ "PRESET".
 PRESET: For preset stations
 MANUAL: For non-preset stations

3. Press [TUNE/TIME ADJ (∨ or ∧)] to select the desired broadcast.

"ST" lights when an FM stereo broadcast is being received. "TUNED" lights when you precisely tune in a broadcast station.

4. Turn [VOLUME] to adjust the volume level.

Auto tuning

Auto tuning is an easy way to tune in non-preset stations in the manual mode.

Hold down [TUNE/TIME ADJ (∨ or ∧)], and release the button when the frequency starts scrolling.

The radio will stop automatically on the first station it picks up.

- When there is outside interference, the radio sometimes stops on a certain frequency where no station is broadcasting.

To stop auto tuning

Press [TUNE/TIME ADJ (∨ or ∧)] again.

A If noise is excessive in the FM stereo mode

Press [FM MODE/BP]. ("MONO" will light up.)

Sound will be produced in monaural, but this also reduces noise.

Press the button again to cancel. "MONO" will go out.

Normally, you'll want to listen in stereo, so leave "MONO" off. This way, you can listen to stereo broadcasts in stereo, and monaural broadcasts in mono.

You can preset an FM station in monaural by following the steps under "Presetting only your favorite stations" on page 14. After selecting the station in step 1, select "MONO" with [FM MODE/BP], then continue with steps 2 and 3.

Note

- If you preset stations in memory they can be easily selected from the remote control with [RECALL], [PRESET], or the numeric buttons.

1. Press [TUNER] to select band on the remote control.

2. Press [RECALL] or [PRESET] to select the channel, or select the required channel directly with the numeric buttons.

To select a two-digit channel:

Press [RECALL] (≥10) and then the two numbers you want within 10 seconds or so.

- Sound is momentarily interrupted if you load/unload tapes while listening to an AM broadcast.

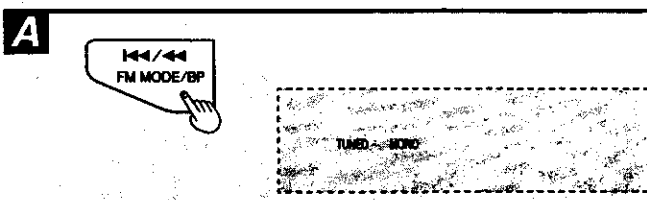
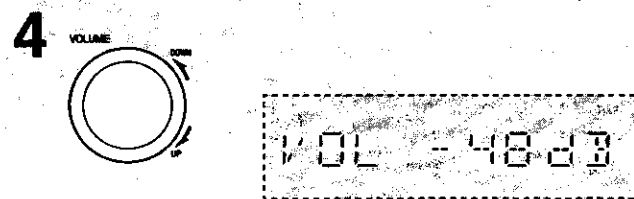
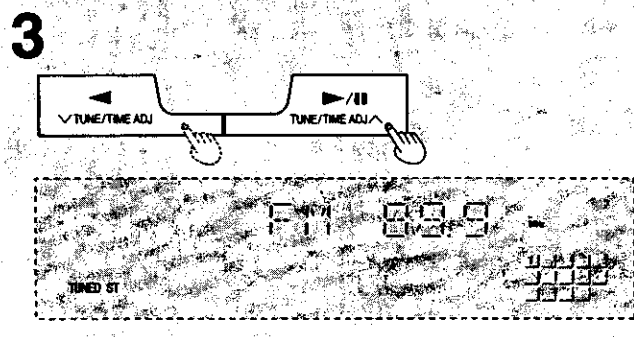
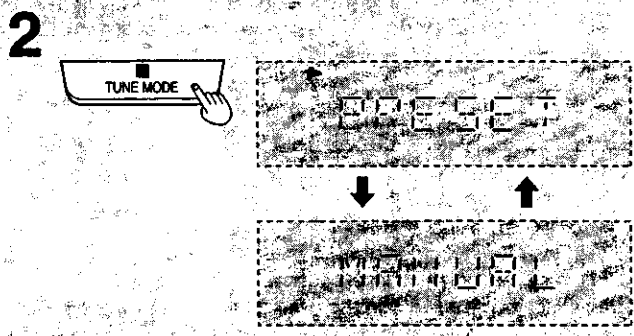
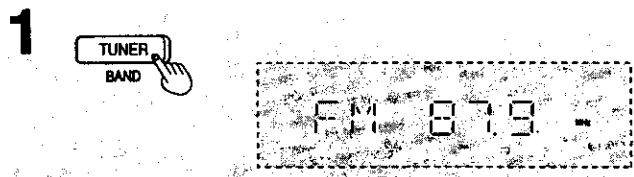

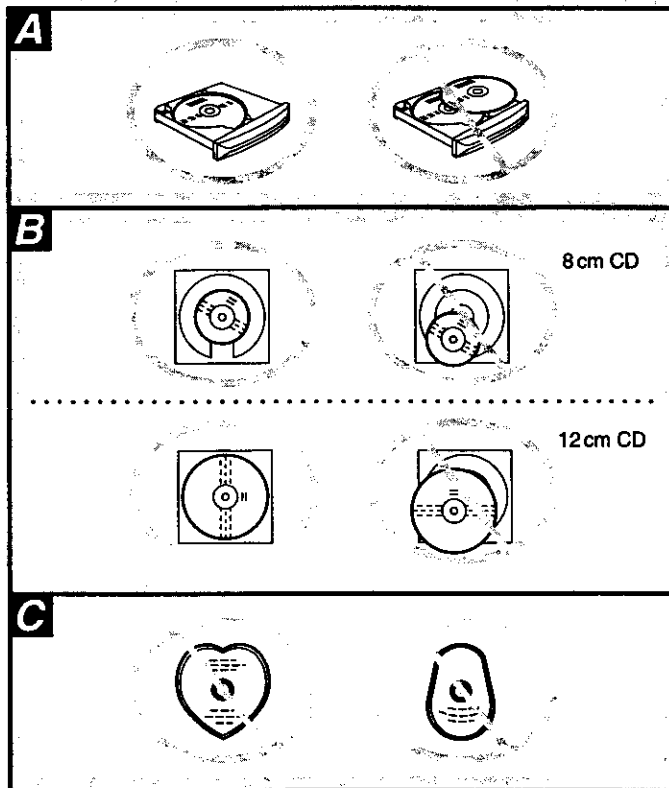
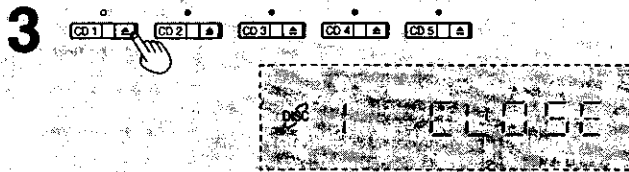
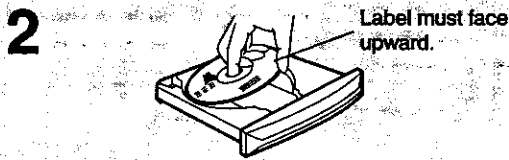
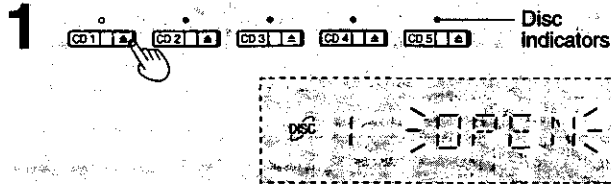
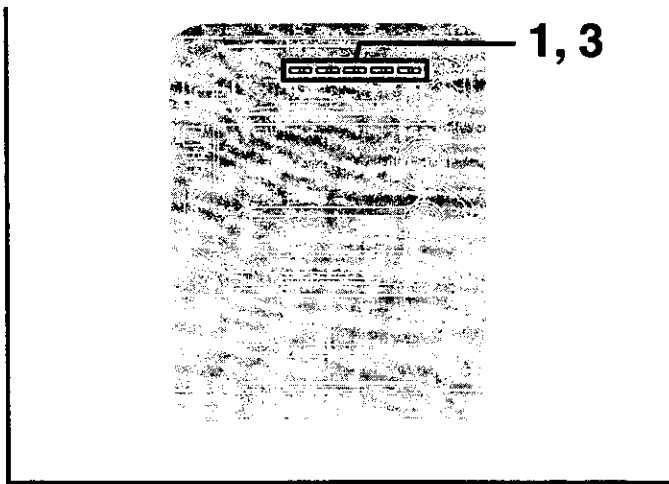

Radio operation



Loading and checking CDs

Always stop the changer before loading or changing CDs. You cannot change CDs while a disc is playing.

How to load CDs

1. Press the [] button.
The selected tray will open.
2. Set CD in the tray.
3. Press the same [] button.
The tray will close.

To continue loading CDs in the other trays
Press another [] button to open the required tray.
The current tray closes and the selected tray automatically opens.

Disc indicators (CD 1 – CD 5)

The disc indicators light whenever the tray is in the playing position, whether it is loaded or not. (If the spectrum analyzer is off, the disc indicators will not light up. → page 34).

To prevent damage

Always observe the following points.

- **A** Load only 1 CD per tray.
- **B** Load CDs as shown in figure.
- An adapter is not needed with 8 cm CDs (singles).
- Set the system on a flat, level surface.
Do not set it on top of magazines, inclined surfaces, etc.
- Do not move the system while trays are opening/closing, or when loaded.
- Do not put anything except CDs in trays.
- Do not use cleaning CDs or CDs which are badly warped or cracked.
- Do not use CDs with poorly attached labels or stickers.
Adhesive protruding from underneath stickers or left over from peeled off stickers can cause your stereo to malfunction.
- **C** Do not use irregular shaped CDs.

Sequential play

1. Press [CD].

The power will come on automatically.
If the unit was off and a CD was loaded, play will start automatically (One touch play function).

2. Insert CDs in the trays.

(→ page 16.)

3. Press [CD 1] – [CD 5] to select the disc you want.

(If the desired CD is indicated on the display panel, the same operation can be accomplished by pressing [▶/⏸].)

Play will start from the first track on the selected disc, and will continue until the last track of the final disc is played (see below).

4. Turn [VOLUME] to adjust the volume level.

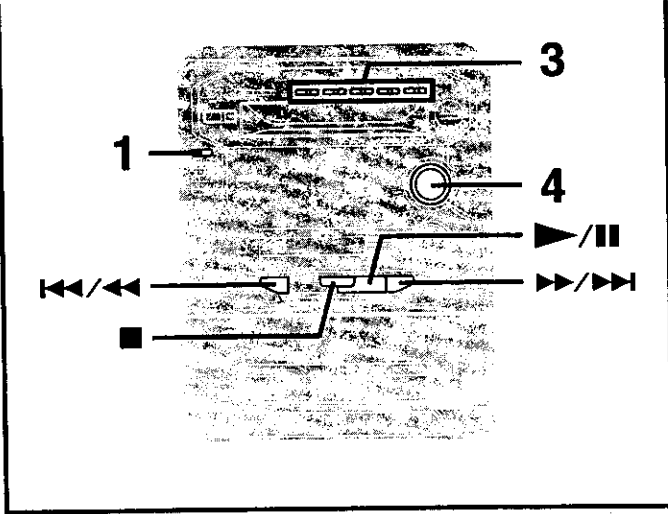

1

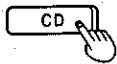

3

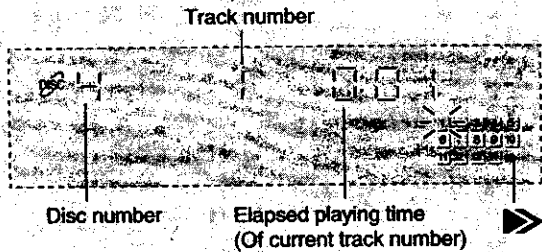

4

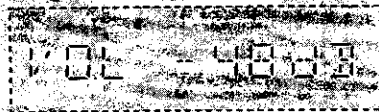
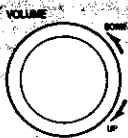

A

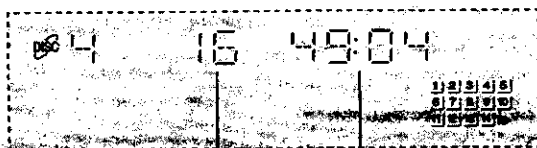

Total number of tracks Total playing time

A To stop the disc
Press [■].

When "▶" appears on the display

It indicates there are 15 or more tracks on the disc in the playing position.

What is meant by "final disc"?

For example, if play starts from CD 4, CD 3 will be the "final disc".

Order of progression:
CD 4 → 5 → 1 → 2 → 3

To pause	Press [▶/⏸] during playback. To resume playback, press [▶/⏸].
To search forward/backward (Search)	Hold down [⏮/⏭] (backward) or [⏩/⏪] (forward) during playback or pause mode.
To skip forward/backward	Press [⏮/⏭] (backward) or [⏩/⏪] (forward) during playback or pause mode. Each press increases the number of skips. Current position 2 press 1 press 1 press 2 press track track track

Note

- During random play (→ page 18), you cannot skip to tracks which have already been played.
- During program play (→ page 19) or random play, you can search forward or backward only within the current track.
- During program play, skipping is always in the programmed order, whether forward or backward.

Reference:

- Use the CD manager function if you want to listen to one CD only. (→ page 20)

CD operation

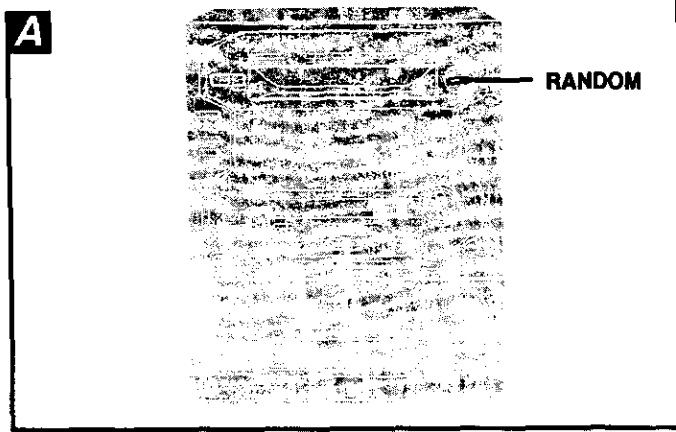

A Random play

Press [RANDOM].

Every time you press the button:

1-DISC → ALL-DISC → Previous display

To random play just one disc

Select the CD you want to random play with [CD1]-[CD5] and press [RANDOM] to select "1-DISC".

To random play all the loaded CDs

Press [RANDOM] to select "ALL-DISC".

All tracks on the CD(s) will be played in random order. Playback will stop automatically when all tracks have been played.

To cancel random play

Press [RANDOM] to clear "RANDOM" display.

Note

You can use random play with your program. Only the programmed tracks will be played, but in random order.

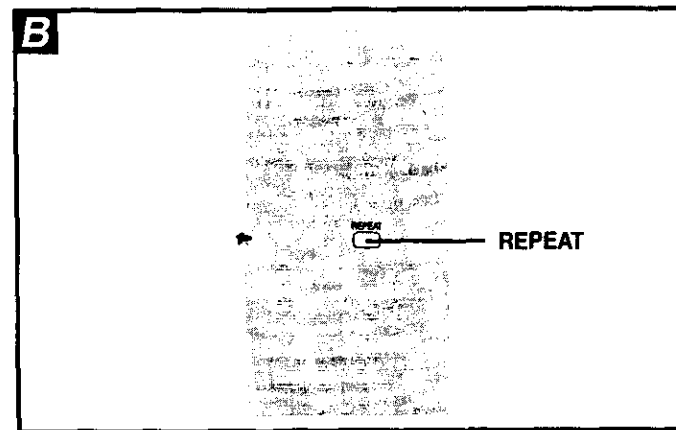
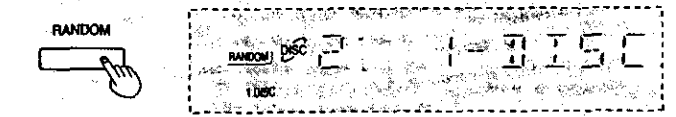

B Repeat play

by remote control only

Press [REPEAT] before or during play.

All tracks on the loaded CDs are repeated.

To cancel repeat play

Press [REPEAT] once again.

To repeat your favorite tracks

1. Program the tracks you want (⇒ page 19).
2. Press [REPEAT] and make sure "◻" is displayed.
3. Press [▶/⏪/⏩]. Playback will start.

To repeat just one track

Set the 1-TRACK mode (⇒ page 20), press [REPEAT] before or during playback, and make sure "◻" is displayed.

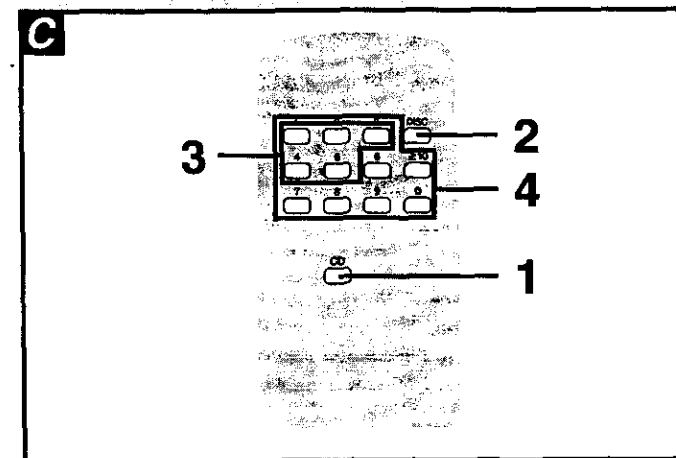
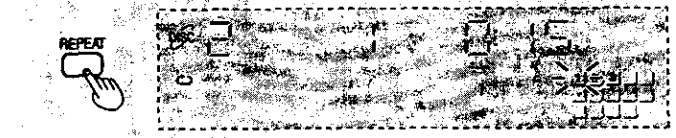

C Direct access play

by remote control only

1. Press [CD].
2. Press [DISC].
3. (Within 10 seconds or so) Press [1] – [5] to select the disc you want.
4. Press the numeric button to select the desired track number.

The CD will be played from the selected track to the last track of the final disc. (⇒ page 17)

To select a two-digit track

Press [≥10] and then the two numbers you want within 10 seconds or so.

For example

Track no. 20: [≥10] → [2] → [0]

Track no. 35: [≥10] → [3] → [5]

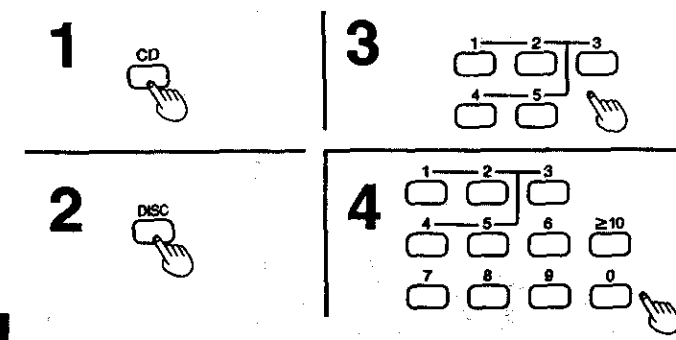

CD operation

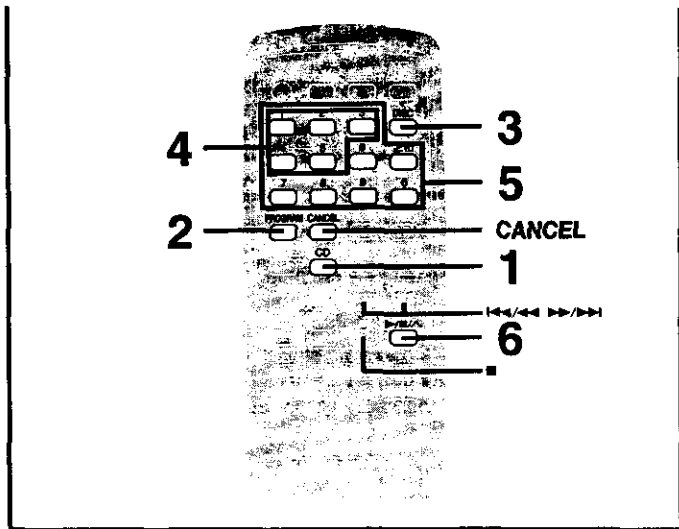

Program play

by remote control only

You can program up to 24 tracks.

1. Press [CD].
Ensure CD is stopped.
2. Press [PROGRAM].
3. Press [DISC].
4. (Within 10 seconds or so)
Press [1] – [5] to select the disc you want.
5. Press the numeric button to select the desired track.
Repeat steps 3 – 5 until you have programmed the desired track(s).
6. Press [▶/||/∧].
Play will start in the programmed sequence.

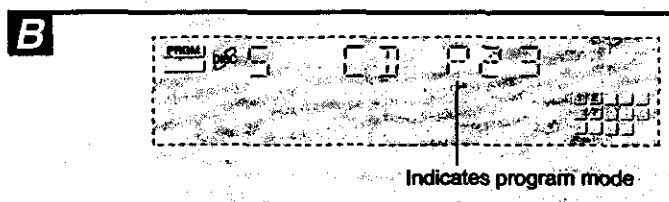
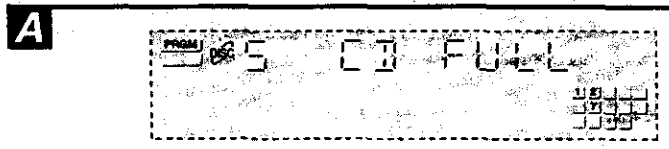
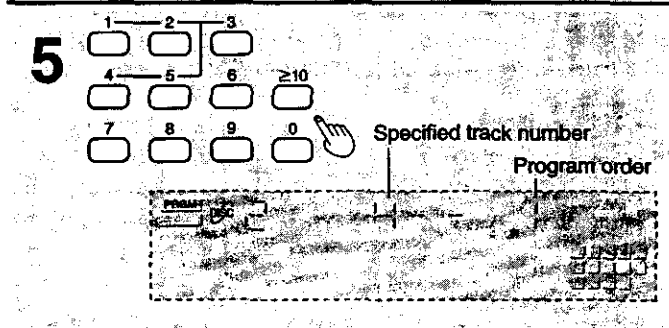
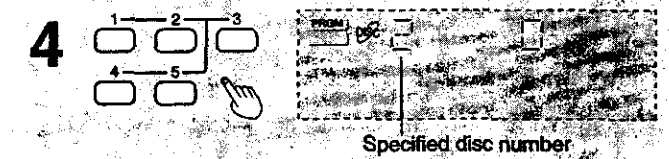
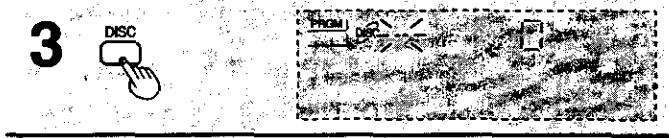
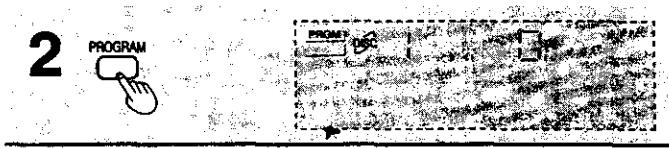
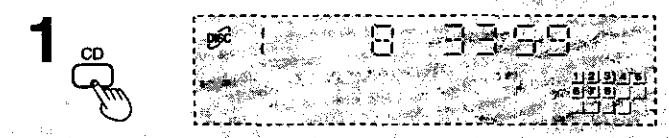

To cancel program play mode
Press [PROGRAM] in the stop mode.
Programmed contents will be saved in memory.
Pressing [■] will cancel program play, but it will also erase the entire program.

To select a two-digit track
Press [≥10] and then the two numbers you want.

ⓐ When "CD FULL" appears
The number of programmed tracks is limited to 24. No further tracks can be programmed.

- ⓑ You can do the following during program mode**
- Check program contents.
Press [◀◀/▶▶] or [▶▶/▶▶].
Every time you press one of the buttons, the track and program No. are shown on the display.
 - Add to the program.
Repeat steps 3 through 5.
 - Cancel entries.

From the last programmed track	Press [CANCEL].
A specified track only	Select the track with [◀◀/▶▶] or [▶▶/▶▶], and press [CANCEL] within 3 seconds.
All tracks	Press [■].

Memory retention
Your program is retained in memory for about 2 weeks while the system is unplugged.

- To replay your program**
If you turned off your program with [PROGRAM], you can play it again as explained below.
1. Press [PROGRAM].
 2. Press [▶/||/∧].

If you program a track number not on your CDs
The track is initially programmed, but during program play, the player will skip that track and will continue playing from the next programmed item.

CD operation

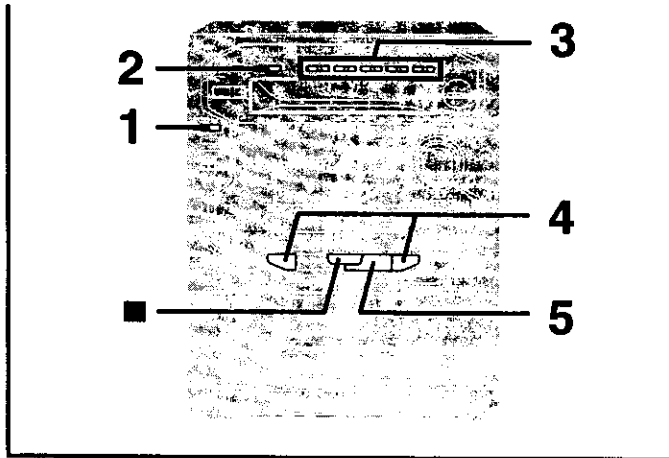

To listen to special CDs and tracks (CD Manager function)

This function makes it easier for you to select specific CDs and tracks from amongst those loaded in the player.

You can use this function to make recordings as well.

There are 3 CD/track selection modes.

- For playing back 1 track only from all loaded CDs
1-Track mode (1-TRACK)
- For playing back 1 CD only from all loaded CDs
1-Disc mode (1-DISC)
- For playing back 1 track on all loaded CDs
1-Track All-Disc mode (1-ALL)

1. Press [CD].

Ensure CD is stopped.

2. Press [CD MANAGER] to select the desired mode.

Every time you press the button;

1-TRACK → 1-DISC → 1-ALL → NORMAL (OFF)

- 1-TRACK : Only one particular track is played.
- 1-DISC : The tracks on only one particular disc are played.
- 1-ALL : The same track numbers on each of the CDs are played in succession.

(NORMAL : The original display is restored in about 3 seconds.)

3. Press [CD 1] – [CD 5] to select the disc you want.

Note

This step is not required if 1-ALL was selected in step 2.

4. Press [<<<] or [>>>] to select the desired track.

Note

This step is not required if 1-DISC was selected in step 2.

5. Press [▶/⏸].

The selected track will start.

To stop play

Press [■].

When playback ends

"NORMAL" will appear on the display for about 3 seconds, then the CD MANAGER function will turn off automatically.

During play in the 1-ALL mode:

- It is not possible to skip back to a CD whose track has already been played.
- If a CD does not have the designated track number, it is skipped and play continues.

Note

- You can use the CD Manager function together with repeat play.
- CD Manager function will be cancelled when you press the [RANDOM] button.

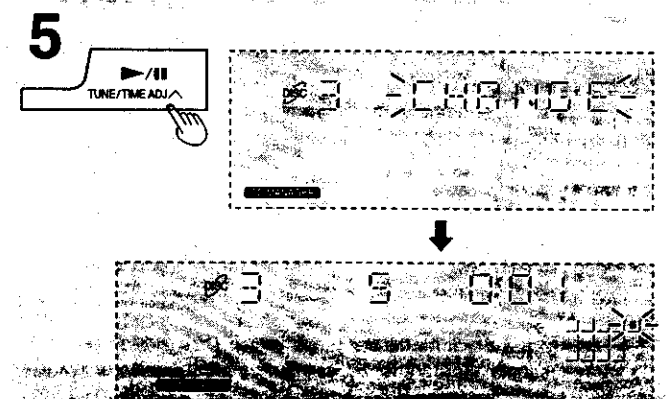
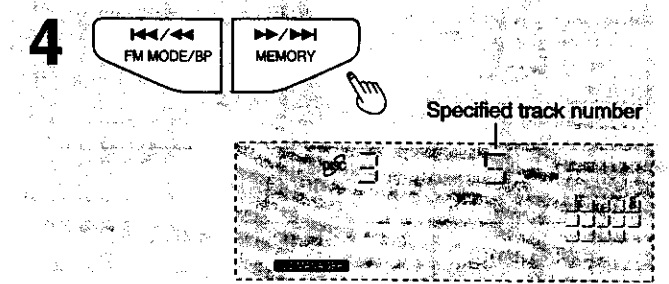
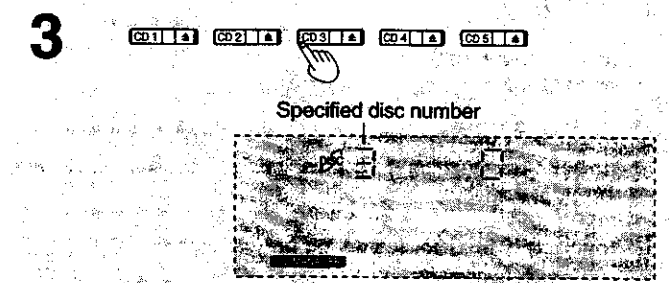
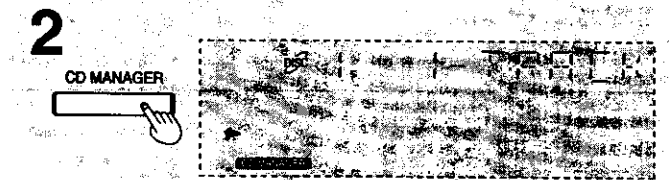

CD operation

Types of tapes which can be played correctly:
The unit automatically identifies the type of tape.

NORMAL POSITION / TYPE I	✓
HIGH POSITION / TYPE II	✓
METAL POSITION / TYPE IV	✓

You can use either deck 1 or deck 2 for tape playback.

1. Press [TAPE DECK 1/2].

The power will come on automatically.
If the unit was off and a cassette was loaded, play will start automatically (One touch play function).

2. Press [▲ DECK 1 OPEN] or [▲ DECK 2 OPEN] and insert the tape.

Insert the tape with the exposed tape facing down.
Close the holder by hand.

3. Press [REV MODE] to select the reverse mode.

Every time you press the button;

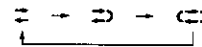

- : One side is played, then playback stops automatically.
- ↔ : Both sides (front side → reverse side) are played one time each, then playback stops automatically.
- ↔ with bar : Both sides are played 8 times each, then playback stops automatically.

4. Press [◀] or [▶/II] to start playback.

- [▶/II]: The forward side (front side) will play.
- [◀]: The reverse side will play.

5. Turn [VOLUME] to adjust the volume level.

To stop tape playback

Press [■].

To change the deck to be used

Press [TAPE DECK 1/2] to select the deck you want to use when you load cassettes into both decks.

To listen to 2 tapes consecutively

Load a tape into each deck and select (↔). Both tapes will be played 8 times each.

Note

Playback is momentarily interrupted while playing back tapes if you open the other deck.

Tape deck operation

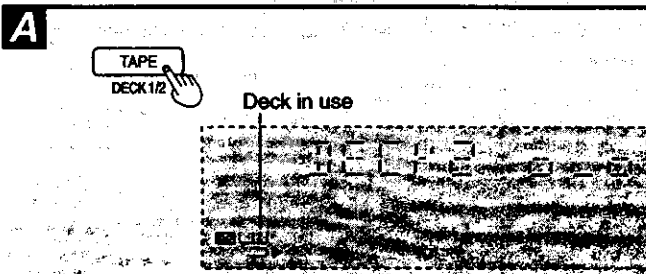
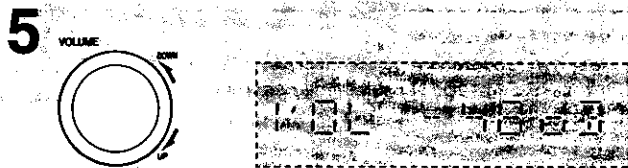
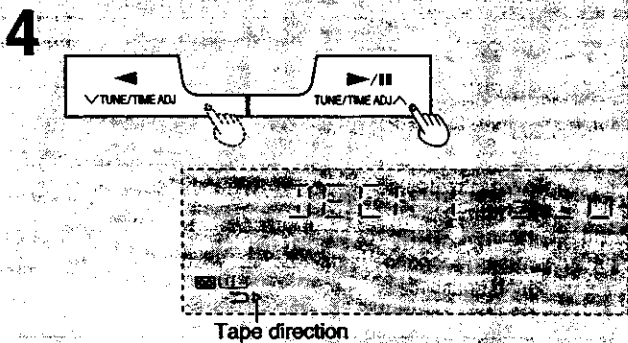
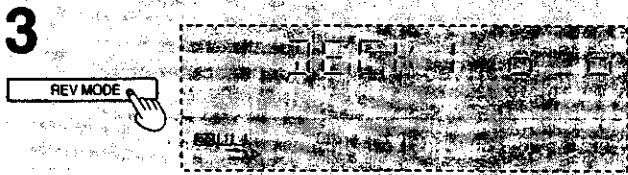
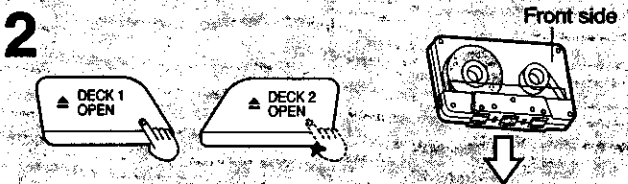
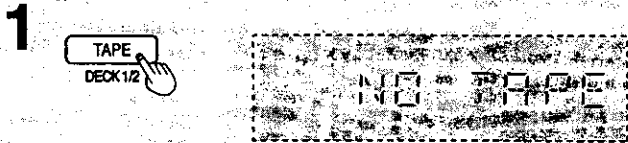
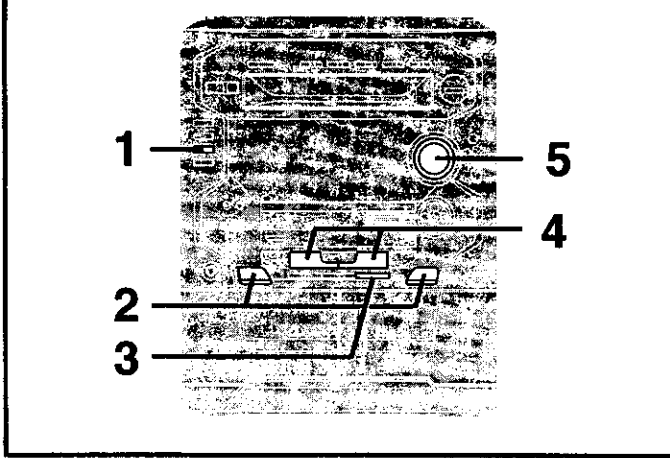

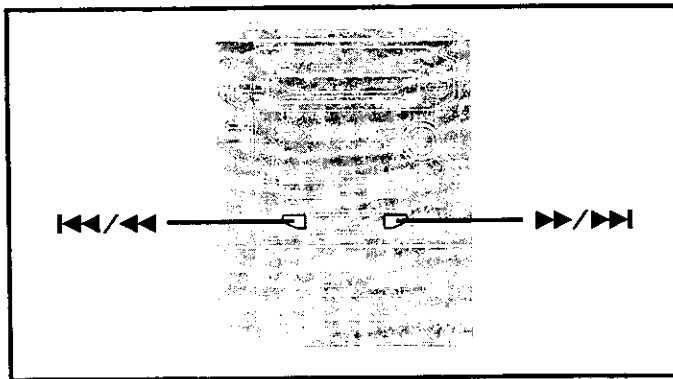

To fast-forward or rewind the tape

Press [<<<<] or [>>>>] in the stop mode.

Tape direction	To rewind	To fast-forward
" ▷ "	[<<<<]	[>>>>]
" ◁ "	[>>>>]	[<<<<]

To find the beginning of a program (TPS: Tape Program Sensor)

TPS finds the beginning of a track and resumes play from there. Each press increases the number of tracks skipped, up to a maximum of 9.

Press [<<<<] or [>>>>] during play.

Tape direction	To play the current tune from the beginning	To play the next tune from the beginning
" ▷ "	[<<<<]	[>>>>]
" ◁ "	[>>>>]	[<<<<]

Note

TPS searches for silent parts of about 4 seconds normally found between tunes. As a result, it may not function properly in the following cases.

- With short silent parts
- When noise occurs between tunes
- With silent parts found within tunes

Tape deck operation

Recording operation

Types of tapes which can record correctly

The unit automatically identifies the type of tape.

NORMAL POSITION / TYPE I	✓
HIGH POSITION / TYPE II	✓
METAL POSITION / TYPE IV	✗

Metal position tapes can be used, but the unit will not be able to record or erase them correctly.

To record from the beginning of the tape

You cannot record on the leader part of the tape. Before recording, wind the tape past the leader to a point where recording can start immediately.

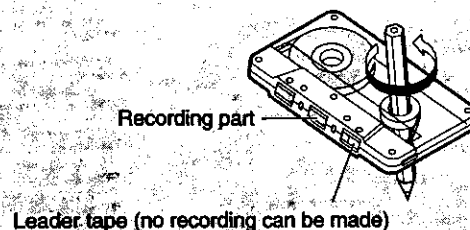

To start recording from a particular position on the tape

Wind the tape on to the position you want recording to start from.

To start recording from the reverse side

Insert the cassette into deck 2 and follow these steps to change the side.

1. Press [TAPE DECK 1/2] so the deck 2 indicator lights.
2. Press [◀] then [■]. Tape direction will be shown as " ◁ ".

How volume, sound quality/field affect recording

The tape you are recording is not affected whatsoever by changes in volume, sound quality/field.

To erase a recorded sound

1. Press [TAPE DECK 1/2].
2. Insert the recorded tape into deck 2.
3. Press [REV MODE] to select reverse mode.
4. Press [● REC/STOP].

Note

- You cannot open deck 1 while recording.
- You cannot fast-forward or rewind one deck while recording with the other.

Recording from radio broadcasts

Preparation:

Insert the tape to be recorded on into deck 2.

Tape direction is automatically set to "▷".

Change the tape direction if you want to start recording from the reverse side. (⇒ page 22)

1. Select a radio station.

(⇒ page 15, steps 1 – 3)

2. Press [REV MODE] to select the reverse mode.

Every time you press the button;

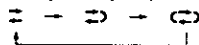

▷ : One side is recorded, then recording stops automatically.

↔, ↔ : Both sides (front side → reverse side) are recorded, then recording stops automatically.

3. Press [● REC/STOP] to start recording.

If you selected ↔ in step 2, the direction will automatically change to ▷ when recording starts.

To stop recording

Press [● REC/STOP] again.

Recording can also be stopped by pressing [■].

To cut an unnecessary part while recording

1. Press [● REC/STOP] during the unnecessary part. The cassette deck will stop.
2. Press [● REC/STOP] to resume recording again. Recording will continue in the same direction as before.

Note

When recording an AM broadcast, sound is momentarily interrupted when you start and stop the recording.

A To reduce noise while AM recording (Beat proof function)

Press [◀◀/▶▶, FM MODE/BP] while recording.

Each time you press the button, "BP1" and "BP2" will be displayed alternately.

Select the position where there is less noise.

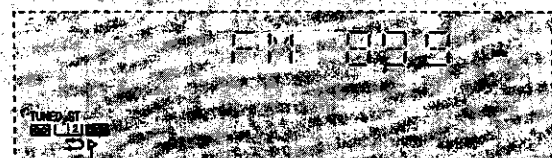
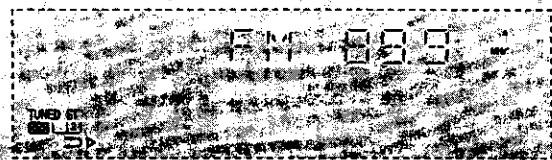
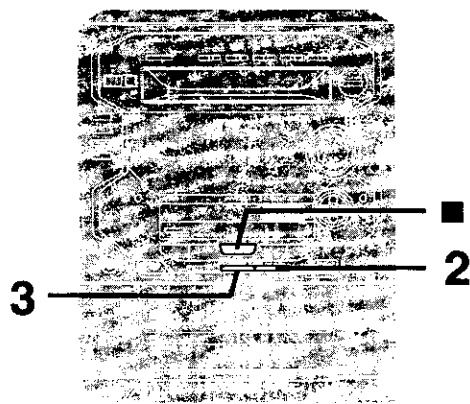

Tape direction

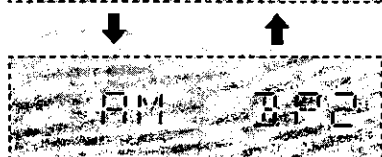
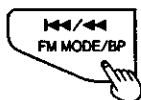
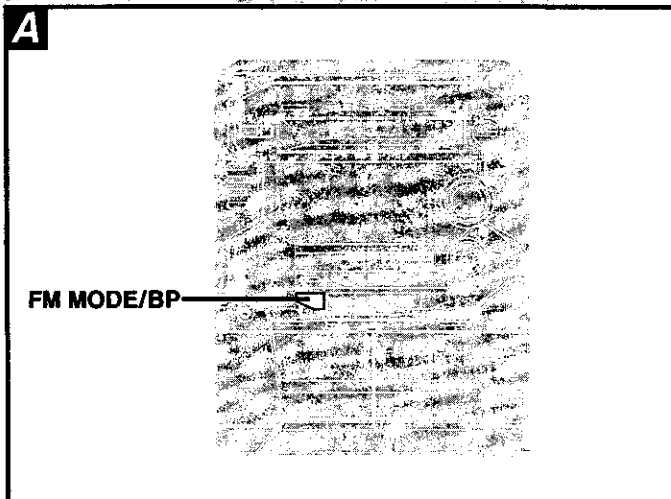

Recording from compact discs

Sequential recording

Preparation:

1. Insert the tape to be recorded on into deck 2.
Tape direction is automatically set to "▷".
Change the tape direction if you want to start recording from the reverse side. (⇒ page 22)
2. Insert the CD.

1. ① Press [CD 1] – [CD 5] to select the disc.
② Press [■] to stop the CD.

2. Press [REV MODE] to select the reverse mode.

Every time you press the button:

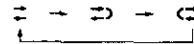

- ▷ : One side is recorded, then recording stops automatically.
- ↔ : Both sides (front side → reverse side) are recorded, then recording stops automatically.

3. Press [● REC/STOP] to start recording.

- If you selected ↔ in step 2, the direction will automatically change to ▷ when recording starts.
- The recording will proceed from the first track on the selected CD and will continue on through the last track of the final disc.
- The tape deck stops automatically when the CD is finished.

To stop recording

- To add a 4 second silent interval before stopping
Press [■]. The CD will stop automatically too.
- To stop recording without a silent interval
Press [● REC/STOP]. The CD will stop automatically too.

To record programmed tracks

1. After step 2, program the track you want (performs steps 2 – 5 on page 19).
2. Press [● REC/STOP] to start recording.

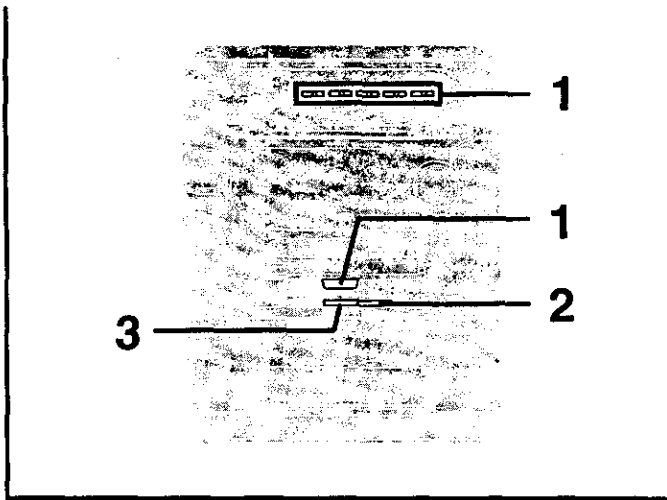

1 ①

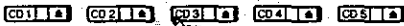

②

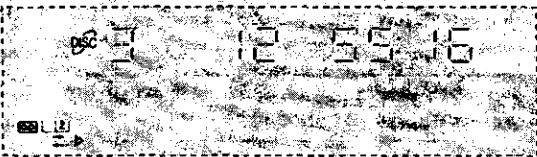

2

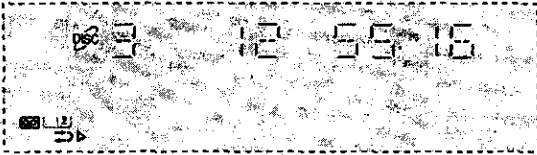

3

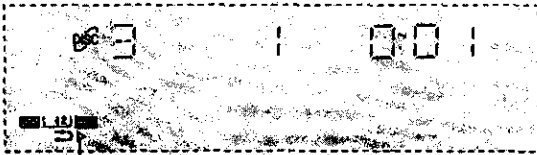
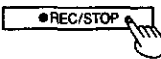

Tape direction

Recording operation

To record special CDs and tracks (CD Manager function)

This function makes it easier for you to select special CDs and tracks from amongst those loaded in the player.

- While recording, if a track is cut off in the middle at the end of the front side, it is re-recorded from the beginning on the reverse side.



The interrupted track is re-recorded in its entirety on the reverse side.

- At the end of the reverse side, recording stops and the current track will be interrupted.

Preparation:

1. Insert the tape to be recorded on into deck 2.
Tape direction is automatically set to "▷".
Change the tape direction if you want to start recording from the reverse side. (⇒ page 22)
2. Insert the CD.

1. Press [CD].
2. Press [CD MANAGER] to select the desired mode.

Every time you press the button;

1-TRACK → 1-DISC → 1-ALL → NORMAL (OFF)

- 1-TRACK : Only one particular track is recorded.
- 1-DISC : The tracks on only one particular disc are recorded.
- 1-ALL : The same track numbers on each of the CDs are recorded in succession.
- (NORMAL : The original display is restored in about 3 seconds.)

3. Press [CD 1] – [CD 5] to select the disc.

Note

This step is not required if 1-ALL was selected in step 2.

4. Press [◀◀/▶▶] or [▶▶/▶▶] to select the desired track.

Note

This step is not required if 1-DISC was selected in step 2.

5. Press [● REC/STOP] to start recording.

To stop recording

- To add a 4 second silent interval before stopping
Press [■]. The CD will automatically stop too.
- To stop recording without a silent interval
Press [● REC/STOP]. The CD will stop automatically too.

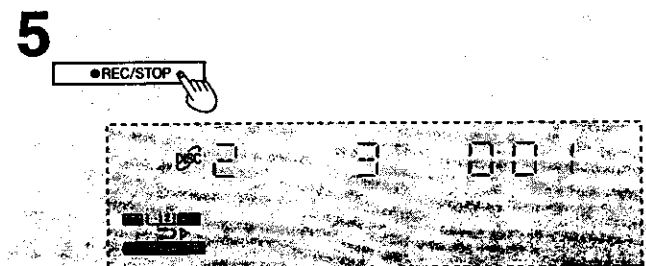
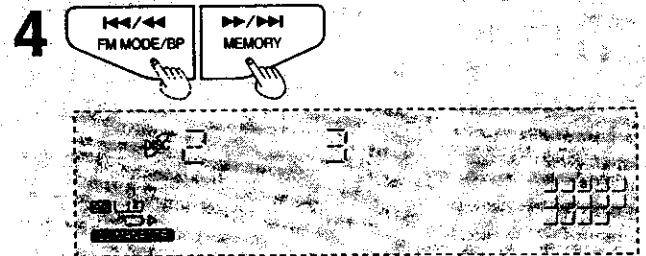
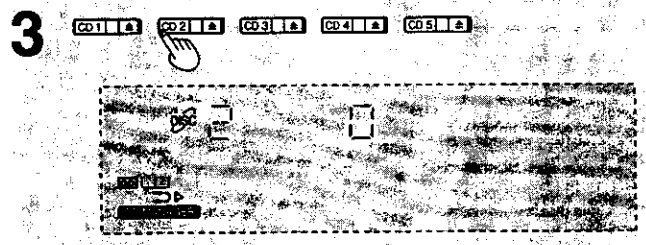
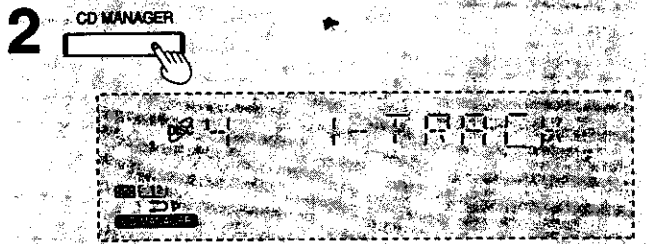
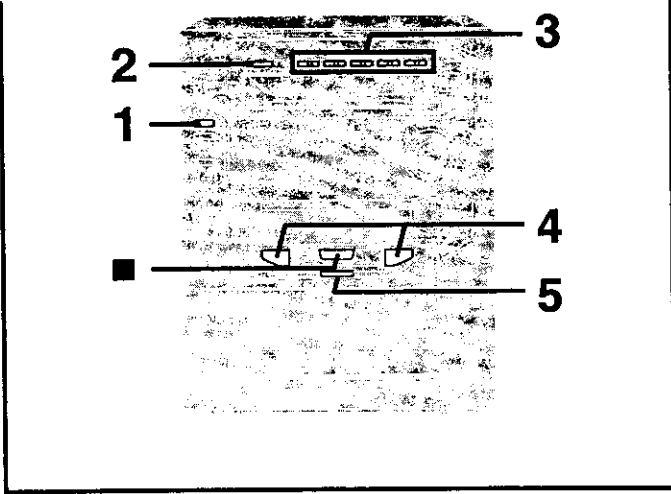

The recording level will be recorded as they are on the tape being played back.

Preparation:

Insert the cassettes.

For playback: into deck 1

For recording: into deck 2

Tape direction is automatically set to "▷".

Change the tape direction if you want to start recording from the reverse side. (→ page 22)

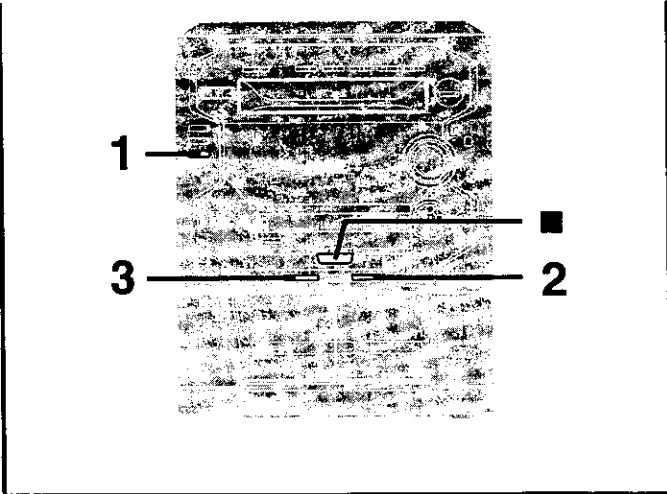

1. Press [TAPE DECK 1/2].

2. Press [REV MODE] to select the reverse mode.

Every time you press the button;

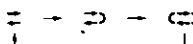

▷ : One side is recorded, then recording stops automatically.

↔ , ↔ : Both sides (front side → reverse side) are recorded, then recording stops automatically.

3. Press [TAPE EDIT] to start recording.

- If you selected ↔ in step 2, the direction will automatically change to ▷ when recording starts.

To stop recording:

Press [■].

Both decks will stop.

1

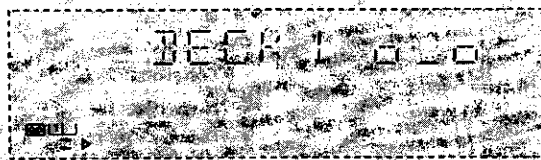

2

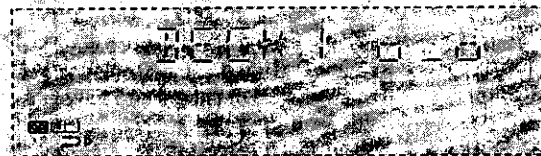

3



Tape direction of the tape you are recording onto

Recording operation

A Boosting the super woofer

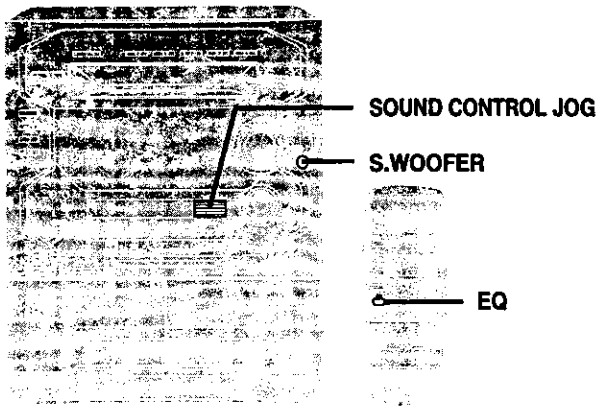

Press [S.WOOFER].

- When listening to the sound through the speakers

MID (medium) → MAX (high) → Light off (OFF)

- When listening to the sound through the headphones
Light on (ON) = Light off (OFF)

Note

All recordings are performed at the flat setting even if an alternative sound quality/sound field setting has been selected and the super woofer effect is set to ON.

A

S.WOOFER

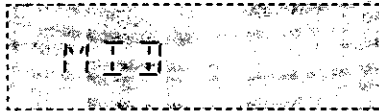
**B**

SOUND CONTROL JOG

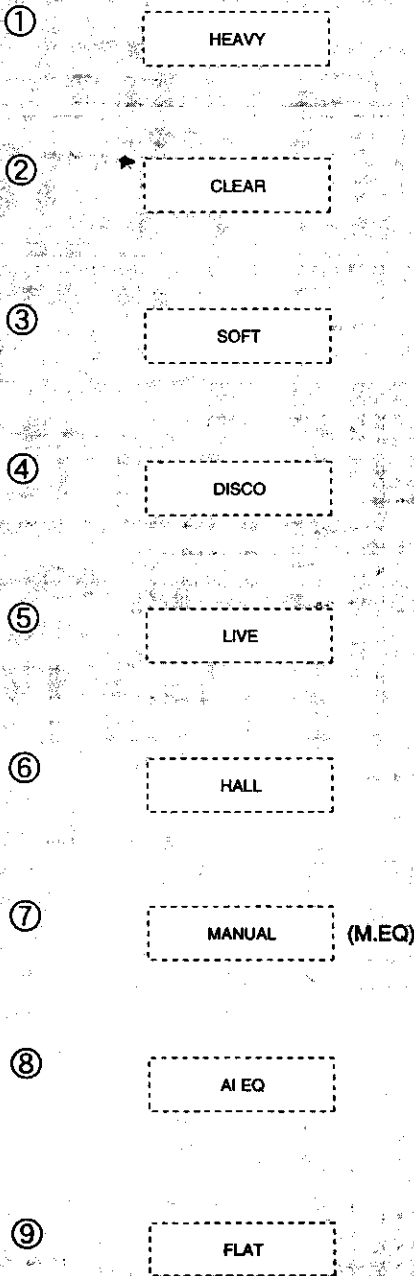

Dial [SOUND CONTROL JOG] to select the sound quality or sound field.

When it is dialed down, the settings are selected in the following sequence.

- ① **HEAVY (sound quality)**
Select this when playing rock or other kinds of music that sound better with an added punch.
- ② **CLEAR (sound quality)**
Select this for jazz or other kinds of music for which clarity in the treble range is desired.
- ③ **SOFT (sound quality)**
Select this when listening to background music.
- ④ **DISCO (sound field)**
Select this to produce sound with the same kind of lengthy reverberations heard at a disco.
- ⑤ **LIVE (sound field)**
Select this to make vocals more alive.
- ⑥ **HALL (sound field)**
Select this to add an expansiveness to the sound to produce the atmosphere of a great concert hall.
- ⑦ **MANUAL (see page 28)**
- ⑧ **AI EQ (see page 29)**
- ⑨ **FLAT**
The original display is restored on the display panel in about 5 seconds.

To release the equalizer

Dial [SOUND CONTROL JOG] to select "FLAT".

When using the remote control to perform the operations described above

Press [EQ].

Each time this button is pressed, the setting is changed in the sequence described above.

varying the sound quality with the manual equalizer (Manual EQ)

1. Dial [SOUND CONTROL JOG] to select "MANUAL".

When it is dialed down, the settings are selected in the following sequence.

- HEAVY
- CLEAR
- SOFT
- DISCO
- LIVE
- HALL
- **MANUAL(M.EQ)**
- AI EQ
- FLAT

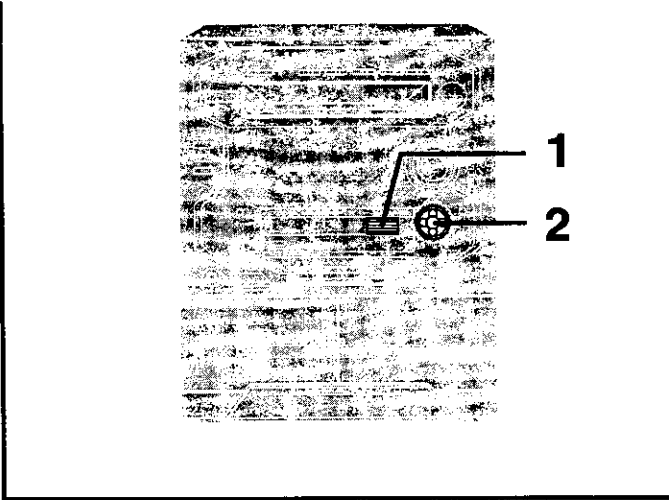

1

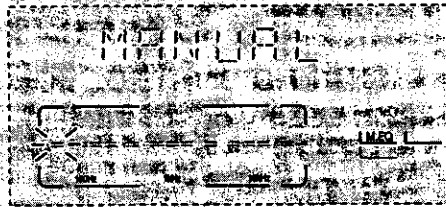

2. Adjust the sound quality.

① ← — direction: For selecting the range of the sound to be adjusted

Characteristics of each sound range

- 100 Hz: Super woofer range
- Around 330 Hz: Bass to midrange
- 1 kHz: Midrange
- Around 3.3 kHz: Midrange to treble
- 10 kHz: Treble

② ↓ ↑ direction: For adjusting the level

Repeat steps ① and ② to set the desired sound quality. The original display is restored on the display panel in about 5 seconds.

2

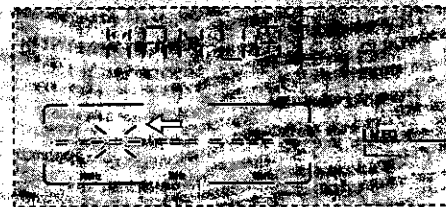
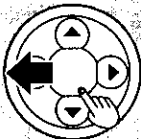
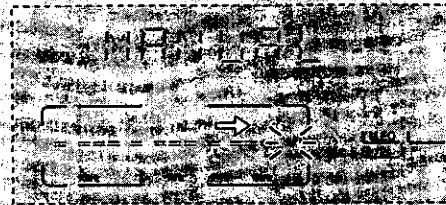

②

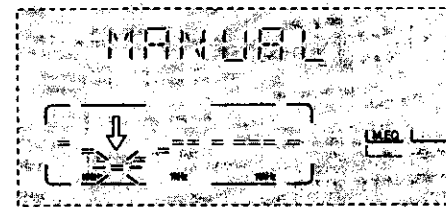
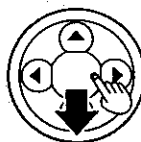
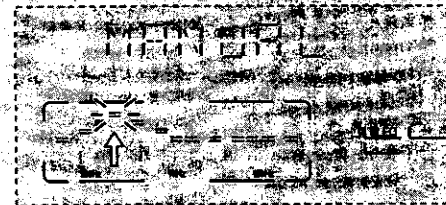
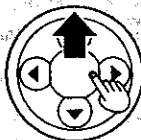

To release the equalizer

Dial [SOUND CONTROL JOG] to select "FLAT".

Note

- The sound quality setting is stored automatically. It is recalled when "MANUAL" is next selected.
- All recordings are performed at the flat setting even if an alternative sound quality setting has been selected.

Sound quality / sound field operations

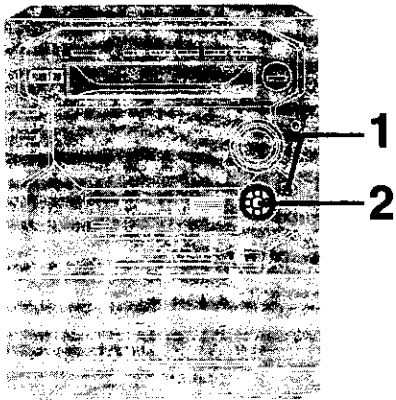
A**A**

Varying the sound quality with the acoustic image (AI) equalizer (3D AI EQ)

It is possible to use the acoustic image equalizer (AI EQ) together with the surround effect to create your own sound effect. The AI EQ equalizer uses the SOFT, SHARP, HEAVY and LIGHT sound quality coordinates to achieve subtle sound quality settings with ease.

1. Press [3D AI EQ] to adjust the surround level.

Every time you press the button;
AI EQ → 3D AI 1 → 3D AI 2

2. Adjust the sound quality.

- ① ← → direction : SOFT-SHARP setting
- ② ↓ ↑ direction : LIGHT-HEAVY setting

Repeat steps ① and ② to set the desired sound quality.

The original display is restored on the display panel in about 5 seconds.

To release the equalizer

Dial [SOUND CONTROL JOG] to select "FLAT".

Note

- The sound quality setting is stored automatically. It is recalled when "AI EQ" is next selected.
- All recordings are performed at the flat setting even if an alternative sound quality setting has been selected.

1

3D AI EQ

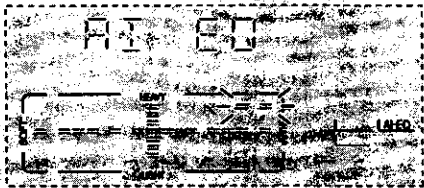
**2**

①

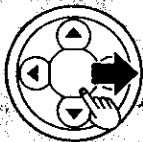
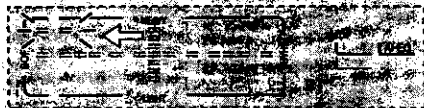
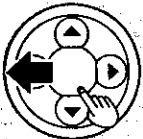

②

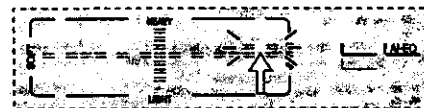
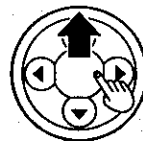
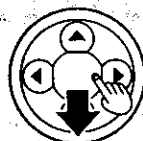

Adjusting speakers output level

Remote control only

If the level of the speakers appears to be different while listening to a source, sit where you would normally and perform the following to adjust the level of all the speakers to the same apparent level.

1. Press [DOLBY PRO LOGIC].

The [DOLBY PRO LOGIC] indicator lights.

2. Adjust the volume of the center and surround speakers.

Sit in the normal listening position and make the adjustments with the remote control.

① Press [TEST].

A test signal is output.
The speaker outputting the test signal will flash while the test is running.
L: Front speaker (Left)
C: Center speaker
R: Front speaker (Right)
S: Surround speakers

② Press [VOLUME (- or +)].

Set the volume to the normal listening level.

The following steps are for setting the output level of the center speaker and the surround speakers.

③ Press [CH SELECT].

Select the speaker channel to be adjusted.

④ Press [CH LEVEL (- or +)].

Adjust the output level to the same listening level as the front speakers.
+ : Increases the output level
- : Decreases the output level
Repeat steps ③ and ④ to adjust the level accordingly.

To stop the test signal

Press [TEST] again.

Note

- All the features are only effective if speakers are used. No discernible effect will be heard through headphones.
- This mode cannot be used with the radio mode.

To playback a Dolby Surround source with Dolby Pro Logic

1. Press [DOLBY PRO LOGIC].

The [DOLBY PRO LOGIC] indicator lights.

2. Playback a Dolby Surround source.

To turn off DOLBY PRO LOGIC

Press [DOLBY PRO LOGIC].

The [DOLBY PRO LOGIC] indicator goes out.

Reference:

Software with the following mark is recorded in Dolby Pro Logic:

- Laser Disc
- DVD
- Video tape (VCR)
- CD

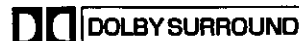

Manufactured under license from Dolby Laboratories Licensing Corporation. DOLBY, the double-D symbol DD and "PRO LOGIC" are trademarks of Dolby Laboratories Licensing Corporation.

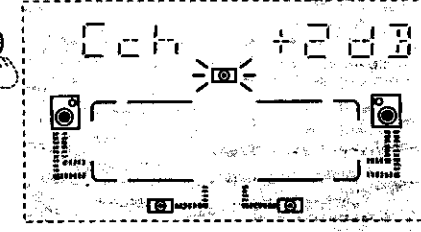
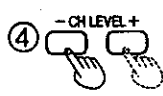
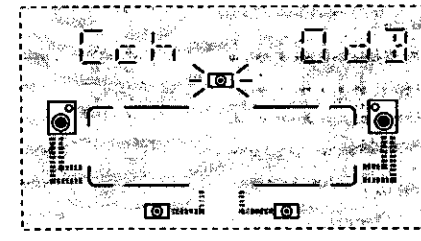
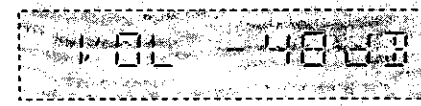
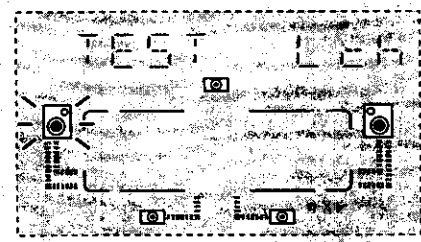
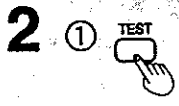
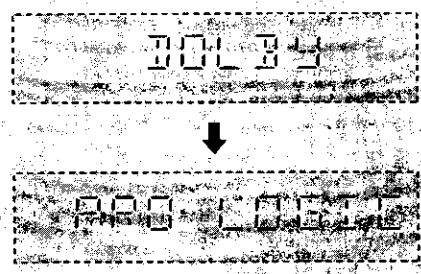
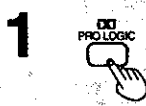
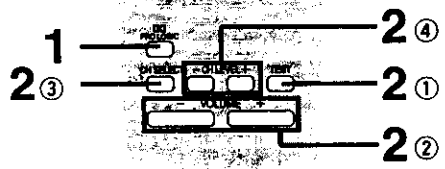

Sound quality / sound field operations

Using the play timer

Preparations

- Switch on the power.
- Make sure that you have completed "Setting the time" on page 13. The figure shows how to set the play timer to play from 6:30 a.m. to 7:40 a.m.

1. Press [CLOCK/TIMER] to select "⊖ PLAY".

Every time you press the button;

CLOCK → ⊖PLAY → ⊖REC → Previous display

2. "ON" time setting

(Within 8 seconds or so)

- ① Press [TUNE/TIME ADJ (√ or ^)] to select the starting time.
- ② Press [CLOCK/TIMER].

3. "OFF" time setting

- ① Press [TUNE/TIME ADJ (√ or ^)] to select the ending time.
- ② Press [CLOCK/TIMER].

4. Source selection

Select the desired source and then prepare for playing.

To play CD(s)

Press [CD] and insert CD(s).

If more than 1 CD is loaded

Press [CD 1] – [CD 5] to select the CD you want to hear first, and press [■].

Note

Disc selection does not become part of the timer memory.

To play tape(s)

Press [TAPE DECK 1/2] and insert tape(s).

If tapes are loaded in both decks, playback will start from deck 2.

To play the radio

Press [TUNER BAND] and tune in the desired station.

To play the external unit

Press [AUX].

5. Play volume setting

Turn [VOLUME] to adjust the playback volume.

6. Press [⊕ PLAY/ ⊖ REC] to select "⊕ PLAY".

Every time you press the button;

⊕PLAY → ⊖REC → (off)

7. Press [⏻/I, POWER] to switch off the power.

The timer play will start at the preset time with volume increasing gradually up to the volume level you preset.

To switch the timer OFF

Press [⊖ PLAY/ ⊖ REC] and check "⊖ PLAY" goes out.

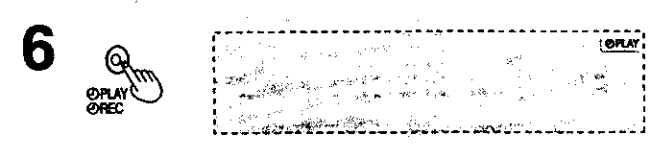
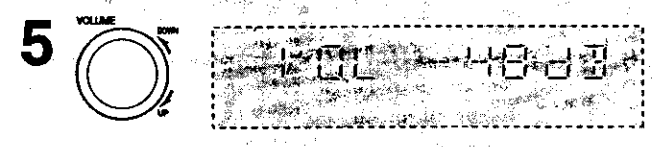
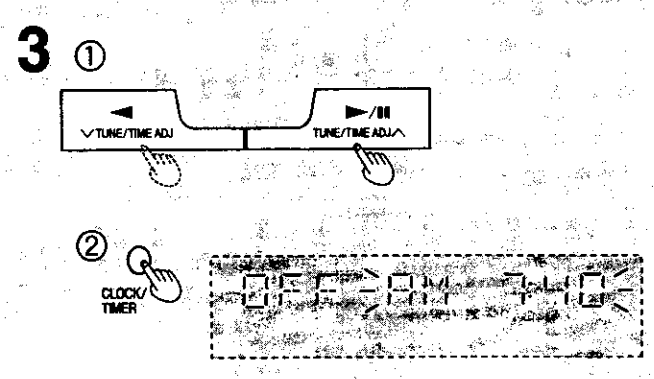
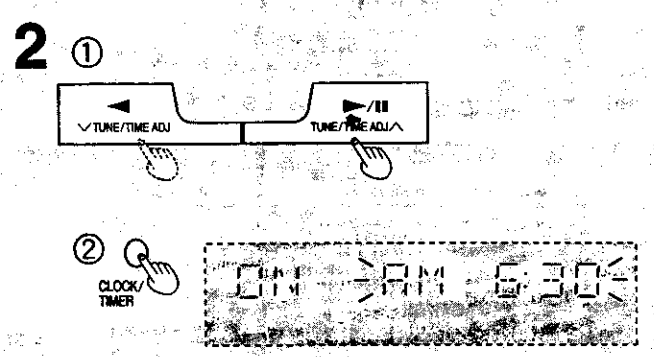
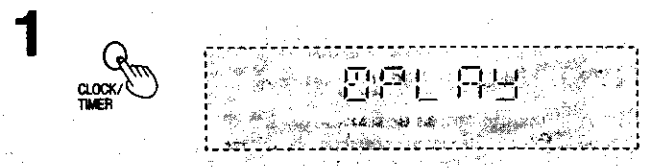
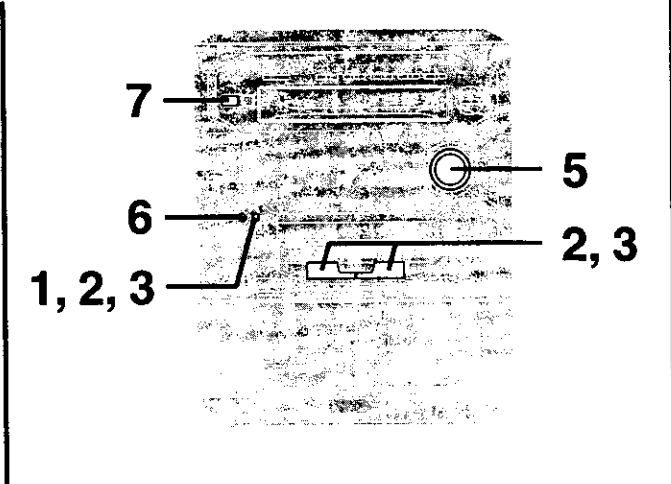

Timer and others

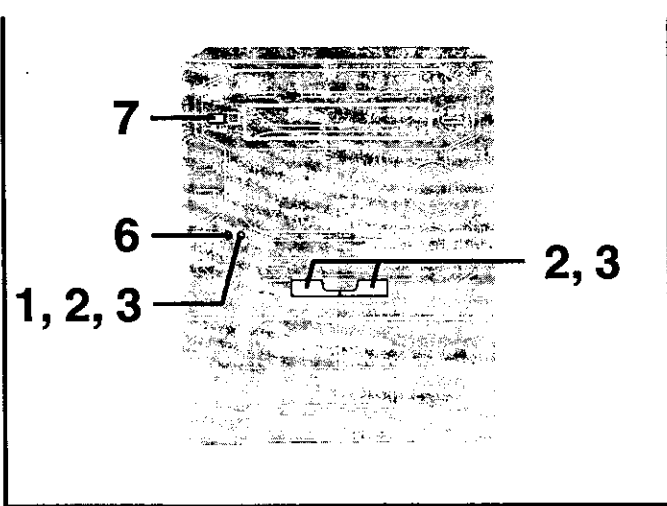

Using the record timer

Preparations

- Switch on the power.
- Make sure that you have completed "Setting the time" on page 13.

Set the timer at least 2 minutes before you want to start recording.

The figure shows how to set the record timer for recording from 6:30 p.m. to 8:00 p.m.

1. Press [CLOCK/TIMER] to select "⌚ REC".

Every time you press the button;

CLOCK → ⌚PLAY → ⌚REC → Previous display

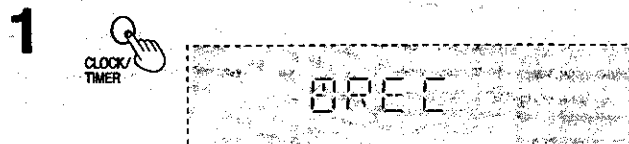

2. "ON" time setting

(Within 8 seconds or so)

- 1 Press [TUNE/TIME ADJ (∨ or ∧)] to select the starting time.
- 2 Press [CLOCK/TIMER].

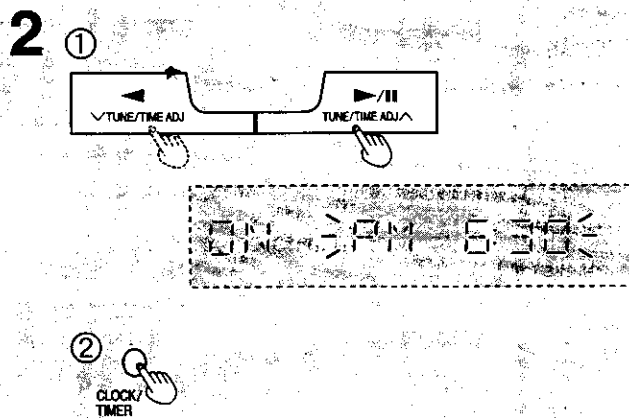

3. "OFF" time setting

- 1 Press [TUNE/TIME ADJ (∨ or ∧)] to select the ending time.
- 2 Press [CLOCK/TIMER].

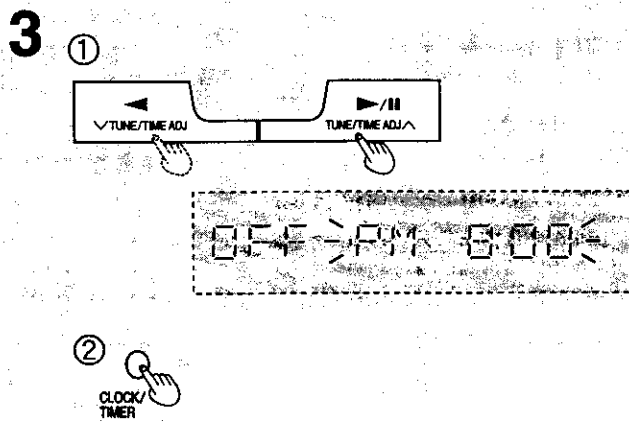

4. Source selection

Select the desired source and then prepare for recording.

To record from the radio

Press [TUNER BAND] to select the band and tune in the desired station.

To record the external unit

Press [AUX].

5. Prepare for recording.

1. Insert a tape into deck 2 with the side on which the recording will start facing you.
2. Select the reverse mode.

Note

Reverse mode does not become part of the timer memory.

6. Press [⌚ PLAY/⌚ REC] to select "⌚ REC".

Every time you press the button;

⌚PLAY → ⌚REC → (off)

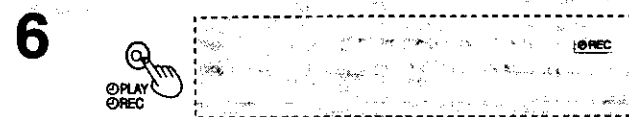

7. Press [⏻/I, POWER] to switch off the power.

About 30 seconds before the set time, the system mutes all sound automatically.



To switch the timer OFF

Press [⌚ PLAY/⌚ REC] and check "⌚ REC" goes out.

Timer and others

Using the play/record timer

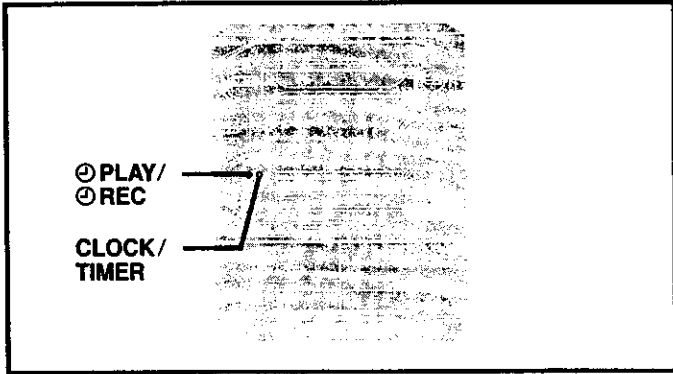

If you set the timer incorrectly
Repeat the procedure from step 1.

To check settings

While the unit is on and the "⊙ PLAY" (or "⊙ REC") indicator is on, press [CLOCK/TIMER] so "⊙ PLAY" (or "⊙ REC") appears on the display.

Two seconds after "⊙ PLAY" (or "⊙ REC") appears, the settings are displayed in the following order.

- For play timer
 - ① Play start time
 - ② Play end time
 - ③ Play source
 - ④ Playback volume
- For record timer
 - ① Recording start time
 - ② Recording end time
 - ③ Recording source

To enjoy the desired source after the timer setting is completed

The volume level and music source are stored in the timer memory and the timer will start in these preset conditions. However the Disc number and reverse mode do not get stored in the timer memory.

1. After step 7, turn on the unit and start playing the desired source.
2. Reset the Disc number and reverse mode if you have changed any of them, confirm that a Disc or cassette is inserted, then press [⊙/1, POWER] to put the unit on standby.

Turning the timer ON/OFF

One of the timers is on when the [⊙ PLAY/ ⊙ REC] button is alight. When the unit is on (or off and NORMAL mode) you can confirm which is on by checking the indicators on the display.

When the unit is off and in ECO mode, press [CLOCK/TIMER].

The display will then show which timer is on and the settings that have been made (see above).

To change the timer, press [⊙ PLAY/ ⊙ REC].

Each time the button is pressed the setting changes as follows.

⊙PLAY → ⊙REC → (off)

Note

- If the power is on, the timer will not function. The system must be in the standby mode.
- If you switch the power to the standby mode while the play/record timer is functioning, the OFF time setting will not be activated.
- If "AUX" is selected as the source, when the timer comes ON, the system will turn ON and will engage "AUX" as the source. If you want to playback or record from a connected component, set the component's timer to the same time. (See the instruction manual that came with the component.)
- The play timer cannot be used in combination with the record timer.

Using the sleep timer

This timer turns power to your system OFF at the set time (Max. 2 hours, settable at 30 minute intervals). It lets you fall asleep listening to music.

by remote control only

The figure shows how to set the system to standby mode after 30 minutes.

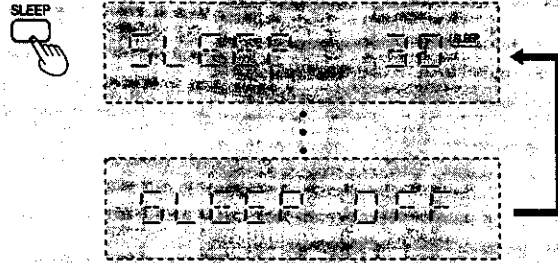
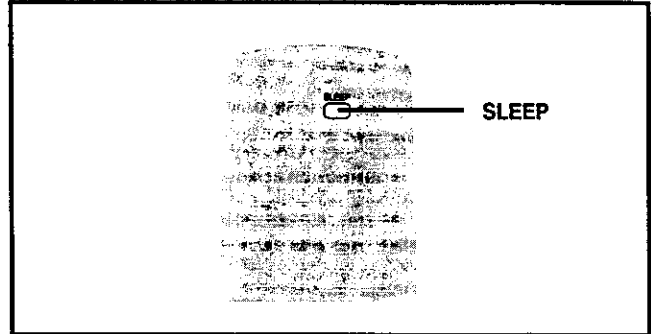

While enjoying the desired source:

Press [SLEEP] to select the desired time.

Every time you press the button;

30 → 60 → 90 → 120 → OFF

The system is turned off after the set time has elapsed.

To cancel the sleep timer:

Press [SLEEP] to select "OFF".

To confirm the remaining time:

(only while power is ON)

Press [SLEEP].

To change the time remaining during operation:

Press [SLEEP] to show the remaining time then press [SLEEP] to select the desired time.

Note

- The sleep timer turns OFF automatically the moment you attempt to edit-record a CD using CD Manager function.
- The sleep timer can be used in combination with the play/record timer.
The sleep timer always has priority.
Be sure not to overlap timer settings.

Using an external unit

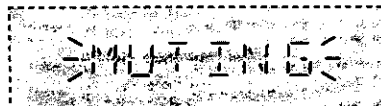
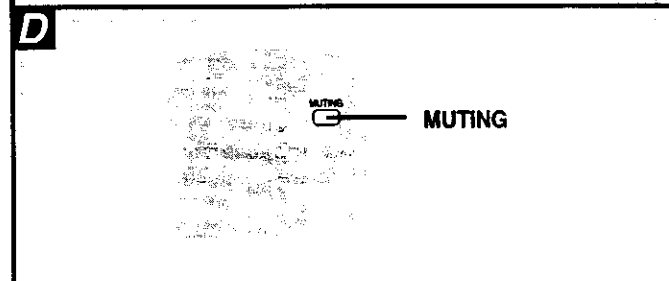
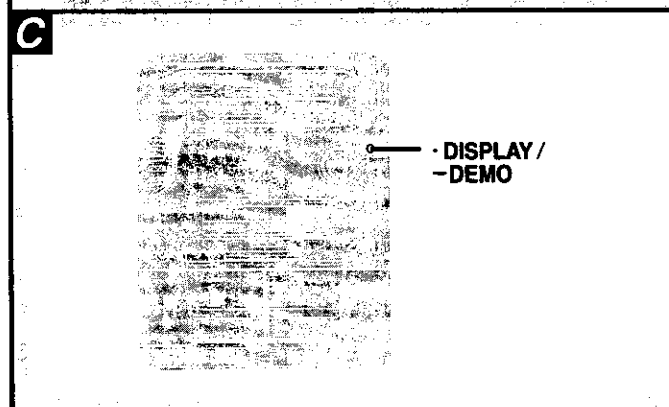
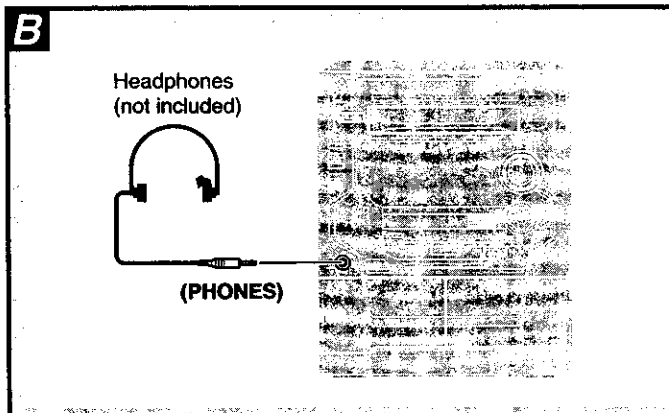
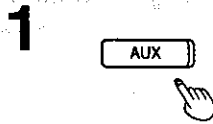
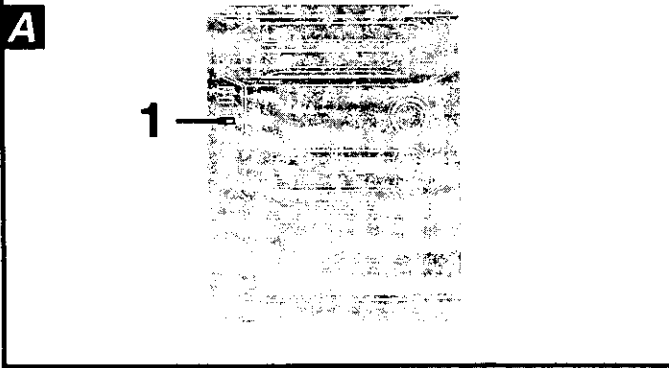

A Listening to an external source

(See page 9 for external unit connection.)

1. Press [AUX].

The power will come on automatically.

2. Start playback from the external source.

(For details, refer to the owner's manual of the equipment.)

Recording from an external source

1. Press [▲ DECK 2 OPEN] and insert the tape.

Close the holder by hand.

2. Press [REV MODE] to select the reverse mode.

3. Press [AUX] to select the external source.

4. Press [● REC/STOP].

Recording starts.

5. Start playback from the external source.

(For details, refer to the owner's manual of the equipment.)

B Listening with headphones

Reduce the volume level, and connect the headphones.
Plug type: 3.5 mm stereo

Note

Avoid listening for prolonged periods of time to prevent hearing damage.

Convenient functions

C Switching displays

Press [-DISPLAY/-DEMO] to select the desired spectrum analyzer.

Every time you press the button;

NORMAL → Peak hold → Aurora → off (Dimmer)

When the spectrum analyzer is off, the display is dimmed and indicators, except for the AC supply indicator, are turned off for better television viewing.

D To mute the volume

by remote control only

This feature is convenient when you have a telephone call, etc.

Press [MUTING].

Press the button again to cancel.

"MUTING" goes out.

Muting can also be cancelled by lowering the volume all the way (--- dB).

When the system is turned off, the muting operation will be automatically cancelled.

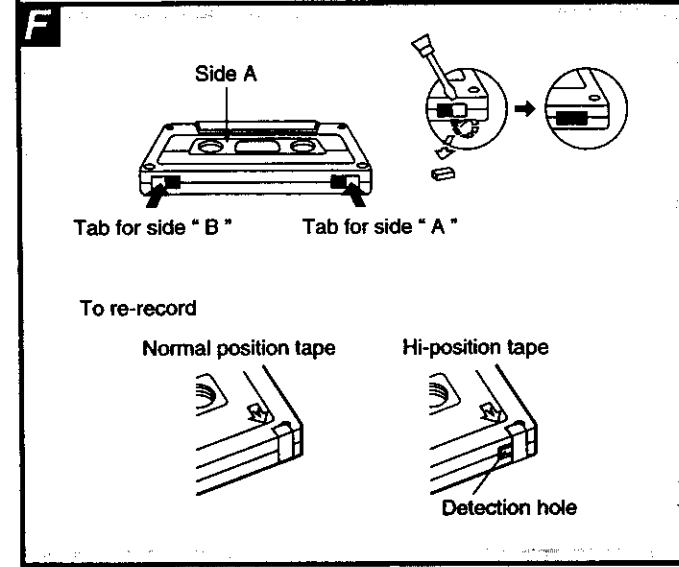
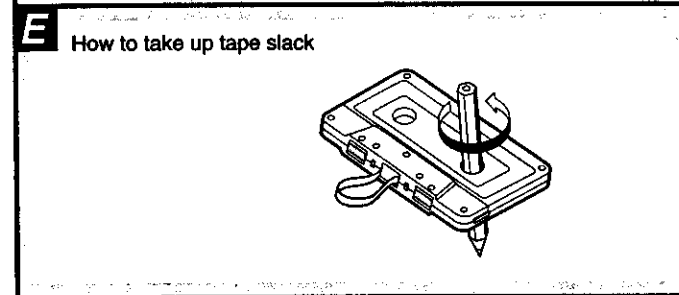
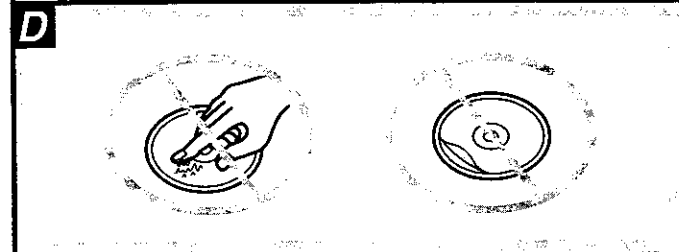
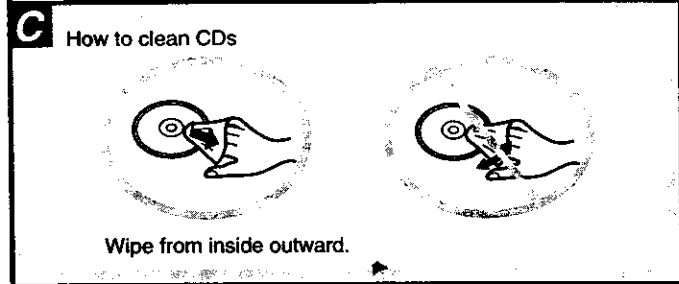
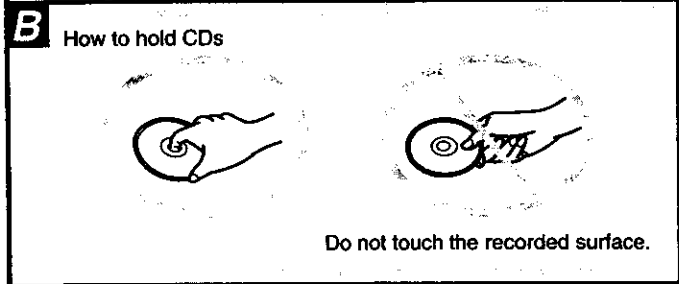
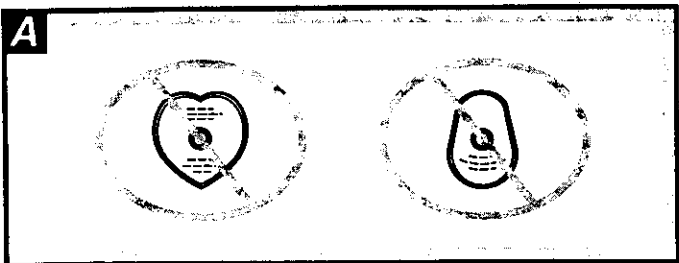

Concerning CDs

With this system, you can only play CDs having this mark.



⚠ However, do not use irregular shaped CDs. CDs of the sort can damage the unit.

B - D Handling precautions

- If you are taking the CD from a cold to a warm environment, moisture may form on the CD. Wipe this off with a soft, dry, lint-free cloth before using the CD.
- Do not write on the label side with a ball-point pen or other writing instrument.
- Do not use record cleaning sprays, benzine, thinner, static electricity prevention liquids or any other solvent.
- Do not attach labels or stickers to CDs. (Do not use CDs with exposed adhesive from tape or left over peeled off stickers.)
- Do not use scratch-proof protectors or covers other than those specified for use with this system.
- Do not use CDs printed with label printers available on the market.

Storage precautions

Be sure to store CDs in their cases to protect them from dust, scratches, and warping.

Do not place or store CDs in the following places

- Locations exposed to direct sunlight
- Humid or dusty locations
- Locations directly exposed to a heat vent or heating appliance
- In the glove compartment or on the rear deck of an automobile

Concerning cassette tapes

Selection of cassette tapes

Tapes can get caught on the capstans. Use caution with the following types of tapes.

Cassette tapes exceeding 100 minutes

Tapes are made of a thin film material. Do not repeatedly advance and stop the tape, fast-forward it or rewind it.

Endless-tapes

For this unit, it is recommended to use tapes which are appropriate to the auto reverse mechanism.

Always read the instructions provided with your tapes.

E Tape slack

Tape slack may cause the tape to break.

F Erasure prevention

Use a screwdriver or similar object to break out the tab.

To re-record on a protected cassette

Cover the hole with adhesive tape. Do not cover the detection hole on hi-position tapes.

Storage precautions

Do not place or store tapes in the following places;

- In high temperature (35°C or higher) or high humidity (80% or higher) areas
- In a strong magnetic field (near a speaker, on top of a TV, etc.) This can erase a recording.
- Locations exposed to direct sunlight

Reference

Before requesting service for this unit, check the chart below for a possible cause of the problem you are experiencing. Some simple checks or a minor adjustment on your part may eliminate the problem and restore proper operation.

If you are in doubt about some of the check points, or if the remedies indicated in the chart do not solve the problem, refer to the directory of Authorized Service Centers (enclosed with this unit) to locate a convenient service center, or consult your dealer for instructions.

For detailed instructions, contact an authorized servicenter in the U.S.A. and Panasonic Canada Inc. Customer Care Centre in Canada. In the U.S.A. 1-800-211-7262 or web site (<http://www.panasonic.com>) In Canada 905-624-5505 or web site (www.panasonic.ca)

Problem	Probable cause(s)	Suggested remedy	Reference page(s)
Problems common to all systems			
ECO mode is on but the display panel still lights up.	DEMO mode is on.	Turn DEMO mode off.	12
The location of the various musical instruments is not well defined.	The (+) and (-) connections to one of the speakers are reversed.	Connect the speaker cords correctly.	7
The left and right sounds are reversed.	The left and right connections to the speaker are reversed.	Connect the speaker cords correctly.	7
LOW frequency sounds cannot be heard.	Either the left or the right LOW speaker cable is not connected.	Connect the left and right speaker cables to the LOW terminals.	7
When listening to the external unit, the left and right sounds are reversed.	The left and right connections to the external unit are reversed.	Connect the external unit's cord correctly.	9
There is no sound when a source is being played.	The (+) and (-) wire of the speaker cords are shorted.	Switch the system to the standby mode, and reconnect the speaker cords so that they are not shorted. Then switch on the power.	7
"ERROR" message appears on the display.	Incorrect operation has been done.	Operate the unit correctly by following the operating instructions.	—
"---:---" appears on the display.	<ul style="list-style-type: none"> • You plugged the power cord in for the first time. • There was a power failure recently. 	Set the time.	13
"F61" appears on the display.	Check if the speaker cords have shorted.	If they are not shorted then there is a power supply problem. Consult your dealer for assistance.	—
There is no operation when [(CD 1) ~ (CD 5)] / [TAPE] / [CD] / [TUNER] / [AUX] is pressed during system standby mode.	There was a power failure or the power cord was disconnected from the household AC outlet <ul style="list-style-type: none"> • during disc changing operation or • when the disc tray is opened. 	1. Press [⏻/⏪] to switch on the power. 2. If the tray opens, remove the CD and press [▶] of [CD 1] to close the tray. The system will restore normal operation.	—

While listening to FM broadcasts			
There is a "rushing noise" during a stereo broadcast which is not audible during a monaural broadcast.	The transmitting station is distant.	If you are using an indoor antenna, change to an outdoor antenna.	8
You hear excessive noise during a stereo broadcast, and occasionally the sound disappears.	The installation location and orientation of the antenna are unsuitable.		
The stereo indicator ("ST") flickers and does not light completely.	The transmitting station is distant.	Try switching off the TV set or VCR.	—
	The power of the TV set or VCR is ON.		
The sound during a stereo broadcast is highly distorted.	There is a building or mountain nearby. [Distortion is caused by interference between the signal from the transmitting station (direct wave) and the signal reflected from the building or mountain (reflected wave).]	Use a high-grade outdoor antenna, and install it in a good location, height, and orientation for reception.	8

Problem	Probable cause(s)	Suggested remedy	Reference page(s)
While listening to AM broadcasts			
You hear an unusual beat sound.	You are using the system at the same time you are playing a TV set.	Switch off the TV set, or use the system further away from it.	—
You hear a low-frequency hum.	The antenna wire is near the power cord.	Separate the antenna wire from the power cord.	—
When there is a television set nearby			
The picture on the TV disappears or stripes appear on the screen.	The location and orientation of the antenna are incorrect.	If you are using an indoor antenna, change to an outdoor antenna.	8
	The wiring at the back of the system is unsuitable.	Separate the antenna wire of the TV set from the system.	—
While using the cassette deck			
Sound is low, intermittent, poor quality, noisy, scratchy, or unsteady.	Heads are dirty.	Clean the heads.	37
The deck does not enter the recording mode.	The erase-prevention tabs have been removed from the cassette.	Attach tape to cover the space left by removal of the erase-prevention tabs.	35
While listening to compact discs			
The display does not show the correct indication. Disc play does not start when you press the play button.	The disc is upside down.	Set the disc with the label facing upward.	16
	The disc is dirty.	Wipe the disc with a soft cloth.	35
	The disc is scratched.	Replace the disc with a new one.	—
	The disc is badly warped.		
	The disc is a nonstandard one.	Replace the disc with a different one.	35
There is condensation inside the CD changer.	Wait for 60 minutes before using the CD player.	—	
A certain music passage can't be played correctly.	The disc is dirty.	Wipe the disc with a soft cloth.	35
"TAKE OUT DISC" appears on the display.	There is a problem with the CD mechanism. (A power failure may have occurred.)	The tray will open automatically. Remove the CD and press [△] of [CD 1] to close the tray. The system will restore normal operation.	—
While using the remote control			
The system cannot be operated with the remote control.	The batteries are installed in the reverse polarity.	Re-insert the batteries observing the correct polarity.	5
	The batteries are run-down.	Replace the batteries with new batteries.	5

Maintenance

If the surfaces are dirty

To clean this unit, wipe with a soft, dry cloth. If the surfaces are extremely dirty, use a soft cloth dipped in a soap-and-water solution or a weak detergent solution.

- Never use alcohol, paint thinner or benzine to clean this unit.
- Before using chemically treated cloth, read the instructions that came with the cloth carefully.

For a cleaner crisper sound

Clean the heads regularly to assure good quality playback and recording. Use a cleaning tape (not included).

AMPLIFIER SECTION

Front speaker power output
RMS power output
 THD 1.0% , both channels driven
 60 Hz–120 Hz
 70 W per channel (6 Ω)
 120 Hz–14 kHz
 30 W per channel (6 Ω)
Total Bi-amp power
 100 W per channel

Power output in

Dolby Pro Logic mode

RMS power output

THD 1.0% both channels driven
Front 60 Hz – 120 Hz
 70 W per channel (6 Ω)
Front 120 Hz – 14 kHz
 30 W per channel (6 Ω)
Center 1 kHz
 30 W (8 Ω)
Surround 1 kHz
 15 W per channel (4 Ω)
Total power output 260 W

Input sensitivity

AUX 250 mV

Input Impedance

AUX 13.9 kΩ

FM TUNER SECTION

Frequency range

87.9 – 107.9 MHz (200 kHz step)
 87.5 – 108.0 MHz (100 kHz step)

Sensitivity 2.5 μV (IHF)

S/N 26 dB 2.2 μV

Antenna terminal(s) 75 Ω (unbalanced)

AM TUNER SECTION

Frequency range 520 – 1710 kHz (10 kHz step)

Sensitivity

S/N 20 dB 560 μV/m

CASSETTE DECK SECTION

Track system 4 track, 2 channel

Heads

Record/playback Solid permalloy head

Erasure Double gap ferrite head

Motor DC servo motor

Recording system AC bias 100 kHz

Erasing system AC erase 100 kHz

Tape speed 4.8 cm/s (1 7/8 ips)

Overall frequency response

(+3, –6 dB at DECK OUT)

NORMAL (TYPE I) 35 Hz – 14 kHz

HIGH (TYPE II) 35 Hz – 14 kHz

S/N 50 dB (A weight)

Wow and flutter 0.18% (WRMS)

Fast forward and rewind times

Approx. 120 seconds with C-60 cassette tape

CD SECTION

Sampling frequency 44.1 kHz

Decoding 16 bit linear

Beam Source/Wavelength Semiconductor laser/780nm

Frequency response 20 Hz – 20 kHz (+1, –2 dB)

Wow and flutter Below measurable limit

Digital filter 8 fs

D/A converter MASH (1 bit DAC)

SPEAKER SECTION

• Front speakers (SB-AK58)

Type 3 way speaker system

Speaker(s)

Super woofer 17 cm (6 11/16") cone type

Woofer 12 cm (4 23/32") cone type

Tweeter 6 cm (2 3/8") cone type

Impedance

HIGH 6 Ω

LOW 6 Ω

Input power

HIGH 60 W (Music)

LOW 140 W (Music)

Output sound pressure level 87 dB/W (1.0 m)

Cross over frequency 150 Hz, 5 kHz

Frequency range 45 Hz – 22 kHz (–16 dB)

55 Hz – 20 kHz (–10 dB)

Dimensions (WxHxD) 220 x 330 x 302 mm
 (8 21/32" x 13" x 11 7/8")

Weight 4.6 kg (10.1 lb.)

• Surround speakers (SB-PS55)

Type 1 way, 1 speaker, Dipole type

Speaker

Full range 8 cm cone type

Impedance 4 Ω

Input power 35 W (Music), 17.5 W (DIN)

Output sound pressure level 85 dB/W (1.0 m)

Frequency range 190 Hz – 20 kHz (–16 dB)

Dimensions (WxHxD) 180 x 108 x 142 mm
 (7 3/32" x 4 1/4" x 5 19/32")

Weight 0.7 kg (1.54 lb.)

• Center speaker (SB-PC55)

Type 1 way, 1 speaker

Speaker

Full range 8 cm cone type

Impedance 8 Ω

Input power 70 W (Music), 35 W (DIN)

Output sound pressure level 85 dB/W (1.0 m)

Frequency range 110 Hz – 18 kHz (–16 dB)

Dimensions (WxHxD) 252 x 121 x 150 mm
 (9 29/32" x 4 3/4" x 5 29/32")

Weight 0.9 kg (1.98 lb.)

GENERAL

Power supply AC 120 V, 60 Hz

Power consumption 170 W

Standby

Normal mode 18 W

Eco mode 0.25 W

Dimensions (WxHxD) 270 x 331 x 338 mm
 (10 5/8" x 13 1/32" x 13 5/16")

Weight 8.3 kg (18.3 lb.)

Power consumption in standby mode

Eco mode on 0.25 W

Eco mode off 18 W

Note

- Specifications are subject to change without notice.
 Mass and dimensions are approximate.
- Total harmonic distortion is measured by the digital spectrum analyzer.

Do not attempt to remove the cover(s) or repair the unit yourself. Refer servicing to qualified personnel only.

Product information

For product service, product information or assistance with product operation, refer to the servicenter directory.

Servicenter List (US)

Panasonic

Technics

Quasar

*For Product Information, Operating Assistance, Literature Request, Dealer Locations, and all Customer Service inquiries please contact:
1-800-211-PANA (7262), Monday-Friday 9 am-9 pm; Saturday-Sunday 9 am-7 pm, EST.*

*Web Site: <http://www.panasonic.com>
You can purchase parts, accessories or locate your nearest servicenter by visiting our Web Site.*

Accessory Purchases:

1-800-332-5368 (Customer Orders Only)
Panasonic Services Company 20421 84th Avenue South, Kent, WA 98032
(6 am to 5 pm Monday-Friday; 6 am to 10:30 am Saturday; PST)
(Visa, MasterCard, Discover Card, American Express, Check)

Factory Servicenters Locations

CALIFORNIA

6550 Katella Avenue
Cypress, CA 90630

800 Dubuque Avenue
S. San Francisco
CA 94080

20201 Sherman Way
Suite 102
Canoga Park, CA 91306

3878 Ruffin Road
Suite A
San Diego, CA 92123

COLORADO

1640 South Abilene Street
Suite D
Aurora, CO 80012

FLORIDA

3700 North 29th Avenue
Suite 102
Hollywood, FL 33020

GEORGIA

8655 Roswell Road
Suite 100
Atlanta, GA 30350

ILLINOIS

9060 Golf Road
Niles, IL 60714

1703 North Randall Road
Elgin, IL 60123
(Pick-up/Drop-off only)

MARYLAND

62 Mountain Road
Glen Burnie, MD 21061

MASSACHUSETTS

60 Glacier Drive
Suite G
Westwood, MA 02090

MICHIGAN

37048 Van Dyke Avenue
Sterling Heights, MI 48312

MINNESOTA

7850-12th Avenue South
Airport Business Center
Bloomington, MN 55425

OHIO

2236 Waycross Road
Civic Center Plaza
Forest Park, OH 45240

PENNSYLVANIA

2221 Cabot Blvd. West
Suite B
Langhorne, PA 19047

Chartiers Valley
Shopping Center
1025 Washington Pike
Bridgeville, PA 15017

TENNESSEE

3800 Ezell Road
Suite 806
Nashville, TN 37211

TEXAS

7482 Harwin Drive
Houston, TX 77036

13615 Welch Road
Suite 101
Farmers Branch
TX 75244

WASHINGTON

20425-84th Avenue South
Kent, WA 98032

HAWAII

99-859 Iwaiwa Street
Aiea, Hawaii 96701
Phone (808) 488-1996
Fax (808) 486-4369

Service in Puerto Rico

*Matsushita Electric of Puerto Rico, Inc. Panasonic Sales Company/Factory Servicenter:
Ave. 65 de Infanteria, Km. 9.5, San Gabriel Industrial Park, Carolina, Puerto Rico 00985
Phone (787) 750-4300 Fax (787) 768-2910*

Reference

**Panasonic Consumer Electronics
Company, Division of Matsushita
Electric Corporation of America**
One Panasonic Way Secaucus,
New Jersey 07094
<http://www.panasonic.com>

**Panasonic Sales Company,
Division of Matsushita Electric of
Puerto Rico, Inc. ("PSC")**
Ave. 65 de Infanteria, Km. 9.5
San Gabriel Industrial Park, Carolina,
Puerto Rico 00985

Panasonic Canada Inc.
5770 Ambler Drive,
Mississauga, Ontario
L4W 2T3
www.panasonic.ca



Free Manuals Download Website

<http://myh66.com>

<http://usermanuals.us>

<http://www.somanuals.com>

<http://www.4manuals.cc>

<http://www.manual-lib.com>

<http://www.404manual.com>

<http://www.luxmanual.com>

<http://aubethermostatmanual.com>

Golf course search by state

<http://golfingnear.com>

Email search by domain

<http://emailbydomain.com>

Auto manuals search

<http://auto.somanuals.com>

TV manuals search

<http://tv.somanuals.com>