

CRAIG®

**DUAL SCREEN 7 INCH
PORTABLE DVD/CD
PLAYER**

Owner's Manual

PLEASE READ BEFORE OPERATING THIS EQUIPMENT.

Model: CTFT719



IMPORTANT SAFETY INSTRUCTION



CAUTION: TO REDUCE THE RISK OF ELECTRIC SHOCK, DO NOT REMOVE COVER (OR BACK). NO USER-SERVICEABLE PARTS INSIDE. REFER SERVICING TO QUALIFIED SERVICE PERSONNEL.

CAUTION:
THIS DIGITAL VIDEO DISC PLAYER EMPLOYS A LASER SYSTEM.
TO ENSURE PROPER USE OF THIS PRODUCT, PLEASE READ THIS OWNER'S MANUAL CAREFULLY AND RETAIN FOR FUTURE REFERENCE. SHOULD THE UNIT REQUIRE MAINTENANCE, CONTACT AN AUTHORIZED SERVICE LOCATION-SEE SERVICE PROCEDURE.
USE CONTROLS, ADJUSTMENTS OR THE PERFORMANCE OF PROCEDURES OTHER THAN THOSE SPECIFIED HEREIN MAY RESULT IN HAZARDOUS RADIATION EXPOSURE.
TO PREVENT DIRECT EXPOSURE TO LASER BEAM, DO NOT TRY TO OPEN THE ENCLOSURE. VISIBLE LASER RADIATION MAY BE PRESENT WHEN THE ENCLOSURE IS OPENED. DO NOT STARE INTO BEAM.

WARNING:
TO REDUCE THE RISK OF FIRE OR ELECTRIC SHOCK, DO NOT EXPOSE THIS PRODUCT TO RAIN OR MOISTURE.

WARNING:
TO REDUCE THE RISK OF FIRE OR ELECTRIC SHOCK, AND ANNOYING INTERFERENCE, USE THE RECOMMENDED ACCESSORIES ONLY.

SURGE PROTECTORS:
It is recommended to use a surge protector for AC connection. Lightning and power surges ARE NOT covered under warranty for this product.

 The lightning flash with arrowhead symbol within an equilateral triangle is intended to alert the user to the presence of uninsulated dangerous voltage within the product's enclosure that may be of sufficient magnitude to constitute a risk of electric shock to persons.

 The exclamation point within an equilateral triangle is intended to alert the user to the presence of important

operating and maintenance(servicing) instructions in the literature accompanying the appliance.

DANGER:
 Invisible and hazardous laser radiation when open and interlock failed or defeated. Avoid direct exposure to beam.

FCC NOTICE:
This equipment has been tested and found to comply with the limits for a Class B digital device, pursuant to part 15 of the FCC Rules. These limits are designed to provide reasonable protection against harmful interference in a residential installation. This equipment generates, uses and can radiate radio frequency energy and, if not installed and used in accordance with the instructions, may cause harmful interference to radio communications.
However, there is no guarantee that interference will not occur in a particular installation. If this equipment does cause harmful interference to radio or television reception, which can be determined by turning the equipment off and on, the user is encouraged to try to correct the interference by one or more of the following measures:

- Reorient or relocate the receiving antenna. Increase the separation between the equipment and receiver.
- Connect the equipment into an outlet on a circuit different from that to which the receiver is connected.
- Consult the dealer or an experienced radio/TV technician for help.

FCC WARNING:
To assure continued compliance, follow the attached installation instructions and use only shielded cables when connecting to other devices. Modifications not authorized by the manufacturer may void user's authority to operate this device.

WARNING
USE UNDER SUPERVISION OF AN ADULT DUE TO LONG CORD
This unit has a long AC cord or other long cord that can easily be tripped on or pulled on, causing injury. Please make sure it is arranged so it will not drape over a tabletop, etc. Where it can be pulled on by children or tripped over accidentally.

EXERCISE CAUTION AS UNIT HAS SHARP POINTS.





IMPORTANT SAFETY INSTRUCTION

Before using the unit, be sure to read all operating instructions carefully. Please note that these are general precautions and may not pertain to your unit.

1) Read these instructions.

All the safety and operating instructions should be read before the product is operated.

2) Keep these instructions.

The safety and operating instructions should be retained for future reference.

3) Heed all warnings.

All warnings on the product and in the operating instructions should be adhered to.

4) Follow all instructions.

All operating and use instructions should be followed.

5) Do not use this apparatus near water.

Do not use this product near water and moisture, for example: near a bathtub, washbowl, kitchen sink or laundry tub; in a wet basement; or near a swimming pool.

6) Clean only with dry cloth.

Unplug this product from the wall outlet before cleaning. Do not use liquid cleaners or aerosol cleaners. Use a dry cloth for cleaning.

7) Do not block any ventilation openings. Install in accordance with the manufacturer's instructions.

Slots and openings in the cabinet and in the back or bottom are provided for ventilation, to ensure reliable operation of the product and to protect it from overheating. These openings must not be blocked or covered. The openings should never be blocked by placing the product on a bed, sofa, rug or other similar surface. This product should never be placed near or over a radiator or heat source. This product should not be placed in a built-in installation such as a bookcase or rack unless proper ventilation is provided or the manufacturer's instructions have been adhered to.

8) Do not install near any heat sources such as radiators, heat registers, stoves, or other apparatus(including amplifiers) that produce heat.

9) Do not defeat the safety purpose of the polarized or grounding-type plug. A polarized plug has two blades with one wider than the other. A grounding type plug has two blades and a

third grounding prong. The wide blade or the third prong are provided for your safety. If the provided plug does not fit into your outlet, consult an electrician for replacement of the obsolete outlet.

10) Protect the power cord from being walked on or pinched particularly at plugs, convenience receptacles, and the point where they exit from the apparatus.

11) Only use attachments/accessories specified by the manufacturer.

12) Use only with the cart, stand, tripod, bracket, or table specified by the manufacturer, or sold with the apparatus. When a cart is used, use caution when moving the cart/apparatus combination to avoid injury from tip-over.

An appliance and cart combination should be moved with care.

Quick stop, excessive force and uneven surfaces may cause the appliance and cart combination to overturn.



13) Unplug this apparatus during lightning storms or when unused for long periods of time.

To protect your product from a lightning storm, or when it is left unattended and unused for long periods of time, unplug it from the wall outlet and disconnect the antenna or cable system. This will prevent damage to the product due to lightning and power-line surges.

14) Refer all servicing to qualified service personnel. Servicing is required when the apparatus has been damaged in any way, such as power-supply cord or plug is damaged, liquid has been spilled or objects have fallen into the apparatus, the apparatus has been exposed to rain or moisture does not operate normally, or has been dropped.

15) Power source.

This product should be operated only from the type of power source indicated on the marking label. If you are not sure of the type of power supply to your home, consult your appliance dealer or local power company. For products intended to operate from battery power, or other source, refer to the operation instructions.

16) Power lines





IMPORTANT SAFETY INSTRUCTION

An outside antenna system should not be located in the vicinity of overhead power lines or other electric light or power circuits, or where it can fall into such power lines or circuits.

When installing an outside antenna system, extreme care should be taken to keep from touching such power lines or circuits as contact with them might be fatal.

17) Overloading

Do not overload wall outlets and extension cords as this can result in a risk of fire or electric shock.

18) Object and liquid entry

Never push objects of any kind into the product through openings as they may touch dangerous voltage points or short out parts that could result in fire or electric shock. Never spill or spray any type of liquid on the product.

19) Outdoor antenna grounding

If an outside antenna is connected to the product, be sure the antenna system is grounded so as to Provide some protection against voltage surges and built up static charges. Section 810 of the National Electric Code ANSI/NFPA 70 provides information with respect to proper to grounding of the mast and supporting structure, grounding of the lead-in wire to an antenna discharge product, size of grounding conductors, location of antenna-discharge product, connection to grounding electrodes and requirements for the grounding electrodes.

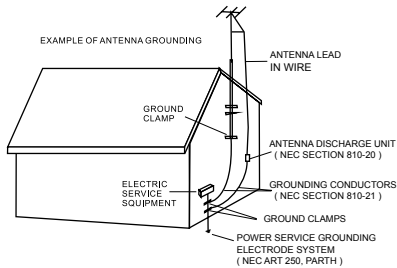

20) Service

Do not attempt to service this product yourself as opening or removing covers may expose you to dangerous voltage or other hazards. Refer all servicing to qualified service personnel.

21) Replacement parts

When replacement parts are required, be sure the service technician uses replacement parts

specified by the manufacturer or those that have the same characteristics as the original parts.

Unauthorized substitutions may result in fire or electric shock or other hazards.

22) Safety check

Upon completion of any service or repairs to this product, ask the service technician to perform safety checks to determine that the product is in proper operational condition.

23) Wall or ceiling mounting

The product should be mounted to a wall or ceiling only as recommended by the manufacturer.

24) Damage requiring service

Unplug this product from the wall outlet and refer service to qualified service personnel under the following conditions.

- a) When the power-supply cord or plug is damaged.
- b) If liquid has been spilled or objects have fallen into the product.
- c) If the product has been exposed to rain or water.
- d) If the product does not operate normally by following the operating instructions. Adjust only those controls that are covered by the operating instructions, as an adjustment of other controls may result in damage and will and require extensive work by a qualified technician to restore in the product to its normal operation.
- e) If the product has been dropped or the cabinet has been damaged.
- f) when the product exhibits a distinct change in performance-this indicates a need for service.

25) Note to CATV system installer

This reminder is provided to call the CATV system installer's attention to Article 820-40 of the NEC that provides guidelines for proper grounding and, in particular, specifies that the cable ground shall be connected to the grounding system of the building, as close to the point of cable entry as practical.

NOTE: Refer all servicing to qualified service personnel Servicing is required when the unit has been damaged in any way such as the following: the power-supply cored or plug has been damaged, liquid has been spilled into unit, the unit has been exposed to rain or moisture, the unit has been dropped or the unit does not operate normally.





IMPORTANT SAFETY INSTRUCTIONS(CONTINUED)

NOTES ON HANDLING:

- When shipping the unit, always use the original shipping carton and packing materials. For maximum protection, repack the unit as it was originally packed at the factory.
- Do not use volatile liquids, such as insect spray, near the unit. Do not leave rubber or plastic products in contact with the unit for a long time. They will leave marks on the finish.
- The top and rear panels of the unit may become warm after a long period of use. This is normal and not a malfunction.
- When the DVD player is not in use, be sure to remove the disc and turn off the power.

NOTES ON LOCATING THE DVD PLAYER:

When you place this unit near a TV, radio or VCR, the playback picture may become poor and the sound may be distorted. In this case, move the unit away from the TV, radio or VCR.

NOTES ON CLEANING:

Use a soft, dry cloth for cleaning

- For stubborn dirt, soak the cloth in a weak detergent solution, wring well and wipe. Use a dry cloth to wipe it dry. Do not use any type of solvent, such as thinner and benzene, as they may damage the surface of the unit.
- If you use a chemical-saturated cloth to clean the unit, follow that product's instructions.

Warning: Cleaning and adjustment of lenses and /or other components of playback mechanism should be performed by a qualified service technician.

NOTES ON MOISTURE CONDENSATION:

Moisture condensation damages the DVD player.

Please read the following carefully.

- Moisture condensation occurs, for example, when you pour a cold drink into a glass on a warm day. Drops of water form on the outside of the glass. In the same way, moisture may condense on the optical pick-up lens inside this unit, one of the most crucial internal parts of the DVD player.

Moisture condensation occurs during the following cases:

- When you bring the DVD player directly from a

cold place to a warm place.

- When you use the DVD player in a room where you just turned on the heater, or a place where the cold wind from the air conditioner directly hits the unit.
- In summer, when you use the DVD player in a hot and humid place just after you moved the unit from an air conditioned room.
- When you use the DVD player in a humid place.

Do not use the DVD player when moisture condensation may occur.

- If you use the DVD player in such a situation, it may damage discs and internal parts. Remove the disc, connect the AC/DC Adaptor to the DVD player and the wall outlet, turn on the DVD player and leave it ON for two or three hours. After two or three hours, the DVD player will have warmed up and evaporated any moisture.



ABOUT DISCS

The region number for this DVD Player is: 1
See the following page for information regarding region numbers.



PLAYABLE DISCS:

The following discs can be played back on this DVD player:



DISC TYPES:

DVD

Data on most DVDs is divided into sections called titles and then into subsections called chapters, each of which is given a title or chapter number. Some features of this DVD player will not operate with some DVD discs as they are preset. If a function you selected does not run as desired, refer to the manual accompanying the DVD disc.

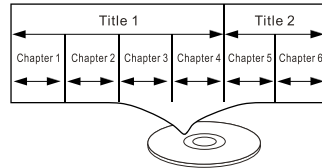

AUDIO CD

Data on an audio CD is divided into sections called tracks, each of which is given a track number.

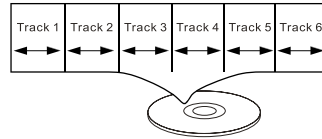

IMPORTANT:

It is important that you read the manual that accompanies the DVD disc, as there are features that are on the DVD player that cannot be used with certain DVDs.

There are also extra features on the DVD disc that are different for each DVD disc, so they are not explained in this owner's manual.

This player conforms to the NTSC and PAL color systems. However, if you are in the USA, Canada or Mexico, leave this setting on NTSC. If incorrectly set to PAL, the TV picture may roll vertically. In this case, set the TV system to NTSC as specified on page 15.

ABOUT DISCS

Notes on Copyright:

It is forbidden by law to copy, broadcast, show, broadcast on cable, play in public and rent copyrighted material without permission. DVD video discs are copy protected, and any recordings made from these discs will be distorted. This product incorporates copyright protection technology that is protected by method claims of certain U.S. Patents and other intellectual property rights owned by Macrovision Corporation, and is intended for home and other limited viewing uses only, unless otherwise authorized by Macrovision Corporation. Reverse engineering or disassembly is prohibited.

Region Management Information:

This DVD Player is designed and manufactured to respond to the Region Management Information that is recorded on a DVD disc. If the Region number described on the DVD disc does not correspond to the Region number of this DVD player, this DVD player cannot play that disc. You may not be able to play back some DVD video discs on this player if they were purchased from outside your geographic area or made for business purposes. When you try to play back an unauthorized disc, Wrong Region appears on the TV screen.





LOCATION OF CONTROLS

Main Unit

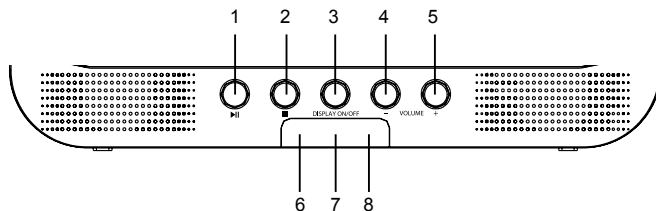

1. **Play/Pause (▶ ||)**: Press to play or pause.
2. **STOP (■)**: Press to stop the playback.
3. **DISPLAY ON/OFF**: Turn on or off the display.
4. **VOL-**: Press to decrease volume level.
5. **VOL+**: Press to increase the volume level.
6. **Charge Indicator**: Red Indicator will turn on when the unit is charging, and turn off when the unit is fully charged.
7. **Remote Control Sensor**
8. **Power Indicator**: Green Indicator will turn on when the unit is power on, and turn off if the unit shut off.

Sub Unit

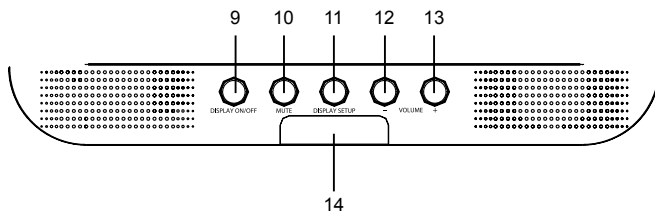

9. **DISPLAY ON/OFF**: Turn on or off the display.
10. **MUTE**: Press to mute the sound, press again to turn the sound back.
11. **Display Setup**: Press to enter to display setup menu.
12. **VOL-**: Press to decrease volume level.
13. **VOL+**: Press to increase volume level.
14. **Power Indicator**: Turn on when power on the sub-unit, and turn off if shut off the sub-unit.





LOCATION OF CONTROLS

Main Unit

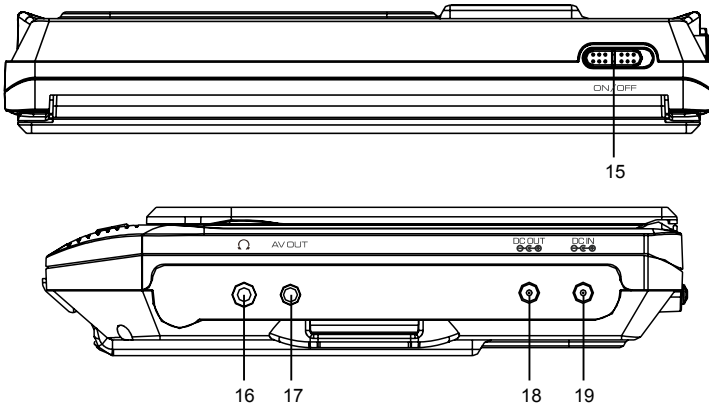

- 15. ON/OFF:** Power ON/OFF Switch,
Slide to ON position to power on.
Slide to OFF position to power off.
- 16. EARPHONE:** Earphone jack.

- 17. AV OUT:** Audio/video output jack.
- 18. DC OUT:** To Connect to sub unit.
- 19. DC in:** DC in jack(DC 9V, \equiv 2A \ominus \oplus \ominus), connect to supplied AC/DC Adapter.

Sub Unit

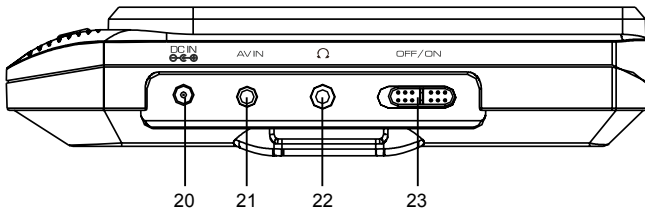

- 20. DC IN:** DC in jack, connect to the DC out jack on main unit by the supplied DC connection cable.
- 21. AV IN:** Audio/video in jack, connect to the AV IN Jack on the main unit by the supplied AV connection cable.

- 22. EARPHONE:** Earphone jack.
- 23. ON/OFF:** Power ON/OFF Switch, slide to ON position to power on. Slide to OFF position to shut off.





LOCATION OF CONTROLS - REMOTE CONTROL

1. **DISPLAY ON/OFF:** To turn On or OFF the screen.
2. **TITLE:** To display the title menu of current disc. Using the Direction and ENTER buttons to select and play the desired title.
3. **MENU:** To display the menu of current disc. Using the Direction and ENTER buttons to select and play the desired track.
4. **PREV ◀◀ (Previous):** Press repeatedly to skip the tracks backward.
5. **NEXT ▶▶:** Press repeatedly to skip the tracks forward.
6. **Stop ■ :** Press to stop.
7. **Direction buttons:** press to select the desired functions within the setting menu.
8. **SETUP:** Press to enter or exit setup menu.
9. **Numeric buttons:** Press numeric buttons to enter numbers.
10. **PROG (Program) button:** press to display program setting menu. Using the Numeric; Direction and ENTER buttons to set the program as on screen instructions.
11. **ZOOM:** Press repeatedly to zoom in/out the picture.
12. **SLOW:** Press repeatedly to set and play the current video in slow motion. Press the ▶| button to resume normal playback.
13. **GOTO:** Press to enter to goto menu. Using the Numeric; Direction and ENTER buttons to select the desired tract to play.
14. **SUBTITLE:** Press repeatedly to select the subtitle.
15. **▶▶ (Fast searching forward):** Press repeatedly to searching the desired section forward. Press ▶| button to resume normal playback.
16. **◀◀ (Fast searching backward):** Press repeatedly to searching the desired section backward. Press ▶| button to resume normal playback.
17. **VOL (Volume) +:** Press to increase the volume level.
18. **ENTER:** Press the confirm the selection (settings).
19. **VOL (Volume) -:** Press to decrease the volume level.

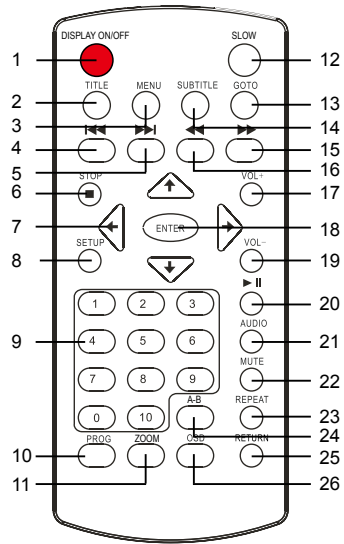



LOCATION OF CONTROLS - REMOTE CONTROL

20. **▶/II (Play/Pause):** Press to play or pause playback.
21. **AUDIO:** Press repeatedly to select the audio channels.
22. **MUTE:** Press to turn off the sound. Press again to resume.
23. **REPEAT:** Press repeatedly to set repeat mode.
24. **A-B:** During playback, press to set the beginning point of A-B repeat. Press again to set the end point of A-B repeat. The unit will start playback the selected section repeatedly. To resume normal playback, press the A-B button again.
25. **ANGLE:** Press repeatedly to select the available viewing angle.
26. **OSD (On Screen Display):** Press repeatedly to display the playback status.

Battery installation:

1. Press the tabs on the battery door and lifting it off.
2. Install two (2) x AAA size batteries (included) into the battery compartment as the figure on right and the polarity markings inside battery compartment.
3. Replace the battery door.

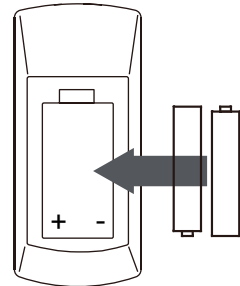

BATTERY PRECAUTIONS

Follow these precautions when using batteries in this device:

1. Use only the size and type of batteries specified.
2. Be sure to follow the correct polarity when installing the batteries as indicated next to the battery compartment. Reversed batteries may cause damage to the device.
3. Do not mix different types of batteries together (e.g. Alkaline, Rechargeable and Carbonzinc) or old batteries with fresh ones.
4. If the device is not to be used for a long period of time, remove the batteries to prevent damage or injury from possible battery leakage.
5. Do not try to recharge batteries not intended to be recharged; they can overheat and rupture. (Follow battery manufacturer's directions.)
6. Do not dispose of batteries in fire, batteries may explode or leak.
7. Clean the batter contacts and also those of the device prior to battery installation.



Using AC/DC Adaptor

The unit has a DC (DC \equiv) 7.4V, 1900mAh Li-ion rechargeable battery. Recharge it by the supplied AC/DC Adaptor as follows:

1. Connected the small plug on the supplied AC/DC Adaptor to the DC IN Jack on Main unit as the figure on right.
2. Connected the AC/DC Adaptor to the to a wall outlet having 120V, 60Hz AC only.
3. During charging, you can play the disc as usual.

NB: The AC/DC Adaptor is intended to be correctly orientated in a vertical or floor mount position.

Notes: Your battery will last longer if you follow these simple guidelines for caring for and storing it.

- A. For first time charge, charge it approximate 12 hours. For normal charge, it need approximate 6 hours.
- B. Recharge and store the device within the temperature range of 5°C~35°C (40°F~95°F).
- C. Do not overcharge (longer than 24 hours). Excessive charging or discharging may shorten the battery's life.
- D. Battery life naturally shortens slowly over time.

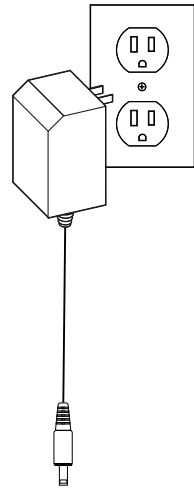

Main Unit

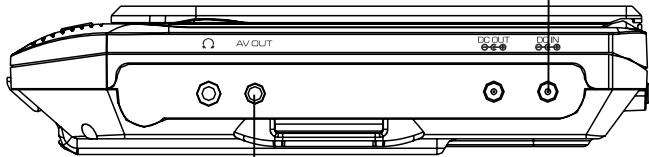

Video input jack (yellow)
 Audio left channel input jack (white)
 Audio right channel input jack (red)

Audio/Video cable(not included)

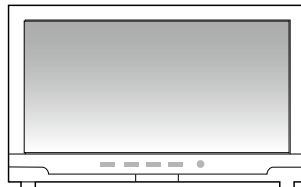
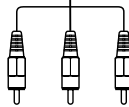

Connected to the TV





Using the Car Power Adaptor

- ☼ Connect to the cigarette lighter socket of a vehicle that has a 12V battery. It is not compatible with a vehicle that has a 24V battery.
- ☼ This is a special negative grounded Car Adapter. Using this Car Adapter with a plus grounded car can cause malfunction.
- ☼ Do NOT plug in the Car Adapter until the car ignition is turned on. Disconnect the Car Adapter from the cigarette lighter after use.

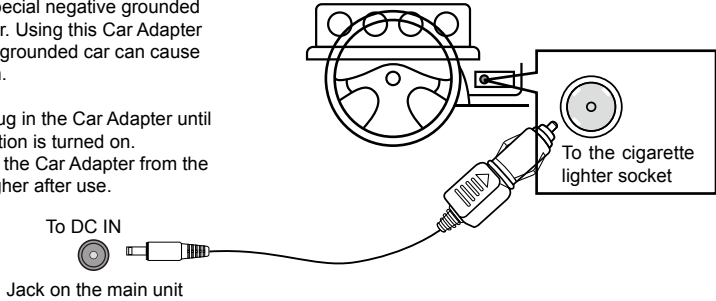

CONNECTION OF MAIN AND SUB-UNIT:

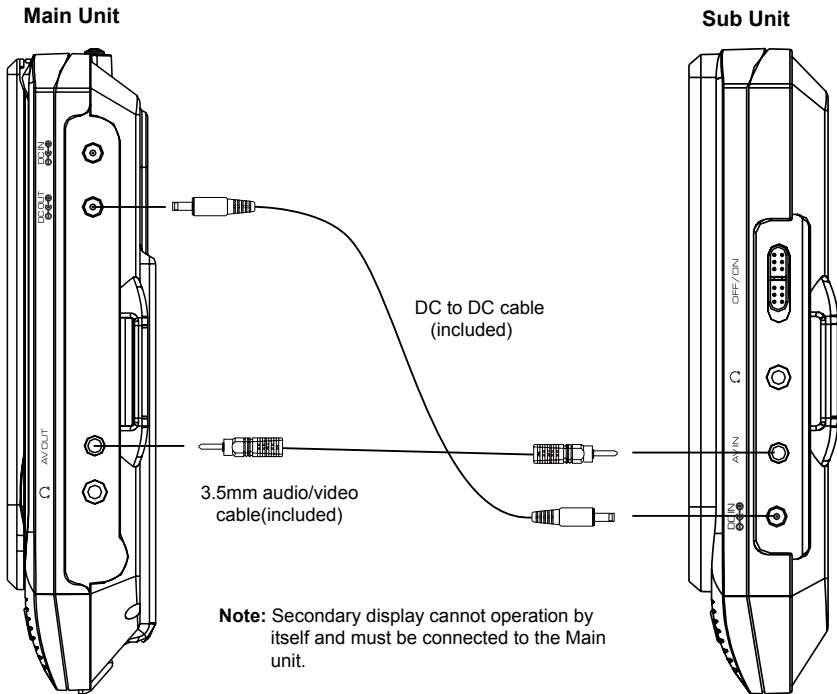



OPERATION

Main unit:

1. Recharged or connect the unit to AC/DC Adaptor; Car Adaptor as previous produce.
2. Lift up the panel on the main unit as the figure below:

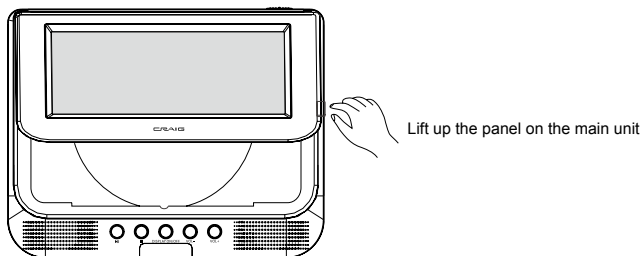

3. Insert the disc to the center spindle with label side face up.
4. Power on the unit by slide the POWER ON/OFF switch on the rear of unit to ON position. The green power on indicator will turn on and the unit will start playback automatically.
5. For private listening, insert the supplied earbug to the phones jack. The speakers will cut off automatically.
6. For saving battery power while listening music, press the DISPLAY ON/OFF button to turn off. Press again to turn it back.
7. To power off, slide the POWER ON/OFF switch to OFF position.

Sub-unit:

1. Connect the sub-unit to the main unit by the supplied DC and AV connection cables as previous procedures.
2. Slide the POWER ON/OFF switch on the right side of unit to ON position to power on the sub-unit.
3. Press the DISPLAY SETUP button to enter to display setting menu. Press repeatedly to select desired function to set. Press the VOL +/- button on the sub-unit to set.
4. For private listening, insert the supplied earbug to the phones jack. The speakers will cut off automatically.
5. For saving battery power while listening music, press the DISPLAY ON/OFF button to turn off. Press again to turn it back.
6. To power off, slide the POWER ON/OFF switch to OFF position.





SETTING MENU

In stop playback, press the **SETUP** button on the Remote Control, the setting menu will appear on the screen. Using the Numeric; Direction and **ENTER** buttons to set or reset the selected functions.

General Setup Page

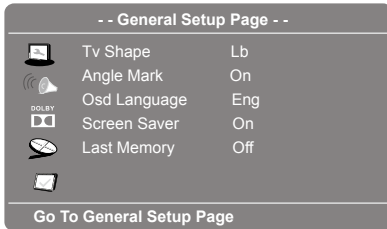

- **Tv Shape:** To set the aspect ratio of the screen to match the current movie.
- **Angle Mark:** To turn ON/OFF the angle mark. When turn on, if multi-angle is available in the current disc. The angle mark will appear on the screen.
- **Osd Lang:** To set the language of on screen display.
- **Screen Saver:** To turn ON/OFF the screen saver. If set to on, when the disc stop playback couple minutes, the screen saver will appear on the screen.
- **Last Memory:** To turn ON/OFF the last memory. When set to on, if playback the correct disc. It will start playback at the point you were stopped last time.

Speaker Setup Page

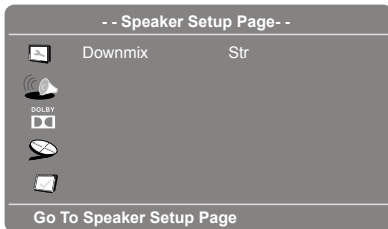

● Downmix

Set the rear audio channels to stereo (hearing the rear-left channel in Dolby 5.1 disc in left speaker; rear-right channel in right channel) or Lt/Rt mode (hearing rear-right and rear-left channel in both right and left speakers).

Dolby Digital Step

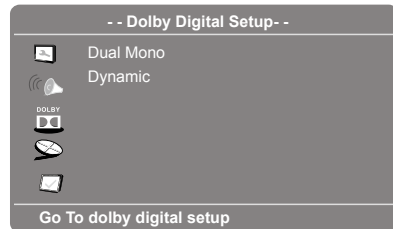

● Dual Mono:

Select and set the audio channels to play.

● Dynamic:

Set the dynamic level or turn it off.

Video Setup Page:

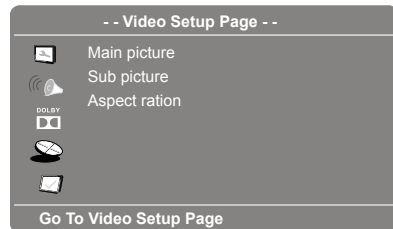

● **Main Picture:** Set the picture quality of main unit.

● **Sub Picture:** Set the picture quality of the Video output signal through AV Out jack.

● **Aspect ration:** Set the picture size of Main unit to 4:3 or 16:9 to match the aspect ration of the movie.

NOTE: The aspect ration of the sub-unit cannot turn to 4:3.





SETUP MENU

Preference Page

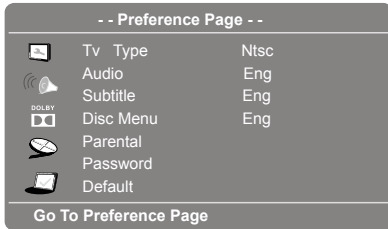

TROUBLE SHOOTING

The remote control does not function

- Point the remote directly at the infrared remote sensor on the unit.
- Replace the battery in the remote with a new one.

Forget Password

Using the super password "136900" to set or reset new password.

- **Tv Type:** Set the color system to NTSC; PAL or AUTO. (The color system in US; Canada and Mexico is NTSC).

- **Audio:** Select and set the priority of the available language.

- **Subtitle:** Select and set the priority of the available language of the subtitle.

- **Disc Menu:**
Select and set the priority of the available language of the disc menu.

- **Parental:** Using the password "136900" to set or reset the rate level as below:

Level 1 : Kid Saf

Level 2 : G

Level 3 : PG

Level 4 : PG 13

Level 5 : PGR

Level 6 : R

Level 7 : NC17

Level 8 : Adult

- **Password:**
Password Mode: To turn the set rating ON/ OFF.

Password: To change the password.

- **Default:** To reset all the setting to factory default settings.



CARE AND MAINTENANCE

Caring for Discs

Treat the disc carefully. Handle the disc only by its edges.
Never allow your fingers to contact with the shiny, unprinted side of the disc.

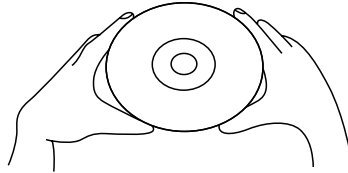

- Do not attach adhesive tape, stickers, etc. to the disc label.
- Clean the disc periodically with a soft, lint-free, dry cloth. Never use detergents or abrasive cleaners to clean the disc. If necessary, use a CD cleaning kit.
- If a disc skips or gets stuck on a section of the disc, it is probably dirty or damaged (scratched).
- When cleaning the disc, wipe in straight lines from the center of the disc to the outer edge of the disc. Never wipe in circular motions.



- Discs should be stored in their cases after each use to avoid damage.
- Do not expose discs to direct sunlight, high temperatures or dust, etc. Prolonged exposure or extreme temperatures can warp the disc.
- Do not stick or write anything on either side of the disc. Sharp writing instruments, or the ink, may damage the surface.

Cleaning the Unit

- To prevent fire or shock hazard, disconnect your unit from the AC power source when cleaning.
- The finish on your unit may be cleaned with a dust cloth and cared for as other furniture. Use caution when cleaning and wiping the plastic parts.
- Mild soap and a damp cloth may be used on the front panel.



SPECIFICATIONS

Power Source:

Main Unit	Built-in DC \equiv 7.4V,1900mAh Li-ion battery Recharge by DC \equiv 9V, 2A \ominus \oplus
AC Adapter	Input : 100-240V~, 50/60Hz Output : DC \equiv 9V, 2A \ominus \oplus
Car Adapter	Input Voltage: DC \equiv 12V Output Voltage : DC \equiv 12V, 1.4A \ominus \oplus Built-in fuse: F-2A,250V
Power Source of Remote Control	DC \equiv 3V, 2x "AAA" size batteries, included
Power consumption:	18W (Max)
Color system:	NTSC / PAL
OBattery charging time :	Approximately 6 hours
Battery life (Full charge) :	Approximately 2 hours
Discs played :	
(1) DVD-VIDEO disc	12cm single-sided, single-layer 12cm single-sided, dual-layer 12cm double-sided, single-layer 8cm single-sided, single-layer 8cm single-sided, dual-layer 8cm double-sided, single-layer
(2) Compact disc	12cm disc 8cm disc
Video output level:	1 Vp-p
Audio output level:	1.5Vrms(1 KHz, 0dB)
Audio signal output characteristics:	
Frequency responses:	
DVD (linear audio):	20Hz-20KHz (48KHz sampling) 20Hz-20KHz (96KHz sampling)
CD aydui:	20Hz-20KHz
S/N ratio :	70dB
Pickup:	
Wave length :	DVD640 \pm 10nm, CD790 \pm 15nm
Laser power :	CLASS 1

ACCESSORIES

• Remote control: uses 2 x AAA size batteries (included)	x 1
• 3.5mm audio/video connection cable	x 1
• Earphones	x 2
• AC/DC Adapter	x 1
• Car Adapter	x 1
• DC connection cable	x 1
• Headrest straps	x 2
• Instruction Manual	x 3

SPECIFICATIONS ARE SUBJECT TO CHANGE WITHOUT NOTICE



LIMITED WARRANTY

Craig warrants this product to be free from manufacturing defects in material and workmanship under normal use for a period of 90 days from date of purchase. If service is required, please return the product to the store where it was purchased for exchange; or, pack the unit in the original packing material with all accessories if applicable, a copy of your sales receipt and a Cashier's check or Money Order for \$20.00 (to cover shipping and handling costs) payable to Craig Electronics Inc. For consumers in Canada, please make sure that the cashier check or money order is redeemable through a U.S. bank. Ship your product freight pre-paid. Your unit will be repaired, replaced or if the unit can not be repaired or replaced, a refund will be forwarded to you within four weeks of receipt of your unit. Please ship your unit to:

Craig Electronics Inc.
1160 NW 163 Drive
Miami, FL 33169

This warranty is void if the product has been: a) Used in a commercial application or rental. b) Damaged through misuse, negligence, or abuse. c) Modified or repaired by anyone other than an authorized Craig service center. d) Damaged because it is improperly connected to any other equipment.

Note: This warranty does not cover: a) Ordinary adjustments as outlined in the Owner's Manual which can be performed by the customer. b) Damage to equipment not properly connected to the product. c) Any cost incurred in shipping the product for repair. d) Damage to the product not used in the USA.

This warranty is not transferable and only applies to the original purchase. Any implied warranties, including the warranty of merchantability, are limited in duration to the period of this expressed warranty and no warranty whether expressed or implied shall apply to the product thereafter.

Under no circumstance shall Craig be liable for any loss or consequential damage arising out of the use of this product. This warranty gives specific legal rights. However, you may have other rights which may vary from state to state. Some states do not allow limitations on implied warranties or exclusion of consequential damage. Therefore, these restrictions may not apply to you.

To Obtain Service on your Product
email: service@craigelectronics.com

Free Manuals Download Website

<http://myh66.com>

<http://usermanuals.us>

<http://www.somanuals.com>

<http://www.4manuals.cc>

<http://www.manual-lib.com>

<http://www.404manual.com>

<http://www.luxmanual.com>

<http://aubethermostatmanual.com>

Golf course search by state

<http://golfingnear.com>

Email search by domain

<http://emailbydomain.com>

Auto manuals search

<http://auto.somanuals.com>

TV manuals search

<http://tv.somanuals.com>