



- Full HD Video
- SDI & HDMI
- Very Low Latency
- Plug & Play
- Rugged Design

# Wireless Video Link PRO 800

### EU Environmental Protection

Waste electrical products should not be disposed of with household waste. Please recycle where facilities exist. Check with your local authority or retailer for recycling advice.



## User Manual

This user manual applies to:  
Transmitter: CC8980  
Receiver: CC3865



Version: 1.5

## Important Information

Please read this user manual before you use this product, it contains all the notes and important things regarding operating this product. In accordance with the safety precautions and operating instructions listed on this user manual, our applies provided the product is handled properly for its intended use, but may not apply to below cases:

- Repairs or product modification and alterations have been executed by unauthorized personnel.
- The damages are caused by accidents including but not limited to lightning, fire, exposed to rain or water, and moisture.
- Do not use provided power adapter with specific power voltage which are not compliant with the rated voltage range in the attached label of the power adapter in package.
- The model label on the product has been modified or the warranty tag has been removed by unauthorized personnel.

### Safety Precaution

 <p>Danger! High voltage</p>	<p>To reduce the risks of electricity, do not remove or open the cover. No user-serviceable parts are inside. Please return to original factory for maintenance</p>
 <p>Beware of hot surfaces!</p>	<p>The high temperature in the process of operating the device may cause the high risk of scalding.</p>
 <p>Caution!</p>	<p>Please use our standard power adapter. Detailed information Please refer to the rated voltage range showed on the label at the back of package's power adapter.</p>

### Danger: Be careful with electricity.

- As connecting any equipment (such as any player or TV , etc.), please turn off the power to the product before any operation is undertaken.
- Power outlet: To prevent electric shock or fire, short circuit, please make sure the type of electrical plug used on the receiver's and transmitter's power cord are compliant with the rated voltage range in the attached label of the power adapter in package.
- Power cord: Do not place any heavy articles above on the power cord. To avoid being stepped on or pinched by heavy items, the power cord should not be located on the place where people pass by frequently.
- Power overloading: Avoid overloading wall's electrical outlets and extension cord or other multi-socket; otherwise could result in electric shock or fire.
- Lightning: For protection from lightning or when the product is left unattended for a long period, please disconnect it from the power source.
- Please disconnect the power cord from the power outlet when you are not using the receiver and transmitter, this will reduce the risk of electric shock or fire.

### Warning

- This product should not be exposed to dripping or splashing. Do not place any object filled with liquid on the product (eg. vases).
- To avoid electric shock, please do not block or stick anything on the air vent of product; do not remove the cover or put the object just like pins, steel wire into the gap of the air vent.
- Please place the receiver/ transmitter on a flat with hard and stable surface.
- Ventilation: please do not block the air vents on the receiver/transmitter or place any heavy object on top of them . Blocking the air flow can damage the product itself. Please make sure that there is adequate ventilation distance between the receiver and TV, and also put the product away from direct sunlight or any source of heat.
- Water Exposure: To reduce the risk of electric shock or fire , please do not expose the receiver/transmitter to rain or moisture.
- We assume no responsibility for any damage or result caused by using other adapters instead of our standard adapters

### Special Notice

- Although the product has provided the function of data encryption when transmitting, you still need to pay attention to deliberate signal interception. There will be the Possibility of a third party intentionally intercept the transmission signal since the product adopt wireless communication. Please do not use the product on confidential and important communications, or life-related communications The main concern is that the content of wireless communication might be received by the third party's wireless devices deliberately or accidentally.
- The impact of radio waves (such as the following environment may cause the abnormal audio and video (blocked image, noise ...etc.).
  - 1 ) Transmit near the wall which is hard for the radio waves to get through.
  - 2 ) Quite close to the refrigerator, metal fitment and appliances, or next to the crowded situation.
- This product has been tested and manufactured to comply with national electrical safety rules, however, there will be noise caused by the interference with other machines in rare cases. If the interference is happened, please keep a certain distance away from other machines.
- The product is susceptible to interference from 5GHz wireless local area network or other wireless devices.
- Optimal range between transmitter and receiver is between 1 meter and 50 meters within line of sight indoor.
- Please do not set up the transmitter and receiver in metal shelf, or it will hinder the wireless communications.
- 1080P/60 Hz Wireless transmitting.
- It will take 15-20 seconds to boot the system before wireless communication start, the media receiver can not be operated during this time.

## Contents

About the User Manual.....	02
Brief Introduction.....	02
Features.....	02
Packing List.....	03
Specification.....	04
Structure & Interface.....	05
Wireless HD Transmitter:CC8980.....	05
Wireless HD Receiver:CC3865.....	07
Product Installation.....	09
Wireless HD Transmitter:CC8980.....	09
Wireless HD Receiver:CC3865.....	12
OLED Display Description.....	14
Support Full PSF Resolution.....	16
Antenna Installation Recommendations.....	17
Trouble Shooting.....	20

## About the User Manual

- Please read this manual carefully before you use this product and retain it properly for future reference.
- If there is any doubt or difficulty in the process of product usage, please feel free to contact us or the dealer.
- The company reserves the authority to amend the specification.

## Brief Introduction











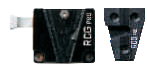

As the widely use of live broadcasting , there is some problem exsited in the process of cable wiring, such as the high cost and short-life usage of the cable. Also, the cable trod by the crowd under insufficient site protection is the major cause of cable performance, even lead to the live broadcast accident. CVW provides you with more convenient and safer solution for live broadcasting. The long distance transmission system applied with the high-capacity Li-battery, plug-and-play setting, can fully meet requirement of outdoor and indoor shooting. Especially, no cable wiring will bring the safer and more professional experience to you!

## Features

- Effective range up to 800M,suitable for film shooting, live broadcast, wedding and big conference use.
- Support 1080P/60Hz 4:2:2bit, uncompressed real time HD video transmitting.
- Support HDMI/HD-SDI/3G-SDI.
- Plug&Play- easy to install.
- Support channel switching and broadcast mode for 1transmitter to multiple receivers.
- Support SDI Time code transmitting, code format:ATC\_VITC、 ATC\_LTC.
- Support SDI Start/Stop transmitting.
- Compatible EDID 1.1, Support HDMI 1.3
- AES128Encryption

## Packing List

Please check the packing list carefully after unpacking, if any part is missing, please contact your dealer. Accessories of all models are subject to the following packing list.

Transmitter				
	Wireless HD transmitter X1	Antenna x2	Power Cable x1 2-pin Lemo to DTap	
				
	SDI Cable x1	DC Adapter X1 12V 2A Lemo 2 pin * Optional	V-Mount X1 * Optional	Hot-shoe Stand x1
Receiver				
	Wireless HD receiver X1	Antenna x5	Power Cable x1 2-pin Lemo to DTap	
				
	SDI Cable x1	DC Adapter X1 12V 2A Lemo 2 pin	V-Mount X1 * Optional	Hot-shoe Stand x1

## Specification

ITEM	Specification
Frequency	5.1~5.9(GHz)
Bandwidth	40MHz
Video Formats Supported	1080p 23.98/24/25/30/50/60 1080psf 23.98/24/25 1080i 50/59.94/60 720p 50/59.94/60 576p 576i 480p 480i
Audio Formats Supported	PCM
Time Code	ATC_VITC ATC_LTC
Transmission range	800m (MAX)
<b>Transmitter</b>	
Antenna	External Antenna X 2 pcs
Transmission Power	20dBm
Functional Interface	HDMI Input; SDI Input; SDI Loop Output; Mini USB; LEMO Power IN; Antenna RPSMA Socket, Power ON/OFF
Locating Structure	1/4" Hot-shoe connection; V-Mount * Optional
OLED Screen	Wireless Channel Info; SDI/HDMI Signal Info
Working Voltage	6V~17V
Power Consumption	12W
Dimensions	119x79x32 mm
Temperature	-10 ~ 50°C ( Operating ) ; -40 ~ 80°C ( Storage )
<b>Receiver</b>	
Antenna	External Antenna X 5 pcs
Receiving Sensitivity	-70dBm
Functional Interface	SDI Dual Output; HDMI Output; Mini USB; LEMO Power IN; Antenna RPSMA Socket, Power ON/OFF
Locating Structure	1/4" Hot-shoe connection; V-Mount * Optional
OLED Screen	Wireless Channel Info; SDI/HDMI Signal Info
Working Voltage	6V~17V
Power Consumption	7~8W
Dimensions	155x111x32 mm
Temperature	-10 ~ 50°C ( Operating ) ; -40 ~ 80°C ( Storage )

\* Since the product's improving process , all the performance , design and specifications of our products are subject to minor change without prior notice.

# Structure & Interface

## Transmitter CC8980

# TX

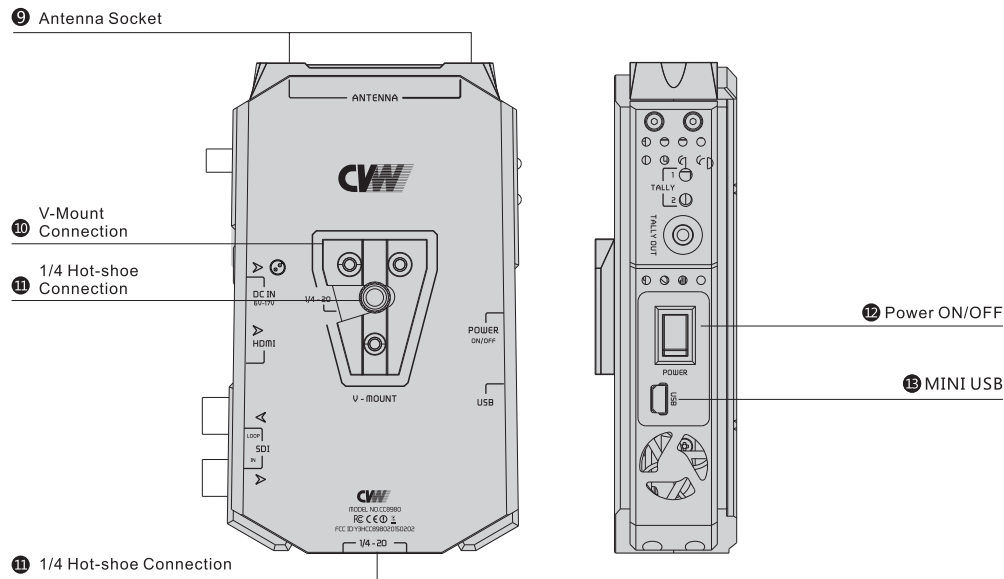
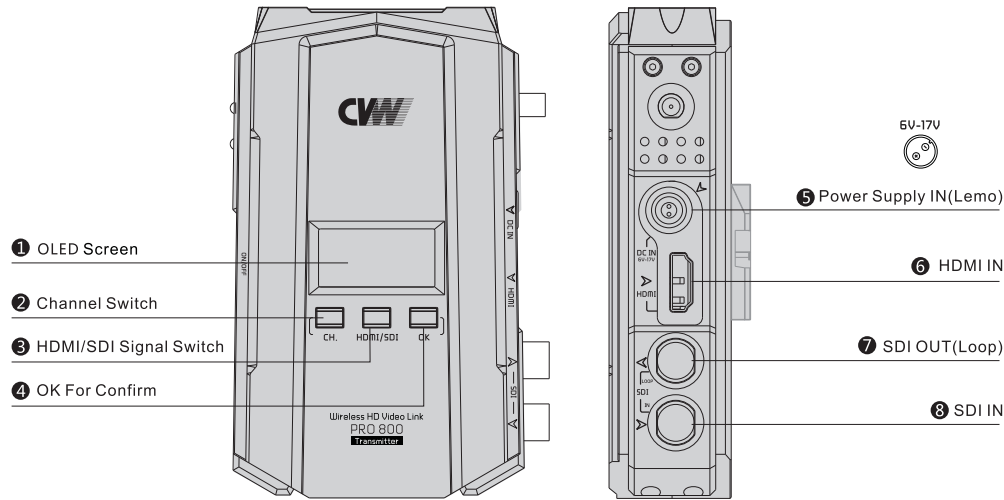

### Structure

1	OLED Screen
	Display information about the Channel, Signal INPUT, Capacity, Signal status.
2	Channel Switch
	Select the correct Channel
3	HDMI/SDI Signal Switch
	Switch HDMI or SDI Signal as the signal source
4	OK For Confirm
	OK For Confirm the selection
5	Power Supply IN(Lemo) * support 6-17V
	Support connecting to the power supply of the camera, or power adaptor Notice: DO Make sure the Voltage (+)(-) was connected correctly.
6	HDMI OUT
	Connect to the HD Digital Camcorder with HDMI OUT
7	SDI OUT(Loop)
	Connect to the HD Digital Monitor which support 3G-SDI, HD-SDI
8	SDI IN
	Connect to the HD Camcorder which support 3G-SDI, HD-SDI
9	Antenna Socket
	SMA socket to connect the antenna
10	V-Mount Connection * Optional
	Support V-Mount Connection
11	1/4 Hot-shoe Connection
	Support to connect with more methods
12	Power ON/OFF
	Power ON/OFF
13	Mini USB
	For system updating

\* Since the product's improving process , all the performance , design and specifications of our products are subject to minor change without prior notice.

# Structure

## Transmitter CC3865

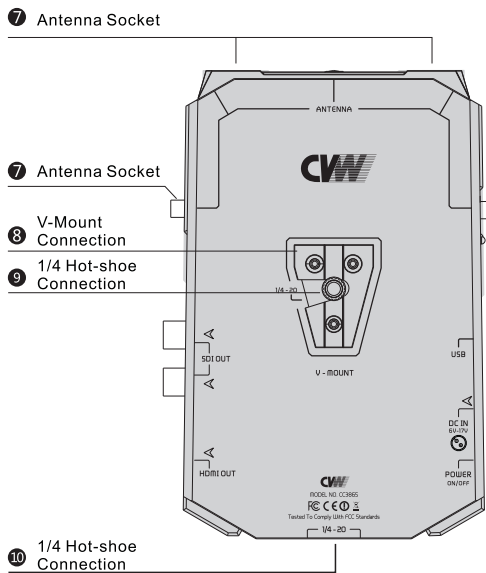
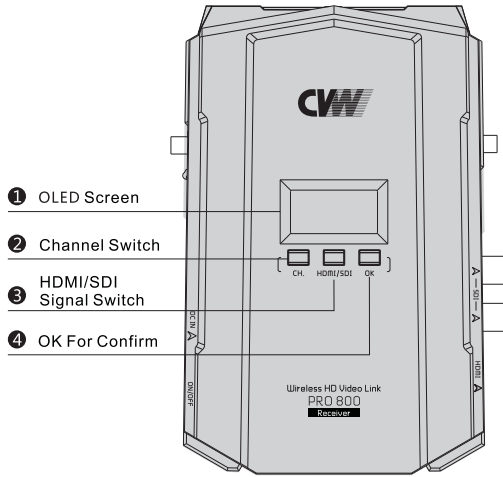

# RX

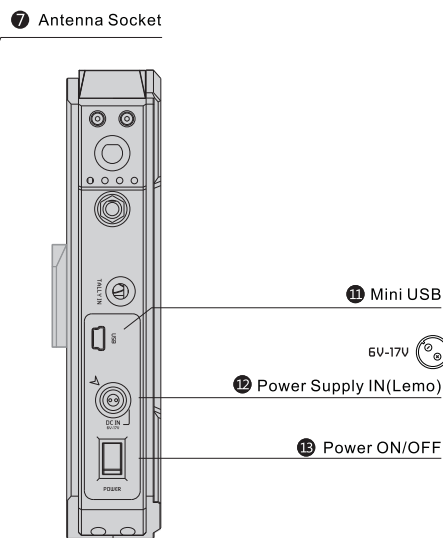
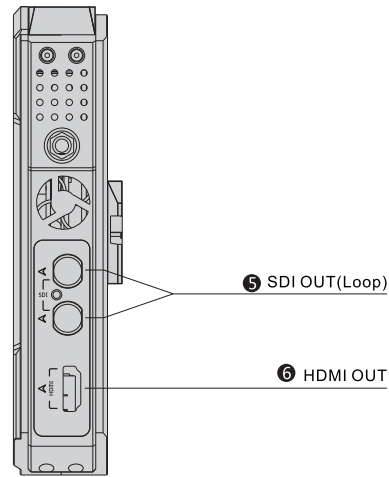

## Structure

1	OLED Screen
	Display information about the Channel, Signal INPUT, Capacity, Signal status.
2	Channel Switch
	Select the correct Channel
3	HDMI/SDI Signal Switch
	Switch HDMI or SDI Signal as the signal source
4	OK For Confirm
	OK For Confirm the selection
5	SDI OUT(Loop)
	Connect to the HD Digital Monitor which support 3G-SDI, HD-SDI
6	HDMI OUT
	Connect to the HD Digital Camcorder with HDMI OUT
7	Antenna Socket
	SMA socket to connect the antenna
8	V-Mount Connection * Optional
	Support V-Mount Connection
9,10	1/4 Hot-shoe Connection
	Support to connect with more methods
11	Mini USB
	For system updating
12	Power Supply IN(Lemo) * support 6-17V
	Support connecting to the power supply of the camera, or power adaptor Notice: DO Make sure the Voltage (+)(-) was connected correctly.
13	Power ON/OFF
	Power ON/OFF

\* Since the product's improving process , all the performance , design and specifications of our products are subject to minor change without prior notice.

## Product Installation

### For transmitter

# TX

1. Fix on the antennas to the transmitter, and arrange them to be right angle as figured below.

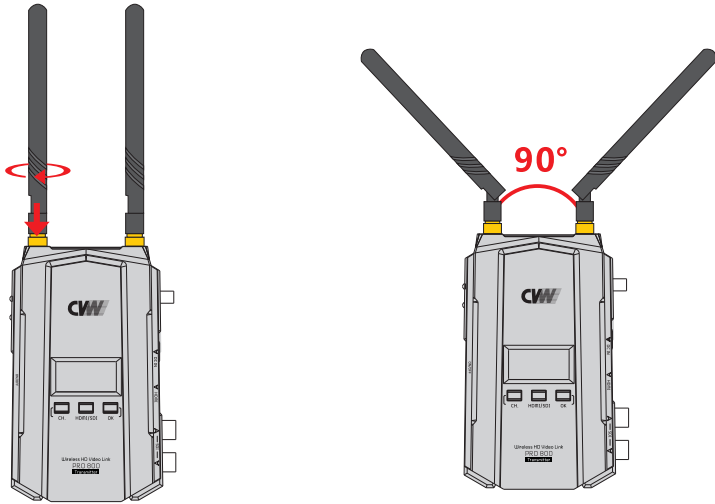

2. Connect the transmitter to the power supply via the certain power cable. Connect the SDI/HDMI cable to the HD Video Source.

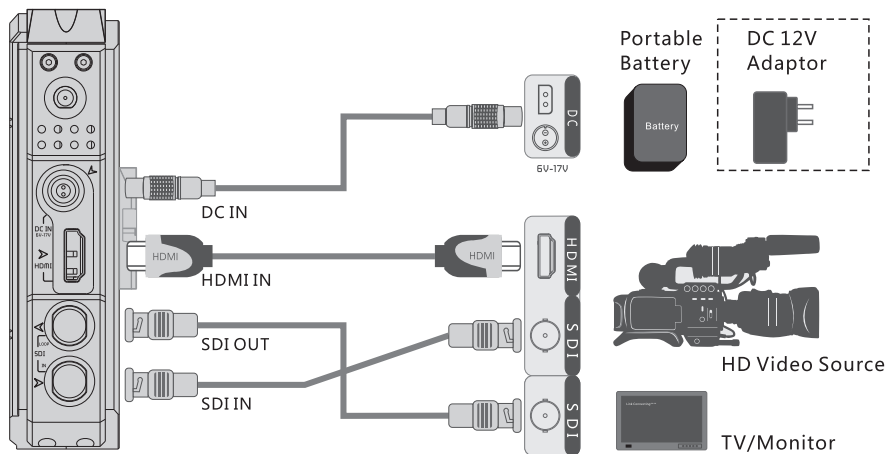

3. Turn ON the power supply and make sure the transmitter start to work.

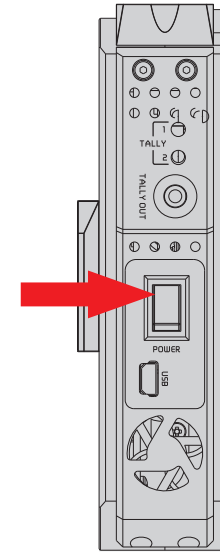

4. Press the "CH" button to select the wireless channel that corresponding to the Receiver, then press the "OK" button to confirm. When the video signal is normally transferred, the OLED Screen will display "VIDEO" ;

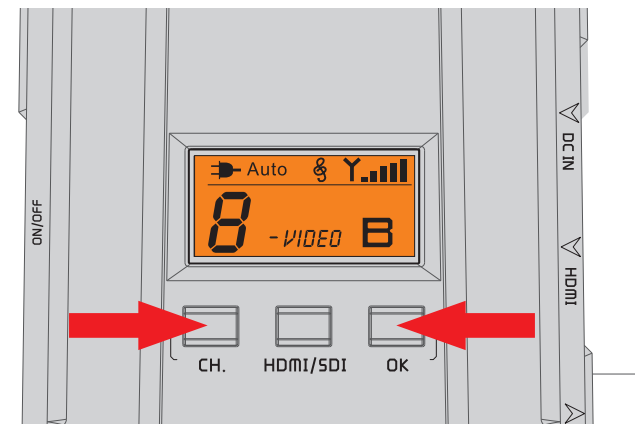

5. Transmitter support long pressing "HDMI/SDI" key to manually switch SDI audio mode. When there is no audio from SDI input, you can manually switch SDI audio mode. This function is only valid for the SDI interface and does not affect the HDMI interface.

SDI Audio mode is set to 0 by default

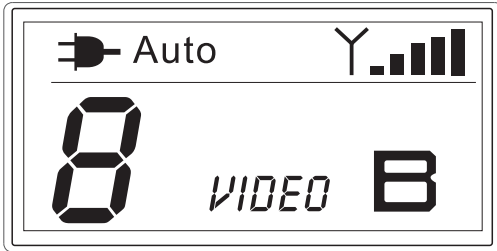

Long press "HDMI/SDI" key to switch to SDI audio mode 1

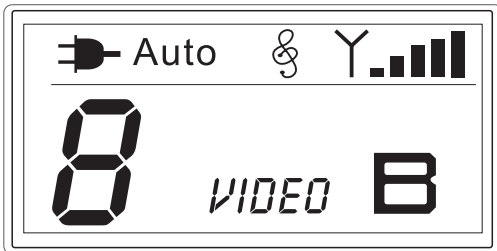

## For Receiver

1. Fix on the antennas to the receiver, and arrange them to be right angle as figured below.

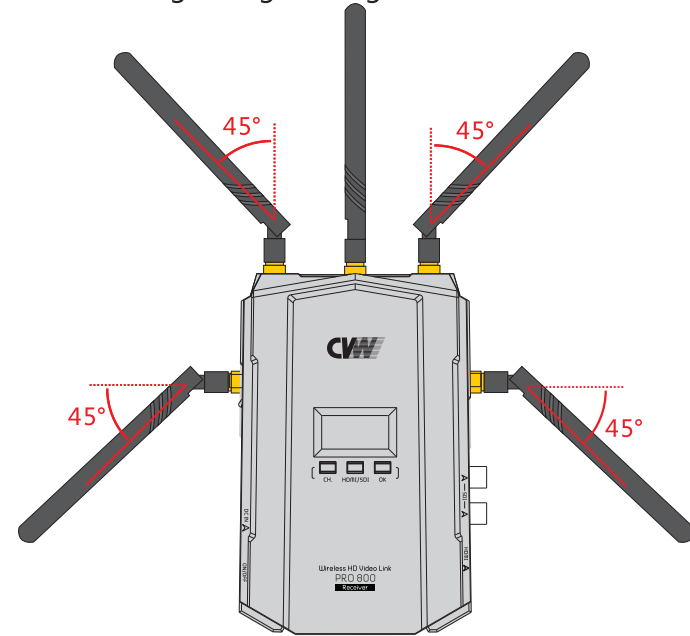

2. Connect the receiver to the power supply via the certain power cable. Connect the SDI/HDMI cable to the TV/Monitor.

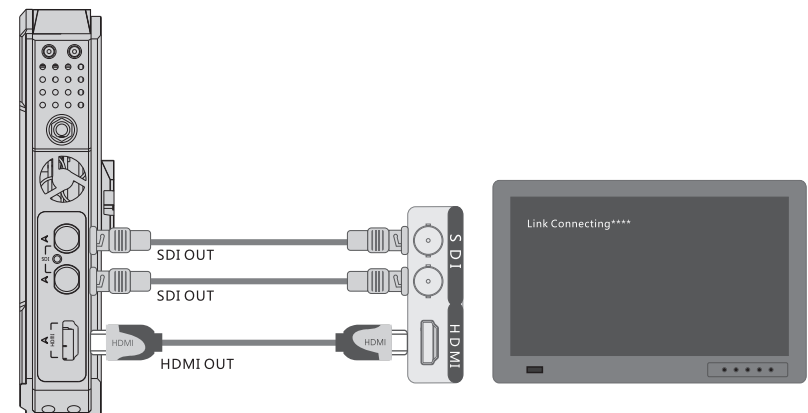



3. Turn ON the power supply and make sure the receiver start to work.

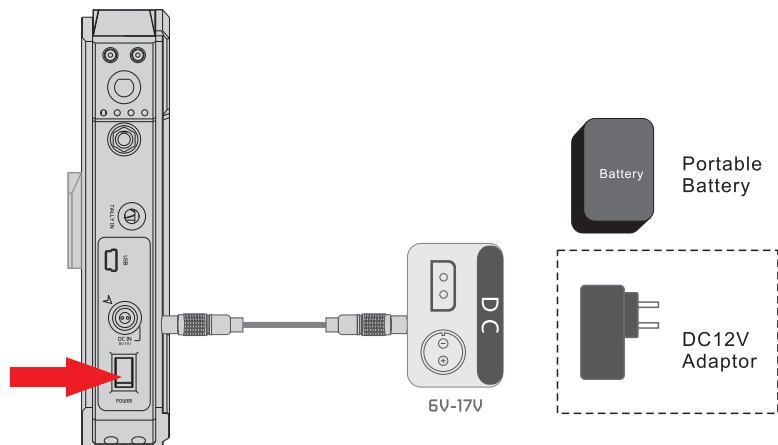

4. Press the "CH" button to select the wireless channel that corresponding to the Transmitter, then press the "OK" button for confirm.  
 When the video signal is normally transferred, the OLED Screen will display "VIDEO" ;  
 When the Networking is normally connected, the OLED Screen will display "LINK" .  
 Then the screen of TV/Monitor will display the HD images simultaneously from the video source.

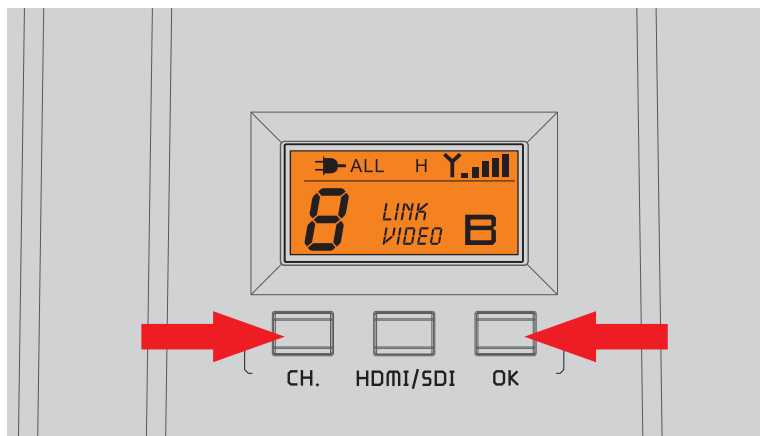

5. Long press HDMI/SDI: LAN high and low gain switching, "H" for high gain, "L" for low gain.  
 Short press HDMI/SDI: switch ALL/HDMI/SDI video output interface.

## OLED Display Description

### CC8980 OLED Screen

Signal source input :  
Auto/HDMI/SDI

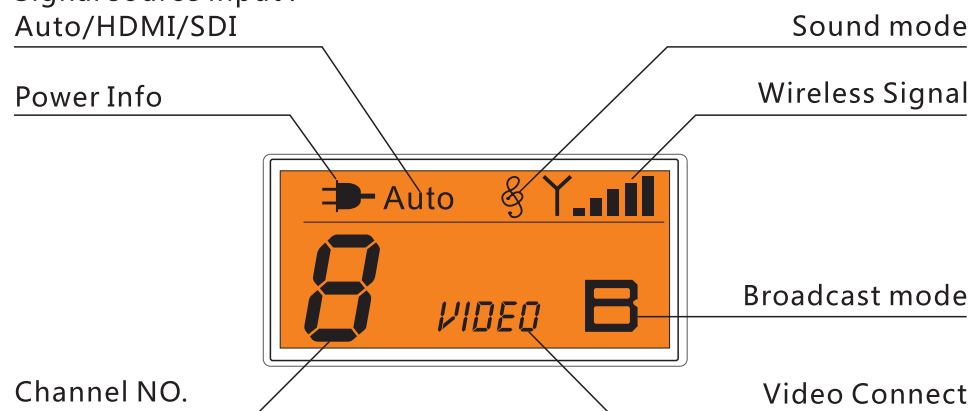

Signal source input :Auto/HDMI/SDI.

Power Info: Display the current power supply status.

Channel NO.: Display the current Channel NO. of device.

Wireless Signal: Display the networking signal status.

Sound Mode:mode 0,display nothing, mode 1 display melody logo.

VIDEO: VIDEO means the video signal is OK.

If the screen does not have any operation,it will automatically enter the screensaver mode after three minutes.

## CC3865 OLED Screen

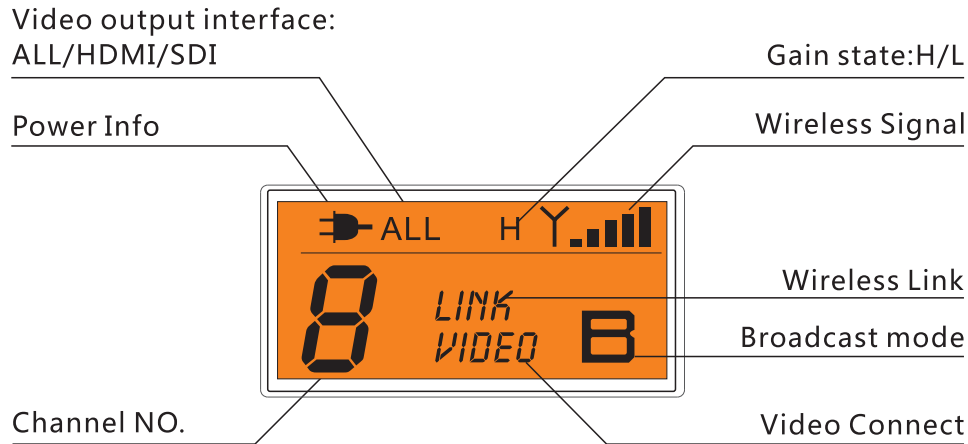

Video output interface:ALL/HDMI/SDI.

Power Info: Display the current power supply status.

Channel NO.: Display the current Channel NO. of device.

Gain state:H/L:

"L" is low-gain mode,application for short distance transmission, good ability to anti-jamming;

"H" is high-gain mode,application for long distance transmission, normal ability to anti-jamming;

Wireless Signal: Display the networking signal status.

Wireless LINK: LINK means the wireless connecting is OK

Video Connect: When connection failed ,displays nothing;  
When connection normally,displays"VIDEO"

If the screen does not have any operation,it will automatically enter the screensaver mode after three minutes.

## Support Full PSF Resolution

### Support Full PSF Resolution

25PSF in = 25PSF out	23.98P in=23.98P out
29.97PSF=29.97PSF out	24P in=24P out
30PSF in = 30PSF out	25P in=25P out
	29.97P in=29.97P out
	30P in=30P out
50i in = 50i out	
59.94i in = 59.94i out	
60i in = 60i out	

## Antenna Installation Recommendations

In order to get the best wireless communication quality and achieve the best transmission effect, the installation of the device should meet the following requirements.

- It is necessary to install transmitter and receiver at least 1.5 meters above ground. the height of receiver and transmitter should be consistent.
- There is no barrier between transmitter and receiver
- The plane of transmitter antennas toward the plane of receiver antennas face-to-face, not vertical or oversized.

### Recommended Installation Method under Ideal Position

Make receiver to stand vertically; adjust antennas to a fan-shaped arrangement;  
Make transmitter to stand vertically; adjust antennas to 90° angle in the same plane  
The plane of transmitter antennas toward the plane of receiver antennas face-to-face

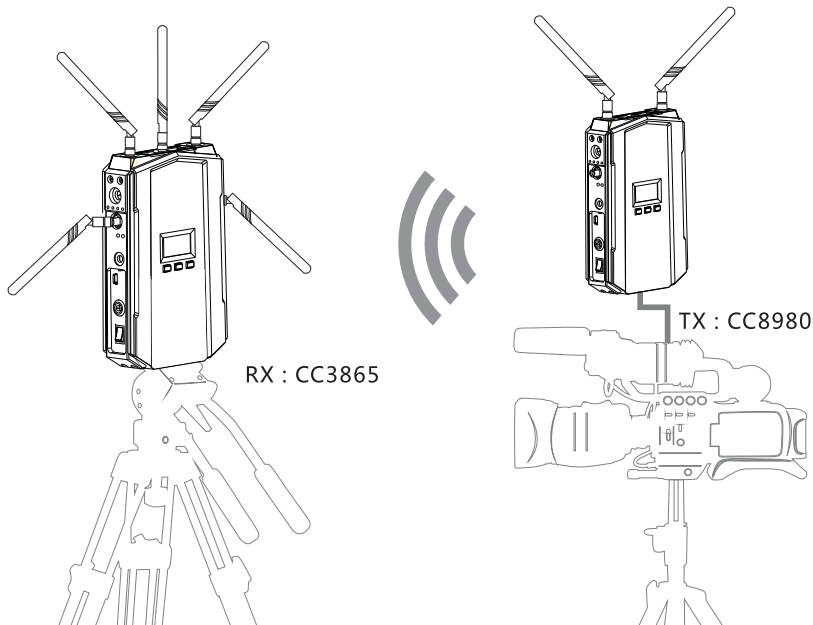

### Recommended Installation Method under Non-ideal Position

When the front side of the transmitter is not able to face to the receiver, please try to adjust the direction of transmitter antennas to make sure that the formative fan-shaped arrangement can face to the receiver for best signal transmission. As shown in the diagram 1 and diagram 2

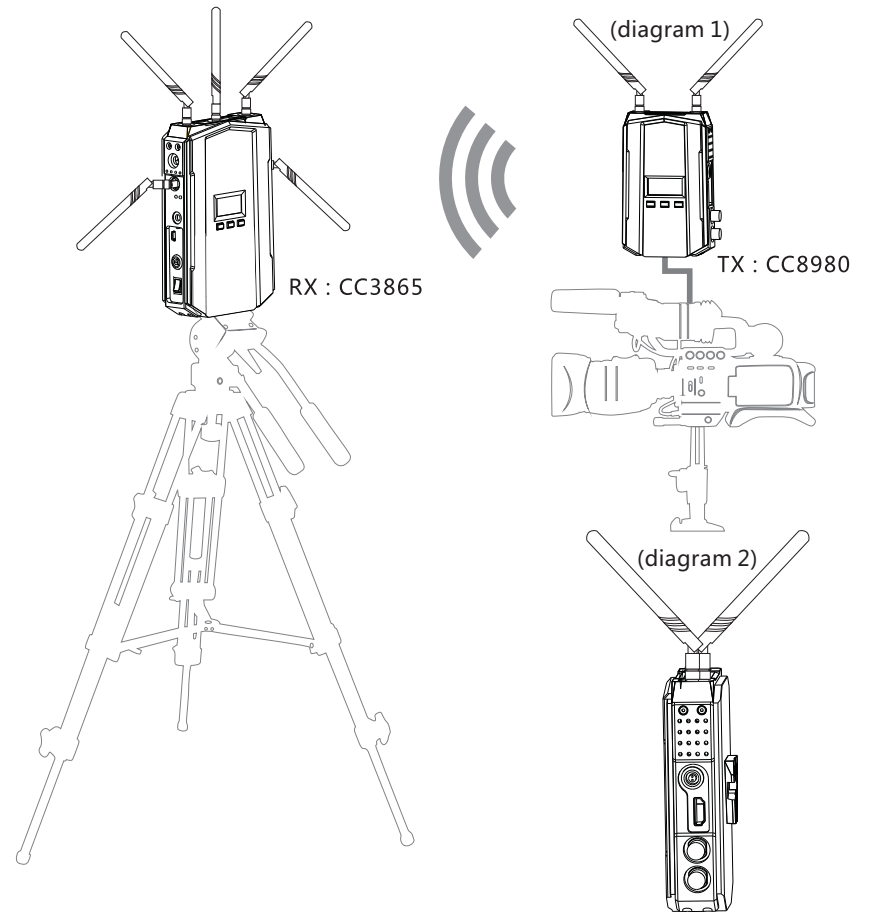

Because TX and RX are working on ISM band, wireless transmission performance is relevant with level of interference intensity. If transmission performance declines, we recommend to switch the wireless channel of TX and RX simultaneously for improvement of transmission performance.

# Trouble Shooting

	Troubles & Possible Reasons:	Solutions:
OSD Information on TV	<b>Displaying "Link Connecting.." for long time</b>	
	Transmitter is not electrified.	Power on transmitter.
	Transmitter or receiver is not placed erectly.	Place the TX or RX onto the base and replace them erectly.
	The transmitter and receiver are too far away.	Move the receiver closer to the transmitter.
	Several solid wall partition TX and RX.	Reduce the number of solid walls between TX and RX.
	There are too many obstacles between TX and RX.	Move the receiver closer to the transmitter.
	Haven't matched the code of TX and RX.	Rematch the code of transmitter and receiver.
	There is other transmitter which is under working condition near the receiver.	Power off other independent transmitter, place the receiver away from the other sources of interference.
	<b>No Video Signal received</b>	
	Transmitter and video source are not connected.	Connect the transmitter to video source by SDI/HDMI cable.
	The video source is turned OFF.	Power ON the video source.
	Video source were NOT switched to SDI/HDMI output.	Switch the Video source to SDI/HDMI output.
	Bad contact of cable of transmitter	Remove and then re-plug the cable of transmitter
	Abnormal working of transmitter	Reboot the transmitter.
	Problem with cable between TX and video source	Change the SDI/HDMI cable.
Player NOT support the output resolution format.	Switch the output video resolution to other modes.	
The TV/Monitor NOT support HDCP authentication.	Replaced with HDCP-certified TV/Monitor.	
Image	<b>No signal input to Receiver or TV/Monitor</b>	
	Receiver is turned OFF.	Power on receiver.
	Receiver and TV are not connected.	Connect receiver to TV/Monitor via SDI/HDMI cable.
	TV/Monitor NOT switched to SDI/HDMI input.	Switch TV/Monitor to SDI/HDMI input.
	Bad contact of the cable of receiver or TV/monitor	Remove then re-plug the SDI/HDMI cable.
	TV/Monitor turn into standby mode	Switch the TV/Monitor to normal operation mode.
	Abnormal working of receiver.	Reboot the receiver.
	<b>No image appear on TV/Monitor</b>	
	Bad contact of receiver or cable.	Re-plug the cable of the receiver or TV/Monitor
	Abnormal working of receiver	Reboot the receiver
	Receiver failure	Please contact your retailer
	<b>Abnormal color on TV screen</b>	
	Bad contact of cable of receiver or TV/monitor.	Unplug and then plug the HDMI cable of the receiver or TV.
	Bad contact of cable of transmitter or video source.	Unplug and then plug the HDMI cable of the TX and player.
	Abnormal working of transmitter or receiver	Reboot the transmitter and receiver.

## FCC Statement

This equipment has been tested and found to comply with the limits for a Class B digital device, pursuant to part 15 of the FCC rules. These limits are designed to provide reasonable protection against harmful interference in a residential installation. This equipment generates, uses and can radiate radio frequency energy and, if not installed and used in accordance with the instructions, may cause harmful interference to radio communications. However, there is no guarantee that interference will not occur in a particular installation. If this equipment does cause harmful interference to radio or television reception, which can be determined by turning the equipment off and on, the user is encouraged to try to correct the interference by one or more of the following measures:-Reorient or relocate the receiving antenna. Increase the separation between the equipment and receiver. Connect the equipment into an outlet on a circuit different from that to which the receiver is connected. Consult the dealer or an experienced radio/TV technician for help. To assure continued compliance, any changes or modifications not expressly approved by the party responsible for compliance could void the user's authority to operate this equipment. (Example use only shielded interface cables when connecting to computer or peripheral devices).

## FCC Radiation Exposure Statement

This equipment complies with FCC RF radiation exposure limits set forth for an uncontrolled environment. This transmitter must not be co-located or operating in conjunction with any other antenna or transmitter. This equipment complies with Part 15 of the FCC Rules.

Operation is subject to the following two conditions:

- (1) This device may not cause harmful interference, and
- (2) This device must accept any interference received, including interference that may cause undesired operation.

## Cautions!

The manufacturer is not responsible for any radio or TV interference caused by unauthorized modifications to this equipment. Such modifications could void the user authority to operate the equipment.

## Free Manuals Download Website

<http://myh66.com>

<http://usermanuals.us>

<http://www.somanuals.com>

<http://www.4manuals.cc>

<http://www.manual-lib.com>

<http://www.404manual.com>

<http://www.luxmanual.com>

<http://aubethermostatmanual.com>

Golf course search by state

<http://golfingnear.com>

Email search by domain

<http://emailbydomain.com>

Auto manuals search

<http://auto.somanuals.com>

TV manuals search

<http://tv.somanuals.com>