



User Manual

Wireless AC Day/Night Camera with Color Night Vision

DCS-2136L

Preface

D-Link reserves the right to revise this publication and to make changes in the content hereof without obligation to notify any person or organization of such revisions or changes. Information in this document may become obsolete as our services and websites develop and change. Please refer to the www.mydlink.com website for the most current information.

Manual Revisions

Revision	Date	Description
1.0	September 27, 2013	• Initial release for Revision A1

Trademarks

D-Link and the D-Link logo are trademarks or registered trademarks of D-Link Corporation or its subsidiaries in the United States or other countries. All other company or product names mentioned herein are trademarks or registered trademarks of their respective companies.

Copyright © 2013 D-Link Systems, Inc.

All rights reserved. This publication may not be reproduced, in whole or in part, without prior expressed written permission from D-Link Systems, Inc.

Table of Contents

Preface	2	Image Setup	36
Manual Revisions.....	2	Audio and Video.....	38
Trademarks	2	Preset.....	40
Product Overview	4	Enable Motion Detection.....	42
Package Contents.....	4	Time and Date.....	43
Minimum Requirements.....	5	Event Setup.....	44
Introduction	6	SD Card.....	52
Features.....	7	Advanced	53
Hardware Overview	8	Digital Input/Output	53
Front	8	White Light LED.....	54
Rear.....	9	HTTPS.....	55
Sides	10	Access List.....	56
Installation	11	Maintenance	57
Wireless Installation Considerations.....	11	Device Management	57
Zero Configuration Setup.....	13	System	58
Camera Setup Wizard.....	16	Firmware Upgrade.....	59
Windows Users	16	Status	60
Mac Users.....	17	Device Info	60
Manual Hardware Installation.....	18	Logs	61
WPS - Push Button Setup.....	19	Support	62
Download mydlink Lite/mydlink + Apps	20	Troubleshooting	63
Mount the Camera	21	DI/DO Specifications	64
Configuration	22	Technical Specifications	65
Configuration Interface.....	22	Contacting Technical Support	68
Live Video	23	Warranty	69
Setup.....	25	Registration	76
Setup Wizards	25		
Network Setup.....	31		
Wireless Setup.....	34		

Product Overview

Package Contents



DCS-2136L Wireless AC Day/Night Camera with Color Night Vision



CAT5 Ethernet cable



Power adapter



Stand/Mounting Bracket



Quick Install Guide

If any of the above items are missing, please contact your reseller.

Note: Using a power supply with a different voltage rating than the one included with your DCS-2136L will cause damage and void the warranty for this product.

Minimum Requirements

Network Requirements	<ul style="list-style-type: none">• 10/100 Ethernet network or an 802.11ac/n/g/b wireless network
Web-based Configuration Utility Requirements	<p>Browser Requirements:</p> <ul style="list-style-type: none">• Internet Explorer 7• Firefox 12• Safari 4• Chrome 20 <p>Note: Make sure you have the latest version of Java installed. Visit www.java.com to download the latest version.</p>
mydlink Website Requirements	<ul style="list-style-type: none">• Broadband Internet connection• Computer with:<ul style="list-style-type: none">• Internet Explorer 7 or higher (ActiveX)• Firefox 12 or higher• Safari 4 or higher• Chrome 20 or higher
mydlink Mobile Requirements	<ul style="list-style-type: none">• iOS version 4.3 or above• Android version 2.1 or above

Introduction

Congratulations on your purchase of the DCS-2136L Wireless AC Day/Night Camera with Color Night Vision. The DCS-2136L is a versatile surveillance solution for your business, and it offers mydlink™ Cloud Services. Unlike a standard webcam, the DCS-2136L is a complete system with a built-in CPU and web server that transmits high quality video images for surveillance. The simple installation and intuitive web-based interface offer easy integration with your Ethernet/Fast Ethernet or 802.11ac/n/g wireless network.

The DCS-2136L comes with remote monitoring and motion detection features, and can be controlled from any PC/Notebook over your local network or through the Internet via a web browser. If you download the free mydlink Lite App, you can monitor your business from anywhere, anytime from your iPhone, iPad or Android device, providing comprehensive and cost-effective 24/7 security.

Features

Easy to Use

The DCS-2136L is a stand-alone surveillance camera that requires no special hardware or software. You can operate the camera independently, even without a PC. Since the DCS-2136L is mydlink-enabled, you can either view and manage your camera using the mydlink website, or you can use the mydlink mobile app for iOS and Android mobile devices.

Supports a Variety of Platforms

Supports TCP/IP networking, HTTP, and other Internet-related protocols. The DCS-2136L can also be integrated easily into other Internet/Intranet applications because of its standards-based features.

Web Configuration

Using a standard Web browser, administrators can configure and manage the DCS-2136L directly from its own Web page via Intranet or Internet. This means you can access your DCS-2136L anytime, from anywhere in the world.

All-Day Surveillance with low-light color image capability

A built-in white light LED lets you monitor an area 24 hours a day with full color images, even in areas with low light or complete darkness. Combined with the passive IR sensor which can be used to trigger the white light LED, the DCS-2136L is a versatile surveillance device.

Broad Range of Applications

The DCS-2136L allows remote access using a Web browser for live image viewing, and allows the administrator to manage and control the DCS-2136L anytime, from anywhere in the world. There are many applications for this, including industrial monitoring of offices, banks, hospitals, and amusement parks, as well as educational monitoring of pre-schools, middle schools, and high schools.

802.11ac Wireless or Ethernet/Fast Ethernet Support

The DCS-2136L offers wireless 802.11ac and Ethernet/Fast Ethernet connectivity, making the DCS-2136L easy to integrate into your existing network environment. The DCS-2136L works with 10/100/1000Mbps Ethernet based networks for traditional wired environments, and works with 802.11ac routers or access points for added flexibility. The Site Survey feature also allows you to view and connect to any available wireless network.

Remote Monitoring Utility

The D-ViewCam™ application adds enhanced features and functionality for the DCS-2136L. It allows administrators to configure and access the DCS-2136L from a remote site via Intranet or Internet. Other features include image monitoring, recording images to a hard drive, taking snapshots, and viewing up to 32 cameras on one screen.

Hardware Overview

Front

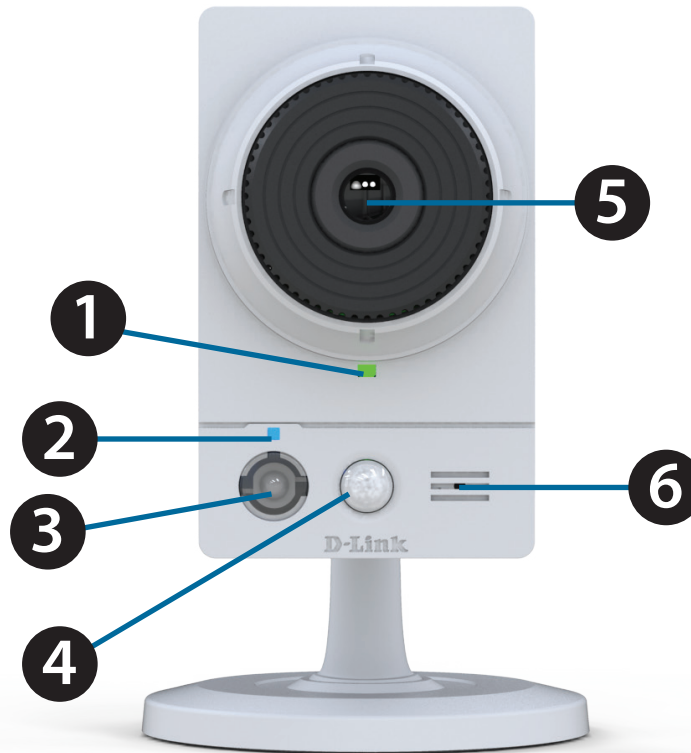

1	Power/Status LED	Indicates the camera's current status.
2	WPS Status LED	Indicates the WPS connection status of the camera.
3	White Light LED	Used to illuminate the camera's field of view at night.
4	PIR Sensor	Passive Infrared sensor for motion detection.
5	Camera Lens	Allows you to record or view video of the surrounding area.
6	Microphone	Allows you to record or listen to audio from the surrounding area.

Rear

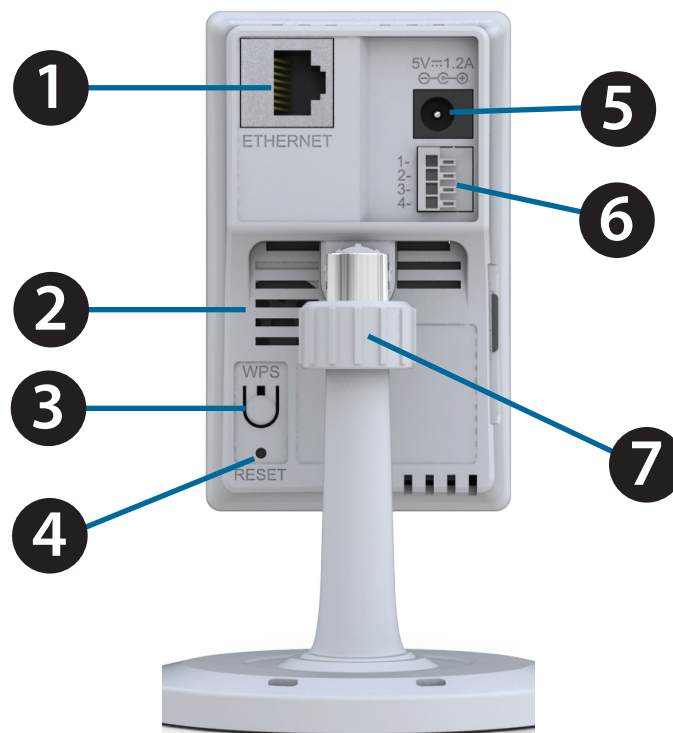

1	Ethernet Port	Using an Ethernet cable, connect the camera to your network.
2	Speaker	Enables audio output.
3	WPS Button	Press this button, then press the WPS button for five seconds on your router to set up a wireless connection automatically.
4	Reset Button	Press and hold this button for 10 seconds to reset the camera.
5	Power Jack	Connector for the supplied DC 5 V power adapter.
6	DI/DO Connector	I/O connectors for external devices.
7	Adjustment Ring	Tighten or loosen the adjustment ring to adjust the camera's position.

Sides



1	Micro SD Card Slot	Insert a MicroSD card for local storage of recorded video and images.
---	---------------------------	---

Installation

Wireless Installation Considerations

This D-Link camera can connect to your wireless network from anywhere within the operating range of your wireless network. However, the number, thickness, and location of walls, ceilings, or other objects that the wireless signals must pass through may limit the range. Typical ranges vary depending on the types of materials and background RF (radio frequency) noise in your home or business. The key to maximizing wireless range is to follow these basic guidelines:

1. Minimize the number of walls and ceilings between your camera and other network devices - each wall or ceiling can reduce your camera's range from 3-90 feet (1-30 meters).
2. Be aware of the direct line between network devices. A wall that is 1.5 feet thick (.5 meters), at a 45-degree angle appears to be almost 3 feet (1 meter) thick. At a 2-degree angle, it looks over 42 feet (14 meters) thick. Position your devices so that the signal will travel straight through a wall or ceiling (instead of at an angle) for better reception.
3. Building Materials make a difference. A solid metal door or aluminum studs may weaken the wireless signal. Try to position your access points, wireless routers, and other networking devices where the signal passes through drywall or open doorways. Materials and objects such as glass, steel, metal, walls with insulation, water (fish tanks), mirrors, file cabinets, brick, and concrete will degrade your wireless signal.
4. Keep your camera at least 3-6 feet or 1-2 meters away from electrical devices or appliances that generate RF noise.
5. If you are using 2.4GHz cordless phones or other radio frequency sources (such as microwave ovens), your wireless connection may degrade dramatically or drop completely. Make sure your 2.4GHz phone base is as far away from your wireless devices as possible. The base transmits a signal even if the phone is not in use.

Software Installation

There are three ways to set up your camera:

Zero Configuration Setup: If you have a D-Link Cloud Router, this is the easiest way to set up your camera. Refer to ["Zero Configuration Setup" on page 13](#).

Camera Setup Wizard: If you do not have a D-Link Cloud Router, use the *DCS-2136L Setup Wizard* to guide you through setup and initial configuration of your camera. Refer to ["Camera Setup Wizard" on page 16](#).

Manual Hardware Installation: This section shows you how to manually set up your camera. However, in order to use the mydlink features of your camera, you will still need to run the *DCS-2136L Setup Wizard*. Refer to ["Manual Hardware Installation" on page 18](#).

Zero Configuration Setup

If you have a D-Link Cloud Router, you can take advantage of Zero Configuration. Zero Configuration automatically configures your camera for you, and adds it to your mydlink account. This allows you to set up your camera by simply plugging it in and connecting it to your router. Then you will be able to remotely access your camera from the mydlink.com website.

If you do not have a D-Link Cloud Router, use the *DCS-2136L Setup Wizard* to guide you through setup and initial configuration of your camera. Refer to ["Camera Setup Wizard" on page 16](#).

Connect Using an Ethernet Cable

If using an Ethernet connection: Connect the included Ethernet cable to the Ethernet port located on the back of the DCS-2136L and connect it to your router.

Note: *Using the Ethernet connection will also configure your wireless settings. If you want to use your camera wirelessly, you can unplug the Ethernet cable once the setup is complete.*

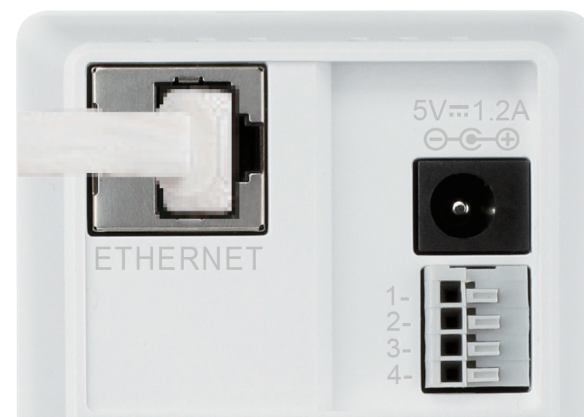

Attach the External Power Supply

Attach the external power supply to the power receptor located on the rear panel of the DCS-2136L. Connect the power supply to your wall outlet or power strip.

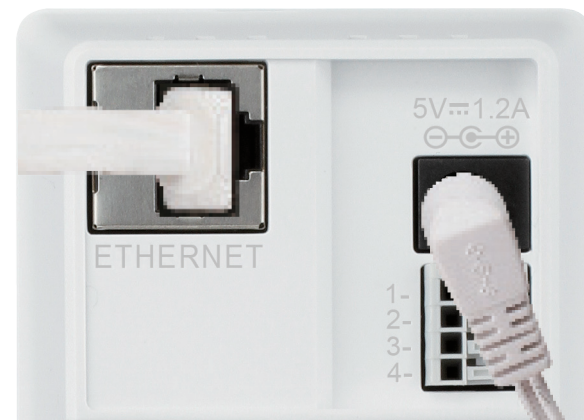

Confirm Your Camera's Addition to Your mydlink Account

From any computer, you can open a web browser and navigate to <http://www.mydlink.com>. Log into your mydlink account. When your camera is detected you will see, a *New Devices!* window in the bottom-left corner of the screen. Click on **DCS-2136L** to continue.



A *Confirming New Device* window will open, containing a summary of your settings. You will see the question, *Do you want to add this new device to your mydlink account?*

Make a note of the settings and click **Yes** to confirm the addition of the DCS-2136 to your mydlink account.

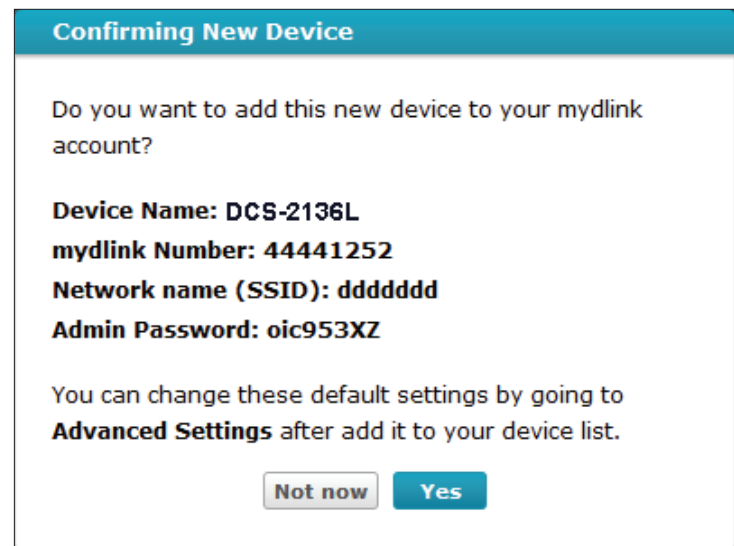

Section 2: Installation

Under the mydlink *Live View* tab, you will see a message that says, *Your new IP cam was successfully registered to your mydlink account!* Under the message you will see live video.

If you wish to connect your camera to your router wirelessly, you can now disconnect the Ethernet cable and move the camera to its intended location. Your router's wireless settings have been automatically transferred to the camera, and no further configuration is required.

Skip to "[Configuration](#)" on page 22 for advanced configuration of your camera.

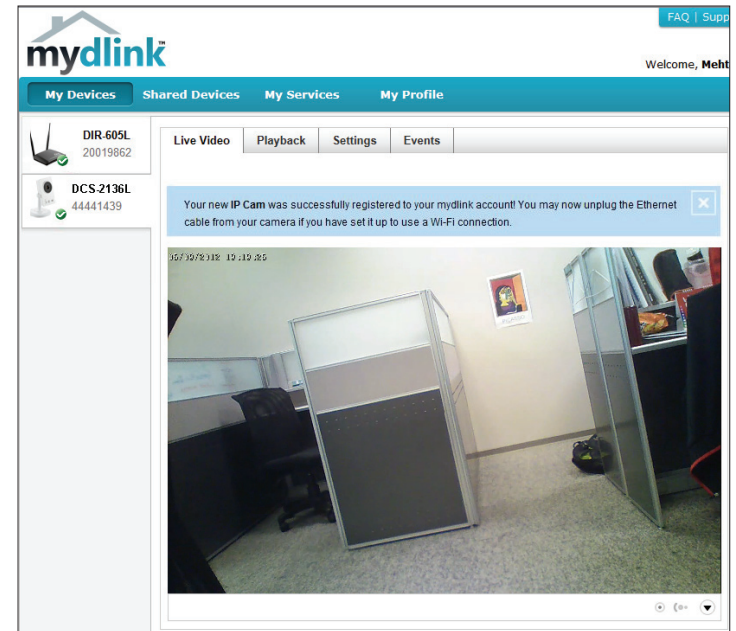

Camera Setup Wizard

If you do not have a D-Link Cloud Router, you can use a Windows or Mac computer to launch the *DCS-2136L Setup Wizard*, which will guide you through the complete installation process. Download the *Setup Wizard* from <http://www.mydlink.com/download>. Click your camera model and then under *Wizard*, click the link to the version (Windows or Mac) you want to download. Depending on your web browser, you may need to right-click the link and select **Save link as**. (Mac Users can skip to the next page.)

Windows Users

Extract ("unzip") the files to a folder on your computer and double-click the **autorun.exe** file. Click **Set up your Cloud Camera**, and the *DCS-2136L Setup Wizard* will guide you step-by-step through the complete installation process. Follow the on-screen instructions to connect your hardware, configure your camera, and register your DCS-2136L with your mydlink account.



Note: At the end of the camera setup process, you will see a summary that includes the camera's IP address. Make a note of it. You will need the IP address for advanced configuration of your camera. Refer to "[Configuration Interface](#)" on page 22.

Mac Users

Instructions on the previous page describe the *Setup Wizard* download from <http://www.mydlink.com/download>. Open the **SetupWizard** file and launch the application.

After about 20-30 seconds, the *DCS-2136L Setup Wizard* will open, which will guide you step-by-step through the complete installation process. Follow the on-screen instructions to connect your hardware, configure your camera, and register your DCS-2136L with your mydlink account.



Note: At the end of the camera setup process, you will see a summary that includes the camera's IP address. Make a note of it. You will need the IP address for advanced configuration of your camera. Refer to "[Configuration Interface](#)" on page 22.

Manual Hardware Installation

If you prefer to set up your camera manually, without using the Camera Setup Wizard, follow these steps*. If your router supports WPS (Wi-Fi Protected Setup), you can simply attach the power supply and go to ["WPS - Push Button Setup" on page 19](#).

***Note:** In order to use the mydlink features of this product, you must use the DCS-2136L Setup Wizard. Refer back to ["Camera Setup Wizard" on page 16](#).

Connect Using an Ethernet Cable

Connect the included Ethernet cable to the Ethernet port located on the back of the DCS-2136L and attach it to your network.

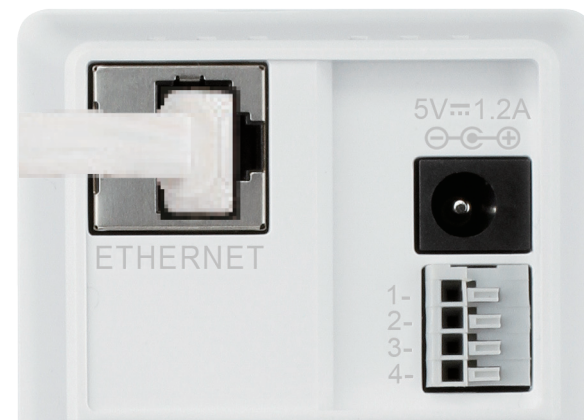

Attach the External Power Supply

Attach the external power supply to the DC power receptor located on the rear panel of the DCS-2136L and connect it to your wall outlet or power strip.

Configure Your Camera

Refer to ["Configuration" on page 22](#) for instructions on how to configure your camera.

Note: If your router supports WPS (Wi-Fi Protected Setup), you have the option to create a secure wireless connection with the push of a button. Refer to the next page for details.

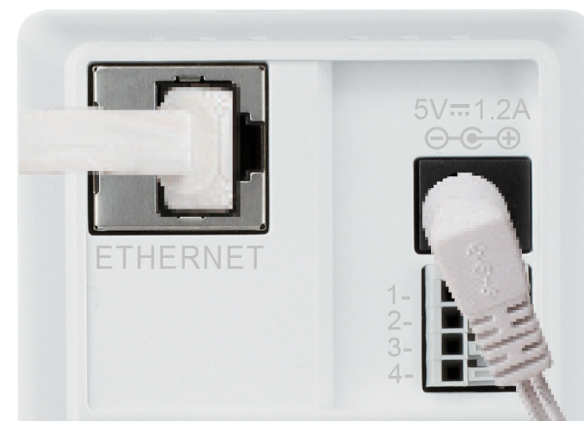

WPS - Push Button Setup

If your router supports WPS (Wi-Fi Protected Setup), utilize the WPS button on the camera to create a secure wireless connection to your network.

To create a WPS connection:

Step 1

Press and hold the WPS button for approximately five to six seconds. The blue WPS status LED above the button will blink.

Step 2

Within 60 seconds press the WPS button on your router. On some routers, you may need to log in to the web interface and click on an on-screen button to activate the WPS feature. If you are not sure where the WPS button is on your router, refer to your router's User Manual.

The DCS-2136L will automatically create a wireless connection to your router. While connecting, the status LED will flash. When the connection process is complete, the status LED will turn solid.

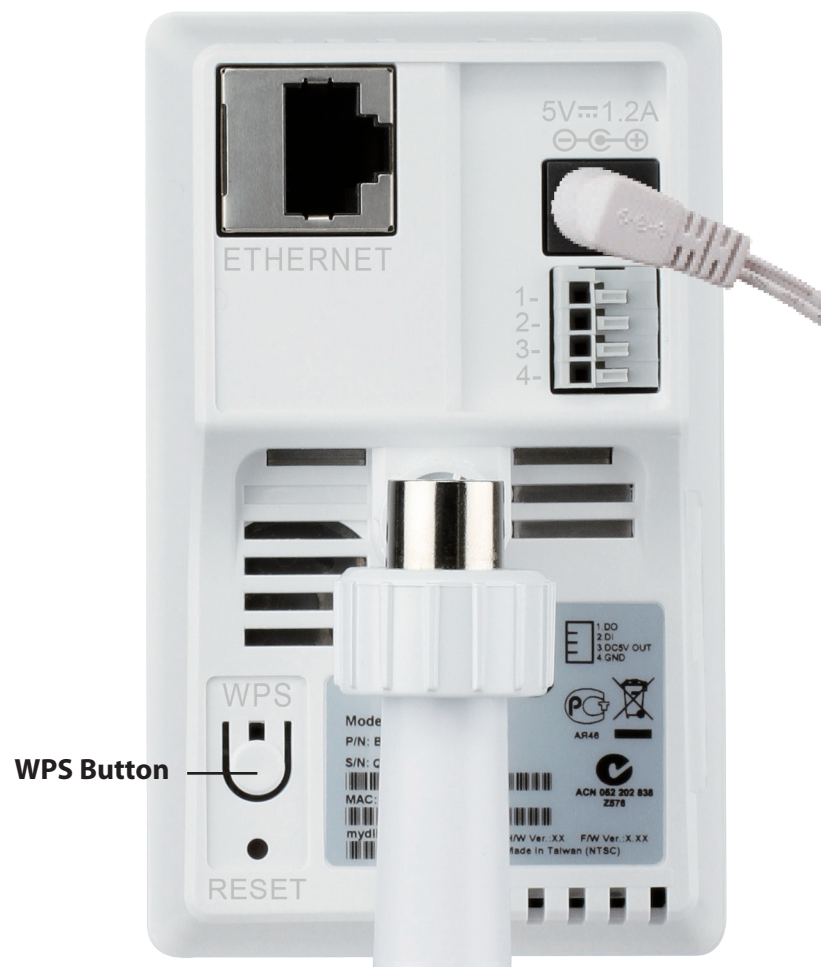

Download mydlink Lite/mydlink + Apps

mydlink Lite App (Free)

Search for “mydlink lite” to download and install the app on your smartphone or tablet when connected to the Internet. You can also find the app by scanning the QR code below with a QR code scan app.



System Requirements: iOS version 4.3 or above. Android version 2.1 or above.

mydlink+ App (Paid - Tablet Only)

Search for the word “mydlink+” to download and install the app on your tablet when connected to the Internet. You can also find the app by scanning the QR code below with a QR code scan app.



System Requirements: iOS version 4.3 or above. Android version 2.1 or above.

Mount the Camera

Refer to the steps below to assist you with mounting the camera. We suggest that you configure the camera before mounting it.

1. Place the mounting base where you want to position the camera and use a pencil to mark the holes.

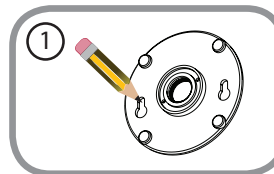

2. Depending on the material of the wall or ceiling, use proper tools to drill two holes or screws where you marked. If the wall is made out of concrete, drill the holes first, insert the plastic anchors and then the screws.

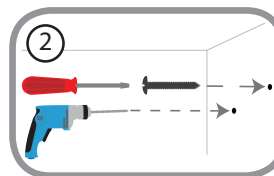

Note: The space between the camera and the screwheads should be 3mm.

3. Place the mounting base over the screw that is mounted on the wall. Make sure to fit the screw-heads over the big holes and slide it downward to lock firmly. Lightly pull the base forward to make sure that it is locked.

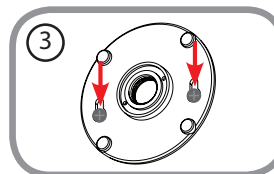

4. Place the base cover on the base and screw the camera stem clockwise into the mounting base.

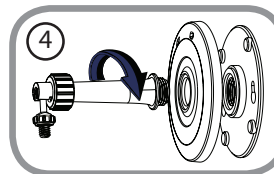

5. Adjust the angle of the camera as desired, then tighten the collar on the camera stem to lock it in place.

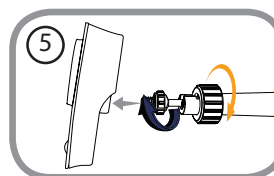

Configuration Configuration Interface

The camera's built-in configuration interface allows you to access to your DCS-2136L through the Internet. In order to access the interface, you need the IP address of your DCS-2136L. The simplest way to acquire the camera's IP address is by using the Camera Setup Wizard. At the end of the setup process there is a summary screen that includes the camera's IP address. If you did not launch the wizard but would like to, refer back to ["Camera Setup Wizard" on page 16](#).

Note: *If you choose not to use the Camera Setup Wizard, you can get the camera's IP address from your router.*

Open a web browser (e.g., Internet Explorer, Chrome, Firefox, or Safari). Enter the IP address of your camera. You will see a login window. For the User name enter **admin**. Enter the password you created in the Setup Wizard. If you did not create a password, by default the password is blank. Click **OK**.

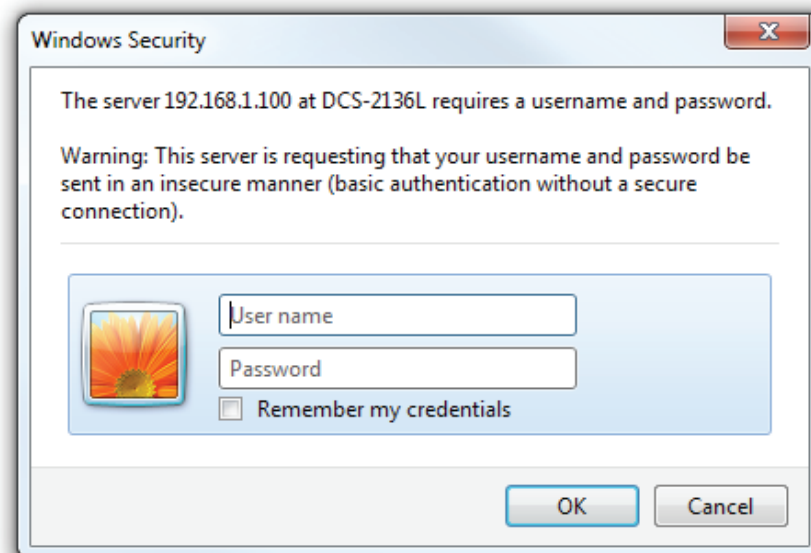

Live Video







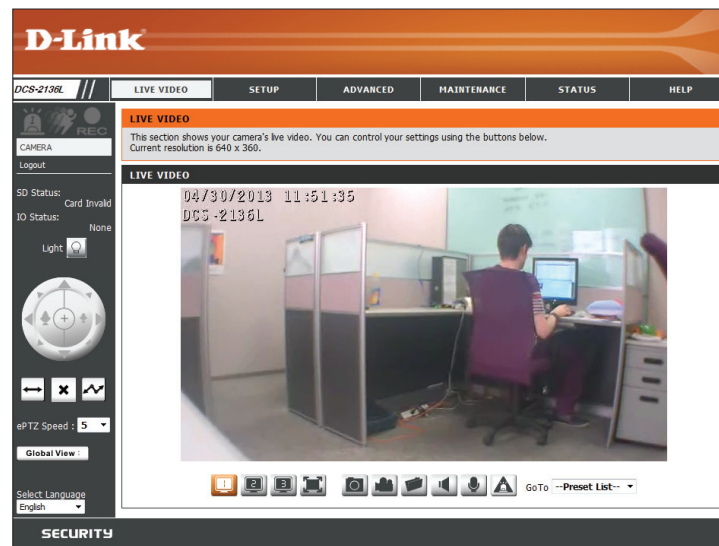

View your camera's live video from this screen. You can select any of the icons listed below to operate the camera.

Use your mouse to zoom in and out on the live video image. Right-click to zoom out or left-click to zoom in on the image.

SD Status: This option displays the status of the SD card. If no SD card has been inserted, this field will say, *Card Invalid*.

IO Status: This option displays the status of your I/O device if a device is connected. If not connected, this field will say, *None*.



	Digital Input Indicator	This indicator will change to amber when a digital input signal is detected.
	Motion Trigger Indicator	This indicator will change to amber when a trigger event occurs. Note: <i>The video motion feature for your camera must first be enabled.</i>
	Recording Indicator	This indicator will change to amber when a recording is in progress.
	White Light LED	This button may be used to enable or disable the white light LED. The functionality depends on the settings you select. Refer to "White Light LED" on page 54.
	Control Pad	This control pad can be used to electronically pan, tilt, and zoom (ePTZ) within the camera's predefined view area, if one has been defined.
	Auto Pan	This button starts the automatic panning function. The camera will pan back and forth within the Field of View (FOV).
	Stop	This button stops automatic panning function.
	Preset Path	If a preset path has been defined, this button will start the camera's motion along the path. See <i>Go To Preset List</i> on the next page.





ePTZ Speed: Click on the arrow to select a value between **0** and **64**. (Zero is the slowest and 64 is the fastest speed for pan, tilt, and zoom.)



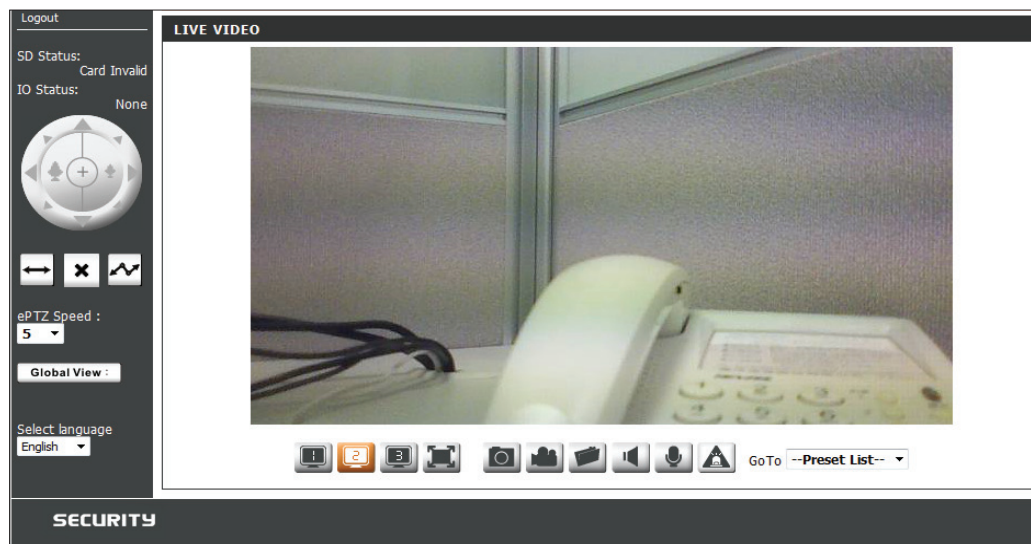

Global View: This window indicates the total field of view (FOV) of the camera.

Language: You have the option to select a different language for the interface using this menu.

Go To: If any presets have been defined, you will be able to click on the arrow and select a preset from the list.



-  Video Profile 1
-  Video Profile 2
-  Video Profile 3
-  Full screen mode
-  Taking a Snapshot

-  Record a Video Clip
-  Set a Storage Folder
-  Start/Stop Audio In (from microphone)
-  Start/Stop Audio Out (to speaker)
-  Start/Stop Digital Output

Setup

Setup Wizards

This screen provides setup wizards to guide you through connecting your camera to the network and setting up your motion detection preferences. If you have experience with camera configuration, you can skip the wizards and adjust the settings manually.

Internet Connection Setup Wizard: You can use the *Internet Connection Setup Wizard* to connect your camera to your network or directly to the Internet. Refer to step-by-step instructions for the "Internet Connection Setup Wizard" on page 26.

Manual Internet Connection Setup: To manually setup your camera's connection to your network or to modify the settings, refer to "Network Connection Setup" on page 31.

Motion Detection Setup Wizard: You may configure motion detection using the *Motion Detection Setup Wizard*. Refer to step-by-step instructions for the "Motion Detection Setup Wizard" on page 29.

Manual Motion Detection Setup: If you would prefer to setup the camera's motion detection manually, refer to "Enable Motion Detection" on page 42.

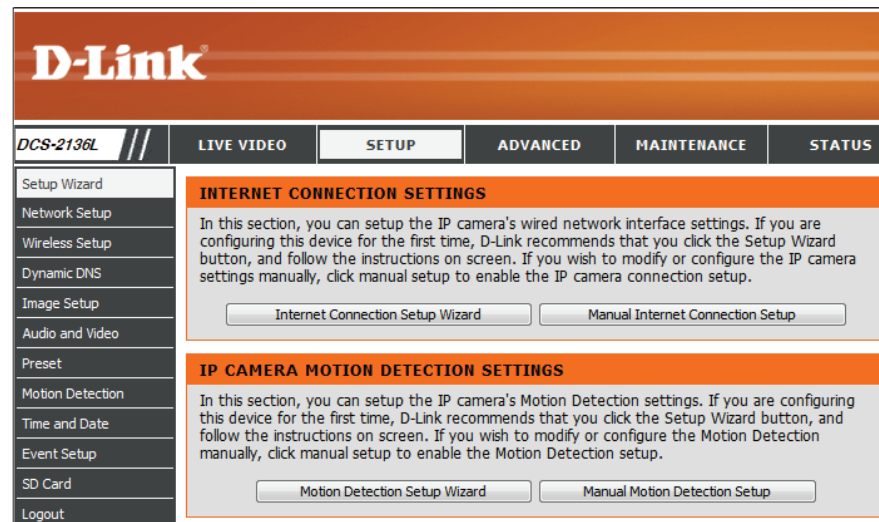

Internet Connection Setup Wizard

The *Internet Connection Setup Wizard* will guide you through a step-by-step process to configure your DCS-2136L and connect your IP camera to the network. Click **Next** to continue.

Note: *this wizard will not register your camera with mydlink.com.*

Select **DHCP** (Dynamic Host Configuration Protocol) if you want your DHCP server (usually enabled on your router) to assign the camera its IP settings.

If you want to manually assign the IP settings, select **Static IP Client** and enter the following details from your ISP:

IP Address: Enter an **IP Address** for your camera.

Subnet Mask: Enter the **Subnet Mask** of your network.

Default Router: Enter the **Default Gateway** address. This is usually the IP address (LAN) of your router.

Primary DNS: Enter the primary DNS server's IP address. This is usually also the IP address (LAN) of your router.

Secondary DNS: Enter the secondary DNS server's IP address. This field is optional.

If you are required to connect using PPPoE (Point to Point Protocol over Ethernet), select **Enable PPPoE** and enter the **User Name** and **Password** for your PPPoE connection. Only select this option if your camera is directly connected to your broadband modem. If it is on a network with a router or gateway, do not select this option.

Click **Next** to continue.

welcome to d-link setup wizard - internet connection setup

This wizard will guide you through a step-by-step process to configure your new D-Link IP camera and connect the IP camera to the internet. To set-up your camera motion detection settings, please click Back button to close this wizard and re-open the motion detection setup wizard.

- Step 1: Setup LAN Settings
- Step 2: Setup DDNS Settings
- Step 3: IP camera Name Settings
- Step 4: Setup Time Zone

Back Next Cancel

Step 1: Setup LAN Settings

Please select whether your IP camera will connect to the Internet with a DHCP connection or Static IP address. If your IP camera is connected to a router, or you are unsure which settings to pick, D-Link recommends that you keep the default selection of DHCP connection. Otherwise, click on Static IP address to manually assign and IP address before clicking on the Next button. Please enter your ISP Username and Password in the case that your ISP is using PPPoE and then click on the Next button. Please contact your ISP if you do not know your Username and Password.

DHCP
 Static IP Client

IP address
 Subnet mask
 Default router
 Primary DNS
 Secondary DNS

Enable PPPoE
 User Name
 Password (e.g. 654321@hinet.net)

Back Next Cancel

Section 4: Configuration

If you have a Dynamic DNS (Dynamic Domain Name System) account, you may have an IP address that changes frequently. Enabling DDNS allows your camera to update your IP address automatically, maintaining accessibility.

Enable DDNS: Click to enable the DDNS updating function.

Server Address: Select your DDNS server from the drop down menu.

Host Name: Enter the **Host Name** of the DDNS server.

User Name: Enter your **User Name** or the e-mail address used to connect to the DDN server.

Password: Enter the **Password** used to connect to the DDNS server.

Timeout: You can specify how often the camera notifies the DDNS server of its current global IP address by entering a whole number representing hours.

Click **Next** to continue.

Step 2: Setup DDNS Settings

If you have a Dynamic DNS account and would like the IP camera to update your IP address automatically, enable DDNS and enter in your host information below. Please click on the Next button to continue.

Enable DDNS

Server Address << ▾

Host Name

User Name

Password

Verify Password

Timeout (hours)

Section 4: Configuration

Create a unique name for your camera. Assign it to your DCS-2136L by entering it into the **IP Camera Name** field. Click **Next** to continue.

Select the **Time Zone** that corresponds to your camera's location in order to ensure that scheduled events occur at the correct time. If the selected **Time Zone** observes daylight saving time, check the **Enable Daylight Saving** box. You may select **Auto Daylight Saving** to have DST set automatically, or select **Set Date and Time Manually** so that you can set the start and end time of DST yourself.

Click **Next** to continue.

A summary of your camera settings is displayed for confirmation. If the settings are incorrect, click **Back** to make changes. Otherwise click **Apply**.

Note: Make a note of the IP camera settings so you can access your DCS-2136L on your network or by using a web browser.

Step 3: IP camera Name Settings

D-Link recommends that you rename your IP camera for easy accessibility. You can then identify and connect to your IP camera via this name. Please assign a name of your choice before clicking on the Next button.

IP camera Name DCS-2136L

Back Next Cancel

Step 4: Setup Time Zone

Please configure the correct time to ensure that all events are triggered, captured and scheduled at the correct time and day and then click on the Next button.

Time Zone (UTC+08:00) Taipei

Enable Daylight Saving

Back Next Cancel

Step 5: Setup complete

Below is a summary of your IP camera settings. Click on the Back button to review or modify settings or click on the Apply button if all settings are correct. It is recommended to note down these settings in order to access your IP camera on the network or via your web browser.

IP Address	DHCP
IP camera Name	DCS-2136L
Time Zone	(UTC+08:00) Taipei
DDNS	Disable
PPPoE	Disable

Back Apply Cancel

Motion Detection Setup Wizard

The *Motion Detection Setup Wizard* will guide you through a step-by-step process to configure your camera's motion detection. Click **Next** to continue.

Step 1

Check the box by **Enable Video Motion** to enable motion detection. Click on either **Snapshot** or **Video Clip** to specify what the camera should capture when motion is detected.

Refer to "[Enable Motion Detection](#)" on page 42 for details about how to set sensitivity, how much movement is required before triggering a camera event, etc. Click **Next** to continue.

Step 2

This step allows you to specify a motion detection schedule. Check the box by **Always** to record whenever motion is detected. Or you can check the boxes by the days and use the drop-down menu to select the hours when you would like your camera to detect motion. Click **Next** to continue.

Welcome To D-LINK Setup Wizard - Motion Detection

This wizard will guide you through a step-by-step process to configure your IP camera's motion detection functions. To setup the IP camera LAN or Internet settings, please click on the Back button to close this wizard and re-open the IP camera Setup wizard. Otherwise click on the Next button to begin.

- Step 1: Specify Motion Detection Area Settings
- Step 2: Motion Detection Schedule
- Step 3: Alerts and Notifications

Step 1: Specify Motion Detection Area Settings

This section will allow you to enable or disable motion detection as well as control the sensitivity of your camera's ability to detect movement.

Enable Video Motion Snapshot Video Clip

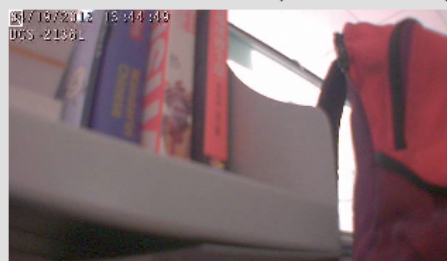

Sensitivity

0~100%

Percentage

0~100%

step 2: Motion Detection Schedule

This final step allows you to specify how you receive notification of camera events. Choose between an email notification or alternatively you can setup an FTP Notification. You will need your email account settings or FTP details. If you are unsure of this information, please contact your ISP. Once you have entered this information, please click on the Next button.

Sun Mon Tue Wed Thu Fri Sat

Time

Always

From To

Step 3

This step allows you to specify your preferences regarding notification of camera events. Click on **Do not notify me** if you choose not to receive event notification. Otherwise, select **Email** or **FTP**. Enter the relevant information for your e-mail or FTP account. Click **Next** to continue.

Step 3: Alerts and Notification

This final step allows you to specify how you receive notification of camera events. Choose between an email notification or alternatively you can setup an FTP Notification. You will need your email account settings or FTP details. If you are unsure of this information, please contact your ISP. Once you have entered this information, please click on the Next button.

Do not notify me

Email

Sender email address

Recipient email address

Server address

User name

Password

Port

FTP

Server address

Port

User name

Password

Remote folder name

Step 4

You have completed your IP Camera Setup. A summary of your selections is displayed for confirmation. If settings are incorrect, click **Back** to make changes. Otherwise click **Apply**.

Wait a few moments while your camera saves the settings and restarts. If you already connected your IP camera to the network using the *Setup Wizard*, skip to the section entitled "[Wireless Setup](#)" on page 34.

Step 4: Setup Complete

You have completed your IP camera setup. Please click the Back button if you want to review or modify your settings or click on the Apply button to save and apply your settings.

Motion Detection : Disable

EVENT : Video Clip

Schedule Day : Sun ,Mon ,Tue ,Wed ,Thu ,Fri ,Sat ,

Schedule Time : Always

Alerts and Notification : Do not notify me

Network Setup

Use this screen to configure the network connections for your camera, or to modify your network settings. After making changes, click **Save Settings**.

DHCP: Select this option if you have a DHCP server (i.e. router) running on your LAN (local area network), and would like your camera to obtain an IP address automatically.

Static IP Client: Select this option for a static or fixed IP address. You can obtain a static or fixed IP address for your camera from your network administrator.

IP Address: Enter the fixed **IP Address** for your camera in this field.

Subnet Mask: Enter the **Subnet Mask** for your network. This number is used to determine if the destination is in the same subnet as host devices.

Default router: Enter the default gateway address for the router that will be used to forward the data outside of the network.

Primary DNS: Enter the IP address of the **Primary DNS** (Domain Name Server) that translates names into IP addresses.

Secondary DNS: Enter the IP address of the **Secondary DNS** (optional). The secondary DNS acts as a backup to the primary.

Enable UPnP Presentation: Check the box to **Enable UPnP** (Universal Plug and Play). This setting allows your camera to be configured as a UPnP device on your network.

Enable UPnP Port Forwarding: Check to **Enable UPnP Port Forwarding**. This setting allows the camera to add port forwarding entries into the router automatically on a UPnP capable network.

D-Link

DCS-2136L // LIVE VIDEO SETUP ADVANCED MAINTENANCE STATUS HELP

NETWORK SETUP
You can configure your LAN and Internet settings here.
Save Settings Don't Save Settings

LAN SETTINGS

DHCP
 Static IP Client

IP address: 192.168.1.100
 Subnet mask: 255.255.255.0
 Default router: 192.168.1.1
 Primary DNS: 192.168.1.1
 Secondary DNS: 0.0.0.0

Enable UPnP presentation
 Enable UPnP port forwarding

Forwarding Port: 1024 Test
 Forwarding Status: UPnP forwarding is inactive

Helpful Hints..
 Select 'DHCP Connection' if you are running a DHCP server on your network and would like an IP address assigned to your IP camera automatically.
UPnP: Enabling UPnP settings will allow you to configure your IP camera as an UPnP device in the network.
PPPoE Setting: If you use the IP camera to connect directly to the Internet, you will need to enter the username and password, which were given to you when you set up your account with your Internet Service Provider. If the camera is behind a router or a gateway, you do not need to configure this setting.

Enable PPPoE: Check this box to **Enable PPPoE** (Point to Point Protocol over Ethernet). Only select this option if your camera is directly connected to your broadband modem. If it is on a network with a router or gateway, do not select this option.

User Name & Password: Enter the **User Name** and **Password** for your PPPoE account. You may obtain this information from your Internet Service Provider (ISP).

HTTP Port: The default number is **80** for the port allocated to connect the camera to the Internet using a standard web browser.

Access Name for Streams 1 thru 3: The default name is **video#.mjpg**, where # corresponds with the number of the stream.

HTTPS Port: The default number is **443** for the port allocated to connect the camera to the Internet using a secure web browser.

Authentication: Click the arrow for the drop-down menu in order to **Enable/Disable** Authentication of RTSP (Real Time Streaming Protocol).

RTSP Port: The default port number is **554** for the port allocated to connect to an IP camera using a streaming mobile device, like a mobile phone or PDA. You may specify the address of a particular stream. Example: live1.sdp can be accessed at rtsp://x.x.x.x/video1.sdp where the x.x.x.x represents the IP address of your camera.

Enable CoS: Check to **Enable Cos** (Class of Service). This setting implements assignment of priority to packets being transmitted, using a best-effort policy. This means there is no guarantee of level of service in terms of bandwidth and delivery time.

The screenshot displays the configuration web interface for the camera, organized into several sections:

- PPPOE SETTINGS:**
 - Enable: Enable, Disable
 - User Name:
 - Password:
 - Confirm password:
 - PPPoE Status: PPPoE is inactive.
- HTTP:**
 - HTTP port:
 - Access name for stream1:
 - Access name for stream2:
 - Access name for stream3:
- HTTPS:**
 - HTTPS port:
- RTSP:**
 - Authentication:
 - RTSP port:
 - Access name for stream1:
 - Access name for stream2:
 - Access name for stream3:
- COS SETTINGS:**
 - Enable CoS:
 - VLAN ID: [0~4095]
 - Live video:
 - Live audio:
 - Event/Alarm:
 - Management:

Help Text on the Right:

- HTTP:** HTTP Port is the port you allocate in order to connect to the IP camera via a standard web browser.
- HTTPS:** HTTPS Port in a IP camera connects it with a PC via a secure web browser.
- RTSP:** RTSP Port is the port you allocate in order to connect to a IP camera by using streaming mobile device(s), such as a mobile phone or PDA.
- CoS (Class of Service):** Coarsely-grained traffic control based on the L2 protocol. Class of Service technologies do not guarantee a level of service in terms of bandwidth and delivery time, they offer a "best-effort".
- QoS (Quality of Service):** Finely-grained traffic control, a resource reservation control mechanism. Quality of service guarantees are important if the network capacity is insufficient, especially for real-time streaming multimedia applications.
- Enable IPv6:** Select this option and click Save to enable IPv6 setting. Please note that this only works if your network environment and hardware equipment support IPv6. The browser should be Microsoft ® Internet Explorer 6.5, Mozilla Firefox 3.0 or above. When IPv6 is enabled, by default, the Network

Enable QoS: Check to **Enable QoS** (Quality of Service). This setting allows you to specify a traffic priority policy to ensure consistent Quality of Service during busy time periods. If the DCS-2136L is connected to a router that itself implements QoS, the router's settings will override the QoS settings of the camera.

Enable IPv6: Check **EnableIPv6** to manually set up the IP address. This setting only works if your network and hardware support IPV6 protocol, which is the latest version of Internet Protocol (IP).

Note: *the vast majority of Internet traffic in the U.S. currently uses IPv4.*

Enable Multicast for streams: Check the boxes to multicast each of the available streams using group addresses. If you do not want to use the default settings, you can enter the port and Time to Live (TTL) values you prefer.

Verify your settings and click **Save Settings**.

The screenshot displays the configuration web interface for the camera, divided into three main sections: QoS SETTINGS, IPV6, and MULTICAST.

- QoS SETTINGS:**
 - Enable QoS
 - Live video: 0
 - Live audio: 0
 - Event/Alarm: 0
 - Management: 0
- IPV6:**
 - Enable IPv6
 -
 - Manually setup the IP address
 - Optional IP address / Prefix length: [] / 64
 - Optional default router: []
 - Optional primary DNS: []
- MULTICAST:**
 - Enable multicast for stream 1
 - Multicast group address: 239.1.1.1
 - Multicast video port: 6550
 - Multicast RTP video port: 6551
 - Multicast audio port: 6552
 - Multicast RTP audio port: 6553
 - Multicast TTL [1~255]: 64
 - Enable multicast for stream 2
 - Multicast group address: 239.1.1.2
 - Multicast video port: 6554
 - Multicast RTP video port: 6555
 - Multicast audio port: 6556
 - Multicast RTP audio port: 6557
 - Multicast TTL [1~255]: 64
 - Enable multicast for stream 3
 - Multicast group address: 239.1.1.3
 - Multicast video port: 6558
 - Multicast RTP video port: 6559
 - Multicast audio port: 6560
 - Multicast RTP audio port: 6561
 - Multicast TTL [1~255]: 64

At the bottom of the interface are two buttons: and .

Camera will listen to router advertisements and be assigned a link-local IPv6 address accordingly.

IPv6 Information: Click this button to obtain the IPv6 information. If your IPv6 setting are successful, the IPv6 address list will be listed in the pop-up window. Please follow the steps below to link to an IPv6 address:

- 1) Open your web browser.
- 2) Enter the link-global or link-local IPv6 address in the address bar of your web browser.
- 3) Press Enter on the keyboard or click Refresh button to refresh the webpage.

Manually setup the IP address: Select this option to manually configure IPv6 setting if your network environment does not have DHCPv6 server and advertisements-enabled routers.

Multicast: Click the items to display the detailed configuration information. Select the Always multicast option to enable multicast for stream 1 ~ 3. Unicast video transmission delivers a stream through point-to-point transmission; multicast, on the other hand, sends a stream to the multicast group address and allows multiple clients to acquire the stream at the same time by requesting a copy from the multicast group address. Therefore, enabling multicast can effectively save network bandwidth.

Multicast RTP video, audio port/Multicast RTP video, audio port: The ports can be changed to values between 1024 and 65534. The multicast RTP port must be an even number and the multicast RTP port number is the multicast RTP port number plus one, and this is always odd. When

Wireless Setup

Use this screen to set up and configure the wireless settings on your camera. After making changes, click the **Save Settings**.

Enable Wireless: Check the box to **Enable Wireless**.

Site Survey: Click **Rescan** to scan for available wireless networks. Then you can use the drop-down menu to select a wireless network from the *SSID List*. The fields for related information (Wireless Mode, Channel, Authentication, Encryption) will be automatically completed.

SSID: You may enter an **SSID** (Service Set Identifier) manually if you did not use Site Survey to select an available wireless network.

Wireless Mode: Use the drop-down menu to select the mode of the wireless network you want to connect your camera to. **Infrastructure** is for connecting to an access point or router. **Ad-Hoc** is for connecting directly to a computer.

Channel: If you are using Ad Hoc mode, select the **Channel** of the wireless network you wish to connect to, or select **Auto**.

Authentication: Select the authentication type for your wireless network - **Open**, **Shared**, **WPA-PSK**, or **WPA2-PSK**.

Encryption: For WPA-PSK or WPA2-PSK authentication, you need to specify whether your wireless network uses **TKIP** or **AES** encryption. For Open or Shared authentication, specify **WEP** encryption.

Key: If you use WEP, WPA-PSK, or WPA2-PSK authentication, enter the **Key**, or password, for your wireless network.

Dynamic DNS

If you have a Dynamic DNS (Dynamic Domain Name System) account, you may have an IP address that changes frequently. Enabling DDNS allows you to assign a website domain name to your IP camera. Then you can connect by entering the domain name, regardless of your actual IP address.

Enable DDNS: Check this box to **Enable DDNS**.

Server Address: Select the Dynamic DNS provider from the drop-down menu or enter the server address manually.

Host Name: Enter the **Host Name** of the DDNS server.

User Name: Enter the **User Name** or e-mail used to connect to your DDNS account.

Password: Enter the **Password** used to connect to your DDNS server account.

Timeout: Enter the DNS **Timeout** value in hours.

Status: Indicates the connection **status**, which is automatically determined by the system.

Click **Save Settings** to save your changes.

The screenshot shows the D-Link web interface for the DCS-2136L camera. The main navigation bar includes 'LIVE VIDEO', 'SETUP', 'ADVANCED', 'MAINTENANCE', 'STATUS', and 'HELP'. The 'SETUP' menu is expanded, showing options like 'Setup Wizard', 'Network Setup', 'Wireless Setup', 'Dynamic DNS', 'Image Setup', 'Audio and Video', 'Preset', 'Motion Detection', 'Time and Date', 'Event Setup', 'SD Card', and 'Logout'. The 'Dynamic DNS' option is selected, displaying the following content:

DYNAMIC DNS

The Dynamic DNS feature allows you to use a domain name that you have purchased (www.yourdomain.com) to access your IP camera with a dynamically assigned IP address. Most broadband Internet service providers assign dynamic (changing) IP addresses. By using a DDNS service, you can enter your domain name to connect to your IP camera no matter what your IP address is.

[Sign up for D-Link's Free DDNS service at www.DLinkDDNS.com.](http://www.DLinkDDNS.com)

Buttons: Save Settings, Don't Save Settings

DYNAMIC DNS SETTING

Enable DDNS:

Server Address: <<

Host Name:

User Name:

Password:

Verify Password:

Timeout: (hours)

Status: Inactive

Buttons: Save Settings, Don't Save Settings

Helpful Hints..

Dynamic DNS is useful if you have a DSL or Cable service provider that changes your modem IP address periodically. This will allow you to assign a website domain name to your IP camera instead of connecting through an IP address.

Image Setup

From this screen, you can configure the image settings for your camera. A preview of the image will be shown below the *Live Video* heading.

Enable Privacy Mask Setting: Check the box to **Enable Privacy Mask**. You can specify up to three rectangular areas for exclusion from video recordings and snapshots. Click and drag the mouse over the camera image to draw a privacy mask. If you right click on the camera image you will see the following menu options:

Disable All: Disables all mask areas

Enable All: Enables all mask areas

Reset All: Clears all mask areas.

Mirror: Select **On** to mirror the image horizontally.

Flip: Select **On** to flip the image vertically. If you turn *Flip* on, you may want to consider turning *Mirror* on as well.

Power Line: Select the frequency (**60 Hz** or **50 Hz**) that is used by your power lines to avoid interference or flicker.

White Balance: Use the drop-down menu to adjust **White Balance** settings for different environments. Select from **Auto**, **Outdoor**, **Indoor**, **Fluorescent**, and **Push Hold**.

Exposure Mode: Select an **Exposure Mode**. Use the drop-down menu to select from **Indoor**, **Outdoor**, or **Night** environments. Select **Moving** to capture moving objects. The **Low Noise** option generates a high-quality picture with a minimum amount of noise. You can also create three different custom exposure modes.

The screenshot displays the D-Link web interface for the DCS-2136L camera. The top navigation bar includes 'LIVE VIDEO', 'SETUP', 'ADVANCED', 'MAINTENANCE', 'STATUS', and 'HELP'. The left sidebar lists various setup options, with 'Image Setup' selected. The main content area is titled 'IMAGE SETUP' and contains a message: 'Changes to your IP camera settings are made immediately.' Below this is the 'LIVE VIDEO' section, which features a video preview and an unchecked checkbox for 'Enable Privacy Mask Setting'. The 'IMAGE SETTINGS' section includes the following controls:

- Mirror: Radio buttons for On and Off (Off is selected).
- Flip: Radio buttons for On and Off (Off is selected).
- Power Line: Radio buttons for 60 Hz and 50 Hz (60 Hz is selected).
- White Balance: A dropdown menu set to 'Auto'.
- Exposure Mode: A dropdown menu set to 'Indoor', with a 'Max Gain' of 36 dB.
- Denoise: A dropdown menu set to '0'.
- Brightness: A dropdown menu set to '128'.
- Contrast: A dropdown menu set to '128'.
- Saturation: A dropdown menu set to '128'.
- Sharpness: A dropdown menu set to '128'.
- WDR Level: A dropdown menu set to 'WDR' with a value of '5'.
- 3D filter: A dropdown menu set to 'None'.

A 'Reset Default' button is located at the bottom of the settings section. The right sidebar, titled 'Helpful Hints...', provides instructions for Privacy Mask, Mirror, Flip, Power Line, and White Balance settings.

Max Gain: You can adjust the **Max Gain** setting in order to apply the maximum amount of gain to brighten the picture.

Denoise: Adjust this setting to control the amount of noise reduction that will be applied to the picture.

Brightness: Adjust this setting to compensate for backlit subjects.

Contrast: Adjust this setting, which is defined by the difference between the darkest and lightest areas of an image. For example, setting a higher contrast may improve the image quality on a day when the sky is dark gray.

Saturation: Adjust the intensity of color, ranging from grayscale to fully saturated.

Sharpness: Adjust the degree of sharpening to be applied to the image.

WDR Level: Adjust the **WDR Level** (Wide Dynamic Range). WDR allows the camera to record greater scene details, from darker shadows to brighter highlights. This is especially important in environments like lobby entrances, parking lots, and ATMs, where WDR adjustment can make a big difference in the viewer's ability to identify details.

3D filter: Adjust this setting to reduce image artifacts. The desired result is less blur when the video is recorded during the night or in areas where there are low levels of light. Select from **Low**, **Medium**, or **High**.

Reset Default: Click to reset the camera to factory default settings.

D-Link

DCS-2136L // LIVE VIDEO SETUP ADVANCED MAINTENANCE STATUS HELP

Setup Wizard
Network Setup
Wireless Setup
Dynamic DNS
Image Setup
Audio and Video
Preset
Motion Detection
Time and Date
Event Setup
SD Card
Logout

IMAGE SETUP
Changes to your IP camera settings are made immediately.

LIVE VIDEO

Enable Privacy Mask Setting

08/19/2011 11:04:37
DCS-2136L

IMAGE SETTINGS

Mirror On Off
Flip On Off
Power Line 60 Hz 50 Hz
White Balance **Auto**
Exposure Mode **Indoor** Max Gain **36** dB
Denoise **0**
Brightness **128**
Contrast **128**
Saturation **128**
Sharpness **128**
WDR Level **WDR** **5**
3D filter **None**

Reset Default

Helpful Hints..

Privacy Mask: Click the attached box to activate this function. Now use your mouse to draw a rectangle covering the area you want hidden. Click the box again to deactivate the function.

Mirror: This function horizontally reverses your images 180 degrees.

Flip: This function vertically reverses your images 180 degrees.

Power Line: This setting is used to remove 50/60 Hz flicker.

White Balance: White Balance - Is the process of removing unrealistic color casts, so that objects which appear white in person are rendered white in your photo.

Exposure Mode: Exposure is the total amount of light allowed to fall on the image sensor during the process of capturing an image. You may choose different scene modes to produce the better images.

Max Gain: It can always be enabled automatically. But you have an option - you can change Max Gain either automatically or manually.

Denoise: It is the process of removing noise from a signal.

Audio and Video

You may configure up to three different video profiles on your camera from the *Audio and Video* screen. You can set up profiles for your computer that are different than profiles intended for your mobile devices. In addition, you may configure the two-way audio settings for your camera.

Aspect ratio: Click the drop-down menu to change the aspect ratio of the video. Aspect ratio is the ratio between the width and height of the image. Select either **4:3** standard or **16:9** widescreen.

Mode: Select a mode for the profile from the drop-down menu. The video codec options are **JPEG**, **MPEG-4**, or **H.264**.

Frame size/View window area: **Frame size** determines the total capture resolution, and **View window area** determines the Live Video viewing window size. When the **Frame size** is larger than the Live Video size, you can use the ePTZ controls to look around.

16:9 1280 x 720, 800 x 450, 640 x 360, 480 x 270, 320 x 176, 176 x 144

4:3 1024 x 768, 800 x 600, 640 x 480, 480 x 360, 320 x 240, 176 x 144

Note: If your **View window area** is the same as your **Frame size**, you will not be able to use the ePTZ function.

The screenshot displays the D-Link DCS-2136L web interface for configuring audio and video settings. The interface is organized into several sections:

- Navigation Menu:** Includes Setup Wizard, Network Setup, Wireless Setup, Dynamic DNS, Image Setup, Audio and Video (selected), Preset, Motion Detection, Time and Date, Event Setup, SD Card, and Logout.
- Audio and Video Section:**
 - Helpful Hints:** Provides information on frame size, frame rate, and bit rate, and suggests setting the Frame Rate to 5fps and the Bit Rate to 64 kbps for mobile viewing.
 - Video Settings:**
 - Aspect ratio: 16:9 (Warning: Change the aspect ratio will clear the settings of privacy mask and preset and motion detection).
 - VIDEO PROFILE 1:**
 - Mode: H.264
 - Frame size: 1280x720
 - View window area: 1280x720
 - Maximum frame rate: 30
 - Video quality: Excellent (Fixed quality selected)
 - VIDEO PROFILE 2:**
 - Mode: JPEG
 - Frame size: 640x360
 - View window area: 640x360
 - Maximum frame rate: 30
 - Video quality: Excellent
 - VIDEO PROFILE 3:**
 - Mode: H.264
 - Frame size: 320x176
 - View window area: 320x176
 - Maximum frame rate: 30
 - Video quality: 512K (Constant bit rate selected)
 - AUDIO SETTINGS:**
 - Audio in off
 - Audio in gain level: 26dB
 - Audio out off
 - Audio out volume level: 6

Maximum frame rate: Click the arrow to select a **Maximum Frame Rate**. Recording at a higher frame rate provides smoother motion for videos, and requires more bandwidth. Lower frame rates will result in stuttering motion, and requires less bandwidth.

Video Quality: Select **Constant bit rate** or **Fixed quality**.

Constant bit rate: Select **Constant bit rate** if you want a fixed bandwidth, regardless of video quality. Higher bit rates result in better video quality, requiring greater bandwidth.

Fixed quality: Select an image quality level for the camera to maintain. The intent of this option is to allow the user to optimize bandwidth utilization.

Audio in off: Check this box to mute incoming audio.

Audio in gain level: Adjust this setting to control the amount of gain applied to incoming audio and increase the volume.

Audio out off: Check this box to mute outgoing audio.

Audio out volume level: Adjust this setting to control the amount of gain applied to outgoing audio and increase the volume.

After making changes, click **Save Settings**.

The screenshot displays the D-Link DCS-2136L configuration interface. The main content area is titled 'AUDIO AND VIDEO' and contains several sections:

- AUDIO AND VIDEO:** A header section with a description: 'This section allows you to configure the sound and video of your camera. You can configure different settings depending on whether you are viewing content from a PC or a Mobile Phone / PDA.' It includes 'Save Settings' and 'Don't Save Settings' buttons.
- VIDEO SETTINGS:** Contains 'Aspect ratio' set to '16:9' with a warning: 'Warning: Change the aspect ratio will clear the settings of privacy mask and preset and motion detection.' It has 'Save' and 'Default' buttons.
- VIDEO PROFILE 1:** Includes 'Mode' (H.264), 'Frame size' (1280x720), 'View window area' (1280x720), 'Maximum frame rate' (30), and 'Video quality' (Excellent). Under 'Video quality', 'Constant bit rate' is selected with '1M' and 'Fixed quality' is unselected.
- VIDEO PROFILE 2:** Includes 'Mode' (JPEG), 'Frame size' (640x360), 'View window area' (640x360), 'Maximum frame rate' (30), and 'Video quality' (Excellent).
- VIDEO PROFILE 3:** Includes 'Mode' (H.264), 'Frame size' (320x176), 'View window area' (320x176), 'Maximum frame rate' (30), and 'Video quality' (Excellent). Under 'Video quality', 'Constant bit rate' is selected with '512K' and 'Fixed quality' is unselected.
- AUDIO SETTINGS:** Includes 'Audio in off' (checked), 'Audio in gain level' (26dB), 'Audio out off' (checked), and 'Audio out volume level' (6). It has 'Save Settings' and 'Don't Save Settings' buttons at the bottom.

On the right side, there are 'Helpful Hints.' including:

- Higher frame size, frame rate and bit rate gives better video quality. At the same time, it requires more network bandwidth.
- For best viewing results on a mobile phone, we suggest setting the Frame Rate to 5fps and the Bit Rate to 64 kbps.
- Aspect Ratio:** An aspect ratio is the ratio between the width and height of an image.
- Mode:** It can be H.264, JPEG, or MPEG4. In JPEG mode, the video frames are independent. MPEG4 consumes much less network bandwidth than JPEG, and H.264 can use less bandwidth but better image quality.
- Frame Size:** 5 options exist for the sizes of the video display. It is recommended using 320x176 for mobile viewing and 1280x720 for computer viewing.
- View window area:** The viewing region of the current video stream.
- Max frame rate:** The maximum number of frames that is displayed in 1 second. 30fps is the highest video quality for this camera. In general, any frame rate above 15 fps is imperceptible to the human eye.
- Video Quality:** This limits the maximal refresh frame rate, which can be combined with the 'Fixed quality' to optimize the bandwidth utilization and video quality. If the User wants to fix the bandwidth utilization regardless of the video quality, choose 'Constant bit rate' and select the desired bandwidth.
- Audio Settings:** You can use the option to switch the external microphone on/off or adjust the volume.

Preset

This screen allows you to preset points for the ePTZ (Point, Tilt, Zoom) function of the camera. You can look around within the camera's viewable area by using the zoom function. Presets allow you to quickly go to and view a specific area your camera is covering. Plus, you can create preset sequences, which will automatically change the camera's view from one preset to the next, according to a predefined order and specific timing.

Note: Only when you set the **View window area** smaller than the **Frame size** will you be able to use the ePTZ function. Refer to "Audio and Video" on page 38.

Video Profile: Click on the arrow and select a number for the **Video Profile** you would like to use.

ePTZ Speed: Click on the arrow and select a value for the **ePTZ Speed**. 0 is the slowest and 64 is the fastest.

Arrow Buttons and Home Button: Use the arrows to move to a specific part of the viewing area, which you can then capture as a preset. Click the **Home** button to return to the center of the viewing area.

Input Preset Name: Enter the name of the preset you captured, then click the **Add** button to create a new preset. If you select an existing preset from the **Preset List**, you can change its name by typing in a new name, then clicking the **Rename** button.

Preset List: Click this drop-down menu to see a list of all the presets that have been created. You can select one, then click the **GoTo** button to change the displayed camera view to the preset. Clicking the **Remove** button will delete the currently selected preset.

The screenshot displays the D-Link web interface for the DCS-2136L camera. The top navigation bar includes 'LIVE VIDEO', 'SETUP', 'ADVANCED', 'MAINTENANCE', 'STATUS', and 'HELP'. The 'SETUP' menu is expanded, showing options like Setup Wizard, Network Setup, Wireless Setup, Dynamic DNS, Image Setup, Audio and Video, Preset, Motion Detection, Time and Date, Event Setup, SD Card, and Logout. The 'Preset' option is selected.

The main content area is divided into three sections:

- PRESET CONTROL:** This section features a live video feed of an office interior. To the right of the video, there are controls for 'VIDEO PROFILE' (set to 1) and 'ePTZ Speed' (set to 5). Below these are directional arrow buttons (up, down, left, right) and a central 'Home' button.
- PRESET:** This section contains an 'Input Preset Name' field with 'Add' and 'Rename' buttons. Below it is a 'Preset List' dropdown menu with a 'GoTo' button and a 'Remove' button. A note indicates 'Support(0~9,A~Z,a~z,-,*,/,_)'. The 'GoTo' button is highlighted in red.
- PRESET SEQUENCE:** This section shows a 'Preset Name' field with 'Dwell time' set to 10. It includes 'Add', 'Update', and 'Remove' buttons. A note indicates 'Second(s)[3~30]'. There are also directional arrow buttons and a trash icon.

On the right side of the interface, there is a 'Helpful Hints..' section with the following text:

- Input Preset Name:** Using the Pan, Tilt and Zoom (PTZ) controls, move the camera view to the required position and simply by selecting the preset's name.
- Add:** This camera position is then saved as a preset position in the camera.
- GoTo:** for test the preset the preset position.
- Preset Sequence:** A preset sequence is an automated series of camera movements from one preset position to another. A guard tour can be set up to display the video streams from different preset positions in a pre-determined order, and for configurable time periods.
- Add:** set up a new preset sequence, Modify to change, and Remove to remove an existing preset sequence.

Preset Sequence: This section allows you to create a **Preset Sequence**, which will automatically change the camera's view from one preset to the next, according to a predefined order and specific timing.

Preset List: To add a preset to the sequence, select it from the drop-down menu at the bottom of this window, set the **Dwell time** to determine how long the camera view will remain at that preset, then click the **Add** button. The preset name will appear in the list, followed by the dwell time for viewing that preset.

You can change your presets in the sequence by selecting a preset, then clicking the arrow buttons to move it higher or lower in the current sequence.

Clicking the trash can button will remove the currently selected preset from the sequence.

If you want to change the dwell time for a preset, select it from the list, enter a new dwell time, then click the **Update** button.

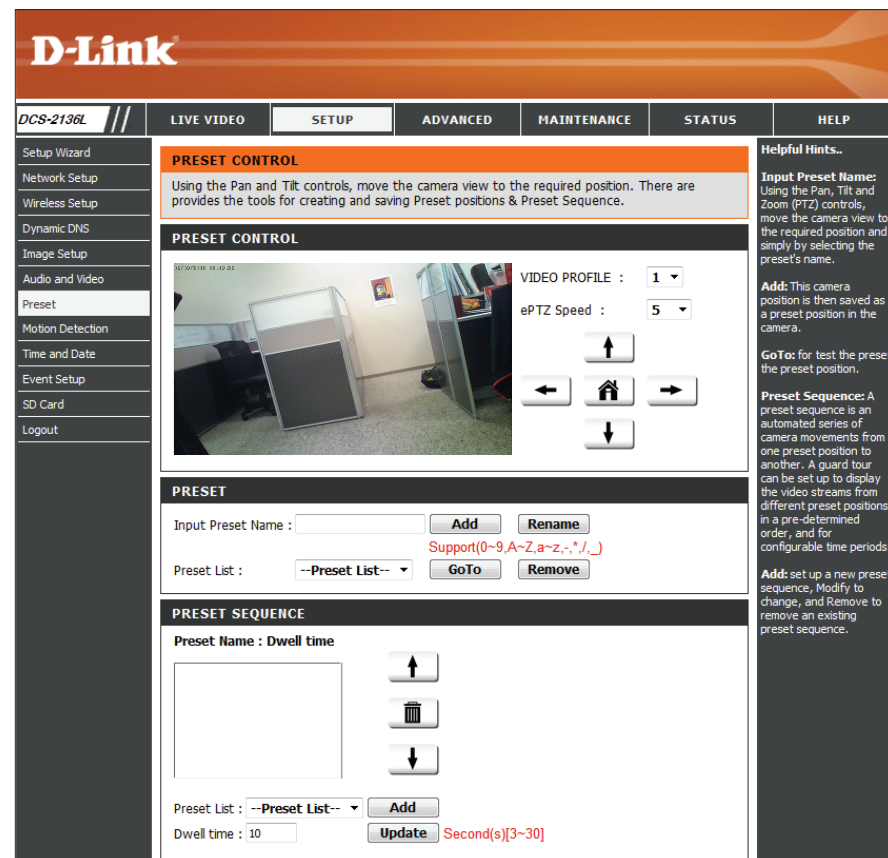

Enable Motion Detection

Enabling Video Motion will allow your camera to use the motion detection feature. You may draw a finite motion area that will be used for monitoring.

Enable Video Motion: Check this box to enable the motion detection feature of your camera.

Sensitivity: Enter a **Sensitivity** value between 0 and 100. Specifies the measurable difference between two sequential images that would indicate motion.

Percentage: Enter a **Percentage** value between 0 and 100. Specifies the amount of motion in the window being monitored that is required to initiate an alert. If this is set to 50%, the window must be halfway filled by a moving object before motion detection is triggered.

Draw Motion Area: To draw the motion detection area, drag your mouse within the *Live Video* window (indicated by the red square).

Erase Motion Area: To erase a motion detection area, simply click on the red square that you want to remove.

Right clicking on the camera image brings up the following menu options:

Select All: Draws a motion detection area over the entire screen.

Clear All: Clears any motion detection areas that have been drawn.

Restore: Restores a previously specified motion detection area.

After making changes, click **Save Settings**.

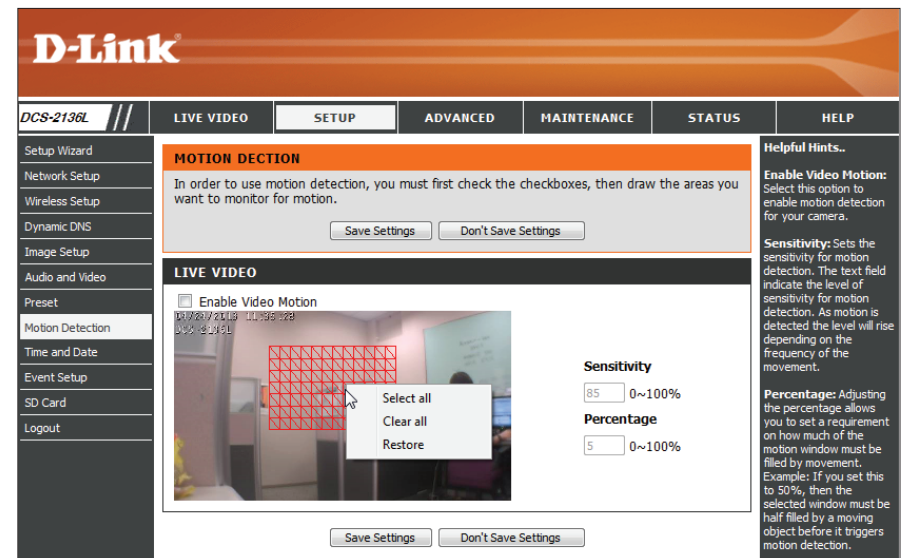
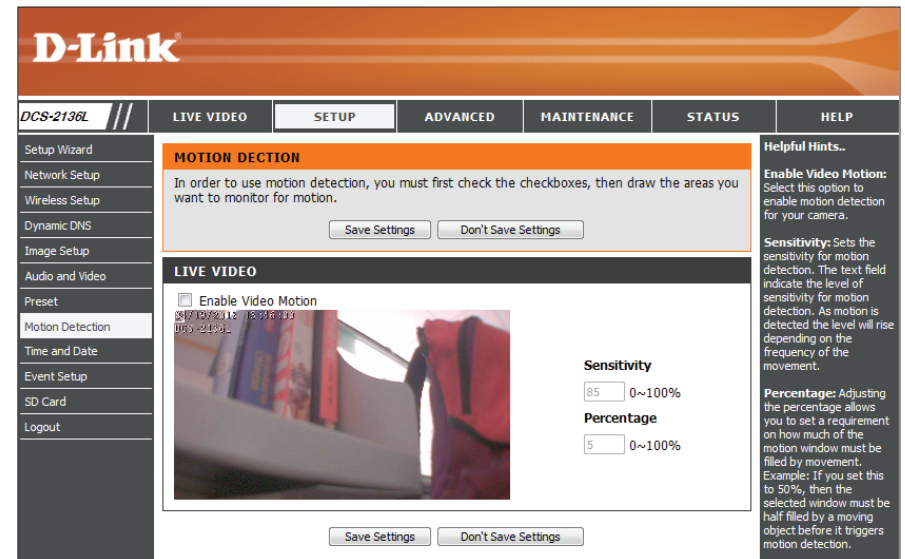

Time and Date

This section allows you to automatically or manually configure, update, and maintain the current time for your camera.

Time Zone: Select your **Time Zone** from the drop-down menu.

Enable Daylight Saving: Check the box to **Enable Daylight Saving Time**.

Auto Daylight Saving: Click to allow your camera to configure Daylight Saving settings automatically.

Set Date and Time Manually: Select this option to configure the Daylight Saving manually. Then set **Start time** and **End time** using drop-down menus for **Month**, **Week**, and **Day of week**. Enter values for **Hour** and **Minutes**.

Offset: Select the amount of time to be added or removed when Daylight Saving is enabled.

Synchronize with NTP Server: Enable this feature to obtain time automatically from an NTP server.

NTP Server: Network Time Protocol (NTP) synchronizes the DCS-2136L with an Internet time server. Choose the one that is closest to your location.

Set the Date and Time Manually: Check this box to **Set the Date and Time Manually**.

Copy Your Computer's Time Settings: Click to synchronize the time zone and Daylight Saving information from your PC.

After making changes, click **Save Settings**.

Helpful Hints..

Good timekeeping is important for accurate logs and scheduled firewall rules.

Time Zone: Select your time zone from the drop-down menu.

Enable Daylight Saving: Select this to enable the daylight saving time.

Auto Daylight Saving: When you select it, the clock is automatically adjusted according to the daylight saving time of the selected time zone.

Offset: Select the time offset, if your location observes daylight saving time.

Synchronize with NTP Server: With the option selected, the camera will synchronize the time settings with the NTP server over the Internet whenever the camera starts up. If the timeserver cannot be reached, no time settings will be applied.

NTP Server: Network Time Protocol (NTP) synchronizes the IP camera with an Internet time server. Choose the one that is closest to your location.

Copy Your Computer's Time Settings: This will synchronize the time information from your PC.

Event Setup

When an event is triggered, a specified action will be performed. As shown in the illustration below, an event can be triggered in various ways. For example, when the camera detects motion, or when an external digital input device like a sensor detects a door opening.

After an event is triggered, either an e-mail notification can be delivered to a specified e-mail address, or images may be uploaded to an FTP server. You can specify whether the DCS-2136L should send snapshots or videos to your e-mail address or FTP site.

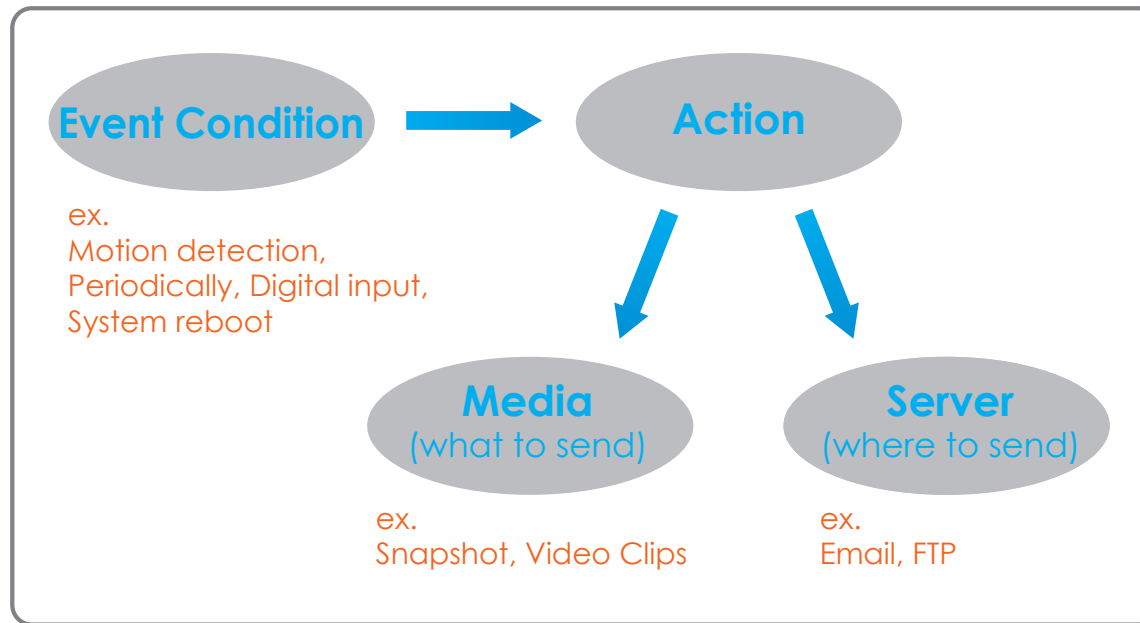

Event Setup instructions begin on the next page.

To set up an **Event**, it is suggested that you start with **Server** and **Media** sections first. Once the **Server** and **Media** are associated with an **Event**, they can not be modified. In order to change the **Server** and **Media**, they must be removed from the **Event**.

The *Event Setup* screen includes four different sections:

- **Server**
- **Media**
- **Event**
- **Recording**

1. To add a new item - **Server, Media, or Event**, click **Add**. A screen will appear and allow you to update the fields accordingly.
2. To remove the selected item from the drop-down menu, click **Delete**.
3. Click on the item from the drop-down menu to open a window for modifying the item.

The screenshot shows the D-Link web interface for the DCS-2136L device. The main navigation bar includes tabs for LIVE VIDEO, SETUP (selected), ADVANCED, MAINTENANCE, STATUS, and HELP. The left sidebar lists various setup options, with 'Event Setup' highlighted. The main content area is titled 'EVENT SETUP' and contains four sections:

- EVENT SETUP**: A text box explaining the sections and providing instructions on how to add and delete items. It states: "There are four sections in Event Setup page. They are event, server, media and recording. Click Add to pop a window to add a new item of event, server, media or recording. Click Delete to delete the selected item from event, server, media or recording. Click on the item name to pop a window to edit it. There can be at most 2 events and 1 recording. There can be at most 5 server and 5 media configurations."
- SERVER**: A table with columns 'Name', 'Type', and 'Address/Location'. It includes an 'Add' button and a 'Delete' button.
- MEDIA**: A table with columns 'Name', 'Type', and 'Source'. It includes an 'Add' button and a 'Delete' button.
- EVENT**: A table with columns 'Name', 'Status', and days of the week (Sun, Mon, Tue, Wed, Thu, Fri, Sat), along with 'Time' and 'Trigger'. It includes an 'Add' button and a 'Delete' button.
- RECORDING**: A table with columns 'Name', 'Status', days of the week (Sun, Mon, Tue, Wed, Thu, Fri, Sat), 'Time', 'Source', and 'Destination'. It includes an 'Add' button and a 'Delete' button.

On the right side, there is a 'Helpful Hints...' section with the following text: "Suggest setting server and media first before setting events. The servers and media which selected in event list are not be able to modify or delete. Please remove them first from the event if you want to delete or modify them. Recommend using different media in different event to make use all media be produced and received correctly. If using the same media in different events and the events trigger almost simultaneously, the servers in the second triggered event will not receive any media; there would be only notifications."

Add Server

You can configure up to five servers to save snapshots and/or video to.

Server Name: Enter the unique name of your server.

E-mail: Enter the configuration for the target **E-mail** server account.

FTP: Enter the configuration for the target **FTP** server account.

Network Storage: Specify a **Network Storage** location. Only one network storage device is supported.

SD Card: Use the camera's onboard SD card storage.

After making changes, click **Save Settings**.

SERVER

You can set at most 5 different servers here for different event.

SERVER TYPE

Server Name:

Email

Sender email address

Recipient email address

Server address

User name

Password

Port

This server requires a secure connection (StartTLS)

FTP

Server address

Port

User name

Password

Remote folder name

Passive mode

Network storage

Network storage location

(for example: \\my_nas\disk\folder)

Workgroup

User name

Password

Primary WINS server

SD Card

Add Media

You can select from three types of media that can be sent when an **Event** is triggered, **Snapshot**, **Video Clip**, and **System Log**.

Media Name: Enter a unique name for *Media Type* you want to create.

Snapshot: Select this option to set the *Media Type* to snapshot.

Source: Set the video profile to use as the media **Source**. Refer to "Audio and Video" on page 38 for more information about video profiles.

Send pre-event image(s) [0~4]: Enter the number of **pre-event images** to take. The pre-event images are images taken before the main event snapshot. You can set up to four pre-event images to be taken.

Send post-event image(s) [0~7]: Enter the number of **post-event images** to take. The post-event images are images taken after the main event snapshot. You can set up to seven post-event images to be taken.

File name prefix: Enter the prefix name to be included in the file name.

Add date and time suffix to file name: Check the box to add date and time information as file name suffix.

Video clip: Select this option to set the *Media Type* to **Video Clip**.

Source: Select the video profile to use as the media **Source**. Refer to "Audio and Video" on page 51 for more information on video profiles.

Pre-event recording: Enter the number of seconds to record before the main event video clip starts. You can record up to four seconds of pre-event video.

Maximum duration: Enter the maximum number of seconds to record for your video clips.

Maximum file size: Set the maximum file size (in Kbytes) for your video clips.

File name prefix: Enter the prefix name that will be included in the filename of saved video clips.

System log: Select this option to set the *Media Type* to **System Log**. This will save the event to the camera's *System Log*, but will not record snapshots or video clips.

After making changes, click **Save Settings**.

The screenshot shows a configuration window titled "MEDIA". At the top, it states "You can set at most 5 different media here for different event." Below this are two buttons: "Save Settings" and "Don't Save Settings". The main section is titled "MEDIA TYPE" and contains three radio button options: "Snapshot", "Video Clip", and "System log".

- Snapshot:** Selected. Includes a "Source" dropdown menu set to "Profile 1", a "Send" input field for "pre-event image(s) [0~4]", a "Send" input field for "post-event image(s) [0~7]", a "File Name Prefix" input field, and a checkbox for "Add date and time suffix to file name".
- Video Clip:** Includes a "Source" dropdown menu set to "Profile 1", a "Pre-event recording" input field for "Second(s) [0~4]", a "Maximum duration" input field for "Second(s) [1~100]", a "Maximum file size" input field for "Kbytes [100~5000]", and a "File Name Prefix" input field.
- System log:** Unselected.

At the bottom of the window are two buttons: "Save Settings" and "Don't Save Settings".

Add Event

You can create and schedule a maximum of two events, each with its own settings.

Event name: Enter a name for the *Event*.

Enable this event: Check this box to **Enable this event**.

Priority: Select the **Priority** for this event. The event with the highest priority will be executed first.

Delay: Enter the number of seconds for the **Delay** time before checking for the next *Event*. This value is used for three types of events - *Video motion detection*, *Digital input*, and *Passive infrared sensor*.

Trigger: Select an input type that triggers the *Event*. Choices are described below.

Video Motion Detection: When motion is detected during live video monitoring. Select the windows that need to be monitored.

Periodic: When an *Event* is triggered in specified intervals. Specify the trigger frequency in minutes.

Digital input: When there is an external trigger input to the camera.

System Boot: When the system boots up, an *Event* is triggered.

Network Lost: When the network connection is lost, an *Event* is triggered.

Passive Infrared Sensor: Triggers an Event when the PIR sensor is activated by moving infrared objects even in dark environment.

EVENT

You can set at most 2 events like motion detection or digital input trigger here and arrange the detection schedule at the same time.

EVENT

Event name:

Enable this event

Priority: ▼

Delay for seconds before detecting next event [For motion detection and digital input and Passive Infrared sensor]

TRIGGER

Video motion detection

Periodic
Trigger every minutes

Digital input

System boot

Network lost

Passive Infrared sensor

Event Schedule: Check the box by the days of the week for scheduling.

Time: Click **Always** or click **From** and enter the time interval as a range.

Trigger D/O: Check the box to trigger the digital output for a specific number of seconds when an event occurs.

Trigger white light LED Check the box to trigger the white light LED. Select **Keep active during an event** or specify the number of seconds to keep active for during an *Event*.

After making changes, click **Save Settings**.

EVENT SCHEDULE

Sun Mon Tue Wed Thu Fri Sat

Time

Always

From To

ACTION

Trigger D/O for seconds

Trigger White light LED

Keep active during event

Keep active for seconds

Active : Inactive :

Add Recording

Here you can configure and schedule the recording settings.

Recording entry name: Enter a unique name for the **Recording entry**.

Enable this recording: Check this box to **Enable recording**.

Priority: Select the **Priority** for this entry. The entry with the highest priority value will be executed first.

Source: Select the **Profile** to be used as a **Source** of the stream.

Recording schedule: Check the box by the days of the week for recording.

Time: Click **Always** or click **From** and enter the time interval as a range.

Destination: Select **None** or select the folder where the video file will be stored.

Total cycling recording size: Enter storage size between 1MB and 2TB for video recordings. New recordings will replace the oldest recording when the total storage size exceeds this value.

Size of each file for recording: If this option is selected, files will be separated based on the file size you enter (in Mbytes).

Time of each file for recording: If this option is selected, files will be separated based on the maximum length of time you specify (in seconds).

File Name Prefix: Enter the prefix name to be included in the file name of the video file(s).

After making changes, click **Save Settings**.

RECORDING

You can setup schedule recording to network storage with your specify week day and time period.

RECORDING

Recording entry name:

Enable this recording

Priority:

Source:

RECORDING SCHEDULE

Sun Mon Tue Wed Thu Fri Sat

Time

Always

From To

RECORDING SETTINGS

Destination:

Total cycling recording size: Mbytes [200~2000000]

Size of each file for recording: Mbytes

Time of each file for recording: seconds

File Name Prefix:

SD Card

Here you may view and manage the recorded files which are stored on the SD card.

Files per page: Select a number from the drop-down menu indicating the number of files to view on this page at one time.

Refresh: Click the link to reload the file and folder information from the SD card.

Delete: Check the box by **Delete**, and then check the box by the name of the file(s) you would like to remove and click **OK**.

View Recorded Picture: If the **Picture** files are stored on the SD card, you can click on the link to the picture file you would like to view.

Playback Recorded Video: If **Video** files are stored on the SD card, you can click on the link to the video file you would like to view.

Format SD Card: Click to automatically format the SD card and create *Picture* and *Video* folders.

The screenshot shows the D-Link web interface for the DCS-2136L camera. The main content area is titled "SD CARD" and contains the following information:

- Header: **SD CARD**
- Text: Here you could browse and manage the record files which stored in SD card.
- Sub-header: **SD CARD**
- SD Card: /
- SD Status: Ready
- Files per Page: 10 (dropdown menu)
- Refresh button
- Page: 1 of 1
- Table of files:

<input type="checkbox"/>	Delete	File	Num of files	Size
<input type="checkbox"/>		Picture	8	
<input type="checkbox"/>		Video	1	
- Format SD Card button
- Total: 119247KB, Used: 31848KB, Free: 87399KB
- OK button

On the right side, there is a "Helpful Hints.." section with the following text:

- Format SD Card:** Click this icon, system will automatically format SD card and create "picture" & "video" folders.
- View recorded picture:** If SD stored recorded picture files, enter picture link and choose which picture file you desire to view. You will view picture via image viewer SW. (ie. Windows Image Viewer)
- Playback recorded video:** If SD stored recorded video files, enter video link and choose which video file you desire to playback. Windows will guide you to open/download video file (AVI format) so that you can playback file via video decoder SW (ie. Windows Media Player)

Advanced Digital Input/Output

This screen allows you to control the behavior of digital input (DI) and digital output (DO) devices. The I/O connector provides the physical interface for DO and DI that is used for connecting a variety of external alarm devices, such as IR-Sensors and alarm relays. The digital input is used for connecting external alarm devices. Once the alarm is triggered, images will be recorded and e-mailed.

Active State for D/I or D/O: The camera will send a signal when an event is triggered, depending upon the type of device connected to the DI circuit.

N.C. stands for *Normal Closed*. This means that the normal state of the circuit is closed. Therefore events are triggered when the device status changes to *Open*.

N.O. stands for *Normal Open*. This means that the normal state of the circuit is open. Therefore events are triggered when the device status changes to *Closed*.

After making any changes, click **Save Settings**.

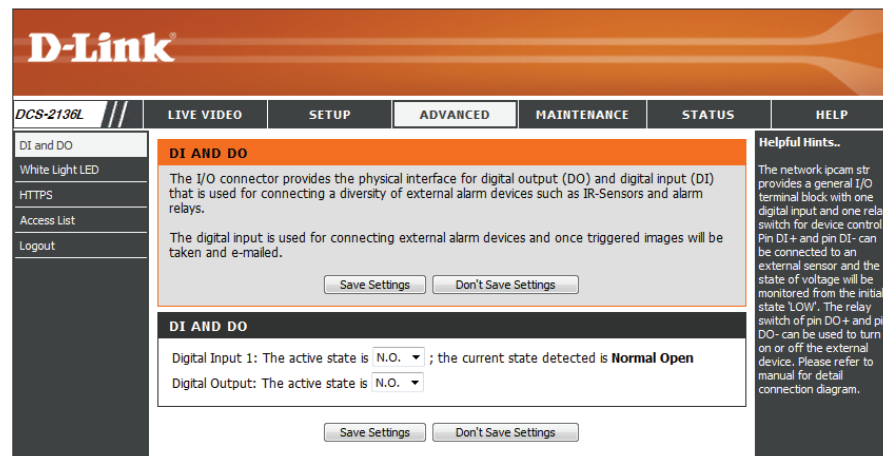

White Light LED

From this screen you can configure the *White Light LED* settings. The settings on this page will control how the light button on the *Live View* page will appear. It will also determine the *White Light LED* functions used with event triggers.

Light: The *White Light LED* can be set according to your preferences. Select from **None**, **Pulse**, **Active**, and **Slider**.

None: If the **Light** option is set to **None**, neither the camera PIR sensor nor any external trigger will activate the *White Light LED*.

Pulse: Select **Pulse** to activate the built-in light for a defined period of time, for example three seconds. You can set how the white light functions by selecting an action for when the *White Light LED* becomes **Active** and goes **Inactive**.

Active: Select **Active** so the *White Light LED* will be activated upon a predefined event, or enable using the button on the *Live View* page. You can set how the white light functions by selecting an action for when the *White Light LED* becomes **Active** and goes **Inactive**.

Slider: Selecting this option will enable a **Slider** on the *Live View* page. The **Slider** will allow you to control the brightness of the built-in light. Moving the **Slider** to the left to dim, and to the right to brighten.

Auto: Selecting this option will enable the *White Light LED* to automatically come on when it senses that the surrounding light levels have reached a certain threshold. Select a **Sensitivity** level of **High**, **Medium**, or **Low**.

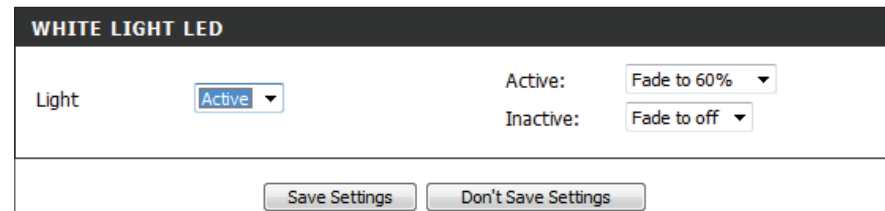
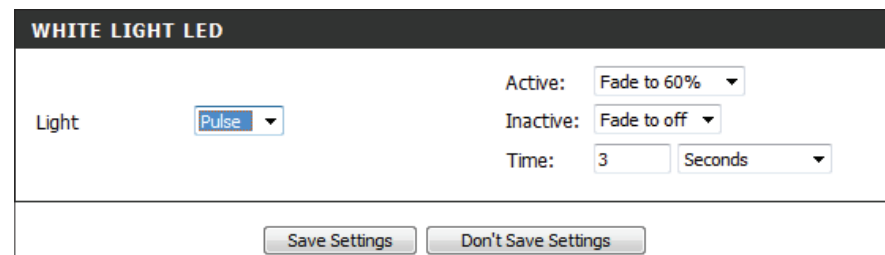
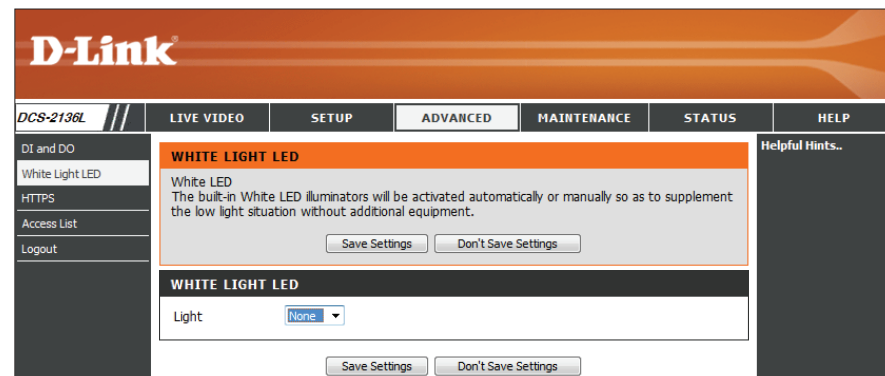

HTTPS

HTTPS (Hypertext Transfer Protocol Secure) is a protocol for secure communication over a computer network. **Enable HTTPS** to ensure there is a secure connection to your camera.

Note: Before you can enable HTTPS, you must create and install a certificate. Certificates are used to verify the identity of a website, allowing HTTPS to provide authentication.

Enable HTTPS Secure Connection: Check the box to **Enable HTTPS**.

Create Certificate Method: Select one of the three methods of certificate creation:
Create a self-signed certificate automatically
Create a self-signed certificate manually
Create a certificate request and install

Create Certificate: Click **Create** to create the certificate.

Certificate Information: Displays the status and details about the origin of the certificate. To remove the certificate, click **Remove***.

***Note:** The certificate cannot be removed while HTTPS is still enabled. To remove the certificate, you must first uncheck **Enable HTTPS secure connection**.

After making any changes, click **Save Settings**.

The screenshot shows the D-Link web interface for the DCS-2136L camera. The main navigation bar includes LIVE VIDEO, SETUP, ADVANCED, MAINTENANCE, STATUS, and HELP. The left sidebar has links for DI and DO, White Light LED, HTTPS, Access List, and Logout. The main content area is titled 'HTTPS' and contains the following text: 'To enable HTTPS, you have to create and install certificate first.' Below this is a 'Save Settings' button and a 'Don't Save Settings' button. The 'Enable HTTPS secure connection' checkbox is checked. Under 'Create certificate method', three radio buttons are shown: 'Create self-signed certificate automatically' (selected), 'Create self-signed certificate manually', and 'Create certificate request and install'. The 'Create certificate:' field shows 'Create' and 'Private key existed'. The 'CERTIFICATE INFORMATION' section lists: Status: Active, Country: TW, State or province: Taiwan, Locality: Taipei, Organization: D-Link Taiwan, Organization Unit: R&D Dept., and Common Name: www.dlink.com.tw. At the bottom of this section are 'CSR Property', 'Certificate Property', and 'Remove' buttons. A final 'Save Settings' and 'Don't Save Settings' button are at the very bottom. A 'Helpful Hints..' sidebar on the right contains a note: 'Enable HTTPS secure connection: allows you to enable HTTPS service. Note: 1. The certificate can't be removed while the HTTPS is still enabled. To remove the certificate you have to uncheck the "Enable HTTPS secure connection" first.'

Access List

From this screen you can set permissions for users to view video from your camera by entering a range of IP addresses for devices with access.

Start IP address: The starting IP address for devices (like a computer) that have access to the video from the camera.

End IP address: The ending IP address for the devices (like a computer) that have access the video from the camera. Click **Add** to save IP addresses to the *Allow List*.

Delete allow list: Remove the specified setting from the *Allow List*.

Start IP address: The starting IP addresses for devices that do not have access to the video from the camera.

End IP address: The ending IP addresses for devices that do not have access to the video from the camera.

Delete deny list: Remove the specified setting from the *Delete List*.

Example:

When the range of the *Allow List* is set from 1.1.1.0 to 192.255.255.255 and the range of the **Deny List** is set from 1.1.1.0 to 170.255.255.255, only users with IP addresses between 171.0.0.0 and 192.255.255.255 can access the DCS-2136L.

Note: A maximum of seven IP address ranges can be specified for both *Allow* and *Deny* lists.

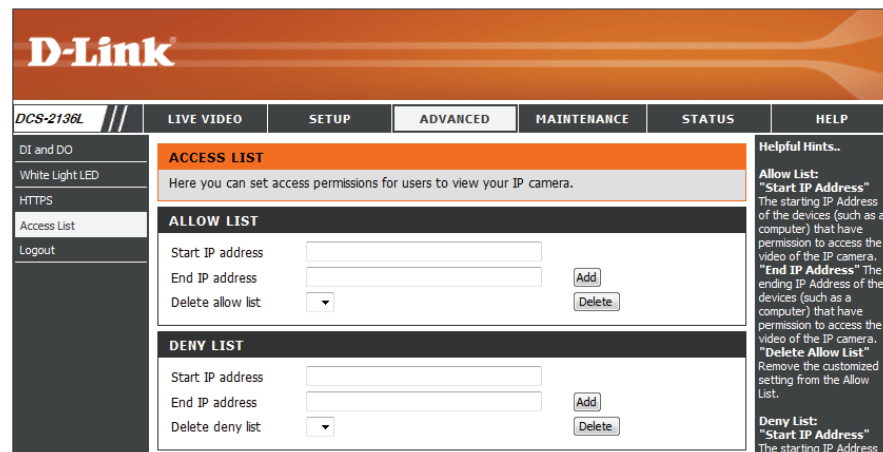

Maintenance

Device Management

You can change the administrator's password for your camera, as well as add and manage the user accounts for accessing the camera. You can also enable the OSD (On-Screen Display) so that you will see the camera name and time when viewing video recordings.

New Password: Enter a new password for the administrator's account and click on **Save**.

User Name: Enter a **User Name** for the new user account.

Password: Enter a **Password** for the new user account, confirm the password and click **Add**.

User Name/ List: Click the arrow to view the drop-down list of user accounts. Click **Delete** to remove the selected user name from the list.

IP Camera Name: Enter a name for your camera that will be included in the file name of camera output.

Enable OSD: Select this option to enable the OSD feature for your camera.

Label: Enter a name for the camera that will be displayed on the video screen when OSD is enabled. Check the box by **Show Time** in order to see both the camera name and the time, and click **Save**.

LED: Select **On** or **Off** to indicate whether or not you want the network status LED on the back of the camera to function, and click **Save**.

The screenshot shows the D-Link maintenance interface for a DCS-2136L camera. The page is titled "D-Link" and has a navigation menu with options: LIVE VIDEO, SETUP, ADVANCED, MAINTENANCE (selected), STATUS, and HELP. The main content area is divided into several sections:

- ADMIN:** A section with a sub-header "ADMIN" and a description: "Here you can change the administrator's password for your IP camera as well as add and/or delete user account(s). You can configure the information, such as IP camera's name and time via this page. You can also enable the OSD (On-Screen Display) feature in order to display the IP camera name and time stamp for your video recordings." Below this is the "ADMIN PASSWORD SETTING" section with fields for "New Password" (63 characters maximum) and "Retype Password" with a "Save" button.
- ADD USER ACCOUNT:** A section with fields for "User Name" (20 users maximum), "New Password" (63 characters maximum), and "Retype Password" with an "Add" button.
- USER LIST:** A section with a "User Name" field containing "-- User list --" and a "Delete" button.
- DEVICE SETTING:** A section with fields for "IP camera Name" (DCS-2136L, 63 characters maximum), "Label" (DCS-2136L, 30 characters maximum), and a "Show time" checkbox. There is also an "Enable OSD" checkbox and a "Save" button.
- LED:** A section with "LED" and radio buttons for "On" and "Off", and a "Save" button.

On the right side of the page, there are "Helpful Hints..":

- Enabling OSD, the IP camera name and time will be displayed on the video screen for the user.
- For security purposes, it is recommended that you change the password for your administrator account. Be sure to write down the new password to avoid having to reset the IP camera in the event that it is forgotten.
- LED: In the near panel of your camera there is a LED beside the network adapter. ON: The LED will flash a light to indicate if the network is working or not. OFF: No light will show, forth option is turn off.

System

From this screen, you may backup, restore the camera configuration, or reboot the camera. Restoring the camera to factory default settings will erase all settings, including any rules that you created.

Save To Local Hard Drive: Click **Save Configuration** to save your current camera configuration as a file on your computer.

Load From Local Hard Drive: Click **Browse** to locate a pre-saved configuration, and then restore the pre-defined settings to your camera by clicking **Load Configuration**.

Restore to Factory Defaults: Clicking **Restore Factory Defaults** will reset your camera's configuration settings back to the settings that were in effect at the time the unit was shipped from the factory. Any settings that have not been saved will be lost. If you want to save the current camera configuration settings, use the **Save Configuration** button above.

Reboot Device: Click **Reboot Device** to restart your camera.

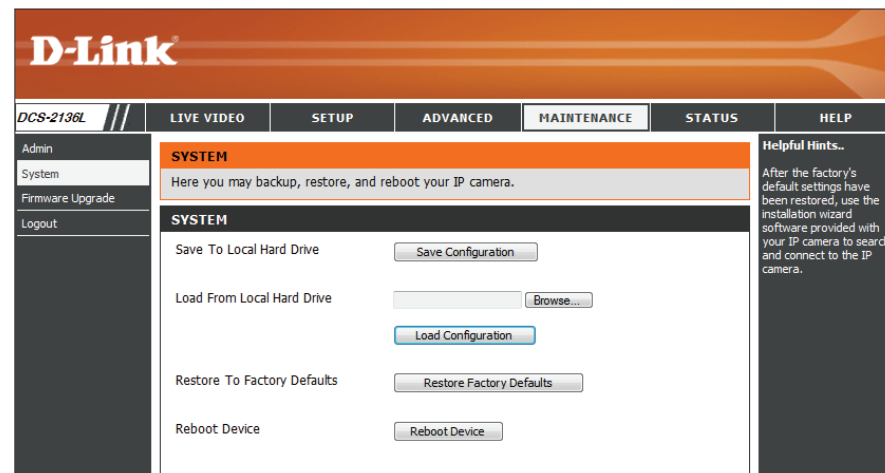

Firmware Upgrade

You can upgrade your camera's firmware from this screen. Click on the link to the **D-Link Support Page** to check for the latest available firmware.

To upgrade the firmware on your DCS-2136L, download and save the latest firmware version to your local hard drive. Locate the file on your local hard drive by clicking the **Browse** button. Select the file and click the **Upload** button to complete the firmware upgrade.

Current Firmware Version: Displays the *Current Firmware Version* that is detected on your camera.

Current Product Name: Displays your camera's model name.

File Path: Click the **Browse** button to locate and open the file on your hard drive that contains the updated firmware.

Upload: Click **Upload** to complete the firmware upgrade for your camera.

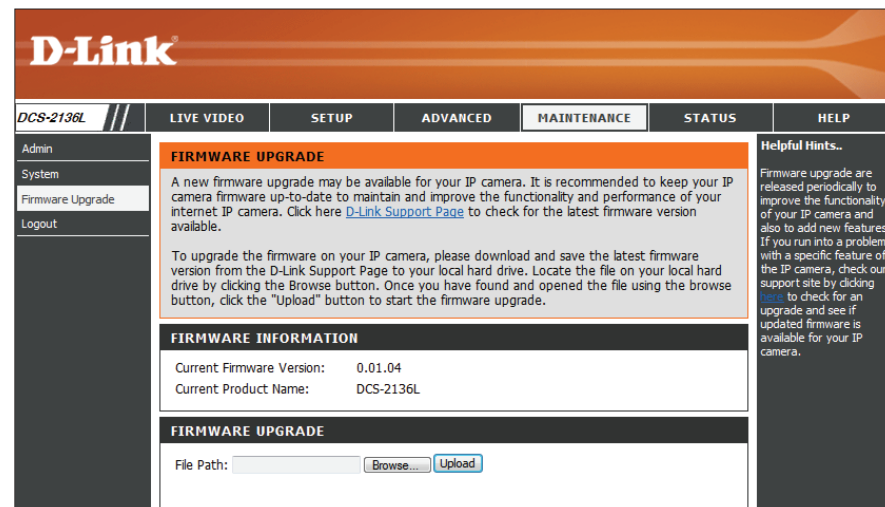

Status

Device Info

This page displays detailed information about your IP camera and network settings.

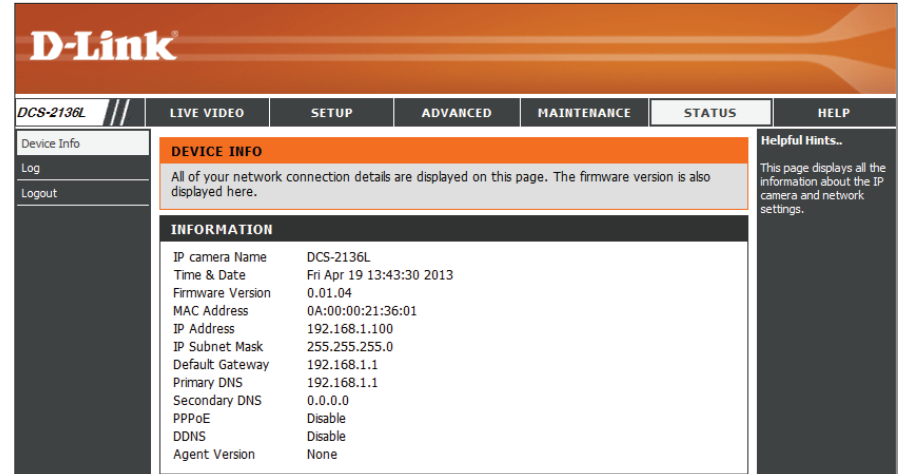

The screenshot shows the D-Link web interface for the DCS-2136L camera. The top navigation bar includes 'LIVE VIDEO', 'SETUP', 'ADVANCED', 'MAINTENANCE', 'STATUS', and 'HELP'. The 'STATUS' tab is selected, and the 'DEVICE INFO' sub-tab is active. The main content area is divided into three sections: a header, a descriptive paragraph, and a table of information.

INFORMATION	
IP camera Name	DCS-2136L
Time & Date	Fri Apr 19 13:43:30 2013
Firmware Version	0.01.04
MAC Address	0A:00:00:21:36:01
IP Address	192.168.1.100
IP Subnet Mask	255.255.255.0
Default Gateway	192.168.1.1
Primary DNS	192.168.1.1
Secondary DNS	0.0.0.0
PPPoE	Disable
DDNS	Disable
Agent Version	None

Logs

This page displays the *Current Log* of IP camera events. You may download the log by clicking **Download**. You may also click **Clear** to delete the log information.

D-Link

DCS-2136L // LIVE VIDEO SETUP ADVANCED MAINTENANCE STATUS HELP

Device Info
Log
Logout

SYSTEM LOG
The system log records IP camera events that have occurred.

CURRENT LOG

1. 2013-04-19 13:42:44 admin LOGIN OK FROM 192.168.1.2
2. 2013-04-19 11:04:08 admin LOGIN OK FROM 192.168.1.2
3. 2013-04-18 16:18:24 admin FROM 192.168.1.2 SET VIDEO CODEC Need Reset
4. 2013-04-18 16:18:24 admin FROM 192.168.1.2 SET PROFILE 1 Viewer window area 640x360
5. 2013-04-18 16:18:24 admin FROM 192.168.1.2 SET PROFILE 1 Frame Size 640x360
6. 2013-04-18 16:17:30 admin LOGIN OK FROM 192.168.1.2
7. 2013-04-18 15:38:06 IP CAMERA ACQUIRE DHCP IP 192.168.1.100
8. 2013-04-18 15:38:04 NETWORK RECONNECT
9. 2013-04-18 14:32:44 NETWORK LOSS
10. 2013-04-15 17:02:29 IP CAMERA ACQUIRE DHCP IP 192.168.1.100
11. 2013-04-15 17:02:27 SYSTEM SET IR LIGHT OFF
12. 2013-04-15 17:02:25 SYSTEM BOOTING
13. 2013-04-15 14:07:04 IP CAMERA ACQUIRE DHCP IP 192.168.1.100
14. 2013-04-15 14:07:00 NETWORK RECONNECT
15. 2013-04-15 14:06:59 SYSTEM SET IR LIGHT OFF
16. 2013-04-15 14:06:59 NETWORK LOSS
17. 2013-04-15 14:06:58 SYSTEM BOOTING
18. 2013-04-15 13:55:57 NETWORK LOSS
19. 2013-04-14 21:53:52 IP CAMERA ACQUIRE DHCP IP 192.168.1.100
20. 2013-04-14 21:53:35 NETWORK RECONNECT

First Page Previous 20 Next 20
Clear Download

Helpful Hints..
You can save the log to your local hard IP camera by clicking the Download button, and you can clear the log by clicking on the Clear button.

Support

This page provides links to helpful information regarding camera setup and operation.

The screenshot displays the D-Link DCS-2136L web interface. At the top, the D-Link logo is visible. Below it, a navigation bar contains the following tabs: LIVE VIDEO, SETUP, ADVANCED, MAINTENANCE, STATUS, and HELP. The HELP tab is currently selected. On the left side, there is a sidebar with 'Help' and 'Logout' links. The main content area is divided into several sections, each with a header and a list of links:

- HELP**
 - [LIVE VIDEO](#)
 - [SETUP](#)
 - [MAINTENANCE](#)
 - [ADVANCED](#)
 - [STATUS](#)
- LIVE VIDEO**
 - [Camera](#)
- SETUP**
 - [Setup Wizard](#)
 - [Network Setup](#)
 - [Wireless Setup](#)
 - [Dynamic DNS](#)
 - [Image Setup](#)
 - [Audio and Video](#)
 - [Preset](#)
 - [Motion Detection](#)
 - [Time and Date](#)
 - [Event Setup](#)
 - [SD Card](#)
- ADVANCED**
 - [DI and DO](#)
 - [ICR and White LED](#)
 - [HTTPS](#)
 - [Access List](#)
- MAINTENANCE**
 - [Admin](#)
 - [System](#)
 - [Firmware Upgrade](#)
- STATUS**
 - [Device Info](#)
 - [Log](#)

Troubleshooting

1. What can I do if I forget my password?

If you forget your password, you must reset your camera. Unfortunately, this will change your settings back to the factory defaults.

To reset your camera, use an unfolded paperclip to press and hold the **RESET** button for at least three seconds while your camera is plugged in.



2. Why does the LED not light up?

The power supply might be faulty. Confirm that you are using the provided DC 5V power supply for this camera. Verify that the power supply is correctly connected. If the camera is functioning normally, the LED may have been disabled. See "[Motion Detection Setup Wizard](#)" on page 29 for information about how to enable the LED.

3. Why does a series of broad vertical white lines appear through out the image?

It could be that the image sensor has become overloaded when it has been exposed to bright light such as direct exposure to sunlight or halogen lights. Reposition the camera into a more shaded area immediately, as prolonged exposure to bright lights will damage the sensor.

4. Why are no images available through the Web browser?

ActiveX might be disabled. If you are viewing the images from Internet Explorer make sure ActiveX has been enabled in the Internet Options menu. You may also need to change the security settings on your browser to allow the ActiveX plug-in to be installed.

If you are using Internet Explorer with a version number lower than 6, then you will need to upgrade your Web browser software in order to view the streaming video transmitted by the Network Camera.

Note: for more information, go to www.mydlink.com and click on **FAQs** in the top right corner. Click on the **Camera** tab and then click on DCS-2136L.

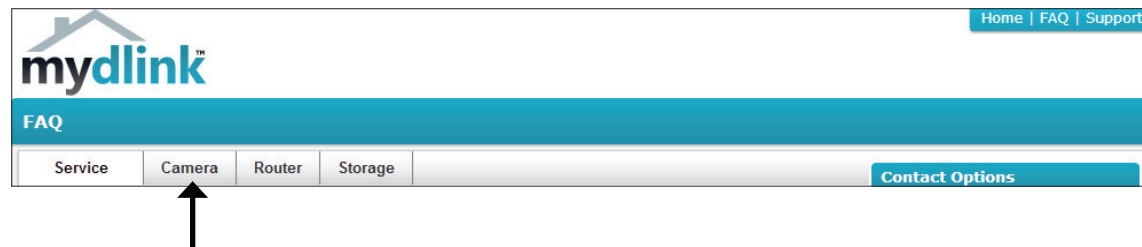

DI/DO Specifications

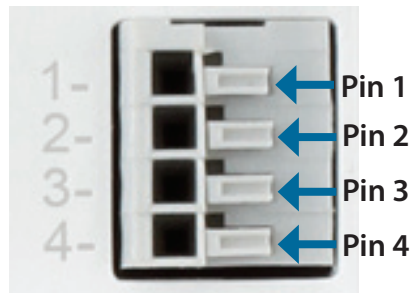

PIN	FUNCTION	NOTE
1	Digital Out (DO)	Uses an open-drain NFET transistor with the source connected to GND in camera. If used with an external relay, a diode must be connected in parallel with the load for protection against voltage transients. Max loading is 100 mA.
2	Digital In (DI)	A switch from DI to DC 5 V, activated by setting NO. or NC.
3	DC5V OUTPUT	DC 5 V Output / Max. 100 mA
4	GND	GND

Internal 5V Power

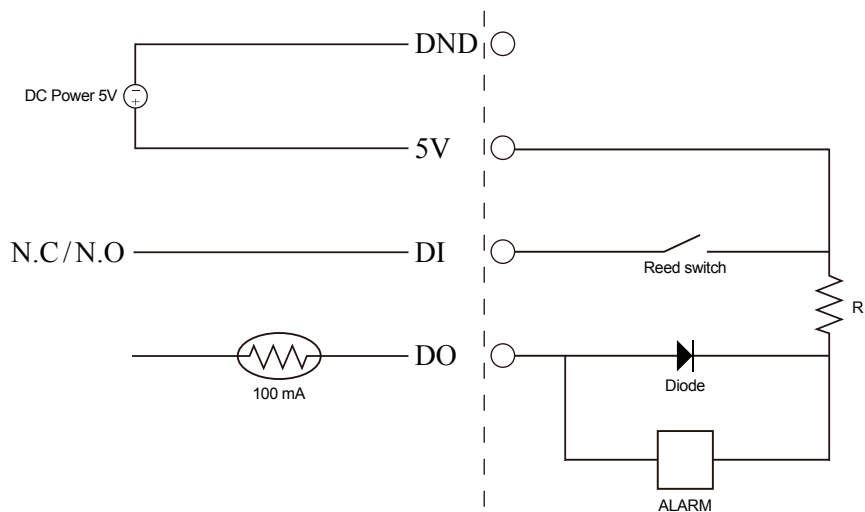

External 3~12V Power

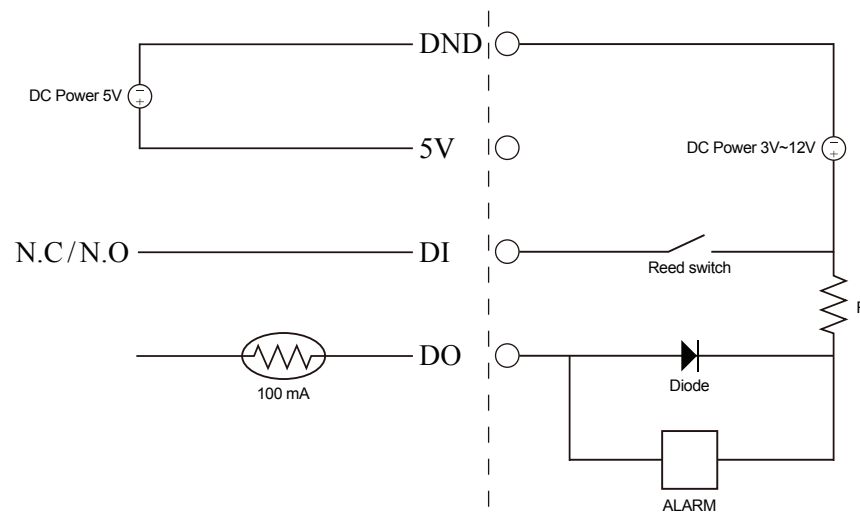

Technical Specifications

SYSTEM REQUIREMENTS FOR WEB INTERFACE/MYDLINK

- Microsoft Windows® 8/7/Vista®/XP, or Mac with OS X 10.5 or higher
- Internet Explorer 7 (Active X), Firefox 12, Safari 4, or Chrome 20 or higher version with Java installed and enabled
- Broadband Internet Connection

CAMERA HARDWARE PROFILE

- 1/3" Megapixel Progressive CMOS Sensor
- 16 ft. White Light Illumination Distance
- Minimum Illumination: 0 lux with White Light LED On
- Built-in PIR Sensor (16 ft.)
- Built-in Microphone and Speaker
- 10x Digital Zoom
- Focal Length: 3.6 mm
- Aperture: F1.4
- Angle of View:
 - (H) 64°
 - (V) 46.5°
 - (D) 92.4°

IMAGE FEATURES

- Configurable Image Size, Quality, Frame Rate and Bit Rate
- Time Stamp and Text Overlays
- Configurable Motion Detection Windows
- Configurable Privacy Mask Zones
- Configurable Shutter Speed, Brightness, Saturation, Contrast, Sharpness, and WDR

NETWORKING PROTOCOLS

- IPv6
- Ipv4
- TCP/IP
- UDP
- ICMP
- DHCP Client
- NTP Client (D-Link)
- DNS Client
- DDNS Client (D-Link)
- SMTP Client
- FTP Client

- HTTP/HTTPS
- Samba Client
- PPPoE
- UPnP Port Forwarding
- RTP/RTSP/RTCP
- IP Filtering
- QoS
- CoS
- Multicast
- IGMP
- SNMP
- ONVIF compliant

EXTERNAL DEVICE INTERFACE

- 10/100 BASE-TX Fast Ethernet Port
- IEEE 802.11ac 2.4GHz, 5GHz Dual-Band Wireless
- DI/DO Port
- MicroSD/SDHC Card Slot

SECURITY

- Administrator and User Group Protection
- Password Authentication
- HTTP and RTSP Digest Encryption

REMOTE MANAGEMENT

- Take Snapshots and Video Clips and Save to Local Hard Drive or NAS using a Web Browser
- Configuration Interface Accessible via Web Browser

EVENT MANAGEMENT

- Motion Detection
- Event Notification and Uploading of Snapshots/Video Clips via e-mail or FTP
- Supports Multiple SMTP and FTP Servers
- Multiple Event Notifications
- Multiple Recording Methods for Easy Backup

MOBILE SUPPORT

- mylink Mobile App for iOS and Android Mobile Devices

AUDIO SUPPORT

- AAC
- G.711

VIDEO COMPRESSION

- Simultaneous H.264/MPEG-4/MJPEG Format Compression
- H264/MJPEG-4 Multicast Streaming
- JPEG for Still Images

VIDEO RESOLUTION

- 16:9 - 1280 x 720, 800 x 450, 640 x 360, 480 x 270, 320 x 176, 176 x 144 at up to 30 fps
- 4:3 - 1024 x 768, 800 x 600, 640 x 480, 480 x 360, 320 x 240, 176 x 144 at up to 30 fps

WEIGHT

- Device (Without Stand) 2.96 oz (84.0 g)
- Stand 1.58 oz (45.0 g)

OPERATING TEMPERATURE

- 32° to 104° F (0° to 40° C)

STORAGE TEMPERATURE

- - 4° to 158° F (-20° to 70° C)

HUMIDITY

- 20% to 80% RH non-condensing

EXTERNAL POWER ADAPTER

- Input: 100 to 240 V AC, 50/60 Hz
- Output: 5 V DC, 1.2A, 50/60 Hz

POWER CONSUMPTION

- 4 Watts

CERTIFICATIONS

- CE
- CE LVD
- FCC
- C-Tick

Dimensions

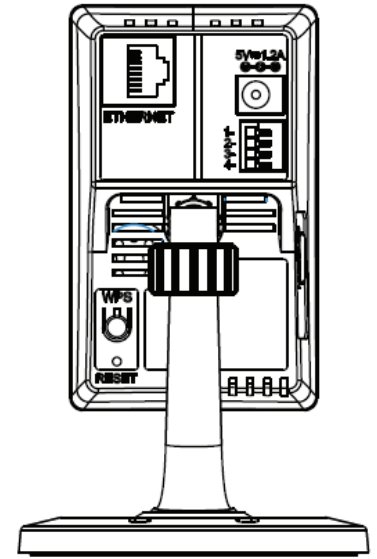
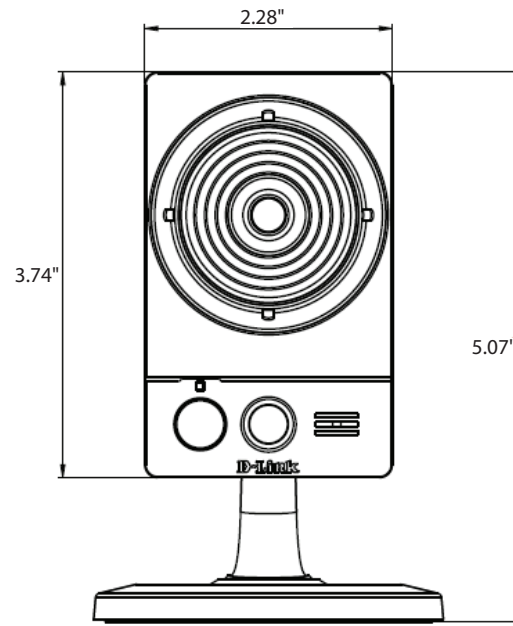
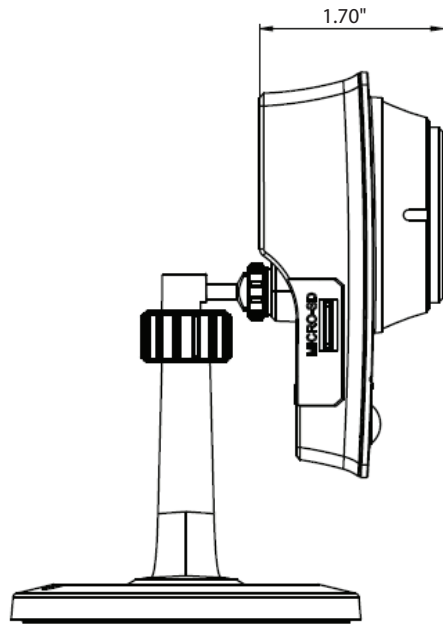

Contacting Technical Support

U.S. and Canadian customers can contact D-Link technical support through our web site or by phone.

Before you contact technical support, please have the following ready:

- Model number of the product (e.g. DCS-2136L)
- Hardware Revision (located on the label on the bottom of the Network Camera (e.g. rev A1))
- Serial Number (s/n number located on the label on the bottom of the camera).

You can find software updates and user documentation on the D-Link website as well as frequently asked questions and answers to technical issues.

For customers within the United States:

Phone Support:

(877) 453-5465

Internet Support:

<http://support.dlink.com>

For customers within Canada:

Phone Support:

(800) 361-5265

Internet Support:

<http://support.dlink.ca>

Warranty

Subject to the terms and conditions set forth herein, D-Link Systems, Inc. (“D-Link”) provides this Limited Warranty:

- Only to the person or entity that originally purchased the product from D-Link or its authorized reseller or distributor, and
- Only for products purchased and delivered within the fifty states of the United States, the District of Columbia, U.S. Possessions or Protectorates, U.S. Military Installations, or addresses with an APO or FPO.

Limited Warranty:

D-Link warrants that the hardware portion of the D-Link product described below (“Hardware”) will be free from material defects in workmanship and materials under normal use from the date of original retail purchase of the product, for the period set forth below (“Warranty Period”), except as otherwise stated herein.

- Hardware (excluding power supplies and fans): One (1) year
- Power supplies and fans: One (1) year
- Spare parts and spare kits: Ninety (90) days

The customer’s sole and exclusive remedy and the entire liability of D-Link and its suppliers under this Limited Warranty will be, at D-Link’s option, to repair or replace the defective Hardware during the Warranty Period at no charge to the original owner or to refund the actual purchase price paid. Any repair or replacement will be rendered by D-Link at an Authorized D-Link Service Office. The replacement hardware need not be new or have an identical make, model or part. D-Link may, at its option, replace the defective Hardware or any part thereof with any reconditioned product that D-Link reasonably determines is substantially equivalent (or superior) in all material respects to the defective Hardware. Repaired or replacement hardware will be warranted for the remainder of the original Warranty Period or ninety (90) days, whichever is longer, and is subject to the same limitations and exclusions. If a material defect is incapable of correction, or if D-Link determines that it is not practical to repair or replace the defective Hardware, the actual price paid by the original purchaser for the defective Hardware will be refunded by D-Link upon return to D-Link of the defective Hardware. All Hardware or part thereof that is replaced by D-Link, or for which the purchase price is refunded, shall become the property of D-Link upon replacement or refund.

Limited Software Warranty:

D-Link warrants that the software portion of the product (“Software”) will substantially conform to D-Link’s then current functional specifications for the Software, as set forth in the applicable documentation, from the date of original retail purchase of the Software for a period of ninety (90) days (“Software Warranty Period”), provided that the Software is properly installed on approved hardware and operated as contemplated in its documentation. D-Link further warrants that, during the Software Warranty Period, the magnetic media on which D-Link delivers the Software will be free of physical defects. The customer’s sole and exclusive remedy and the entire liability of D-Link and its suppliers under this Limited Warranty will be, at D-Link’s option, to replace the non-conforming Software (or defective media) with software that substantially conforms to D-Link’s functional specifications for the Software or to refund the portion of the actual purchase price paid that is attributable to the Software. Except as otherwise agreed by DLink in writing, the replacement Software is provided only to the original licensee, and is subject to the terms and conditions of the license granted by D-Link for the Software. Replacement Software will be warranted for the remainder of the original Warranty Period and is subject to the same limitations and exclusions. If a material non-conformance is incapable of correction, or if D-Link determines in its sole discretion that it is not practical to replace the non-conforming Software, the price paid by the original licensee for the non-conforming Software will be refunded by D-Link; provided that the non-conforming Software (and all copies thereof) is first returned to D-Link. The license granted respecting any Software for which a refund is given automatically terminates.

Non-Applicability of Warranty:

The Limited Warranty provided hereunder for Hardware and Software portions of D-Link’s products will not be applied to and does not cover any refurbished product and any product purchased through the inventory clearance or liquidation sale or other sales in which D-Link, the sellers, or the liquidators expressly disclaim their warranty obligation pertaining to the product and in that case, the product is being sold “As-Is” without any warranty whatsoever including, without limitation, the Limited Warranty as described herein, notwithstanding anything stated herein to the contrary.

Submitting A Claim (USA):

The customer shall return the product to the original purchase point based on its return policy. In case the return policy period has expired and the product is within warranty, the customer shall submit a claim to D-Link as outlined below:

- The customer must submit with the product as part of the claim a written description of the Hardware defect or Software nonconformance in sufficient detail to allow DLink to confirm the same, along with proof of purchase of the product (such as a copy of the dated purchase invoice for the product) if the product is not registered.
- The customer must obtain a Case ID Number from D-Link Technical Support at 1-877-354-6555, who will attempt to assist the customer in resolving any suspected defects with the product. If the product is considered defective, the customer must obtain a Return Material Authorization (“RMA”) number by completing the RMA form and entering the assigned Case ID Number at <https://rma.dlink.com/>.

- After an RMA number is issued, the defective product must be packaged securely in the original or other suitable shipping package to ensure that it will not be damaged in transit, and the RMA number must be prominently marked on the outside of the package. Do not include any manuals or accessories in the shipping package. DLink will only replace the defective portion of the product and will not ship back any accessories.
- The customer is responsible for all in-bound shipping charges to D-Link. No Cash on Delivery (“COD”) is allowed. Products sent COD will either be rejected by D-Link or become the property of D-Link. Products shall be fully insured by the customer and shipped to D-Link Systems, Inc., 17595 Mt. Herrmann, Fountain Valley, CA 92708. D-Link will not be held responsible for any packages that are lost in transit to D-Link. The repaired or replaced packages will be shipped to the customer via UPS Ground or any common carrier selected by D-Link. Return shipping charges shall be prepaid by D-Link if you use an address in the United States, otherwise we will ship the product to you freight collect. Expedited shipping is available upon request and provided shipping charges are prepaid by the customer. D-Link may reject or return any product that is not packaged and shipped in strict compliance with the foregoing requirements, or for which an RMA number is not visible from the outside of the package. The product owner agrees to pay D-Link’s reasonable handling and return shipping charges for any product that is not packaged and shipped in accordance with the foregoing requirements, or that is determined by D-Link not to be defective or non-conforming.

Submitting A Claim (Canada):

The customer shall return the product to the original purchase point based on its return policy. In case the return policy period has expired and the product is within warranty, the customer shall submit a claim to D-Link as outlined below:

- Customers need to provide their receipt (proof of purchase) even if the product is registered. Without a receipt, no warranty service will be done. The registration is not considered a proof of purchase.
- The customer must submit with the product as part of the claim a written description of the Hardware defect or Software nonconformance in sufficient detail to allow D-Link to confirm the same, along with proof of purchase of the product (such as a copy of the dated purchase invoice for the product) if the product is not registered.
- The customer must obtain a Case ID Number from D-Link Technical Support at 1-800-361-5265, who will attempt to assist the customer in resolving any suspected defects with the product. If the product is considered defective, the customer must obtain a Return Material Authorization (“RMA”) number by completing the RMA form and entering the assigned Case ID Number at <https://rma.dlink.ca/>.
- After an RMA number is issued, the defective product must be packaged securely in the original or other suitable shipping package to ensure that it will not be damaged in transit, and the RMA number must be prominently marked on the outside of the package. Do not include any manuals or accessories in the shipping package. D-Link will only replace the defective portion of the product and will not ship back any accessories.

- The customer is responsible for all in-bound shipping charges to D-Link. No Cash on Delivery (“COD”) is allowed. Products sent COD will be rejected by D-Link. Products shall be fully insured by the customer and shipped to D-Link Networks, Inc., 2525 Meadowvale Boulevard Mississauga, Ontario, L5N 5S2 Canada. D-Link will not be held responsible for any packages that are lost in transit to D-Link. The repaired or replaced packages will be shipped to the customer via Purolator Canada or any common carrier selected by D-Link. Return shipping charges shall be prepaid by D-Link if you use an address in Canada, otherwise we will ship the product to you freight collect. Expedited shipping is available upon request and provided shipping charges are prepaid by the customer. D-Link may reject or return any product that is not packaged and shipped in strict compliance with the foregoing requirements, or for which an RMA number is not visible from the outside of the package. The product owner agrees to pay D-Link’s reasonable handling and return shipping charges for any product that is not packaged and shipped in accordance with the foregoing requirements, or that is determined by D-Link not to be defective or non-conforming.
- RMA phone number: 1-800-361-5265 Hours of Operation: Monday-Friday, 9:00AM – 9:00PM EST

What Is Not Covered:

The Limited Warranty provided herein by D-Link does not cover:

Products that, in D-Link’s judgment, have been subjected to abuse, accident, alteration, modification, tampering, negligence, misuse, faulty installation, lack of reasonable care, repair or service in any way that is not contemplated in the documentation for the product, or if the model or serial number has been altered, tampered with, defaced or removed; Initial installation, installation and removal of the product for repair, and shipping costs; Operational adjustments covered in the operating manual for the product, and normal maintenance; Damage that occurs in shipment, due to act of God, failures due to power surge, and cosmetic damage; Any hardware, software, firmware or other products or services provided by anyone other than D-Link; and Products that have been purchased from inventory clearance or liquidation sales or other sales in which D-Link, the sellers, or the liquidators expressly disclaim their warranty obligation pertaining to the product.

While necessary maintenance or repairs on your Product can be performed by any company, we recommend that you use only an Authorized D-Link Service Office. Improper or incorrectly performed maintenance or repair voids this Limited Warranty.

Disclaimer of Other Warranties:

EXCEPT FOR THE LIMITED WARRANTY SPECIFIED HEREIN, THE PRODUCT IS PROVIDED “AS-IS” WITHOUT ANY WARRANTY OF ANY KIND WHATSOEVER INCLUDING, WITHOUT LIMITATION, ANY WARRANTY OF MERCHANTABILITY, FITNESS FOR A PARTICULAR PURPOSE AND NONINFRINGEMENT.

IF ANY IMPLIED WARRANTY CANNOT BE DISCLAIMED IN ANY TERRITORY WHERE A PRODUCT IS SOLD, THE DURATION OF SUCH IMPLIED WARRANTY SHALL BE LIMITED TO THE DURATION OF THE APPLICABLE WARRANTY PERIOD SET FORTH ABOVE. EXCEPT AS EXPRESSLY COVERED UNDER THE LIMITED WARRANTY PROVIDED HEREIN, THE ENTIRE RISK AS TO THE QUALITY, SELECTION AND PERFORMANCE OF THE PRODUCT IS WITH THE PURCHASER OF THE PRODUCT.

Limitation of Liability:

TO THE MAXIMUM EXTENT PERMITTED BY LAW, D-LINK IS NOT LIABLE UNDER ANY CONTRACT, NEGLIGENCE, STRICT LIABILITY OR OTHER LEGAL OR EQUITABLE THEORY FOR ANY LOSS OF USE OF THE PRODUCT, INCONVENIENCE OR DAMAGES OF ANY CHARACTER, WHETHER DIRECT, SPECIAL, INCIDENTAL OR CONSEQUENTIAL (INCLUDING, BUT NOT LIMITED TO, DAMAGES FOR LOSS OF GOODWILL, LOSS OF REVENUE OR PROFIT, WORK STOPPAGE, COMPUTER FAILURE OR MALFUNCTION, FAILURE OF OTHER EQUIPMENT OR COMPUTER PROGRAMS TO WHICH D-LINK'S PRODUCT IS CONNECTED WITH, LOSS OF INFORMATION OR DATA CONTAINED IN, STORED ON, OR INTEGRATED WITH ANY PRODUCT RETURNED TO D-LINK FOR WARRANTY SERVICE) RESULTING FROM THE USE OF THE PRODUCT, RELATING TO WARRANTY SERVICE, OR ARISING OUT OF ANY BREACH OF THIS LIMITED WARRANTY, EVEN IF D-LINK HAS BEEN ADVISED OF THE POSSIBILITY OF SUCH DAMAGES. THE SOLE REMEDY FOR A BREACH OF THE FOREGOING LIMITED WARRANTY IS REPAIR, REPLACEMENT OR REFUND OF THE DEFECTIVE OR NONCONFORMING PRODUCT. THE MAXIMUM LIABILITY OF D-LINK UNDER THIS WARRANTY IS LIMITED TO THE PURCHASE PRICE OF THE PRODUCT COVERED BY THE WARRANTY. THE FOREGOING EXPRESS WRITTEN WARRANTIES AND REMEDIES ARE EXCLUSIVE AND ARE IN LIEU OF ANY OTHER WARRANTIES OR REMEDIES, EXPRESS, IMPLIED OR STATUTORY.

Governing Law:

This Limited Warranty shall be governed by the laws of the State of California. Some states do not allow exclusion or limitation of incidental or consequential damages, or limitations on how long an implied warranty lasts, so the foregoing limitations and exclusions may not apply. This Limited Warranty provides specific legal rights and you may also have other rights which vary from state to state.

Trademarks:

D-Link is a registered trademark of D-Link Corporation/D-Link Systems, Inc. Other trademarks or registered trademarks are the property of their respective owners.

Copyright Statement:

No part of this publication or documentation accompanying this product may be reproduced in any form or by any means or used to make any derivative such as translation, transformation, or adaptation without permission from D-Link Corporation/D-Link Systems, Inc., as stipulated by the United States Copyright Act of 1976 and any amendments thereto. Contents are subject to change without prior notice.

Copyright ©2013 by D-Link Corporation/D-Link Systems, Inc. All rights reserved.

CE Mark Warning:

This is a Class B product. In a domestic environment, this product may cause radio interference, in which case the user may be required to take adequate measures.

FCC Statement:

This equipment has been tested and found to comply with the limits for a Class B digital device, pursuant to part 15 of the FCC Rules. These limits are designed to provide reasonable protection against harmful interference in a residential installation. This equipment generates, uses, and can radiate radio frequency energy and, if not installed and used in accordance with the instructions, may cause harmful interference to radio communication. However, there is no guarantee that interference will not occur in a particular installation. If this equipment does cause harmful interference to radio or television reception, which can be determined by turning the equipment off and on, the user is encouraged to try to correct the interference by one or more of the following measures:

- Reorient or relocate the receiving antenna.
- Increase the separation between the equipment and receiver.
- Connect the equipment into an outlet on a circuit different from that to which the receiver is connected.
- Consult the dealer or an experienced radio/TV technician for help.

FCC Caution:

Any changes or modifications not expressly approved by the party responsible for compliance could void the user's authority to operate this equipment.

This device complies with Part 15 of the FCC Rules. Operation is subject to the following two conditions:

- (1) This device may not cause harmful interference, and
- (2) this device must accept any interference received, including interference that may cause undesired operation.

If this device is going to be operated in 5.15 ~ 5.25GHz frequency range, then it is restricted in indoor environment only.

IMPORTANT NOTICE:

FCC Radiation Exposure Statement:

This equipment complies with FCC radiation exposure limits set forth for an uncontrolled environment. This equipment should be installed and operated with minimum distance 20cm between the radiator & your body. This transmitter must not be co-located or operating in conjunction with any other antenna or transmitter.

The availability of some specific channels and/or operational frequency bands are country dependent and are firmware programmed at the factory to match the intended destination. The firmware setting is not accessible by the end user.

For detailed warranty information applicable to products purchased outside the United States, please contact the corresponding local D-Link office.

Industry Canada Statement:

This device complies with RSS-210 of the Industry Canada Rules. Operation is subject to the following two conditions:

- (1) This device may not cause harmful interference, and
- (2) this device must accept any interference received, including interference that may cause undesired operation.

IMPORTANT NOTE:

Radiation Exposure Statement:

This equipment complies with Canada radiation exposure limits set forth for an uncontrolled environment. This equipment should be installed and operated with minimum distance 20cm between the radiator and your body.

This device has been designed to operate with an antenna having a maximum gain of 2 dB. Antenna having a higher gain is strictly prohibited per regulations of Industry Canada. The required antenna impedance is 50 ohms.

Registration

Register your product online at registration.dlink.com



Product registration is entirely voluntary and failure to complete or return this form will not diminish your warranty rights.

Version 1.0
September 27, 2013

Free Manuals Download Website

<http://myh66.com>

<http://usermanuals.us>

<http://www.somanuals.com>

<http://www.4manuals.cc>

<http://www.manual-lib.com>

<http://www.404manual.com>

<http://www.luxmanual.com>

<http://aubethermostatmanual.com>

Golf course search by state

<http://golfingnear.com>

Email search by domain

<http://emailbydomain.com>

Auto manuals search

<http://auto.somanuals.com>

TV manuals search

<http://tv.somanuals.com>