

D-Link™ DGS-1016D

DGS-1024D

16/24-Port 10/100/1000Mbps

Gigabit Ethernet Switch

Manual

D-Link®
Building Networks for People



RECYCLABLE
(November 2005)
P/N: 6DGS1024D.02G

Information in this document is subject to change without notice.

© 2005 D-Link Computer Corporation. All rights reserved.

Reproduction in any manner whatsoever without the written permission of D-Link Computer Corporation is strictly forbidden.

Trademarks used in this text: *D-Link* and the *D-LINK* logo are trademarks of DLink Computer Corporation; *Microsoft* and *Windows* are registered trademarks of Microsoft Corporation.

Other trademarks and trade names may be used in this document to refer to either the entities claiming the marks and names or their products. D-Link Computer Corporation disclaims any proprietary interest in trademarks and trade names other than its own.

FCC Warning

This equipment has been tested and found to comply with the limits for a Class A digital device, pursuant to Part 15 of the FCC Rules. These limits are designed to provide reasonable protection against harmful interference when the equipment is operated in a commercial environment. This equipment generates, uses, and can radiate radio frequency energy and, if not installed and used in accordance with this user's guide, may cause harmful interference to radio communications. Operation of this equipment in a residential area is likely to cause harmful interference in which case the user will be required to correct the interference at his own expense.

CE Mark Warning

This is a Class A product. In a domestic environment, this product may cause radio interference in which case the user may be required to take adequate measures.

Warnung!

Dies ist ein Produkt der Klasse A. Im Wohnbereich kann dieses Produkt Funkstörgerungen verursachen. In diesem Fall kann vom Benutzer verlangt werden, angemessene Massnahmen zu ergreifen.

Precaución!

Este es un producto de Clase A. En un entorno doméstico, puede causar interferencias de radio, en cuyo caso, puede requerirse al usuario para que adopte las medidas adecuadas.

Attention!

Ceci est un produit de classe A. Dans un environnement domestique, ce produit pourrait causer des interférences radio, auquel cas l'utilisateur devrait prendre les mesures adéquates.

Attenzione!

Il presente prodotto appartiene alla classe A. Se utilizzato in ambiente domestico il prodotto può causare interferenze radio, nel cui caso è possibile che l'utente debba assumere provvedimenti adeguati.

VCCI Warning

この装置は、クラスA情報技術装置です。この装置を家庭環境で使用すると電波妨害を引き起こすことがあります。この場合には使用者が適切な対策を講ずるよう要求されることがあります。

CONTENTS

PREFACE	IV
NOTES, NOTICES, AND CAUTIONS	IV
SAFETY INSTRUCTIONS	V
<i>Safety Cautions</i>	<i>v</i>
<i>General Precautions for Rack-Mountable Products</i>	<i>vii</i>
<i>Protecting Against Electrostatic Discharge</i>	<i>ix</i>
INTRODUCTION	10
SWITCH DESCRIPTION	10
<i>Switch Features</i>	<i>11</i>
<i>Gigabit Ethernet Technology</i>	<i>12</i>
<i>802.1P and QoS</i>	<i>12</i>
FRONT-PANEL COMPONENTS	15
<i>LED Indicators</i>	<i>15</i>
<i>Cable Diagnostic</i>	<i>16</i>
POWER INPUT ON REAR PANEL	18
INSTALLATION	19
<i>Package Contents</i>	<i>19</i>
BEFORE YOU CONNECT TO THE NETWORK	20
<i>Mounting the Switch on a Rack</i>	<i>21</i>
<i>Attaching the Rubber Feet</i>	<i>22</i>
<i>Provide for Adequate Ventilation</i>	<i>22</i>
POWER ON	23
<i>Power Failure</i>	<i>23</i>
CONNECTING THE SWITCH	24
<i>Switch to End Node</i>	<i>25</i>
<i>Switch to Hub or Switch</i>	<i>26</i>
<i>Connecting to Network Backbone or Server</i>	<i>27</i>
TECHNICAL SPECIFICATIONS	28
GLOSSARY	31
USA WARRANTY AND REGISTRATION INFORMATION	34
INTERNATIONAL OFFICES	40

Preface

The *DGS-1016D/DGS-1024D Manual* is divided into sections that describe the system installation and operating instructions with examples.

Section 1. Introduction - A description of the physical features of the Switch, including LED indicators, ports and panel descriptions.

Section 2. Installation - A description of the physical installation of the Switch, mounting the Switch in a equipment rack and powering on the Switch.

Section 3. Connecting the Switch - A description of how to connect your Switch to an end node, hub, another switch or backbone server.

Appendix Technical Specifications - The technical specifications of the DGS-1016D/DGS-1024D.

Notes, Notices, and Cautions



NOTE: A NOTE indicates important information that helps you make better use of your device.



NOTICE: A NOTICE indicates either potential damage to hardware or loss of data and tells you how to avoid the problem.



CAUTION: A CAUTION indicates the potential for property damage, personal injury or death.

Safety Instructions

Use the following safety guidelines to ensure your own personal safety and to help protect your system from potential damage. Throughout this safety section, the caution icon () is used to indicate cautions and precautions that you need to review and follow.



Safety Cautions

To reduce the risk of bodily injury, electrical shock, fire, and damage to the equipment, observe the following precautions.

Observe and follow service markings. Do not service any product except as explained in your system documentation. Opening or removing covers that are marked with the triangular symbol with a lightning bolt may expose you to an electrical shock. Only a trained service technician should service components inside these compartments.

If any of the following conditions occur, unplug the product from the electrical outlet and replace the part or contact your trained service provider:

- The power cable, extension cable, or plug is damaged.
 - An object has fallen into the product.
 - The product has been exposed to water.
 - The product has been dropped or damaged.
 - The product does not operate correctly when you follow the operating instructions.
- Keep your system away from radiators and heat sources. Also, do not block cooling vents.
 - Do not spill food or liquids on your system components, and never operate the product in a wet environment. If the system gets wet, see the appropriate section in your troubleshooting guide or contact your trained service provider.
 - Do not push any objects into the openings of your system. Doing so can cause a fire or an electric shock by shorting out interior components.
 - Use the product only with approved equipment.
 - Allow the product to cool before removing covers or touching internal components.
 - Operate the product only from the type of external power source indicated on the electrical ratings label. If you are not sure of the type of power source required, consult your service provider or local power company.

Safety Instructions (continued)

- To help avoid damaging your system, be sure the voltage selection Switch (if provided) on the power supply is set to match the power available at your location:
 - 115 volts (V)/60 hertz (Hz) in most of North and South America and some Far Eastern countries such as South Korea and Taiwan
 - 100 V/50 Hz in eastern Japan and 100 V/60 Hz in western Japan.
 - 230 V/50 Hz in most of Europe, the Middle East, and the Far East.
- Also be sure that attached devices are electrically rated to operate with the power available in your location.
- Use only approved power cable(s). If you have not been provided with a power cable for your system or for any AC-powered option intended for your system, purchase a power cable that is approved for use in your country. The power cable must be rated for the product and for the voltage and current marked on the product's electrical ratings label. The voltage and current rating of the cable should be greater than the ratings marked on the product.
- To help prevent an electric shock, plug the system and peripheral power cables into properly grounded electrical outlets. These cables are equipped with three-prong plugs to help ensure proper grounding. Do not use adapter plugs or remove the grounding prong from a cable. If you must use an extension cable, use a 3-wire cable with properly grounded plugs.
- Observe extension cable and power strip ratings. Make sure that the total ampere rating of all products plugged into the extension cable or power strip does not exceed 80 percent of the ampere ratings limit for the extension cable or power strip.
- To help protect your system from sudden, transient increases and decreases in electrical power, use a surge suppressor, line conditioner, or uninterruptible power supply (UPS).
- Position system cables and power cables carefully; route cables so that they cannot be stepped on or tripped over. Be sure that nothing rests on any cables.
- Do not modify power cables or plugs. Consult a licensed electrician or your power company for site modifications. Always follow your local/national wiring rules.
- When connecting or disconnecting power to hot-pluggable power supplies, if offered with your system, observe the following guidelines:
 - Install the power supply before connecting the power cable to the power supply.
 - Unplug the power cable before removing the power supply.
 - If the system has multiple sources of power, disconnect power from the system by unplugging *all* power cables from the power supplies.
- Move products with care; ensure that all casters and/or stabilizers are firmly connected to the system. Avoid sudden stops and uneven surfaces.



General Precautions for Rack-Mountable Products

- Observe the following precautions for rack stability and safety. Also refer to the rack installation documentation accompanying the system and the rack for specific caution statements and procedures.
- Systems are considered to be components in a rack. Thus, "component" refers to any system as well as to various peripherals or supporting hardware.

CAUTION: Installing systems in a rack without the front and side stabilizers installed could cause the rack to tip over, potentially resulting in bodily injury under certain circumstances. Therefore, always install the stabilizers before installing components in the rack.



After installing system/components in a rack, never pull more than one component out of the rack on its slide assemblies at one time. The weight of more than one extended component could cause the rack to tip over and may result in serious injury.

- Before working on the rack, make sure that the stabilizers are secured to the rack, extended to the floor, and that the full weight of the rack rests on the floor. Install front and side stabilizers on a single rack or front stabilizers for joined multiple racks before working on the rack.

Safety Instructions (continued)

- Always load the rack from the bottom up, and load the heaviest item in the rack first.
- Make sure that the rack is level and stable before extending a component from the rack.
- Use caution when pressing the component rail release latches and sliding a component into or out of a rack; the slide rails can pinch your fingers.
- After a component is inserted into the rack, carefully extend the rail into a locking position, and then slide the component into the rack.
- Do not overload the AC supply branch circuit that provides power to the rack. The total rack load should not exceed 80 percent of the branch circuit rating.
- Ensure that proper airflow is provided to components in the rack.
- Do not step on or stand on any component when servicing other components in a rack.



CAUTION: Never defeat the ground conductor or operate the equipment in the absence of a suitably installed ground conductor. Contact the appropriate electrical inspection authority or an electrician if you are uncertain that suitable grounding is available.



CAUTION: The system chassis must be positively grounded to the rack cabinet frame. Do not attempt to connect power to the system until grounding cables are connected. Completed power and safety ground wiring must be inspected by a qualified electrical inspector. An energy hazard will exist if the safety ground cable is omitted or disconnected.

Protecting Against Electrostatic Discharge

Static electricity can harm delicate components inside your system. To prevent static damage, discharge static electricity from your body before you touch any of the electronic components, such as the microprocessor. You can do so by periodically touching an unpainted metal surface on the chassis.

You can also take the following steps to prevent damage from electrostatic discharge (ESD):

1. When unpacking a static-sensitive component from its shipping carton, do not remove the component from the antistatic packing material until you are ready to install the component in your system. Just before unwrapping the antistatic packaging, be sure to discharge static electricity from your body.
2. When transporting a sensitive component, first place it in an antistatic container or packaging.
3. Handle all sensitive components in a static-safe area. If possible, use antistatic floor pads, workbench pads, and an antistatic grounding strap.

SECTION 1

Introduction

Switch Description

Switch Features

Ports

Front-Panel Components

LED Indicators

Power Input on Rear Panel

Switch Description

The 16-port DGS-1016D and 24-port DGS-1024D Switches provide dedicated 10, 100 or 1000 Mbps Ethernet bandwidth on each port. The ports will automatically detect the speed, duplex and MDI/MDIX status of the device it is connecting to, and adjust these settings accordingly. The Switch ports can be used to network computers, printers, servers, routers, other switches or any device equipped with an Ethernet port. For best performance, use Category 5 or better Ethernet cabling.

This stand-alone Switch is very easy to set up, there is no network management required. Just power on the Switch and connect the cables. Keep in mind however that the standard rules of Ethernet regarding cable length apply to this and all Ethernet devices. The length of an Ethernet cable from one device to another cannot exceed 100 meters (or 300 feet).

Switch Features

The DGS-1016D 16-Port and DGS-1024D 24-port Switches do not require any management. Both Switches are designed for easy installation, flexibility and high performance. Connect devices to the Switch as the scale and volume of network traffic increases.

- Sixteen (DGS-1016D) or twenty-four (DGS-1024D) 10/100/1000 Mbps Ethernet ports
- Cable Diagnostic function at Switch boot up
- Auto-Negotiation for 10/100/1000Mbps and duplex mode
- Auto-MDI/MDIX for each port
- Supports Full/Half-duplex transfer mode for 10 and 100Mbps
- Supports Full-duplex transfer mode for 1000Mbps
- Full wire speed reception and transmission
- Store-and-Forward Switching method
- Supports 8K absolute MAC addresses
- DGS-1016D Supports 340KB RAM for data buffering
- DGS-1024D Supports 500KB RAM for data buffering
- Easy to read diagnostic LEDs
- IEEE 802.3x flow control for Full-duplex
- Back pressure flow control for Half-duplex
- IEEE 802.1p Priority support

Gigabit Ethernet Technology

Gigabit Ethernet is an extension of IEEE 802.3 Ethernet utilizing the same packet structure, format, and support for CSMA/CD protocol, full duplex, flow control, and management objects, but with a tenfold increase in theoretical throughput over 100-Mbps Fast Ethernet and a hundredfold increase over 10-Mbps Ethernet. Since it is compatible with all 10-Mbps and 100-Mbps Ethernet environments, Gigabit Ethernet provides a straightforward upgrade without wasting a company's existing investment in hardware, software and trained personnel.

The increased speed and extra bandwidth offered by Gigabit Ethernet is essential to coping with the network bottlenecks that frequently develop as computers and their bus speeds get faster and more users use applications that generate more traffic. Upgrading key components, such as your backbone and servers to Gigabit Ethernet can greatly improve network response times as well as significantly speed up the traffic between your subnets.

Gigabit Ethernet supports video conferencing, complex imaging and similar data-intensive applications. Likewise, since data transfers occur 10 times faster than Fast Ethernet, servers outfitted with Gigabit Ethernet NIC's are able to perform 10 times the number of operations in the same amount of time.

802.1P and QoS

The DGS-1024D and DGS-1016D Switches support 802.1p priority queuing Quality of Service. The implementation of QoS (Quality of Service) and benefits of using 802.1p priority queuing are described here.

Advantages of QoS

QoS is an implementation of the IEEE 802.1p standard that allows network administrators a method of reserving bandwidth for important functions that require a large bandwidth or have a high priority, such as VoIP (voice-over Internet Protocol), web browsing applications, file server applications or video conferencing. Not only can a larger bandwidth be created, but other less critical traffic can be limited, so bandwidth can be saved. The Switch has separate hardware queues on every physical port to

which packets from various applications are mapped to and assigned a priority. The illustration below shows how 802.1P priority queuing is implemented on the Switch. The eight IEEE 802.1P priority levels defined by the standard are mapped to the four class queues used in the Switch.

How 802.1p works

4 Priority Queues

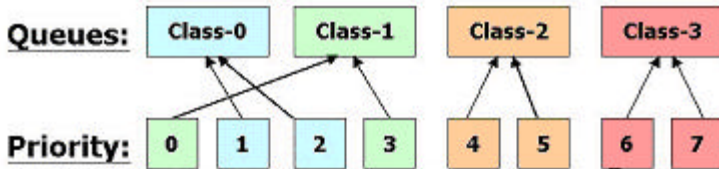

Mapping QoS on the Switch

The picture above shows the default priority setting for the Switch. Class-3 has the highest priority of the four priority queues on the Switch. In order to implement QoS, the user is required to instruct the Switch to examine the header of a packet to see if it has the proper identifying tag tagged. Then the user may forward these tagged packets to designated queues on the Switch where they will be emptied, based on priority.

"The DUT support strict mode for 802.1p QoS. The untagged pkt will follow the priority 0 to work (i.e. class 1)."

Understanding QoS.

The Switch has four priority queues. These priority queues are labeled as 3, the high queue to 0, the lowest queue. The eight priority tags, specified in IEEE 802.1p are mapped to the Switch's priority tags as follows:

- Priority 0 is assigned to the Switch's Q1 queue.
- Priority 1 is assigned to the Switch's Q0 queue.
- Priority 2 is assigned to the Switch's Q0 queue.
- Priority 3 is assigned to the Switch's Q1 queue.
- Priority 4 is assigned to the Switch's Q2 queue.
- Priority 5 is assigned to the Switch's Q2 queue.
- Priority 6 is assigned to the Switch's Q3 queue.

- Priority 7 is assigned to the Switch's Q3 queue.

The Switch uses strict priority for Scheduling. Strict priority-based scheduling, any packets residing in the higher priority queues are transmitted first.

Front-Panel Components.

Note: The Switch illustrations used for this manual depict only the model DGS-1016D Switch.

On the front panel of the Switch you will see the following.

- LED status indicators
- 16 Auto-Negotiating 10/100/1000Mbps ports on the DGS -1016D
- 24 Auto-Negotiating 10/100/1000Mbps ports on the DGS -1024D

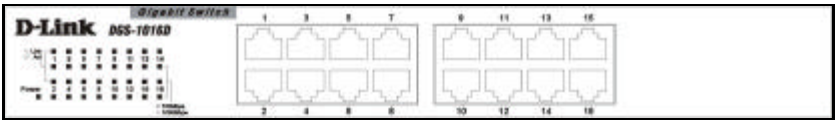

Front Panel View of the Switch

LED Indicators

The LED indicators of the Switch include a Power status indicator, one Link/Act indicator for each port as well as one speed 100/1000Mbps indicator for each port. When the Switch is powered on or restarted, it initiates a diagnostic function as part of the boot up process. The speed indicators are also used to display cable diagnostic information when the Switch boots up.

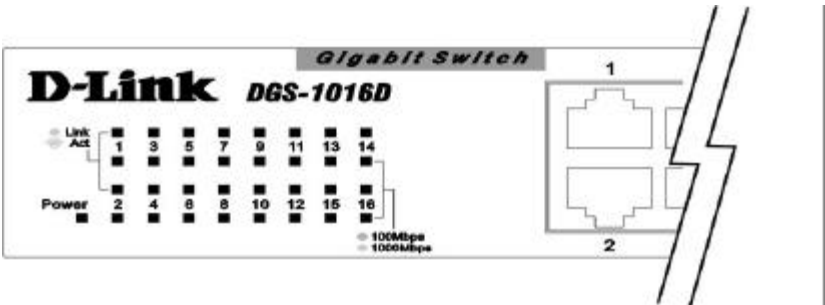

LED Indicators

Cable Diagnostic.

Upon booting up the Switch, a **Cable Diagnostic** is used to detect three problems that may prevent successful connection. This feature operates only on ports that are connected to 1000Mbps devices. If there are problems on a port connected to a Gigabit Ethernet device (1000Mbps), try restarting the Switch and watch the speed (100/1000Mbps) LED indicators to determine if the problem is a fault in the cable or connecting hardware. For ports operating at 10 or 100Mbps, the LED indicators can be used for less specific troubleshooting.

The faults detected by the cable diagnostic for 1000Mbps operation are as follows:

- Open circuit - a lack of continuity between the pins at each end of the Ethernet cable or a disconnected cable.
- Short circuit - two or more conductors short-circuited.
- Connectivity is checked for each of the eight wires of a cable to ensure its capability for running 1000Mbps.

During the diagnostic, each port is scanned to determine if the Ethernet cable and connectors is in good working order. During the diagnostic process the speed LED for each port blinks green in sequential order. This port scan takes about 3 seconds. If a cable fault is detected, the corresponding port's speed LED will light amber for 5 seconds. The Switch is then reset for normal operation. It takes about 2 seconds for the Switch to reset. The entire Cable Diagnostic process takes about 10 seconds from the time the Switch is powered on.

The table below summarizes Cable Diagnostic information.



NOTE: the cable diagnostic function does not detect the length of Ethernet cabling. Remember that the length of cabling between two Ethernet devices may not exceed 100 meters (or 300 feet).

LED Indicator	Description
Power	This lights green while the Switch is receiving power.
Link/Act	A steady green light indicates the corresponding port is connected and a valid link is established. This will blink green when there is activity on the port.
100Mbps/1000Mbps	The speed indicator will light green if the corresponding port is connected and operating at 1000Mbps. An amber light indicates the port is operating at 100Mbps. If the port is connected (as indicated by the Link/Act indicator) and the speed indicator does not light, the port is operating at 10Mbps.
Cable Diagnostic (during boot up only)	Open or short circuit, or hardware connectivity problem – 100/1000Mbps LED blinks amber for 5 seconds

Power Input on Rear Panel.

The power cable connection is located on the rear panel of the Switch.



Rear panel view of the Switch

Switch power input is provided by an internal universal power supply (100-240VAC: 12V/3.3A).

The AC power connector is a standard three-pronged connector that supports the power cord. Please see the Power On section below for instructions on how to properly connect the Switch to a power source.

SECTION 2

Installation.

Package Contents

Before You Connect to the Network

Installing the Switch

Power On

Package Contents.

Open the shipping carton of the Switch and carefully unpack its contents. The carton should contain the following items:

- One DGS-1016D 16-Port/DGS-1024D 24-Port 10/100/1000BASE-T Gigabit Ethernet Switch
- Four rubber feet with adhesive backing
- One power Cord
- Mounting ears for rack-mounting
- This manual

If any item is found missing or damaged, please contact your local D-Link reseller for replacement.

Before You Connect to the Network.

The site where you install the Switch may greatly affect its performance. Please follow these guidelines for setting up the Switch.

- Install the Switch on a sturdy, level surface that can support at least 3 kg (6.6 lbs) of weight. Do not place heavy objects on the Switch.
- The power outlet should be within 1.82 meters (6 feet) of the Switch.
- Visually inspect the power cord and see that it is fully secured to the AC power port.
- Make sure that there is adequate space for proper heat dissipation from and adequate ventilation around the Switch. Leave at least 10 cm (4 inches) of space at the front and rear of the Switch for ventilation.
- Install the Switch in a fairly cool and dry place for the acceptable temperature and humidity operating ranges.
- Install the Switch in a site free from strong electromagnetic field generators (such as motors), vibration, dust, and direct exposure to sunlight.
- When installing the Switch on a level surface, attach the rubber feet to the bottom of the device. The rubber feet cushion the Switch, protect the casing from scratches and prevent it from scratching other surfaces.

Mounting the Switch on a Rack.

The DGS-1016D/1024D can easily be mounted on a rack. Two mounting ears are provided for this purpose. Make sure that the front panel is exposed in order to view the LEDs. Please refer to the following illustrations:

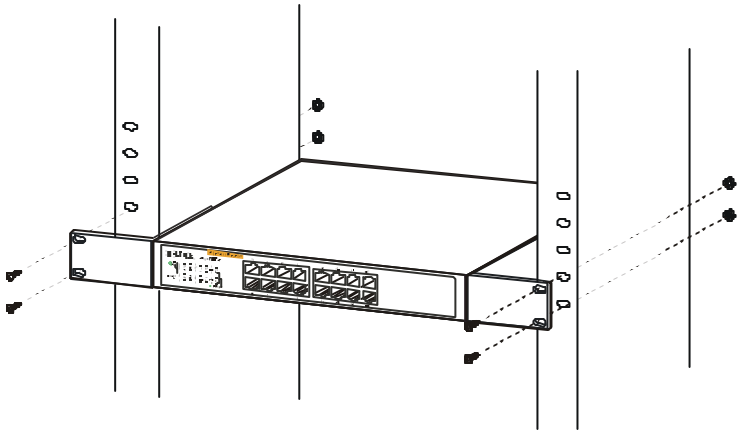
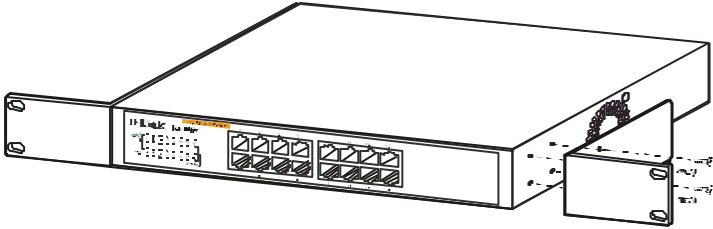

Mounting the Switch to a Rack

1. Attach the ears to each side of the Switch, using the screw-holes located on the side of the device.
2. Firmly attach the ears to the rack as shown. Please follow the usual safety precautions for rack-mountable products

Attaching the Rubber Feet.

Use rubber feet provided. Position and apply rubber feet to the underside of the DGS-1016D/1024D Switch.

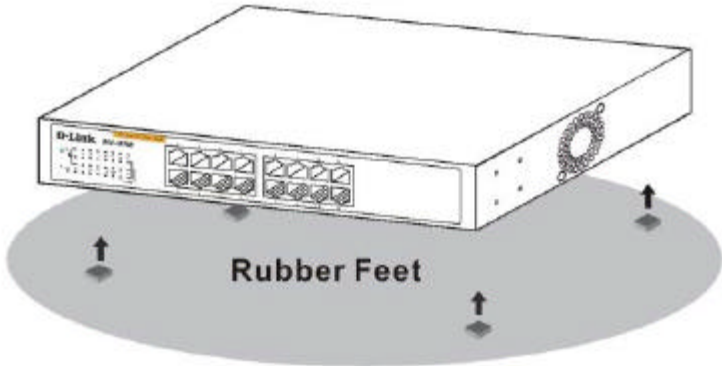

Attaching the Rubber Feet

Provide for Adequate Ventilation.



CAUTION: Do not place any device on top of Switch, or place the Switch on top of any device or object that will block the free flow of air through the ventilation slots on the sides, top, and bottom of the Switch's case. In addition, care should be taken not to locate the Switch next to, on top of, or underneath any device that generates a significant amount of heat. For the Switch to perform at its optimal level, the Switch must have adequate ventilation to prevent the Switch from overheating and becoming damaged.

Power On.

To power on the Switch, Plug-in the female connector of the provided power cord into this socket, and the male side of the cord into a suitable power source.

After the Switch is powered on, the LED indicators will blink briefly while the system resets.

Power Failure.

As a precaution, in the event of a power failure, unplug the Switch. When power is resumed, plug the Switch back in.

Section 3

Connecting the Switch.

Switch to End Node

Switch to Hub or Switch

Connecting to a Server



NOTE: All Ethernet ports auto-detect MDI-II/MDI-X, port speed (10, 100, 1000Mbps) and duplex of the device connected to the Switch.

Cable Quality

For all connections to the Switch, use these rules to determine the

- For connections to 10BASE-T and 100BASE-TX devices, use Category 5 or 5e UTP/STP cable.
- For connections to 1000BASE-T and 100BASE-TX devices, use Category 5e or better UTP/STP cable. All 1000BASE-T connections operate in full duplex mode.



NOTE: UTP (Unshielded Twisted Pair) Ethernet cabling is adequate for most small office environments. More expensive STP (Shielded Twisted Pair) can also be used, but is generally only needed where there will be risk of strong Electromagnetic or Radio Frequency Interference.

Switch to End Node.

End nodes include PCs outfitted with a 10, 100 or 1000 Mbps RJ-45 Ethernet/Fast Ethernet Network Interface Card (NIC) and Ethernet ready routers. Use standard Ethernet cable to connect the Switch to end nodes. Switch ports will automatically adjust to the hardware characteristics (MDI-II/MDI-X, speed, duplex) of the device to which it is connected.

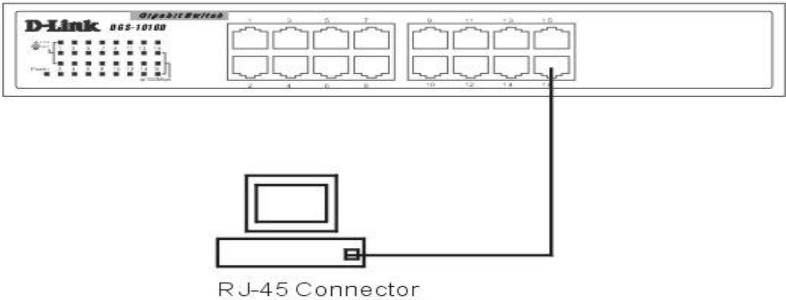

Switch connected to an end node

Observe the guidelines for cable quality stated at the beginning of this section. The **Link/Act** LEDs for each port lights green when the link is valid.

Switch to Hub or Switch.

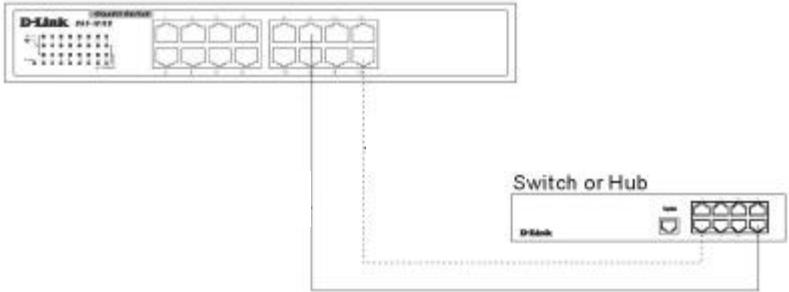

Connect to another switch or hub.

Observe the guidelines for cable quality stated at the beginning of this section. The **Link/Act** LEDs for each port lights green when the link is valid.

Connecting to Network Backbone or Server.

Any port may be used to uplink the Switch to a network backbone or network server. When linking to a 1000BASE-T device the port operates in full duplex mode.

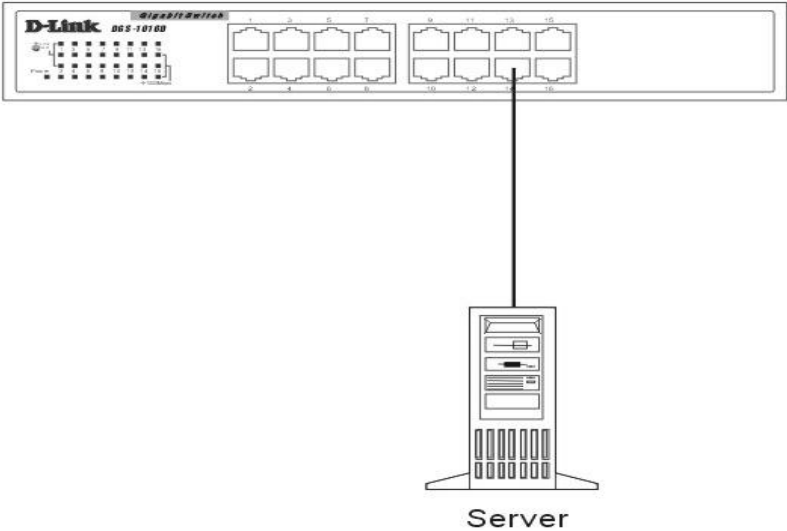

Connection to a Server

Observe the guidelines for cable quality stated at the beginning of this section. The **Link/Act** LEDs for each port lights green when the link is valid.

Appendix

Technical Specifications.

General	
Standards:	IEEE 802.3 10BASE-T IEEE 802.3u compliance IEEE 802.3ab compliance IEEE 802.1p compliance Half or Full-Duplex operations at 10/100Mbps Full-Duplex operations at 1000Mbps IEEE 802.3x Flow Control supports for Full Duplex Support back pressure for Half-Duplex operation
Protocol:	CSMA/CD
Data Transfer Rate:	Ethernet: 10Mbps (Half-duplex) 20Mbps (Full-duplex) Fast Ethernet: 100Mbps (Half-duplex) 200Mbps (Full-duplex) Gigabit Ethernet: 2000Mbps (Full-duplex)
Topology:	Star
Network Cables:	Ethernet: 2-pair UTP Cat. 3,4,5, Unshield Twisted Pair (UTP)Cable Fast Ethernet: 2-pair UTP Cat. 5, Unshield Twisted Pair (UTP)Cable Gigabit Ethernet: 4-pair UTP Cat. 5e, Unshield Twisted Pair (UTP)Cable
Number of Ports:	Sixteen (16) or twenty-four (24) 10/100/1000BASE-T Gigabit Ethernet ports

Physical and Environmental

AC Inputs:	100~240VAC; 12V/3.3A Internal universal power supply
Power Consumption:	30.2 watts maximum
Fans	1 Built-in 40 x 40 x 10 mm Fans
Operating Temperature:	32°F ~ 104F ° (0 °C ~ 40 °C)
Storage Temperature:	14°F ~ 158°F (-10°C ~ 70°C)
Humidity:	5% ~ 95% RH, non-condensing
Dimensions :	11.02 in. x 7.09 in. x 1.73 in. (280 mm x 180 mm x 44 mm)
Weight	DGS-1024D: 1.79 kg / DGS-1016D: 1.69 kg
EMI	FCC Class A, CE Class A, VCCI Class A
Safety:	CSA International

Performance

Transmission Method:	Store-and-forward
RAM Buffer:	DGS-1016D Supports 340KB RAM per device DGS-1024D Supports 500KB RAM per device
Filtering Address Table:	8K MAC address per device
Packet Filtering/ Forwarding Rate:	Full wire speed
MAC Address Learning:	Self-learning, auto-aging
Jumbo Frame	9.6 KBytes support

Glossary

1000BASE-LX – A short laser wavelength on multimode fiber optic cable for a maximum length of 550 meters.

1000BASE-SX – A long wavelength for a "long haul" fiber optic cable for a maximum length of 10 kilometers.

100BASE-FX – 100Mbps Ethernet implementation over fiber.

100BASE-TX – 100Mbps Ethernet implementation over Category 5 and Type 1 Twisted Pair cabling.

10BASE-T – The IEEE 802.3 specification for Ethernet over Unshielded Twisted Pair (UTP) cabling.

aging – The automatic removal of dynamic entries from the Switch Database which have timed-out and are no longer valid.

ATM – Asynchronous Transfer Mode. A connection oriented transmission protocol based on fixed length cells (packets). ATM is designed to carry a complete range of user traffic, including voice, data, and video signals.

auto-negotiation – A feature on a port, which allows it to advertise its capabilities for speed, duplex, and flow control. When connected to an end station that also supports auto-negotiation, the link can self-detect its optimum operating setup.

backbone port – A port that does not learn device addresses, and that receives all frames with an unknown address. Backbone ports are normally used to connect the Switch to the backbone of your network. Note that backbone ports were formerly known as designated downlink ports.

backbone – The part of a network used as the primary path for transporting traffic between network segments.

Bandwidth – Information capacity, measured in bits per second, that a channel can transmit. The bandwidth of Ethernet is 10Mbps. the bandwidth of Fast Ethernet is 100Mbps.

baud rate – The switching speed of a line. Also known as *line speed*.

BOOTP – The BOOTP protocol allows you to automatically map an IP address to a given MAC address each time a device is started. In addition, the protocol can assign the subnet mask and default gateway to a device.

bridge – A device that interconnects local or remote networks no matter what higher level protocols are involved. Bridges form a single logical network, centralizing network administration.

broadcast – A message sent to all destination devices on the network.

broadcast storm – Multiple simultaneous broadcasts that typically absorb available network bandwidth and can cause network failure.

console port – The port on the Switch accepting a terminal or modem connector. It changes the parallel arrangement of data within computers to the serial form used on data transmission links. This port is most often used for dedicated local management.

CSMA/CD – Channel access method used by Ethernet and IEEE 802.3 standards, in which devices transmit only after finding the data channel clear for some period of time. When two devices transmit simultaneously, a collision occurs and the colliding devices delay their retransmissions for a random amount of time.

data center switching – The point of aggregation within a corporate network where a switch provides high-performance access to server farms, a high-speed backbone connection, and a control point for network management and security.

Ethernet – A LAN specification developed jointly by Xerox, Intel, and Digital Equipment Corporation. Ethernet networks operate at 10Mbps using CSMA/CD to run over cabling.

Fast Ethernet – 100Mbps technology based on the Ethernet/CD network access method.

Flow Control – (IEEE 802.3x) A means of holding packets back at the transmit port of the connected end station. Prevents packet loss at a congested switch port.

forwarding – The process of sending a packet toward its destination by an internetworking device.

Full-duplex – A system that allows packets to be transmitted and received at the same time and, in effect, doubles the potential throughput of a link.

Half-duplex – A system that allows packets to be transmitted and received, but not at the same time. Contrast with *full-duplex*.

IP address – Internet Protocol address. A unique identifier for a device attached to a network using TCP/IP. The address is written as four octets separated with full-stops (periods), and is made up of a network section, an optional subnet section and a host section.

IPX – Internetwork Packet Exchange. A protocol allowing communication in a NetWare network.

LAN – Local Area Network. A network of connected computing resources (such as PCs, printers, servers) covering a relatively small geographic area (usually not larger than a floor or building). Characterized by high data rates and low error rates.

latency – The delay between the time a device receives a packet and the time the packet is forwarded out of the destination port.

line speed – See *baud rate*.

main port – The port in a resilient link that carries data traffic in normal operating conditions.

MDI – Medium Dependent Interface. An Ethernet port connection where the transmitter of one device is connected to the receiver of another device.

MDI-X – Medium Dependent Interface Cross-over. An Ethernet port connection where the internal transmit and receive lines are crossed.

MIB – Management Information Base. Stores a device's management characteristics and parameters. MIBs are used by the Simple Network Management Protocol (SNMP) to contain attributes of their managed systems. The Switch contains its own internal MIB.

multicast – Single packets copied to a specific subset of network addresses. These addresses are specified in the destination-address field of the packet.

protocol – A set of rules for communication between devices on a network. The rules dictate format, timing, sequencing, and error control.

resilient link – A pair of ports that can be configured so that one will take over data transmission should the other fail. See also *main port* and *standby port*.

RJ-45 – Standard 8-wire connectors for IEEE 802.3 10BASE-T networks.

RMON – Remote Monitoring. Subset of SNMP MIB II, which allows monitoring and management capabilities by addressing up to ten different groups of information.

RPS – Redundant Power System. A device that provides a backup source of power when connected to the Switch.

server farm – A cluster of servers in a centralized location serving a large user population.

SLIP – Serial Line Internet Protocol. A protocol that allows IP to run over a serial line connection.

SNMP – Simple Network Management Protocol. A protocol originally designed to be used in managing TCP/IP internets. SNMP is presently implemented on a wide range of computers and networking equipment and may be used to manage many aspects of network and end station operation.

Spanning Tree Protocol – (STP) A bridge-based system for providing fault tolerance on networks. STP works by allowing you to implement parallel paths for network traffic, and to ensure that redundant paths are disabled when the main paths are operational and enabled if the main paths fail.

stack – A group of network devices that are integrated to form a single logical device.

standby port – The port in a resilient link that will take over data transmission if the main port in the link fails.

switch – A device that filters, forwards, and floods packets based on the packet's destination address. The Switch learns the addresses associated with each switch port and builds tables based on this information to be used for the switching decision.

TCP/IP – A layered set of communications protocols providing Telnet terminal emulation, FTP file transfer, and other services for communication among a wide range of computer equipment.

Telnet – A TCP/IP application protocol that provides virtual terminal service, letting a user log in to another computer system and access a host as if the user were connected directly to the host.

TFTP – Trivial File Transfer Protocol. Allows you to transfer files (such as software upgrades) from a remote device using your switch's local management capabilities.

UDP – User Datagram Protocol. An Internet standard protocol that allows an application program on one device to send a datagram to an application program on another device.

VLAN – Virtual LAN. A group of location- and topology-independent devices that communicate as if they are on a common physical LAN.

VLT – Virtual LAN Trunk. A Switch-to-Switch link which carries traffic for all the VLANs on each Switch.

VT100 – A type of terminal that uses ASCII characters. VT100 screens have a text-based appearance.

USA Warranty and Registration Information



Limited Warranty
(USA Only)

Subject to the terms and conditions set forth herein, D-Link Systems, Inc. ("D-Link") provides this Limited warranty for its product only to the person or entity that originally purchased the product from:

- D-Link or its authorized reseller or distributor and
- Products purchased and delivered within the fifty states of the United States, the District of Columbia, U.S. Possessions or Protectorates, U.S. Military Installations, addresses with an APO or FPO.

Limited Warranty: D-Link warrants that the hardware portion of the D-Link products described below will be free from material defects in workmanship and materials from the date of original retail purchase of the product, for the period set forth below applicable to the product type ("Warranty Period"), except as otherwise stated herein.

Limited Lifetime Warranty for the Product(s) is defined as follows:

- Hardware for as long as the original customer/end user owns the product, or five years after product discontinuance, whichever occurs first (excluding power supplies and fans)
- Power Supplies and Fans Three (3) Year
- Spare parts and spare kits Ninety (90) days

D-Link's sole obligation shall be to repair or replace the defective Hardware during the Warranty Period at no charge to the original owner or to refund at D-Link's sole discretion. Such repair or replacement will be rendered by D-Link at an Authorized D-Link Service Office. The replacement Hardware need not be new or have an identical make, model or part. D-Link may in its sole discretion replace the defective Hardware (or any part thereof) with any reconditioned product that D-Link reasonably determines is substantially equivalent (or superior) in all material respects to the defective Hardware. Repaired or replacement Hardware will be warranted for the remainder of the original Warranty Period from the date of original retail purchase. If a material defect is incapable of correction, or if D-Link determines in its sole discretion that it is not practical to repair or replace the defective Hardware, the price paid by the original purchaser for the defective Hardware will be refunded by D-Link upon return to D-Link of the defective Hardware. All Hardware (or part thereof) that is replaced by D-Link, or for which the purchase price is refunded, shall become the property of D-Link upon replacement or refund.

Limited Software Warranty: D-Link warrants that the software portion of the product ("Software") will substantially conform to DLink's then current functional specifications for the Software, as set forth in the applicable documentation, from the date of original retail purchase of the Software for a period of ninety (90) days ("Warranty Period"), provided that the Software is properly installed on approved hardware and operated as contemplated in its documentation. D-Link further warrants that, during the Warranty Period, the magnetic media on which DLink delivers the Software will be free of physical defects. D-Link's sole obligation shall be to replace the non-conforming Software (or defective media) with software that substantially conforms to DLink's functional specifications for the Software or to refund at D-Link's sole discretion. Except as otherwise agreed by D-Link in writing, the replacement Software is provided only to the original licensee, and is subject to the terms and conditions of the license granted by D-Link for the Software. Software will be warranted for the remainder of the original Warranty Period from the date of original retail purchase. If a material non-conformance is incapable of correction, or if D-Link determines in its sole discretion that it is not practical to replace the non-conforming Software, the price paid by the original licensee for the non-conforming Software will be refunded by D-Link; provided that the non-conforming Software (and all copies thereof) is first returned to DLink. The license granted respecting any Software for which a refund is given automatically terminates.

Non-Applicability of Warranty: The Limited Warranty provided hereunder for hardware and software of D-Link's products will not be applied to and does not cover any refurbished product and any product purchased through the inventory clearance or liquidation sale or other sales in which DLink, the sellers, or the liquidators expressly disclaim their warranty obligation pertaining to the product and in that case, the product is being sold "As-Is" without any warranty whatsoever including, without limitation, the Limited Warranty as described herein, notwithstanding anything stated herein to the contrary.

Submitting A Claim: The customer shall return the product to the original purchase point based on its return policy. In case the return policy period has expired and the product is within warranty, the customer shall submit a claim to DLink as outlined below:

- The customer must submit with the product as part of the claim a written description of the Hardware defect or Software nonconformance in sufficient detail to allow D-Link to confirm the same.
- The original product owner must obtain a Return Material Authorization ("RMA") number from the Authorized DLink Service Office and, if requested, provide written proof of purchase of the product (such as a copy of the dated purchase invoice for the product) before the warranty service is provided.
- After an RMA number is issued, the defective product must be packaged securely in the original or other suitable shipping package to ensure that it will not be damaged in transit, and the RMA number must be prominently marked on the outside of the package. Do not include any manuals or accessories in the shipping package. DLink will only replace the defective portion of the Product and will not ship back any accessories.

The customer is responsible for all in-bound shipping charges to D-Link. No Cash on Delivery ("COD") is allowed. Products sent COD will either be rejected by D-Link or become the property of D-Link. Products shall be fully insured by the customer and shipped to **D-Link Systems, 17595 Mt. Herrman Street, Fountain Valley, CA. 92708**. D-Link will not be held responsible for any packages that are lost in transit to D-Link. The repaired or replaced packages will be shipped to the customer via UPS Ground or any common carrier selected by D-Link, with shipping charges prepaid. Expedited shipping is available if shipping charges are prepaid by the customer and upon request.

D-Link may reject or return any product that is not packaged and shipped in strict compliance with the foregoing requirements, or for which an RMA number is not visible from the outside of the package. The product owner agrees to pay D-Link's reasonable handling and return shipping charges for any product that is not packaged and shipped in accordance with the foregoing requirements, or that is determined by D-Link not to be defective or non-conforming.

What Is Not Covered: This limited warranty provided by D-Link does not cover: Products, if in D-Link's judgment, have been subjected to abuse, accident, alteration, modification, tampering, negligence, misuse, faulty installation, lack of reasonable care, repair or service in any way that is not contemplated in the documentation for the product, or if the model or serial number has been altered, tampered with, defaced or removed; Initial installation, installation and removal of the product for repair, and shipping costs; Operational adjustments covered in the operating manual for the product, and normal maintenance; Damage that occurs in shipment, due to act of God, failures due to power surge, and cosmetic damage; Any hardware, software, firmware or other products or services provided by anyone other than D-Link; Products that have been purchased from inventory clearance or liquidation sales or other sales in which D-Link, the sellers, or the liquidators expressly disclaim their warranty obligation pertaining to the product. Repair by anyone other than D-Link or an Authorized D-Link Service Office will void this Warranty.

Disclaimer of Other Warranties: EXCEPT FOR THE LIMITED WARRANTY SPECIFIED HEREIN, THE PRODUCT IS PROVIDED "AS-IS" WITHOUT ANY WARRANTY OF ANY KIND WHATSOEVER INCLUDING, WITHOUT LIMITATION, ANY WARRANTY OF MERCHANTABILITY, FITNESS FOR A PARTICULAR PURPOSE AND NON-INFRINGEMENT. IF ANY IMPLIED WARRANTY CANNOT BE DISCLAIMED IN ANY TERRITORY WHERE A PRODUCT IS SOLD, THE DURATION OF SUCH IMPLIED WARRANTY SHALL BE LIMITED TO NINETY (90) DAYS. EXCEPT AS EXPRESSLY COVERED UNDER THE LIMITED WARRANTY PROVIDED HEREIN, THE ENTIRE RISK AS TO THE QUALITY, SELECTION AND PERFORMANCE OF THE PRODUCT IS WITH THE PURCHASER OF THE PRODUCT.

Limitation of Liability: TO THE MAXIMUM EXTENT PERMITTED BY LAW, D LINK IS NOT LIABLE UNDER ANY CONTRACT, NEGLIGENCE, STRICT LIABILITY OR OTHER LEGAL OR EQUITABLE THEORY FOR ANY LOSS OF USE OF THE PRODUCT, INCONVENIENCE OR DAMAGES OF ANY CHARACTER, WHETHER DIRECT, SPECIAL, INCIDENTAL OR CONSEQUENTIAL (INCLUDING, BUT NOT LIMITED TO, DAMAGES FOR LOSS OF GOODWILL, LOSS OF REVENUE OR PROFIT, WORK STOPPAGE, COMPUTER FAILURE OR MALFUNCTION, FAILURE OF OTHER EQUIPMENT OR COMPUTER PROGRAMS TO WHICH D-LINK'S PRODUCT IS CONNECTED WITH, LOSS OF INFORMATION OR DATA CONTAINED IN, STORED ON, OR INTEGRATED WITH ANY PRODUCT RETURNED TO DLINK FOR WARRANTY SERVICE) RESULTING FROM THE USE OF THE PRODUCT, RELATING TO WARRANTY SERVICE, OR ARISING OUT OF ANY BREACH OF THIS LIMITED WARRANTY, EVEN IF DLINK HAS BEEN ADVISED OF THE POSSIBILITY OF SUCH DAMAGES. THE SOLE REMEDY FOR A BREACH OF THE FOREGOING LIMITED WARRANTY IS REPAIR, REPLACEMENT OR REFUND OF THE DEFECTIVE OR NON-CONFORMING PRODUCT. THE MAXIMUM LIABILITY OF DLINK UNDER THIS WARRANTY IS LIMITED TO THE PURCHASE PRICE OF THE PRODUCT COVERED BY THE WARRANTY. THE FOREGOING EXPRESS WRITTEN WARRANTIES AND REMEDIES ARE EXCLUSIVE AND ARE IN LIEU OF ANY OTHER WARRANTIES OR REMEDIES, EXPRESS, IMPLIED OR STATUTORY

Governing Law. This Limited Warranty shall be governed by the laws of the State of California. Some states do not allow exclusion or limitation of incidental or consequential damages, or limitations on how long an implied warranty lasts, so the foregoing limitations and exclusions may not apply. This limited warranty provides specific legal rights and the product owner may also have other rights which vary from state to state.

Trademarks: D-Link is a registered trademark of DLink Systems, Inc. Other trademarks or registered trademarks are the property of their respective manufacturers or owners.

Copyright Statement: No part of this publication or documentation accompanying this Product may be reproduced in any form or by any means or used to make any derivative such as translation, transformation, or adaptation without permission from D-Link Corporation/D-Link Systems, Inc., as stipulated by the United States Copyright Act of 1976. Contents are subject to change without prior notice. Copyright© 2004 by D-Link Corporation/D-Link Systems, Inc. All rights reserved.

CE Mark Warning: This is a Class A product. In a domestic environment, this product may cause radio interference, in which case the user may be required to take adequate measures.

FCC Statement: This equipment has been tested and found to comply with the limits for a Class A digital device, pursuant to part 15 of the FCC Rules. These limits are designed to provide reasonable protection against harmful interference in a residential installation. This equipment generates, uses, and can radiate radio frequency energy and, if not installed and used in accordance with the instructions, may cause harmful interference to radio communication. However, there is no guarantee that interference will not occur in a particular installation. If this equipment does cause harmful interference to radio or television reception, which can be determined by turning the equipment off and on, the user is encouraged to try to correct the interference by one or more of the following measures:

- Reorient or relocate the receiving antenna.
- Increase the separation between the equipment and receiver.
- Connect the equipment into an outlet on a circuit different from that to which the receiver is connected.
- Consult the dealer or an experienced radio/TV technician for help.

For detailed warranty outside the United States, please contact corresponding local D-Link office.

Register online your D-Link product at <http://support.dlink.com/register/>

International Offices

U.S.A

17595 Mt. Herrmann Street
Fountain Valley, CA 92708
TEL: 1-800-326-1688
URL: www.dlink.com

Canada

2180 Winston Park Drive
Oakville, Ontario, L6H 5W1
Canada
TEL: 1-905-8295033
FAX: 1-905-8295223
URL: www.dlink.ca

Europe (U. K.)

4th Floor, Merit House
Edgware Road, Colindale
London NW9 5AB
U.K.
TEL: 44-20-8731-5555
FAX: 44-20-8731-5511
URL: www.dlink.co.uk

Germany

Schwalbacher Strasse 74
D-65760 Eschborn
Germany
TEL: 49-6196-77990
FAX: 49-6196-7799300
URL: www.dlink.de

France

No.2 all'ee de la Fresnerie
78330 Fontenay le Fleury
France
TEL: 33-1-30238688
FAX: 33-1-30238689
URL: www.dlink.fr

Netherlands

Weena 290
3012 NJ, Rotterdam
Netherlands
Tel: +31-10-282-1445
Fax: +31-10-282-1331
URL: www.dlink.nl

Belgium

Rue des Colonies 11
B-1000 Brussels
Belgium
Tel: +32(0)2 517 7111
Fax: +32(0)2 517 6500
URL: www.dlink.be

Italy

Via Nino Bonnet n. 6/b
20154 – Milano
Italy
TEL: 39-02-2900-0676
FAX: 39-02-2900-1723
URL: www.dlink.it

Sweden

P.O. Box 15036, S-167 15
Bromma
Sweden
TEL: 46-(0)8564-61900
FAX: 46-(0)8564-61901
URL: www.dlink.se

Denmark

Naverland 2, DK-2600
Glostrup, Copenhagen
Denmark
TEL: 45-43-969040
FAX: 45-43-424347
URL: www.dlink.dk

Norway

Karihaugveien 89
N-1086 Oslo
Norway
TEL: +47 99 300 100
FAX: +47 22 30 95 80
URL: www.dlink.no

Finland

Latokartanontie 7A
FIN-00700 HELSINKI
Finland
TEL: +358-10 309 8840
FAX: +358-10 309 8841
URL: www.dlink.fi

Spain

Avenida Diagonal, 593-95, 9th
floor
08014 Barcelona
Spain
TEL: 34 93 4090770
FAX: 34 93 4910795
URL: www.dlink.es

Portugal

Rua Fernando Pahlha
50 Edificio Simol
1900 Lisbon Portugal
TEL: +351 21 8688493
URL: www.dlink.es

Czech Republic

Vaclavske namesti 36, Praha 1
Czech Republic
TEL :+420 (603) 276 589
URL: www.dlink.cz

Switzerland

Glatt Tower, 2.OG CH-8301
Glattzentrum Postfach 2.OG
Switzerland
TEL : +41 (0) 1 832 11 00
FAX: +41 (0) 1 832 11 01
URL: www.dlink.ch

Greece

101, Panagoulis Str. 163-43
Heliopolis Athens, Greece
TEL : +30 210 9914 512
FAX: +30 210 9916902
URL: www.dlink.gr

Luxemburg

Rue des Colonies 11,
B-1000 Brussels,
Belgium
TEL: +32 (0)2 517 7111
FAX: +32 (0)2 517 6500
URL: www.dlink.be

International Offices

Poland

Budynek Aurum ul. Walic-w 11
PL-00-851
Warszawa
Poland
TEL : +48 (0) 22 583 92 75
FAX: +48 (0) 22 583 92 76
URL: www.dlink.pl

Hungary

R-k-czi-t 70-72
HU-1074
Budapest
Hungary
TEL : +36 (0) 1 461 30 00
FAX: +36 (0) 1 461 30 09
URL: www.dlink.hu

Singapore

1 International Business Park
#03-12 The Synergy
Singapore 609917
TEL: 65-6774-6233
FAX: 65-6774-6322
URL: www.dlink-intl.com

Australia

1 Giffnock Avenue
North Ryde, NSW 2113
Australia
TEL: 61-2-8899-1800
FAX: 61-2-8899-1868
URL: www.dlink.com.au

India

D-Link House, Kurla Bandra
Complex Road
Off CST Road, Santacruz (East)
Mumbai - 400098
India
TEL: 91-022-26526696/56902210
FAX: 91-022-26528914
URL: www.dlink.co.in

Middle East (Dubai)

P.O.Box: 500376
Office: 103, Building:3
Dubai Internet City
Dubai, United Arab Emirates
Tel: +971-4-3916480
Fax: +971-4-3908881
URL: www.dlink-me.com

Turkey

Ayazaga Maslak Yolu
Erdebil Cevahir Is Merkezi
5/A Ayazaga – Istanbul
Turkiye
TEL: +90 212 289 56 59
FAX: +90 212 289 76 06
URL: www.dlink.com.tr

Egypt

19 El-Shahed Helmy, El Masri
Al-Maza, Heliopolis
Cairo, Egypt
TEL: +202 414 4295
FAX: +202 415 6704
URL: www.dlink-me.com

Israel

11 Hamanofim Street
Ackerstein Towers, Regus
Business Center
P.O.B 2148, Hertzelia-Pituach
46120
Israel
TEL: +972-9-9715700
FAX: +972-9-9715601
URL: www.dlink.co.il

Latin America

Isidora Goyechea 2934
Ofcina 702
Las Condes
Santiago – Chile
TEL: 56-2-232-3185
FAX: 56-2-232-0923
URL: www.dlink.cl

Brazil

Av das Nacoes Unidas
11857 – 14- andar - cj 141/142
Brooklin Novo
Sao Paulo - SP - Brazil
CEP 04578-000 (Zip Code)
TEL: (55 11) 21859300
FAX: (55 11) 21859322
URL: www.dlinkbrasil.com.br

South Africa

Einstein Park II
Block B
102-106 Witch-Hazel Avenue
Highveld Technopark
Centurion
Gauteng
Republic of South Africa
TEL: 27-12-665-2165
FAX: 27-12-665-2186
URL: www.d-link.co.za

Russia

Grafsky per., 14, floor 6
Moscow
129626 Russia
TEL: 7-095-744-0099
FAX: 7-095-744-0099 #350
URL: www.dlink.ru

China

No.202,C1 Building, Huitong
Office Park,
No. 71, Jianguo Road, Chaoyang
District, Beijing
100025, China.
TEL +86-10-58635800
FAX: +86-10-58635799
URL: www.dlink.com.cn

Taiwan

No. 289 , Sinhu 3rd Rd., Neihu
District ,
Taipei City 114 ,Taiwan
TEL: 886-2-6600-0123
FAX: 886-2-6600-1188
URL: www.dlinktw.com.tw

Free Manuals Download Website

<http://myh66.com>

<http://usermanuals.us>

<http://www.somanuals.com>

<http://www.4manuals.cc>

<http://www.manual-lib.com>

<http://www.404manual.com>

<http://www.luxmanual.com>

<http://aubethermostatmanual.com>

Golf course search by state

<http://golfingnear.com>

Email search by domain

<http://emailbydomain.com>

Auto manuals search

<http://auto.somanuals.com>

TV manuals search

<http://tv.somanuals.com>