DGS-6600 Configuration Guide

Ver. 1.00

D-Link

DGS-6600

Information in this document is subject to change without notice.

© 2013 D-Link Corporation. All rights reserved.

Reproduction in any manner whatsoever without the written permission of D-Link Corporation is strictly forbidden.

Trademarks used in this text: D-Link and the D-LINK logo are trademarks of D-Link Corporation; Microsoft and Windows are registered trademarks of Microsoft Corporation.

Other trademarks and trade names may be used in this document to refer to either the entities claiming the marks and names or their products. D-Link Corporation disclaims any proprietary interest in trademarks and trade names other than its own.

Audience

The DGS-6600 Configuration Guide contains information for the setup and management of the DGS-6600 Switch. The term, “the Switch” will be used when referring to the DGS-6600. This Configuration Guide is intended for network managers and individuals familiar with network management concepts and terminology.

Related Documentation

- DGS-6600 Command Line Reference Guide

Typographical Conventions

The conventions used in this Configuration Guide are explained in the following table:

Convention	Description	Example
Typewriter Font	This is used in the CLI examples to represent the text that is seen in the Switch console window and the output. This is also used to indicate Switch responses.	DGS-6600:2>
Boldface Typewriter Font	This is used in the CLI examples to represent the commands that the user will type in the Switch console window. The commands must be typed exactly as printed in the manual.	configure terminal
BOLD UPPER CASE ITALIC TYPEWRITER FONT	This is used in the CLI examples to indicate the parameters in a CLI command.	VLAN-NAME
Square brackets []	This token specifies optional elements. A user can specify zero, one, or multiple elements.	[view VIEW-NAME]
Vertical bar	This token separates the alternative elements.	dhcp bootp
Braces { }	This token specifies a required element. The user must specify one of the elements.	{1 2c 3 {auth noauth priv}}
, -	These tokens specify that multiple interfaces can be specified. The '-' symbol is used to represent a range of interfaces and the ',' symbol is used to connect multiple ranges.	[, -]
Angle brackets <>	This token represents the numeric range of a parameter. The available range is enclosed in the <> symbols.	<1-10>
Bold Font	Indicates a Switch command or a Keyword.	configure terminal
Italic Font	Indicates a variable or parameter that is replaced with an appropriate word or string.	Type the <i>IP address</i> of your TFTP Server.

Notes, Notices, and Cautions

Below are examples of the 3 types of indicators used in this manual. When configuring your switch using the information in this document, you should pay special attention to these indicators. Each example below provides an explanatory remark regarding each type of indicator.



NOTE: A **NOTE** indicates important information that helps you make better use of your device

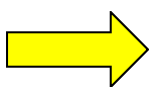

NOTICE: A **NOTICE** indicates either potential damage to hardware or loss of data and tells you how to avoid the problem



CAUTION: A **CAUTION** indicates a potential for property damage, personal injury, or death.

Table of Contents

Preface	iii
<i>Audience</i>	<i>iii</i>
<i>Related Documentation</i>	<i>iii</i>
<i>Typographical Conventions</i>	<i>iii</i>
<i>Notes, Notices, and Cautions</i>	<i>iv</i>
Chapter 1-DGS-6600 Series Switch Product Summary	18
Chapter Overview	18
<i>An Introduction to the DGS-6600 Series Switch</i>	18
<i>Components and Hardware</i>	19
<i>Chassis</i>	20
<i>Module Plug-in Frame</i>	20
Module List	21
Supported User Interfaces	24
Chapter 2-Quick Start	25
Chapter Overview	25
<i>An Introduction to Quickly Setting Up the DGS-6600 Series Switch</i>	25
Preparation for Installation	25
<i>Static Discharge Damage Prevention</i>	26
<i>Moving the Device</i>	26
<i>System Grounding Requirements</i>	27
<i>Simple Grounding Steps</i>	28
Installation Site Requirements	28
<i>Ventilation Requirements</i>	28
Removing and Installing Modules from the DGS-6600 Series Switch	29
<i>Removing Modules from the DGS-6600</i>	29
<i>Installing Modules in the DGS-6604 & DGS-6608</i>	29
Configuring the Connection To The Switch	30
<i>Connecting a Terminal to the Console Port</i>	30
<i>SNMP-Based Management</i>	30

Part 1- Configuration Fundamentals

Chapter 3-Command-Line Interface (CLI)	32
Command-Line Interface Overview	32
<i>An Introduction to the Command-Line Interface</i>	32
<i>Command Mode and User Privilege Level</i>	32
User EXEC Mode Configuration Commands	35
<i>Help Features</i>	38
<i>Editing Features</i>	40
<i>Using Abbreviated Commands</i>	41
<i>Error Messages</i>	42
<i>Command Prompt</i>	43
<i>Login Banner</i>	46
<i>Establishing a Telnet Connection to a Remote Device</i>	47
<i>Common Parameter Syntax Conventions</i>	48
<i>Allowed Character Strings And String Examples</i>	49

<i>Time and Date Configuration</i>	50
<i>Calendar Dates</i>	50
<i>Time</i>	51
<i>Countdown Timer</i>	51
Chapter 4-Accessing the Command Line Interface	52
Chapter Overview	52
<i>An Introduction to Accessing the Switch Using a Console Connection</i> ..	52
Accessing the Switch Using a Telnet Connection	54
<i>Enabling the Telnet Service</i>	55
<i>Configuring the Telnet Service Port</i>	55
<i>Specifying Telnet Terminals</i>	55
<i>Displaying Trusted Host Telnet Terminals</i>	56
<i>Closing an Active Terminal Session</i>	56
Terminal Settings	56
<i>Configuring the Number of Lines Displayed on Terminal Screen</i>	56
<i>Configuring the Max Number of Characters Displayed per Terminal Line</i> ..	57
<i>Configuring the Terminal Timeout</i>	58
List of Constants and Default Settings	58
Chapter 5-User Account Configuration	59
Chapter Overview	59
<i>An Introduction to Configuring User Accounts</i>	59
Creating User Accounts with Different Privilege Levels	59
<i>Creating User Accounts</i>	59
<i>Displaying the User Accounts Setup on the Switch</i>	60
<i>Displaying Active User Sessions on the Switch</i>	61
Creating and Configuring Enabled Passwords	61
<i>Creating an Enabling Password</i>	61
<i>Displaying Enabled Passwords</i>	62
<i>Logging into the Switch with a Different User Account</i>	62
<i>Encrypting Passwords</i>	63
List of Constants and Default Settings	64
Chapter 6-Accessing the Web Interface (Web UI)	65
Chapter Overview	65
<i>An Introduction to Accessing the Switch using the Web Interface</i>	65
Configuration Commands	65
List of Constants and Default Settings	67
Chapter 7-Time Configuration	68
Chapter Overview	68
<i>An Introduction to Time Configuration</i>	68
Configuration Commands	68
<i>Manual Configuration of Time</i>	68
<i>Automatic Configuration of Time</i>	69
<i>Configuring Summer Time</i>	70
List of Constants and Default Settings	71
Chapter 8-DGS-6600 Default Metric	73
Chapter Overview	73
.....	73

Part 2- Interface and Hardware Configurations

Chapter 9-Interface Configuration	75
Chapter Overview	75
<i>An Introduction to Interface Configuration</i>	76
Identification of an Interface	76
<i>Switch Port Interface</i>	76
<i>Port Channel Interface</i>	76
<i>VLAN Interface</i>	76
<i>Out-of-Band (OOB) Management Port Interface</i>	76
Configuration Commands	77
<i>Entering Interface Configuration Mode</i>	77
<i>Adding a Description to an Interface</i>	77
<i>Removing a Description from an Interface</i>	78
<i>Displaying Interface Status</i>	78
Configuring Switch Port Interfaces	79
<i>Configuring Duplex Mode</i>	80
<i>Configuring Flow Control</i>	80
<i>Configuring Speed</i>	80
<i>Shutting Down an Interface</i>	81
<i>Configuring the Maximum Allowed Frame Size</i>	81
<i>Configuring the MTU</i>	82
<i>Clearing Counters</i>	82
Configuring VLAN Interfaces	83
<i>Configuring the MTU on a VLAN Interface</i>	83
Configuring the OOB Management Interface	83
<i>Configuring an IP Address on the Management Interface</i>	84
<i>Configuring a Default Gateway on the OOB Management Interface</i>	84
<i>Configuring the IP MTU on the OOB Management Interface</i>	85
<i>Configuring an IPv6 Address on the OOB Management Interface</i>	85
<i>Configuring a IPv6 Default Gateway on the OOB Management Interface</i>	86
<i>Shutting Down the Management Interface</i>	86
<i>Displaying the OOB Management Port Interface Status</i>	87
List of Constants and Default Settings	87

Part 3- Layer 2 Configurations

Chapter 10-VLAN Configuration	89
Chapter Overview	89
<i>An Introduction to VLAN</i>	89
<i>Packet Classification</i>	90
VLAN Configuration Commands	90
Configuration Examples	96
<i>VLAN Configuration Examples</i>	96
Relations with Other Modules	98
List of Constants and Default Settings	98
Chapter 11-VLAN Tunneling	99
Chapter Overview	99
<i>An Introduction to VLAN Tunneling</i>	99

<i>VLAN Encapsulation</i>	100
<i>VLAN Remarking</i>	101
<i>CoS Remarking</i>	101
<i>Packet Forwarding Flow</i>	101
<i>UNI to NNI or UNI to UNI Forwarding</i>	102
<i>NNI to UNI or NNI to NNI Forwarding</i>	104
VLAN Tunneling Configuration Commands	107
Configuration Examples	112
<i>QinQ Configuration Example</i>	112
List of Constants and Default Settings	116
Chapter 12-GARP VLAN Registration Protocol (GVRP) Configuration	117
Chapter Overview	117
<i>An Introduction to GARP</i>	117
GARP Configuration Commands	117
List of Constants and Default Settings	123
Chapter 13-MAC Address Tables	124
Chapter Overview	124
<i>An Introduction to Mac Address Tables</i>	124
Mac Address Configuration Commands	124
Relations with Other Modules	127
List of Constants and Default Settings	127
Chapter 14-Spanning Tree Protocol (STP) Configuration	128
Chapter Overview	128
<i>An Introduction to Spanning Tree Protocol</i>	128
<i>Spanning Tree Protocol (STP) Concepts</i>	128
<i>Rapid Spanning Tree Protocol (RSTP) Concepts</i>	132
<i>Multiple Spanning Tree Protocol Concepts</i>	133
STP Configuration Commands	134
<i>Configuring a Single Spanning Tree Instance</i>	139
<i>Configuring Multiple Spanning Tree Instances</i>	142
<i>Configuring Optional Features</i>	147
Configuration Examples	149
<i>RSTP Configuration example</i>	149
<i>MSTP Configuration Example</i>	152
List of Constants and Default Settings	157
Chapter 15-Link Aggregation	158
Chapter Overview	158
<i>An Introduction to Port Channel Groups and LACP</i>	158
<i>Load Balancing</i>	159
<i>Load Balance Hash Algorithm</i>	159
<i>Port and System Priority</i>	160
Link Aggregation Configuration Commands	160
Configuration Examples	163
<i>Link Aggregation Configuration Example</i>	163
Relations with Other Modules	165
List of Constants and Default Settings	165
Chapter 16-Proxy ARP	166

Chapter Overview	166
<i>An Introduction to Proxy ARP</i>	166
<i>Operation Concept</i>	166
<i>Parameters</i>	166
<i>Per Interface parameter</i>	167
<i>Sanity checks for ARP request</i>	167
<i>Acceptable route</i>	167
Proxy ARP Configuration Commands	167
Chapter 17-Super VLAN	169
Chapter Overview	169
<i>An Introduction to Super VLAN Overview</i>	169
Super VLAN Configuration Commands	170
Configuration Examples	171
<i>Super VLAN Configuration Examples</i>	171
List of Constraints & restrictions	173
List of Constants	173
Chapter 18-Voice VLAN	174
Chapter Overview	174
<i>An Introduction to Voice VLAN</i>	174
Voice VLAN Configuration commands	178
Configuration Examples	180
<i>Voice VLAN Configuration Example</i>	180
Chapter 19-Ethernet Ring Protection Switching (ERPS)	182
Chapter Overview	182
<i>An Introduction to ERPS</i>	182
Configuration Example	186
<i>ERPS Configuration Example</i>	186
Relationship with other modules	191

Part 4- Layer 3 Configurations

Chapter 20-IPv4 Basics	194
Chapter Overview	194
<i>An Introduction to IPv4</i>	194
<i>IPv4 Basics</i>	194
<i>Subnet Masks</i>	195
<i>IPv4 Address Assignment on the DGS-6600 Series Switch</i>	195
IPv4 Basic Configuration Commands	196
Configuration Example	197
<i>Basic Routing (IPV4) Configuration Example</i>	197
Chapter 21-IPv4 Static Route Configuration	199
Chapter Overview	199
<i>An Introduction to IPv4 Static Routing</i>	199
IPv4 Static Routing Configuration Commands	199
Configuration Example	201
<i>Static Routing (IPV4) Configuration Example</i>	201

Chapter 22-Routing Information Protocol (RIP)	204
Chapter Overview	204
<i>An Introduction to RIP</i>	204
RIP Configuration Commands	205
Configuration Examples	213
<i>RIP Configuration Example</i>	213
List of Constants and Default Settings	216
Chapter 23-Open Shortest Path First (OSPF)	217
Chapter Overview	217
<i>An Introduction to OSPF</i>	217
OSPF Configuration Commands	218
<i>Basic Commands and Functions</i>	218
<i>Generating a Default Route</i>	226
<i>Redistributing Routes to OSPF</i>	227
<i>Displaying Border Routers</i>	230
<i>Restarting OSPF</i>	238
Configuration Examples	239
<i>OSPFv2 Configuration (Basic) Example</i>	239
<i>OSPFv2 Configuration Example 2</i>	241
List of Constants and Default Settings	247
Chapter 24-ECMP	248
Chapter Overview	248
<i>An Introduction to ECMP</i>	248
ECMP Overview	248
Configuring ECMP	249
.....	249
Chapter 25-IPv6 Basics	250
Chapter Overview	250
<i>An introduction to Internet Protocol Version 6 (IPv6) Basics</i>	250
IPv6 Configuration Commands	253
.....	255
Chapter 26-IPv6 Static Route Configuration	256
Chapter Overview	256
<i>An Introduction to IPv6 Static Route Configuration</i>	256
IPv6 Static Route Configuration Commands	257
Configuration Example	258
<i>IPv6 Static Route Configuration Example</i>	258
Chapter 27-Routing Information Protocol Next Generation (RIPng)	261
Chapter Overview	261
<i>An Introduction to RIPng</i>	261
RIPng Configuration Commands	266
Configuration Examples	267
<i>RIPng Configuration Example</i>	267
Limitations	269
Chapter 28-Open Shortest Path First Version 3 (OSPFv3)	271
Chapter Overview	271

<i>An Introduction to OSPFv3</i>	271
OSPFv3 Configuration Commands	279
Configuration Examples	280
<i>OSPFv3 Configuration Example</i>	280
Limitations	283
Behavior	283
Chapter 29-IPv6 Tunneling	285
Chapter Overview	285
<i>An Introduction to IPv6 Tunneling</i>	285
<i>Operation concept</i>	285
IPv6 Tunneling Configuration Commands	287
Configuration Examples	287
<i>IPv6 tunneling manual Configuration Example</i>	287
<i>IPv6 tunneling 6to4 Configuration Example</i>	289
<i>IPv6 tunneling ISATAP Configuration Example</i>	291
Chapter 30-Border Gateway Protocol (BGP)	293
Chapter Overview	293
<i>An Introduction to BGP</i>	293
BGP Configuration commands	294
Configuration Examples	324
<i>BGP Configuration Example</i>	324
Chapter 31-Policy Based Route Map (PBR)	331
Chapter Overview	331
An Introduction to Policy Based Route Map	331
PBR Configuration Commands	333
<i>Usage Guideline</i>	334
Configuration example	335
<i>PBR Configuration Example</i>	335
Chapter 32-Virtual Router Redundancy Protocol (VRRP)	339
Chapter Overview	339
<i>An introduction to VRRP</i>	339
VRRP Configuration Commands	343
Configuration Example	344
<i>VRRP Configuration Example</i>	344
<hr/>	
Part 5- Multiprotocol Label Switching (MPLS)	
Chapter 33-Multiprotocol Label Switching (MPLS)	350
Chapter Overview	350
<i>An Introduction to MPLS Authentication</i>	350
<i>MPLS Operation</i>	350
MPLS Configuration Commands	351
Configuration Examples	354
<i>MPLS, LDP (Dynamic Label) Configuration Example</i>	354
<i>MPLS (Static Label) Configuration Example</i>	358
<i>MPLS QoS Configuration Example</i>	362
Configuration Restrictions	367

Chapter 34- Virtual Private Wire Service (VPWS)	368
Chapter Overview	368
<i>An Introduction to VPWS (Virtual Pseudo Wire Service)</i>	368
VPWS Configuration Commands	369
Configuration examples	370
<i>Configuring a VPWS</i>	370
Configuration Restrictions and constants	372
Chapter 35- Virtual Private Lan Services (VPLS)	373
Chapter Overview	373
<i>An Introduction to VPLS</i>	373
VPLS Configuration Commands	375
Configuration Examples	377
<i>MPLS - VPLS Configuration Example</i>	377
Configuration Restrictions and Constants	381

Part 6- Quality of Service (QoS)

Chapter 36-Quality of Service (QoS)	383
Chapter Overview	383
<i>An Introduction to QoS</i>	383
<i>Policing and Color Markers</i>	384
QoS Configuration Commands	384
<i>Scheduling</i>	387
<i>Defining the Policing</i>	388
Configuration Examples	393
<i>Configuring QoS Examples</i>	393
<i>QOS Strict Mode Configuration Example</i>	394
<i>QOS WRR Mode Configuration Example</i>	396

Part 7- Multicast Configurations

Chapter 37-Multicast Configuration	399
Chapter Overview	399
<i>An Introduction to Multicast</i>	399
Multicast Filter Mode Configuration Commands	400
PIM	401
Configuration Examples	403
<i>PIM-DM configuration Examples</i>	403
<i>PIM-SM Configuration Example</i>	405
<i>DVMRP Configuration Example</i>	408
<i>IGMP Snooping Configuration Example</i>	411

Part 8- Security & Authentication

Chapter 38-Access Control Lists (ACL)	414
Chapter Overview	414
<i>An Introduction to Access Control Lists</i>	414

Configuration Overview	415
ACL Configuration Commands	417
<i>Configuring Access Control Lists</i>	418
<i>Applying Access Control Lists to Interfaces</i>	423
Configuration Examples	425
<i>ACL Configuration Example</i>	425
List of Constants and Default Settings	427
Chapter 39-Authentication, Authorization and Accounting (AAA) Configuration	428
Chapter Overview	428
<i>An Introduction to AAA Configuration</i>	428
AAA Configuration Commands	429
<i>Configuring AAA Server Groups</i>	429
List of Constants and Default Settings	432
Chapter 40-802.1X Authentication	433
Chapter Overview	433
<i>An Introduction to 802.1X Authentication</i>	434
<i>Port-based and Host-based Access Control</i>	435
802.1X Configuration Commands	435
<i>Configuring 802.1X Authentication</i>	435
<i>Displaying 802.1X Configuration and Status</i>	443
Configuration Examples	446
<i>802.1x Guest VLAN Configuration Example</i>	446
Relations with Other Modules	448
List of Constants and Default Settings	449
Chapter 41-DoS Protection	450
Chapter Overview	450
<i>An Introduction to DoS Protection</i>	450
DoS Prevention Overview	450
<i>Architecture</i>	450
Operation Concepts	451
<i>Mechanism</i>	451
<i>Actions</i>	451
<i>Attack Types</i>	451
Configuration Commands	452
<i>Configuration Examples</i>	453
Parameters	454
Chapter 42-Dynamic ARP Inspection	455
Chapter Overview	455
<i>An Introduction to Dynamic ARP Inspection</i>	455
Dynamic ARP Inspection Configuration Commands	456
Chapter 43-DHCP Server Screening	458
Chapter Overview	458
<i>An introduction to DHCP Server Screening Configuration</i>	458
<i>DHCP Server Screening</i>	459
<i>DHCP Server Screening Operating Concept</i>	459
DHCP Server Screening/Client Filtering Configuration Commands	460
<i>Configuring DHCP Server Screening/Client Filtering</i>	460

.....	462
DHCP Server Screening Default Settings	463
DHCP Server Screening Limitation	463
Chapter 44-DHCP Snooping Configuration	464
Chapter Overview	464
An Introduction to DHCP Snooping	464
<i>DHCP Operation concept</i>	465
DHCP Snooping Configuration Commands	465
Chapter 45-Port Security	469
Chapter Overview	469
<i>An Introduction to Port Security Configuration</i>	469
Port Security Configuration Commands	470
Relations with Other Modules	470
List of Constants and Default Settings	471
Chapter 46-IP Source Guard	472
Chapter Overview	472
<i>An Introduction to IP Source Guard</i>	472
IP Source Guard Configuration Commands	473
Chapter 47-Safeguard Engine Settings	475
Chapter Overview	475
<i>An Introduction to Safeguard Engine Settings</i>	475
Configuration Commands	477
<i>Configuration Command Examples</i>	477
Chapter 48-Traffic Segmentation Configuration	479
Chapter Overview	479
<i>An Introduction to Traffic Segmentation</i>	479
Traffic Segmentation Configuration Commands	479
<i>Configuring Traffic Segmentation</i>	479
Configuration Examples	480
<i>Traffic Segmentation Configuration Example</i>	480
Relations with Other Modules	482
List of Constants and Default Settings	482

Part 9- Network Application

Chapter 49-DHCP Server Configuration	484
Chapter Overview	484
<i>An Introduction to DHCP SERVER</i>	484
<i>Architecture</i>	485
<i>Operation concept</i>	485
<i>Selecting IP address pool</i>	486
<i>DHCP DISCOVER/REQUEST with 'requested IP address</i>	486
<i>Choosing IP address in address pool</i>	487
<i>Responding DHCP DISCOVER/REQUEST packet</i>	487
<i>Receiving DHCP DECLINE</i>	487
<i>Sending back DHCP packet to client</i>	487

<i>PING operation</i>	487
<i>Behavior under multi-netting</i>	487
<i>DHCP server and DHCP relay agent global mode</i>	488
<i>High availability in DHCP server</i>	488
DHCP Server Configuration Commands	488
<i>Configuring a DHCP Address Pool</i>	489
Limitations	497
Chapter 50-DHCP Relay Configuration	498
Chapter Overview	498
<i>An Introduction to DHCP Relay Agent Operation</i>	498
DHCP Relay Configuration Commands	500
<i>Configuring the Relay Agent Information Option</i>	501
<i>Configuring Trusted Interfaces</i>	503
List of Constants and Default Settings	505
Chapter 51-DHCPv6 Client Configuration	506
Chapter Overview	506
<i>An Introduction to the DHCPv6 Client</i>	506
<i>Operation concept</i>	506
<i>Protocol and Addressing</i>	507
<i>Basic Message Format</i>	508
<i>Message Types</i>	509
<i>Prefix Delegation</i>	511
<i>Restrictions</i>	512
<i>Rapid Commit</i>	512
<i>Address Information Refresh</i>	512
DHCPv6 Configurations Commands	513
Default Settings	519
Restriction/Limitation	519
Chapter 52-sFlow	521
Chapter Overview	521
<i>An Introduction to sFlow</i>	521
sFlow Design Overview	522
Configuration Commands	524
<i>Configuration Command Examples</i>	524
sFlow Configuration Example	525

Part 10- Network Management

Chapter 53-Simple Network Management Protocol (SNMP)	528
Chapter Overview	528
<i>An Introduction to SNMP Overview</i>	528
<i>User-based Security Model</i>	529
<i>View-based Access Control Model</i>	529
SNMP Configuring Commands	529
Configuration Examples	537
<i>SNMPv2 With Trap Configuration Example</i>	537
<i>SNMP v3 with trap Configuration Example</i>	538
List of Constants and Default Settings	541

Chapter 54-RMON	542
Chapter Overview	542
<i>An Introduction to RMON</i>	542
RMON Overview	542
<i>Configuring rmon statistics</i>	544
Configuration Examples	544
<i>RMON Configuration Example</i>	544
Relations with Other Modules	546
List of Constants and Default Settings	546
Chapter 55-Error Disable Port Recovery	547
Chapter Overview	547
<i>An introduction to Error Disable Port Recovery</i>	547
Error Disable Port Recovery Configuration Commands	547
List of Constants and Default Settings	548
Chapter 56-Traffic Storm Control	549
Chapter Overview	549
<i>An Introduction to Traffic Storm Control</i>	549
Traffic Storm Configuration Commands	550
Relations with Other Modules	552
List of Constants and Default Settings	552

Part 11- System Management

Chapter 57-File System	555
Chapter Overview	555
<i>An Introduction to the File System</i>	555
File System Configuration Commands	556
<i>Loading Configuration Files</i>	564
<i>Managing Image Files</i>	566
<i>Loading Image Files</i>	568
List of Constants and Default Settings	570

Part 12- Troubleshooting

Chapter 58-Displaying System Information	572
Chapter Overview	572
<i>An Introduction to Displaying Information</i>	572
<i>Information Categories</i>	572
Displaying System Information Configuration Commands	573
Chapter 59-Logging System Messages	580
Chapter Overview	580
<i>An Introduction to Logging System Messages</i>	580
<i>Logging System Messages Configuration Commands</i>	581
List of Constants and Default Settings	585
Chapter 60-Port Mirroring	586
Chapter Overview	586

<i>An Introduction to Port Mirroring</i>	586
Port Mirroring Configuration Commands	586
Configuration Examples	588
<i>Mirror Configuration Example</i>	588
Relations with Other Modules	589
List of Constants and Default Settings	589
Chapter 61-Remote Switching Port Analyzer (RSPAN)	590
Chapter Overview	590
<i>An Introduction to RSPAN</i>	590
RSPAN Configuration Commands	592
Configuration Examples	594
<i>RSPAN Configuration Example</i>	594
Relationship with other modules in the DGS-6600-Series Switch.	596
Chapter 62-Testing Network Connectivity	598
Chapter Overview	598
Testing Connectivity to a Specific Destination.	598
Tracing the Route to a Specific Destination	599
Chapter 63-Debug Information to Compact Flash	601
Chapter Overview	601
Updating Debug information to cf2, Overview	601
<i>Terminology</i>	601
<i>Configuration Steps</i>	601

Chapter 1

DGS-6600 Series Switch Product Summary

Chapter Overview

The following topics are included in this chapter, please go to the topic for more detailed information:

- [Chapter Overview](#)
- [An Introduction to the DGS-6600 Series Switch](#)
 - [Components and Hardware](#)
 - [Chassis](#)
 - [Module Plug-in Frame](#)
- [Module List](#)
 - [DGS-6600-CM](#)
 - [DGS-6600-CM-II](#)
 - [DSG-6600-24SC2XS I/O Card](#)
 - [DGS-6600-48P I/O Card](#)
 - [DGS-6600-48T I/O Card](#)
 - [DGS-6600-48S I/O Card](#)
 - [DGS-6600-48TS I/O Card](#)
 - [DGS-6600-8XG I/O Card](#)
- [Supported User Interfaces](#)

An Introduction to the DGS-6600 Series Switch

The D-Link's DGS-6600 series switch is a modular, chassis-based Ethernet backbone switch. It is designed to be adaptable and scalable, it's intended to be used in a variety of different network designs and to be upgradable as those network designs change and mature. Currently, the DGS-6600 series chassis is available in a 4-slot chassis (DGS-6604) and 8-slot chassis (DGS-6608) design.

The DGS-6600 switch provides a management platform, it has a backplane switch capacity of either; 576Gbps for the DGS-6604 or 1152Gbps for the DGS-6608. The backplane switch capacities are per Management Module. The DGS-6604 chassis has 4 slots. These slots are designed to hold, one management module and three line card modules. The DGS-6608 chassis has 8 slots. These slots are designed to hold two management modules and six line card modules.

All of the supported modules are capable of being hot-swapped, this allows the module configuration to be changed while the power is on, with minimal disruption to the operating system.

The DGS-6600 chassis provides a built-in power shelf that is designed to support, depending upon which chassis type is used (DGS-6604 or DGS-6608), up to four (DGS-6604) or eight (DGS-6608) redundant power modules. Multiple redundant power modules are designed to enable continuous operation in the event of a power module failure.

Components and Hardware

The D-Link's DGS-6600 series switch is a modular, chassis-based Ethernet backbone switch designed for adaptability and scalability. Currently, the DGS-6600 series chassis is available in a 4-slot chassis (DGS-6604) and an 8-slot chassis (DGS-6608).

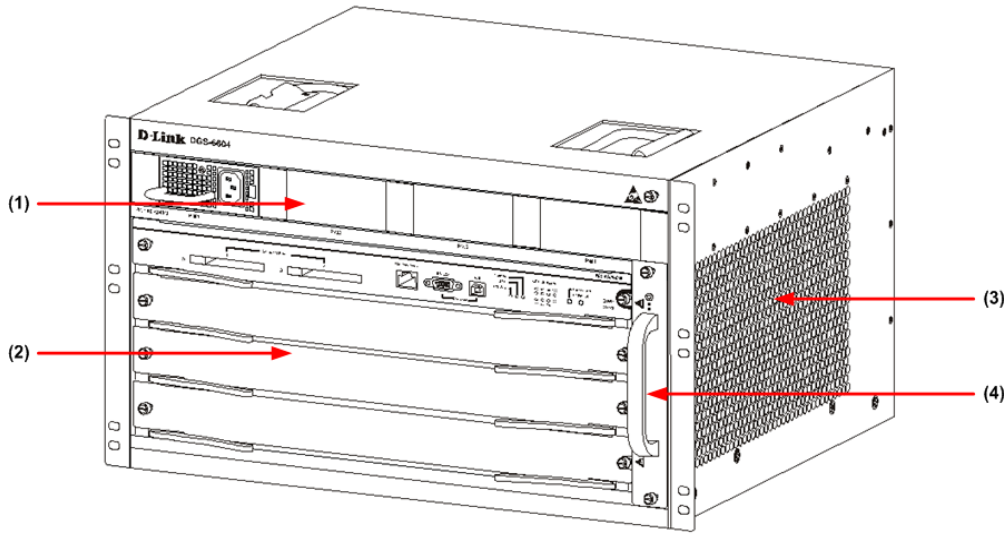

Figure 1-1 DGS-6604 Product Appearance

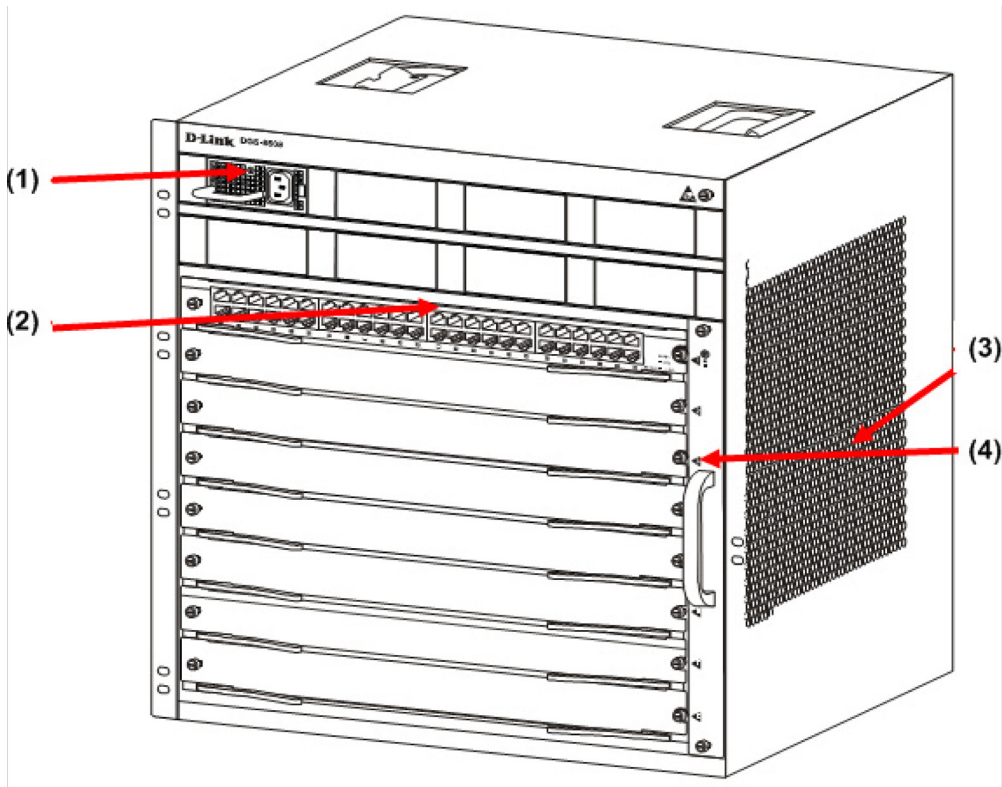

Figure 1-2 DGS-6608 Product Appearance

Chassis

The DGS-6604 uses a standard 19-inch chassis, which has a height of 280mm, a width of 484mm, and a depth of 470mm. The chassis consists of the system module layer, fan layer, and power layer. The layer that handles system modules consists of a module plug-in frame, which is used for connecting the various DGS-6604 modules. The built-in power shelf is located at the top of the chassis. The fan tray is located on the right-hand side of the chassis. The fan tray consists of eight fans. The dimension of each fan is 80x80x20mm.

The DGS-6608 chassis consists of the system module layer, fan layer, and power layer. The layer that handles system modules consists of a module plug-in frame, which is used for connecting the various DGS-6608 modules. The built-in power shelf is located at the top of the chassis. The fan tray is located on the right-hand side of the chassis. The fan tray consists of sixteen fans. The dimension of each fan is 80x80x20mm.

Module Plug-in Frame

The module plug-in frame of the DGS-6604 consists of the module slots and the backplane. The DGS-6604 supports four module slots. The slot at the top of the Switch can only be used for the control management module. The other three slots can be used to connect to various line cards. All the modules supported by the DGS-6604 are of the same height, width and depth. The dimensions of each module are a height of 42mm, a width of 388mm, and a depth of 422mm. The modules of the DGS-6604 are inserted into the Switch horizontally. The backplane of the DGS-6604 is used to interconnect the control management card and the line cards that have been installed in the Switch.

When the slots of the DGS-6604 are fully populated, the modules of the DGS-6604 will have the following layout:

- One control management module.
- Three line card modules to meet the network requirements.

The slot number used for the Control Management module is 1. Slots 2, 3, and 4 are used for line card modules.

The module plug-in frame of the DGS-6608 consists of the module slots and the backplane. The DGS-6608 supports eight module slots. The slots 4 and 5 of the Switch can only be used for the control management module. The other six slots can be used to connect to various line cards. All the modules supported by the DGS-6608 are of the same height, width and depth. The dimensions of each module are a height of 42mm, a width of 388mm, and a depth of 422mm. The modules of the DGS-6608 are inserted into the Switch horizontally. The backplane of the DGS-6608 is used to interconnect the control management card and the line cards that have been installed in the Switch.

When the slots of the DGS-6608 are fully populated, the modules of the DGS-6608 will have the following layout:

- Two control management module.
- Six line card modules to meet the network requirements.

The slot number used for the Control Management module is 4 and 5. Slots 1-3 to 6-8 are used for line card modules.

Module List

The DGS-6604/6608 supports the modules described below:

Model Name	Type	Description	Compatibility
DGS-6600-CM	Control Module	The Control Module is a CPU module for the DGS-6604. The CPU module is used to control the whole system. The DGS-6604 only supports 1 control module.	DGS-6604
DGS-6600-CM-II	Control Module	The DGS-6600-CM-II is a CPU module for the DGS-6604/6608. The DGS-6608 is able to support 2 control modules.	DGS-6604/DGS-6608
DGS-6600-24SC2XS	I/O Module	The DGS-6600-24SC2XS has 12 SFP ports, 12 combo ports (10/100/1000Base-T/SFP Module) and 2 SFP+ ports.	DGS-6604
DGS-6600-16XS	I/O Module	The DGS-6600-16XS has 16x 10G SFP ports +.	DGS-6604/DGS-6608
DGS-6600-48P	I/O Module	The DGS-6600-48P has 48x 10/100/1000 RJ-45 Ports and PoE.	DGS-6604/DGS-6608
DGS-6600-48S	I/O Module	The DGS-6600-48S has 48x SFP interfaces.	DGS-6604/DGS-6608
DGS-6600-48T	I/O Module	The DGS-6600-48T has 48x 10/100/1000 RJ-45 ports.	DGS-6604/DGS-6608
DGS-6600-48TS	I/O Module	The DGS-6600-48TS has 24x 10/100/1000 Base-T and 24x SFP ports module interfaces.	DGS-6604/DGS-6608
DGS-6600-8XG	I/O Module	This module has 8x 10G XFP module interfaces.	DGS-6604

Table 1-1 List of supported modules

DGS-6600-CM



Figure 1-3 DGS-6600-CM

Compact Flash Slot

The DGS-6600-CM Control Module has two compact flash slots (CF1 and CF2). Install a card in the compact flash slot 1 to store the system configuration, log, and runtime image files. Slot 2 is for debugging purposes (please see [“Debug Information to Compact Flash”](#) on page 601)

The LED indicator will flash green when data from the compact flash card is being accessed.

Management Port

The DGS-6600-CM Control Module is equipped with an auxiliary Gigabit Ethernet port for out-of-band management. The IP address configured on the management port can be in the same domain as the one assigned to the I/O module.

UART Console Interface

The DGS-6600-CM front panel provides two types of UART Console Interface, an RS-232 connector and a USB connector. These two interfaces are mutually exclusive, with the USB interface having a higher priority. If the Switch is currently being managed via the RS-232 console connection and a USB connection is established, the CLI engine will use the USB connection and automatically disconnect the user who is connected to the Switch via the RS-232 console connection.

The switching between the RS-232 and USB console connection is automatically controlled by the firmware. However, this feature is disabled during system bootup. Therefore, it is strongly recommended not to change the console connection interface during system bootup, as important bootup information may be missed.

In order to use the USB console interface the host will need to have a terminal emulation application (e.g., Hyper Terminal, Teraterm etc.) installed and the correct USB driver for the Switch.



NOTE: The terminal emulation application may need to be restarted if the USB cable is disconnected and plugged it back into the host the Switch is being accessed from.

DGS-6600-CM-II



Figure 1-4 DGS-6600-CM-II

Compact Flash Slot

The DGS-6600-CM-II Control Module has two compact flash slots (CF1 and CF2). Install a card in the compact flash slot 1 to store the system configuration, log, and runtime image files. Slot 2 is for debugging purposes (please see [“Debug Information to Compact Flash”](#) on page 601)

The LED indicator will flash green when data from the compact flash card is being accessed.

Management Port

The DGS-6600-CM-II Control Module is equipped with an auxiliary Gigabit Ethernet port for out-of-band management. The IP address configured on the management port can be in the same domain as the one assigned to the I/O module.

UART Console Interface

The DGS-6600-CM-II front panel provides two types of UART Console Interface, an RS-232 connector and a USB connector. These two interfaces are mutually exclusive, with the USB interface having a higher priority. If the Switch is currently being managed via the RS-232 console connection and a USB connection is established, the CLI engine will use the USB connection and automatically disconnect the user who is connected to the Switch via the RS-232 console connection.

The switching between the RS-232 and USB console connection is automatically controlled by the firmware. However, this feature is disabled during system bootup. Therefore, it is strongly recommended not to change the console connection interface during system bootup, as important bootup information may be missed.

In order to use the USB console interface the host will need to have a terminal emulation application (e.g., Hyper Terminal, Teraterm etc.) installed and the correct USB driver for the Switch.



NOTE: The terminal emulation application may need to be restarted if the USB cable is disconnected and plugged it back into the host the Switch is being accessed from.

DSG-6600-24SC2XS I/O Card



Figure 1-5 DGS-6600-24SC2XS

DGS-6600-48P I/O Card



Figure 1-6 DGS-6600-48P

DGS-6600-48T I/O Card



Figure 1-7 DGS-6600-48T I/O Card

DGS-6600-48S I/O Card



Figure 1-8 DGS-6600-48S I/O Card

DGS-6600-48TS I/O Card



Figure 1-9 DGS-6600-48TS I/O Card

DGS-6600-8XG I/O Card

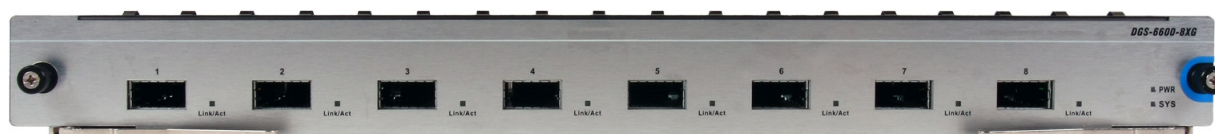

Figure 1-10 DGS-6600-8XG I/O Card

Supported User Interfaces

The Switch can be configured using the following methods:

- Command-Line Interface
- MIB Browser

Chapter 2

Quick Start

Chapter Overview

The following topics are included in this chapter, please go to the topic for more detailed information:

- [Chapter Overview](#)
 - [An Introduction to Quickly Setting Up the DGS-6600 Series Switch](#)
- [Preparation for Installation](#)
 - [Static Discharge Damage Prevention](#)
 - [Moving the Device](#)
 - [System Grounding Requirements](#)
 - [Simple Grounding Steps](#)
- [Installation Site Requirements](#)
 - [Ventilation Requirements](#)
- [Removing and Installing Modules from the DGS-6600 Series Switch](#)
 - [Removing Modules from the DGS-6600](#)
 - [Installing Modules in the DGS-6604 & DGS-6608](#)
- [Configuring the Connection To The Switch](#)
 - [Connecting a Terminal to the Console Port](#)
 - [SNMP-Based Management](#)

An Introduction to Quickly Setting Up the DGS-6600 Series Switch

The following chapter discusses how to create user accounts on the Switch. User accounts can be used to protect access to the command-line interface. The user can create several user accounts with different access-levels.

Preparation for Installation

To ensure normal operation and to prolong the lifespan of the DGS-6600, the appropriate temperature and humidity must be maintained in the equipment room (please see [Table 2-1 on page 25](#)).

If the equipment room's temperature and humidity do not meet the specified requirements the equipment may sustain damage.

Operating Temperature	Operating Humidity
0°C-50°C	10%-90% RH non-condensed

Table 2-1



Note:

The ambient temperature and humidity should be measured at a point that is 1.5m above the floor and 0.4m in front of the equipment when there is no protective plate in the front or back of the equipment rack.

Static Discharge Damage Prevention

To prevent damage from static electricity, please use the following guidelines:

- Be sure to install an adequate ground for all electronic equipment.
- Use appropriate dust prevention measures.
- Maintain the required humidity in the operating environment.
- Hold circuit boards by their edges. Do not touch any components on the printed circuit board (PCB).
- Always wear an anti-static wrist strap when working near any electronic circuitry.
- Do not allow clothing to touch circuit boards. An antistatic wrist strap will only prevent static electricity from the human body, it will not reduce the static electricity build up on clothing.

Moving the Device

The DGS-6600 series Switch is quite heavy. When handling, please use the following guidelines:

- Avoid moving the equipment frequently.
- Seek assistance in lifting if the weight of the chassis is more than you can lift safely alone.
- Lift and move the chassis using the handles on the top panel (please see [Table 2-1 on page 27](#)).
- Turn off all power supplies and unplug all power cables before moving the equipment.
- Completely loosen the thumb/Phillips screws and pull the card levers to remove each and all line cards, fan tray, and power modules from the chassis before moving the chassis.

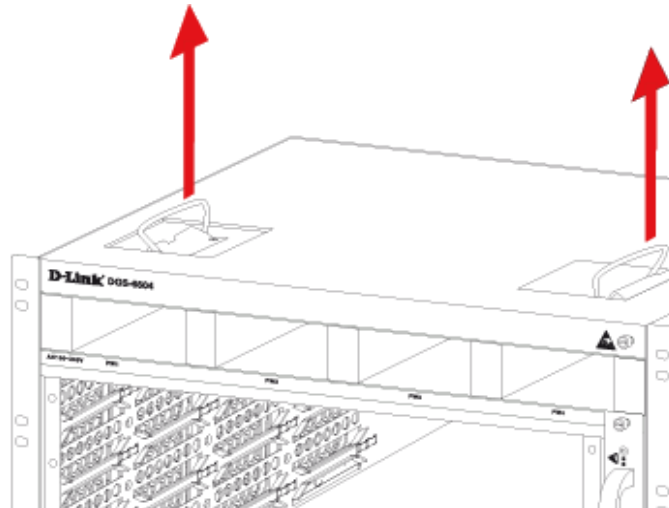

Figure 2-1

System Grounding Requirements

Proper grounding will help to ensure the stable and reliable operation of the DGS-6600 series switch. Be sure to verify that the grounding conditions meet the grounding requirements and all devices are grounded appropriately before using the DGS-6600 series switch.

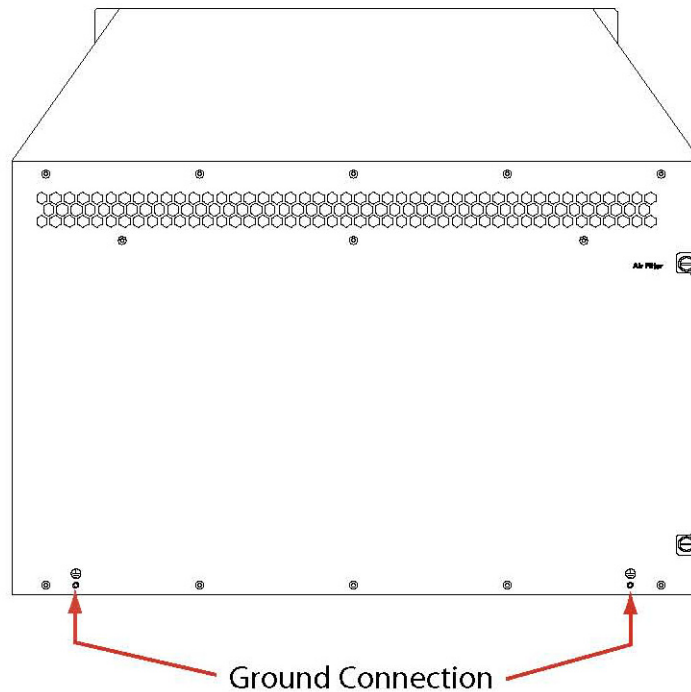

Figure 2-2

Simple Grounding Steps

- Unfasten the nut on the rear grounding post of the equipment.
- Affix the terminal of the grounding cable to the grounding pole.
- Fasten the nut back on the grounding post.
- Connect the other end of the grounding cable to a suitable grounding bar.

Installation Site Requirements

The DGS-6600 series switch must be used indoors. To ensure normal operation and to prolong the lifespan of the equipment, the installation site must meet the following requirements:

Requirements for Rack Mounting:-

If you plan to mount the DGS-6600 in a frame, please use the following guidelines:

- Install the switch in an open cabinet if possible. If you install the switch inside a closed cabinet please ensure that the cabinet has a good ventilation and heat dissipation system.
- Ensure that the cabinet is durable enough to bear the weight of the DGS-6600 and its installed components.
- Ensure that the dimensions of the cabinet provide enough space for the installation of the front, rear, left and right panels of the DGS-6600 for the purpose of heat dissipation.
- The frame should be properly grounded.

Ventilation Requirements

[Table 2-3 on page 29](#) shows the ventilation requirements of the DGS-6600. You must allow sufficient space near the vents to ensure proper ventilation.

After the cables have been connected, they should be arranged into bundles or placed on the cabling rack to prevent the obstruction of air intakes and vents.

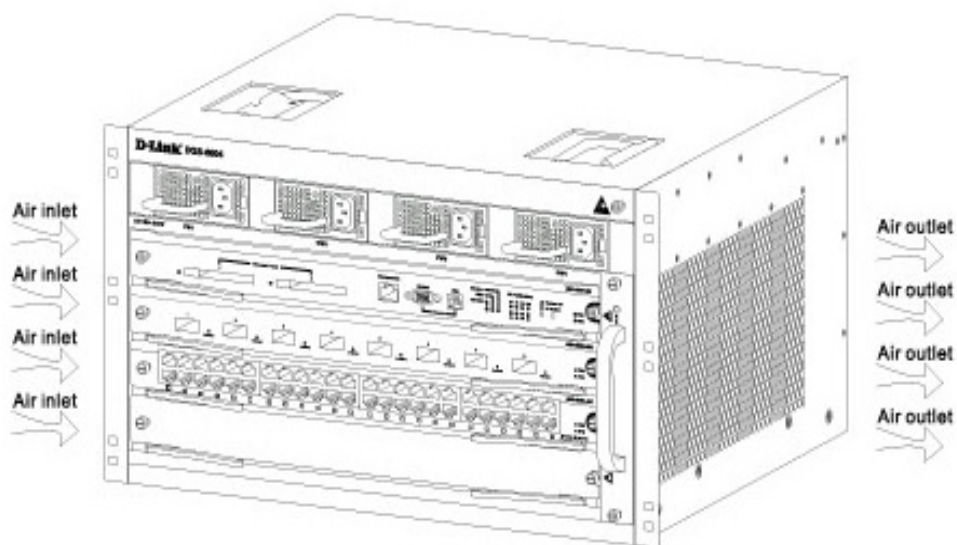

Figure 2-3

Removing and Installing Modules from the DGS-6600 Series Switch

Removing Modules from the DGS-6600

- Unplug all copper/fibre cabling, i.e. RJ45 twisted-pair and fibre optic cables from the module to be removed.
- Loosen and unscrew the panel's two captive screws.
- Use both hands to pull the levers, on the left and right hand sides of the board, to remove the module from the DGS-6600.

Installing Modules in the DGS-6604 & DGS-6608

- Remove the component card or blank panel as instructed in the section Removing Modules from the DGS-6600
- Insert the new module into the guide rail of the vacant slot.
- Use the levers on the left and right hand side to push the board into position and tighten the two captive screws on the module using a straight screw driver.

Configuring the Connection To The Switch

Connecting a Terminal to the Console Port

Connect the supplied RJ-45-to DB-9 adapter cable to the standard 9-pin serial port on the PC. Connect the other end of the cable to the console port on the switch. Set the terminal emulation software as follows:

```
Baud rate: 115200
Data bits: 8
Parity: None
Stop bits: 1
Flow control: None
Select VT100 for the terminal emulation mode
```

After you have correctly set up the terminal, plug the power cable into the power supply on the switch. The boot sequence will appear in the terminal.

Press the Enter key at the password prompt. There is no default password for the Switch.

Enter the commands to complete your desired tasks. Many commands require administrator-level access privileges. See the Command Line Interface (CLI) Reference Guide on the documentation CD for a list of all commands and additional information using the CLI.

Telnet Management Users may also access the switch CLI by using the PC's Command Prompt. To access it from the PC, users must first ensure that a valid connection is made through the Ethernet port of the Switch and the PC, then click Start > Programs > Accessories > Command Prompt on the PC. Once the console window opens, enter the command telnet 10.90.90.90 (depending on configured IP address) and press Enter on the keyboard. The user should be directed to the opening console screen for the CLI of the switch, press the Enter key at the password prompts. There is no default password for the Switch.

SNMP-Based Management

The Switch can be managed with D-Link D-View or any SNMP-compatible console program. The SNMP function is disabled by default for D-Link managed switches.



Part 1- Configuration Fundamentals

The following chapters are included in this volume:

- **Command-Line Interface (CLI)**
- **Accessing the Command Line Interface**
- **User Account Configuration**
- **Accessing the Web Interface (Web UI)**
- **Time Configuration**
- **DGS-6600 Default Metric**

Chapter 3

Command-Line Interface (CLI)

Command-Line Interface Overview

The following topics are included in this chapter, please go to the topic for more detailed information:

- [Command-Line Interface Overview](#)
 - [An Introduction to the Command-Line Interface](#)
 - [Command Mode and User Privilege Level](#)
- [User EXEC Mode Configuration Commands](#)
 - [Help Features](#)
 - [Editing Features](#)
 - [Using Abbreviated Commands](#)
 - [Error Messages](#)
 - [Command Prompt](#)
 - [Login Banner](#)
 - [Establishing a Telnet Connection to a Remote Device](#)
 - [Common Parameter Syntax Conventions](#)
 - [Allowed Character Strings And String Examples](#)
 - [Time and Date Configuration](#)

An Introduction to the Command-Line Interface

The command-line interface (CLI) is a user interface that is available for inputting commands to manage the Switch. Users can access the CLI using either the local console or a remote console. This chapter describes the different features of the command-line interface that are available when configuring the Switch.

Command Mode and User Privilege Level

There are several command modes available in the command-line interface (CLI). The set of commands available, to the user, depends upon two factors, the mode the user is currently in and their privilege level. For each case, the user can see all the commands that are available when in a particular command mode by entering a question mark (?) at the system prompt.

The command-line interface has four privilege levels:

- **Basic User-** Privilege Level 1. This user account level has the lowest priority of the user accounts and is allowed to use, system show commands in, the terminal control interface. The purpose of this type of user account level is for basic system checking. This user account can only show limited information that is not related to security. The most important limitation of this account is that there is no way of changing the access right level.
- **Advanced User-** Privilege Level 2. This user account level allowed to use the terminal control interface to enter, some, privileged EXEC mode configurations.

- **Power User**- Privilege Level 12. This user account level is used to grant system configuration rights for users who need to change or monitor system configuration, except for security related information such as user accounts and SNMP account settings, etc.
- **Administrator**- Privilege Level 15. This administrator user account level can monitor all system information and change any of the system configuration settings expressed in this configuration guide.

The command-line interface has three basic command modes:

- **User EXEC mode**
- **Privileged EXEC mode**
- **Global Configuration mode**

All other sub-configuration modes can be accessed via global configuration mode.

When a user logs in to the Switch, the privilege level of the user determines the command mode the user will enter after their initial log in. The user will either log into user EXEC mode or privileged EXEC mode. Users with a basic user and advanced user level will log into the Switch in user EXEC mode. Users with power user and administrator level accounts will log into the Switch in privileged EXEC mode. Therefore, user EXEC mode can operate at either basic user level or advanced user level, and privileged EXEC mode can operate at either power user level or administrator level. The user can only enter global configuration mode from privileged EXEC mode. Therefore, global configuration mode can be accessed by users who have power user or administrator level user accounts. As for sub-configuration modes, a subset of those can only be accessed by users who have the highest secure administrator level privileges.

In user EXEC mode at advanced user level, the user is allowed to enter privileged EXEC mode by entering the enable password. In privileged EXEC mode, the user is allowed to exit to the user EXEC mode at advanced user level by entering the **disable** command. The **enable password** and **disable** commands are functions that can be used to switch between user EXEC mode and privileged EXEC mode.

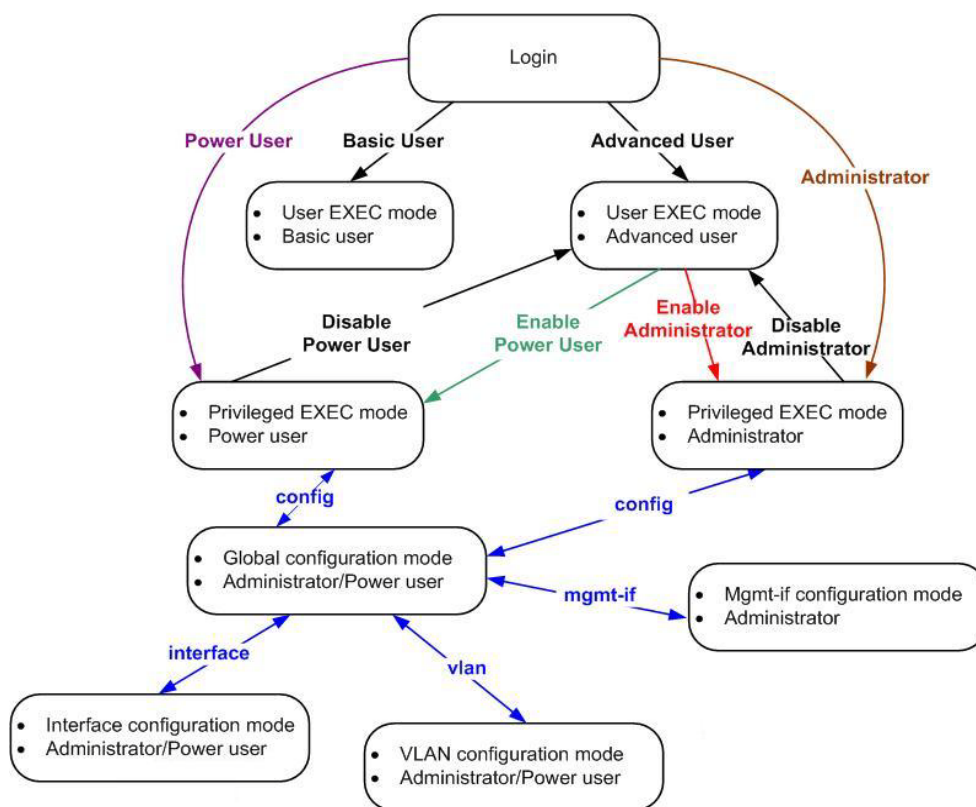

Figure 3-1 Command Mode State Diagram



NOTE: Not all configuration modes are listed in the above figure. For example, in global configuration mode, enter **“router ospf”** to enter OSPF router configuration mode

Table 2-1 describes in brief the available command modes. Only the basic command modes and some of the sub-configuration modes are enumerated. The basic command modes and basic sub-configuration modes are further described in the following chapters. Descriptions for the rest of the sub-configuration modes are not provided in this section. For more information on the additional sub-configuration modes, the user should refer to the chapters relating to these functions.

The available command modes and privilege levels are described below:

Command Mode & Privilege Level	Purpose
User EXEC mode at Basic User level	For checking basic system settings, allowing users to change the local terminal session settings, and verifying basic network connectivity. Checking security related settings is not allowed at this command mode and privilege level.
User EXEC mode at Advanced User level	This level has almost the same access rights as user EXEC mode at basic user level, except that a user in this mode and at this level can enter privileged EXEC mode by entering the enable command.
Privileged EXEC mode at Power User level	For changing both local and global terminal settings, monitoring, and performing certain system administration tasks. The system administration tasks that can be performed at this level includes the clearing of system configuration settings, except for any security related information, such as user accounts, SNMP account settings etc.
Privileged EXEC mode at Administrator level	This level is identical to privileged EXEC mode at power user level, except that a user at the administrator level can monitor and clear security related settings.
Global Configuration Mode at Power User level	For applying global settings, except for security related settings, on the entire Switch. In addition to applying global settings on the entire Switch, the user can access other sub-configuration modes from global configuration mode.
Global Configuration Mode at Administrator level	For applying global settings on the entire Switch. In addition to applying global settings on the entire Switch, the user can access other sub-configuration modes from global configuration mode.
Interface Configuration Mode at Power User level	For applying interface related settings.
VLAN Interface Configuration Mode	For applying VLAN interface related settings.
VLAN Configuration Mode	For applying settings to a VLAN.
IP Access-List Configuration Mode	For specifying filtering criteria for an IP access list.

Table 3-1 Command Modes and Privilege Levels

User EXEC Mode Configuration Commands

User EXEC Mode at Basic User Level

This command mode is mainly designed for checking basic system settings, allowing users to change the local terminal session settings and carry out basic network connectivity verification. One limitation of this command mode is that it cannot be used to display information related to security. The most significant limitation of this command mode is that there is no way of changing the access right level of the logged in user.

This command mode can be entered by logging in as a basic user.

User EXEC Mode at Advanced User Level

User EXEC mode at advanced user level has the same purpose as user EXEC mode at basic user level, except that user EXEC mode at advanced user level is allowed to use the **enable** command to enter privileged EXEC mode.

This command mode can be entered by logging in as an advanced user or by using the **disable** command in privileged EXEC mode.

In the following example, the user is currently logged in as an advanced user in privileged EXEC mode and uses the **disable** command to return to user EXEC mode at advanced user level:

```
DGS-6600:15#disable
DGS-6600:2>
```

Privileged EXEC Mode at Power User Level

Users logged into the Switch in privileged EXEC mode at this level can change both local and global terminal settings, monitor, and perform system administration tasks like clearing configuration settings (except for security related information such as user accounts, SNMP account settings etc.)

There are two methods that a user can use to enter privileged EXEC mode at power user level. The first method is to login to the Switch with a user account that has a privilege level of 12. The other method is to use the **enable privilege LEVEL** command in user EXEC mode.

In the following example, the user enters privileged EXEC mode at power user level by logging in with a user account called "power-user" that has a privilege level of 12:

```
User Access Verification
```

```
Username: power-user
Password:
```

```
DGS-6600 Chassis-based High-Speed Switch
Command Line Interface
```

```
Firmware: 2.10.011
```

```
Copyright (c) 2012 D-Link Corporation. All rights reserved.
```

```
DGS-6600:12#
```

In the following example, the user enters the **enable privilege LEVEL** command in user EXEC mode to enter privileged EXEC mode at Power User level:

```
DGS-6600:2>enable privilege 12
DGS-6600:12#
```

Privileged EXEC Mode at Administrator Level

This command mode has a privilege level of 15. Users logged in with this command mode can monitor all system information and change any system configuration settings mentioned in this Configuration Guide.

There are two methods that a user can use to enter privileged EXEC mode at administrator level. The first method is to login to the Switch with a user account that has a privilege level of 15. The second method requires a user to login to the Switch in as a user with an advanced user or power user level and use the **enable privilege LEVEL** command.

In this command mode, the user can return to user EXEC mode at an advanced user level by entering the **disable** command.

In the following example, the user is currently logged in as an administrator in privileged EXEC mode and uses the **disable** command to return to user EXEC mode at an advanced user level:

```
DGS-6600:15#disable
DGS-6600:2>
```

In the following example, the user enters the **enable privilege LEVEL** command in privileged EXEC mode at power user level to enter privileged EXEC mode at an administrator level:

```
DGS-6600:12#enable privilege 15
DGS-6600:15#
```

Global Configuration Mode

The primary purpose of global configuration mode is to apply global settings on the entire Switch. Global configuration mode can be accessed at both power user and administrator level. However, security related settings are not accessible at power user level. In addition to applying global settings on the entire Switch, the user can also access other sub-configuration modes.

In order to access global configuration mode, the user must be logged in as an administrator or power user and use the **configure terminal** command in privileged EXEC mode.

In the following example, the user is logged in as an Administrator in privileged EXEC mode and uses the **configure terminal** command to access global configuration mode:

```
DGS-6600:15#configure terminal
DGS-6600:15 (config)#
```

The **exit** command is used to exit global configuration mode and return to privileged EXEC mode.

The procedures to enter the different sub-configuration modes can be found in the related chapters in this Configuration Guide. The command modes are used to configure the individual functions.

Interface Configuration Mode

Interface configuration mode is used to configure the parameters for an interface or a range of interfaces. An interface can be a physical port, VLAN, or other virtual interface. Thus, interface configuration mode is distinguished further according to the type of interface. The command prompt for each type of interface is slightly different.

VLAN Interface Configuration Mode

VLAN interface configuration mode is one of the available interface modes and is used to configure the parameters of a VLAN interface.

To access VLAN interface configuration mode, use the following command in global configuration mode:

Command	Explanation
DGS-6600:15 (config) # interface vlanVLAN-ID	Enters VLAN interface configuration mode.

Using the End and Exit Commands

The **end** command can be used to return to privileged EXEC mode from any configuration task in any configuration mode. If a user enters the **end** command while in user EXEC mode, the user will be logged out of the session. The **exit** command is used to end the current mode and return to the mode that the user was in previously. If the Switch is in global configuration mode, the **exit** command will return the Switch to privileged EXEC mode.

Use the following commands to end the current configuration session or exit the current mode:

Command	Explanation
end	Ends the current configuration session.
exit	Exits the current mode.

In the following example, the user uses the **end** command in interface mode to return to privileged EXEC mode:

```
DGS-6600:15 (config-if) #end
DGS-6600:15#
```

In the following example, the **exit** command is used in interface mode to return to global configuration mode:

```
DGS-6600:15 (config-if) #exit
DGS-6600:15 (config) #
```

Help Features

The help feature allows the user to get instant and interactive guidance information on using the CLI commands. The following list describes the different help features that are available on the Switch:

Command	Purpose
<i>ABBREVIATED-COMMAND-ENTRY?</i>	Obtains a list of commands that begin with a particular character string. For example: <pre>DGS-6600:15#di? dir List directory contents disable Turn off privileged mode command</pre> DGS-6600:15#
<i>ABBREVIATED-COMMAND-ENTRY <TAB></i>	Completes a partial command name. For example: <pre>DGS-6600:15#show spa<TAB> DGS-6600:15#show spanning-tree</pre>

Table 3-2 Help System

Command	Purpose
?	<p>Lists all the commands that are available in a particular command mode. For example:</p> <pre>DGS-6600:2>? Exec commands: clear Reset function copy Copy crypto Generate encrypt key dir List of directory contents disable Turn off privileged mode command enable Turn on privileged mode command end Exit from the EXEC</pre>
COMMAND ?	<p>Lists the associated keywords for a command. For example:</p> <pre>DGS-6600:15#copy ? WORD Specifies the URL debug Debug information running-config The running-config startup-config The startup-config system-log System-log file DGS-6600:15#</pre>
COMMAND KEYWORD ?	<p>Lists the associated arguments for a keyword. For example:</p> <pre>DGS-6600:15(config)#spanning-tree mode ? mstp Multiple Spanning Tree Protocol rstp Rapid Spanning Tree Protocol stp Spanning Tree Protocol(Compatible Mode) DGS-6600:15(config)#</pre>

Table 3-2 Help System (continued)

The following example, the user enters the abbreviated command entry **conf** and the **<TAB>** key to automatically complete the **configure** command:

```
DGS-6600:15#conf<TAB>
```

Help Command

A user can enter the **help** command in any command mode to display a brief description of the help system.

In the following example, the user has entered the **help** command in user EXEC mode:

```
DGS-6600:2>help
CLI provides advanced help feature. When you need help,
anytime at the command line please press '?'.

If nothing matches, the help list will be empty and you must backup
until entering a '?' shows the available options.
Two styles of help are provided:
 1. Full help is available when you are ready to enter a
    command argument (e.g. 'show ?') and describes each possible
    argument.
 2. Partial help is provided when an abbreviated argument is entered
    and you want to know what arguments match the input
    (e.g. 'show ve?').

DGS-6600:2>
```

Editing Features

The CLI user interface supports the following keystrokes for editing purposes:

Keystroke	Purpose
<DELETE>	Deletes character under the cursor and shifts remainder of the line to the left.
<BACKSPACE>	Deletes character to the left of the cursor and shifts remainder of the line to the left.
<LEFT ARROW>	Moves cursor to the left.
<RIGHT ARROW>	Moves cursor to the right.
<CTRL+R>	Redisplays the current command line if the Switch suddenly sends messages to the screen.
<RETURN>	Scrolls down to display the next line.
<SPACE>	Scrolls down to display the next page.
<ESC>	Escapes from the page being displayed.
<TAB>	Automatically completes a command.

Table 3-3 Editing Features

Using Abbreviated Commands

The Switch supports abbreviated commands. In order to enter a command, a user only needs to input enough characters for the Switch to uniquely recognize a command. For example if the user types **show span**, the Switch will identify the command as **show spanning-tree**. However, if the user does not type enough characters to uniquely identify the command an ambiguous command error message will display. For example if the user types **log** the Switch cannot identify if the command is **login** or **logout**.

To automatically complete a command with a short prefix, the user needs to press the **<TAB>** key on their keyboard.

For example:

If the user types **show span** and presses the **<TAB>** key on their keyboard the command will automatically complete to display **show spanning-tree**.

The No and Default Command Forms

Many of the configuration commands can be disabled or reset to their default values by using a **no** prefix before the command. One function that supports the **no** command form is the **password encryption** command. For example, to disable the password encryption function globally on the Switch the user would need to enter the **no password encryption** command in global configuration mode. In order to re-enable the password encryption function, the user would need to enter the **password encryption** command in global configuration mode.

Example of Using the No Command Form

In the following example, the user has typed in the **no password encryption** command in global configuration mode.

```
DGS-6600:15 (config) #no password encryption
DGS-6600:15 (config) #
```

Some commands also have a **default** option, which the user can use to return the parameters of a command back to factory defaults. One command that supports the **default** option is the **ip telnet service-port** command. For example, entering the **default ip telnet service-port** command in global configuration mode will return the banner login message back to factory defaults.

Example of Using the Default Command Form

In the following example, the **default ip telnet service-port** command is entered in global configuration mode to return the Telnet service port to default settings.

```
DGS-6600:15 (config) #default ip telnet service-port
DGS-6600:15 (config) #
```

Error Messages

The following table explains the error messages that will appear if the user inputs a command incorrectly in the CLI:

Error Message	Meaning
Ambiguous command	Not enough keywords were entered for the Switch to recognize the command.
Incomplete command	The command was not entered with all the required keywords.
Invalid input detected at ^ marker	The command was entered incorrectly.
Argument is too long	The length of the command is longer than 384 characters. Users can only input an argument that is less than, or equal to 384 characters.

Table 3-4 Error Messages

Example of an Ambiguous Command Error

In the following example, the user has typed in the word **log** in privileged EXEC mode. However, there are not enough letters to enable the Switch to identify if the command is **login** or **logout**.

```
DGS-6600:15#log
% Ambiguous command:  "log"
DGS-6600:15#
```

Example of an Incomplete Command Error

In the following example, the user has typed in the **ping** command in privileged EXEC mode. However, there are not enough keywords for the Switch to execute the command.

```
DGS-6600:15#ping
% Incomplete command.

DGS-6600:15#
```

Example of an Invalid Input Detected at ^ Marker Error

In the following example, the user has tried to enter the **shutdown** command in global configuration mode. Since the **shutdown** command is not available in global configuration mode, the "Invalid input detected at marker" error appears in the console window, indicating the location of the error.

```
DGS-6600:15 (config)#shutdown
                        ^
% Invalid input detected at '^' marker.

DGS-6600:15 (config)#
```

Using Command History

The Switch CLI provides a history or record of commands that have been entered in the current console session. This feature is particularly useful for recalling long or complex commands or entries, including access lists. The Switch records 20 command lines in its history buffer. The command history feature is enabled by default.

The commands in the history buffer can be displayed by using the **show history** command.

The following example uses the **show history** command to display the commands in the history buffer:

```
DGS-6600:15#show history
 1 enable
 2 configure terminal
 3 default ip telnet service-port
 4 end
 5 show history
DGS-6600:15#
```

Recalling Commands

To recall commands from the history buffer, use one of the following key combinations:

Command	Explanation
<CTRL-P> or the <UP ARROW> key.	Recalls commands in the history buffer, beginning with the most recent command. Repeat the key sequence to recall successively older commands.
<CTRL-N> or the <DOWN ARROW> key.	Returns to more recent commands in the history buffer after recalling commands with the <CTRL-P> or the <UP ARROW> key. Repeat the key sequence to recall the most recent commands successively.

Table 3-5 Recalling Commands

Command Prompt

The user can change the command prompt of the Switch so that it displays the product name, system name, or a user-defined string. The user can also specify if the command prompt displays the level of the user that is currently logged into the Switch. By default the CLI Prompt displays the product name and the user level.

A command prompt is shown in the following format: **WWWW:XX(YY)Z**

Letter	Description
www	Represents the model name of the Switch, e.g. DGS-6600, the system name of the Switch, or the user-defined string. This part of the command prompt is always followed by a colon.
xx	Represents the user access level, e.g. 1 indicates a Basic User, 2 indicates an Advanced User, 12 indicates a Power User, and 15 indicates an Administrator.

Table 3-6 Command Prompts

Letter	Description
(YY)	Represents the configuration mode that the user is in. The available modes are Global Configuration mode, Interface Configuration mode, VLAN Configuration mode, Router mode, etc.
z	Represents if the user is in user EXEC mode or privileged EXEC mode. The ">" symbol indicates that the user is in user EXEC mode. The "#" symbol indicates that the user is in privileged EXEC mode or a configuration mode.

Table 3-6 Command Prompts (continued)

The following table lists some examples of the command prompts that the user will see in different command modes. In the following table the Switch has been configured to use the product name as the command prompt and display the privilege level of the user:

Command Mode and Privilege Level	Command Prompt
User EXEC mode at Basic User level	DGS-6600:1>
User EXEC mode at Advanced User level	DGS-6600:2>
Privileged EXEC mode at Power User level	DGS-6600:12#
Privileged EXEC mode at Administrator level	DGS-6600:15#
Global Configuration mode	DGS-6600:15 (config) #
Interface Configuration mode	DGS-6600:15 (config-if) #
VLAN Interface Configuration mode	DGS-6600:15 (config-if) #

Table 3-7 Command Prompts

If the user wants to change the CLI prompt to be the product name, system name, or a user-defined string, and specify if the privilege level should be displayed or hidden, the following command should be entered in global configuration mode:

Command	Explanation
<code>command prompt [level no-level] [string <i>STRING</i> product-name system-name]</code>	Configures the CLI prompt.

In the following example, the user configures the command prompt to display the privilege level and use the user-defined string "Comms-Rm":

```
DGS-6600:2>enable
DGS-6600:15#configure terminal
DGS-6600:15 (config) #command prompt level string Comms-Rm
Comms-Rm:15 (config) #end
```

Filtering the Output from the Show Command

The user can filter the output of the **show** command to match a given expression as well as any of lines that are associated with the expression.

show *COMMAND* | {**begin** | **include** | **exclude**} *REGULAR-EXPRESSION*

Syntax	Description
<i>COMMAND</i>	Represents any show command.
	The vertical bar (pipe symbol) indicates that an output processing specification will follow.
begin	Specifying the begin syntax causes the Switch to search the output from the first instance of a specified string.
include	Specifying the include syntax causes the Switch to filter the output so that only lines with a particular regular expression are displayed.
exclude	Specifying the exclude syntax causes the Switch to exclude any lines that contain a particular regular expression.
<i>REGULAR-EXPRESSION</i>	Represents any regular expression (text string) that is found in the output of the show command.

In the following example, the user filters the output of the **show logging-buffer** command so that only the entries for the first instances of eth4.43:

```
DGS-6600:2>enable
DGS-6600:15#show logging buffer | begin eth4.43

...skipping
7      2010-08-26 07:38:28  eth4.43 state change from FWD to BLK for MSTID 0
6      2010-08-26 07:38:27  Interface eth4.43 is down
5      2010-08-26 07:38:27  Interface vlan1 is down
4      2010-08-26 07:38:09  eth4.43 state change from LRN to FWD for MSTID 0
3      2010-08-26 07:38:09  eth4.43 state change from BLK to LRN for MSTID 0
2      2010-08-26 07:38:06  Interface eth4.43 is up
1      2010-08-26 07:38:06  Interface vlan1 is up

DGS-6600:15#
```

In the following example, the user filters the output of the **show logging-buffer** command so that only lines containing the expression eth4.43 are displayed:

```
DGS-6600:2>enable
DGS-6600:15#show logging buffer | include eth4.43
7      2010-08-26 07:38:28  eth4.43 state change from FWD to BLK for MSTID 0
6      2010-08-26 07:38:27  Interface eth4.43 is down
4      2010-08-26 07:38:09  eth4.43 state change from LRN to FWD for MSTID 0
3      2010-08-26 07:38:09  eth4.43 state change from BLK to LRN for MSTID 0
2      2010-08-26 07:38:06  Interface eth4.43 is up

DGS-6600:15#
```

In the following example, the user filters the output of the **show logging-buffer** command so that lines containing the expression **eth4.43** are filtered out:

```
DGS-6600:2>enable
DGS-6600:15#show logging buffer | exclude eth4.43

Total logs:9

Index Date          Times          Log Text
-----
9      2010-08-26 07:42:28  The running CFG was saved to the startup CFG by user
anonymous, IP 0.0.0.0, via console

8      2010-08-26 07:38:49  Successfully login to the system by user anonymous, I
P 10.73.87.1, via Telnet at privilege level 2

5      2010-08-26 07:38:27  Interface vlan1 is down

1      2010-08-26 07:38:06  Interface vlan1 is up

DGS-6600:15#
```

Login Banner

The user can create a login banner that will display after successfully logging into the Switch. This feature is useful as it can be used as a method for informing users about any future events or useful information that the administrator would like to announce to any users who are connected to the Switch, such as an upgrade on the network.

By default, the login banner displays information about the Switch model and firmware version.

To configure a login banner, enter the following command in global configuration mode:

Command	Explanation
banner login <i>STRING</i>	Configure the login banner.

In the following example, the user configures a login banner that displays the following message:

“Essential Network Maintenance at 18:00 tonight!

Make sure you are logged off the network before 18:00.

For more information contact the System Administrator on extension: 6716.”

```
DGS-6600:15#configure terminal
DGS-6600:15 (config)#banner login Essential Network Maintenance at 18:00 tonight!/
nMake sure you are logged off the network before 18:00./nFor more information
contact the System Administrator on extension: 6716.
DGS-6600:15 (config)#
```

The following example displays the login banner that will appear after logging into the Switch:

```
User Access Verification

Username: adv-user
Password:
Essential Network Maintenance at 18:00 tonight!
Make sure you are logged off the network before 18:00.
For more information contact the System Administrator on extension: 6716.
DGS-6600:2>
```

The following example uses the **default** command in global configuration mode to return the login banner back to default settings:

```
DGS-6600:15 (config)#default banner login
DGS-6600:15 (config)#
```

Establishing a Telnet Connection to a Remote Device

The user can establish a connection to a remote device that supports the Telnet protocol:

Command	Explanation
telnet { <i>IP-ADDRESS</i> <i>IPV6-ADDRESS</i> } [<i>TCP-PORT</i>]	Establishes a connection to a remote device that supports the Telnet protocol.

In the following example, the user establishes a Telnet connection to a device that has an IP address of 10.1.1.254:

```
DGS-6600:2>telnet 10.1.1.254
Connecting to 10.1.1.254 ...
Connected to 10.1.1.254.
Escape character is 'Ctrl-_'.
```

Telnet connecting ...

```
User Access Verification

Username:
```

In the following example, the user establishes a Telnet connection to a device that has an IPv6 address of 2001:e10:5c00:2::101:253, with the default port 23:

```
DGS-6600:2>telnet 2001:e10:5c00:2::101:2534
Connecting to 2001:e10:5c00:2::101:253 ...
Connected to 10.1.1.254.
Escape character is 'Ctrl-_'.
```

Telnet connecting ...

User Access Verification

Username:

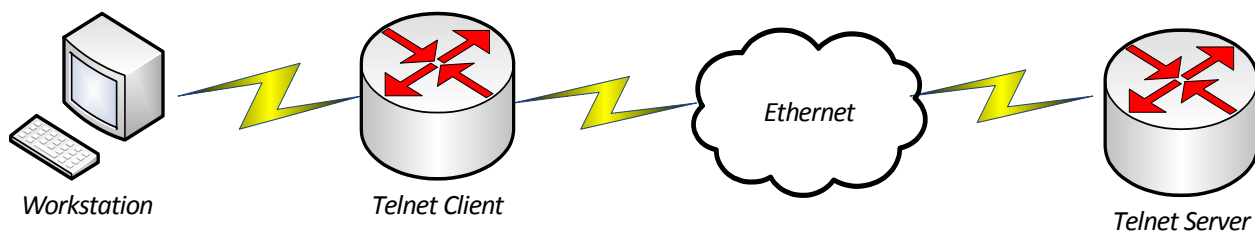

Figure 2-2 Workstation to Telnet Server diagram.

Common Parameter Syntax Conventions

The following section describes the syntaxes used for commonly used command parameters.

Interface-ID

An interface can be a physical port, a VLAN, or a channel-group. For a physical port in an Ethernet switch, an interface-ID appears in the following format:

ethx.y

- **x**—For a standalone switch, this number is always 1. This can also represent the unit number (stackable system) or slot number (chassis system).
- **y**—The interface number on the switch. The port numbers always begin at 1, starting on the left, when facing the front of the Switch, for example, eth1.1, eth1.2.

For a VLAN interface, the format is **vlanVLAN-ID**. e.g. vlan1.

For a channel group (link aggregated) interface, the format is **port-channelGROUP-NUM**, for example: **port-channel3**

MAC Address

The acceptable formats for a MAC Address are **00-01-80-40-30-20**, **00:01:80:40:30:20**, **000180403020**, and **0001.8040.3020**.

The MAC address will always be displayed in the following format: **00-01-80-40-30-20**

IP Parameters

An IP address will always be in the format of **A.B.C.D**. The subnet mask can be represented in mask bit form or as an integer indicating the number of mask bits, as shown below:

A.B.C.D xxx.xxx.xxx.xxx

A.B.C.D/N

For example – **10.9.18.2 255.0.0.0** is interchangeable with **10.9.18.2/8**. Note that a space is required between **A.B.C.D** and **xxx.xxx.xxx.xxx**. A back slash '/' has to be inserted between **A.B.C.D** and **N**.

Allowed Character Strings And String Examples

Allowed Characters for File Name

A-Z

a-z

0-9

!#\$%&'()+,.-=@[]^_`{ } ~

space

Allowed Characters for General Strings that Allow Spaces

A-Z

a-z

0-9

!#\$%&'()+,.-=@[]^_`{ } ~ / \ : * <

space

Allowed Characters for General Strings that Do Not Allow Spaces

A-Z

a-z

0-9

!#\$%&'()+,.-=@[]^_`{ } ~ / \ : * <

Encrypted Password

An encrypted password should start with *@&.

The allowed characters for an encrypted password are:

A-Z

a-z

0-9

+/

Time and Date Configuration

The following section defines the display format the Switch uses to represent durations, calendar date, and time respectively.

Durations

Durations are used to define the amount of intervening time in a time interval.

The Switch uses the following format to represent time, [v]DT[v]H[v]M[v]S. In this representation, the value for each of the date and time elements replaces the date and time elements that follow the [v]. Leading zeros for each of the date and time elements are not required. Each date and time element use a capital letter as a designator that is not replaced.

The following table explains the designators used for each date and time element:

Designator	Description
D	Used as the <i>Day</i> designator. This designator follows the value for the number of days.
T	Used as the <i>Time</i> designator. This designator precedes the time components.
H	Used as the <i>Hour</i> designator. This designator follows the value for the number of hours.
M	Used as the <i>Minute</i> designator. This designator follows the value for the number of minutes.
S	Used as the <i>Second</i> designator. This designator follows the value for the number of seconds.

Table 3-8 Date and Time Element Designators

For example, a duration lasting "six days, seven hours, fifteen minutes, and nine seconds would be represented as as follows, "6DT7H15M9S". If the value of a date and time element, including their designator, is zero, the value may be omitted. Lower values can also be omitted for reduced precision. For example, the following format, "13DT21H" is an acceptable form to represent 13 days and 21 hours.

Calendar Dates

The Switch uses the following format to represent calendar dates, YYYY-MM-DD.

The following table explains the components that the Switch uses to represent calendar dates:

Date Component	Description
YYYY	Used to indicate a four-digit year, 0000 through to 9999.
MM	Used to indicate a two-digit month of the year, 01 through to 12.

Table 3-9

Date Component	Description
DD	Used to indicate a two-digit day of that month, 01 through to 31.

Table 3-9

For example, the Switch would represent the date "22nd of February 2012" as "2012-02-22."

This Switch allows calendar dates to be written with reduced precision. For example, if the user inputs "2012-02" the Switch will identify the calendar date as "2012 February". If the user inputs "2012" the Switch will identify the year as "2012".

The format of YYYY-MM-DD is necessary for complete calendar date representations.

Time

The Switch uses the 24-hour clock system, with the following format: [hh]:[mm]:[ss].

The following table explains the components that the Switch uses to represent the time:

Date Component	Description
[hh]	Used to refer to a zero-padded hour between 00 and 24, where 24 is only used to notate midnight at the end of a calendar day.
[mm]	Used to refer to a minute between 00 and 59
[ss]	Used to refer to a second between 00 and 59.

Table 3-10 Switch Time Components

For example "14:50:30".

Midnight is a special case and can be referred to as either "00:00" or "24:00". The notation "00:00" is used at the beginning of a calendar day and is used more frequently. The notation usually used at the end of a day is "24:00".

Countdown Timer

The Switch uses most its timers for protocol synchronization. The Switch timers usually use seconds or milliseconds time units. The Switch usually abbreviates seconds to *sec* and milliseconds to *msec* for unified display formatting.

Chapter 4

Accessing the Command Line Interface

Chapter Overview

The following topics are included in this chapter, please go to the topic for more detailed information:

- [Chapter Overview](#)
 - [An Introduction to Accessing the Switch Using a Console Connection](#)
- [Accessing the Switch Using a Telnet Connection](#)
 - [Enabling the Telnet Service](#)
 - [Configuring the Telnet Service Port](#)
 - [Specifying Telnet Terminals](#)
 - [Displaying Trusted Host Telnet Terminals](#)
 - [Closing an Active Terminal Session](#)
- [Terminal Settings](#)
 - [Configuring the Number of Lines Displayed on Terminal Screen](#)
 - [Configuring the Max Number of Characters Displayed per Terminal Line](#)
 - [Configuring the Terminal Timeout](#)
- [List of Constants and Default Settings](#)

An Introduction to Accessing the Switch Using a Console Connection

Initial configuration of the Switch needs to be carried out using one of the UART console interfaces available on the DGS-6600-CM front panel. The DGS-6600-CM front panel provides two types of UART console interface, an RS-232 connector and a USB connector.

In order to use the RS-232 or USB console interface the host will need to have a terminal emulation application (e.g., Hyper Terminal, Teraterm etc.) installed. If using the USB console interface, the correct USB driver for the Switch will also need to be installed on the connected host.

If using the RS-232 console connection, the host will need to have the following equipment:

- A terminal or a computer with an RS-232 serial port and the ability to emulate a terminal.
- A null modem or straight-through RS-232 cable with a female DB-9 connector for the console port on the Switch.

Carry out the following to connect a terminal to the RS-232 console port:

- 1) Connect the female connector of the RS-232 cable directly to the console port on the Switch, and tighten the captive retaining screws.
- 2) Connect the other end of the cable to a terminal or to the serial connector of a computer running terminal emulation software. Set the terminal emulation software as follows:
- 3) Select the appropriate serial port (COM port 1, COM port 2, etc).
- 4) Set the baud rate to 115200 bps.
- 5) Set the data format to 8 data bits, 1 stop bit, and no parity.

- 6) Set flow control to hardware.
- 7) Under Properties, select VT100 for Emulation mode.
- 8) After correctly setting up the terminal, plug the power cable into the power receptacle on the back of the Switch. The boot sequence appears in the terminal.
- 9) After the boot sequence completes, the console login screen displays.
- 10) Ensure that any terminal or PC being used to make a console connection is configured to match these settings.
- 11) If using the USB console connection, the host will need to have the following equipment:
 - A terminal or a computer with USB port and the ability to emulate a terminal.
 - A Type A to Type B USB cable.

Carry out the following to connect a terminal to the USB console port:

- 1) Connect the Type A connector end of the USB cable to an available USB port on the Switch.
- 2) Connect the Type B connector end of the USB cable to an available USB port on the computer running the terminal emulation software. Set the terminal emulation software using the same procedure described above.



NOTE: If both the RS-232 and USB connection are active on the device, the USB connection will have priority over the RS-232 connection. If the device is currently being managed via the RS-232 console connection and a USB connection is established, the system will disconnect the RS-232 connection and switch over to the USB connection.

If connecting to the Switch for the first time, press the **<RETURN>** key to start the login process.

In the following example, the user has started a console connection and enters privileged EXEC mode:

```
DGS-6600 Chassis-based High-Speed Switch
Command Line Interface

Firmware: 3.00.080
Copyright (c) 2012 D-Link Corporation. All rights reserved.
DGS-6600:2>enable
DGS-6600:15#
```

If the user has created a user name and password, the Switch will prompt the user to enter a user name and password before accessing a command mode. The command mode the user initially enters will depend on the privilege level assigned to the user name.

In the following example the user is prompted to enter a user name and password. The user enters a user name with administrator level privileges and directly enters privileged EXEC mode:

```
User Access Verification

Username:Admin-User
Password:

                DGS-6600 Chassis-based High-Speed Switch
                Command Line Interface

                Firmware: 3.00.080
                Copyright (c) 2012 D-Link Corporation. All rights reserved.
DGS-6600:2>enable
DGS-6600:15#
```



NOTE: The user has three attempts to enter the correct password, before the login attempt is refused.

Accessing the Switch Using a Telnet Connection

The Switch can be managed using a Telnet connection. Up to eight simultaneous Telnet sessions can be made from the Switch.



NOTE: In order to successfully connect to the Switch using Telnet, an IP address needs to be configured on the Switch

To start a Telnet connection on the Switch open a terminal emulation application on the PC and enter the Telnet command followed by the IP address of the Switch.

In the following example, a Telnet connection is established to a Switch with an IP address of 10.73.87.99:

```
C:\>telnet 10.73.87.99
Telnet connecting ...

                DDGS-6600 Chassis-based High-Speed Switch
                Command Line Interface

                Firmware: 3.00.080
                Copyright (c) 2012 D-Link Corporation. All rights reserved.
DGS-6600:2>enable
DGS-6600:15#
```

Enabling the Telnet Service

To re-enable the Telnet service after it has been disabled by the user, enter the following commands in privileged EXEC mode:

Command	Explanation
<code>configure terminal</code>	Enters global configuration mode.
<code>ip telnet server</code>	Enables the Telnet service.

Configuring the Telnet Service Port

The user can change the port used by the Telnet service by using the following command in global configuration mode:

Command	Explanation
<code>ip telnet service-port <i>TCP-PORT</i></code>	Configures the port used by the Telnet service.

To return the Telnet service on the Switch to the default setting use the **default** form of the command.

In the following example, the user configures the TCP port number for Telnet to be 3000:

```
DGS-6600:15#configure terminal
DGS-6600:15(config)#ip telnet service-port 3000
DGS-6600:15(config)#end
```

Specifying Telnet Terminals

The user can specify the hosts that are allowed to manage the Switch using a Telnet connection by using the following command in global configuration mode:

Command	Explanation
<code>ip trusted-host {<i>IP-ADDRESS</i> <i>NETWORK-ADDRESS/PREFIX-LENGTH</i>} telnet</code>	Specifies a host that is allowed to manage the Switch using a Telnet connection.

In the following example, a trusted host with IP address 10.73.87.3 is allowed to manage the switch using a Telnet connection:

```
DGS-6600:15#configure terminal
DGS-6600:15(config)#ip trusted-host 10.73.87.3 telnet
DGS-6600:15(config)#end
```

Displaying Trusted Host Telnet Terminals

The user can display a list of the hosts that are allowed to manage the Switch using a Telnet connection by entering the following command in privileged EXEC mode:

Command	Explanation
<code>show ip trusted-host telnet</code>	Displays a list of the hosts that are allowed to manage the Switch using a Telnet connection.

In the following example, the user displays a list of the hosts that are allowed to managed the Switch using a Telnet connection:

```
DGS-6600:15#show ip trusted-host telnet
Index  IP/Network Address      Valid to Access
=====
01     10.78.62.1/32           TELNET
02     10.73.87.1/32           TELNET
Total Entries: 2
DGS-6600:15#
```

Closing an Active Terminal Session

An active session can be ended using either the **logout**, **exit**, or **end** commands.

Command	Explanation
<code>logout</code>	Ends an active session.
<code>exit</code>	If the exit command is entered in EXEC mode, the active session will end.
<code>end</code>	If the end command is entered in EXEC mode, the active session will end.

Terminal Settings

Configuring the Number of Lines Displayed on Terminal Screen

The number of lines that are displayed can be changed by the user to meet their needs. The valid entries for the number of lines that can be displayed is between 0 and 512. If the user specifies a terminal length of 0, the display will continue to scroll down until the end of the display is reached. If a terminal length is specified to a value other than 0, for example 50, then the display will stop after 50 lines. Output from a single command that overflows a single display screen is followed by the **--More--** prompt. At the **--More--** prompt the user can use the **Ctrl-C**, **q**, or **Q** keys to interrupt the output and return to the prompt, press the **<SPACEBAR>** to display an additional screen of output, or press the **<RETURN>** key to display one more line of output.

The user can use one of the following commands to change the default number of lines displayed on the terminal screen for the current session or apply the changes to all future sessions:

Command	Explanation
<code>terminal length LINES</code>	Configures the number of lines that will be displayed on the terminal screen for the current session.
OR	
<code>terminal length LINES default</code>	Configures the number of lines that will be displayed on the terminal screen for all current and future sessions.

The following example configures the current session to display 60 lines on the terminal screen:

```
terminal length 60
```

The following example configures the current and all future sessions to display 60 lines on the terminal screen:

```
terminal length 60 default
```



NOTE: The settings specified in these commands also apply to both Telnet and SSH sessions automatically.

Configuring the Max Number of Characters Displayed per Terminal Line

The user can specify the maximum number of characters that will be displayed on each line in the console window. The user can specify a value between 80 and 255 characters.

Use the following command to specify the number of characters that will be displayed on a terminal line:

Command	Explanation
<code>terminal width <80-255> [default]</code>	Configures the maximum number of characters that can be displayed in the terminal window. The range is from 80 to 255 characters and the argument default specifies to save the setting permanently in the startup configuration file.

In the following example, the user specifies that a maximum of 100 character can be displayed in a terminal window and by using the **default** keyword saves the setting into the system configuration file for the next switch startup.:

```
DGS-6600:2>terminal width 100 default
```



NOTE: The settings specified in these commands also apply to both Telnet and SSH sessions automatically.

Configuring the Terminal Timeout

The Switch uses a timer to specify the amount of time a terminal session should be idle before timing out. The Switch uses the same timer for all terminal sessions, regardless of whether the session was established by a direct serial connection, a Telnet connection, or an SSH connection.

To configure the amount of time the terminal session should be idle before timing out, enter the following command in privileged EXEC mode:

Command	Explanation
<code>terminal timeout {never 2_minutes 5_minutes 10_minutes 15_minutes}</code>	Configures the amount of time the terminal session should be idle before timing out.

In the following example, the user configures an idle terminal session to time out after two minutes:

```
DGS-6600:2>enable
DGS-6600:15#terminal timeout 2_minutes
```

List of Constants and Default Settings

Constant Name	Value
Maximum Telnet sessions	8
Local Console Baud Rate	115200 bps

Table 4-1 Constants Values

Variable Name	Default Value
Telnet Service	Enabled
Telnet Service Port	TCP 23
Terminal Length	24 lines
Terminal Timeout	Never

Table 4-2 Default Variable Values

Chapter 5

User Account Configuration

Chapter Overview

The following topics are included in this chapter, please go to the topic for more detailed information:

- [Chapter Overview](#)
 - [An Introduction to Configuring User Accounts](#)
- [Creating User Accounts with Different Privilege Levels](#)
 - [Creating User Accounts](#)
 - [Displaying the User Accounts Setup on the Switch](#)
 - [Displaying Active User Sessions on the Switch](#)
- [Creating and Configuring Enabled Passwords](#)
 - [Creating an Enabling Password](#)
 - [Displaying Enabled Passwords](#)
 - [Logging into the Switch with a Different User Account](#)
 - [Encrypting Passwords](#)
- [List of Constants and Default Settings](#)

An Introduction to Configuring User Accounts

The following chapter discusses how to create user accounts on the Switch. User accounts can be used to protect access to the command-line interface. The user can create several user accounts with different access-levels.

Creating User Accounts with Different Privilege Levels

Creating User Accounts

The Switch supports user accounts with different access levels. The following access levels can be assigned to user accounts, Level 1, Level 2, Level 12, & Level 15. If another level is specified, an error message will be displayed on the console.

When a user logs in with a Level 1 or Level 2 account, the user will access the Switch in user EXEC mode. In order to access higher privilege levels, a user needs to use the **enable** command. However, if a user logs onto the Switch using a Level 1 user account, they will not be allowed to enter privileged EXEC mode.

When a user logs in with a user account that has a privilege level of 12 or 15, the user will directly enter privileged EXEC mode.

When creating a user account, the user can specify if the password will be entered in encrypted or plain text form. If a password is entered into the Switch in plain-text form, but the password encryption function is enabled, the password will be converted to encrypted form.

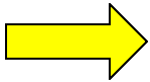

NOTICE: Make sure that the password is changed correctly before saving the changes to the startup configuration

To create a new user account, use the following command in global configuration mode:

Command	Explanation
<code>username NAME [privilege LEVEL] password {plain-text encrypted} PASSWORD</code>	Creates a new user account.

The following example creates a user account called “admin” and a password of “mypassword”:

```
DGS-6600:2>enable
DGS-6600:15#configure terminal
DGS-6600:15 (config) #username admin password plain-text mypassword
DGS-6600:15 (config) #end
```

To remove a user account with the user name “admin”:

```
DGS-6600:2>enable
DGS-6600:15#configure terminal
DGS-6600:15 (config) #no username admin
DGS-6600:15 (config) #end
```

Displaying the User Accounts Setup on the Switch

To display the user accounts setup on the Switch, use the following command in privileged EXEC mode:

Command	Explanation
<code>show username [NAME]</code>	Displays the user accounts setup on the Switch.

The following example displays all the user accounts that have been setup on the Switch:

```
DGS-6600:15#show username
Password Encryption : Disabled
Username           Access Level Password                               Encrypted
-----
dlink              15          *@&fEqNCco3Yq9h5ZUglD3CZJT4LBvRndtZ    *
admin              15          mypassword
Total Entries: 2
DGS-6600:15#
```

The table below describes the significant fields shown in the display:

Field	Description
Encrypted	'*' denotes the entry's password is encrypted. Empty indicates that the password is 'Plain Text'.

Table 5-1 Significant fields shown in the show username command output

The factory default settings have no user accounts setup. When the user account database is empty, a user accessing the Switch using the console connection will directly enter user EXEC mode at Power User level. The user can enter privileged EXEC mode, by entering an up-to-date enable password. If a user attempts to make a Telnet connection when the user account database is empty, the Switch will directly enter user EXEC mode.

Displaying Active User Sessions on the Switch

To display the user sessions that are currently running on the Switch, use the following command in user EXEC mode:

Command	Explanation
<code>show user-session [console telnet ssh http https]</code>	Displays the user accounts setup on the Switch.

The following example displays all the user accounts that have been setup on the Switch:

```
DGS-6600:2>show user-session
UI Codes: co - console, h - http, hs - https, s - ssh, te - telnet
ID   Login Time           From           UI Level  Username
-----
  0   11:52:38, 2012-05-24  0.0.0.0      co 15     admin
* 5   11:52:52, 2012-05-24  10.70.89.1   te 2      dlink
Total Entries: 2
DGS-6600:2>
```

Creating and Configuring Enabled Passwords

Creating an Enabling Password

The **enable password** command is used to create a password for entering privileged EXEC mode. Different parameters can be specified when creating an enable password, including the privilege level that the user will have after entering the password and whether the password will appear in plain-text or encrypted form in the running configuration.

To create a new enable password use the following command in global configuration mode:

Command	Explanation
<code>enable password privilege <i>LEVEL</i> password {plain-text encrypted} <i>PASSWORD</i></code>	Creates a new enable password.

In the following example, the user creates a plain-text password using the word “MyEnablePassword” with a privilege level of 15:

```
DGS-6600:2>enable
DGS-6600:15#configure terminal
DGS-6600:15 (config)#enable password privilege 15 password plain-text
MyEnablePassword
DGS-6600:15 (config)#end
```

Displaying Enabled Passwords

To display the enable passwords setup on the Switch, use the following command in privileged EXEC mode:

Command	Explanation
<code>show enable password [privilege <i>LEVEL</i>]</code>	Displays the enable passwords that have been setup on the Switch.

In the following example, the user displays all the enable passwords that have been setup on the Switch:

```
DGS-6600:15#show enable password
Password Encryption :Disabled
Access Level      Password
-----
12                *@&fEqNCco3Yq9h5ZUg1D3CZJT4LBvRndtZ (Encrypted)
15                MyEnablePassword(Plain Text)

Total Entries: 2
```

Logging into the Switch with a Different User Account

Enter the following command to log into the Switch with a different user name:

Command	Explanation
<code>login</code>	Allows the user to login with a different user name.

In the following example, the user logs into the switch with the user name “user1”:

```
DGS-6600:2>login

User Access Verification

Username: user1
Password:

DGS-6600 Chassis-based High-Speed Switch
Command Line Interface

Firmware: 3.00.080
Copyright (c) 2012 D-Link Corporation. All rights reserved.

DGS-6600:2>
```

Encrypting Passwords

By default, passwords defined by the **username** and **enable** commands are stored in plain-text form in the configuration file, unless the specified password is in encrypted form when the user account is setup. In order to increase security, the **password encryption** command can be used to encrypt plain-text form passwords.

To encrypt all the passwords defined by the **username** commands, use the following command in global configuration mode:

Command	Explanation
password encryption	Encrypts the passwords defined by the username command.

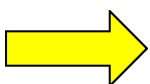

NOTICE: The **no password encryption** command can be used to disable the encryption of passwords in the configuration file. However, passwords that were created in encrypted form or passwords that were converted to encrypted form by the last **password encryption** command will remain in encrypted form and cannot be reverted back to plain text form.

The following example encrypts the passwords of user accounts and the authentication password:

```
DGS-6600:15#configure terminal
DGS-6600:15 (config) #password encryption
DGS-6600:15 (config) #end
```



NOTE: Even if the **no password encryption** command has been entered on the Switch, the password of a user account can still be encrypted by specifying the **encrypted** option with the **username** command.

The following example shows the output of the **show username** command after the **password encryption** command has been entered on the Switch:

```
DGS-6600:15#show username
Password Encryption : Enabled
Username           Access Level Password                               Encrypted
-----
admin              15          *@&Fxy+fgwFJI09+SpIYvXjcCuMda7vnWTR/B *
dlink              15          *@&EukpPsazDH+ooJJq9CgH6SnBaE+gJj/Eww *
Kindo              15          *@&NUQjQWpaucJPOFFIgEr8kbKRITrrrrd/wN *
Total Entries: 3
DGS-6600:15#
```

List of Constants and Default Settings

Constant Name	Value
Maximum Number of User Accounts	4

Table 5-2 Constants Values

Variable Name	Default Value
Number of User Accounts Setup on the Switch	None
Enable Password	None
Password Encryption	Disabled

Table 5-3 Default Variable Values

Chapter 6

Accessing the Web Interface (Web UI)

Chapter Overview

The following topics are included in this chapter, please go to the topic for more detailed information:

- [Chapter Overview](#)
 - [An Introduction to Accessing the Switch using the Web Interface](#)
- [Configuration Commands](#)
 - [Enabling the Web Interface](#)
 - [Configuring the Web Service Port](#)
 - [Specifying Web Management Terminals](#)
 - [Displaying Trusted Host Web Terminals](#)
- [List of Constants and Default Settings](#)

An Introduction to Accessing the Switch using the Web Interface

The Switch can be managed using the Web interface. Only one user can manage the Switch using the Web at any one time.



NOTE: In order to successfully connect to the Switch using the Web interface, an IP address needs to be configured on the Switch

To start a Web connection on the Switch, enter the IP address that has been defined for the device. The URL in the address bar should read something like `http://123.123.123.123`, where the numbers 123 represent the IP address of the Switch.

Configuration Commands

Enabling the Web Interface

To re-enable the Web interface after it has been disabled by the user, enter the following commands in privileged EXEC mode:

Command	Explanation
<code>configure terminal</code>	Enters global configuration mode.
<code>ip http server</code>	Enables the Web interface.
<code>end</code>	Exits global configuration mode.

In the following example, the user configures to enable the Web interface.

```
DGS-6600:15#configure terminal
DGS-6600:15 (config)#ip http server
DGS-6600:15 (config)#end
```

Configuring the Web Service Port

The user can change the port used by the Web service by using the following command in global configuration mode:

Command	Explanation
<code>ip http service-port <i>TCP-PORT</i></code>	Configures the port used by the web service.

In the following example, the user configures the TCP port number for web to be 6600:

```
DGS-6600:15#configure terminal
DGS-6600:15 (config)#ip http service-port 6600
DGS-6600:15 (config)#end
```

Specifying Web Management Terminals

The user can specify the hosts that are allowed to manage the Switch using an HTTP web connection by using the following command in global configuration mode:

Command	Explanation
<code>ip trusted-host {<i>IP-ADDRESS</i> <i>NETWORK-ADDRESS/PREFIX-LENGTH</i>} http</code>	Specifies a host that is allowed to manage the Switch using a web connection.

In the following example, the user allows the host 10.73.87.3 to have access to the Switch using an HTTP web connection:

```
DGS-6600:15#configure terminal
DGS-6600:15 (config)#ip trusted-host 10.73.87.3 http
DGS-6600:15 (config)#end
```

Displaying Trusted Host Web Terminals

The user can display a list of the hosts that are allowed to manage the Switch using an HTTP web connection by entering the following command in privileged EXEC mode:

Command	Explanation
<code>show ip trusted-host http</code>	Displays a list of the hosts that are allowed to manage the Switch using a web connection.

In the following example, the user displays a list of the hosts that are allowed to managed the Switch using an HTTP web connection:

```
DGS-6600:15#show ip trusted-host http
Index  IP/Network Address      Valid to Access
=====
01     10.73.87.3/32          HTTP
Total Entries : 1
DGS-6600:15#
```

List of Constants and Default Settings

Constant Name	Value
Maximum Web sessions	1

Table 6-1 Constants Values

Variable Name	Default Value
HTTP Service	Enabled
HTTP Service Port	TCP 80

Table 6-2 Default Variable Values

Chapter 7

Time Configuration

Chapter Overview

The following topics are included in this chapter, please go to the topic for more detailed information:

- [Chapter Overview](#)
- [An Introduction to Time Configuration](#)
- [Configuration Commands](#)
 - [Manual Configuration of Time](#)
 - [Automatic Configuration of Time](#)
 - [Configuring Summer Time](#)
- [List of Constants and Default Settings](#)

An Introduction to Time Configuration

The Switch uses a real time clock (RTC) chip to provide the time and calendar services. The time set in the RTC chip should reflect the local time of the chosen locale, with the time being able to adjust in the summer for daylight saving time. The time in the RTC will still be retained if the Switch is power cycled. The user can choose to set the time on the Switch manually or automatically.

Configuration Commands

Manual Configuration of Time

The user can manually configure the time, the first time the device is setup. If manually setting the time on the Switch, the local time should be specified. The time will be written to the real-time clock (RTC) as soon as the time is set.

The following commands are used to manually set the clock:

Command	Explanation
<code>clock set HH:MM:SS DAY MONTH YEAR</code>	Manually sets the date and time.
<code>show clock</code>	Displays the current time.

In the following example, the user configures the clock on the Switch to be 14:45:00 on the 5th August 2010 and verifies that the time has been set correctly:

```
DGS-6600:2>enable
DGS-6600:15#clock set 14:45:00 5 August 2010
DGS-6600:15#show clock

Current Time Source   : No Time Source
Current Time          : 14:45:03, 2010-08-05
Time Zone             : UTC +00:00
Daylight Saving Time  : Disable
Offset in Minutes     : 60
                     From : N/A
                     To   : N/A

DGS-6600:15#
```

Automatic Configuration of Time

The Switch supports the Simple Network Time Protocol (SNTP), which allows automatic time configuration on the Switch. SNTP is a client-only version of the Network Time Protocol (NTP). Unlike NTP, SNTP is a simplified protocol that does not support the packet authentication or other complex mechanisms. When an NTP server address is configured, the system will automatically synchronize the time with the NTP servers. Once the Switch has synchronized with a specific server, the Switch will re-synchronize with the specified server at regular intervals. Whenever the Switch synchronizes with the NTP server, the latest time will be reflected in the RTC.

The SNTP server will always synchronize with the Switch using UTC time. After synchronizing with the SNTP server, the Switch's RTC will adjust to local time, according to the local time zone configured on the Switch.

The following commands are used to configure SNTP:

Command	Explanation
<code>sntp server IP-ADDRESS</code>	Configures the SNTP server.
<code>show sntp</code>	Displays the SNTP server settings.
<code>clock timezone {+ -} HOURS-OFFSET [MINUTES-OFFSET]</code>	Configures the time zone settings.
<code>show clock</code>	Displays the current time and the time zone setting.

In the following example, the user configures the Switch to synchronize with an SNTP server with the IP address 10.73.87.99, configures the time zone to be eight hours ahead of UTC, and verifies the SNTP and clock settings:

```
DGS-6600:2>enable
DGS-6600:15#configure terminal
DGS-6600:15 (config)#sntp server 10.73.87.99
DGS-6600:15 (config)#clock timezone + 8
DGS-6600:15 (config)#end
DGS-6600:15#show sntp

Server IP                Version          Last Receive
-----
10.73.87.99              5                00:01:02

Total Entries: 1

DGS-6600:15#show clock

Current Time Source   : SNTP
Current Time         : 12:21:19, 2010-08-05
Time Zone            : UTC +08:00
Daylight Saving Time : Disable
Offset in Minutes    : 60
                    From : N/A
                    To   : N/A

DGS-6600:15#
```

Configuring Summer Time

During summer time, the clock on the Switch may need to be adjusted for daylight saving time. The Switch supports two methods for adjusting to daylight saving time. The first method adjusts the time on the Switch every year on specific times, on specific days, and specific weeks of a month, e.g. The time will go forward one hour at 2:00am on Sunday in the fourth week of March and return to standard time at 2:00am (summer time) on Sunday in the fourth week of October. The second method adjusts the time on the Switch on specific dates and times every year, e.g. The time will always go forward one hour at 2:00:00 on March 29 and return to standard time at 2:00:00 (summer time) on October 25.

The following commands are used to configure summer time:

Command	Explanation
clock summer-time recurring <i>WEEK DAY MONTH HH:MM WEEK DAY MONTH HH:MM [OFFSET]</i>	Configures when summer time will start/end on the Switch based on a specific day, week, and month.
clock summer-time date <i>DATE MONTH HH:MM DATE MONTH HH:MM [OFFSET]</i>	Configures when summer time will start/end on the Switch based on a specific date and time.
show clock	Displays the summer time settings.

In the following example, the user configures the Switch to move the time forward by one hour at 2:00am on Sunday in the fourth week of March and return to standard time at 2:00am (summer time) on Sunday in the fourth week of October, and verifies the configuration:

```
DGS-6600:15 (config) #clock summer-time recurring 4 Sunday March 2:00 4 Sunday
October 2:00
DGS-6600:15 (config) #end
DGS-6600:15 #show clock

Current Time Source   : SNTP
Current Time         : 15:32:09, 2010-08-06
Time Zone            : UTC +08:00
Daylight Saving Time : Recurring
Offset in Minutes    : 60
    Recurring From   : Mar 4th Sun 02:00
                    To   : Oct 4th Sun 02:00
DGS-6600:15 #
```

In the following example, the user configures the Switch to move the time forward by one hour at 2:00:00 on March 29 and return to standard time at 2:00:00 (summer time) on October 25, and verifies the configuration:

```
DGS-6600:15 (config) #clock summer-time date 29 March 2:00 25 October 2:00
DGS-6600:15 (config) #end
DGS-6600:15 #show clock

Current Time Source   : SNTP
Current Time         : 15:32:09, 2010-08-06
Time Zone            : UTC +00:00
Daylight Saving Time : Annual
Offset in Minutes    : 60
    Annual From      : 29 Mar 02:00
                    To   : 25 Oct 02:00
DGS-6600:15 #
```

List of Constants and Default Settings

Constant Name	Value
Maximum Number of SNTP Servers	2

Table 7-1 Constants Values

Variable Name	Default Value
Summer Time	Disabled
Summer Time Offset	60 Minutes
Time Zone	UTC (Coordinated Universal Time)

Table 7-2 Default Variable Values

Variable Name	Default Value
Allow SNTP Broadcasts from SNTP Servers	Disabled
Default SNTP Server Setup	None

Table 7-2 Default Variable Values

Chapter 8

DGS-6600 Default Metric

Chapter Overview

Protocol		Default Distance*	Default Metric	Default Metric Command Reference
Protocol	Type			
Connected interface		0	N/A	
Static route		1	0	
BGP	External BGP Protocol (eBGP)	20	0	
	Internal BGP	200		
Open Shortest Path First (OSPF)		110	20	default-metric (OSPF)
OSPFv3		110	20	default-metric (IPv6 OSPF)
Routing Information Protocol (RIP)		120	1	default-metric (RIP)
RIPng		120	1	default-metric (RIP IPv6)
Unknown		255	N/A	

* Default distance refers to the Default value of "distance" command



Part 2- Interface and Hardware Configurations

The following chapters are included in this volume:

- **Interface Configuration**

Chapter 9

Interface Configuration

Chapter Overview

The following topics are included in this chapter, please go to the topic for more detailed information:

- [Chapter Overview](#)
 - [An Introduction to Interface Configuration](#)
- Identification of an Interface
 - [Switch Port Interface](#)
 - [Port Channel Interface](#)
 - [VLAN Interface](#)
 - [Out-of-Band \(OOB\) Management Port Interface](#)
- Configuration Commands
 - [Entering Interface Configuration Mode](#)
 - [Adding a Description to an Interface](#)
 - [Removing a Description from an Interface](#)
 - [Displaying Interface Status](#)
- Configuring Switch Port Interfaces
 - [Configuring Duplex Mode](#)
 - [Configuring Flow Control](#)
 - [Configuring Speed](#)
 - [Shutting Down an Interface](#)
 - [Configuring the Maximum Allowed Frame Size](#)
 - [Configuring the MTU](#)
 - [Configuring the MTU on a VLAN Interface](#)
 - [Clearing Counters](#)
- Configuring the OOB Management Interface
 - [Configuring the Maximum Allowed Frame Size](#)
 - [Configuring the MTU](#)
 - [Clearing Counters](#)
 - [Configuring the MTU on a VLAN Interface](#)
 - [Configuring an IP Address on the Management Interface](#)
 - [Configuring a Default Gateway on the OOB Management Interface](#)
 - [Shutting Down the Management Interface](#)
 - [Displaying the OOB Management Port Interface Status](#)
- List of Constants and Default Settings

An Introduction to Interface Configuration

This chapter describes the type of interfaces supported on the device, the features that can be configured on physical interfaces, and the common features that can be configured on any interface.

Identification of an Interface

An interface can be a physical port, VLAN, or channel-group. The Switch supports a number of different interfaces, which are listed below:

- Switch Port Interface
- Port Channel Interface
- VLAN Interface
- Out-of-Band (OOB) Management Port Interface

Switch Port Interface

For a physical port in an Ethernet switch, an interface-ID appears in the following format:

ethx.y

- **x**—For a standalone switch, this number is always 1. This can also represent the unit number (stackable system) or slot number (chassis system).
- **y**—The interface number on the Switch. The port numbers always begin at 1, starting on the left, when facing the front of the switch, for example, eth1.1, eth1.2.

Port Channel Interface

A channel group (link aggregated) interface, uses the following format:

port-channelGROUP-NUM

For example a channel group that has a group number of 3 would appear as **port-channel3**.

VLAN Interface

A VLAN interface always uses the following format:

vlanVLAN-ID

For example a VLAN that has an ID of 2 would appear as **vlan2**.

Out-of-Band (OOB) Management Port Interface

The OOB management port interface always uses the following format:

mgmt-if

Configuration Commands

The following topics are included in this section:

- [Entering Interface Configuration Mode](#)
- [Adding a Description to an Interface](#)
- [Removing a Description from an Interface](#)
- [Displaying Interface Status](#)

Entering Interface Configuration Mode

Use the following commands in global configuration mode to enter interface configuration mode or interface range configuration mode for all interfaces, except for the out-of-band management port interface.

Command	Explanation
<code>interface <i>INTERFACE-ID</i></code>	Enters interface configuration mode.
<code>interface range <i>INTERFACE-ID</i> [, -]</code>	Enters interface range configuration mode.

In the following example, the user enters interface configuration mode for Ethernet interface 5.1:

```
DGS-6600:2>enable
DGS-6600:15#configure terminal
DGS-6600:15 (config) #interface eth5.1
DGS-6600:15 (config-if) #
```

In the following example, the user enters interface configuration mode for the range of Ethernet interfaces 4.1-4.5:

```
DGS-6600:2>enable
DGS-6600:15#configure terminal
DGS-6600:15 (config) #interface range eth4.1-4.5
DGS-6600:15 (config-if) #
```

Adding a Description to an Interface

A description can be added to an interface or range of interfaces to help identify the function of the interface or range of interfaces.

Enter the following command in interface configuration mode to add a description to a specific interface:

Command	Explanation
<code>description <i>DESCRIPTION</i></code>	Adds a description, of up to 64 characters, to the interface.

In the following example, the user adds the description 'Comms-Uplink' to Ethernet port 4.1:

```
DGS-6600:2>enable
DGS-6600:15#configure terminal
DGS-6600:15 (config)#interface eth4.1
DGS-6600:15 (config-if)#description Comms-Uplink
DGS-6600:15 (config-if)#end
```

Removing a Description from an Interface

Enter the following command in interface configuration mode to remove a description from a specific interface:

Command	Explanation
<code>no description</code>	Removes a description from an interface.

In the following example, the user removes the description from Ethernet port 4.15:

```
DGS-6600:2>enable
DGS-6600:15#configure terminal
DGS-6600:15 (config)#interface eth4.15
DGS-6600:15 (config-if)#no description
DGS-6600:15 (config-if)#end
```

Displaying Interface Status

Enter the following command to display information about an interface on the Switch:

Command	Explanation
<code>show interface [INTERFACE-ID [, -]]</code>	Displays information about the interface.

In the following example, the user displays the information about interface VLAN99:

```
DGS-6600:2>show interface vlan99

vlan99 is up, line protocol is up (connected)
  Hardware is VLAN, address is 06-60-0c-10-00-98 (bia 06-60-0c-10-00-98)
  Description: link to Backbone
  IP MTU:1500bytes
  inet 10.73.87.100/8 broadcast 10.255.255.255
  inet6 10:73:87::100/64
  inet6 99::20/64
  inet6 fe80::460:cff:fe10:98/64

DGS-6600:2>
```

In the following example, the user displays information about Ethernet interface 4.1:

```
DGS-6600:2#show interface eth4.1

eth4.1 is up, line protocol is up (connected)
  Hardware is Ethernet, address is 00-01-02-03-04-00 (bia 00-01-02-03-04-00)
  Description:
  Full-duplex, 100Mb/s, medium type is Fiber, GBIC type is 100BASE-FX
(admin) Send flow-control is off, receive flow-control is off
(oper) Send flow-control is off, receive flow-control is off
  max-rcv-frame-size:1536bytes
  MTU:1500bytes
    RX rate: 9599876 bytes/sec, TX rate: 2399537 bytes/sec
    RX Bytes: 146264046, TX Bytes: 44013446
    RX rate: 141597 packets/sec, TX rate: 37650 packets/sec
    RX Frames: 2102120, TX Frames: 660755
    RX Unicast: 1025389, RX Multicast: 1992
    RX Broadcast: 1074738
    64: 2679551, 65-127: 63295, 128-255: 311
    256-511: 1765, 512-1023: 16388, 1024-1518: 1565
    RX CRC Error: 1, RX Undersize: 0
    RX Oversize: 0, RX Fragment: 0
    RX Jabber: 0, RX Dropped Pkts: 0
    RX MTU Exceeded: 0
    TX CRC Error: 0, TX Excessive Deferral: 0
    TX Single Collision: 0, TX Excessive Collision: 0
    TX Late Collision: 0, TX Collision: 0

DGS-6600:2>
```

Configuring Switch Port Interfaces

The following topics are included in this chapter:

- [Configuring Duplex Mode](#)
- [Configuring Flow Control](#)
- [Configuring Speed](#)
- [Shutting Down an Interface](#)
- [Configuring the Maximum Allowed Frame Size](#)
- [Configuring the MTU](#)
- [Configuring the MTU on a VLAN Interface](#)
- [Clearing Counters](#)

Configuring Duplex Mode

Use the following command to configure the duplex settings on a physical interface:

Command	Explanation
<code>duplex {full half auto} [copper]</code>	Specifies the duplex setting on the physical interface. The option [copper] is for a combo port set to duplex on a copper medium.

In the following example, the user configure the duplex settings on Ethernet interface 4.24 to be full-duplex:

```
DGS-6600:2>enable
DGS-6600:15#configure terminal
DGS-6600:15 (config)#interface eth4.24
DGS-6600:15 (config-if)#duplex full
DGS-6600:15 (config-if)#end
```

Configuring Flow Control

Use the following command to configure the flow control capability on a port:

Command	Explanation
<code>flowcontrol [send receive] {on off} [copper fiber]</code>	Specifies the flow control capability on the physical interface. The option [copper fiber] is for combo ports with set speed on specified medium.

In the following example, the user enables the flow control send capability on Ethernet interface 4.20:

```
DGS-6600:2>enable
DGS-6600:15#configure terminal
DGS-6600:15 (config)#interface eth4.20
DGS-6600:15 (config-if)#flowcontrol send on
DGS-6600:15 (config-if)#end
```

Configuring Speed

Use the following command in interface configuration mode to configure the speed settings on a physical interface:

Command	Explanation
<code>speed {10 100 1000 [master slave] auto [SPEED-LIST]} [copper fiber]</code>	Configures the speed of the physical interface. The option [copper fiber] is for the combo port set speeds on a specified medium.

In the following example, the user configures the speed of Ethernet Interface 4.45 to be 100 Mbps:

```
DGS-6600:2>enable
DGS-6600:15#configure terminal
DGS-6600:15 (config)#interface eth4.45
DGS-6600:15 (config-if)#speed 100
DGS-6600:15 (config-if)#end
```

Shutting Down an Interface

Use the following command in interface configuration mode to disable a port:

Command	Explanation
<code>shutdown</code>	Disables the specified interface.

In the following example, the user disables Ethernet Interface 4.40:

```
DGS-6600:2>enable
DGS-6600:15#configure terminal
DGS-6600:15 (config)#interface eth4.40
DGS-6600:15 (config-if)#shutdown
```

Configuring the Maximum Allowed Frame Size

Use the following command in interface configuration mode to configure the maximum Ethernet frame size that can be received on an interface:

Command	Explanation
<code>max-rcv-frame-size BYTES</code>	Specifies the maximum frame size that can be received on the interface.

In the following example, the user sets the maximum received frame size that can be received on Ethernet Interface 4.46 to be 6000 bytes:

```
DGS-6600:2>enable
DGS-6600:15#configure terminal
DGS-6600:15 (config)#interface eth4.46
DGS-6600:15 (config-if)#max-rcv-frame-size 6000
DGS-6600:15 (config-if)#end
```

Configuring the MTU

Use the following command in interface configuration mode to configure the MTU of an interface:

Command	Explanation
<code>mtu BYTES</code>	Specifies the MTU rate on the interface.

In the following example, the user sets the MTU to be 6000 bytes on Ethernet Interface 4.48:

```
DGS-6600:2>enable
DGS-6600:15#configure terminal
DGS-6600:15 (config)#interface eth4.48
DGS-6600:15 (config-if)#mtu 6000
DGS-6600:15 (config-if)#end
```

In the following example, the user restores the default maximum transmit packet size setting on Ethernet interface 4.48:

```
DGS-6600:2>enable
DGS-6600:15#configure terminal
DGS-6600:15 (config)#interface eth4.48
DGS-6600:15 (config-if)#default mtu
DGS-6600:15 (config-if)#end
```

Clearing Counters

Enter the following command in interface configuration mode to clear the counters on the entire Switch or on a specific interface:

Command	Explanation
<code>clear counters [INTERFACE-ID [, -]]</code>	Clears the counters on the entire Switch or on a specific interface.

In the following example, the user clears the counters for all physical ports:

```
DGS-6600:2>enable
DGS-6600:15#clear counters
```

In the following example, the user clears the counters for Ethernet interface 4.5:

```
DGS-6600:2>enable
DGS-6600:15#clear counters eth4.5
```

In the following example, the user clears the counters for Ethernet ports 4.1 to 4.10:

```
DGS-6600:2>enable
DGS-6600:15#clear counters eth4.1-4.10
```

Configuring VLAN Interfaces

The Switch allows the user to configure the MTU value on a VLAN interface.

Configuring the MTU on a VLAN Interface

Use the following command to configure the MTU value in a TCP/IP stack:

Command	Explanation
<code>ip mtu <i>BYTES</i></code>	Specifies the IP MTU value in the TCP/IP stack.

In the following example, the user configures the IP MTU value on VLAN interface 2 to be 6000:

```
DGS-6600:2>enable
DGS-6600:15#configure terminal
DGS-6600:15 (config)#interface vlan2
DGS-6600:15 (config-if)#ip mtu 6000
DGS-6600:15 (config-if)#end
```

Configuring the OOB Management Interface

The following topics are included in this section:

- [Configuring the Maximum Allowed Frame Size](#)
- [Configuring the MTU](#)
- [Clearing Counters](#)
- [Configuring the MTU on a VLAN Interface](#)
- [Configuring an IP Address on the Management Interface](#)
- [Configuring a Default Gateway on the OOB Management Interface](#)
- [Shutting Down the Management Interface](#)
- [Displaying the OOB Management Port Interface Status](#)

Configuring an IP Address on the Management Interface

Enter the following commands to configure the IP address of the out-of-band management interface:

Command	Explanation
<code>configure terminal</code>	Enters global configuration mode.
<code>mgmt-if</code>	Enters management interface mode.
<code>ip address IP-ADDRESS/PREFIX-LENGTH</code>	Specifies the IP address of the management interface.

In the following example, the user configures the IP address of the management interface to be 10.1.1.1 with an 8 bit subnet mask:

```
DGS-6600:2>enable
DGS-6600:15#configure terminal
DGS-6600:15 (config) #mgmt-if
DGS-6600:15 (mgmt-if) #ip address 10.1.1.1/8
DGS-6600:15 (mgmt-if) #end
```

Configuring a Default Gateway on the OOB Management Interface

Enter the following commands to configure a default gateway for the OOB management interface:

Command	Explanation
<code>configure terminal</code>	Enters global configuration mode.
<code>mgmt-if</code>	Enters management interface mode.
<code>default-gateway IP-ADDRESS</code>	Specifies the IP address of the management interface.

In the following example, the user configures the default gateway of the OOB management interface to be 10.1.1.254:

```
DGS-6600:2>enable
DGS-6600:15#configure terminal
DGS-6600:15 (config) #mgmt-if
DGS-6600:15 (mgmt-if) #default-gateway 10.1.1.254
DGS-6600:15 (mgmt-if) #end
```

Configuring the IP MTU on the OOB Management Interface

Enter the following commands to configure the IP MTU of the OOB management interface:

Command	Explanation
<code>configure terminal</code>	Enters global configuration mode.
<code>mgmt-if</code>	Enters management interface mode.
<code>ip mtu BYTES</code>	Specifies the IP MTU of the management interface.

In the following example, the user sets the MTU of the OOB management port to 1600 bytes:

```
DGS-6600:2>enable
DGS-6600:15#configure terminal
DGS-6600:15 (config) #mgmt-if
DGS-6600:15 (mgmt-if) #ip mtu 1600
DGS-6600:15 (mgmt-if) #end
```

Configuring an IPv6 Address on the OOB Management Interface

Enter the following commands to configure an IPv6 address on the out-of-band management interface:

Command	Explanation
<code>configure terminal</code>	Enters global configuration mode.
<code>mgmt-if</code>	Enters management interface mode.
<code>ipv6 address X:X::X:X/M</code>	Specifies the IPv6 address of the management interface.

In the following example, the user configures the IPv6 address of the OOB management interface to be 2043:1::43:11:33:192/48:

```
DGS-6600:2>enable
DGS-6600:15#configure terminal
DGS-6600:15 (config) #mgmt-if
DGS-6600:15 (mgmt-if) #ipv6 address 2043:1::43:11:33:192/48
DGS-6600:15 (mgmt-if) #end
```

Configuring a IPv6 Default Gateway on the OOB Management Interface

Enter the following commands to configure an IPv6 default gateway for the OOB management interface:

Command	Explanation
<code>configure terminal</code>	Enters global configuration mode.
<code>mgmt-if</code>	Enters management interface mode.
<code>ipv6 default-gateway X:X::X:X</code>	Specifies the IPv6 address of the management interface.

In the following example, the user configures the IPv6 default gateway of the OOB management interface to be 1::1:

```
DGS-6600:2>enable
DGS-6600:15#configure terminal
DGS-6600:15 (config) #mgmt-if
DGS-6600:15 (mgmt-if) #ipv6 default-gateway 1::1
DGS-6600:15 (mgmt-if) #end
```

Shutting Down the Management Interface

Enter the following commands to shutdown the OOB management port:

Command	Explanation
<code>configure terminal</code>	Enters global configuration mode.
<code>mgmt-if</code>	Enters management interface mode.
<code>shutdown</code>	Disables the out-of-band management port.

In the following example, the user disables the OOB management port:

```
DGS-6600:2>enable
DGS-6600:15#configure terminal
DGS-6600:15 (config) #mgmt-if
DGS-6600:15 (mgmt-if) #shutdown
DGS-6600:15 (mgmt-if) #end
```

Displaying the OOB Management Port Interface Status

Enter the following command to display information about the status of the management port, including user settings and link status:

Command	Explanation
<code>show mgmt-if</code>	Displays the status of the management port.

In the following example, the user displays the status of the OOB management port:

```
DGS-6600:2>show mgmt-if
Management Interface
-----
Admin Status           : Up
IPv4 Address           : 10.40.9.80/8
IPv4 Default Gateway   : 0.0.0.0
IPv6 Global Address    : 6600::66/64
IPv6 Link-local Address : fe80::48b:ff:fe10:0/64
IPv6 Default Gateway   : 6600::251
IP MTU                 : 1500
Link Status            : Down
DGS-6600:2>
```

List of Constants and Default Settings

Constant Name	Value
100 FX Interface Speed	100 Mbps
1000 SX Interface Speed	1000 Mbps
1000 LX Interface Speed	1000 Mbps

Table 9-1 Constants Values

Variable Name	Default Value
MTU	1536
Duplex	Auto
Flow Control	Both send and receive are off.
100 TX Interface Speed	Auto
1000 TX Interface Speed	Auto
Interface Description	Empty string.
Interface Shutdown State	No shutdown.
Management Interface Shutdown State	No shutdown.

Table 9-2 Default Variable Values



Part 3- Layer 2 Configurations

The following chapters are included in this volume:

- **VLAN Configuration**
- **VLAN Tunneling**
- **GARP VLAN Registration Protocol (GVRP) Configuration**
- **MAC Address Tables**
- **Spanning Tree Protocol (STP) Configuration**
- **Link Aggregation**
- **Proxy ARP**
- **Super VLAN**
- **Voice VLAN**
- **Ethernet Ring Protection Switching (ERPS)**

Chapter 10

VLAN Configuration

Chapter Overview

The following topics are included in this chapter, please go to the topic for more detailed information:

- [Chapter Overview](#)
 - [An Introduction to VLAN](#)
- [VLAN Configuration Commands](#)
 - [Creating a VLAN](#)
 - [Specifying an Access VLAN for an Interface](#)
 - [Specifying Trunk VLAN Mode for an Interface](#)
 - [Configuring Miscellaneous VLAN Attributes for an Interface](#)
 - [Configuring Protocol VLAN Groups](#)
 - [Creating a MAC-based VLAN Classification Entry](#)
 - [Creating a Subnet-based VLAN Classification Entry](#)
- [Configuration Examples](#)
 - [VLAN Configuration Examples](#)
- [Relations with Other Modules](#)
- [List of Constants and Default Settings](#)

An Introduction to VLAN

A Virtual Local Area Network (VLAN) is a fundamental feature of switching, and the DGS-6600 Switch. The physical counterpart of a VLAN, a Local Area Network (LAN), refers to a single physical switching domain. A VLAN is a virtual switched network, intended to provide groupings by logical location based on such considerations like: project team, department, or shared functionality.

By divorcing the need to consider physical location, it is possible to group end stations even if they are not physically located on the same LAN segment, allowing the demands for security and reduced broadcast flooding to be addressed with the VLAN feature.

By using VLAN, up to 4094 switching domains can be configured, with each switching domain using a different VLAN ID and functioning in a similar way to a physical LAN.

The DGS-6600 Switch automatically creates a VLAN called VLAN 1. VLAN1 is used as the default VLAN. The default VLAN has the following properties:

- The default VLAN cannot be deleted by users.
- By default all switch ports are access ports of the default VLAN.

The switching domain of a VLAN is defined by the member ports of the VLAN. The member ports of a VLAN can be either tagged VLAN members or untagged VLAN members. In general, access ports (ports which are connected to end users) are untagged member ports, and trunk ports (ports which are connected to other switches) are tagged member ports.

When a packet arrives at a port, before it is processed further, the packet will be classified with a VLAN ID. After the packet is given a specific VLAN classification, the subsequent processing, including address learning, filtering, and packet forwarding, will all be based on the assigned VLAN classification.

The forwarding port will be determined based on the packet status and the status of the transmitting port, if the transmitting port is a tagged member port, the packet will be transmitted in a tagged format. If the transmitting port is an untagged member port, the packet will be transmitted in an untagged format.

Packet Classification

The DGS-6600 Switch classifies and assigns the packet to a specific VLAN using the following rules:

- 1) If the packet contains an 802.1Q tag that specifies a VLAN ID, the packet will be classified with the VLAN specified in the 802.1Q tag.
- 2) If the packet is a priority tagged or untagged packet, the system will classify the packet using one of the following rules:
 - If a MAC-based classification rule is created, and the source MAC addresses of the packet match one of the rules, the VLAN will be classified based on this rule.
 - If a subnet-based classification rule is created, and a source IP address of the packet matches one of the rules, the VLAN will be classified based on this rule.
 - If no MAC or subnet-based classification rule is created, the packet will be classified with the default VLAN of the recipient port.

VLAN Configuration Commands

The following topics are included in this section:

- [Creating a VLAN](#)
- [Specifying an Access VLAN for an Interface](#)
- [Specifying Trunk VLAN Mode for an Interface](#)
- [Configuring Miscellaneous VLAN Attributes for an Interface](#)
- [Configuring Protocol VLAN Groups](#)
- [Creating a MAC-based VLAN Classification Entry](#)
- [Creating a Subnet-based VLAN Classification Entry](#)

Creating a VLAN

The user should create a VLAN before configuring a member port. If the user deletes a VLAN, all port membership will automatically be removed from the VLAN. When a VLAN is created, a default name is assigned to the VLAN. The user can modify the VLAN name if needed.

The following commands are used to create a VLAN:

Command	Explanation
<code>vlan <i>VLAN-ID</i> [, -]</code>	Used to create a VLAN or modify the attributes of a VLAN. After successfully entering this command, the Switch will enter VLAN configuration mode.
<code>vlan name <i>VLAN-NAME</i></code>	Used to modify the reference name of a VLAN.
<code>show vlan</code>	Displays the VLAN settings.

In the following example, the user creates a new VLAN, assigning a VLAN ID of 2 and the name "IT-Support". The user then enters the **show vlan** command to verify the configuration:

```
DGS-6600:15#configure terminal
DGS-6600:15 (config)#vlan 2
DGS-6600:15 (config-vlan)#vlan name IT-Support
DGS-6600:15 (config-vlan)#end
DGS-6600:15#show vlan

VLAN 1:
  Name: default
  GVRP advertisement: yes
  Static Tag Member Ports:
    eth4.48,
  Static Untag Member Ports:
    None
  GVRP Advertise Ports:
    eth4.1-eth4.48
  Forbidden Ports:
    None

VLAN 2:
  Name: IT-Support
  GVRP advertisement: yes
  Static Tag Member Ports:
    eth4.33, eth4.48,
  Static Untag Member Ports:
    eth4.2,
  GVRP Advertise Ports:
    eth4.1-eth4.45, port-channel5, port-channel3-port-channel4
  Forbidden Ports:
    eth4.1, eth4.40

DGS-6600:15#
```

Specifying an Access VLAN for an Interface

An interface can only be a member of one access VLAN at any given time. When the **access vlan** command is applied to an interface, the interface will operate in access mode. An interface can be defined as a physical port or a port-channel. If the **access vlan** command is applied to a port-channel, the member ports of the port-channel will become untagged members of the access VLAN. The default VLAN ID of the port will then be changed to the VLAN ID of the access VLAN. When a port is in access mode, no trunk VLANs can be defined for the port.

The following commands are used to specify an access VLAN for an interface and verify the VLAN interface settings:

Command	Explanation
<code>access vlan <i>VLAN-ID</i></code>	Configures the interface to operate in access mode and specifies the access VLAN of the interface.
<code>show vlan interface [<i>INTERFACE-ID</i>]</code>	Displays the VLAN settings specified for the interfaces on the Switch.

In the following example, the user specifies that Ethernet interface 4.2 should become an access member of VLAN 2 and verifies the configuration:

```
DGS-6600:15#configure terminal
DGS-6600:15 (config)#interface eth4.2
DGS-6600:15 (config-if)#access vlan 2
DGS-6600:15 (config-if)#end
DGS-6600:15#show vlan interface eth4.2
eth4.2
PVID                : 2
GVRP State          : Disabled
Ingress checked     : Enabled
Access VLAN         : 2
Advertise VLAN      : 1-4094
Forbidden VLAN      :
Acceptable frame types : admit-all

DGS-6600:15#
```

Specifying Trunk VLAN Mode for an Interface

When the user specifies the **trunk allowed-vlan** parameter on a port, the port will operate in trunk VLAN mode. If the port was previously operating in a different mode, all the related membership settings will be cleared.

Multiple trunk VLANs can be specified for a port, with the port becoming a tagged member of the trunk VLAN. When a port is in trunk mode, no access VLANs can be defined for the port.

The following commands are used to specify trunk VLAN mode for an interface and verify the VLAN interface settings:

Command	Explanation
<code>trunk allowed-vlan <i>VLAN-ID</i></code>	Configures the interface to operate in trunk mode and specifies the VLANs allowed to access the trunk connection.
<code>show vlan interface [<i>INTERFACE-ID</i>]</code>	Displays the VLAN settings specified for the interfaces on the Switch.

In the following example, the user specifies that Ethernet interface 4.48 should operate in trunk VLAN mode, allowing traffic from VLAN 2 to be sent and received on the trunk, and verifies the configuration:

```
DGS-6600:2>enable
DGS-6600:15#configure terminal
DGS-6600:15 (config)#interface eth4.48
DGS-6600:15 (config-if)#trunk allowed-vlan 2
DGS-6600:15 (config-if)#end
DGS-6600:15#show vlan interface eth4.48
eth4.48
PVID                : 1
GVRP State          : Disabled
Ingress checked     : Enabled
Trunk allowed VLAN  : 2
Advertise VLAN      : 1-4094
Forbidden VLAN      :
Acceptable frame types : admit-all

DGS-6600:15#
```

Configuring Miscellaneous VLAN Attributes for an Interface

There are three VLAN related parameters that the user can explicitly specify for an interface, if required. The interface can either be a physical port or a port-channel.

The acceptable frame type specifies the type of frames that are acceptable by the port. The user can specify if the Switch will accept tagged packets only, untagged packets only, or both.

When ingress checking is enabled, the system will check the VLAN membership of the recipient port against the classified VLAN of the ingress packet. If the recipient port is not member port of the classified VLAN, the packet will be dropped.

The following commands are used to configure miscellaneous VLAN attributes on an interface:

Command	Explanation
trunk allowed-vlan <i>VLAN-ID</i> [, -]	Specifies that the interface will operate in trunk mode.
acceptable-frame {tagged-only untagged-only admin-all}	Configures the acceptable frame type for an interface.
ingress-checking	Configures the ingress check function for an interface.
pvid <i>VLAN-ID</i>	Configures the default VLAN ID on the port.
hybrid vlan <i>VLAN-ID</i> [, -] {tagged untagged}	Specifies whether the interface will act as untagged or tagged member of the specified VLAN.
show vlan interface	Displays the configuration.

In the following example the user configures Ethernet 4.48 as a trunk port that only allows tagged frames from VLAN 2, enables the ingress checking function, specifies a PVID of 2, and verifies the configuration:

```
DGS-6600:15#configure terminal
DGS-6600:15 (config)#interface eth4.48
DGS-6600:15 (config-if)#trunk allowed-vlan 2
DGS-6600:15 (config-if)#acceptable-frame tagged-only
DGS-6600:15 (config-if)#ingress-checking
DGS-6600:15 (config-if)#pvid 2
DGS-6600:15 (config-if)#hybrid vlan 100 tagged
DGS-6600:15 (config-if)#end
DGS-6600:15#show vlan interface eth4.48
eth4.48
PVID                : 2
GVRP State          : Enabled
Ingress checked     : Enabled
Hybrid untagged VLAN :
Hybrid tagged VLAN  : 100
Advertise VLAN      : 1-4094
Forbidden VLAN      :
Acceptable frame types : tagged only

DGS-6600:15#
```

Configuring Protocol VLAN Groups

The Switch supports protocol-based VLANs. This standard, defined by the IEEE 802.1v standard maps packets to protocol-defined VLANs by examining the type octet within the packet header to discover the type of protocol associated with it. After assessing the protocol, the Switch will forward the packets to all ports within the protocol-assigned VLAN. This feature will benefit the administrator by better balancing load sharing and enhancing traffic classification.

The following commands are used to configure protocol VLAN groups and configure the interfaces that the groups will be bound to:

Command	Explanation
<code>dot1v protocol-group <i>GROUP-ID</i> frame {ethernet2 snap llc} <i>TYPE-VALUE</i></code>	Adds a protocol to a protocol group.
<code>dot1v binding protocol-group <i>GROUP-ID</i> vlan <i>VLAN-ID</i></code>	Configures a new protocol group and binds the group to an interface.
<code>show dot1v {protocol-group [<i>GROUP-ID</i> [, -]] interface [<i>INTERFACE-ID</i> [, -]] }</code>	Verifies the protocol group configuration.

In the following example, the user adds the Ethernet II type frame value of 0x2311 to protocol group 10, binds the group to VLAN 100 on Ethernet interface 4.48, and finally verifies the configuration:

```
DGS-6600:2>enable
DGS-6600:15#configure terminal
DGS-6600:15 (config) #dot1v protocol-group 10 frame ethernet2 0x2311
DGS-6600:15 (config) #interface eth4.48
DGS-6600:15 (config-if) #dot1v binding protocol-group 10 vlan 100
DGS-6600:15 (config-if) #end
DGS-6600:15#show dot1v interface eth4.48
Interface      dot1v Group ID/Binding-VLAN
-----
eth4.48        10/100
DGS-6600:15#
```

Creating a MAC-based VLAN Classification Entry

A MAC-based VLAN classification entry defines the rule for classifying a VLAN based on the source MAC address of a packet. The untagged packet or priority tagged packet will be matched against the rule for VLAN classification. If the source MAC address of the packet matches the MAC address defined by the entry, the packet will be classified to the VLAN associated with the entry.

The following command is used to make an existing VLAN a MAC-based VLAN:

Command	Explanation
<code>mac-base MAC-ADDRESS</code>	Configures the VLAN as a MAC-based VLAN.

In the following example, the user creates a new VLAN called "VLAN5" and specifies that the VLAN will be a MAC-based VLAN, with a MAC address of "00:11:22:33:ab:cd":

```
DGS-6600:2>enable
DGS-6600:15#configure terminal
DGS-6600:15 (config) #vlan 5
DGS-6600:15 (config-vlan) #mac-base 00-11-22-33-ab-cd
DGS-6600:15 (config-vlan) #end
```

Creating a Subnet-based VLAN Classification Entry

The Subnet-based VLAN classification entry defines the rule for classifying a VLAN based on the source IP address of the packet. The untagged packet or priority tagged packet will be matched against the rule for VLAN classification. If the source IP address of the packet matches the IP subnet defined by the entry, the packet will be classified to the VLAN associated with the entry.

The following command is used to make an existing VLAN a subnet-based VLAN:

Command	Explanation
<code>subnet-base {NETWORK-PREFIX NETWORK-MASK NETWORK-PREFIX/PREFIX-LENGTH}</code>	Configures the VLAN as a subnet-based VLAN.

In the following example, the user creates a new VLAN called “VLAN6” and specifies that the VLAN will be a subnet-based VLAN, for the subnets “20.0.1.0/8” and “192.168.1.0/24”:

```
DGS-6600:2>enable
DGS-6600:15#configure terminal
DGS-6600:15 (config)#vlan 6
DGS-6600:15 (config-vlan)#subnet-base 20.0.1.0/8
DGS-6600:15 (config-vlan)#subnet-base 192.168.1.0/24
DGS-6600:15 (config-vlan)#end
```

Configuration Examples

VLAN Configuration Examples

In this example, two VLANs, VLAN2 and VLAN3, are created in both devices. Port eth2.5 are VLAN2 and VLAN3 trunk (overlapped tagged) ports between the two devices. eth2.1-2.2, and eth2.3-2.4 are access ports for VLAN2 and VLAN3, respectively.

Topology

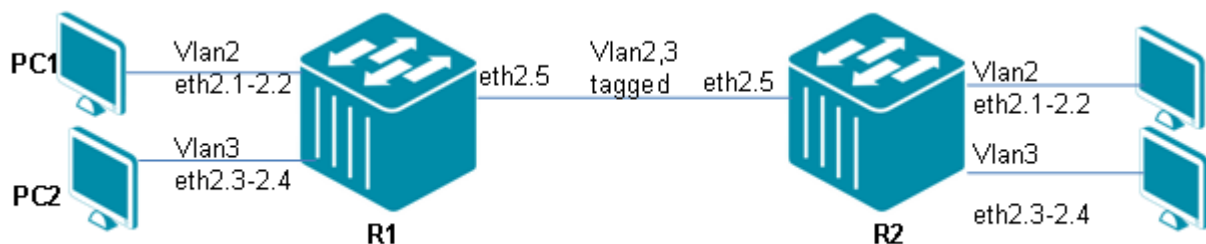

Figure 10-1 Configuration Topology

R1 (Router 1) Configuration Steps

Step 1. Create vlan 2 and 3.

```
DGS-6600:15 (config)#vlan 2
DGS-6600:15 (config-vlan)#vlan 3
```

Step 2: Add port into VLAN. Ports eth2.1-2.2 and eth2.3-2.4 are access ports of VLAN2 and VLAN3, respectively. Port eth2.5 is a trunk port of VLAN2 and VLAN3.

```
DGS-6600:15 (config-vlan)#interface range eth2.1-2.2
DGS-6600:15 (config-if)# access vlan 2
DGS-6600:15 (config-if)#interface range eth2.3-2.4
DGS-6600:15 (config-if)# access vlan 3
DGS-6600:15 (config-if)#interface eth2.5
DGS-6600:15 (config-if)# trunk allowed-vlan 2
DGS-6600:15 (config-if)# trunk allowed-vlan 3
```

R2 (Router 2) Configuration Steps

Step1: Create vlan 2 and 3

```
DGS-6600:15(config)#vlan 2
DGS-6600:15(config-vlan)# vlan 3
```

Step2: Add port into VLAN. Ports eth2.1-2.2 and eth2.3-2.4 are access ports of VLAN2 and VLAN3, respectively. Port eth2.5 is the trunk port of VLAN2 and VLAN3.

```
DGS-6600:15(config-vlan)#interface range eth2.1-2.2
DGS-6600:15(config-if)# access vlan 2
DGS-6600:15(config-if)#interface range eth2.3-2.4
DGS-6600:15(config-if)# access vlan 3
DGS-6600:15(config-if)#interface eth2.5
DGS-6600:15(config-if)# trunk allowed-vlan 2
DGS-6600:15(config-if)# trunk allowed-vlan 3
```

Verifying the Configuration Example

Step 1: Use "show vlan" command to check the VLAN configuration. R1 is used as the example to show the output.

```
DGS-6600:15# show vlan 2,3

VLAN 2:
  Name: VLAN0002
  GVRP advertisement: yes
  Static Tag Member Ports:
    eth2.5,
  Static Untag Member Ports:
    eth2.1, eth2.2,
  GVRP Advertise Ports:
    eth2.1-eth2.48, eth4.1-eth4.48
  Forbidden Ports:
    None

VLAN 3:
  Name: VLAN0003
  GVRP advertisement: yes
  Static Tag Member Ports:
    eth2.5,
  Static Untag Member Ports:
    eth2.3, eth2.4,
  GVRP Advertise Ports:
    eth2.1-eth2.48, eth4.1-eth4.48
  Forbidden Ports:
    None
```

Notes: PC1 and PC3 can ping each other. PC2 and PC4 can ping each. This indicates the PCs are in the same VLAN and can communicate each other.

PC1 cannot ping PC2 or PC4. PC2 cannot ping PC1 and PC3. This indicates PC is in a different VLAN and cannot communicate with each other.

PC's on the same VLAN can communicate with each other on the same device, or across devices. PC's within different VLAN's cannot communicate with each other on the same device or across devices.

Relations with Other Modules

- 1) Port security settings cannot be configured on a channel group member port.
- 2) The VLAN related settings of different ports must be consistent for them to be grouped into a port channel group.
- 3) When a port is removed from port channel group, the previous VLAN related settings will be reset to default values.

List of Constants and Default Settings

Constant Name	Value
Maximum Number of Static VLANs	4094
Maximum Number of MAC-based VLAN Entries	8192
Maximum Number of Subnet-based VLAN Entries	512

Table 10-1 Constants Values

Variable Name	Default Value
VLAN	VLAN 1 is the system default VLAN
acceptable-frame	Admit-all
ingress-checking	Enabled
PVID	1

Table 10-2 Default Variable Values

Chapter 11

VLAN Tunneling

Chapter Overview

The following topics are included in this chapter, please go to the topic for more detailed information:

- [Chapter Overview](#)
 - [An Introduction to VLAN Tunneling](#)
- [VLAN Tunneling Configuration Commands](#)
 - [Enabling VLAN Tunneling](#)
 - [Specifying UNI/NNI Ports](#)
 - [Configuring NNI Port S-Tag TPID](#)
 - [Removing the Inner Tag of an Incoming Packet](#)
 - [Creating VLAN Encapsulation Rules](#)
 - [Creating VLAN Remarking Rules](#)
 - [Creating CoS Remarking Rules](#)
 - [Configuring Ingress Checking](#)
 - [Verifying the VLAN Tunneling Configuration](#)
- [Configuration Examples](#)
 - [QinQ Configuration Example](#)
- [List of Constants and Default Settings](#)

An Introduction to VLAN Tunneling

This chapter describes how to configure IEEE 802.1Q VLAN Tunneling. VLAN tag uses 12 bits to identify 4094 VLANs, which is insufficient for identifying a large mass of users. To solve this problem, the VLAN tunnel feature was developed, which maps VLAN tags within a second layer of tags. The implementation of an extra VLAN tag squares the number of potential VLANs, making a total of 16 million. By using this feature, service providers can use a single VLAN to support customers that have multiple VLANs, therefore allowing traffic from different customer VLANs to be segregated. Below are a list of introductory topics, regarding VLAN on the DGS-6600 Series Switch:

- [VLAN Encapsulation](#)
- [VLAN Remarking](#)
- [CoS Remarking](#)
- [Packet Forwarding Flow](#)
 - [Tunnel Table](#)
 - [VLAN Tunnel TPID](#)
 - [VLAN Tunnel Ingress Check](#)
- [UNI to NNI or UNI to UNI Forwarding](#)
 - [Determining the S-VLAN](#)
 - [Determining the Forwarding Port](#)

- *UNI to NNI*
- *CoS Remarking*
- *VLAN-Tunnel TPID*
- *UNI to UNI*
- *UNI to UNI for VLAN Remarking Feature*
- *VLAN Remarking UNI to NNI*
- *NNI to UNI or NNI to NNI Forwarding*
- *Determining the S-VLAN*
- *Determining the Forwarding Port*
- *NNI to UNI*
- *NNI to NNI*

VLAN Encapsulation

VLAN encapsulation is also known as VLAN stacking or Q-in-Q. VLAN encapsulation inserts a second VLAN (service provider VID, S-VID) as an outer tag for packets that are being transmitted from the Networks-to-Network Interface (NNI). Instead of changing the customer’s original VLAN tag information, the VLAN mapping mechanism adds more service provider VLAN tags to traverse the service provider networks. Typically, there is a many-to-one mapping relationship between multiple C-VIDs and the S-VID. At UNI ingress ports, the outer S-Tag is stacked on top of a C-Tag. At UNI egress ports, the outer S-Tag is removed.

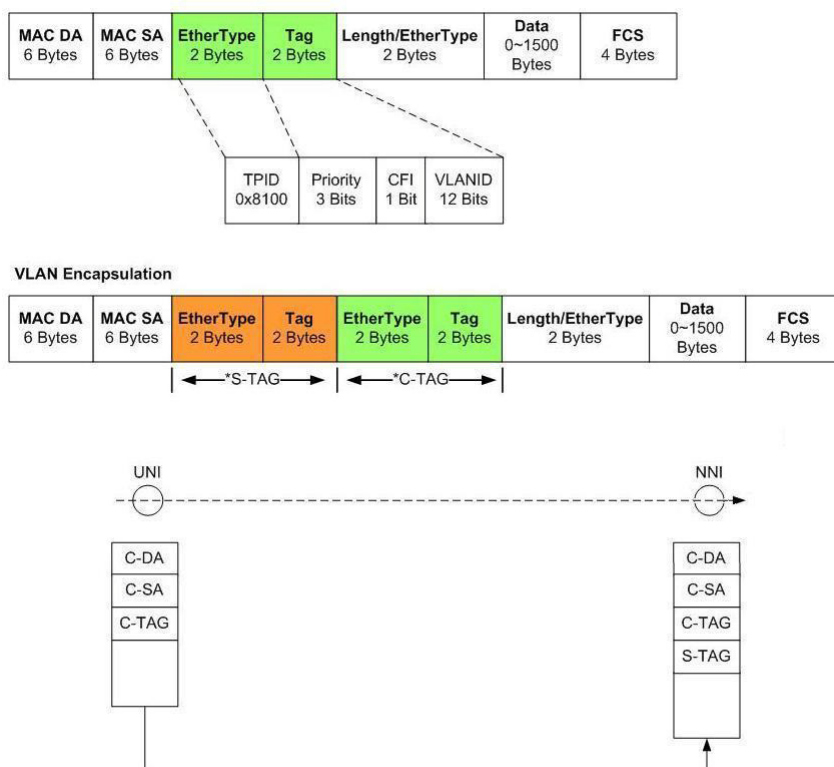
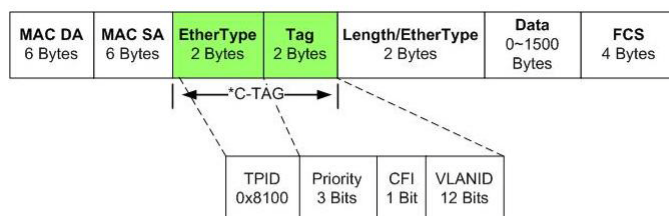

Figure 11-1 Tagged Frames from UNI to NNI with VLAN Encapsulation Feature

VLAN Remarking

VLAN Remarking replaces (overwrites) the customer VLAN tag as the packets are transmitted at the Networks-to Network Interface (NNI). The system does not insert an additional VLAN tag. Instead, the system remarks the original VLAN information in order to traverse the service provider’s networks. Non-stacking S-Tags are never stacked on top of a C-Tag. There is typically a one-to-one mapping relationship between a C-VID and an S-VID, making it unnecessary to carry the C-Tag in the provider network. On UNI ingress ports, the non-stacking S-Tag replaces the C-Tag. On UNI egress ports, the non-stacking S-Tag is replaced by a C-Tag.



VLAN Remarking

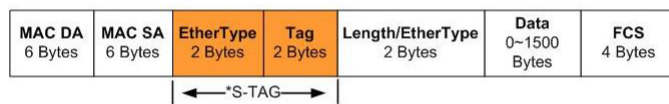

*S-TAG: Service Provider VLAN Tag
 *C-TAG: Customer VLAN Tag



Figure 11-2 VLAN Remarking Operation

CoS Remarking

The S-CoS can be determined by matching one of the following conditions:

- CoS Retain- The C-CoS is retained into the S-CoS priority tag. If there is no C-Tag, the default port priority is used as the C-CoS priority.
- CoS Remarking is carried out according to the ingress port number (if not specified, the default port priority is used for the S-CoS).
- CoS Remarking according to the ingress port and C-VID.

Packet Forwarding Flow

Tunnel Table

A VLAN tunnel table is defined for each UNI port. Each entry describes whether VLAN encapsulation or remarking is being carried out, and whether to trust the C-Tag CoS or remark the CoS for each C-VID.

VLAN Tunnel TPID

A VLAN Tunnel TPID is defined for each NNI port. The VLAN Tunnel TPID is used for encoding S-Tags, or used to identify if the packet is an S-Tagged packet.

VLAN Tunnel Ingress Check

If the Switch receives a tagged packet, the Switch searches the VLAN tunnel table (including VLAN encapsulation and VLAN remarking) using the packet VLAN ID and the ingress port. If there is an entry miss, then the packet will either be dropped or have an S-VLAN (service provider VLAN) tag added that is based on the VLAN lookup tables (MAC, Subnet, Protocol, Port VLAN ID). When VLAN tunnel ingress filtering is enabled, the translation miss packet is dropped. If an S-VLAN tag is added to the translation miss packet and forwarded to the S-VLAN, it is referred to as VLAN tunnel ingress-checking disabled.

UNI to NNI or UNI to UNI Forwarding

Determining the S-VLAN

- If the packet is a C-Tagged packet, the S-VLAN is determined based on the tunnel table.
- If the C-Tag has no tunnel table hits and the ingress check is enabled, the packet will be dropped.
- If the C-Tag has no tunnel table hits or the packet has no C-VID, the S-VLAN is resolved based on the MAC-based VLAN, Subnet-based VLAN, Protocol-based VLAN, or Port-based VLAN.

Determining the Forwarding Port

Packets received on a UNI port should be forwarded to the correct port according to the DA and S-VLAN information. The forwarding port can either be a UNI port or an NNI port.

UNI to NNI

If the receiving packet hits a tunnel table entry, either the S-Tag remark or encapsulation process will be carried out, depending on whether the entry is a remark or an encapsulation entry.

If the packet received has no tunnel table hits or the packet has no C-Tag, the packet will be encapsulated with an S-Tag.

CoS Remarking

The S-CoS can be determined based on one of the following conditions:

- If the packet has no C-Tag, the default port priority is used for S-CoS.
- If the packet has a C-Tag, but the tunnel table lookup fails, then C-CoS will be used.
- If there is a tunnel table hit, the Switch will remark the S-Tag CoS or trust the Tag CoS.

VLAN-Tunnel TPID

The VLAN tunnel TPID defined for the NNI port will be encoded in S-Tag.

The following diagram shows the operation of the untagged frames from UNI to NNI with the VLAN encapsulation feature:

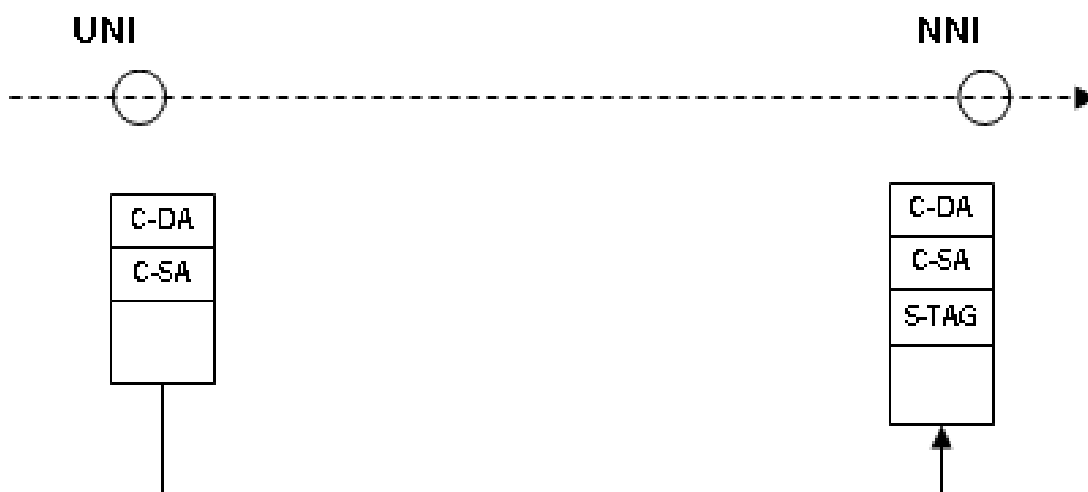

Figure 11-3 Untagged Frames from UNI to NNI with VLAN Encapsulation Feature

The following diagram shows the operation of the tagged frames from UNI to NNI with the VLAN encapsulation feature:

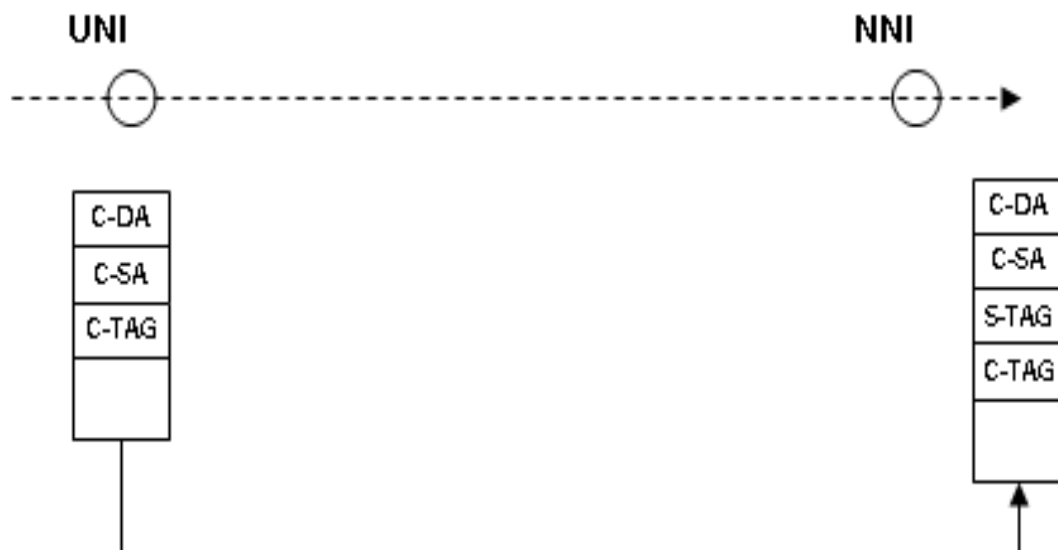

Figure 11-4 Tagged Frames from UNI to NNI with VLAN Encapsulation Feature

UNI to UNI

If the forwarding port is a UNI port, the packet will be retained without encapsulating the S-VLAN or remarking with the S-VLAN information.

UNI to UNI for VLAN Remarking Feature

The following diagram shows the operation of the UNI to UNI for VLAN remarking feature:

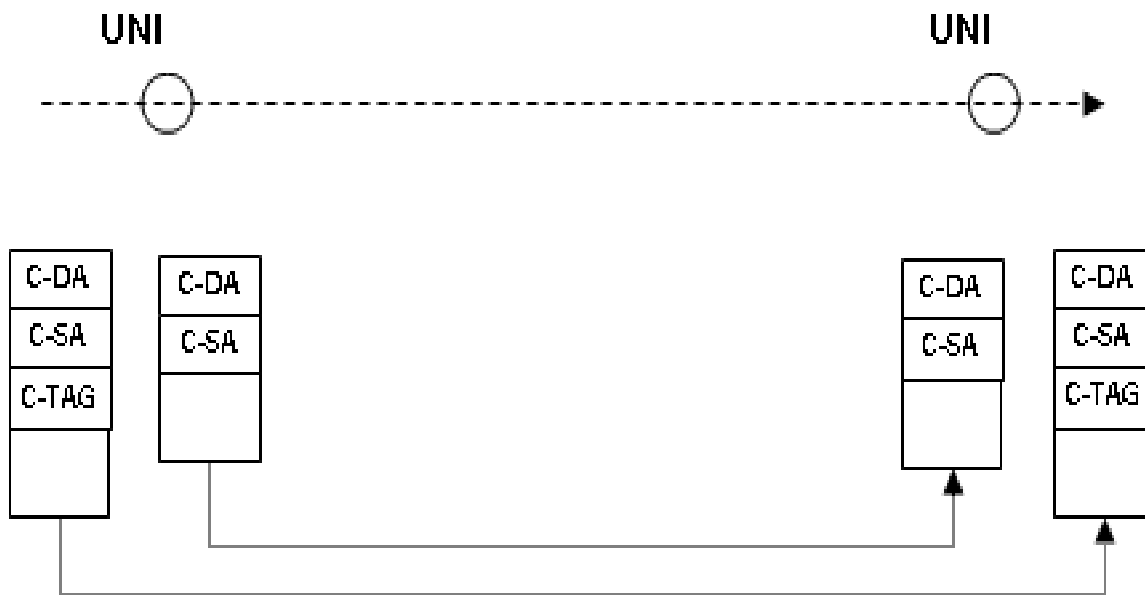

Figure 11-5 UNI to UNI for VLAN Remarking Feature

VLAN Remarking UNI to NNI

The Figure below shows the requirement for VLAN remarking from UNI to NNI. A C-tag will be replaced by S-tag. The receiving packet should be forwarded to the correct NNI port according to C-DA and S-TAG information.

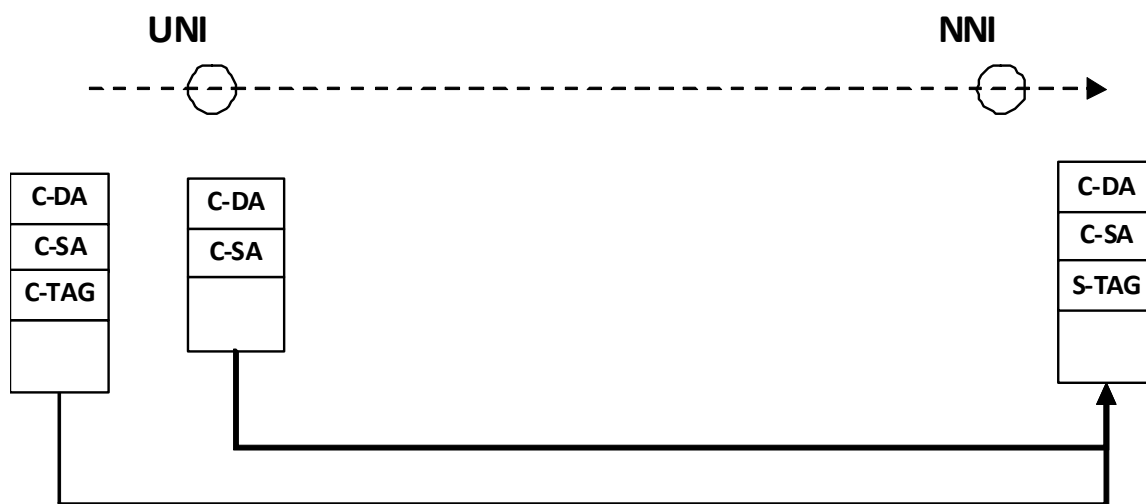

Figure 11-6 UNI to NNI for VLAN remarking feature.

NNI to UNI or NNI to NNI Forwarding

Determining the S-VLAN

- If the packet is an S-Tagged packet, get the S-VLAN from the S-Tag. The VLAN tunnel TPID is used to identify the S-Tag.

- If the packet is untagged and VLAN tunnel ingress check is enabled, the packet will be dropped.
- If the packet is untagged, the S-VLAN will be resolved as if the packet was an untagged packet.

Determining the Forwarding Port

The packets received on a UNI port should be forwarded to the correct port according to the DA and S-VLAN information. The forwarding port can be a UNI port or an NNI port.

NNI to UNI

- If the packet is an S-Tagged packet, the tunnel table will be searched based on the S-VID.
- If the VLAN encapsulation entry is hit or miss, the S-tag will be removed.
- If the hit entry is a remark entry, the S-VID in the S-Tag will be replaced by the C-VID.
- If the tunnel table misses or has no S-Tag, the untagged packet will be transmitted.

The following diagram shows the operation of an NNI to UNI VLAN encapsulation:



Figure 11-7 NNI to UNI for VLAN Encapsulation Table

The following diagram shows the operation of an NNI to UNI for VLAN remarking table hit:



Figure 11-8 NNI to UNI for VLAN Remarking Table Hit

The following diagram shows the operation of an NNI to UNI for VLAN remarking table miss:

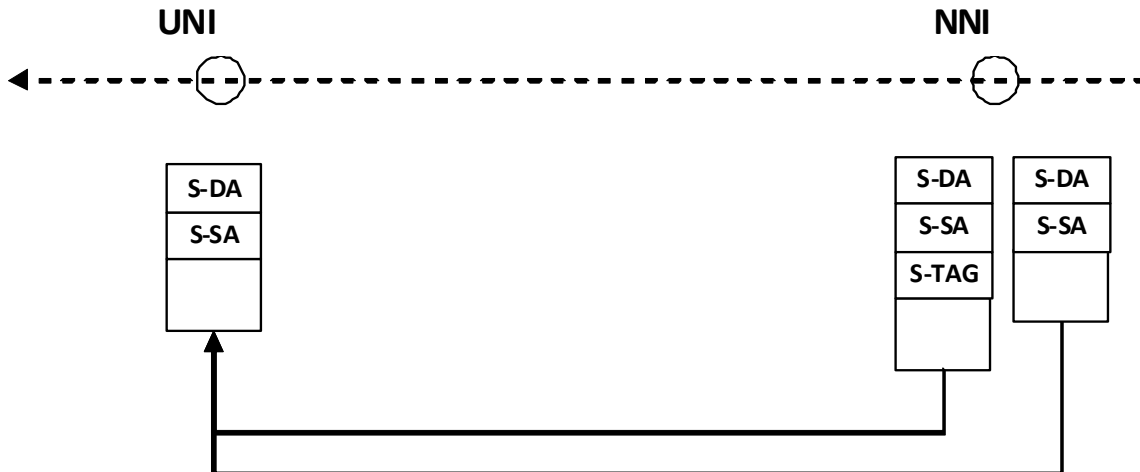

Figure 11-9 NNI to UNI VLAN Remarking Table Miss

NNI to NNI

If the received packet is already S-Tagged, the packet content is retained. If the received packet has no S-Tag, the S-Tag will be added.

The following diagram shows the operation of NNI to NNI with an S-Tag packet:



Figure 11-10 NNI to NNI Operation with S-Tag Packet

The following diagram shows the operation of NNI to NNI without an S-Tag packet:

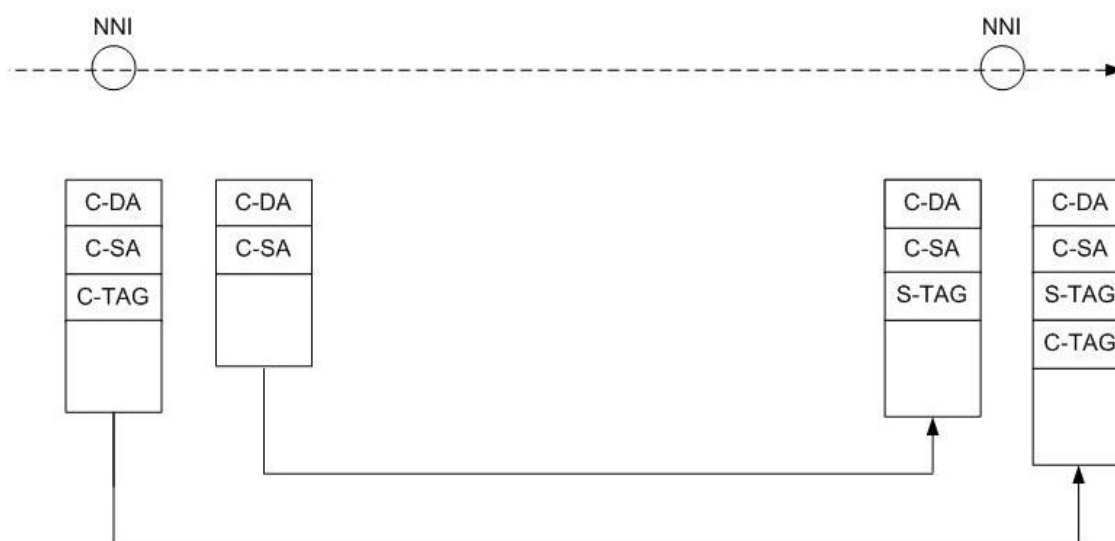

Figure 11-11 NNI to NNI Operation without S-Tag Packet

VLAN Tunneling Configuration Commands

The following topics are included in this section:

- [Enabling VLAN Tunneling](#)
- [Specifying UNI/NNI Ports](#)
- [Configuring NNI Port S-Tag TPID](#)

- [Removing the Inner Tag of an Incoming Packet](#)
- [Creating VLAN Encapsulation Rules](#)
- [Creating VLAN Remarking Rules](#)
- [Creating CoS Remarking Rules](#)
- [Configuring Ingress Checking](#)
- [Verifying the VLAN Tunneling Configuration](#)

Enabling VLAN Tunneling

By default, the system operates in Single Tag mode. The user needs to explicitly enable VLAN tunnel mode on the Switch. Other VLAN-tunnel commands can only be entered after VLAN tunnel mode has been enabled. When VLAN tunnel mode is enabled, the following settings are automatically applied.

- 1) All interfaces are set to operate as Network-to-Network Interface (NNI) ports.
- 2) All existing static VLANs will run as SP-VLANs, and all dynamically learned L2 addresses need to be cleared.
- 3) All dynamically registered VLAN entries will be cleared and GVRP will be disabled.
- 4) If the user needs to run GVRP on the Switch, GVRP should be manually enabled. In VLAN tunnel mode, the SP-VLAN GVRP address (01-80-C2-00-00-0D) will be used by the GVRP protocol.

Use the following command in global configuration mode to enable the VLAN tunneling feature:

Command	Explanation
<code>vlan-tunnel</code>	Enables the VLAN tunneling feature.

In the following example, the user enables VLAN tunneling on the Switch:

```
DGS-6600:2>enable
DGS-6600:15#configure terminal
DGS-6600:15(config)#vlan-tunnel
DGS-6600:15(config)#end
```

Specifying UNI/NNI Ports

When the system is in VLAN tunnel mode, each port will be either a UNI (user to network) port or an NNI (network to network) port. The UNI port should be configured as an untagged port to remove the S-TAG. A UNI port should be configured as a tagged port only when it has VLAN remarking rules.

Use the following command to determine if an interface should take on an NNI or a UNI port role:

Command	Explanation
<code>vlan-tunnel interface-type {nni uni}</code>	Specifies if the port will be a UNI or NNI port.

In the following example, the user configures Ethernet interface 4.8 to be an NNI port:

```
DGS-6600:2>enable
DGS-6600:15#configure terminal
DGS-6600:15 (config)#interface eth4.8
DGS-6600:15 (config-if)#vlan-tunnel interface-type nni
DGS-6600:15 (config-if)#end
```

Configuring NNI Port S-Tag TPID

The user can use the following command to set the TPID for the S-Tag that will be used by an NNI port:

Command	Explanation
<code>vlan-tunnel tpid <i>TPID</i></code>	Sets the TPID value of the S-Tag that will be used by the NNI port.

In the following example, the user sets the TPID value on Ethernet interface 4.12 to be "0x88a0":

```
DGS-6600:2>enable
DGS-6600:15#configure terminal
DGS-6600:15 (config)#interface eth4.12
DGS-6600:15 (config-if)#vlan-tunnel interface-type nni
DGS-6600:15 (config-if)#vlan-tunnel tpid 0x88a0
DGS-6600:15 (config-if)#end
```

Removing the Inner Tag of an Incoming Packet

The user can enter the following command to remove the inner tag from any packets received by an interface that is configured to operate as a UNI port:

Command	Explanation
<code>vlan-tunnel remove-inner-tag</code>	Specifies that the interface will remove the inner tag from any packets that are received.

In the following example, the user specifies that the inner tag will be removed from any packets that are received by interface eth4.20:

```
DGS-6600:2>enable
DGS-6600:15#configure terminal
DGS-6600:15 (config)#interface eth4.20
DGS-6600:15 (config-if)#vlan-tunnel remove-inner-tag
DGS-6600:15 (config-if)#end
```

Creating VLAN Encapsulation Rules

The user can use the following command to create VLAN encapsulation entries on a UNI port:

Command	Explanation
<code>vlan encapsulation S-VID C-VID [, -]</code>	Creates VLAN encapsulation entries on a UNI port.

In the following example, the user specifies that any packets originating from Ethernet interface 4.22, with an inner-VID value of 4 and an outer-VID value of 2 will be encapsulated:

```
DGS-6600:2>enable
DGS-6600:15#configure terminal
DGS-6600:15 (config)#interface eth4.22
DGS-6600:15 (config-if)#vlan-tunnel interface-type uni
DGS-6600:15 (config-if)#vlan encapsulation 4 2
DGS-6600:15 (config-if)#end
```

Creating VLAN Remarking Rules

The user can use the following command to create VLAN remarking entries on a UNI port:

Command	Explanation
<code>vlan remarking S-VID C-VID [, -]</code>	Creates VLAN remarking entries on a UNI port.

In the following example, the user configures the Switch to remark the service providers with a VLAN tag of 8 to the customer VLAN with a VLAN tag of 9, on Ethernet interface 4.23:

```
DGS-6600:2>enable
DGS-6600:15#configure terminal
DGS-6600:15 (config)#interface eth4.23
DGS-6600:15 (config-if)#vlan-tunnel interface-type uni
DGS-6600:15 (config-if)#vlan remarking 8 9
DGS-6600:15 (config-if)#end
```

Creating CoS Remarking Rules

The user can use the following command to create CoS remark entries on a UNI port:

Command	Explanation
<code>cos remarking NEW-COS [C-VID[, -]]</code>	Creates CoS remark entries on the specified UNI port.

In the following example, the user creates a CoS remark entry on Ethernet interface 4.24 that remarks CoS value 2 to the customer VLAN with a VLAN ID of 4:

```
DGS-6600:2>enable
DGS-6600:15#configure terminal
DGS-6600:15 (config)#interface eth4.24
DGS-6600:15 (config-if)#vlan-tunnel interface-type uni
DGS-6600:15 (config-if)#cos remarking 2 4
DGS-6600:15 (config-if)#end
```

Configuring Ingress Checking

The user can use the following command to control the ingress check function on a UNI port:

Command	Explanation
<code>vlan-tunnel ingress-checking</code>	Enables the ingress check function on the specified port.

In the following example, the user enables the VLAN tunnel ingress check function on Ethernet interface 4.33:

```
DGS-6600:2>enable
DGS-6600:15#configure terminal
DGS-6600:15 (config)#interface eth4.33
DGS-6600:15 (config-if)#vlan-tunnel interface-type uni
DGS-6600:15 (config-if)#vlan-tunnel ingress-checking
DGS-6600:15 (config-if)#end
```

Verifying the VLAN Tunneling Configuration

The user can use the following command to display the VLAN tunnel related settings:

Command	Explanation
<code>show vlan-tunnel [INTERFACE-ID[, -]]</code>	Displays the VLAN tunnel related settings.

In the following example, the user displays the VLAN tunnel related settings for Ethernet interface 4.20 to 4.30 :

```
DGS-6600:2>show vlan-tunnel eth4.20-4.30
VLAN tunneling: enabled

eth4.20: UNI port, CoS remarking: disabled, ingress-checking: disabled,
remove-inner-tag: enabled
VLAN          S-VID  C-VID  CoS
-----
eth4.21: NNI port, TPID: 0x88a8
eth4.22: UNI port, CoS remarking: disabled, ingress-checking: disabled,
remove-inner-tag: disabled
VLAN          S-VID  C-VID  CoS
-----
encapsulation  2      4      trusted

eth4.23: UNI port, CoS remarking: disabled, ingress-checking: disabled,
remove-inner-tag: disabled
VLAN          S-VID  C-VID  CoS
-----
remarking      8      9      trusted

eth4.24: UNI port, CoS remarking: disabled, ingress-checking: disabled,
remove-inner-tag: disabled
VLAN          S-VID  C-VID  CoS
-----

eth4.25: NNI port, TPID: 0x88a8
eth4.26: NNI port, TPID: 0x88a8
eth4.27: NNI port, TPID: 0x88a8
eth4.28: NNI port, TPID: 0x88a8
eth4.29: NNI port, TPID: 0x88a8
eth4.30: NNI port, TPID: 0x88a8
DGS-6600:2>
```

Configuration Examples

QinQ Configuration Example

R1 eth2.1 and eth2.2 are QinQ uni ports. Eth2.3 is a nni port. The packet ingress from R1 eth2.1 (having C-tag=2) will be added to S-tag 1002. The packet ingress from R1 eth2.2 (having C-tag=2) will be added to S-tag 1003. The packet egress from R1 eth2.3 will have double tagging (S-tag and C-tag) and will be sent to R2. Customer#2 VLAN2 can communicate each other, but cannot communicate to Customer#3 VLAN2.

Topology

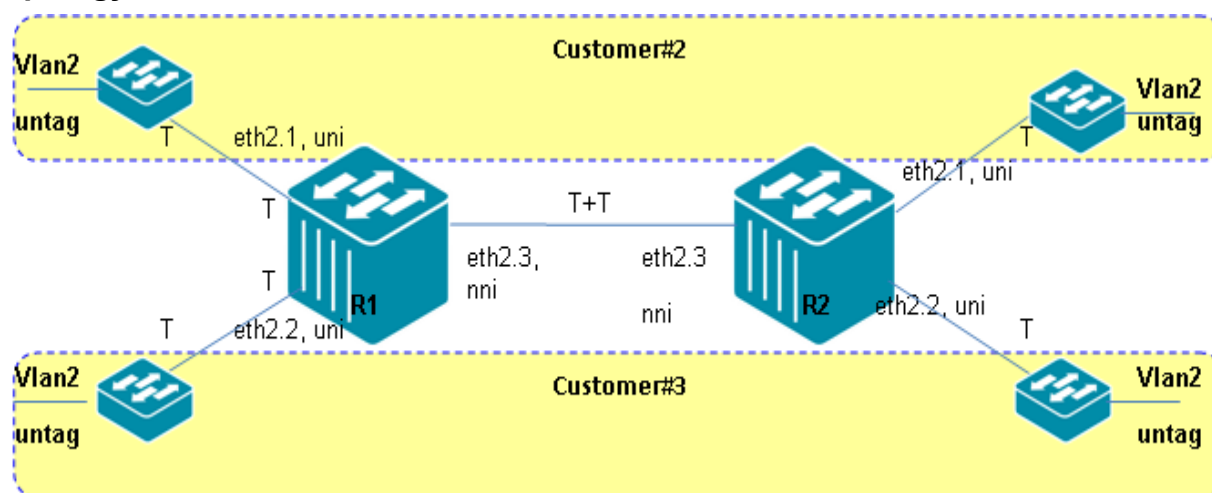

Figure 11-12 Q-in-Q Configuration Example Topology

R1 (Router 1) Configuration Steps

Step 1: Enable QinQ

```
DGS-6600:15 (config) #vlan-tunnel
```

Step 2: Create vlan 1002, 1003

```
DGS-6600:15 (config) #vlan 1002
DGS-6600:15 (config-vlan) #vlan 1003
```

Step 3: Add port into vlan. Set eth2.1-2.2 as UNI port, and eth2.3 as nni-port (default value).

```
DGS-6600:15 (config-vlan) #interface eth2.1
DGS-6600:15 (config-if) # access vlan 1002
DGS-6600:15 (config-if) # vlan-tunnel interface-type uni
DGS-6600:15 (config-if) # vlan-tunnel ingress-checking
DGS-6600:15 (config-if) # vlan encapsulation 1002 2
DGS-6600:15 (config-if) #interface eth2.2
DGS-6600:15 (config-if) # access vlan 1003
DGS-6600:15 (config-if) # vlan-tunnel interface-type uni
DGS-6600:15 (config-if) # vlan-tunnel ingress-checking
DGS-6600:15 (config-if) # vlan encapsulation 1003 2
DGS-6600:15 (config-if) #interface eth2.3
DGS-6600:15 (config-if) # trunk allowed-vlan 1002-1003
```

R2 (Router 2) Configuration Steps

Step 1: Enable QinQ

```
DGS-6600:15(config)#vlan-tunnel  
  
Step2. Create vlan 1002, 1003  
DGS-6600:15(config)#vlan 1002  
DGS-6600:15(config-vlan)#vlan 1003
```

Step 3: add port into vlan and set eth2.1-2.2 are uni- port, eth2.3 are nni-port (default value)

```
DGS-6600:15(config-vlan)#interface eth2.1  
DGS-6600:15(config-if)# access vlan 1002  
DGS-6600:15(config-if)# vlan-tunnel interface-type uni  
DGS-6600:15(config-if)# vlan-tunnel ingress-checking  
DGS-6600:15(config-if)# vlan encapsulation 1002 2  
DGS-6600:15(config-if)#interface eth2.2  
DGS-6600:15(config-if)# access vlan 1003  
DGS-6600:15(config-if)# vlan-tunnel interface-type uni  
DGS-6600:15(config-if)# vlan-tunnel ingress-checking  
DGS-6600:15(config-if)# vlan encapsulation 1003 2  
DGS-6600:15(config-if)#interface eth2.3  
DGS-6600:15(config-if)# trunk allowed-vlan 1002-1003
```

Verifying the Configuration

Check R1 QinQ config using the command `show vlan interface eth2.1-2.3`

R1 (router 1) Configuration Verification

```
DGS-6600:15#show vlan interface eth2.1-2.3
eth2.1
PVID                : 1002
GVRP State          : Disabled
Ingress checked     : Enabled
Access VLAN         : 1002
Advertise VLAN      : 1-4094
Forbidden VLAN      :
Acceptable frame types : admit-all

eth2.2
PVID                : 1003
GVRP State          : Disabled
Ingress checked     : Enabled
Access VLAN         : 1003
Advertise VLAN      : 1-4094
Forbidden VLAN      :
Acceptable frame types : admit-all

eth2.3
PVID                : 1
GVRP State          : Disabled
Ingress checked     : Enabled
Trunk allowed VLAN : 1002-1003
Advertise VLAN      : 1-4094
Forbidden VLAN      :
Acceptable frame types : admit-all

DGS-6600:15#show vlan-tunnel eth2.1-2.3
VLAN tunneling: enabled

eth2.1: UNI port, CoS remarking: disabled, ingress-checking: enabled,
remove-inner-tag: disabled
VLAN          S-VID  C-VID  CoS
-----
encapsulation 1002   2      trusted

eth2.2: UNI port, CoS remarking: disabled, ingress-checking: enabled,
remove-inner-tag: disabled
VLAN          S-VID  C-VID  CoS
-----
encapsulation 1003   2      trusted

eth2.3: NNI port, TPID: 0x88a8
```

Customer#2's VLAN2 should be able to communicate within itself, but unable to communicate with Customer#3's VLAN2. Customer#3's VLAN2 can communicate within itself, but unable to communicate with Customer#2's VLAN2.

List of Constants and Default Settings

Variable Name	Default Value
VLAN Tunnel Table Entry Number	Disabled
VLAN Tunnel Mode	Disabled
UNI/NNI Port Role	NNI Port
Ingress Checking	Disabled
VLAN Tunnel TPID	0x88a8

Table 11-1 Default Variable Values

Chapter 12

GARP VLAN Registration Protocol (GVRP) Configuration

Chapter Overview

The following topics are included in this chapter, please go to the topic for more detailed information:

- [Chapter Overview](#)
 - [An Introduction to GARP](#)
- [GARP Configuration Commands](#)
 - [Enabling the GVRP Protocol](#)
 - [Specifying Forbidden Ports](#)
 - [Specifying the GVRP Timer](#)
 - [Enabling the Dynamic Creation of VLANs](#)
 - [Configuring the Interface Advertisement Attribute](#)
 - [Configuring the VLAN Advertisement Attribute](#)
 - [Verifying GVRP Settings](#)
 - [Displaying and Clearing the GVRP Statistic Counters](#)
- [List of Constants and Default Settings](#)

An Introduction to GARP

GVRP provides a mechanism for the Switch to dynamically learn the VLAN membership of a port. When the Switch receives a GVRP message that indicates a reception port wants to join a specific VLAN, the Switch will automatically learn the VLAN membership of the reception port. The dynamic VLAN membership of a port will be automatically removed by either the timeout mechanism or when the Switch receives another GVRP message that indicates the port is going to leave a specific VLAN. Any dynamic member ports that were automatically learned by GVRP will become tagged member ports.

GVRP also provides a mechanism to propagate GVRP messages to uplink ports for automatically registering VLAN memberships. This propagation allows the partner switch to automatically learn that the partner port is a member port of the advertised VLAN.

GARP Configuration Commands

The following is a list of commands that are necessary to configure the GARP function on the DGS-6600 Series Switch:

- [Enabling the GVRP Protocol](#)
- [Specifying Forbidden Ports](#)
- [Specifying the GVRP Timer](#)
- [Enabling the Dynamic Creation of VLANs](#)
- [Configuring the Interface Advertisement Attribute](#)

- [Configuring the VLAN Advertisement Attribute](#)
- [Verifying GVRP Settings](#)
- [Displaying and Clearing the GVRP Statistic Counters](#)

Enabling the GVRP Protocol

The GVRP protocol must be enabled on the Switch globally before GVRP can be enabled on an individual interface.

The GVRP function can be enabled on both physical ports and port-channels. However, the user cannot configure GVRP on an individual member port of a port-channel.



NOTE: The GVRP protocol can only be enabled on interfaces that are operating in trunk mode.

To enable GVRP on an interface, access privileged EXEC mode and enter the following commands:

Command	Explanation
<code>configure terminal</code>	Enters global configuration mode.
<code>gvrp</code>	Enables GVRP globally on the Switch.
<code>interface IFNAME</code>	Used to enter interface configuration mode for the interface that needs GVRP enabling.
<code>trunk allowed-vlan VLAN-ID [, -]</code>	Specifies that the interface will operate in trunk mode.
<code>gvrp</code>	Enables GVRP on the interface.
<code>end</code>	Exits interface configuration mode.

In the following example, the user configures Ethernet interface 4.48 to be a trunk port, specifying that VLANs 3 and 6 can receive and send traffic on the interface in tagged format, and finally enables GVRP on the interface:

```
DGS-6600:2>enable
DGS-6600:15#configure terminal
DGS-6600:15 (config)#gvrp
DGS-6600:15 (config)#interface eth4.48
DGS-6600:15 (config-if)#trunk allowed-vlan 3,6
DGS-6600:15 (config-if)#gvrp
DGS-6600:15 (config-if)#end
```

Specifying Forbidden Ports

If the user specifies the `gvrp forbidden` option in interface configuration mode, the interface will not be able to become a member of any VLANs using the GVRP protocol.

To stop an interface from becoming a member of any VLANs using the GVRP protocol, enter the following command in interface configuration mode:

Command	Explanation
<code>gvrp forbidden</code>	Specifies that the interface can not become a member of any VLANs using the GVRP protocol.

In the following example, the user specifies that Ethernet Interface 4.1 will be forbidden from joining any VLANs using the GVRP operation:

```
DGS-6600:2>enable
DGS-6600:15#configure terminal
DGS-6600:15 (config) #eth4.1
DGS-6600:15 (config-if) #gvrp forbidden
DGS-6600:15 (config-if) #end
```

Specifying the GVRP Timer

The user can specify the GVRP timer for each interface.

The value of these parameters must comply to one of the following rules:

- 1) `LEAVE_TIMER >= 3 * JOIN_TIMER`
- 2) `LEAVE_ALL_TIMER > LEAVE_TIMER`

Enter the following command to specify the GVRP timer for an interface:

Command	Explanation
<code>gvrp timer {join leave leave-all} <i>TIMER-VALUE</i></code>	Configures the GVRP timer.

In the following example, the user configures the GVRP timer on Ethernet interface 4.40 to leave all groups after 500 centiseconds:

```
DGS-6600:2>enable
DGS-6600:15#configure terminal
DGS-6600:15 (config) #interface eth4.40
DGS-6600:15 (config-if) #gvrp timer leave-all 500
DGS-6600:15 (config-if) #end
```

Enabling the Dynamic Creation of VLANs

Since an interface may request membership to a VLAN that does not currently exist, the Switch supports a feature that can dynamically create the requested VLAN. If this feature is disabled, the Switch ignores the request.

Enter the following command in global configuration mode to enable dynamic VLAN creation:

Command	Explanation
<code>gvrp dynamic-vlan-creation</code>	Enables the dynamic creation of VLANs.

In the following example, the user enables the GVRP protocol to create dynamic VLANs:

```
DGS-6600:2>enable
DGS-6600:15#configure terminal
DGS-6600:15 (config) #gvrp
DGS-6600:15 (config) #gvrp dynamic-vlan-creation
DGS-6600:15 (config) #end
```

Configuring the Interface Advertisement Attribute

The user can specify whether to allow the advertisement of specific VLANs from an interface. If a VLAN is not allowed to be advertised, the intended partner port will have no chance of becoming a member port of the VLAN.

To specify the VLANs that can be advertised by an interface, access privileged EXEC mode and enter the following commands:

Command	Explanation
<code>configure terminal</code>	Enters global configuration mode.
<code>gvrp</code>	Enables GVRP globally on the Switch.
<code>interface IFNAME</code>	Used to enter interface configuration mode for the interface that needs GVRP enabling.
<code>trunk allowed-vlan VLAN-ID [, -]</code>	Specifies that the interface will operate in trunk mode.
<code>gvrp advertise [VLAN-ID[, -]]</code>	Specifies the VLANs that can be advertised to the interface by the GVRP protocol.

In the following example, the user specifies that VLAN100 will be advertised via Ethernet interface 4.5:

```
DGS-6600:2>enable
DGS-6600:15#configure terminal
DGS-6600:15 (config) #interface eth4.5
DGS-6600:15 (config-if) #trunk allowed-vlan 100
DGS-6600:15 (config-if) #gvrp advertise 100
DGS-6600:15 (config-if) #end
```

Configuring the VLAN Advertisement Attribute

The user can specify whether to allow the advertisement of specific VLANs system-wide.

Enter the following command in global configuration mode to specify the VLANs that can be advertised system-wide:

Command	Explanation
<code>gvrp advertise</code>	Specifies the VLANs that can be advertised system-wide.

In the following example, the user specifies that VLAN100 will be advertised system-wide:

```
DGS-6600:2>enable
DGS-6600:15#configure terminal
DGS-6600:15(config)#vlan 100
DGS-6600:15(config-vlan)#gvrp advertise
DGS-6600:15(config-vlan)#end
```

Verifying GVRP Settings

The user can verify the following GVRP settings:

- 1)Global GVRP State
- 2)Per Port GVRP State
- 3)Per Port GVRP Timer
- 4)Per Port Forbidden Attribute
- 5)Per Port Advertisement Attribute

Enter the following command to verify the GVRP settings:

Command	Explanation
<code>show gvrp configuration [interface <i>INTERFACE-ID</i> [, -]]</code>	Displays the GVRP configuration.

In the following example, the user displays the global GVRP configuration:

```
DGS-6600:2>show gvrp configuration
Global GVRP State      : Enabled
Dynamic VLAN Creation : Enabled
DGS-6600:2>
```

In the following example, the user displays the GVRP configuration for Ethernet interfaces 5.1 to 5.3:

```
DGS-6600:2>show gvrp configuration interface eth5.1-5.3
```

Port	GVRP Status	Join	Leave	LeaveAll (1/100 Secs)
eth4.1	Enabled	20	60	1000
eth4.2	Disabled	20	60	1000
eth4.3	Disabled	20	60	1000

Total Entries: 3

Port based Forbidden VLAN Configuration:

Port	Forbidden VLANs
eth4.1	2-4094
eth4.2	
eth4.3	

Port based Advertising VLAN Configuration:

Port	Advertising VLANs
eth4.1	1-4094
eth4.2	1-4094
eth4.3	1-4094

DGS-6600:2>

Displaying and Clearing the GVRP Statistic Counters

The user can display and clear statistics for a GVRP port.

Enter the following commands to display or clear the statistics for a GVRP port:

Command	Explanation
<code>show gvrp statistics [interface <i>INTERFACE-ID</i> [, -]]</code>	Displays the GVRP statistics for an interface.
<code>clear gvrp statistics [interface <i>INTERFACE-ID</i> [, -]]</code>	Clears the GVRP statistics for an interface.

In the following example, the user displays the GVRP port statistics for Ethernet interface 4.48:

```
DGS-6600:2>show gvrp statistics interface eth4.48
```

Port		JoinEmpty	JoinIn	LeaveEmpty	LeaveIn	Empty
eth4.48	RX	0	0	0	0	0
	TX	4294967296	4294967296	4294967296	4294967296	4294967296

Total Entries: 1

DGS-6600:2>

In the following example, the user clears the GVRP port statistics for Ethernet interface 4.48 and verifies that the statistics have been cleared:

```
DGS-6600:15#clear gvrp statistics interface eth4.48
DGS-6600:15#show gvrp statistics interface eth4.48
Port
-----
eth4.48          RX          0          0          0          0          0
                  TX          0          0          0          0          0

Total Entries: 1
DGS-6600:15#
```

List of Constants and Default Settings

Constant Name	Value
Maximum Number of Created Dynamic VLANs	256

Table 12-1 Constants Values

Variable Name	Default Value
Global GVRP State	Disabled
Interface GVRP State	Disabled
Interface Advertisement Attribute	Advertise all VLANs
Dynamic VLAN	Disabled
Interface Forbidden Attribute	No Forbidden VLANs
Join Timer	0.2 Seconds
Leave Timer	0.6 Seconds
Leave All Timer	10 Seconds

Table 12-2 Default Variable Values

Chapter 13

MAC Address Tables

Chapter Overview

The following topics are included in this chapter, please go to the topic for more detailed information:

- [Chapter Overview](#)
- [An Introduction to Mac Address Tables](#)
- [Mac Address Configuration Commands](#)
- [Displaying MAC Address Entries](#)
- [Managing Dynamic MAC Address Entries](#)
- [Creating Static MAC Address Entries](#)
- [Relations with Other Modules](#)
- [List of Constants and Default Settings](#)

An Introduction to Mac Address Tables

The MAC address table is the filtering database that exists in the switch controller and is used for filtering and forwarding packets. A MAC address entry can either be dynamic or static. The system automatically learns the dynamic entries from the source unicast MAC address recorded in the received packet. Static entries are manually configured by the user. Dynamic entries are automatically aged out. If the static entries are not saved, the static entry will disappear after power is cycled. Generally, the user configures static entries for unicast MAC addresses. However, static entries for multicast MAC addresses can also be created.

Mac Address Configuration Commands

Below is a list of common commands and examples used to configure Mac Address Tables on the DGS-6600 Series Switch:

- [Displaying MAC Address Entries](#)
- [Managing Dynamic MAC Address Entries](#)
- [Creating Static MAC Address Entries](#)

Displaying MAC Address Entries

The user has several options for viewing the MAC address table. The user can browse the entire MAC address table or filter the entries by specifying a specific entry, entries based on the entry type, the forwarding interface, or a VLAN.

Use the following command to display the MAC address table entries on the Switch:

Command	Explanation
<code>show mac address-table [dynamic static] [address MAC-ADDR interface INTERFACE-ID [, -] vlan VLAN-ID]</code>	Displays the MAC address entries on the Switch.

In the following example, the user specifies that the Switch should display all MAC address table entries for the MAC address "00-e0-18-72-0d-1f":

```
DGS-6600:15(config-if)>show mac address-table address 00-e0-18-72-0d-1f
Vlan Mac Address      Type      Ports      InactiveSlot
-----
 1 00-e0-18-72-0d-1f  Dynamic  eth2.4
Total Entries: 1
DGS-6600:15(config-if)>
```

In the following example, the user specifies that the Switch should display all static MAC address table entries:

```
DGS-6600:15(config-if)>show mac address-table static
Vlan Mac Address      Type      Ports      InactiveSlot
-----
 1 cc-b2-55-6d-50-01  Static   CPU
 10 cc-b2-55-6d-50-0a Static   CPU
Total Entries: 2
DGS-6600:15(config-if)>
```

In the following example, the user specifies that the Switch should display all the MAC address table entries for interface VLAN1:

```
DGS-6600:15(config-if)>show mac address-table vlan 1
#show mac address-table vlan 1
Vlan Mac Address      Type      Ports      InactiveSlot
-----
 1 00-e0-18-72-0d-1f  Dynamic  eth2.4
 1 cc-b2-55-6d-50-01  Static   CPU
Total Entries: 2
DGS-6600:15(config-if)>
```

Managing Dynamic MAC Address Entries

The user can clear a specific dynamic entry or several dynamic entries based on the forwarding interface or VLAN.

If required, the user can also configure the aging time for dynamic entries or disable the aging function.

Use the following command to manage the dynamic MAC address table entries on the Switch:

Command	Explanation
<code>clear mac address-table {dynamic [address <i>MAC-ADDR</i> interface <i>INTERFACE-ID</i> vlan <i>VLAN-ID</i>] }</code>	Clears a dynamic MAC address entry.
<code>mac address-table aging-time <i>SECONDS</i></code>	Configures the aging time for dynamic MAC address entries.
<code>show mac address-table aging-time</code>	Displays the aging time settings for dynamic MAC address entries.

In the following example, the user removes the MAC address “00:03:9d:75:14:21” from the dynamic address table:

```
DGS-6600:2>enable
DGS-6600:15#clear mac address-table dynamic address 00:03:9d:75:14:21
```

In the following example, the user sets the MAC address aging time to be 200 seconds:

```
DGS-6600:2>enable
DGS-6600:15#configure terminal
DGS-6600:15(config)#mac address-table aging-time 200
DGS-6600:15(config)#end
```

In the following example, the user displays the MAC address aging time set on the Switch:

```
DGS-6600:2>show mac address-table aging-time
Aging Time is 200 seconds
DGS-6600:2>
```

Creating Static MAC Address Entries

The user can create static MAC address entries for unicast or multicast addresses. A unicast address entry is associated with a forwarding interface, but a multicast address entry can be specified with multiple forwarding interfaces. The associated interface can be a physical port or a port channel.

Use the following command to create a static MAC address table entry on the Switch:

Command	Explanation
<code>mac address-table static <i>MAC-ADDR</i> vlan <i>VLAN-ID</i> interface <i>INTERFACE-ID</i> [, -]</code>	Configures a static MAC address entry.

In the following example, the user adds the static MAC address “00:1d:60:a1:37:b5” to the MAC address table. If a packet with a destination MAC address of “00:1d:60:a1:37:b5” is received in VLAN 99, the packet will be forwarded to the interface specified by the command (eth4.22):

```
DGS-6600:2>enable
DGS-6600:15#configure terminal
DGS-6600:15 (config) #mac address-table static 00:1d:60:a1:37:b5 vlan 99 interface
eth4.22
DGS-6600:15 (config) #end
```



NOTE: If a port is a member port of a port channel group, the user cannot specify the port as an interface for the static entry. Instead the user can specify the port channel for the entry.

Relations with Other Modules

- 1) A port-channel member port cannot be specified as a forwarding interface.
- 2) If a port is the forwarding interface of an entry, and the port becomes a channel group member in the future, the entry will be deleted.
- 3) If a port-channel is a forwarding interface of an entry, and the port channel is deleted in the future, the entry will be deleted.

List of Constants and Default Settings

Constant Name	Value
Size of MAC Address Table	32K
Maximum Number of Unicast Static Entries	256
Maximum Number of Multicast Static Entries	1024

Table 13-1 Constants Values

Variable Name	Default Value
Aging Time	300 Seconds

Table 13-2 Default Variable Values

Chapter 14

Spanning Tree Protocol (STP) Configuration

Chapter Overview

The following topics are included in this chapter, please go to the topic for more detailed information:

- [Chapter Overview](#)
- [An Introduction to Spanning Tree Protocol](#)
 - [Spanning Tree Protocol \(STP\) Concepts](#)
 - [Rapid Spanning Tree Protocol \(RSTP\) Concepts](#)
 - [Multiple Spanning Tree Protocol Concepts](#)
- [STP Configuration Commands](#)
 - [Configuring a Single Spanning Tree Instance](#)
 - [Configuring Multiple Spanning Tree Instances](#)
 - [Configuring Optional Features](#)
- [Configuration Examples](#)
 - [RSTP Configuration example](#)
 - [MSTP Configuration Example](#)
- [List of Constants and Default Settings](#)

An Introduction to Spanning Tree Protocol

Path redundancy is a useful technique for providing a reliable network. In a Layer 2 switching domain, multiple switching devices are connected together to form the network topology. If redundant paths exist in the network, a packet originating from a LAN segment attached to one node has multiple paths for getting to a LAN segment attached to another node. When the STP protocol is running on a Switch, the participating nodes will transmit BPDU messages to exchange information to determine a loop free topology. To achieve a loop free topology, some ports of the participating nodes will be set to a blocked state.

When the topology is loop free, the participating node will constantly monitor all links. When any participating link fails, the port that was originally blocked will recover to provide the packet forwarding service.

The Switch supports all versions of Spanning Tree Protocol, which includes STP, RSTP, and MSTP.

Spanning Tree Protocol (STP) Concepts

Spanning Tree is a protocol defined by IEEE 802.1d and is the first version of the Spanning Tree Protocol suite.

The following topics are included in this section:

- [Basic Terminology](#)
- [Timers](#)
- [Port Role](#)

- [Port State](#)
- [BPDU](#)
- [Priority Vector](#)
- [Algorithms](#)

Basic Terminology

Bridge ID

Each network node participating in the switching domain has a unique bridge ID. The bridge ID is formed by the bridge priority and MAC address of the network node. The bridge priority is a 16-bit integer. A lower bridge ID value represents a better priority.

Port ID

Each port of the network node participating in the switching domain has a port ID, which is formed by an 8-bit port priority and an 8-bit port number.

Link Path Cost

Each port has a path cost value representing the media speed.

Root Bridge

The bridge with the lowest bridge ID is elected as the root bridge.

Root Path Cost

Represents the link cost of the shortest distance between the local Switch and the root bridge.

Designated Bridge

The closest bridge on each LAN segment that can forward all traffic originating from the LAN segment to the root bridge.

Timers

Maximum Age

The message age of the configuration BPDU should be less than the maximum time a BPDU takes to be processed.

Hello Time

The interval that a designated port will wait between the periodic transmission of each configuration message.

Forward Delay

The delay used by STP to transition from the listening to learning and learning to forwarding states.

Port Role

Root Port

The port with the best path to the root bridge is selected as the root port. Each bridge has one root port.

Designated Port

The bridge port on each LAN segment that is closest to the root bridge and can forward all traffic originating from the LAN segment to the root bridge.

Alternate Port and Backup Port

These are bridge ports that can provide connectivity if other network components fail.

Port State

Blocking

After the port has initialized, the port enters the STP blocking state. In this state, the port discards the received frame and does not forward frame.

Listening

After instructing a port to enter the forwarding state, the port will initially enter the listening state. Like the blocking state, a port in the listening state also discards received frames and does not forward any frames.

Learning

After the forward delay timer has expired, the port will transition from the listening state to the learning state. When in the learning state, the port performs address learning on received frames, but does not forward frames.

Forwarding

After the forward delay timer has expired, the port will transition from the learning state to the forwarding state. When in the forwarding state, the port receives and forwards frames.

Disabled

The port does not take part in STP and does not forward or receive frames.

BPDU

There are two types of BPDU messages, configuration messages and Topology Change Notification (TCN) messages. The configuration messages will be encoded as either a Configuration BPDU (802.1d version) or an RST BPDU (802.1w version). TCN Message will be encoded as a TCN BPDU (802.1d version), or as an RST BPDU (802.1w version) with the TC flag set.

The following information from a configuration BPDU message is always conveyed:

- Root Bridge ID

- Root Path Cost
- The Transmitting Bridge ID
- The Transmitting Port ID
- Hello Time
- Forward Delay
- Max-Age

Priority Vector

The purpose of STP is to determine a loop free network topology for the participating nodes and links. STP uses a priority vector mechanism to determine the active topology. There are a number of different priority vectors, which will be described in the following section. All of the priority vectors are formed by the following components:

(Root Bridge ID, Root Path Cost, Designated Bridge, Designated Port ID, Bridge Port ID)

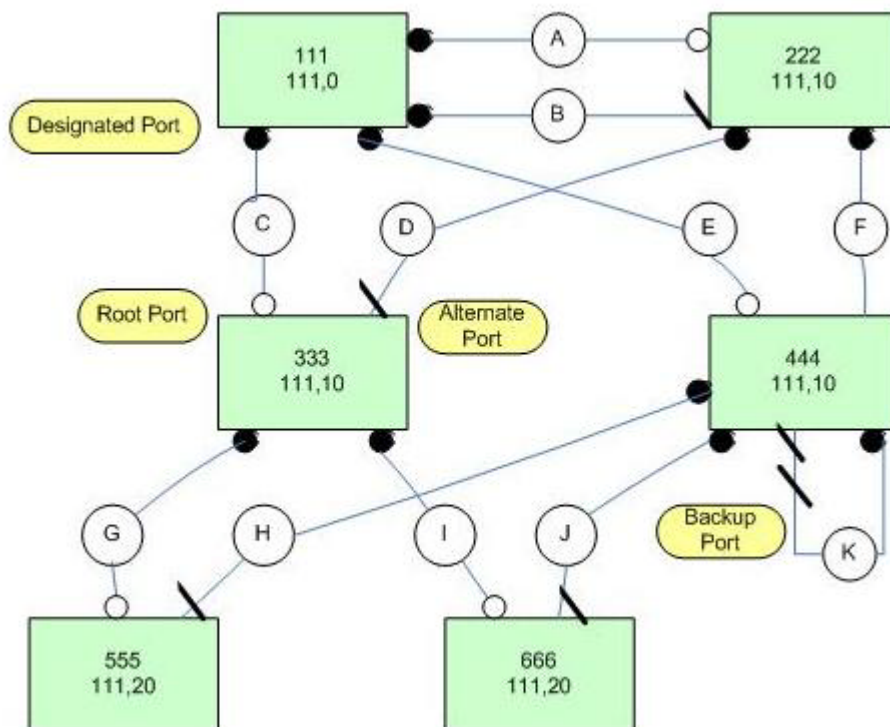

Figure 14-1 Using Priority Vector Algorithm to Determine Active Topology

Algorithms

- 1) Initially, each bridge assumes that it is the root bridge. The initial root priority vector is: **(Bridge ID-X, 0, Bridge ID-X, 0, 0)**
- 2) The bridge calculates the designated priority vector for each port, which will be conveyed in the BDPDU that is transmitted to each port. The RPC (Root Path Cost) is initially zero.
- 3) **(Bridge ID-X, 0, Bridge ID-X, Bridge ID-X TX port, Bridge ID-X TX port)**

- 4) Suppose that a port on bridge Y receives a BPDU from bridge X, the priority vector of the message will be calculated based on the priority conveyed by the received BPDU.
- 5) **(Bridge ID-X, RPC, Bridge ID-X, Bridge ID-X TX port, Bridge ID-Y RX Port)**
- 6) The message priority vector will be compared against the designated priority vector of the RX port, with the best one becoming the port priority vector. If the designated priority vector is better, the port's role will be designated port. If the message priority vector is better, the port's role will be either root port or alternate port. The root path priority vector of the root port or alternate port is calculated by adding the link path cost to the RPC.
- 7) **(Bridge ID-X, RPC+ RX port Path Cost, Bridge ID-X, Bridge ID-X TX port, Bridge ID-Y RX Port)**
- 8) Based on the new derived root path priority vector, the bridge will re-calculate the new root priority vector if necessary.
- 9) **(Bridge ID-X, RPC+ RX port Path Cost, Bridge ID-X, Bridge ID-X TX port, Bridge ID-Y RX Port)**
- 10) Based on the new root priority vector, the bridge re-calculates each port's designated priority vector. This recalculation may cause the re-evaluation of Step-4 and port role re-assignment.
- 11) **(Bridge ID-X, RPC+ RX port Path Cost, Bridge ID-X, TX port, TX Port)**

Rapid Spanning Tree Protocol (RSTP) Concepts

Rapid Spanning Tree Protocol is a protocol defined by IEEE 802.1w, which improves the convergence time of 802.1d.

In 802.1d, when the topology changes and a port is re-computed to an active state, the port will take twice the amount of time specified by the forward delay time to change from the blocking state to the forwarding state. 802.1w reduces this convergence time by applying a handshake algorithm between ports on the neighbor switches and ports on the same switch so that a port can change from the blocking state to the forwarding state within the forward delay time.

In addition to modifying the protocol's operation, the definition of the Bridge ID format and Port ID format have also changed.

Change of Bridge ID Format

The Bridge ID in 802.1d is formed by a 16-bit bridge priority and 6 bytes of the MAC Address.

In 802.1w, the 16-bit bridge priority is divided into a 4-bit port priority and a 12-bit Extension System ID. In 802.1w the Extension System ID part is blank and in 802.1s the Extension System ID is the same as the VLAN ID.

Change of Port ID Format

The Port ID in 802.1d is formed by an 8-bit priority and 8-bit port number.

In 802.1w, the Port ID is formed by a 4-bit port priority and a 12-bit port number.

Protocol Migration

In the network topology, some network nodes may run 802.1d and some switches may run 802.1w. Bridge nodes running 802.1w are backward compatible with 802.1d in the following way. Suppose that on an 802.1w node some ports are connected to 802.1w nodes and some ports are connected to 802.1d nodes. 802.1w will be able to automatically detect the version and downgrade to the 802.1d version for ports that are attached to 802.1d nodes.

802.1w detects and downgrades the protocol version for a port based on the following rule. On initialization, the port will start in “Sending RSTP BPDU” mode and the migration timer will be started. The port will change to “STP BPDU” mode if any 802.1d BPDUs are received after the migration timer has expired. When the port changes to “Sending STP BPDU” mode, another migration timer is restarted. The port may revert to “Sending RSTP BPDU” mode if an 802.1w BPDU is received after the expiration of the migration timer. The migration timer provides a mechanism to prevent the mode from changing too frequently.

Consider a case where a port is in “Sending STP BPDU” mode and is the designated port of a LAN segment. There are another two switches on this segment. One is an 802.1d device and the other is an 802.1w device. Suppose that the 802.1d device is removed, the port can not detect this but will remain in “Sending STP BPDU” mode. In this situation, the user should manually restart the Protocol Version Detection process to allow the port to change to “Sending RSTP BPDU” mode.

Multiple Spanning Tree Protocol Concepts

Multiple Spanning Tree Protocol is a protocol defined by IEEE 802.1s, which improves the utilization of a link in 802.1w by running multiple Spanning Tree instances.

Both STP and RSTP run a single Spanning Tree instance on the network. Since a VLAN forms an independent switching domain, each VLAN could theoretically have its own loop free topology. The advantage of running multiple Spanning Tree instances over a single Spanning Tree instance is that the bandwidth of a link can be utilized more efficiently. The following diagram compares a single Spanning Tree Instance with a multiple Spanning Tree Instance. The diagram shows how one link would be set to the inactive state for both VLAN 1 and VLAN 2 if the Switch is running a single Spanning Tree instance and if running multiple Spanning Tree instances, one link would be set to the inactive state for VLAN 1 and another link would be set to the inactive state for VLAN 2. Therefore, the traffic loading of VLAN 1 and VLAN 2 will be balanced over the two links.

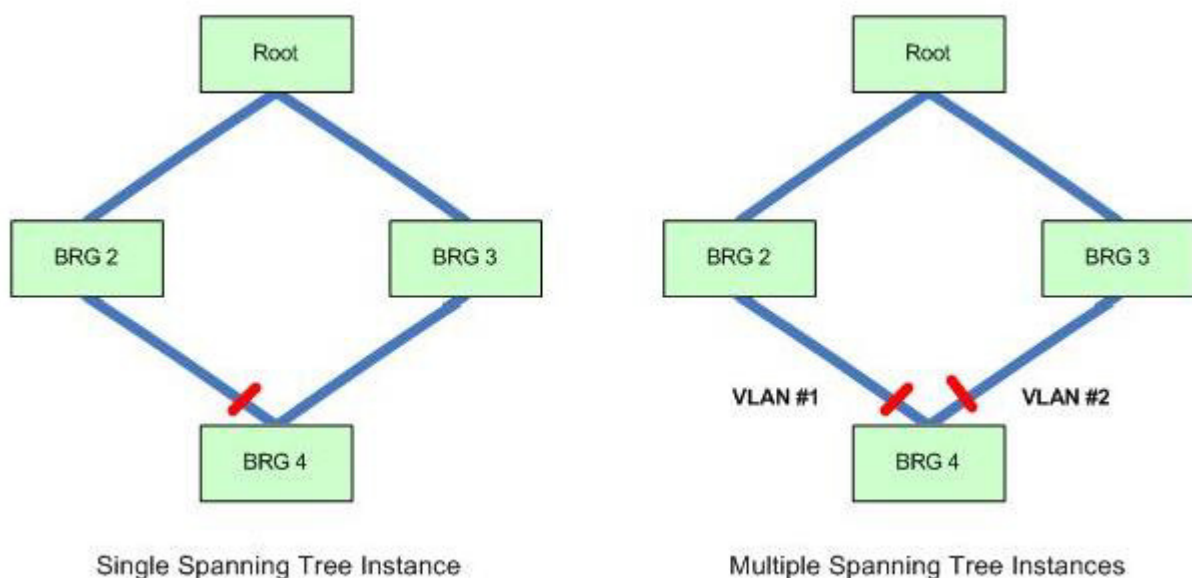

Figure 14-2 Single Spanning Tree Instance Vs. Multiple Spanning Tree Instances

With 802.1s, the user can separate VLANs into different groups, with each group running a separate Multiple Spanning Tree Instance (MSTI).

Region

A network may be comprised of sub-networks, with some sub-networks running Multiple Spanning Tree Instances and other sub-networks running a single Spanning Tree Instance. In a sub-network that runs Multiple Spanning Tree Instances, all the bridge devices in the network must have the same VLAN to MSTI mapping in order to provide the correct forwarding of VLAN traffic. This sub-network is referred to as a region. The MST bridge can detect whether the neighbor bridge is in the same region as itself based on the MST configuration ID conveyed in the BPDU. The MST configuration is formed by three components, the region name, the revision level, and a configuration digest, which is a signature computed from the VLAN to MSTI mapping table.

CST/CIST/IST/MSTI

When a network is comprised of sub-networks, which run a combination of Multiple Spanning Tree Instances and Single Spanning Tree Instances, a Common Spanning Tree (CST) is used to connect the different types of sub-networks together. Bridge devices in the same region can be viewed as a virtual bridge device. Bridge ports that are connected to bridges outside of the region act as the connectivity port on the virtual bridge device. Within a region, the bridge devices can be viewed as if they were connected by an Internal Spanning Tree (IST) instance with a loop free topology. The Common and Internal Spanning Tree (CIST) can be viewed as a tree that is formed by a CST that connects the regions and the ISTs within each region. One of the devices in CIST will act as the CIST root. Generally, except for ISTs, the user needs to explicitly create multiple MSTIs, and map the traffic from VLANs to these MSTIs. However, it is recommended that VLAN traffic should not be mapped to an IST. An IST will always exist even if there are no VLANs mapped to it. On the contrary, other MSTIs do not exist if there are no VLANs mapped to the MSTI.

Master Port

The Master Port is the connectivity port of the virtual bridge that represents the region that has the shortest root path cost to the CIST Root Bridge. All VLAN traffic within the region must go through this port to communicate with sites outside of the region in the direction flowing towards the CIST Root.

STP Configuration Commands

The following topics are included in this section:

- [Enabling Spanning Tree Protocol](#)
- [Specifying the Protocol Version](#)
- [Specifying the Edge Port for Fast Forwarding](#)
- [Specifying the Link Type](#)
- [Limiting the BPDU Transmission Rate](#)
- [Restarting Protocol Migration](#)
- [Displaying the STP Settings](#)

Enabling Spanning Tree Protocol

To enable STP on a port, the device's global setting must be enabled, in addition to STP being enabled for the port.

Use the following commands to enable STP:

Command	Explanation
<code>spanning-tree</code>	This global configuration mode command enables STP system wide.

Command	Explanation
<code>spanning-tree</code>	This interface configuration mode command enables STP on an interface.

Specifying the Protocol Version

The user can configure the device to run the STP, RSTP, or MSTP protocol version. Changing the protocol version takes effect immediately.



NOTE: Be careful when using the **spanning-tree mode** command to switch between STP, RSTP, and MSTP modes. When entering the command to change STP modes, all Spanning Tree instances running in the previous mode will be stopped and new instances will be started in the new mode. The effected ports will be restarted from the discarding state. Using this command may cause disruption to user traffic.

Use the following command to specify the STP version:

Command	Explanation
<code>spanning-tree mode {mstp rstp stp}</code>	Specifies the Spanning Tree Protocol version.

In the following example, the user enables STP on the Switch and specifies that the Switch should use the MSTP version of STP:

```
DGS-6600:2>enable
DGS-6600:15#configure terminal
DGS-6600:15(config)#spanning-tree
DGS-6600:15(config)#spanning-tree mode mstp
DGS-6600:15(config)#end
```

Specifying the Edge Port for Fast Forwarding

A bridge port may be connected to an edge LAN segment or another bridged LAN segment. When the port is connected to an edge LAN segment, the port can directly enter the forwarding state since the port is not connected a bridge that is connected to another LAN segment.

The user can explicitly enable fast forwarding on a port. If fast forwarding is enabled, the port will assume it is an edge port and directly move to the forwarding state on initialization. If a BPDU is received in the future, the port will change to a non-edge port.

Use the following command to implement fast forwarding on an edge port:

Command	Explanation
<code>spanning-tree fast-forwarding</code>	Specifies that the interface will enter the forwarding state on initialization.

In the following example, the user enable fast forwarding on Ethernet interface 4.1:

```
DGS-6600:2>enable
DGS-6600:15#configure terminal
DGS-6600:15 (config)#interface eth4.1
DGS-6600:15 (config-if)#spanning-tree fast-forwarding
DGS-6600:15 (config-if)#end
```

Specifying the Link Type

In order to rapidly converge, a bridge needs to handshake with the neighbor bridge. The handshake mechanism assumes that on a specific link, the bridge has only one neighbor bridge. This means that a handshake will only be carried out on a point-to-point link. Handshaking will not be performed on a shared media link where multiple neighbor bridges are possible.

The user can specify whether to auto-detect the link type or manually specify the link type. Based on auto-detection, a full-duplex port is considered to have a point-to-point connection; on the contrary, a half-duplex port is considered to have a shared media connection.

Use the following command to specify the link type:

Command	Explanation
<code>spanning-tree link-type {point-to-point shared}</code>	Specifies the link type.

In the following example, the user configures the link type as “Point-to-Point” on Ethernet interface 4.33:

```
DGS-6600:2>enable
DGS-6600:15#configure terminal
DGS-6600:15 (config)#interface eth4.33
DGS-6600:15 (config-if)#spanning-tree link-type point-to-point
DGS-6600:15 (config-if)#end
```

Limiting the BPDU Transmission Rate

Too frequent BPDU transmissions will downgrade the performance of the partner switch. The **spanning-tree transmit-hold-count** command allows the user to limit the number of BPDU's transmitted by all ports within the hello time period.

Use the following command to limit the BPDU transmission rate:

Command	Explanation
<code>spanning-tree transmit-hold-count VALUE</code>	Limits the number of BPDU's transmitted by all ports within the hello time period.

In the following example, the user limits the Switch's BPDU transmission rate to 5:

```
DGS-6600:2>enable
DGS-6600:15#configure terminal
DGS-6600:15 (config)#spanning-tree transmit-hold-count 5
DGS-6600:15 (config)#end
```

Restarting Protocol Migration

RSTP and MSTP have built-in compatibility mechanisms that allow them to interact properly with other versions of IEEE Spanning Tree or with other regions. For example, a bridge running RSTP can send 802.1D BPDUs on one of its ports when it is connected to a legacy bridge. An MST bridge can detect that a port is at the boundary of a region when it receives a legacy BPDU or an MST BPDU that is associated with a different region. These mechanisms are not always able to revert to the most efficient mode. For example, an RSTP bridge that is designated for legacy 802.1D stays in 802.1D mode even after the legacy bridge has been removed from the link. Similarly, an MST port assumes that it is a boundary port when the legacy bridge is removed and the other bridges it is connected to have joined the same region. This function allows the user to restart protocol detection.

Use the following command to restart protocol migration:

Command	Explanation
<code>clear spanning-tree detected-protocols</code> <code>[interface <i>INTERFACE-ID</i>]</code>	Restarts protocol migration on the entire Switch or on the specified interfaces.

In the following example, the user restarts protocol migration on Ethernet interface 4.5:

```
DGS-6600:2>enable
DGS-6600:15#clear spanning-tree detected-protocols interface eth4.5
```

Displaying the STP Settings

The user can display the global STP settings, per port STP settings, per port fast forwarding state, and link type by using the following commands:

Command	Explanation
<code>show spanning-tree</code>	Displays the settings when the bridge is in STP/RSTP mode.
<code>show spanning-tree mst</code>	Displays the settings when the bridge is in MSTP mode.

In the following example, the user displays the STP settings when the Switch is operating in STP mode:

```
DGS-6600:2>show spanning-tree

Spanning tree      : Enabled, Mode: RSTP
Forwarding BPDU    : Disabled

Root ID Priority   : 4097
  Address          : 00-04-9B-78-08-00
  Root Path Cost   : 2000
  Hello Time       : 2 sec, Max Age: 20 sec, Forward Delay: 15 sec

Bridge ID Priority : 4097
  Address          : 00-04-9B-78-08-00
  Hello Time       : 2 sec, Max Age: 20 sec, Forward Delay: 15 sec
  Tx Hold Count    : 6

Topology Changes Count : 2

codes - F: Fast forwarding is configured as enabled
        Configured link type: A - Auto, P - point to point, S - shared

      Interface Role          State          Cost          Priority Link
      -----
      Interface Role          State          Cost          .Port  Type      Edge
      -----
FA eth3.3  Designated  Forwarding    20000    128.3  P2P      Eedge
FA eth3.5  Backup      Discarding    200000   128.5  P2P      None-edge
A eth3.6   Designated  Discarding    200000   128.6  Shr      Eedge
P eth3.7   Root        Forwarding    2000     128.9  P2P      None-edge

Total Entries: 4

DGS-6600:2>
```

In the following example, the user displays the STP settings when the Switch is operating in MSTP mode:

```
DGS-6600:2#show spanning-tree mst

Spanning tree      : Enabled, Mode : MSTP
Forwarding BPDU    : Disabled
Operational        : Forward delay 15, Max age 20
Configured         : Forward delay 15, Max age 20
                   Max hops 20, Transmit Hold count 6

>>>> MST0 vlans mapped: 1,4-4094
Bridge address: 00-12-85-26-05-00, Priority: 32768 (32768 sysid 0)
Designated Root: address: 00-54-85-26-05-00, Priority: 4096 (4096 sysid 0)
Root port: eth3.7, External Root path cost: 2000
Regional Root: address: 00-54-85-26-05-00, Priority: 32768 (32768 sysid 0)
Designated Bridge: address: 00-54-85-26-05-00, Priority: 4096 (4096 sysid 0)
Topology Changes Count : 2

codes - F: Fast forwarding is configured as enabled,
Configured Link type: A - Auto, S- Shared, P- Point to point

      Interface  Role           State           Cost           Priority
      - - - - -  - - - - -     - - - - -     - - - - -     - - - - -
      .Port#     Type           Edge
      - - - - -  - - - - -     - - - - -     - - - - -     - - - - -
FA eth3.3      designated    forwarding      20000          128.3          p2p            edge
FA eth3.5      backup        blocking        200000         128.5          p2p            non-edge
A  eth3.6      backup        blocking        200000         128.6          shared         edge
A  eth3.7      root          forwarding      2000           128.9          p2p            edge

>>>> MST2 vlans mapped: 2-3
Bridge address:00-12-d9-87-47-00, Priority: 32770 (32768 sysid 2)
Designated Root: address: 00-54-85-26-05-00, Priority: 4096 (4096 sysid 2)
Regional Root: address: 00-54-85-26-05-00, Priority: 32768 (32768 sysid 2)
Internal Root path cost: 2000
Designated Bridge: address: 00-54-85-26-05-00, Priority:32768 (32768 sysid 2)
Topology Changes Count : 2
Remaining Hops : 19

      Interface  Role           State           Cost           Priority
      - - - - -  - - - - -     - - - - -     - - - - -     - - - - -
      .Port#     Type           Edge
      - - - - -  - - - - -     - - - - -     - - - - -     - - - - -
FA eth3.9      designated    forwarding      20000          128.9          p2p            edge
P  eth3.10     backup        blocking        200000         128.10         p2p            non-edge
A  eth3.11     backup        blocking        200000         128.11         shared         edge
A  eth3.12     root          forwarding      2000           128.12         p2p            edge
DGS-6600:2#
```

Configuring a Single Spanning Tree Instance

The following topics are included in this section:

- [Specifying the Bridge Priority](#)
- [Specifying per Port Priority](#)
- [Specifying per Port Path Cost](#)
- [Specifying the Timers](#)
- [Displaying and Verifying STP Protocol Operations](#)

Specifying the Bridge Priority

The Bridge ID in 802.1d is formed by the 16-bit bridge priority and 6 bytes of the MAC Address. In 802.1w, the 16-bit bridge priority is divided into a 4-bit port priority and a 12-bit extension system ID. Therefore, the specified bridge priority must be divisible by 4096.

Use the following command to specify the bridge priority:

Command	Explanation
<code>spanning-tree priority PRIORITY</code>	Specifies the bridge priority for the entire Switch.

In the following example, the user configures the bridge priority for the entire Switch to be 4096:

```
DGS-6600:2>enable
DGS-6600:15#configure terminal
DGS-6600:15(config)#spanning-tree priority 4096
DGS-6600:15(config)#end
```

Specifying per Port Priority

The port ID in 802.1d is formed by an 8-bit priority and an 8-bit port number. In 802.1w, the priority is formed by a 4-bit port priority and a 12-bit port number. Therefore, the specified port priority must be divisible by 16.

Use the following command to specify the STP priority for a port:

Command	Explanation
<code>spanning-tree port-priority PRIORITY</code>	Specifies the STP priority for the port.

In the following example, the user configures the STP priority of Ethernet interface 4.20 to be 0:

```
DGS-6600:2>enable
DGS-6600:15#configure terminal
DGS-6600:15(config)#interface eth4.20
DGS-6600:15(config-if)#spanning-tree port-priority 0
DGS-6600:15(config-if)#end
```

Specifying per Port Path Cost

The link path cost value represents the media speed. The path cost can be auto-determined based on the media type or manually specified by the user. The following table provides information about how the path cost is auto assigned.

Data Rate	Path Cost
1 Mb/s	20,000,000
10 Mb/s	2,000,000

Table 14-1 Auto-assigned Path Cost for an Interface

Data Rate	Path Cost
100 Mb/s	200,000
1 Gb/s	20,000
10 Gb/s	2000
100 Gb/s	200
1 Tb/s	20

Table 14-1 Auto-assigned Path Cost for an Interface

Use the following commands to specify the path cost for a port:

Command	Explanation
<code>spanning-tree cost <i>COST</i></code>	Explicitly specifies the link path cost for a port.
<code>no spanning-tree cost <i>COST</i></code>	Specifies that the link path cost for a port should be auto-determined.

In the following example, the user configures the port cost of Ethernet interface 4.7 to be 20000:

```
DGS-6600:2>enable
DGS-6600:15#configure terminal
DGS-6600:15(config)#interface eth4.7
DGS-6600:15(config-if)#spanning-tree cost 20000
DGS-6600:15(config-if)#end
```

Specifying the Timers

The user can specify the hello time, forward delay time, and maximum age to be used in the STP or RSTP state machine computation.

Use the following command to configure the Spanning Tree timers:

Command	Explanation
<code>spanning-tree [hello-time <i>SECONDS</i> forward-time <i>SECONDS</i> max-age <i>SECONDS</i>]</code>	Specifies the values for the Spanning Tree timers.

In the following example, the user configures the STP hello timer to be 1 second, the forward time to be 16 seconds, and the maximum aging time to be 21 seconds:

```
DGS-6600:2>enable
DGS-6600:15#configure terminal
DGS-6600:15(config)#spanning-tree hello-time 1
DGS-6600:15(config)#spanning-tree forward-time 16
DGS-6600:15(config)#spanning-tree max-age 21
DGS-6600:15(config)#end
```

Displaying and Verifying STP Protocol Operations

Use the following command to display and verify the Spanning Tree Protocol operations:

Command	Explanation
<code>show spanning-tree [interface <i>INTERFACE-ID</i> [, -]]</code>	Displays the Spanning Tree Protocol operations.

In the following example, the user displays information about the Spanning Tree Protocol operation for the whole Switch:

```
DGS-6600:2>show spanning-tree

Spanning tree      : Enabled, Mode: RSTP
Forwarding BPDU    : Disabled

Root ID Priority   : 4097
  Address          : 00-04-9B-78-08-00
  Root Path Cost   : 2000
  Hello Time       : 2 sec, Max Age: 20 sec, Forward Delay: 15 sec

Bridge ID Priority : 4097
  Address          : 00-04-9B-78-08-00
  Hello Time       : 2 sec, Max Age: 20 sec, Forward Delay: 15 sec
  Tx Hold Count    : 6

Topology Changes Count : 2

codes - F: Fast forwarding is configured as enabled
        Configured link type: A - Auto, P - point to point, S - shared

   Interface Role      State      Cost      Priority Link
   ----- --
   FA eth3.3  Designated Forwarding  20000    128.3   P2P   Edge
   FA eth3.5  Backup      Discarding 200000    128.5   P2P   None-edge
   A eth3.6   Designated  Discarding 200000    128.6   Shr   Edge
   P eth3.7   Root        Forwarding  2000      128.9   P2P   None-edge

Total Entries: 4

DGS-6600:2>
```

Configuring Multiple Spanning Tree Instances

The following topics are included in this section:

- [Specifying the MST Configuration ID](#)
- [Specifying the MSTP Timer](#)
- [Specifying per Port Hello Time](#)
- [Specifying per Tree Bridge Priority](#)
- [Specifying per Tree per Port Priority](#)
- [Specifying per Tree per Port Path Cost](#)

- [Displaying and Verifying MSTP Protocol Operations](#)

Specifying the MST Configuration ID

The MST Configuration ID is conveyed in the BPDU. The local bridge and the neighbor bridge must have the same configuration ID for them to be in the same MST region. The MST Configuration ID is comprised of the region name, the revision level, and the digest of the VLAN to MSTI mapping table.

An MSTI is identified by the Tree ID. MSTI 0 is also the IST. By default, all VLANs are mapped to the IST. The user should re-map VLAN to other MSTIs. All the unmapped VLANs are mapped to an IST. The recommendation is that all VLANs are mapped to other MSTIs. If mapped to an IST, VLAN traffic may be blocked on some ports in certain conditions if there is an error with the STP configuration.

Use the following commands to specify the Configuration ID for an MST:

Command	Explanation
<code>spanning-tree mst configuration</code>	Enters MST configuration mode.
<code>instance <i>INSTANCE-ID</i> vlan <i>VLAN-ID</i> [, -]</code>	Specifies the VLAN or set of VLANs that should be mapped to an MST instance.
<code>name <i>NAME</i></code>	Specifies a name for the MST region.
<code>revision <i>VERSION</i></code>	Specifies a revision number for the MST configuration.
<code>show spanning-tree mst configuration</code>	Displays the MST configuration.

In the following example, the user specifies that the Switch will use MSTP, configures a new MSTP instance numbered 1, names the new instance “Corp-STP”, assigns a revision number of 1, and verifies the settings:

```
DGS-6600:2>enable
DGS-6600:15#configure terminal
DGS-6600:15(config)#spanning-tree mode mstp
DGS-6600:15(config)#spanning-tree mst configuration
DGS-6600:15(config-mst)#instance 1 vlan 300-304
DGS-6600:15(config-mst)#name Corp-STP
DGS-6600:15(config-mst)#revision 1
DGS-6600:15(config-mst)#end
DGS-6600:15#show spanning-tree mst configuration
Name                : Corp-STP
Revision            : 1
Instance  Vlans mapped
-----  -
0         1-299,305-4094
1         300-304

Total Entries:2

DGS-6600:15#
```

Specifying the MSTP Timer

The user can specify the timers used for the forward delay, maximum age, and maximum number of hops for the MSTP state machine computation.

The maximum number of hops of the CIST regional root bridge will be the initial value of the remaining hops for the IST conveyed in the MST BPDU, and decremented by one by each of the following nodes in the IST. The maximum number of hops for the MSTI root bridge will be the initial value of the remaining hops for the MSTI conveyed in the MST BPDU, and will be decremented by one by each of the following MSTI nodes. The MST BPDU will be discarded when it reaches zero.

Use the following command to configure the timers used by MSTP:

Command	Explanation
<code>spanning-tree mst {forward-time SECONDS max-age SECONDS max-hops HOP-COUNT}</code>	Configures the timers used by MSTP.

In the following example, the user configures the MSTP forward time to be 14 seconds, the MSTP maximum age time to be 19 seconds, and restricts the maximum hop of one BPDU to 19 hops:

```
DGS-6600:2>enable
DGS-6600:15#configure terminal
DGS-6600:15(config)#spanning-tree mst forward-time 14
DGS-6600:15(config)#spanning-tree mst max-age 19
DGS-6600:15(config)#spanning-tree mst max-hops 19
DGS-6600:15(config)#end
```

Specifying per Port Hello Time

Unlike STP and RSTP, the hello time in MSTP can be specified for each port.

Use the following command to configure the MSTP hello time for an interface:

Command	Explanation
<code>spanning-tree mst hello-time SECONDS</code>	Specifies the MSTP hello time for the interface.

In the following example, the user configures the MSTP hello time on Ethernet interface 4.20 to be 1 second:

```
DGS-6600:2>enable
DGS-6600:15#configure terminal
DGS-6600:15(config)#interface eth4.20
DGS-6600:15(config-if)#spanning-tree mst hello-time 1
DGS-6600:15(config-if)#end
```

Specifying per Tree Bridge Priority

The user should specify a bridge priority for each MSTI instance. The bridge priority must be divisible by 4096.

Use the following command to specify the bridge priority for an instance:

Command	Explanation
<code>spanning-tree mst <i>INSTANCE-ID</i> priority <i>PRIORITY</i></code>	Specifies the bridge priority for an instance.

In the following example, the user specifies a priority of 0 for MSTI instance 0:

```
DGS-6600:2>enable
DGS-6600:15#configure terminal
DGS-6600:15(config)#spanning-tree mst 0 priority 0
DGS-6600:15(config)#end
```

Specifying per Tree per Port Priority

For each port in an MSTI, the user should specify the port priority. The specified port priority must be dividable by 16. The port priority is an import factor in determining the active topology of the MSTI.

Use the following command to specify the port priority on each tree:

Command	Explanation
<code>spanning-tree mst <i>INSTANCE-ID</i> port-priority <i>PRIORITY</i></code>	Specifies the port priority for each tree.

In the following example, the user configures instance ID 0 on Ethernet Interface 4.20 to have a port priority of 64:

```
DGS-6600:2>enable
DGS-6600:15#configure terminal
DGS-6600:15(config)#interface eth4.20
DGS-6600:15(config-if)#spanning-tree mst 0 port-priority 64
DGS-6600:15(config-if)#end
```

Specifying per Tree per Port Path Cost

For each port of each MSTI, the user should specify the path cost, which will be used in computation of the MSTI active topology. Besides, for each port, the user can specify the external path cost, which will be used in the computation of the CST active topology.

Use the following commands to specify the cost of each port path for each tree:

Command	Explanation
<code>spanning-tree mst <i>INSTANCE-ID</i> cost <i>COST</i></code>	Specifies the internal link path cost for the MSTI.
<code>spanning-tree cost <i>COST</i></code>	Specifies the external path cost for the CST.

In the following example, the user configures the internal link path cost for MSTI instance ID 0 to be 17031970 and the external path cost to be 20000 on Ethernet interface 4.20:

```
DGS-6600:2>enable
DGS-6600:15#configure terminal
DGS-6600:15 (config)#interface eth4.20
DGS-6600:15 (config-if)#spanning-tree mst 0 cost 17031970
DGS-6600:15 (config-if)#spanning-tree cost 20000
DGS-6600:15 (config-if)#end
```

Displaying and Verifying MSTP Protocol Operations

Use the following commands to display and verify the MSTP protocol information:

Command	Explanation
<code>show spanning-tree mst instance <i>INSTANCE-ID</i> [, -]</code>	Displays the MSTP information for an instance or set of instances.
<code>show spanning-tree mst interface <i>INTERFACE-ID</i> [, -]</code>	Displays the MSTP information for an interface or set of instances.
<code>show spanning-tree mst configuration</code>	Displays the MSTP information for the VLAN and MSTI mapping table.
<code>show spanning-tree mst configuration digest</code>	Displays the MD5 digest included in the current MST configuration identifier.

In the following example, the user displays the MSTP information for instance 0:

```
DGS-6600:2>show spanning-tree mst instance 0

Spanning tree : Enabled , protocol : MSTP
Operational   : Forward delay 14, Max age 19
Configured    : Forward delay 14, Max age 19
                Max hops 19, Transmit Hold count 5

>>>> MST0      vlans mapped: 1-299,305-4094
Bridge address: 06-8b-00-19-00-00 , Priority: 4096 (4096 sysid 0)
Designated Root: address:06-8b-00-19-00-00 , Priority: 4096 (4096 sysid 0)
Regional Root : address:06-8b-00-19-00-00 , Priority: 4096 (4096 sysid 0)
Internal Root path cost: 0
Designated Bridge : address:06-8b-00-19-00-00 , Priority: 4096 (4096 sysid 0)
Topology Changes Count : 1

codes - F : Fast forwarding on the port is enabled
        Configured link type : A: Auto , P: point to point , S: shared

Interface      Role          State          Cost          Priority      Link
-----      -
A eth4.47      Designated    Forwarding     200000        128.303      P2P  Edge

DGS-6600:2>
```

In the following example, the user displays the MSTP information for Ethernet interface 4.11:

```
DGS-6600:2>show spanning-tree mst interface eth4.11

eth4.11
  STP state                : Enabled
  Configured Fast-Forwarding : Auto, Operation status: None-Edge
  Configured Link type      : Auto, Operation status: P2P
  Configured Ext Path Cost  : Auto, Operation result: 20000000
  Hello Time                : 2 secs
  Guard Root                : Disabled
  Tcn Filtering             : Disabled

Instance Role      State      Internal
-----
0      Disabled    Disabled  20000000  128
1      Disabled    Disabled   0         128

DGS-6600:2>
```

In the following example, the user display the MD5 digest included in the current MST configuration identifier.

```
DGS-6600:15#show spanning-tree mst configuration digest
Name          : Corp-STP
Revision      : 1, Instances configured 2
Digest        : 38 19 74 10 eb ef ea 41 38 02 dc cc 30 66 ac fe
```

In the following example, the user displays the MSTP information for the VLAN and MSTI mapping table.

```
DGS-6600:15(config)#show spanning-tree mst configuration
Name          : Corp-STP
Revision      : 1
Instance  Vlans mapped
-----
0          1-299,305-4094
1          300-304

Total Entries:2

DGS-6600:15#
```

Configuring Optional Features

The following topics are included in this section:

- [Root Guard](#)
- [TCN Filter](#)
- [Displaying the Optional Feature Settings](#)

Root Guard

The user can restrict a port from becoming a root port for some applications. This feature is typically used in a service-provider environment, where the network administrator wants to prevent a low speed port being a root for the local bridge networks. When this restriction is applied, the port will become alternate port and relinquish the root port role to another candidate port.

Use the following command to enable the root guard feature on an interface:

Command	Explanation
<code>spanning-tree guard root</code>	Enables the root guard feature on the specified interface.

In the following example, the user enables the root guard feature on Ethernet interface 4.47:

```
DGS-6600:2>enable
DGS-6600:15#configure terminal
DGS-6600:15 (config)#interface eth4.47
DGS-6600:15 (config-if)#spanning-tree guard root
DGS-6600:15 (config-if)#end
```

TCN Filter

When the Topology Change Notification (TCN) filter is enabled for a port, the TCN notification received by the port will not be propagated. One of the applications of this function is to prevent bridges that are external to a core region of the network from causing address flushing in that region, possibly because those bridges are not under the full control of the administrator.

Use the following command to enable TCN filtering on an interface:

Command	Explanation
<code>spanning-tree tcnfilter</code>	Enables the TCN filter on the specified interface.

In the following example, the user enables TCN filtering on Ethernet interface 4.5:

```
DGS-6600:2>enable
DGS-6600:15#configure terminal
DGS-6600:15 (config)#interface eth4.5
DGS-6600:15 (config-if)#spanning-tree tcnfilter
DGS-6600:15 (config-if)#end
```

Displaying the Optional Feature Settings

Use the following command to verify the MSTP optional feature settings:

Command	Explanation
<code>show spanning-tree mst interface INTERFACE-ID [, -]</code>	Displays the configuration for the MSTP optional feature settings.

In the following example, the user verifies the configuration of the MSTP optional settings on Ethernet interface 4.47:

```
DGS-6600:2>show spanning-tree mst interface eth4.47

eth4.47
  STP state                : Enabled
  Configured Fast-Forwarding : Auto, Operation status: Edge
  Configured Link type      : Auto, Operation status: P2P
  Configured Ext Path Cost  : Auto, Operation result: 200000
  Hello Time                : 2 secs
  Guard Root                : Enabled
  Tcn Filtering             : Disabled

Instance Role      State      Internal
-----
0      Designated Designated 200000 128

DGS-6600:2>
```

Configuration Examples

RSTP Configuration example

In this example, the RSTP is configured to provide "loop avoidance" and "redundant link". R1 and R2 run RSTP. R1 is the root bridge (STP priority 4096). R1 and R2 eth2.1-2.4 are edge ports, which are used to connect to PC. A port (eth2.6 in this example) will be the block port by RSTP algorithm, providing Loop avoidance. If the active path is broken (e.g., eth2.5 is down), the "blocking" port will become the forwarding port and become the active link, providing redundant link.

Topology

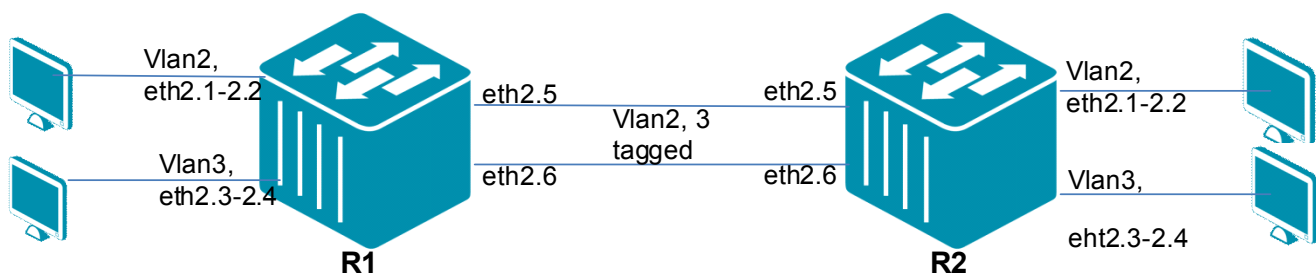

Figure 14-3RSTP Configuration Topology

R1 (Route 1) Configuration Steps

Step 1: Create VLAN 2, 3

```
DGS-6600:15(config)#vlan 2
DGS-6600:15(config-vlan)#vlan 3
```

Step 2: Add ports into VLAN and set edge ports eth2.1-2.4

```
DGS-6600:15(config-vlan)#interface eth2.1
DGS-6600:15(config-if)# access vlan 2
DGS-6600:15(config-if)#spanning-tree fast-forwarding
DGS-6600:15(config-if)#interface eth2.2
DGS-6600:15(config-if)# access vlan 2
DGS-6600:15(config-if)#spanning-tree fast-forwarding
DGS-6600:15(config-if)#interface eth2.3
DGS-6600:15(config-if)# access vlan 3
DGS-6600:15(config-if)#spanning-tree fast-forwarding
DGS-6600:15(config-if)#interface eth2.4
DGS-6600:15(config-if)# access vlan 3
DGS-6600:15(config-if)#spanning-tree fast-forwarding
DGS-6600:15(config-if)#interface eth2.5
DGS-6600:15(config-if)# trunk allowed-vlan 2-3
DGS-6600:15(config-if)#interface eth2.6
DGS-6600:15(config-if)# trunk allowed-vlan 2-3
```

Step 3: Enable spanning tree, configure STP mode as rstp, and configure STP priority to be 4096 (higher priority) so that R1 will become the root bridge.

```
DGS-6600:15(config)#spanning-tree
DGS-6600:15(config-if)#spanning-tree mode rstp
DGS-6600:15(config)#spanning-tree priority 4096
```

R2 (Router 2) Configuration Steps

Step 1: Create VLAN 2, 3

```
DGS-6600:15(config)#vlan 2
DGS-6600:15(config-vlan)#vlan 3
```

Step 2: Add port into VLAN and set edge port for eth2.1-2.4

```
DGS-6600:15(config-vlan)#interface eth2.1
DGS-6600:15(config-if)# access vlan 2
DGS-6600:15(config-if)#spanning-tree fast-forwarding
DGS-6600:15(config-if)#interface eth2.2
DGS-6600:15(config-if)# access vlan 2
DGS-6600:15(config-if)#spanning-tree fast-forwarding
DGS-6600:15(config-if)#interface eth2.3
DGS-6600:15(config-if)# access vlan 3
DGS-6600:15(config-if)#spanning-tree fast-forwarding
DGS-6600:15(config-if)#interface eth2.4
DGS-6600:15(config-if)# access vlan 3
DGS-6600:15(config-if)#spanning-tree fast-forwarding
DGS-6600:15(config-if)#interface eth2.5
DGS-6600:15(config-if)# trunk allowed-vlan 2-3
DGS-6600:15(config-if)#interface eth2.6
DGS-6600:15(config-if)# trunk allowed-vlan 2-3
```

Step 3: Configure STP mode is rstp and enable stp. The STP priority uses default value, which is 32768, so that R1 is will be the root bridge.

```
DGS-6600:15(config)#spanning-tree
DGS-6600:15(config-if)#spanning-tree mode rstp
```

Verifying the Configuration

Step 1: Use commands below to check the RSTP configuration on R1:

```
DGS-6600:15#show spanning-tree

Spanning tree    : Enabled,  Mode : RSTP
Forwarding BPDU  : Disabled

Root ID          Priority      : 4096
Address          : 00-01-02-03-04-00

Bridge ID        Priority      : 4096
Address          : 00-01-02-03-04-00
Hello Time       : 2   sec, Max Age : 20 sec, Forward Delay : 15 sec
TX Hold Count    : 6

Topology Changes Count : 5

codes - F : Fast forwarding is configured as enabled
Configured link type : A - Auto, P - point to point, S - shared

Interface        Role          State          Cost          Priority .Port  Link
-----
FA eth2.1        Designated   Forwarding    20000         128.65   P2P   Edge
FA eth2.3        Designated   Forwarding    20000         128.67   P2P   Edge
A eth2.5         Root         Forwarding    20000         128.69   P2P   None-Edge
A eth2.6         Alternate    Discarding    20000         0.70    P2P   None-Edge
```

Step 2: Use the commands below to check the RSTP configuration on R2:

```
DGS-6600:15#show spanning-tree

Spanning tree    : Enabled,   Mode : RSTP
Forwarding BPDU  : Disabled
Root ID          : Priority    : 4096
                  Address      : 00-01-02-03-04-00
                  Root Path Cost : 20000
                  Hello Time    : 2 sec, Max Age : 20 sec, Forward Delay : 15 sec

Bridge ID        : Priority    : 32768
                  Address      : 06-0b-00-27-00-00
                  Hello Time    : 2 sec, Max Age : 20 sec, Forward Delay : 15 sec
                  TX Hold Count : 6

Topology Changes Count : 2

codes - F : Fast forwarding is configured as enabled
        Configured link type : A - Auto, P - point to point, S - shared

Interface      Role      State      Cost      Priority .Port  Link
-----      -
FA eth2.1      Designated Forwarding 200000    128.65   P2P   Edge
FA eth2.3      Designated Forwarding 200000    128.67   P2P   Edge
A eth2.5       Root      Forwarding 20000     128.69   P2P   None-Edge
A eth2.6       Alternate Discarding 20000     128.70   P2P   None-Edge
```

Notes: Please Check whether PCs in same VLAN can ping each other.

Unplug eth2.5 cable. The PING will be time-out for few second (3-7 sec) and will be back, indicating the redundancy working.

MSTP Configuration Example

In this example, MSTP is configured to provide (1) loop avoidance, (2) Redundant links and (3) Load sharing. MSTP instance 0 contains VLAN2; MSTP instance 1 contains VLAN3.

R1 is the root bridge for both instance 0 and 1. For instance 0, the blocking port is on R2 eth2.6, and therefore VLAN2 traffic will be forwarded using eth2.5 link.

For instance 1, the blocking port is on R2 eth2.5, and therefore VLAN3 traffic will be forwarded using eth2.6 link. This can provide load sharing function.

If one of path is broken (e.g., eth2.5 is down), then the other link will be the active path for VLAN2 and VLAN3. If that link is recovered (e.g., eth2.5 is up again), VLAN2 and VLAN3 will use their active link again (Load sharing).

Topology

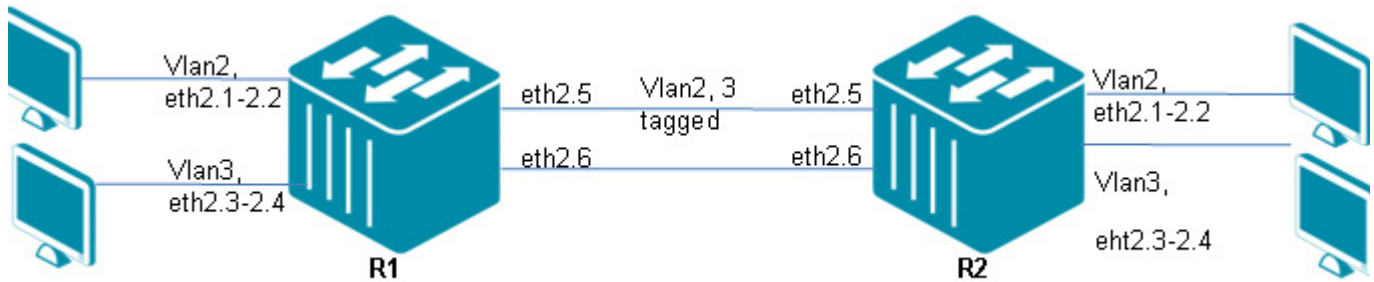

Figure 14-4 MSTP Configuration Topology

R1 (Router 1) Configuration Steps

Step 1: Create VLAN 2, 3

```
DGS-6600:15(config)#vlan 2
DGS-6600:15(config-vlan)#vlan 3
```

Step 2: Configure access ports into VLAN, and set edge ports.

```
DGS-6600:15(config-vlan)#interface range eth2.1-2.2
DGS-6600:15(config-if)# access vlan 2
DGS-6600:15(config-if)#spanning-tree fast-forwarding
DGS-6600:15(config-if)#interface range eth2.3-2.4
DGS-6600:15(config-if)# access vlan 3
DGS-6600:15(config-if)#spanning-tree fast-forwarding
```

Step 3: Configure trunk ports into VLAN and set STP port priority.

```
DGS-6600:15(config-if)#interface range eth2.5
DGS-6600:15(config-if)# trunk allowed-vlan 2-3
DGS-6600:15(config-if)#spanning-tree mst 0 port-priority 0
DGS-6600:15(config-if)#interface eth2.6
DGS-6600:15(config-if)# trunk allowed-vlan 2-3
DGS-6600:15(config-if)#spanning-tree mst 1 port-priority 0
```

Step 4: Set STP mode to mstp and enable STP, and configure R1 has higher priority (smaller value 4096) in each instance so that R1 can be the root bridge for both instances 0 and 1.

```
DGS-6600:15(config-if)#spanning-tree mst configuration
DGS-6600:15(config-mst)# instance 1 vlan 3
DGS-6600:15(config-mst)#name dlink
DGS-6600:15(config-mst)#spanning-tree mode mstp
DGS-6600:15(config)#spanning-tree mst 0 priority 4096
DGS-6600:15(config)#spanning-tree mst 1 priority 4096
DGS-6600:15(config)#spanning-tree
```

R2 (Router) Configuration Steps

Step 1: Create VLAN 2, 3

```
DGS-6600:15(config)#vlan 2
DGS-6600:15(config-vlan)#vlan 3
```

Step 2: Configure access ports into VLAN, and set edge ports.

```
DGS-6600:15(config-vlan)#interface range eth2.1-2.2
DGS-6600:15(config-if)# access vlan 2
DGS-6600:15(config-if)#spanning-tree fast-forwarding
DGS-6600:15(config-if)#interface range eth2.3-2.4
DGS-6600:15(config-if)# access vlan 3
DGS-6600:15(config-if)#spanning-tree fast-forwarding
```

Step 3: Configure trunk ports into VLAN, and use default port priority.

```
DGS-6600:15(config-if)#interface range eth2.5-2.6
DGS-6600:15(config-if)# trunk allowed-vlan 2-3
```

Step 4: Set STP mode to mstp and enable STP, and use default priority value (32768 in each instance so that R1 has can be the root bridge for both instances 0 and 1.

```
DGS-6600:15(config-if)#spanning-tree mst configuration
DGS-6600:15(config-mst)# instance 1 vlan 3
DGS-6600:15(config-mst)#name dlink
DGS-6600:15(config-mst)#spanning-tree mode mstp
DGS-6600:15(config)#spanning-tree
```

Verifying the Configuration

Step 1: Use the following command to check R1 and R2 MSTP configuration.

```
DGS-6600:15#show spanning-tree mst

Spanning tree   : Enabled,  Mode :  MSTP
Forwarding BPDU : Disabled
Operational     : Forward delay 15, Max age 20
Configured      : Forward delay 15, Max age 20
                  Max hops 20, Transmit Hold count 6

>>>> MST0      vlans mapped: 1-2,4-4094
Bridge address: 00-01-02-03-04-00 , Priority: 4096 (4096 sysid 0)
Designated Root: address:00-01-02-03-04-00 , Priority: 4096 (4096 sysid 0)
Regional Root  : address:00-01-02-03-04-00 , Priority: 4096 (4096 sysid 0)
Internal Root path cost: 0
Designated Bridge : address:00-01-02-03-04-00 , Priority: 4096 (4096 sysid 0)
Topology Changes Count : 8

codes - F : Fast forwarding on the port is enabled
        Configured link type : A: Auto , P: point to point , S: shared

Interface          Role      State          Priority      Link
-----          -----
Cost              .Port      Type          Edge
-----          -----
FA eth2.1          Designated Forwarding 20000        128.65      P2P      Edge
FA eth2.3          Designated Forwarding 20000        128.67      P2P      Edge
A eth2.5           Designated Forwarding 20000         0.69       P2P      None-Edge
A eth2.6           Designated Forwarding 20000        128.70      P2P      None-Edge

>>>> MST1      vlans mapped: 3
Bridge address: 00-01-02-03-04-00 , Priority: 4097 (4096 sysid 1)
Regional Root  : address:00-01-02-03-04-00 , Priority: 4097 (4096 sysid 1)
Internal Root path cost: 0
Designated Bridge : address:00-01-02-03-04-00 , Priority: 4097 (4096 sysid 1)
Topology Changes Count : 2
Remaining Hops : 20

codes - F : Fast forwarding on the port is enabled
        Configured link type : A: Auto , P: point to point , S: shared

Interface          Role      State          Priority      Link
-----          -----
Cost              .Port      Type          Edge
-----          -----
FA eth2.3          Designated Forwarding 20000        128.67      P2P      Edge
A eth2.5           Designated Forwarding 20000        128.69      P2P      None-Edge
A eth2.6           Designated Forwarding 20000         0.70       P2P      None-Edge
```

```
DGS-6600:15#show spanning-tree
Bridge is not in STP or RSTP version!

DGS-6600:15#show spanning-tree mst

Spanning tree    : Enabled,  Mode :  MSTP
Forwarding BPDU  : Disabled
Operational      : Forward delay 15, Max age 20
Configured       : Forward delay 15, Max age 20
                  Max hops 20, Transmit Hold count 6

>>>> MST0      vlans mapped: 1-2,4-4094
Bridge address: 06-0b-00-27-00-00 , Priority: 32768 (32768 sysid 0)
Designated Root: address:00-01-02-03-04-00 , Priority: 4096 (4096 sysid 0)
Root port : eth2.5 , External Root path cost: 0
Regional Root : address:00-01-02-03-04-00 , Priority: 4096 (4096 sysid 0)
Internal Root path cost: 20000
Designated Bridge : address:00-01-02-03-04-00 , Priority: 4096 (4096 sysid 0)
Topology Changes Count : 3

codes - F : Fast forwarding on the port is enabled
        Configured link type : A: Auto , P: point to point , S: shared
```

Interface	Role	State	Cost	Priority .Port	Link Type	Edge
FA eth2.1	Designated	Forwarding	200000	128.65	P2P	Edge
FA eth2.3	Designated	Forwarding	200000	128.67	P2P	Edge
A eth2.5	Root	Forwarding	20000	128.69	P2P	None-Edge
A eth2.6	Alternate	Discarding	20000	128.70	P2P	None-Edge

```
>>>> MST1      vlans mapped: 3
Bridge address: 06-0b-00-27-00-00 , Priority: 32769 (32768 sysid 1)
Regional Root : address:00-01-02-03-04-00 , Priority: 4097 (4096 sysid 1)
Internal Root path cost: 20000
Designated Bridge : address:00-01-02-03-04-00 , Priority: 4097 (4096 sysid 1)
Topology Changes Count : 3
Remaining Hops : 19

codes - F : Fast forwarding on the port is enabled
        Configured link type : A: Auto , P: point to point , S: shared
```

Interface	Role	State	Cost	Priority .Port	Link Type	Edge
FA eth2.3	Designated	Forwarding	200000	128.67	P2P	Edge
A eth2.5	Alternate	Discarding	20000	128.69	P2P	None-Edge
A eth2.6	Root	Forwarding	20000	128.70	P2P	None-Edge

VLAN2 PC ping each other and observe the traffic is forwarded in path via eth2.5. VLAN3 PC ping each other and observe the traffic is forwarded in path via eth2.6.

Link down eth2.5 cable. After few seconds (3-7 seconds), we can observe the Ping traffic between PCs for VLAN2 and VLAN3 all forwarded in active link (e.g., eth2.6), Re-plug the eth2.5 cable again. After few seconds, we can observe the PC ping traffic uses it's own link again.

List of Constants and Default Settings

Constant Name	Value
Maximum Multiple Spanning Tree Instances	64

Table 14-2 Constants Values

Variable Name	Default Value
Global STP State	Disable
Per Port STP State	Enabled
Hello Time	2
Forward Time	15
Maximum Age	20
Link Type	Auto-determined
STP Version	MSTP
Bridge Priority	32768
Port Priority	128
VLAN to MSTI Mapping	Mapped to CIST Instance
MST Region Name	Bridge MAC Address
MST Revision Level	0
MSTP Maximum Age	20
MSTP Maximum Hops	20
Transmit Hold Count	6
Fast Forwarding	Auto-determined
Root Guard	Disabled
TCN Filter	Disabled

Table 14-3 Default Variable Values

Chapter 15

Link Aggregation

Chapter Overview

The following topics are included in this chapter, please go to the topic for more detailed information:

- [Chapter Overview](#)
- [An Introduction to Port Channel Groups and LACP](#)
 - [Load Balance Hash Algorithm](#)
 - [Load Balance Hash Algorithm](#)
 - [Port and System Priority](#)
- [Link Aggregation Configuration Commands](#)
 - [Creating a Static Port Channel Group](#)
 - [Creating a Dynamic Port Channel Group](#)
 - [Configuration Restrictions](#)
 - [Specifying the Load Balancing Algorithm](#)
- [Configuration Examples](#)
 - [Link Aggregation Configuration Example](#)
- [Relations with Other Modules](#)
- [List of Constants and Default Settings](#)

An Introduction to Port Channel Groups and LACP

This chapter provides information on how to use and configure Port Channel Groups (static and Dynamic) and LACP.

A Port Channel Group is a function that is used to group a number of physical ports into a logical channel interface. The user can use this feature to support the high bandwidth demand needed for a trunk link. The traffic over the high bandwidth virtual interface is load balanced among the member ports. Since the traffic originally distributed on a specific member port will be automatically switched over to other member ports on failure of the original member port. Additionally, fault tolerance can also be achieved by the port channel group function.

There are two type of port channel group, static and dynamic. For a static port channel group, the member ports are statically assigned. For a dynamic port channel group, the user assigns the candidate member ports, but the actual member ports only form when the LACP protocol has negotiated with the partner device.

"Link aggregation" is a method of grouping physical link segments of the same media type and speed, and treating them as if they were part of a single, logical link segment. Link aggregation is an

important technology that can be used to aggregate bandwidth and to create resilient, redundant links, load sharing.

Feature mode	Mode	Description
Static Type	On	On mode that places a port into a non-negotiation state. Link aggregation is forced to be formed without any LACP negotiation.

Table 15-1

Load Balancing

For unicast packet, there are six algorithms to reach the load sharing. They are:

- Link selection based on source MAC address
- Link selection based on destination MAC address
- Link selection based on source MAC address exclusive destination MAC address
- Link selection based on source IP address
- Link selection based on destination IP address.
- Link selection based on source IP address exclusive destination IP address.

For non-unicast packets, the load balance uses a difference way which is not user-configurable.

- "For IP multicast packets, link selection based on destination IP address, source IP address, and source port
- "For broadcast, L2 multicast and unknown (DLF) packets, link selection based on destination MAC address, source MAC address and source port

Load Balance Hash Algorithm

TRUNKING BASED ON SA HASHING

In this mode, the device uses the source MAC address, VLAN, Ethertype and source module ID fields to hash.

TRUNKING BASED ON DA HASHING

In this mode, the device uses the destination MAC address, VLAN, Ethertype and source module ID fields to hash.

TRUNKING BASED ON DA-SA HASHING

In this mode, the device uses the destination, source MAC address, VLAN, Ethertype and source module ID fields to hash.

TRUNKING BASED ON SIP HASHING

In this mode, the device uses the source IP address and source port fields to hash.

TRUNKING BASED ON DIP HASHING

In this mode, the device uses the destination IP address and destination port fields to hash.

TRUNKING BASED ON DIP-SIP HASHING

In this mode, the index value is the XOR of mode 4 and mode 5 results

Port and System Priority

During LACP negotiation, the system priority and port priority of the local partner will be exchanged with the remote partner. When the max number actual member exceeds the limitation, the switch will use port priority to determine a port either in backup mode or active mode. The lacp system-priority determines which switch that controls the port priority. Port priorities on the other switch are ignored.

Link Aggregation Configuration Commands

Common commands, restrictions and commands to configure channel groups are listed below:

- [Creating a Static Port Channel Group](#)
- [Creating a Dynamic Port Channel Group](#)
- [Configuration Restrictions](#)
- [Specifying the Load Balancing Algorithm](#)

Creating a Static Port Channel Group

In a static port channel group, the member ports are statically assigned. To create a static port channel group, enter the interface mode for each of the member ports, and directly assign the channel group. When a channel group has its member ports assigned, the channel group is automatically created. When a port channel group has all its member ports removed, the port channel group will be automatically destroyed.

Use the following commands to create and display the static port channel group entries on the Switch:

Command	Explanation
<code>channel-group CHANNEL-NO mode {on active passive}</code>	Specifies the interface as a static member port of the specified port channel group.
<code>show channel-group [[channel [CHANNEL-NO] detail]</code>	Displays the detailed settings of the specified port channel group.



NOTE: When an interface is a member port of a port channel group, the membership must be removed before the interface can change membership to another channel group.

In the following example, the user creates channel group 3 and assigns Ethernet port 4.1 to 4.6 to the channel group:

```
DGS-6600:2>enable
DGS-6600:15#configure terminal
DGS-6600:15(config)#interface range eth4.1-4.6
DGS-6600:15(config-if)#channel-group 3 mode on
DGS-6600:15(config-if)#end
```

Creating a Dynamic Port Channel Group

In a dynamic port channel group, the candidate member ports are statically assigned, but the actual member ports are determined through the LACP protocol negotiation with the partner device. The user cannot specify the static member port in a dynamic port channel group.

To create a dynamic port channel group, enter the interface mode for the member ports, and directly assign the channel group. When a channel group has its member ports assigned, the channel group is automatically created. When a port channel group has all its member ports removed, the port channel group will be automatically destroyed.

When a group of ports is specified for a created dynamic port channel group, the LACP related attributes associated with these candidate ports must be explicitly assigned or automatically modified by the system needed for LACP protocol operation.

1) Active or Passive Mode

The user must specify the port operated in active mode or passive mode. In active mode, the port will actively send LACPDU. In passive mode, the port will passively responds to the received LACPDU. At least one side of the link must be in active mode for both sides to exchange the information.

2) Actor Admin Key

The system will automatically allocate a number and set the actor admin key of all candidate ports to this number. This key will be carried in the BPDU transmitted to the partner port, and become the partner operation key of the partner port.

3) System Priority and System ID

The system MAC address is used as the system ID. The LACP system-priority determines the switch that controls the port priority. If both local switch and remote switch have the same system priority, system ID will be checked. Both LACP system priority & system ID will be conveyed in the BPDU transmitted to the partner port, and become the partner system ID & priority of the partner port.

4) Port Priority and Port ID

The port priority determines which ports can join a port-channel and which ports are put in backup mode. When two ports have the same port priority, port number will be checked. They will be conveyed in the BPDU transmitted to the partner port. and become the partner priority vector of the partner port.

Use the following commands to create and display the dynamic port channel group entries on the Switch:

Command	Explanation
<code>channel-group CHANNEL-NO mode {on active passive}</code>	Specifies the interface as a candidate member port of the specified dynamic port channel group.
<code>lacp system-priority PRIORITY</code>	Configures the system priority.

Command	Explanation
<code>lacp port-priority PRIORITY</code>	Configures the port priority.
<code>show channel-group [[channel [CHANNEL-NO] [detail neighbor protocol]] load-balance sys-id]</code>	Displays the information for the dynamic port channel group.

In the following example, the user configures Ethernet ports 4.1 to 4.6

```
DGS-6600:2>enable
DGS-6600:15#configure terminal
DGS-6600:15(config)#lacp system-priority 30000
DGS-6600:15(config)#interface range eth4.1-4.6
DGS-6600:15(config-if)#channel-group 5 mode active
DGS-6600:15(config-if)#lacp port-priority 20000
DGS-6600:15(config-if)#end
```

Configuration Restrictions

- 1) 802.1x enabled ports cannot be specified as channel group member ports.
- 2) Port-security enabled ports cannot be specified as channel group member ports.
- 3) A port channel virtual interface cannot be specified as a source port or destination port for mirror sessions.
- 4) A candidate member port can only be assigned when they are set to full duplex mode, and operating at the same speed.



NOTE: For other layer 2 settings, such as STP settings, if a physical port is a member of a channel port, then the STP setting on the physical port will not have any effect. The STP setting on the channel group will take effect instead.

Specifying the Load Balancing Algorithm

When the system forwards traffic to a port channel group, the system will use the configured algorithm to distribute the traffic among the member ports to balance the traffic load.

The traffic load on the Switch can be balanced, based on one of the following criteria items:

- Source MAC Address
- Destination MAC Address
- Source and Destination MAC Address
- Source IP Address
- Destination IP Address
- Source and Destination IP Address

Use the following commands to create and display the port channel group entries on the Switch:

Command	Explanation
<code>port-channel load-balance {dst-ip dst-mac src-dst-mac src-ip src-mac}</code>	Configures the load balancing algorithm.
<code>show channel-group [[channel [CHANNEL-NO]] load-balance</code>	Displays the load balancing algorithm settings.

In the following example, the user configures the Switch to load-balance packets based on the source IP address:

```
DGS-6600:2>enable
DGS-6600:15#configure terminal
DGS-6600:15(config)#port-channel load-balance src-ip
DGS-6600:15(config)#end
DGS-6600:15#show channel-group load-balance
load-balance algorithm: src-dst-mac
DGS-6600:15#
```

Configuration Examples

Link Aggregation Configuration Example

In the following example, four ports, eth2.5-2.8 in R1 and R2, respectively, are configured as Link Aggregation group using LACP protocol and load-balance algorithm is source-MAC.

And then packet generator (e.g., Smartbits) is used to generate traffic with difference source MAC addresses (e.g., 400). The traffic should be equally or near-equally load shared in each link.

If some of link(s) are linked-down, the traffic will be re-load-sharing to those existing links.

Topology

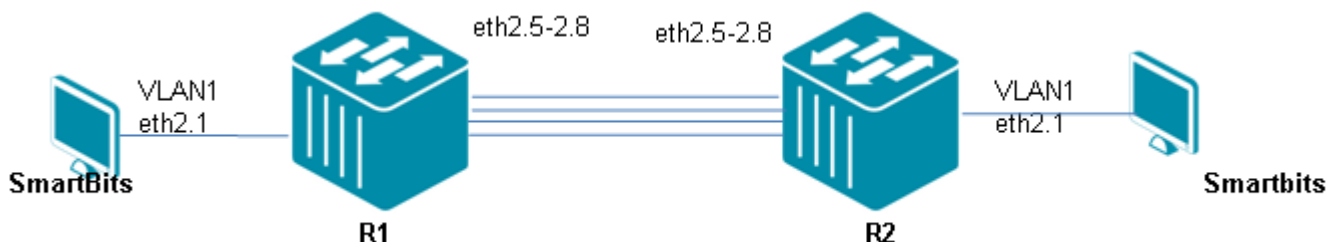

Figure 15-1 Link Aggregation Configuration Topology

R1 (Router 1) Configuration Steps

Step 1: Choose LACP mechanism

```
DGS-6600:15(config)#port-channel load-balance src-mac
```

Step 2: Assign port2.5-2.8 to channel-group 1

```
DGS-6600:15(config)#interface range eth2.5-2.8
DGS-6600:15(config-if)# channel-group 1 mode active
```

R2 (Router 2) Configuration Steps

Step 1: Choose LACP mechanism

```
DGS-6600:15(config)#port-channel load-balance src-mac
```

Step 2: assign port2.5-2.8 to channel-group 1

```
DGS-6600:15(config)#interface range eth2.5-2.8
DGS-6600:15(config-if)# channel-group 1 mode active
```

Verifying The Configuration

Step 1: Use command: "show channel-group", and "show channel-group channel" to check the configuration. Taking R1 as the example below:

```
DGS-6600:15#show channel-group
```

```
Group          Protocol
-----
1              LACP
```

```
Total Entries: 1
```

```
load-balance algorithm: src-mac
system-ID: 32768,00-01-02-03-04-00
```

```
DGS-6600:15#show channel-group channel 1 detail
```

```
Channel Group 1
```

```
Member Ports: 4, Maxports =16,Protocol: LACP
```

Port	Flags	LACP State	Port Priority	Port Number
eth2.5	FA	Up	32768	69
eth2.6	FA	Up	32768	70
eth2.7	FA	Up	32768	71
eth2.8	FA	Up	32768	72

Please note that:

Packet generator injects packets with difference source MAC address. Unplug one port (e.g, eth2.5), the traffic will be load shared based on rest of existing links (3). Re-plug that port, the traffic will be load shard based on all (4) ports.

Relations with Other Modules

- 1) An 802.1x enabled port cannot be specified as a channel group member port.
- 2) A port-security enabled port cannot be specified as a channel group member port.
- 3) A port-channel virtual interface cannot be specified as a source port or destination port for mirror sessions.

List of Constants and Default Settings

Constant Name	Value
Maximum Number of Channel Groups	128
Maximum Number of Members in a Static Group	8
Maximum Number of Candidate Members in a Dynamic Group	16

Table 15-2 Constants Values

Variable Name	Default Value
Load Balancing Algorithm	Source-Destination MAC Address
LACP Port Priority	32768
LACP System Priority	32768

Table 15-3 Default Variable Values

Chapter 16

Proxy ARP

Chapter Overview

The following topics are included in this chapter, please go to the topic for more detailed information:

- [Chapter Overview](#)
 - [An Introduction to Proxy ARP](#)
 - [Operation Concept](#)
 - [Parameters](#)
 - [Per Interface parameter](#)
 - [Sanity checks for ARP request](#)
 - [Acceptable route](#)
 - [Proxy ARP Configuration Commands](#)
 - [Enabling Authentication](#)

An Introduction to Proxy ARP

This chapter describes the guidelines for configuring the Proxy ARP function. Proxy ARP (Address Resolution Protocol) is the technique which let router answers ARP requests on one of its network intended for another machine. The router answers for those addresses with an ARP reply matching the target IP address with the router's Ethernet address. When the target replies to traffic from the request, the target will send the packets for the request to router. The router acts as proxy agent and is responsible for the relaying packets for the sender of ARP request to the destination address.

Operation Concept

Configure to enable Proxy ARP or local proxy ARP on an interface would activate to reply ARP request for hosts.

Parameters

The parameters that list below can be display or/and configured for the user. The "Attribute" field of the following table is given the definition below:

Config - indicate the value of the parameter is configurable

Show - indicate the value of the parameter can be displayed

Config/show - indicate the parameter is both configurable and can be displayed

Per Interface parameter

The following parameters can configure the VLAN to enable proxy ARP or local proxy ARP.

Parameter Name	Attribute	Default Value	Value Range	Description
Proxy arp interface state	Config/Show	Disable	Enable/Disable	Indicate if the interface enables proxy ARP
Local proxy arp interface state	Config/Show	Disable	Enable/Disable	Indicate if the interface enables local proxy ARP

Table 16-1 Configurable parameters

Sanity checks for ARP request

According to RFC1027, there are some checks need to be done before Proxy ARP can reply.

a)ARP for broadcast IP can not reply: If the gateway were to respond with an ARP reply in this situation, it would be inviting the original source to send actual traffic to a broadcast address.

b)Must not reply if the physical networks of the source and target of an ARP request are the same.

c)Must not reply if IP class of the source and target hosts of an ARP request are different. The same IP networks are local IP network. This is to prevent the ARP subnet gateway from being used to reach foreign IP networks and thus possibly bypass security checks provided by IP gateways.

Acceptable route

The following rules will be used to tell if the found route is acceptable.

a)The default route must not be used while look up for route.

If the default route were used, the system would always reply the ARP request, even if the system cannot forward the packets.

b)If the network interfaces on which the request was received and through which the route to the target passes are the same, the gateway must not reply.

The target host can answer for itself.

Proxy ARP Configuration Commands

Enabling Authentication

To enable proxy-arp please use the following commands.

Command	Explanation
<code>ip local-proxy-arp</code>	Use this command to enable local proxy ARP features on an interface. Use the no form of this command to disable local proxy ARP features on an interface.

Command	Explanation
ip proxy-arp	Use this command to enable proxy ARP features on an interface. Use the no form of this command to disable proxy ARP features on an interface.
show ip proxy-arp	Display the proxy ARP and local proxy ARP configuration.

Enabling Proxy ARP function on a VLAN100, Use this command to enable proxy ARP functions. After activation the device will answer ARP request intended for other host, if any route to this host is found and accept and this ARP request packet passed the sanity checks.

```
DGS6600:2>enable
DGS6600:15#configure terminal
DGS6600:15(config)#interface vlan100
DGS6600:15(config-if)#ip proxy-arp
```

Use the **ip local-proxy-arp** command to enable local proxy ARP function on an interface. If local proxy ARP function is enabled, the local proxy ARP feature allows the switch to respond to ARP requests for targeted IP addresses if the ingress interface is the same as the egress interface after routing tables are referenced, which normally no routing is required. This is primarily used when hosts in the connected subnet are L2-separated with features like Private VLAN. The IP proxy ARP features must be enabled before local proxy ARP features can be used.

```
DGS6600:2>enable
DGS6600:15#configure terminal
DGS6600:15(config)#interface vlan100
DGS6600:15(config-if)#ip local-proxy-arp
```

It is possible to show proxy arp settings using the **show ip proxy-arp** command.

```
DGS6600# show ip proxy-arp
List of interfaces configuration:
=====
Interface: vlan1
Proxy ARP:          Disable
Local proxy ARP:    Disable
Interface: vlan2
Proxy ARP:          Enable
Local proxy ARP:    Enable
Interface: vlan4
Proxy ARP:          Enable
Local proxy ARP:    Disable
=====
DGS6600#
```

Chapter 17

Super VLAN

Chapter Overview

The following topics are included in this chapter, please go to the topic for more detailed information:

- [Chapter Overview](#)
- [An Introduction to Super VLAN Overview](#)
- [Super VLAN Configuration Commands](#)
 - [Configuring a super VLAN](#)
 - [Setting Proxy ARP for a super VLAN interface](#)
- [Configuration Examples](#)
 - [Super VLAN Configuration Examples](#)
- [List of Constraints & restrictions](#)
- [List of Constants](#)

An Introduction to Super VLAN Overview

A Super VLAN is designed to contain multiple sub VLANs, thereby saving ip addresses. A super VLAN can be configured with an IP address of the virtual port, while a sub VLAN cannot be configured with the IP address of the virtual port.

Each sub VLAN is set to be a broadcast domain. Different sub VLANs are isolated at Layer 2. When users in a sub VLAN need to communicate with each other, they use the IP address of the virtual interface of the super VLAN as the IP address of the gateway. The IP address is shared by multiple VLANs. If a different sub VLAN wants to: communicate with another at Layer 3, or communicate with another network, an ARP proxy can be enabled. The address resolution protocol (ARP) proxy can forward and process ARP request and response packets so that the isolated sub VLANs can communicate with each other at Layer 3. For more information see the Proxy ARP chapter in this configuration guide or the Proxy ARP commands in the command line interface manual.

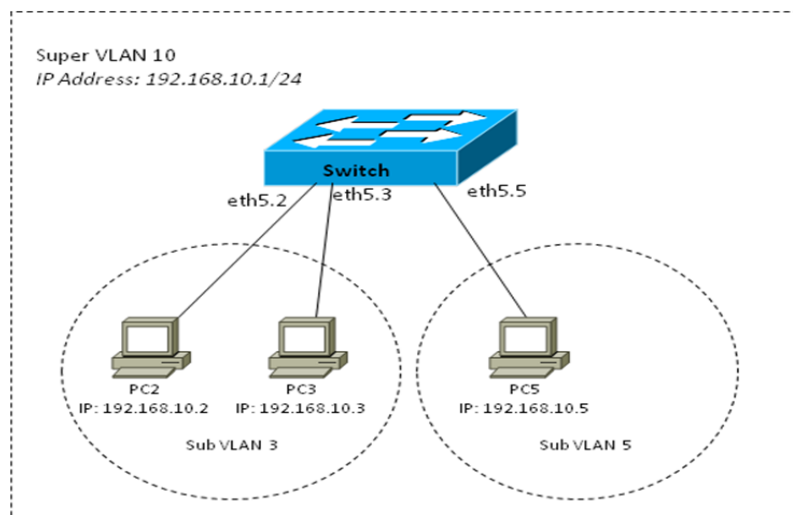

Figure 17-1 A simple Super VLAN Environment

The above figure illustrates a simple super VLAN environment. The VLAN 3 and VLAN 5 are configured as sub VLANs and are associated to the super VLAN 10. An IP address is assigned to super VLAN 10, and both sub VLAN 3 and sub VLAN 5 are located in this subnet. In this environment, PC2 and PC3 can communicate directly without a forwarding device. If PC3 in sub VLAN 3 wants to communicate with PC5 in the sub VLAN 5, after knowing that the peer is located in the same network segment, PC3 directly sends an ARP request packet with a destination IP address. Upon receiving this ARP request packet, the switch directly broadcasts this packet through Layer 2 within Sub VLAN 3, and sends a copy to the ARP module of the device. This module first checks whether the destination IP address in the ARP request packet is in Sub VLAN 3. If so, it will discard this packet because it and PC5 are located in the same broadcast domain, and the destination host will directly respond to PC3. If not, it will respond PC3 with the MAC address of Super VLAN 10, acting as an ARP agent.

Super VLAN Configuration Commands

The following table lists the Supervlan commands and an explanation of their functions.

Command	Explanation
supervlan	Use the supervlan command in the VLAN configuration mode to set the VLAN as a super VLAN. Use the no supervlan command in the VLAN configuration mode to delete the super VLAN.
subvlan VLAN-ID [, -]	Use subvlan command to specify the sub VLANs of a super VLAN. Use no subvlan command to delete sub VLANs. The Valid VLAN ID range is 1 to 4094.
subvlan-address-range	Use subvlan-address-range command to set the IP address range of the sub VLAN. Use the no subvlan-address-range command to remove the IP address range of the sub VLAN.
show supervlan	Use this command to show the configuration of the super VLAN and its sub VLANs.

Configuring a super VLAN

Firstly configure sub-VLANs.

Configure a super VLAN, and associate the super VLAN with the sub-VLANs configured earlier.

Configure a VLAN interface for the super VLAN. The VLAN interface enables communication among hosts and sub-VLANs.

Example: First set VLAN10 to supervlan and assign vlan5-7 as sub VLAN. Then setting subvlan-address-range at sub VLAN 5-7.

```
DGS6600:15 (config)#vlan 10
DGS6600:15 (config-vlan)#supervlan
DGS6600:15 (config-vlan)#subvlan 5-7
DGS6600:15 (config-vlan)#exit
DGS6600:15 (config)#interface vlan10
DGS6600:15 (config-if)#ip address 192.168.10.1/24
DGS6600:15 (config-if)#exit
DGS6600:15 (config)#vlan 5
DGS6600:15 (config-vlan)#subvlan-address-range 192.168.10.50 192.168.10.59
DGS6600:15 (config-vlan)#exit
DGS6600:15 (config)#vlan 6
DGS6600:15 (config-vlan)#subvlan-address-range 192.168.10.60 192.168.10.69
DGS6600:15 (config-vlan)#exit
DGS6600:15 (config)#vlan 7
DGS6600:15 (config-vlan)#subvlan-address-range 192.168.10.70 192.168.10.79
```

Setting Proxy ARP for a super VLAN interface

The sub VLANs can communicate with each other by enabling proxy ARP for the super VLAN interface. Proxy ARP function is disabled by default. To enable proxy ARP functions for a VLAN interface, execute the following commands.

```
DGS6600:15 (config)#enable
DGS6600:15 (config)#configure terminal
DGS6600:15 (config)#interface vlan10
DGS6600:15 (config-if)#ip address 192.168.10.1/24
DGS6600:15 (config-if)#ip proxy-arp
DGS6600:15 (config-if)#ip local-proxy-arp
```

Configuration Examples

Super VLAN Configuration Examples

Super VLAN 10 has two Sub VLAN 100 and 200. The clients in the IP range of Sub VLAN can communicate with each other but not if the IP is out of the range. e.g: PC1 and PC2 on Sub VLAN100 can communicate with PC3 which is on Sub VLAN200. But PC4 isn't in the IP range, and so, cannot communicate with other PCs.

Topology

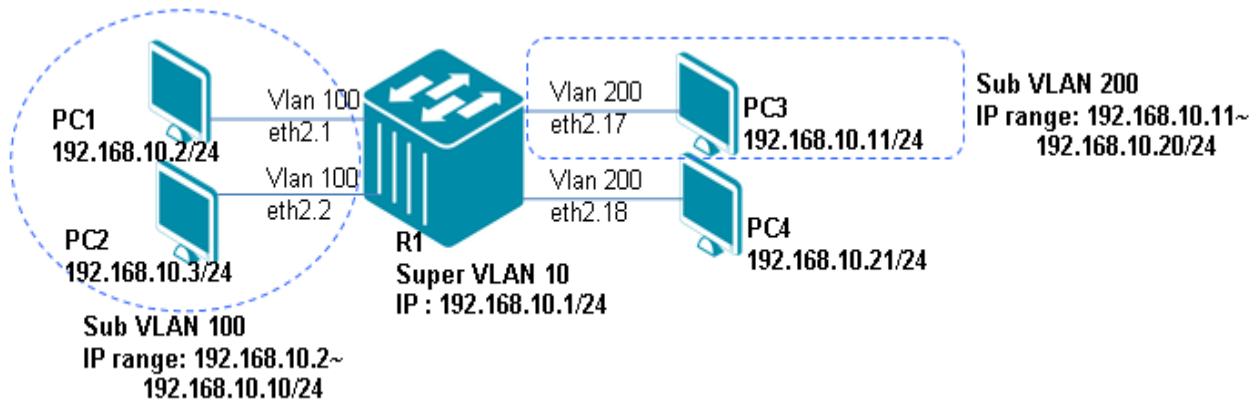

R1 (Router 1) Configuration Steps

Step 1. Set VLAN 10 with Super VLAN 10 and Sub VLAN 100 and 200

```
DGS6600:15(config)#vlan 10
DGS6600:15(config-vlan)#supervlan
DGS6600:15(config-vlan)#subvlan 100,200
DGS6600:15(config-vlan)#interface vlan10
DGS6600:15(config-if)#ip address 192.168.10.1/24
```

Step 2. Set Sub-VLAN with an IP range

```
DGS6600:15(config-if)#vlan 100
DGS6600:15(config-vlan)#subvlan-address-range 192.168.10.2 192.168.10.10
DGS6600:15(config-vlan)#vlan 200
DGS6600:15(config-vlan)#subvlan-address-range 192.168.10.11 192.168.10.20
```

Step 3. Enable proxy-arp with Super VLAN

```
DGS6600:15(config-vlan)#interface vlan10
DGS6600:15(config-if)#ip proxy-arp
DGS6600:15(config-if)#ip local-proxy-arp
```

Step 4. Assign member ports into VLAN

```
DGS6600:15(config-if)#interface range eth2.1-2.2
DGS6600:15(config-if)#access vlan 100
DGS6600:15(config-if)#interface range eth2.17-2.18
DGS6600:15(config-if)#access vlan 200
```

Verification

Use “show supervlan” command to check the configuration.

```
DGS6600:15#show supervlan
SuperVLAN ID  SubVLAN ID  SubVLAN IP Range
-----
10             100           192.168.10.2    - 192.168.10.10
              200           192.168.10.11  - 192.168.10.20
```

PC1 and PC2 should be able to ping each other, also PC1 and PC3 should be able to ping each other. This indicates the clients in the IP range of Sub VLAN can communicate with each other.

PC1 will not be able to ping PC4. PC3 will be unable to ping PC4. This indicates that the client, out of the IP range of Sub VLAN, cannot communicate.

List of Constraints & restrictions

1. A VLAN cannot be configured as a super VLAN if the VLAN has member ports.
2. The super VLAN cannot assign any physical member ports.
3. Default VLAN 1 cannot be a super VLAN.
4. A super VLAN cannot be a sub VLAN of other super VLANs.
5. A sub VLAN can only belong to one super VLAN, and cannot be assigned with an IP address.
6. A VLAN interface with IP address configuration cannot be configured as a sub VLAN.
7. Layer 3 route protocols, VRRP, multicast protocols and IPv6 protocol cannot run on a super VLAN interface.

List of Constants

Constant	Value
Super VLAN entries	4093
Sub-VLAN Entries	4094

Chapter 18

Voice VLAN

Chapter Overview

The following topics are included in this chapter, please go to the topic for more detailed information:

- [Chapter Overview](#)
- [An Introduction to Voice VLAN](#)
 - [Voice VLAN Notational information](#)
 - [Voice VLAN Process Voice Packets](#)
 - [Voice VLAN working with LLDP-MED](#)
- [Voice VLAN Configuration commands](#)
- [Configuration Examples](#)
 - [Voice VLAN Configuration Example](#)

An Introduction to Voice VLAN

Compared to data traffic, voice traffic must be given a higher transmission priority, because the sound quality of an IP phone call will be deteriorated if the voice traffic is unevenly sent. The quality of service (QoS) for voice traffic shall be configured to ensure the transmission priority of voice packet is higher than normal traffic.

Voice VLAN enables switch ports to carry voice traffic with a defined priority in order to enable the separation of voice and data traffic coming onto the port. A primary benefit of using Voice VLAN is to ensure that the sound quality of an IP phone is safeguarded from deteriorating when the data traffic on the port is high. The following figure illustrates an example of voice VLAN. Voice traffic is forwarded in voice VLAN and data traffic is forwarded in port-based VLAN (if no other kind of VLAN is applied).

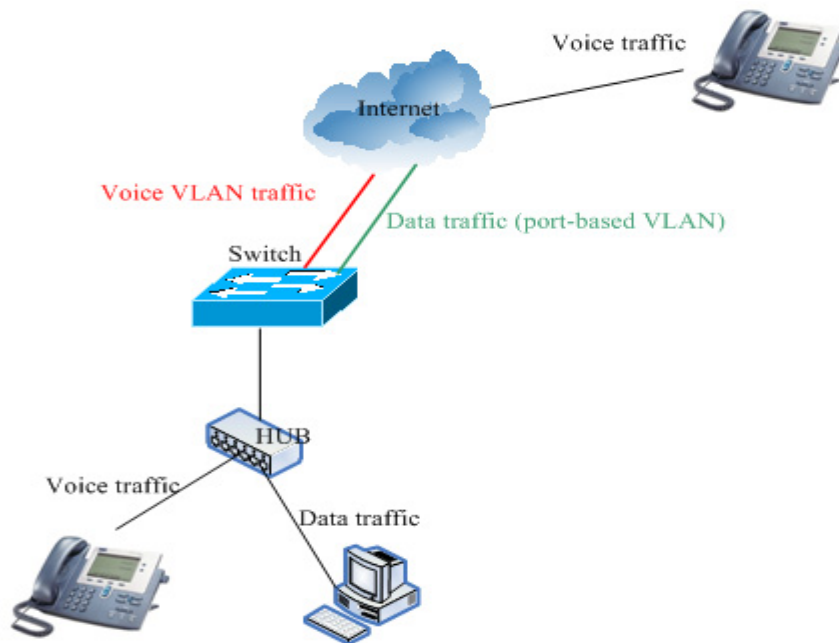

Voice VLAN Notational information

OUI (Organizationally Unique Identifier) — An OUI are the first 3 octets of a MAC address. The OUI of voice VLAN is used to identify the voice traffic. The following table shows the default IP phone vendors OUI: **Voice Device** — Like an IP phone, the voice device sends voice traffic.

OUI	Vendor
00:E0:BB	3COM
00:03:6B	Cisco
00:E0:75	Veritel
00:D0:1E	Pingtel
00:01:E3	Siemens
00:60:B9	NEC/ Philips
00:0F:E2	Huawei-3COM
00:09:6E	Avaya

Table 18-1 Default IP phone vendors OUI

Voice Packet — A packet is determined as voice packet if the source MAC addresses of packets comply with the IP phone vendors OUI.

Manual Mode — If a port works in manual mode, you should add the port to the voice VLAN or remove the port from the voice VLAN through manual configuration.

Voice VLAN Process Voice Packets

When voice VLAN is enabled in a switch, the switch will add a VLAN tag with the specified voice VLAN ID and the specified priority to the received untagged voice packets. The received packets are determined as voice packets if the source MAC addresses of packets comply with the organizationally unique identifier (OUI) addresses configured by the switch. The following figure 2 illustrates how to handle the received untagged and tagged voice packets.

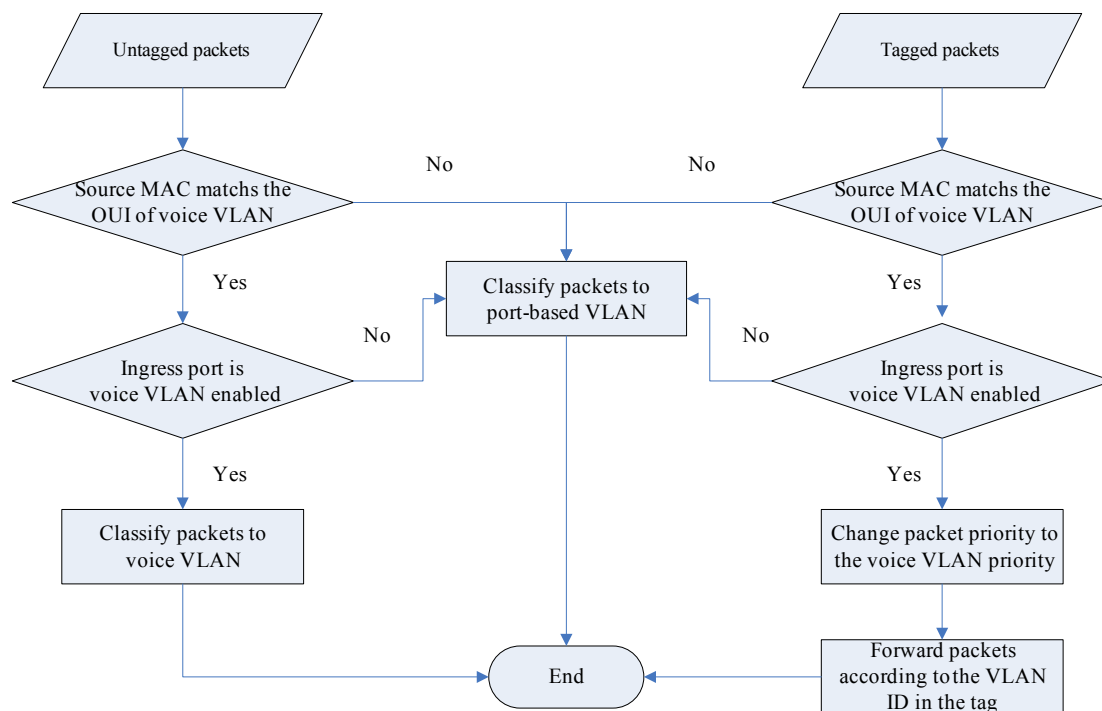

Figure 18-1 The process of ingress untagged and tagged voice packets

For the received tagged voice packets, they are forwarded within corresponding VLAN according to their VLAN ID in the tags. If the ingress port is voice VLAN enabled, and the incoming tagged voice packets pass the VLAN ingress rule, the packets priority will be changed to the voice VLAN priority. If the ingress port is voice VLAN disabled, just forward the packets as normal data packets.

Note:

To support more than 1024 voice devices, we use VFP (VLAN Filter Processor) to classify voice traffic to voice VLAN. For learning voice devices, we must copy the first voice packet to CPU to learn the voice device (saving voice device information). But, a large number of voice packets (come from different devices) will cause system abnormal. In the situation, the system doesn't learn the voice devices from software. We display voice devices by searching the FDB table (no start time information).

The maximum number of supported voice devices is based on the size of MAC Address Table.

Voice VLAN working with LLDP-MED

A voice device can also be detected through the LLDP-MED (Link Layer Discovery Protocol-Media Endpoint Discovery). If an LLDP-MED enabled port receives an LLDP-MED PDU, it can determine if the port is connected to a voice device. Those untagged packets coming from the voice device will then be forwarded to the voice VLAN. The following figure 3 illustrates the learning process of LLDP-MED voice devices.

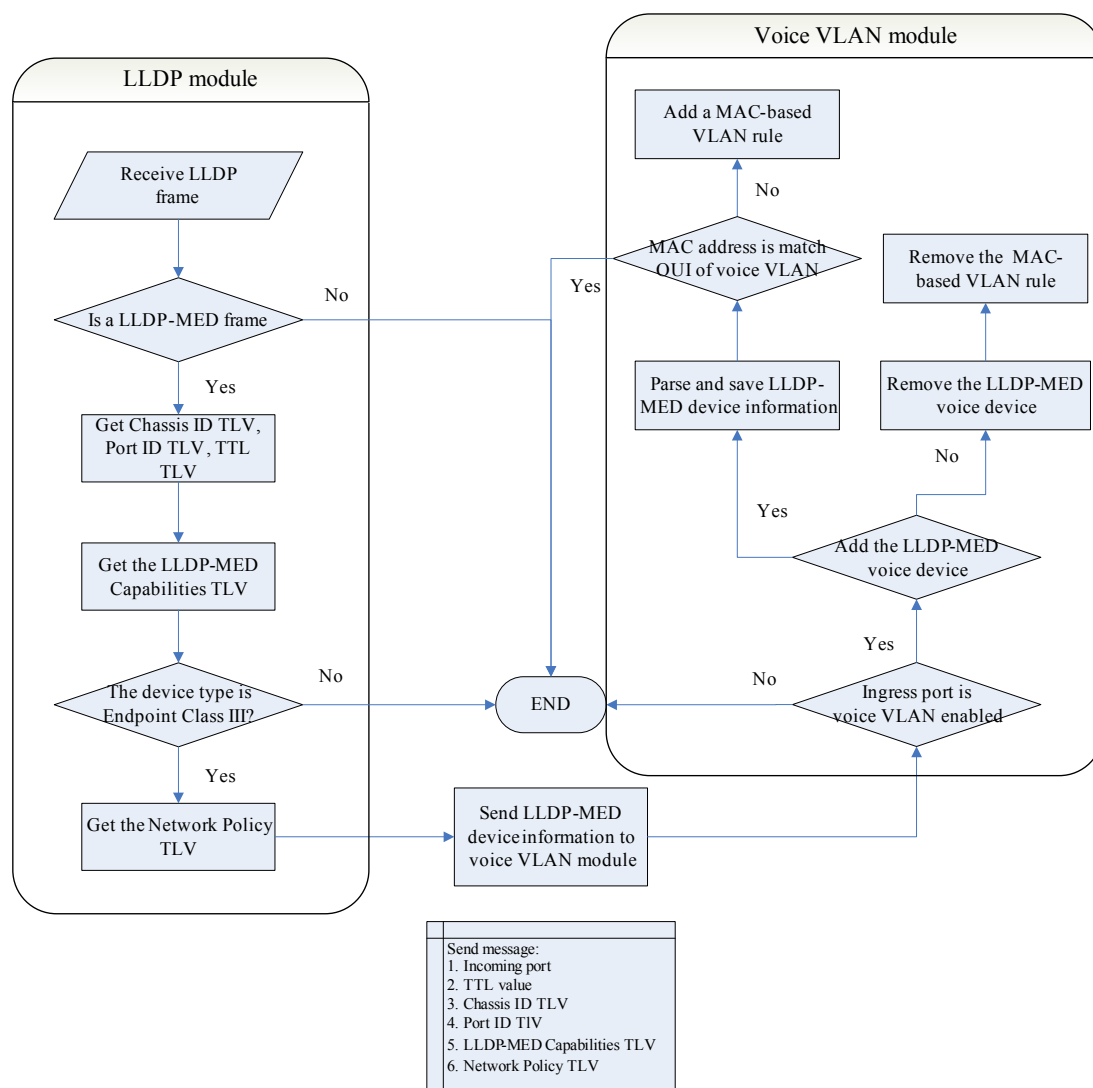

Figure 18-2 The learning process of LLDP-MED voice devices

The LLDP-MED Network Policy TLV is a fixed length TLV that allows Network Connectivity Devices and Endpoint Devices to advertise the specific port’s VLAN type, VLAN identifier (VID), and both the Layer 2 and Layer 3 priorities associated with a specific set of application types. The following Figure 4 shows the format of this TLV.

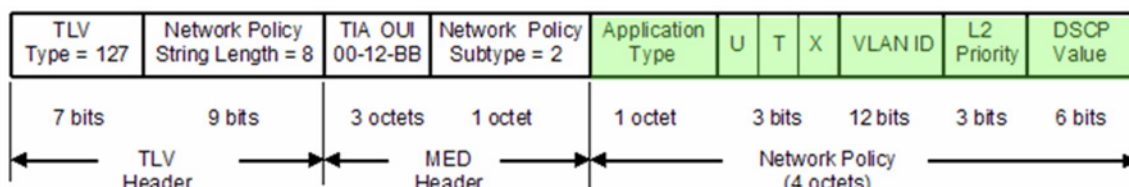

Figure 18-3 LLDP-MED Network Policy TLV format

Note:

- If the value of Tagged Flag (T) is 1, the voice device is using the IEEE 802.1Q tagged frame format.

- If the VLAN ID is not zero and it doesn't equal to voice VLAN ID, the system doesn't learn the LLDP-MED voice device and its packets will be forwarded according 802.1Q VLAN classification.
- If the LLDP-MED voice device's MAC address matches the OUI of voice VLAN, the system doesn't add the MAC-based VLAN rule for the discovered LLDP-MED voice device.

Voice VLAN Configuration commands

Please note that a full listing of the CLI commands can be found in the CLI Manual, however, below are a brief table of the commands summarized in a table format for guidance.

Command	Explanation
voice-vlan <i>VLAN-ID</i>	This command is used to enable the global voice VLAN function and to specify the voice VLAN on a switch. The switch has only one voice VLAN. Use no form of this command to disable the voice VLAN function.
voice-vlan cos <i>COS-VALUE</i>	The voice VLAN priority will be the priority associated with the voice VLAN traffic to distinguish the QoS of the voice traffic from data traffic.
voice-vlan oui <i>MAC-ADDRESS MASK</i> [description <i>TEXT</i>]	This command is used to add user defined OUI(s) for the voice VLAN. The OUI of voice VLAN is used to identify the voice traffic if voice VLAN is enabled. If the source MAC addresses of received packets comply with the configured OUI addresses, the received packets are determined as voice packets.
switchport voice-vlan state { enable disable }	This command is used to enable/disable the voice VLAN function on ports. The command is only available for physical port and port-channel interface configurations.
show vlan voice-vlan [oui interface <i>INTERFACE-ID</i> [, -]]	These commands are used to display voice VLAN configurations and information of learned, other, voice devices.
show vlan voice-vlan [lldp-med] device [interface <i>INTERFACE-ID</i> [, -]]	

Table 18-2 Configuration Commands and Explanations

The following example shows how to enable the voice VLAN function and configure VLAN 1000 as a voice VLAN.

```
DGS6600 (config)#voice-vlan 1000
DGS6600 (config)#end
DGS6600#
```

The example shows how to configure the priority of the voice VLAN to be seven.

```
DGS6600 (config)#voice-vlan cos 7
DGS6600 (config)#end
DGS6600#
```

This example shows how to enable voice VLAN function on physical port eth3.1.

```
DGS6600 (config)#interface eth3.1
DGS6600 (config-if)#switchport voice-vlan state enable
DGS6600 (config-if)#end
DGS6600#
```

This example shows how to add a user defined OUI of voice device.

```
DGS6600 (config)#voice-vlan oui 01-02-03-04-05-06 ff-ff-ff-ff-ff-ff
DGS6600 (config)#end
DGS6600#
```

This example displays the voice VLAN global settings.

```
DGS6600#show vlan voice-vlan
Voice VLAN Status      : Enabled
Voice VLAN ID         : 1000
CoS Priority           : 7
Aging time            : 60 minutes
Member ports          : eth3.1-3.5
Dynamic member ports  : eth3.4
DGS6600#
```

This example displays the OUI information of voice VLAN.

```
DGS6600#show vlan voice-vlan oui

OUI                Address Mask      Description
-----
00-01-e3-00-00-00  ff-ff-ff-00-00-00 Siemens
00-03-6b-00-00-00  ff-ff-ff-00-00-00 Cisco
00-09-6e-00-00-00  ff-ff-ff-00-00-00 Avaya
00-0f-e2-00-00-00  ff-ff-ff-00-00-00 Huawei&3COM
00-60-b9-00-00-00  ff-ff-ff-00-00-00 NEC&Philips
00-d0-1e-00-00-00  ff-ff-ff-00-00-00 Pingtel
00-e0-75-00-00-00  ff-ff-ff-00-00-00 Veritel
00-e0-bb-00-00-00  ff-ff-ff-00-00-00 3COM
01-02-03-04-05-06  ff-ff-ff-ff-ff-ff UserDefined

Total Entries: 9
DGS6600#
```

Configuration Examples

Voice VLAN Configuration Example

In the following example, VLAN2 is a voice VLAN. R1 ports eth2.1-2.5 are the voice VLAN enabled ports. The COS priority of voice VLAN is 5, and new added OUI (in additional to built-in) is 00-11-22.

When a VoIP device connects to R1 any port in eth2.1-2.4, R1 will check whether the packet belong to voice VLAN OUI. If it does, the packet will be classified as VLAN2 packets, and tagged as VLAN2. If not, the packet will be forwarded in regular port-based VLAN3.

Topology

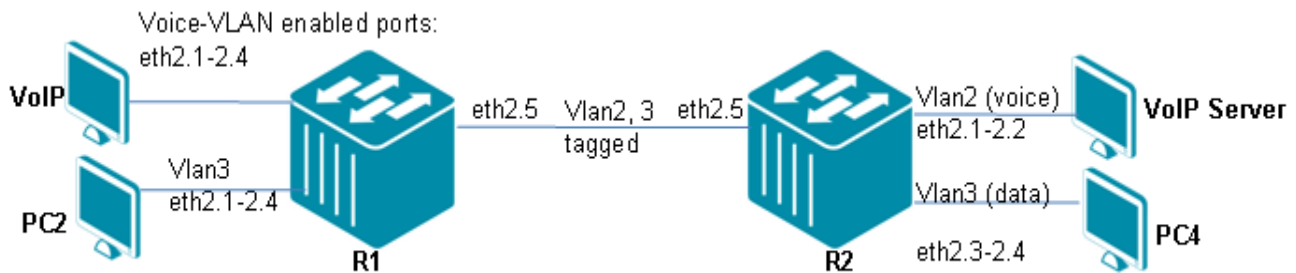

Figure 18-4 Voice Vlan Configuration Topology

R1 (Router 1) Configuration Steps

Step1: Create VLAN 2 and VLAN 3

```
DGS-6600:15(config)#vlan 2
DGS-6600:15(config-vlan)#vlan 3
```

Step2: Assign port to vlan, VoIP client port need to disable ingress-checking

```
DGS-6600:15(config-vlan)#interface range eth2.1-2.4
DGS-6600:15(config-if)# no ingress-checking
DGS-6600:15(config-if)#access vlan 3
DGS-6600:15(config-if)#interface eth2.5
DGS-6600:15(config-if)#trunk allowed-vlan 2-3
```

Step3: Configure voice VLAN OUI, voice VLAN ID, and voice VLAN enabled ports.

```
DGS-6600:15(config)#voice-vlan oui 00-11-22-00-00-00 ff-ff-ff-00-00-00
DGS-6600:15(config)#voice-vlan 2
DGS-6600:15(config)#interface range eth2.1-2.5
DGS-6600:15(config-if)#switchport voice-vlan state enable
```

R2 (Router 2) Configuration Steps

Step 1: Create VLAN 2 for voice and VLAN3 for "data"

```
DGS-6600:15(config)#vlan 2
DGS-6600:15(config-vlan)#vlan 3
```

Step 2: Add port into VLANs

```
DGS-6600:15(config-vlan)#interface range eth2.1-2.2
DGS-6600:15(config-if)# access vlan 2
DGS-6600:15(config-if)#interface range eth2.3-2.4
DGS-6600:15(config-if)# access vlan 3
DGS-6600:15(config-if)#interface eth2.5
DGS-6600:15(config-if)# trunk allowed-vlan 2
DGS-6600:15(config-if)# trunk allowed-vlan 3
```

Verifying the Configuration

Step 1: Check the Voice VLAN configuration in R1.

```
DGS-6600:15#show vlan voice-vlan
```

```
Voice VLAN Status      : Enabled
Voice VLAN ID          : 2
CoS Priority            : 5
Aging time              : 60 minutes
Member ports           : eth2.5
Dynamic member ports   : None
```

```
DGS-6600:15#show vlan voice-vlan oui
```

OUI Address	Mask	Description
00-01-e3-00-00-00	ff-ff-ff-00-00-00	Siemens
00-03-6b-00-00-00	ff-ff-ff-00-00-00	Cisco
00-09-6e-00-00-00	ff-ff-ff-00-00-00	Avaya
00-0f-e2-00-00-00	ff-ff-ff-00-00-00	Huawei&3COM
00-11-22-00-00-00	ff-ff-ff-00-00-00	
00-60-b9-00-00-00	ff-ff-ff-00-00-00	NEC&Philips
00-d0-1e-00-00-00	ff-ff-ff-00-00-00	Pingtel
00-e0-75-00-00-00	ff-ff-ff-00-00-00	Veritel
00-e0-bb-00-00-00	ff-ff-ff-00-00-00	3COM

Step 2: Insert a VOIP device having OUI=00-11-22 to check whether packet from this device can be sent to VOIP server in R2 VLAN2. We can use Ping to test. VoIP client can ping VOIP Server.

Step 3: Insert a PC, whose OUI is not in the list. The PC packet will be sent in VLAN3. We can use ping to test. PC2 can ping PC4.

Chapter 19

Ethernet Ring Protection Switching (ERPS)

Chapter Overview

The following topics are included in this chapter, please go to the topic for more detailed information:

- [Chapter Overview](#)
 - [An Introduction to ERPS](#)
 - [Multiple Ethernet Ring Topology](#)
 - [Multiple ERP instances](#)
 - [Multi-Ring/ladder network](#)
 - [Topology Change Propagation](#)
- [Configuration Example](#)
 - [ERPS Configuration Example](#)
- [Relationship with other modules](#)
 - [Link Monitor module](#)
 - [FDB module](#)
 - [VLAN module](#)
 - [Spanning Tree module](#)
 - [LoopBack Detection \(LBD\) module](#)
 - [LACP module](#)
 - [Multicast Filter Mode](#)
 - [Port Security module](#)
 - [802.1x module](#)
 - [Traffic Segmentation module](#)

An Introduction to ERPS

ERPS is designed for loop avoidance of ring topology and replacing the other loop protection protocol, such as STP (Spanning-Tree Protocol), and it has lower convergence time than other protocols.

To achieve fault-tolerance requirement of carrier-grade networks, ERPS provides faster protection switching performance that the switch completion time for link failure shall be less than 50 ms.

An **Ethernet ring** or **ERP instance**, depicted in the diagram below, is a collection of **ring nodes** forming a closed loop whereby each ring node is connected to two adjacent ring nodes via **ring links** which are bounded by **ring ports**. For each ERP instance, it has one identifier, called **Ring-ID** or instance-id, and **Node ID** of each ring node is its MAC Address.

For each ERP instance, there are two traffic channels, **R-APS** (Ring-Automatic Protection Switching) **controlled channel** and **service protected channel**. R-APS controlled channel is used to transmit and receive R-APS messages which belong to certain VLAN, called **R-APS controlled**

VLAN. And, service protected channel is used to transmit and receive service traffic which belong to multiple VLANs, called **service protected VLANs**.

In order to avoid traffic looping in normal idle state, previous two traffic channels at one of the ring links, **ring protection link (RPL)**, are blocked. The responsibility for setting blocking state of RPL belongs to two ring nodes of each ERP instance, one is called **RPL owner**.

Blocking previous two traffic channels of each ERP instance shall only block or unblock the set of VLANs which include R-APS controlled VLAN and service protected VLANs. But, blocking R-APS controlled channel only prevents R-APS messages received from one ring port being forwarded to the other ring port, and transmits and receives R-APS messages are allowed.

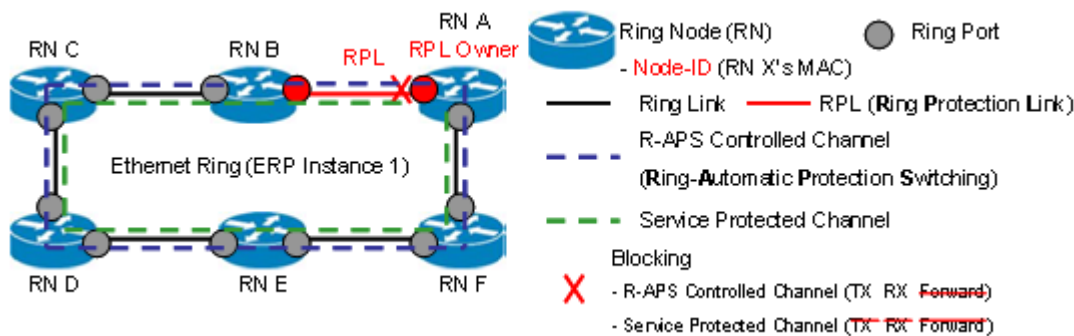

Figure 19-1

The brief ring state transition of each ERP instance is depicted below.

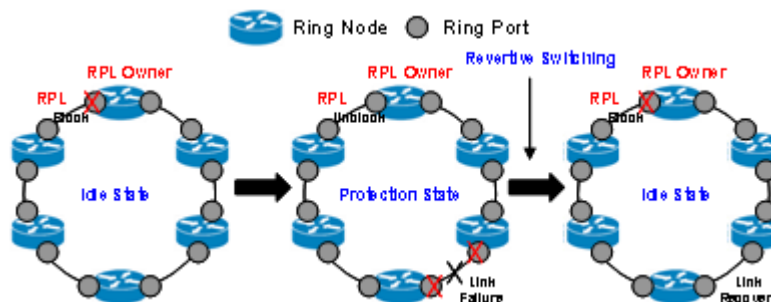

Figure 19-2

The ERP instance is in "Idle" state and RPL between ring node A and B (RPL owner and RPL neighbor) is blocked when no detected link failure events.

When link failure occurs at ring link between ring node D and E, the ring nodes which detect the link failure event blocks the failed ring port and sends a "R-APS (SF)" (SF, Signal Fail) messages to inform other ring nodes this event. When RPL owner and RPL neighbor receive R-APS (SF) messages, they unblock the RPL to keep connectivity of the Ethernet ring and ERP instance enters "Protection" state.

When previous failed link has been recovered, the ring nodes which detect the link recovery event send "R-APS (NR)" (NR, No Request) messages to inform other ring nodes this event. When RPL owner receives R-APS (NR) messages, it starts the timer in order to await the required stability of recovered link.

When previous timer expires, RPL owner blocks RPL and sends "R-APS (NR, RB)" (RB, RPL Blocked) messages to inform other ring nodes that RPL has blocked. When other ring nodes receive

R-APS (NR, RB) messages, RPL neighbor blocks RPL and others unblock blocked ports, and ERP instance returns to "Idle" state.

Multiple Ethernet Ring Topology

When the ring nodes grow gradually in single Ethernet ring, this large ring may be broken and causes traffic segmentation. For the single ring topology which is depicted in the diagrams below, if there are two or more links between ring nodes have occurred link failure, the single ring will not keep connectivity between all ring nodes.

In order to provide scalability and reliability, large single ring will be divided to multiple rings which are interconnected. For the multiple rings topology which is depicted below, even if two links have occurred link failure, all ring nodes will still keep connectivity by using common link.

The multiple rings topology with ERPS can be classified two types, "Multiple ERP Instances" and "Multi-Ring/ladder network". These two types are described on next two sections. The maximum created ERP instances on the device should depend on project definition.

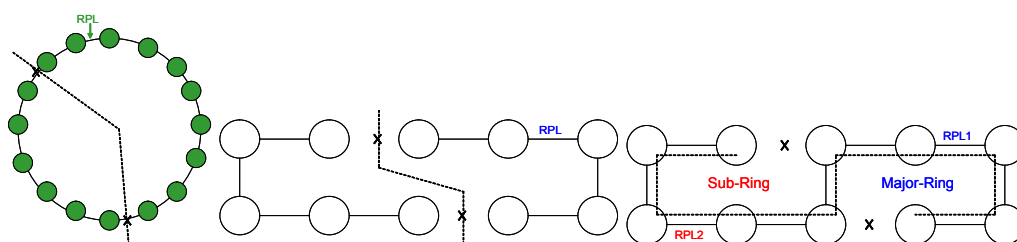

Multiple ERP instances

An Ethernet ring topology may have multiple traffic channels which are grouped into different sets of VLANs. In order to protect these traffic channels, multiple ERP instances are defined and each ERP instance is responsible with one service protected channel and has its own following features.

Instance-ID (Ring-ID)

RPL Owner/Neighbour Node and RPL

R-APS controlled channel and service protected channel

ERP Control Process

And, the link failure and recovery events for each ERP instance are independent.

Topology of multiple ERP instances is depicted below. There are two ERP instances that have its own RPL (RPL1 and RPL2) and are used to avoid loop of its own service protected channels (blue and red channels). For the interconnection nodes, it shall create two ERP instances.

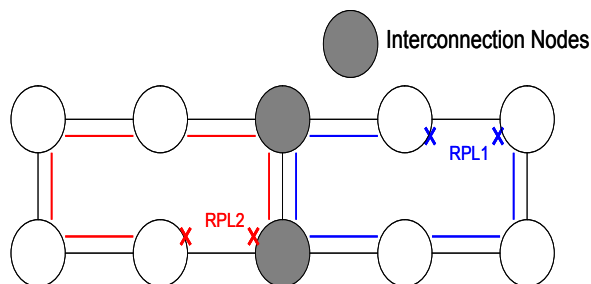

For the following diagrams, two or more ERP instances have the same service protected channel (blue channel). It may cause a super loop when the shared link failure and two EPR instances block this link and unblock RPL simultaneously.

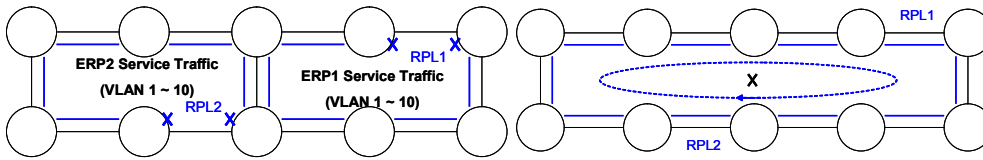

Multi-Ring/ladder network

For the multiple rings topology of ERPS, one ERP instance ("Major-Ring" or "Parent-Ring") is connected with two or more instances ("Sub-Rings" or "Child-Ring") is called "Multi-Ring/ladder network". Topology of multi-ring is depicted below, major-ring and sub-ring are connected through two "Interconnection Nodes (Share Nodes)".

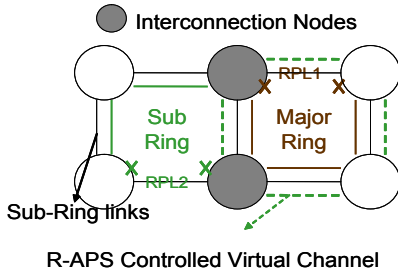

But, the shared link between interconnection nodes is only controlled (block/unblock) by major-ring in order to prevent loop when this link fails. The diagram below depicts the relation of service protected channel for major-ring and sub-ring, and they may the same exactly or overlap each other.

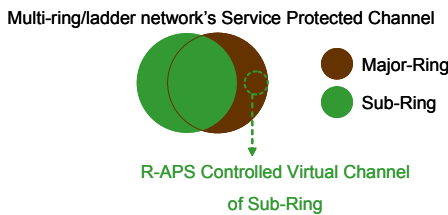

"R-APS controlled virtual channel" is the "R-APS controlled channel" connection between two interconnection nodes of a sub-ring and also be treated as "service traffic" of major-ring. It is used to provide connectivity between two interconnection nodes and always be enabled.

For the sub-ring with R-APS controlled virtual channel, the VLAN-ID of R-APS virtual channel always equal with VLAN-ID of R-APS controlled channel.

Topology Change Propagation

Sub-ring of multi-ring topology shall issue the topology change event to "Parent-Ring" (major-ring or sub-ring) in the interconnection node when performing flush FDB action. This process is called "Topology Change (TC) Propagation" which is depicted below and following description are steps.

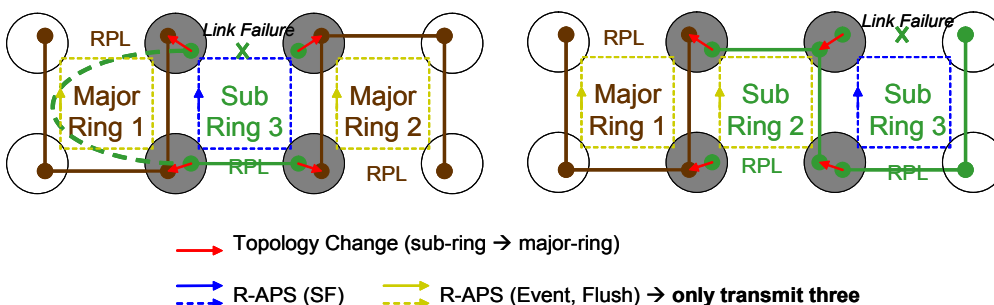

- Sub-ring detects link failure event and performs flush FDB and issues TC event.
- Parent-ring which receives TC event checks if state of TC for sub-ring is enabled? (Default: disabled)
- If state is enabled, parent-ring performs flush FDB action and sends R-APS (Event, Flush) messages to inform other ring nodes this TC event.
- Ring nodes which receive R-APS (Event, Flush) message perform flush FDB action.

The TC event of step1 and "flush FDB" signal of step4 will be disabled after 10ms. This is used to prevent performing multiple times of flush FDB action.

Configuration Example

ERPS Configuration Example

R1, R2 and R3 run ERPS. R1 is the RPL owner. R1 port eth2.5 will be blocked to prevent loop. When any of links (e.g., eth2.6 between R2, R3) in the ring is down, the blocked port will become active within 50ms.

Topology

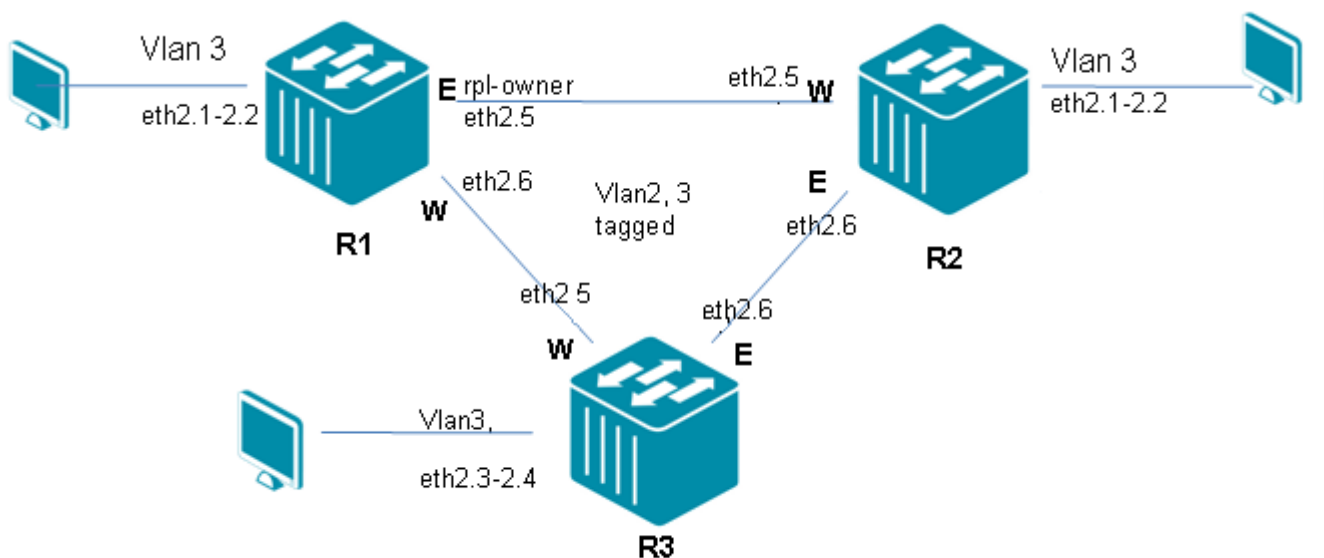

Figure 19-3 ERPS Configuration Topology

R1 (Router 1) Configuration Steps

Step 1: Create VLAN 2, 3

```
DGS-6600:15 (config)#vlan 2
DGS-6600:15 (config-vlan)#vlan 3
```

Step 2: Add port into vlan

```
DGS-6600:15(config-vlan)#interface range eth2.1-2.2
DGS-6600:15(config-if)# access vlan 3
DGS-6600:15(config-if)#interface range eth2.5-2.6
DGS-6600:15(config-if)# trunk allowed-vlan 2-3
```

Step 3: Enable and configure ERPS.

```
DGS-6600:15(config-if)#erps
DGS-6600:15(config)#erps domain erps
DGS-6600:15(config-erps-domain)# erpi 1 type major
DGS-6600:15(config-erps-domain)# erpi 1 raps-vlan 2
DGS-6600:15(config-erps-domain)# erpi 1 ring-port east eth2.5
DGS-6600:15(config-erps-domain)# erpi 1 ring-port west eth2.6
DGS-6600:15(config-erps-domain)# erpi 1 rpl owner rpl-port east
DGS-6600:15(config-erps-domain)# erpi 1 protected-vlan 3
DGS-6600:15(config-erps-domain)# erpi 1 enable
```

R2 (Router 2) Configuration Steps**Step 1: Create VLAN 2, 3**

```
DGS-6600:15(config)#vlan 2
DGS-6600:15(config-vlan)#vlan 3
```

Step 2: Add port into VLAN.

```
DGS-6600:15(config-vlan)#interface range eth2.1-2.2
DGS-6600:15(config-if)# access vlan 3
DGS-6600:15(config-if)#interface range eth2.5-2.6
DGS-6600:15(config-if)# trunk allowed-vlan 2-3
```

Step 3: Enable and configure ERPS.

```
DGS-6600:15(config-if)#erps
DGS-6600:15(config)#erps domain erps
DGS-6600:15(config-erps-domain)# erpi 1 type major
DGS-6600:15(config-erps-domain)# erpi 1 raps-vlan 2
DGS-6600:15(config-erps-domain)# erpi 1 ring-port west eth2.5
DGS-6600:15(config-erps-domain)# erpi 1 ring-port east eth2.6
DGS-6600:15(config-erps-domain)# erpi 1 protected-vlan 3
DGS-6600:15(config-erps-domain)# erpi 1 enable
```

R3 (Router 3) Configuration Steps

Step 1: Create VLAN 2, 3

```
DGS-6600:15(config)#vlan 2
DGS-6600:15(config-vlan)#vlan 3
```

Step 2: Add port into VLAN.

```
DGS-6600:15(config-if)#interface range eth2.3-2.4
DGS-6600:15(config-if)# access vlan 3
DGS-6600:15(config-if)#interface range eth2.5-2.6
DGS-6600:15(config-if)# trunk allowed-vlan 2-3
```

Step 3: Enable and configure ERPS.

```
DGS-6600:15(config-if)#erps
DGS-6600:15(config)#erps domain erps
DGS-6600:15(config-erps-domain)# erpi 1 type major
DGS-6600:15(config-erps-domain)# erpi 1 raps-vlan 2
DGS-6600:15(config-erps-domain)# erpi 1 ring-port west eth2.5
DGS-6600:15(config-erps-domain)# erpi 1 ring-port east eth2.6
DGS-6600:15(config-erps-domain)# erpi 1 protected-vlan 3
DGS-6600:15(config-erps-domain)# erpi 1 enable
```

Verifying The Configuration

Step 1: Use the following command to check each DUT ERPS configuration R1.

```
DGS-6600:15#show erps erpi

ERPS global state : Enabled

ERP instance #1
-----
Domain name : erps
Instance type : Major
Instance state : Enabled
Instance status : Idle
R-APS controlled VLAN : 2
Ring MEL : 1
East ring port : eth2.5
East ring port state : Blocked
West ring port : eth2.6
West ring port state : Forwarding
RPL owner port : East
Service protected VLANs : 3
Guard timer : 500 milliseconds
Hold-Off timer : 0 milliseconds
WTR timer : 5 minutes

Total ERP instances : 1

DGS-6600:15#show erps domain

Domain                                ERPI Type  Status      Port-State
                                ID
-----
erps                                  1   Major Idle      East:Blocked
                                         West:Forwarding

Total ERPS domains : 1
Total ERP instances : 1
```

Step 2: Use the following command to check each DUT ERPS configuration R2.

```
DGS-6600:15#show erps erpi

ERPS global state : Enabled

ERP instance #1
-----
Domain name : erps
Instance type : Major
Instance state : Enabled
Instance status : Idle
R-APS controlled VLAN : 2
Ring MEL : 1
East ring port : eth2.6
East ring port state : Forwarding
West ring port : eth2.5
West ring port state : Forwarding
RPL owner port : (Not-configured)
Service protected VLANs : 3
Guard timer : 500 milliseconds
Hold-Off timer : 0 milliseconds
WTR timer : 5 minutes

Total ERP instances : 1

DGS-6600:15#show erps domain

Domain                ERPI Type  Status      Port-State
                    ID
-----
erps                  1    Major Idle      East:Forwarding
                                         West:Forwarding

Total ERPS domains : 1
Total ERP instances : 1
```

Step 3: Use the following command to check each DUT ERPS configuration R3.

```
DGS-6600:15#show erps erpi

ERPS global state : Enabled

ERP instance #1
-----
Domain name : erps
Instance type : Major
Instance state : Enabled
Instance status : Idle
R-APS controlled VLAN : 2
Ring MEL : 1
East ring port : eth2.6
East ring port state : Forwarding
West ring port : eth2.5
West ring port state : Forwarding
RPL owner port : (Not-configured)
Service protected VLANs : 3
Guard timer : 500 milliseconds
Hold-Off timer : 0 milliseconds
WTR timer : 5 minutes

Total ERP instances : 1

DGS-6600:15#show erps domain

Domain                ERPI Type  Status      Port-State
                    ID
-----
erps                   1   Major Idle      East:Forwarding
                               West:Forwarding

Total ERPS domains : 1
Total ERP instances : 1
```

The same VLAN PC can ping each other.

Unplug any link in the ring, for example, eth2.6 between R2 and R3, the original ERPS block port will become the forwarding within 50ms.

Relationship with other modules

Link Monitor module

Each ERP instance should be registered on link monitor module, and the link monitor module will notify ERPS when the link failure or recovery event on ring ports is detected. Under this design specification for ERPS, the event may be notified from "Link Change (link-up or link-down)".

FDB module

When the ERP instance changes its topology, it will perform flush FDB action on ring ports.

VLAN module

Each ERP instance creates one dedicated R-APS controlled VLAN for transmitting R-APS messages. User must create this VLAN by VLAN commands, and then configure this VLAN as R-APS controlled VLAN.

ERP instance will be running in a "not-operational" state due to several non-consistent configurations. For example, the R-APS controlled VLAN is not created or the ring ports are not the tagged members of R-APS controlled VLAN. If a user removes the ring port from R-APS controlled VLAN or configures ring ports to untagged port members when ERP instances are enabled, the instance will be changed to "not-operational" state, and traffic on the ring is not protected until the configuration has been recovered.

Spanning Tree module

When the ERP instance is enabled on ring ports, the STP function can not be enabled on both ring ports, and the STP BPDU can not be forwarded by the ring ports.

LoopBack Detection (LBD) module

When the ERP instance is enabled on ring ports, the LBD function can not be enabled on both ring ports, but if these ring ports are blocked by LBD function, it may affect traffic of the ERP instance.

LACP module

The link aggregation group can be configured as one ring port of ring node. And, this link aggregation group will run the ERPS function as an individual interface such as physical port.

Member port of link aggregation group can not be configured as one ring port of ring node.

After the physical port has been configured as one ring port of ring node, if this port is added to link aggregation group, it will be removed from ring node. And, administrator may configure link aggregation group as ring port of ring node.

Multicast Filter Mode

The R-APS message will be treated as multicast packets, and if the multicast filter mode of R-APS controlled VLAN or ring ports is "**filter unregistered groups**", the R-APS message will be filtered and dropped. But, as the R-APS messages are protocol packets for ERPS protocol, and "filter unregistered groups" mode is used to filter unregistered multicast data. So, it is suggested that the multicast filter mode of R-APS controlled VLAN or ring ports should not be configured as "filter unregistered groups".

Port Security module

When the ERP instance is enabled on ring ports, the "Port Security" function can be enabled on both ring ports, but if these ring ports are blocked by "Port Security" module, it may affect service traffic of the ERP instance.

802.1x module

When the ERP instance is enabled on ring ports, the "802.1x" function can be enabled on both ring ports, but if these ring ports are blocked by "802.1x" module, it may affect service traffic of the ERP instance.

Traffic Segmentation module

Traffic segmentation function may affect forwarding of R-APS messages over R-APS controlled channel if the forwarded ring port is not forwarding interface of received ring port.



Part 4- Layer 3 Configurations

The following chapters are included in this volume:

- **IPv4 Basics**
- **IPv4 Static Route Configuration**
- **Routing Information Protocol (RIP)**
- **Open Shortest Path First (OSPF)**
- **IPv6 Basics**
- **IPv6 Static Route Configuration**
- **Routing Information Protocol Next Generation (RIPng)**
- **Open Shortest Path First Version 3 (OSPFv3)**
- **ECMP**
- **IPv6 Tunneling**
- **Border Gateway Protocol (BGP)**
- **Policy Based Route Map (PBR)**
- **Virtual Router Redundancy Protocol (VRRP)**

Chapter 20

IPv4 Basics

Chapter Overview

The following topics are included in this chapter, please go to the topic for more detailed information:

- [Chapter Overview](#)
 - [An Introduction to IPv4](#)
 - [IPv4 Basics](#)
 - [Subnet Masks](#)
 - [IPv4 Address Assignment on the DGS-6600 Series Switch](#)
- [IPv4 Basic Configuration Commands](#)
 - [IP Address](#)
 - [ARP](#)
- [Configuration Example](#)
 - [Basic Routing \(IPV4\) Configuration Example](#)

An Introduction to IPv4

This Chapter introduces you to the basics of IP addressing and explains how to use the DGS-6000 switch to implement an IP addressing plan for your network. An IP address uniquely identifies a device on an IP network. Allocating, recycling, and documenting IP addresses and subnets in a network can get confusing very quickly if you have not laid out an IP addressing plan. A sound plan will help you prepare the network foundation to support additional services such as unified communications, wireless access, and enhanced network security.

IPv4 Basics

IP addressing is core to the design of a network and the functionality of the DGS-6600 Switch; it provides the base for all other network and user services on the DGS-6600 switch. IP version 4 (IPv4) addresses, are addresses which uniquely identify a device on an IP network. IPv4 addresses are 32 bits in length and are typically communicated across the network in a format referred to as dotted decimal.

- The 32 binary bits are:
 - Divided into a network and host portions
 - Placed into four octets of 8 bits.
 - Each octet can be converted to binary.

Consider this IP address, which is presented in dotted decimal: 10.83.33.1.

The address breaks down into the following octets: 10, 83, 33, 1

The value in each octet ranges from 0 to 255 decimal, or 00000000– 11111111 binary. In binary, the address 10.83.33.1 is represented as: 00001010 01010011 00100001 00000001

IP addresses are split up into several different categories, including Class A, Class B and Class C. Address classes are defined, in part, on the number of bits that make up the network portion of the address, and on how many are left for the definition of individual host addresses.

In Class A addresses, the first octet is the network portion.

In Class B, the first two octets are the network portion.

In Class C, the first 3 octets are the network portion

Subnet Masks

Subnets allows the creation of multiple logical networks existing within a single Class A, B, or C network. If subnets are not used, only one network from the Class A, B, or C network can be used, which is very limiting. Each link on a network must have a unique network address, with every host on that link being a member of the same network. If you break a major network (Class A, B, or C) into smaller subnet-works, you can create a network of interconnected subnet-works. Each link on this network would then have a unique network/subnet-work ID.

There are two ways to denote a subnet mask either by using:

- Three bits more than the originally specified mask. i.e. 255.255.255.0 becomes 255.255.255.224.
- Denoting the mask with a with the notation prefix/length. i.e. /27 as there are 27 bits that are set in the mask.

For example: 192.168.1.1/27 denotes the network 192.168.1.1 with a mask of 255.255.255.224.

IPv4 Address Assignment on the DGS-6600 Series Switch

On the DGS-6600 Switch, IPv4 can be assigned either manually or automatically. The automatic configuration of an IPv4 address can be either stateless or stateful. A stateless address refers to address configuration based on a prefix passed from the router. A stateful address is an address that is obtained from the DHCP server. This configuration chapter will focus only on stateless addresses.

In IPv4 a default router is normally manually configured. When configuring the DGS-6600, as a general rule, there is by default; no IP address defined for any interface. With no pre-defined IP interface the default is 0.0.0.0/32.

It is possible to use the IP address command, to set a primary or secondary IP address, but only for an interface, it is also possible to acquire an IP address on an interface from DHCP.

IPv4 Basic Configuration Commands

IP Address

Command	Explanation
<code>ip address {IP-ADDRESS SUBNET-MASK [secondary] dhcp}</code>	Use ip address to set a primary or secondary IP address for an interface, or acquire an IP address on an interface from DHCP. Use the no form of the command to remove the IP settings configuration from the interface.

This example shows how to set 10.108.1.27 as the primary address and 192.31.7.17 and 192.31.8.17 as the secondary addresses for VLAN 100.

```
DGS6600:15#configure terminal
DGS6600:15(config)#interface vlan100
DGS6600:15(config-if)#ip address 10.108.1.27 255.255.255.0
DGS6600:15(config-if)#ip address 192.31.7.17 255.255.255.0 secondary
DGS6600:15(config-if)#ip address 192.31.8.17 255.255.255.0 secondary
DGS6600:15(config)#end
```

ARP

Command	Explanation
<code>arp IP-ADDRESS HARDWARE-ADDRESS</code>	Use this command to add a static entry in the Address Resolution Protocol (ARP) cache. Use the no arp command to remove a static entry in the ARP cache.

This example shows how to add static ARP entry for a typical Ethernet host:

```
DGS6600:15(config)#arp 10.31.7.19 0800.0900.1834
```

Command	Explanation
<code>arp timeout SECONDS</code>	Use this command to add to the ARP table and to set the ARP aging time for the ARP table, use the arp timeout command.

This example shows how to sets the ARP timeout to 12000 seconds to allow entries to time out more quickly than the default setting:

```
DGS6600:15(config)#interface vlan1
DGS6600:15(config-if)#arp timeout 12000
```

Command	Explanation
<code>clear arp-cache [interface interface-ID IP-ADDRESS]</code>	To remove dynamically created entries from the Address Resolution Protocol (ARP) cache, use the clear arp-cache command in privileged EXEC mode.

This example shows how to removes all dynamic entries from the ARP cache.

```
DGS6600#clear arp-cache
```

Configuration Example

Basic Routing (IPv4) Configuration Example

PC1, PC2 and PC3 can communicate to each other by basic routing.

Topology

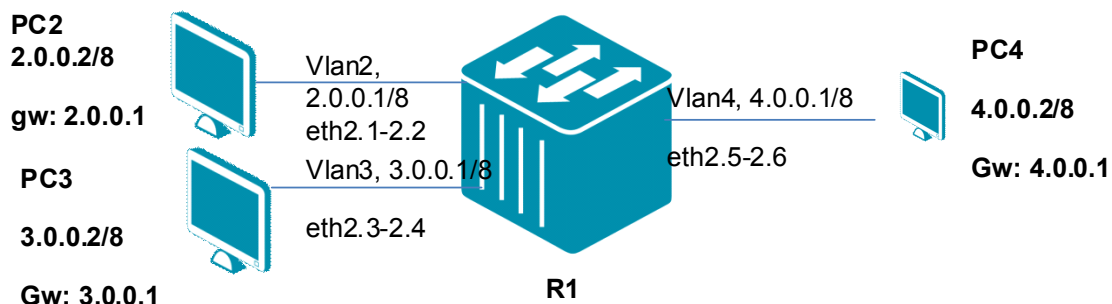

Figure 20-1 Basic Routing IPv4 Configuration Topology

R1 (Router 1) Configuration Steps

Step 1: Create vlan 2,3 and 4

```
DGS6600:15(config)#vlan 2
DGS6600:15(config-vlan)#vlan 3
DGS6600:15(config-vlan)#vlan 4
```

Step 2: Add port into vlan

```
DGS6600:15(config-vlan)#interface range eth2.1-2.2
DGS6600:15(config-if)# access vlan 2
DGS6600:15(config-if)#interface range eth2.3-2.4
DGS6600:15(config-if)# access vlan 3
DGS6600:15(config-if)#interface range eth2.5-2.6
DGS6600:15(config-if)# access vlan 4
```

Step 3: Configure IP address of vlan

```
DGS6600:15(config-if)#interface vlan2
DGS6600:15(config-if)# ip address 2.0.0.1/8
DGS6600:15(config-if)#interface vlan3
DGS6600:15(config-if)# ip address 3.0.0.1/8
DGS6600:15(config-if)#interface vlan4
DGS6600:15(config-if)# ip address 4.0.0.1/8
```

Verifying The Configuration

Step 1: Check R1 routing Configuration.

```
DGS6600:15#show ip route
Codes: K - kernel, C - connected, S - static, R - RIP, B - BGP
       O - OSPF, IA - OSPF inter area
       N1 - OSPF NSSA external type 1, N2 - OSPF NSSA external type 2
       E1 - OSPF external type 1, E2 - OSPF external type 2
       i - IS-IS, L1 - IS-IS level-1, L2 - IS-IS level-2, ia - IS-IS inter area
       # - A number of slots are inactive
       * - candidate default

C       2.0.0.0/8 is directly connected, vlan2
C       3.0.0.0/8 is directly connected, vlan3
C       4.0.0.0/8 is directly connected, vlan4
```

PCs in different subnets can ping each other by DGS-6600's routing.

Chapter 21

IPv4 Static Route Configuration

Chapter Overview

The following topics are included in this chapter, please go to the topic for more detailed information:

- [Chapter Overview](#)
- [An Introduction to IPv4 Static Routing](#)
- [IPv4 Static Routing Configuration Commands](#)
 - [Interface Range](#)
 - [IP Address](#)
 - [Access VLAN](#)
 - [Ip route](#)
 - [show ip route](#)
- [Configuration Example](#)
 - [Static Routing \(IPV4\) Configuration Example](#)

An Introduction to IPv4 Static Routing

Internet Protocol addresses are leased to a host either anew at the time booting, or permanently by fixed configuration of it's hardware or software. Persistent configurations are known as static IP addresses.

IPv4 Static Routing Configuration Commands

Interface Range

Command	Explanation
<code>interface range</code> <i>INTERFACE-ID</i> [, -]	Enter the interface range command to go into interface range configuration mode. The command executed in this mode will be applied to all interfaces specified by the command.

This example shows how to enter the interface configuration mode for a range of ports from eth3.1-3.5.

```
DGS6600(config)# interface range eth3.1-3.5
DGS6600(config-if)#
```

IP Address

Command	Explanation
<code>ip address {IP-ADDRESS SUBNET-MASK [secondary] dhcp}</code>	Use ip address to set a primary or secondary IP address for an interface, or acquire an IP address on an interface from DHCP. Use the no form of the command to remove the IP settings configuration from the interface.

This example shows how to set 10.108.1.27 as the primary address and 192.31.7.17 and 192.31.8.17 as the secondary addresses for VLAN 100.

```
DGS6600#configure terminal
DGS6600(config)#interface vlan100
DGS6600(config-if)#ip address 10.108.1.27 255.255.255.0
DGS6600(config-if)#ip address 192.31.7.17 255.255.255.0 secondary
DGS6600(config-if)#ip address 192.31.8.17 255.255.255.0 secondary
DGS6600(config)#end
```

Access VLAN

Command	Explanation
<code>access vlan <i>VLAN-ID</i></code>	Use the access vlan interface configuration command to specify the access VLAN for the interface. Use default interface command to reset to default setting.

This example shows how to set an interface port 1.1 to an untagged member of VLAN 1000.

```
DGS6600(config)# interface eth1.1
DGS6600(config-if)# access vlan 1000
```

Ip route

Command	Explanation
<code>ip route {<i>NETWORK-PREFIX NETWORK-MASK</i> <i>NETWORK-PREFIX/PREFIX-LENGTH</i>} <i>IPADDRESS</i> [<i>distance DISTANCE</i>]</code>	Use ip route to add a static route entry. Use the no form of the command to remove a static route entry.

This example shows how to add static default route entry with next-hop 10.1.1.254.

```
DGS6600(config)#ip route 0.0.0.0/0 10.1.1.254
```

This example shows how to add a static route entry for a 20.0.0.0/8 with next-hop 10.1.1.254.

```
DGS6600(config)#ip route 20.0.0.0/8 10.1.1.254
```

show ip route

Command	Explanation
<code>show ip route [IP-ADDRESS [/MASK] [database] [PROTOCOL connected static]]</code>	Use ip route to add a static route entry. Use the no form of the command to remove a static route entry.

The following is sample output from the show ip route command when entered without an address.

```
DGS-6600:15#show ip route
Codes: K - kernel, C - connected, S - static, R - RIP, B - BGP
       O - OSPF, IA - OSPF inter area
       N1 - OSPF NSSA external type 1, N2 - OSPF NSSA external type 2
       E1 - OSPF external type 1, E2 - OSPF external type 2
       i - IS-IS, L1 - IS-IS level-1, L2 - IS-IS level-2, ia - IS-IS inter area
       # - A number of slots are inactive
       * - candidate default

C       2.0.0.0/8 is directly connected, vlan2
C       4.0.0.0/8 is directly connected, vlan4
S       5.0.0.0/8 [1/0] via 4.0.0.2, vlan4
S       6.0.0.0/8 [1/0] via 4.0.0.2, vlan4
```

Configuration Example

Static Routing (IPv4) Configuration Example

Create IPv4 Static routes in R1 and R2. PC2, PC3, PC4 and PC5 in different VLAN can communicate (PING) to each other.

Topology

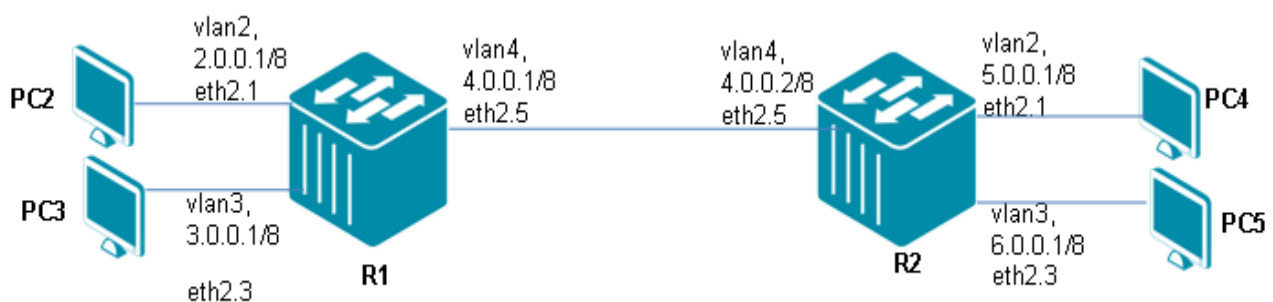

Figure 21-1 Static Routing (IPv4) Configuration Topology

R1 (Router 1) Configuration Steps

Step 1: create vlan 2, 3, 4

```
DGS-6600:15(config)#vlan 2
DGS-6600:15(config-vlan)#vlan 3
DGS-6600:15(config-vlan)#vlan 4
```

Step 2: add port into vlan

```
DGS-6600:15(config)#interface range eth2.1-2.2
DGS-6600:15(config-if)# access vlan 2
DGS-6600:15(config-if)#interface range eth2.3-2.4
DGS-6600:15(config-if)# access vlan 3
DGS-6600:15(config-if)#interface range eth2.5-2.6
DGS-6600:15(config-if)# access vlan 4
```

Step 3: configure IP address of VLAN

```
DGS-6600:15(config)#interface vlan2
DGS-6600:15(config-if)# ip address 2.0.0.1/8
DGS-6600:15(config-if)#interface vlan3
DGS-6600:15(config-if)# ip address 3.0.0.1/8
DGS-6600:15(config-if)#interface vlan4
DGS-6600:15(config-if)# ip address 4.0.0.1/8
```

Step 4: set static routing

```
DGS-6600:15(config)#ip route 5.0.0.0/8 4.0.0.2
DGS-6600:15(config)#ip route 6.0.0.0/8 4.0.0.2
```

R2 (Router 2) Configuration Steps

Step 1: create vlan 2, 3, 4

```
DGS-6600:15(config)#vlan 2
DGS-6600:15(config-vlan)#vlan 3
DGS-6600:15(config-vlan)#vlan 4
```

Step 2: add port into vlan

```
DGS-6600:15(config)#interface range eth2.1-2.2
DGS-6600:15(config-if)# access vlan 2
DGS-6600:15(config-if)#interface range eth2.3-2.4
DGS-6600:15(config-if)# access vlan 3
DGS-6600:15(config-if)#interface range eth2.5-2.6
DGS-6600:15(config-if)# access vlan 4
```

Step 3: configure IP address of VLAN

```
DGS-6600:15(config)#interface vlan2
DGS-6600:15(config-if)# ip address 5.0.0.1/8
DGS-6600:15(config-if)#interface vlan3
DGS-6600:15(config-if)# ip address 6.0.0.1/8
DGS-6600:15(config-if)#interface vlan4
DGS-6600:15(config-if)# ip address 4.0.0.2/8
```

Step 4: set static routing

```
DGS-6600:15(config)#ip route 2.0.0.0/8 4.0.0.1
DGS-6600:15(config)#ip route 3.0.0.0/8 4.0.0.1
```

Verifying The Configuration

Step 1: Check R1 Static Route configuration. Repeat the process, used in checking R1, to check other routers tables.

```
DGS-6600:15#show ip route
Codes: K - kernel, C - connected, S - static, R - RIP, B - BGP
       O - OSPF, IA - OSPF inter area
       N1 - OSPF NSSA external type 1, N2 - OSPF NSSA external type 2
       E1 - OSPF external type 1, E2 - OSPF external type 2
       i - IS-IS, L1 - IS-IS level-1, L2 - IS-IS level-2, ia - IS-IS inter area
       # - A number of slots are inactive
       * - candidate default

C       2.0.0.0/8 is directly connected, vlan2
C       4.0.0.0/8 is directly connected, vlan4
S       5.0.0.0/8 [1/0] via 4.0.0.2, vlan4
S       6.0.0.0/8 [1/0] via 4.0.0.2, vlan4
```

PCs in different VLANs can ping PCs in different VLANs, that are in the same router (local router), and can ping PC connected in "remote" routers.

Chapter 22

Routing Information Protocol (RIP)

Chapter Overview

The following topics are included in this chapter, please go to the topic for more detailed information:

- [Chapter Overview](#)
 - [An Introduction to RIP](#)
- [RIP Configuration Commands](#)
 - [Specifying the RIP Version](#)
 - [Enabling RIP and Specifying Advertised Networks](#)
 - [Specifying Passive Interfaces](#)
 - [Specifying Unicast RIP Information Updates](#)
 - [Using Broadcast Packets in RIPv2](#)
 - [Configuring RIP Timers](#)
 - [Enabling RIP Authentication](#)
 - [Configuring Authentication Key-Chains](#)
 - [Generating a Default Route](#)
 - [Redistributing Routes to RIP](#)
 - [Displaying RIP Protocol and Interface Settings](#)
 - [Displaying the RIP Routing Table](#)
- [Configuration Examples](#)
 - [RIP Configuration Example](#)
- [List of Constants and Default Settings](#)

An Introduction to RIP

Routing Information Protocol is a simple routing protocol that is based on distance-vector routing. When RIP is running on a router, the router exchanges routing information with neighboring routers so that knowledge about the network can be shared at periodic intervals.

RIP measures distance by counting the number of hops that are required to get from one network to another. A router is one hop from a directly connected network, two hops from a network that can be reached through a router, etc. The more routers between a source and a destination, the greater the RIP distance (or hop count). If multiple routes to the same destination are learned by the router, only the route with the shortest distance (or metric) is written into the routing table. When the metric of the route is more than 16, the destination network will be treated as unreachable.

When a route is learned and added to the routing table, a timer is started. This timer is restarted every time a new update for the route is received. If an advertisement for the route is not received within the period of time defined in the expiration timer, the route is marked as invalid.

An invalid route will not be removed from the routing table right away. Instead a timer called the garbage collection timer will start and the route will continue to be advertised with a metric value of

16, with the invalid route still being used for routing packets. The route is purged from the routing table once the garbage timer has expired.

RIP Configuration Commands

The following topics are included in this section:

- [Specifying the RIP Version](#)
- [Enabling RIP and Specifying Advertised Networks](#)
- [Specifying Passive Interfaces](#)
- [Specifying Unicast RIP Information Updates](#)
- [Using Broadcast Packets in RIPv2](#)
- [Configuring RIP Timers](#)
- [Enabling RIP Authentication](#)
- [Configuring Authentication Key-Chains](#)
- [Generating a Default Route](#)
- [Redistributing Routes to RIP](#)
- [Displaying RIP Protocol and Interface Settings](#)
- [Displaying the RIP Routing Table](#)

Specifying the RIP Version

The user can either specify the RIP protocol version globally for the entire device or on individual interfaces. The global RIP version applies to all interfaces unless the version is explicitly specified for the individual interface.

Use the following commands to define the RIP version that will be sent and received by the Switch:

Command	Explanation
<code>version {1 2}</code>	Specifies if the Switch will operate in RIP version 1 or version 2.
<code>ip rip receive version VERSION-ID [, -]</code>	Specifies if the interface will only receive version 1, version 2, or both versions of RIP packets.
<code>ip rip send version VERSION-ID [, -]</code>	Specifies if the interface will only transmit version 1, version 2, or both versions of RIP packets.

In the following example, the user configures the RIP version of the entire Switch to be version 2:

```
DGS-6600:2>enable
DGS-6600:15#configure terminal
DGS-6600:15(config)#router rip
DGS-6600:15(config-router)#version 2
DGS-6600:15(config-router)#end
```

In the following example, the user configures VLAN interface 30 to send both RIP version 1 and RIP version 2 packets:

```
DGS-6600:2>enable
DGS-6600:15#configure terminal
DGS-6600:15 (config)#interface vlan30
DGS-6600:15 (config-if)#ip rip send version 1-2
DGS-6600:15 (config-if)#end
```

In the following example, the user configures VLAN interface 401 to only transmit RIP version 1 packets:

```
DGS-6600:2>enable
DGS-6600:15#configure terminal
DGS-6600:15 (config)#interface vlan401
DGS-6600:15 (config-if)#ip rip send version 1
DGS-6600:15 (config-if)#end
```

In the following example, the user configures VLAN interface 404 to accept both RIP version 1 and version 2 packets:

```
DGS-6600:2>enable
DGS-6600:15#configure terminal
DGS-6600:15 (config)#interface vlan404
DGS-6600:15 (config-if)#ip rip receive version 1-2
DGS-6600:15 (config-if)#end
```

In the following example, the user configures VLAN interface 405 to only accept RIP version 1 packets:

```
DGS-6600:2>enable
DGS-6600:15#configure terminal
DGS-6600:15 (config)#interface vlan405
DGS-6600:15 (config-if)#ip rip receive version 1
DGS-6600:15 (config-if)#end
```

Enabling RIP and Specifying Advertised Networks

To run RIP, the user needs to enter RIP router configuration mode and configure the related RIP protocol parameter settings before the RIP protocol can be started. The **network** command specifies the networks that will operate with the RIP protocol. All the interfaces that are spanned by the interface will be activated with RIP.

Use the following commands to enable RIP and specify the networks that RIP will be advertised on:

Command	Explanation
router rip	Enables the RIP routing process.
network NETWORK-PREFIX/MASK	Defines the networks that will be advertised by the RIP protocol.

In the following example, the user specifies that the 192.168.70.0/24 and 10.99.0.0/16 networks will be advertised using the RIP protocol:

```
DGS-6600:2>enable
DGS-6600:15#configure terminal
DGS-6600:15 (config)#router rip
DGS-6600:15 (config-router)#network 192.168.70.0/24
DGS-6600:15 (config-router)#network 10.99.0.0/16
DGS-6600:15 (config-router)#end
```

Specifying Passive Interfaces

When an interface is activated with RIP, the interface sends and receives RIP packets. To meet some application needs, an interface can be set to passive, which means that the routing information will not be advertised out of an interface using either the broadcast or multicast methods.

Use the following command to specify the interfaces that will not advertise RIP routing updates:

Command	Explanation
<code>passive-interface <i>IF-NAME</i></code>	Specifies the interfaces that will not advertise RIP routing updates.

In the following example, the user specifies that VLAN interface 30 will not advertise RIP routing updates:

```
DGS-6600:2>enable
DGS-6600:15#configure terminal
DGS-6600:15 (config)#router rip
DGS-6600:15 (config-router)#passive-interface vlan30
DGS-6600:15 (config-router)#end
```

Specifying Unicast RIP Information Updates

For some applications, the Switch may need to update routes to neighbor routers using unicast RIP updates. The user can achieve this by configuring unicast neighbors. Configuring unicast neighbors on a passive interface allows the router to exchange routing information with a subset of routers on the VLAN interface.

Enter the following command to configure a unicast neighbor:

Command	Explanation
<code>neighbor <i>IP-ADDRESS</i></code>	Defines the IP address of the neighbor that will be sent unicast RIP updates.

In the following example, the user configures the Switch to send unicast routing updates to the IP address 10.50.71.50:

```
DGS-6600:2>enable
DGS-6600:15#configure terminal
DGS-6600:15 (config)#router rip
DGS-6600:15 (config-router)#neighbor 10.50.71.50
DGS-6600:15 (config-router)#end
```

Using Broadcast Packets in RIPv2

RIP version 2 improves version 1 by sending multicast packets instead of broadcast packets. Using multicast packets reduces the traffic on the network as routing updates will only be sent to hosts that are members of the specified multicast group. However, since some hosts may not be able to receive multicast RIP packets, the user can specify that RIP send version 2 packets will be sent to an IP broadcast address on the specified interface.

Use the following command to specify that RIP version 2 packets will be sent to an IP broadcast address on the specified VLAN interface:

Command	Explanation
<code>ip rip v2-broadcast</code>	Specifies that RIP version 2 packets will be sent to an IP broadcast address on the specified VLAN interface.

In the following example, the user configures the Switch to update RIP information on VLAN interface 30 using IP broadcasts:

```
DGS-6600:2>enable
DGS-6600:15#configure terminal
DGS-6600:15 (config)#interface vlan30
DGS-6600:15 (config-if)#ip rip v2-broadcast
DGS-6600:15 (config-if)#end
```

Configuring RIP Timers

Enter the following command to configure the network timers for RIP:

Command	Explanation
<code>timers {update SECONDS invalid SECONDS flush SECONDS}</code>	Configures the network timers for the RIP protocol.

In the following example, the user configures the value of the RIP update timer to be 60 seconds, the invalid timer to be 360 seconds, and the flush timer to be 240 seconds:

```
DGS-6600:2>enable
DGS-6600:15#configure terminal
DGS-6600:15 (config)#router rip
DGS-6600:15 (config-router)#timers update 60
DGS-6600:15 (config-router)#timers invalid 360
DGS-6600:15 (config-router)#timers flush 240
DGS-6600:15 (config-router)#end
```

Enabling RIP Authentication

Only RIP version 2 has the capability for authenticating routing information. The user can enable the authentication function on a specified interface. The keys used to validate the packet are defined using the **key-chain** command and each interface can have a unique key-chain.

Use the following commands to enable RIP authentication and define the authentication key chain:

Command	Explanation
<code>ip rip authentication key-chain <i>NAME-OF-KEY</i></code>	Enables RIP authentication and specifies the key chain that will be used for authentication.
<code>ip rip authentication mode {text md5}</code>	Specifies if the key will be validated as clear text or an MD5 encrypted key.

In the following example, the user enables RIP authentication on VLAN interface 404, specifying a key-chain name of “Auth-Key1”, and specifies that the key will be validated in clear text form:

```
DGS-6600:2>enable
DGS-6600:15#configure terminal
DGS-6600:15 (config)#interface vlan404
DGS-6600:15 (config-if)#ip rip authentication key-chain auth-key1
DGS-6600:15 (config-if)#ip rip authentication mode text
DGS-6600:15 (config-if)#end
```

Configuring Authentication Key-Chains

A key-chain defines the keys that are valid authentication keys and the keys that can only be sent in different time frames. In order to allow the smooth migration of key changes, the time frame of two keys can overlap. For a received authentication key, the key-chain is valid as long as the key-chain matches a key that is valid at the specified receive time.

Use the following commands to configure an authentication key-chain:

Command	Explanation
<code>key chain <i>NAME-OF-KEY</i></code>	Creates a new key chain that will be used for authentication with RIP version 2
<code>key <i>KEY-ID</i></code>	Identifies the authentication key that will be used with RIP.

Command	Explanation
key-string <i>TEXT</i>	Specifies the authentication string that will be used with the authentication key.
accept-lifetime <i>START-TIME</i> {infinite <i>END-TIME</i> <i>DURATION</i> <i>SECONDS</i> }	Specifies the start and end time for the validity of a received authentication key on a key chain. The end time can be set to a specific time, infinitely, or for a specific time duration.
send-lifetime <i>START-TIME</i> {infinite <i>END-TIME</i> duration <i>SECONDS</i> }	Specifies the start and end time for the validity of an authentication key on a key chain that will be sent. The end time can be set to a specific time, infinitely, or for a specific time duration.

In the following example, the user creates a key-chain named "auth1", with a key-ID of "1". The user then creates a key-string called "forkey1string" that will be accepted from 1:30 p.m. to 3:30 p.m. and be sent from 2:00 p.m. to 3:00 p.m. The user then creates a key-string called "forkey3string" that will be accepted from 2:30 p.m. to 4:30 p.m. and be sent from 3:00 p.m. to 4:00 p.m. Finally, the user applies key-chain auth1 and to VLAN interface 406, using clear text authentication:

```
DGS-6600:2>enable
DGS-6600:15#configure terminal
DGS-6600:15 (config)#key chain auth1
DGS-6600:15 (config-keychain)#key 1
DGS-6600:15 (config-keychain-key)#key-string forkey1string
DGS-6600:15 (config-keychain-key)#accept-lifetime 13:30:00 Jan 25 2009 duration 7200
DGS-6600:15 (config-keychain-key)#send-lifetime 14:00:00 Jan 25 2009 duration 3600
DGS-6600:15 (config-keychain-key)#exit
DGS-6600:15 (config-keychain)#key 3
DGS-6600:15 (config-keychain-key)#key-string forkey3string
DGS-6600:15 (config-keychain-key)#accept-lifetime 14:30:00 Jan 25 2009 duration 7200
DGS-6600:15 (config-keychain-key)#send-lifetime 15:00:00 Jan 25 2009 duration 3600
DGS-6600:15 (config-keychain-key)#end
DGS-6600:15#configure terminal
DGS-6600:15 (config)#interface vlan406
DGS-6600:15 (config-if)#ip rip authentication key-chain auth1
DGS-6600:15 (config-if)#ip rip authentication mode text
DGS-6600:15 (config-if)#end
```

Generating a Default Route

The user can configure the Switch to generate a default route for RIP. The generated default route has a metric value of 1.

Use the following command to automatically generate a default route for RIP:

Command	Explanation
default-information originate	Specifies that a default route will be automatically generated by RIP.

In the following example, the user configures the Switch to generate a default route using the RIP routing process:

```
DGS-6600:2>enable
DGS-6600:15#configure terminal
DGS-6600:15 (config)#router rip
DGS-6600:15 (config-router)#default-information originate
DGS-6600:15 (config-router)#end
```

Redistributing Routes to RIP

The routes learned by other protocols such as OSPF or BGP can be redistributed to RIP. The redistributed routes will be associated with the metric specified for the redistributed protocol, or associated with the default metric if a metric is not specified by the user.

Use the following commands to redistribute routes from one routing domain into another routing domain:

Command	Explanation
<code>redistribute <i>PROTOCOL</i> [<i>metric METRIC-VALUE</i>]</code>	Redistributes routes from one routing domain into another routing domain.
<code>default-metric <i>METRIC-VALUE</i></code>	Specifies the default metric for the redistributed routes.

In the following example, the user configures the Switch to redistribute OSPF routes into a RIP domain:

```
DGS-6600:2>enable
DGS-6600:15#configure terminal
DGS-6600:15 (config)#router rip
DGS-6600:15 (config-router)#redistribute ospf
DGS-6600:15 (config-router)#end
```

In the following example, the user defines a default metric value of 5 for routes that were redistributed by the RIP routing protocol:

```
DGS-6600:2>enable
DGS-6600:15#configure terminal
DGS-6600:15 (config)#router rip
DGS-6600:15 (config-router)#default-metric 5
DGS-6600:15 (config-router)#end
```

Displaying RIP Protocol and Interface Settings

Use the following commands to display the RIP protocol and interface settings:

Command	Explanation
<code>show ip rip interface</code> <code>[INTERFACE-ID]</code>	Displays interface specific RIP information.
<code>show ip protocols rip</code>	Displays information about the state of the RIP routing process.

In the following example, the user displays interface specific RIP information for VLAN interface 5:

```
DGS-6600:2>show ip rip interface vlan5
vlan5 is up, line protocol is up
  Routing Protocol: RIP
    Receive RIPv1 and RIPv2 packets
    Send RIPv1 and RIPv2 packets
    Send v2-broadcast: Disabled
    Authentication Mode: text
    Passive interface: Disabled
    Split horizon: Enabled with Poisoned Reversed
    IP interface address:
      172.16.0.2/16
DGS-6600:2>
```

In the following example, the user displays information about the state of the RIP routing process:

```
DGS-6600:2>show ip protocols rip
Routing Protocol is "rip"
  Sending updates every 60 +/- (0 to 5) seconds, next due in 32 seconds
  Timeout after 360 seconds, garbage collect after 240 seconds
  Default redistribution metric is 5
  Redistributing:
    type          metric
    -----
    ospf          5

  Default version control: send version 2, receive version 2
  Interface      Send  Recv  V2-broadcast  Key-chain
  vlan5          1-2  1-2  Off
  Routing for Networks:
    vlan5 (172.16.0.2/16)

  Routing Information Sources:
    Gateway      Distance  Last Update  Bad Packets  Bad Routes
  the maximum number of RIP routes allowed: 12288
  Number of routes (excluding connected): 0
  Distance: (default is 120)
DGS-6600:2>
```

Displaying the RIP Routing Table

Use the following command to display the summary address entries in the Routing Information Protocol (RIP) routing database:

Command	Explanation
<code>show ip rip database</code>	Displays the summary address entries in the Routing Information Protocol (RIP) routing database.

In the following example, the user displays the summary address entries in the Routing Information Protocol (RIP) routing database for all VLAN interfaces:

```
DGS-6600:2>show ip rip database

Codes: R - RIP, Rc - RIP connected, Rs - RIP static, K - Kernel,
       C - Connected, S - Static, O - OSPF, I - IS-IS, B - BGP

   Network          Next Hop           Metric From       If        Time
Rs 0.0.0.0/0
Rc 172.16.0.0/16
R  192.168.3.0/24   172.16.0.1        2 172.16.0.1     vlan5    0DT0H2M52S

Total Entries: 3
DGS-6600:2>
```

Configuration Examples

RIP Configuration Example

Configuring RIP protocol in R1 and R2. The routing entries can be learned by RIP protocol. In R1, routes 5.0.0.0/8 and 6.0.0.0/8 can be learned dynamically by RIP protocol. In R2, routes: 2.0.0.0/8 and 3.0.0.0/8 can be learned dynamically by RIP protocol. All PCs in the topology can communicate (e.g., PING) each other by routing.

Topology

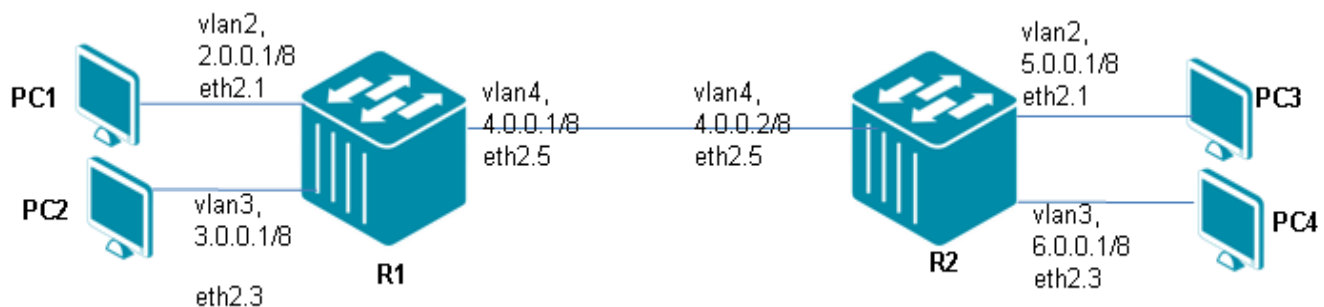

Figure 22-1 RIP Configuration Example Topology

R1 (Router 1) Configuration Steps

Step 1: create vlan 2, 3, 4

```
DGS-6600:15(config)#vlan 2
DGS-6600:15(config-vlan)#vlan 3
DGS-6600:15(config-vlan)#vlan 4
```

Step 2: add port into vlan

```
DGS-6600:15(config-vlan)#interface range eth2.1-2.2
DGS-6600:15(config-if)# access vlan 2
DGS-6600:15(config-if)#interface range eth2.3-2.4
DGS-6600:15(config-if)# access vlan 3
DGS-6600:15(config-if)#interface range eth2.5-2.6
DGS-6600:15(config-if)# access vlan 4
```

Step 3: configure IP address of VLAN

```
DGS-6600:15(config-if)#interface vlan2
DGS-6600:15(config-if)#ip address 2.0.0.1/8
DGS-6600:15(config-if)#interface vlan3
DGS-6600:15(config-if)#ip address 3.0.0.1/8
DGS-6600:15(config-if)#interface vlan4
DGS-6600:15(config-if)#ip address 4.0.0.1/8
```

Step 4: rip setting

```
DGS-6600:15(config-if)# router rip
DGS-6600:15(config-router)# network 2.0.0.1/8
DGS-6600:15(config-router)# network 3.0.0.1/8
DGS-6600:15(config-router)# network 4.0.0.1/8
```

R2 (Router 2) Configuration Steps

Step 1: create vlan 2, 3, 4

```
DGS-6600:15(config)#vlan 2
DGS-6600:15(config-vlan)#vlan 3
DGS-6600:15(config-vlan)#vlan 4
```

Step 2: add port into vlan

```
DGS-6600:15(config-vlan)#interface range eth2.1-2.2
DGS-6600:15(config-if)#access vlan 2
DGS-6600:15(config-if)#interface range eth2.3-2.4
DGS-6600:15(config-if)#access vlan 3
DGS-6600:15(config-if)#interface range eth2.5-2.6
DGS-6600:15(config-if)#access vlan 4
```

Step 3: configure IP address of VLAN

```
DGS-6600:15(config-if)#interface vlan2
DGS-6600:15(config-if)#ip address 5.0.0.1/8
DGS-6600:15(config-if)#interface vlan3
DGS-6600:15(config-if)#ip address 6.0.0.1/8
DGS-6600:15(config-if)#interface vlan4
DGS-6600:15(config-if)#ip address 4.0.0.2/8
```

Step 4: rip setting

```
DGS-6600:15(config-if)#router rip
DGS-6600:15(config-router)# network 4.0.0.2/8
DGS-6600:15(config-router)# network 5.0.0.1/8
DGS-6600:15(config-router)# network 6.0.0.1/8
```

Verifying The Configuration

Step 1: Check R1 IP routing table. Use the same command to check other routers table.

```
DGS-6600:15#show ip route
Codes: K - kernel, C - connected, S - static, R - RIP, B - BGP
       O - OSPF, IA - OSPF inter area
       N1 - OSPF NSSA external type 1, N2 - OSPF NSSA external type 2
       E1 - OSPF external type 1, E2 - OSPF external type 2
       i - IS-IS, L1 - IS-IS level-1, L2 - IS-IS level-2, ia - IS-IS inter area
       # - A number of slots are inactive
       * - candidate default

C       2.0.0.0/8 is directly connected, vlan2
C       3.0.0.0/8 is directly connected, vlan3
C       4.0.0.0/8 is directly connected, vlan4
R       5.0.0.0/8 [120/2] via 4.0.0.2, vlan4, 0DT0H0M24S
R       6.0.0.0/8 [120/2] via 4.0.0.2, vlan4, 0DT0H0M24S

Total Entries: 5 entries, 5 routes
```

PCs in different VLANs can ping PCs in different VLANs, within the same router (local router), and can ping PCs connected to "remote" routers.

List of Constants and Default Settings

Constant Name	Value
Number of Supported Key Chains	16
Number of Keys in a Key Chain	32

Table 22-1 Constants Values

Variable Name	Default Value
Default Information Originate	Disabled
Default Metric	1
IP RIP Authentication Key Chain	No Authentication
IP RIP Authentication Mode	Plain-Text
IP RIP Receive Version	2
IP RIP Send Version	2
IP RIP Version 2 Broadcast	Disabled
IP Route Multi-Path	Enabled
Passive Interface	Disabled
Update Time	30 Seconds
Invalid Time	180 Seconds
Flush Time	120 Seconds

Table 22-2 Default Variable Values

Chapter 23

Open Shortest Path First (OSPF)

Chapter Overview

The following topics are included in this chapter, please go to the topic for more detailed information:

- [An Introduction to OSPF](#)
 - [An Introduction to OSPF](#)
- [OSPF Configuration Commands](#)
 - [Basic Commands and Functions](#)
 - [Generating a Default Route](#)
 - [Redistributing Routes to OSPF](#)
 - [Displaying Border Routers](#)
 - [Restarting OSPF](#)
- [Configuration Examples](#)
 - [OSPFv2 Configuration \(Basic\) Example](#)
 - [OSPFv2 Configuration Example 2](#)
- [List of Constants and Default Settings](#)

An Introduction to OSPF

OSPF is an interior routing protocol that operates within the scope of a domain. A domain is also an autonomous system. An OSPF domain is divided into several sub-domains, which are called areas. Routers within the same area need to maintain a database that defines the topology of the area, but have no need to understand details about the topology outside their own area. Due to this hierarchical structure, OSPF is a routing protocol that is suitable for deploying on large networks.

The division of areas in OSPF is based on a two level structure, with the backbone area being on the first level and the non-backbone areas being on the second level. Each OSPF domain consists of a single backbone area and all other areas in the OSPF domain need to connect to the backbone area. Each area in the OSPF domain needs to have a unique ID. OSPF always identifies the backbone area as zero. Routing information in non-zero areas can be exchanged with the zero area but can not be exchanged with other non-zero areas. Typically, summarized routes are exchanged between the different areas. This design reduces the number of routes that are propagated across areas and maintains the simplicity of the protocol operation.

The router that connects the non-zero area to the zero area is the Area Border Router (ABR). ABRs are responsible for carrying out inter-area routing. An AS Border Router (ASBR) connects the area within an AS to the external network. ASBRs are responsible for redistributing the external routes to the OSPF AS and vice versa. Thus, the ASBR carries out inter-AS routing. The router within the same area carries out the intra-area routing.

OSPF routers exchange routing information using Link State Advertisements (LSA). The exchanged information is divided into the following types:

- Router LSA (Type 1)
- Network LSA (Type 2)

- Summary LSA - Network (Type 3)
- Summary LSA - ASBR (Type 4)
- AS-External Route LSA (Type 5)
- NSSA External Route LSA (Type 7)

The LSAs used by OSPF carry out different roles. Type 1 and Type 2 LSAs are used to carry the intra-area routing information. Type 3 & Type 4 LSAs are used to carry the inter-area routing information. Type 5 and Type 7 LSAs are used to carry the external routing information. Type 4 LSAs give the routing information to the ASBR, which forwards packets destined for the external route.

The stub area and the not-so-stubby area are special non-zero areas. A stub area does not see the external routes. Packets from the stub area destined for external networks will always be forwarded by the border router by a defined default route. A totally stubby area is a stub area that has the further restriction of not being able to see the inter-area routes. The not-so-stubby area is an extension of the stub area. A not-so-stubby area is more flexible than a stub area in that it can be connected to the external small domain, which allows the connected ASBR to import the external routes to the AS so that traffic destined for the external small domain can be transported.

OSPF Configuration Commands

Basic Commands and Functions

The following topics are included in this section:

- [Specifying OSPF Network Areas](#)
- [Specifying an OSPF Router-ID](#)
- [Specifying an OSPF Router Priority](#)
- [Specifying the OSPF Area Type](#)
- [Specifying Passive Interfaces](#)
- [Initiating OSPF Shutdown on a Specific VLAN Interface](#)
- [Specifying the OSPF Cost on a VLAN Interface](#)
- [Configuring OSPF Authentication](#)
- [Configuring OSPF Timers](#)
- [Configuring Area Host Route](#)
- [Creating OSPF Virtual Links](#)

Specifying OSPF Network Areas

To run OSPF, the user needs to enter the OSPF router configuration mode and specify the networks that will operate within the specified area. The interfaces that have been configured with subnets that are covered within the specified OSPF network will start the OSPF protocol operation. The area with an area ID of 0.0.0.0 or 0 will become area zero and the other areas will become non-zero areas.

Use the following commands to enable OSPF and specify the networks that OSPF will be advertised on:

Command	Explanation
<code>router ospf</code>	Enables the OSPF routing process and enters into router configuration mode.
<code>network SUBNET-PREFIX/SUBNET-MASK-LENGTH area AREA-ID</code>	Defines the network address, using an IP prefix and mask length, and area ID for the interfaces that are running OSPF.

In the following example, the user enables OSPF and uses the IP prefix and mask length method to assign the subnet prefix 172.16.0.0/16 to operate in OSPF area 3:

```
dgs-6600:2>enable
dgs-6600:15#configure terminal
dgs-6600:15 (config)#router ospf
dgs-6600:15 (config-router)#network 172.16.0.0/16 area 3
dgs-6600:15 (config-router)#end
```

Specifying an OSPF Router-ID

The Router ID is a number assigned to each router running OSPF. Each router in an AS must have a unique Router ID. The user can manually assign a Router ID or use the default Router ID that is assigned by the router, which is the highest IP address that has been configured on the device.

Use the following command to specify a Router ID for the OSPF process:

Command	Explanation
<code>router-id IP-ADDRESS</code>	Specifies the Router ID for the OSPF process.

In the following example, the user configures the Router ID to be 10.10.10.60:

```
dgs-6600:2>enable
dgs-6600:15#configure terminal
dgs-6600:15 (config)#router ospf
dgs-6600:15 (config-router)#router-id 10.10.10.60
dgs-6600:15 (config-router)#end
```

Specifying an OSPF Router Priority

Each broadcast or non-broadcast multi-access network that has at least two attached routers has a Designated Router. The Designated Router is responsible for advertising the network LSA. The router with the highest priority will be elected as the designated router.

Enter the following command in VLAN interface configuration mode to manually set the OSPF router priority of a VLAN interface:

Command	Explanation
<code>ip ospf priority <i>PRIORITY</i></code>	Manually sets the OSPF router priority on the VLAN interface.

In the following example, the user configures the OSPF router priority on VLAN interface 5 to be 3:

```
dgs-6600:2>enable
dgs-6600:15#configure terminal
dgs-6600:15(config)#interface vlan5
dgs-6600:15(config-if)#ip ospf priority 3
dgs-6600:15(config-if)#end
```

Specifying the OSPF Area Type

The user can further specify a non-zero area as a total stubby area, not-totally stubby area, NSSA area, or NSSA not-totally stubby area.

Use the following commands to specify the OSPF area type:

Command	Explanation
<code>area <i>AREA-ID</i> stub [no-summary]</code>	Defines an area as a stubby area or a not-totally stubby area.
<code>area <i>AREA-ID</i> nssa [no-redistribution] [default-information-originate [metric <i>METRIC-VALUE</i>] [metric-type <i>TYPE-VALUE</i>]] [no-summary]</code>	Defines the area as an NSSA totally stubby area or an NSSA area.

In the following example, the user creates a stub area with an area ID of 2:

```
dgs-6600:2>enable
dgs-6600:15#configure terminal
dgs-6600:15(config)#router ospf
dgs-6600:15(config-router)#area 2 stub
dgs-6600:15(config-router)#end
```

In the following example, the user sets area 1 to be an NSSA:

```
dgs-6600:2>enable
dgs-6600:15#configure terminal
dgs-6600:15(config)#router ospf
dgs-6600:15(config-router)#area 1 nssa
dgs-6600:15(config-router)#end
```

Specifying Passive Interfaces

An interface that is connected to a stub network that does not have any other routers inside can be specified as a passive interface. If the user specifies a passive interface, the OSPF process will neither send or receive OSPF messages on that interface.

Use the following command to specify the interfaces that will not advertise OSPF routing updates:

Command	Explanation
<code>passive-interface <i>INTERFACE-ID</i></code>	Specifies that the interface will not advertise OSPF routing updates.

In the following example, the user specifies that VLAN interface 30 will not advertise OSPF routing updates:

```
dgs-6600:2>enable
dgs-6600:15#configure terminal
dgs-6600:15 (config)#router ospf
dgs-6600:15 (config-router)#passive-interface vlan30
dgs-6600:15 (config-router)#end
```

Initiating OSPF Shutdown on a Specific VLAN Interface

The Switch allows a user to temporarily shutdown the OSPF protocol on a specific VLAN interface in a method that causes minimum disruption and informs neighboring routers that it will be unavailable. When this procedure is implemented, all traffic that has another path through the network will be directed down an alternate path.

Use the following command to shutdown OSPF on a specific VLAN interface:

Command	Explanation
<code>ip ospf shutdown [<i>INTERFACE-ID</i>]</code>	Initiates an OSPF graceful shutdown on a VLAN interface.

In the following example, the user initiates an OSPF protocol graceful shutdown on VLAN interface 5:

```
dgs-6600:2>enable
dgs-6600:15#configure terminal
dgs-6600:15 (config)#router ospf
dgs-6600:15 (config-router)#ip ospf shutdown vlan5
dgs-6600:15 (config-router)#end
```

Specifying the OSPF Cost on a VLAN Interface

The interface cost reflects the overhead for sending a packet across an interface. The cost is inversely proportional to the speed of an interface. Thus, it is inversely proportional to the bandwidth of the link. The higher the bandwidth is, the less the cost is. The speed can be manually assigned or automatically calculated based on the bandwidth. The default referential bandwidth that has a cost value of 1 is 100Mbps. Based on this default referential bandwidth, the cost of an Ethernet interface will be 1.

Use the following command to manually specify the OSPF cost of a VLAN interface:

Command	Explanation
<code>auto-cost reference-bandwidth <i>MBPS</i></code>	Specifies the referential bandwidth for the automatic calculation of cost.
<code>ip ospf cost <i>COST</i></code>	Explicitly specifies the cost of sending a packet on the VLAN interface.

In the following example, the user specifies 50 Mbps as the referential bandwidth for the automatic calculation of cost:

```
dgs-6600:2>enable
dgs-6600:15#configure terminal
dgs-6600:15 (config)#router ospf
dgs-6600:15 (config-router)#auto-cost reference-bandwidth 50
dgs-6600:15 (config-if)#end
```

In the following example, the user specifies that the cost of sending a packet on VLAN interface 5 is 10:

```
dgs-6600:2>enable
dgs-6600:15#configure terminal
dgs-6600:15 (config)#interface vlan5
dgs-6600:15 (config-if)#ip ospf cost 10
dgs-6600:15 (config-if)#end
```

Configuring OSPF Authentication

The authentication of OSPF messages can either operate in password mode or MD5 digest mode.

In password mode, the specified password is encoded within the transmit packet. The packet becomes valid if the password matches the password set on the receiving side.

In MD5 digest mode, the OSPF message sender will compute a message digest based on the message digest key for the TX message. The message digest and the key ID will be encoded in the packet. The receiver of the packet will verify the digest in the message against the digest computed based on the locally defined message digest key corresponding to the same key ID. The same key ID on the neighboring router should be defined with the same key string.

All the neighboring routers on the same interface must use the same key to exchange the OSPF packet with each other. Normally, all neighboring routers on the interface will use the same key.

With MD5 digest mode, the user can rolover to a new key without disrupting the current message exchange using the new key. Suppose that the router is currently using the old key to exchange OSPF packets with other routers, as the user configures a new key, the router will start the roll over process by sending duplicated packets of both the old and new key. The router will stop sending duplicated packets until it find that all routers on the network have learned the new key. After the rollover process has completed, the user should delete the old key to prevent the router from communicating with other routers using the old key.

The following commands are used to enable OSPF authentication and define the authentication method:

Command	Explanation
<code>ip ospf authentication [message-digest]</code>	Enables OSPF authentication and defines the authentication method.
<code>ip ospf authentication-key <i>PASSWORD</i></code>	Specifies the OSPF authentication password that will be used if plain-text authentication is being implemented on the network.
<code>ip ospf message-digest-key <i>KEY-ID</i> md5 <i>KEY</i></code>	Registers the MD5 key that will be used if the MD5 authentication method is being used on the network.

In the following example, the user implements the authentication key authentication method on VLAN interface 5 and specifies that the key “53cuR1ty” will be used for authentication:

```
dgs-6600:2>enable
dgs-6600:15#configure terminal
dgs-6600:15 (config)#interface vlan5
dgs-6600:15 (config-if)#ip ospf authentication-key 53cuR1ty
dgs-6600:15 (config-if)#ip ospf authentication
dgs-6600:15 (config-if)#end
```

In the following example, the user implements the MD5 key authentication method on VLAN interface 406 and specifies that key 10 will use the password “MD5s3cuR1ty” for authentication:

```
dgs-6600:2>enable
dgs-6600:15#configure terminal
dgs-6600:15 (config)#interface vlan406
dgs-6600:15 (config-if)#ip ospf authentication message-digest
dgs-6600:15 (config-if)#ip ospf message-digest-key 10 md5 MD5s3cuR1ty
dgs-6600:15 (config-if)#end
```

Configuring OSPF Timers

Use the following commands to adjust the timers that OSPF uses on a VLAN interface:

Command	Explanation
<code>ip ospf dead-interval <i>SECONDS</i></code>	Defines the amount of time before a neighbor router is declared dead after no hello packets have been received from the neighbor router.
<code>ip ospf hello-interval <i>SECONDS</i></code>	Specifies the interval between each OSPF hello packet that is being sent.
<code>ip ospf retransmit-interval <i>SECONDS</i></code>	Specifies the time between Link-State Advertisement (LSA) retransmissions for adjacencies belonging to the interface.

Command	Explanation
<code>ip ospf transmit-delay SECONDS</code>	Specifies the estimated time that the VLAN interface will take to transmit a Link-State-Update packet.

In the following example, the user configures VLAN interface 5 to have an OSPF dead interval value of 80 seconds, an OSPF hello interval value of 20 seconds, an OSPF retransmit interval value of 10 seconds, and an OSPF transmit delay value of 2 seconds:

```
dgs-6600:2>enable
dgs-6600:15#configure terminal
dgs-6600:15(config)#interface vlan5
dgs-6600:15(config-if)#ip ospf dead-interval 80
dgs-6600:15(config-if)#ip ospf hello-interval 20
dgs-6600:15(config-if)#ip ospf retransmit-interval 10
dgs-6600:15(config-if)#ip ospf transmit-delay 2
dgs-6600:15(config-if)#end
```

Configuring Area Host Route

The area static host route allows the user to configure a stub host entry belonging to a particular area. The router will advertise specific stub host routes as the router-LSA for a stub link.

Enter the following command to configure an area host route:

Command	Explanation
<code>host IP-ADDRESS area AREA-ID [cost COST]</code>	Configures an area host route.

In the following example, the user defines an area host route with an IP address of 172.16.10.100 in area 1:

```
dgs-6600:2>enable
dgs-6600:15#configure terminal
dgs-6600:15(config)#router ospf
dgs-6600:15(config-router)#host 172.16.10.100 area 1
dgs-6600:15(config-router)#end
```

Creating OSPF Virtual Links

If a non-zero area is not physically connected to area zero, it must be connected to area zero via a virtual link. The virtual link is a point to point link through another non-zero area. The router will send OSPF messages to the neighbor router in unicast form directly to the neighbor router IP address.

Use the following command to configure an OSPF virtual link:

Command	Explanation
<pre>area <i>AREA-ID</i> virtual-link <i>ROUTER-ID</i> [authentication message-digest null] [hello-interval <i>SECONDS</i>] [dead-interval <i>SECONDS</i>] [transmit-delay <i>SECONDS</i>] [retransmit-interval <i>SECONDS</i>] [[authentication-key <i>PASSWORD</i>] [[message-digest-key <i>KEY-ID</i> md5 <i>KEY</i>]]</pre>	Configures a virtual link between two backbone areas that are physically separated through a non-backbone area.

In the following example, the user establishes a virtual link in area 2 with a hello-interval of 5 seconds and a dead-interval of 10 seconds, specifies that the authentication password will be a simple password, and specifies that the simple password will be "V1rPa55":

```
dgs-6600:2>enable
dgs-6600:15#configure terminal
dgs-6600:15(config)#router ospf
dgs-6600:15(config-router)#area 2 virtual-link 10.10.11.50 hello-interval 5
dgs-6600:15(config-router)#area 2 virtual-link 10.10.11.50 dead-interval 10
dgs-6600:15(config-router)#area 2 virtual-link 10.10.11.50 authentication
dgs-6600:15(config-router)#area 2 virtual-link 10.10.11.50 authentication-key
V1rPa55
dgs-6600:15(config-router)#end
```

Route Summarization Across OSPF Areas

The user can configure the area border router to summarize the intra-area routes. Routes that are covered by the summary route will be suppressed. This summarization reduces the number of propagated inter-area routes.

The user can also use the **not-advertise** option to hide specific routes or summary routes from being advertised across areas.

Use the following command in OSPF router configuration mode to configure route summarization across OSPF areas:

Command	Explanation
<pre>area <i>AREA-ID</i> range <i>PREFIX/PREFIX-LENGTH</i> [advertise not-advertise][cost <i>COST</i>]</pre>	Configures route summarization across OSPF areas.

In the following example, the user configures the Switch to advertise one summary route for the network prefix 192.168.0.0/16, specifies that a Type 3 summary link advertisement should be generated, and assigns a cost value of 1000 for the summary route of area 1:

```
dgs-6600:2>enable
dgs-6600:15#configure terminal
dgs-6600:15(config)#router ospf
dgs-6600:15(config-router)#area 1 range 192.168.0.0/16 advertise cost 1000
dgs-6600:15(config-router)#end
```

Generating a Default Route

Included in this topic are:

- [Generating a Default Route to a Normal Area](#)
- [Generating a Default Route to a Stub Area](#)
- [Generating a Default Route to an NSSA Area](#)

Generating a Default Route to a Normal Area

In an OSPF domain, Type 5 external default routes can be injected to a normal area but not to a stub area. By default, ASBR will not inject Type 5 external default routes into the OSPF domain. Default routes will only be generated into normal areas when the Switch is specified to do so. An ASBR can generate a default route using one of the following two ways, unconditionally generate or conditionally generate when the redistributed routes contain a default route.

Use the following command to generate a default route to a normal OSPF area:

Command	Explanation
<code>default-information originate [always] [metric METRIC-VALUE] [metric-type TYPE-VALUE]</code>	Generates a default route to a normal OSPF area.

In the following example, the user configures the Switch to automatically generate a default route, specifying that the default route should always be advertised, with a metric value of 2, and that the route is a Type 2 external route:

```
dgs-6600:2>enable
dgs-6600:15#configure terminal
dgs-6600:15 (config)#router ospf
dgs-6600:15 (config-router)#default-information originate always metric 2 metric-type 2
dgs-6600:15 (config-router)#end
```

Generating a Default Route to a Stub Area

Type 3 default routes will be automatically injected by an ABR into stub areas, and totally stubby area. The cost associated with the default route will be one unless it is specified by the following command:

Command	Explanation
<code>area AREA-ID default-cost COST</code>	Specifies the cost associated with the Type 3 default route injected to an stub area or totally stubby area.

In the following example, the user assigns a default cost of 20 to stub network 10.0.0.0:

```
dgs-6600:2>enable
dgs-6600:15#configure terminal
dgs-6600:15 (config) #router ospf
dgs-6600:15 (config-router) #area 10.0.0.0 default-cost 20
dgs-6600:15 (config-router) #end
```

Generating a Default Route to an NSSA Area

For an ABR of an NSSA area, Type 3 default routes will be automatically injected into an NSSA area. The user can manually specify that Type 7 default routes will be injected into the NSSA area.

For an ASBR, when the **default-information-originate** option is specified, Type 7 default routes will be generated into the NSSA area when it exists in the redistributed routes. If **no-redistribution** is specified, a default route will not be generated.

For an ABR, when the **default-information-originate** option is specified, the Type-7 default route will always be generated into the NSSA area.

If there are multiple default routes generated into the NSSA area, the following priority will be followed: intra-route > inter-route > external route.

Use the following command in OSPF router configuration mode to specify the area parameters that are needed to configure an OSPF NSSA area:

Command	Explanation
area <i>AREA-ID</i> nssa [default-information-originate [metric <i>METRIC-VALUE</i>] [metric-type <i>TYPE-VALUE</i>]]	Defines the area that will be an NSSA.

In the following example, the user sets area 1 to be an NSSA:

```
dgs-6600:2>enable
dgs-6600:15#configure terminal
dgs-6600:15 (config) #router ospf
dgs-6600:15 (config-router) #area 1 nssa
dgs-6600:15 (config-router) #end
```

Redistributing Routes to OSPF

Included in this Topic are:

- [Redistributing Routes to Normal Areas and NSSA Areas](#)
- [Route Summarization Across OSPF Areas](#)

Redistributing Routes to Normal Areas and NSSA Areas

External routes can be redistributed to normal areas as Type 5 external routes and redistributed to NSSA areas as Type 7 external routes by an ASBR.

Use the following commands to redistribute routes from other protocols into OSPF routing domain.:

Command	Explanation
<code>redistribute <i>PROTOCOL</i> [<i>PROCESS-ID</i>] [<i>metric METRIC-VALUE</i>] [<i>metric-type TYPE-VALUE</i>] [<i>route-map MAP-NAME</i>]</code>	Redistributes routes from other protocols to OSPF.
<code>default-metric <i>METRIC-VALUE</i></code>	Specifies the default metric for the redistributed routes.

In the following example, the user configures the Switch to redistribute BGP routes in an OSPF domain:

```
dgs-6600:2>enable
dgs-6600:15#configure terminal
dgs-6600:15 (config)#router ospf
dgs-6600:15 (config-router)#redistribute bgp
dgs-6600:15 (config-router)#end
```

In the following example, the user defines a default metric value of eight for routes that were redistributed by the OSPF routing protocol:

```
dgs-6600:2>enable
dgs-6600:15#configure terminal
dgs-6600:15 (config)#router ospf
dgs-6600:15 (config-router)#default-metric 8
dgs-6600:15 (config-router)#end
```

Preventing Redistribution of Routes to a NSSA Area

The user can mask out the redistribution of Type 7 external routes to the NSSA area by using the `area nssa` command with no redistribution option, whereas Type 5 external routes will always be redistributed to the normal area.

Enter the following command to prevent the redistribution of routes to an NSSA area:

Command	Explanation
<code>area <i>AREA-ID</i> nssa [<i>no-redistribution</i>]</code>	Prevents the redistribution of routes to an NSSA area.

In the following example, the user prevents the routes from area 1 being redistributed to the NSSA area:

```
dgs-6600:2>enable
dgs-6600:15#configure terminal
dgs-6600:15 (config)#router ospf
dgs-6600:15 (config-router)#area 1 nssa no-redistribution
dgs-6600:15 (config-router)#end
```

Displaying OSPF Protocol and Interface Settings

Use the following command to display general information about the OSPF routing process:

Command	Explanation
<code>show ip ospf</code>	Displays the OSPF operating status.
<code>show ip protocols ospf</code>	Displays the configured OSPF global settings, which are related to the overall IP routing function.
<code>show ip ospf interface [INTERFACE-ID]</code>	Displays interface settings and operational status.

In the following example, the users displays the OSPF operating status:

```
dgs-6600:2>show ip ospf
Operational Router ID 10.47.65.82
Process uptime is 2 hours 58 minutes
Conforms to RFC2328, and RFC1583Compatibility flag is disabled
This router is an ABR, ABR Type is Standard (RFC2328)
SPF schedule delay 5 secs, Hold time between two SPFs 10 secs
Number of external LSA 1
Number of router LSA 5
Number of network LSA 2
Number of non-default summary LSA 5
Number of asbr summary LSA 1
Number of non-default external LSA 1
Number of LSA originated 6
Number of LSA received 52
Number of current LSA 14
LSDB database overflow limit is 24576
Number of areas attached to this router: 2
  Area 0.0.0.0 (BACKBONE)
    Number of interfaces in this area is 2 active interface number is 2
    Number of fully adjacent neighbors in this area is 2
    SPF algorithm last executed 02:56:28.263 ago
    SPF algorithm executed 6 times
    Number of LSA 7
    Network 47.65.50.0/24
  Area 0.0.0.1
    Number of interfaces in this area is 1 active interface number is 1
    Number of fully adjacent neighbors in this area is 1
    Number of fully adjacent virtual neighbors through this area is 1
    SPF algorithm last executed 02:56:38.259 ago
    SPF algorithm executed 4 times
    Number of LSA 6
    Network 47.65.51.0/24

dgs-6600:2>
```

In the following example, the user displays the configured OSPF global settings:

```
dgs-6600:2>show ip protocols ospf
Routing protocol  OSPF
Configured Router ID :10.10.10.60
Redistribute route default metric:8
Auto-cost Reference-bandwidth:100
Distance: (default is 110)
Originate type 5 default route always
metric-type 2 metric 2
Redistributing:
type          metric    metric_type
-----
rip           20        2
bgp           1         2

dgs-6600:2>
```

In the following example, the user displays the OSPF information that is specific to VLAN interface 505:

```
dgs-6600:2>show ip ospf interface vlan505
vlan505 is up
Internet Address 192.168.50.1/24, Area 0.0.0.4, MTU 1500
Router ID 10.10.10.60, Network Type BROADCAST Cost: 1
Transmit Delay is 1 sec, State DR, Priority 1
Designated Router (ID) 10.10.10.60, Interface Address 192.168.50.1
No backup designated router on this network
Timer intervals configured, Hello 10, Dead 40, Retransmit 5
Hello due in 00:00:09
Neighbor Count is 0
Hello received 0 sent 7944, DD received 0 sent 0
LS-Req received 0 sent 0, LS-Upd received 0 sent 0
LS-Ack received 0 sent 0, Discarded 0
Current Authentication Type: none
dgs-6600:2>
```

Displaying Border Routers

Included in this Topic are:

- [Displaying ABR and ASBR Information](#)
- [Displaying OSPF Neighbor Information](#)
- [Displaying OSPF Virtual Link Information](#)
- [Displaying the OSPF LSA Database](#)

Displaying ABR and ASBR Information

Use the following command to display the ABR and ASBR routing table entries for the OSPF instance:

Command	Explanation
<code>show ip ospf border-routers</code>	Displays the ABR and ASBR routing table entries for the OSPF instance.

In the following example, the user displays the ABR and ASBR routing table entries for the OSPF instance:

```
dgs-6600:2>show ip ospf border-routers

OSPF process internal Routing Table

Codes: i - Intra-area route, I - Inter-area route

i 10.47.65.83 [1] via 10.47.65.83, through TransitArea 0.0.0.1, ABR, Area 0.0.0.0
i 10.47.65.83 [1] via 47.65.51.2, vlan51, ABR, TransitArea 0.0.0.1
i 10.47.65.81 [1] via 47.65.50.1, vlan50, ASBR, Area 0.0.0.0
dgs-6600:2>
```

Displaying OSPF Neighbor Information

Use the following command to display information about the OSPF neighbors:

Command	Explanation
<code>show ip ospf neighbor [interface <i>INTERFACE-ID</i> neighbor <i>NEIGHBOR-ID</i>] [detail]</code>	Displays information about the OSPF neighbors.

In the following example, the user displays information about all the OSPF neighbors:

```
dgs-6600:2>show ip ospf neighbor

Neighbor ID      Pri   State             Dead Time   Address        Interface
10.47.65.81     1     Full/BDR          00:00:34   47.65.50.1    vlan50
10.47.65.83     1     Full/DR           00:00:34   47.65.51.2    vlan51
10.47.65.83     1     Full/ -           00:00:36   47.65.51.2    VLINK0
dgs-6600:2>
```

In the following example, the user displays the OSPF neighbor information for VLAN 50:

```
dgs-6600:2>show ip ospf neighbor interface vlan50

Neighbor ID      Pri   State             Dead Time   Address        Interface
10.47.65.81     1     Full/BDR          00:00:39   47.65.50.1    vlan50
dgs-6600:2>
```

In the following example, the user displays detailed information about the OSPF neighbors:

```
dgs-6600:2>show ip ospf neighbor detail
Neighbor 10.47.65.81, interface address 47.65.50.1
  In the area 0.0.0.0 via interface vlan50
  Neighbor priority is 1, State is Full, 6 state changes
  DR is 47.65.50.2, BDR is 47.65.50.1
  Options is 0x42 (*|O|-|-|-|E|-)
  Dead timer due in 00:00:39
  Neighbor is up for 02:25:15
  Crypt Sequence Number is 0

Neighbor 10.47.65.83, interface address 47.65.51.2
  In the area 0.0.0.1 via interface vlan51
  Neighbor priority is 1, State is Full, 6 state changes
  DR is 47.65.51.2, BDR is 47.65.51.1
  Options is 0x42 (*|O|-|-|-|E|-)
  Dead timer due in 00:00:31
  Neighbor is up for 02:25:15
  Crypt Sequence Number is 0

Neighbor 10.47.65.83, interface address 47.65.51.2
  In the area 0.0.0.0 via interface VLINK0
  Neighbor priority is 1, State is Full, 5 state changes
  DR is 0.0.0.0, BDR is 0.0.0.0
  Options is 0x42 (*|O|-|-|-|E|-)
  Dead timer due in 00:00:31
  Neighbor is up for 02:24:29
  Crypt Sequence Number is 0

dgs-6600:2>
```

Displaying OSPF Virtual Link Information

Use the following command to display information on the OSPF virtual links:

Command	Explanation
show ip ospf virtual-links	Displays information on the OSPF virtual links.

In the following example, the user displays the information for the OSPF virtual links:

```
dgs-6600:2>show ip ospf virtual-links
Virtual Link  to router 10.47.65.83 is up
  Transit area 0.0.0.1 via interface vlan51
  Local address 47.65.51.1/32
  Remote address 47.65.51.2/32
  Transmit Delay is 1 sec, State Point-To-Point,
  Timer intervals configured, Hello 10, Dead 40, Retransmit 5
  Hello due in 00:00:08
  Adjacency state Full
  Current Authentication Type: none
dgs-6600:2>
```

Displaying the OSPF LSA Database

Use the following commands to display information about the OSPF LSA database:

Command	Explanation
<code>show ip ospf database [IFNAME]</code>	Displays a summary of the OSPF database information.
<code>show ip ospf database asbr-summary [LINK-STATE-ID self-originate adv-router IP-ADDRESS]</code>	Displays a summary of the Autonomous System Boundary Router (ASBR) information.
<code>show ip ospf database external [LINK-STATE-ID self-originate adv-router IP-ADDRESS]</code>	Displays information about the external LSAs.
<code>show ip ospf database network [LINK-STATE-ID self-originate adv-router IP-ADDRESS]</code>	Displays information about the network LSAs.
<code>show ip ospf database nssa-external [LINK-STATE-ID self-originate adv-router IP-ADDRESS]</code>	Displays information about the NSSA-external LSAs.
<code>show ip ospf database router [LINK-STATE-ID self-originate adv-router IP-ADDRESS]</code>	Displays information about the router LSAs.
<code>show ip ospf database summary [LINK-STATE-ID self-originate adv-router IP-ADDRESS]</code>	Displays information about the summary LSAs.

In the following example, the user displays a summary of the OSPF database information:

```
dgs-6600:2>show ip ospf database
```

```
Router Link States (Area 0.0.0.0)
```

Link ID	ADV Router	Age	Seq#	CkSum	Link count
10.47.65.81	10.47.65.81	5	0x66040008	0x6aff	1
10.47.65.82	10.47.65.82	1790	0x6604000b	0x6f71	2
10.47.65.83	10.47.65.83	1774	0x66040007	0x98a3	1

```
Net Link States (Area 0.0.0.0)
```

Link ID	ADV Router	Age	Seq#	CkSum
47.65.50.2	10.47.65.82	29	0x66040006	0xe565

```
Summary Link States (Area 0.0.0.0)
```

Link ID	ADV Router	Age	Seq#	CkSum	Route
47.65.51.0	10.47.65.82	39	0x66040006	0x39ad	47.65.51.0/24
47.65.51.0	10.47.65.83	1784	0x66040005	0x35b1	47.65.51.0/24
47.65.151.0	10.47.65.83	13	0x66040006	0xe29e	47.65.151.0/24

```
Router Link States (Area 0.0.0.1)
```

Link ID	ADV Router	Age	Seq#	CkSum	Link count
10.47.65.82	10.47.65.82	1780	0x66040009	0x77ea	1
10.47.65.83	10.47.65.83	1784	0x66040009	0x75e9	1

```
Net Link States (Area 0.0.0.1)
```

Link ID	ADV Router	Age	Seq#	CkSum
47.65.51.2	10.47.65.83	23	0x66040006	0xec5a

```
Summary Link States (Area 0.0.0.1)
```

Link ID	ADV Router	Age	Seq#	CkSum	Route
47.65.50.0	10.47.65.82	49	0x66040006	0x44a3	47.65.50.0/24
47.65.151.0	10.47.65.83	73	0x66040006	0xe29e	47.65.151.0/24

```
ASBR-Summary Link States (Area 0.0.0.1)
```

Link ID	ADV Router	Age	Seq#	CkSum
10.47.65.81	10.47.65.82	1760	0x66040006	0x1f9e

```
AS External Link States
```

Link ID	ADV Router	Age	Seq#	CkSum	Route	Tag
125.1.1.0	10.47.65.81	55	0x66040006	0xe799	E2 125.1.1.0/24	0

```
dgs-6600:2>
```

In the following example, the user displays a summary of the ASBR information:

```
dgs-6600:2>show ip ospf database asbr-summary

                ASBR-Summary Link States (Area 0.0.0.1)

LS age: 1083
Options: 0x2 (*|-|-|-|-|E|-)
LS Type: ASBR-summary-LSA
Link State ID: 10.47.65.81 (AS Boundary Router address)
Advertising Router: 10.47.65.82
LS Seq Number: 66040007
Checksum: 0x1d9f
Length: 28
Network Mask: /0
            TOS: 0  Metric: 1

dgs-6600:2>
```

In the following example, the user displays information about the external LSAs:

```
dgs-6600:2>show ip ospf database external

                AS External Link States

LS age: 1253
Options: 0x2 (*|-|-|-|-|E|-)
LS Type: AS-external-LSA
Link State ID: 125.1.1.0 (External Network Number)
Advertising Router: 10.47.65.81
LS Seq Number: 66040006
Checksum: 0xe799
Length: 36
Network Mask: /24
            Metric Type: 2 (Larger than any link state path)
            TOS: 0
            Metric: 1
            Forward Address: 0.0.0.0
            External Route Tag: 0

dgs-6600:2>
```

In the following example, the user displays information about all the network LSAs:

```
dgs-6600:2>show ip ospf database network

                Net Link States (Area 0.0.0.0)

LS age: 1012
Options: 0x2 (*|-|-|-|-|E|-)
LS Type: network-LSA
Link State ID: 47.65.50.2 (address of Designated Router)
Advertising Router: 10.47.65.82
LS Seq Number: 66040006
Checksum: 0xe565
Length: 32
Network Mask: /24
    Attached Router: 10.47.65.82
    Attached Router: 10.47.65.81

                Net Link States (Area 0.0.0.1)

LS age: 1006
Options: 0x2 (*|-|-|-|-|E|-)
LS Type: network-LSA
Link State ID: 47.65.51.2 (address of Designated Router)
Advertising Router: 10.47.65.83
LS Seq Number: 66040006
Checksum: 0xec5a
Length: 32
Network Mask: /24
    Attached Router: 10.47.65.83
    Attached Router: 10.47.65.82

dgs-6600:2>
```

In the following example, the user displays information about the NSSA-external LSAs:

```
dgs-6600:2>show ip ospf database nssa-external

                NSSA-external Link States (Area 0.0.0.1 [NSSA])

LS age: 1584
Options: 0x0 (*|-|-|-|-|-|-|-)
LS Type: AS-NSSA-LSA
Link State ID: 125.1.1.0 (External Network Number For NSSA)
Advertising Router: 10.47.65.81
LS Seq Number: 66040008
Checksum: 0xa337
Length: 36
Network Mask: /24
    Metric Type: 2 (Larger than any link state path)
    TOS: 0
    Metric: 1
    NSSA: Forward Address: 47.65.51.1
    External Route Tag: 0

dgs-6600:2>
```

In the following example, the user displays the LSA information for the router with the IP address "10.47.65.82":

```
dgs-6600:2>show ip ospf database router 10.47.65.82

Router Link States (Area 0.0.0.0)

LS age: 684
Options: 0x2 (*|-|-|-|-|E|-)
Flags: 0x1 : ABR
LS Type: router-LSA
Link State ID: 10.47.65.82
Advertising Router: 10.47.65.82
LS Seq Number: 6604000c
Checksum: 0x6d72
Length: 48
Number of Links: 2

Link connected to: a Transit Network
(Link ID) Designated Router address: 47.65.50.2
(Link Data) Router Interface address: 47.65.50.2
Number of TOS metrics: 0
TOS 0 Metric: 1

Link connected to: a Virtual Link
(Link ID) Neighboring Router ID: 10.47.65.83
(Link Data) Router Interface address: 47.65.51.1
Number of TOS metrics: 0
TOS 0 Metric: 1

Router Link States (Area 0.0.0.1)

LS age: 664
Options: 0x2 (*|-|-|-|-|E|-)
Flags: 0x5 : ABR VL-endpoint
LS Type: router-LSA
Link State ID: 10.47.65.82
Advertising Router: 10.47.65.82
LS Seq Number: 6604000a
Checksum: 0x75eb
Length: 36
Number of Links: 1

Link connected to: a Transit Network
(Link ID) Designated Router address: 47.65.51.2
(Link Data) Router Interface address: 47.65.51.1
Number of TOS metrics: 0
TOS 0 Metric: 1

dgs-6600:2>
```

In the following example, the user displays information about all the summary LSAs on the Switch:

```
dgs-6600:2>show ip ospf database summary

                Summary Link States (Area 0.0.0.0)

LS age: 319
Options: 0x2 (*|-|-|-|-|E|-)
LS Type: summary-LSA
Link State ID: 47.65.51.0 (summary Network Number)
Advertising Router: 10.47.65.82
LS Seq Number: 66040006
Checksum: 0x39ad
Length: 28
Network Mask: /24
        TOS: 0  Metric: 1

LS age: 263
Options: 0x2 (*|-|-|-|-|E|-)
LS Type: summary-LSA
Link State ID: 47.65.51.0 (summary Network Number)
Advertising Router: 10.47.65.83
LS Seq Number: 66040006
Checksum: 0x33b2
Length: 28
Network Mask: /24
        TOS: 0  Metric: 1

LS age: 293
Options: 0x2 (*|-|-|-|-|E|-)
LS Type: summary-LSA
Link State ID: 47.65.151.0 (summary Network Number)
Advertising Router: 10.47.65.83
LS Seq Number: 66040006
Checksum: 0xe29e
Length: 28
Network Mask: /24
        TOS: 0  Metric: 1

dgs-6600:2>
```

Restarting OSPF

Use the following command to restart or shutdown the OSPF process:

Command	Explanation
<code>clear ip ospf</code>	Restarts the specified OSPF process(es).
<code>ip ospf shutdown [INTERFACE-ID]</code>	Initiates an OSPF graceful shutdown for the entire OSPF process or for a specific OSPF process on a VLAN interface.

In the following example, the user restarts all of the OSPF processes that are running on the Switch:

```
dgs-6600:2>enable
dgs-6600:15#clear ip ospf
```

In the following example, the user initiates an OSPF protocol graceful shutdown on VLAN interface 5:

```
dgs-6600:2>enable
dgs-6600:15#configure terminal
dgs-6600:15 (config) #router ospf
dgs-6600:15 (config-router) #ip ospf shutdown vlan5
dgs-6600:15 (config-router) #end
```

Configuration Examples

OSPFv2 Configuration (Basic) Example

Configure OSPF (v2) protocol in R1 and R2. The routing entries can be learned by OSPF protocol. R2, routes 5.0.0.0/8 and 6.0.0.0/8 and R1 routes: 2.0.0.0/8 and 3.0.0.0/8 can be learned dynamically by OSPF protocol. All PCs in the topology can communicate (e.g., PING) each other by routing.

Topology

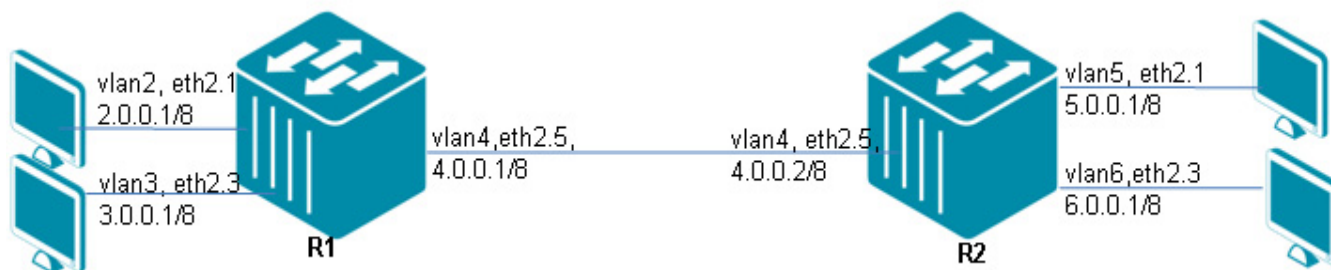

Figure 23-1 OSPFv2 Configuration Example Topology

R1 (Router1) Configuration Steps

Step 1: create vlan 2,3,4

```
DGS-6600:15 (config) #vlan 2
DGS-6600:15 (config-vlan) #vlan 3
DGS-6600:15 (config-vlan) #vlan 4
```

Step 2: add port into vlan

```
DGS-6600:15(config-vlan)#interface eth2.1
DGS-6600:15(config-if)# access vlan 2
DGS-6600:15(config-if)#interface eth2.3
DGS-6600:15(config-if)# access vlan 3
DGS-6600:15(config-if)#interface eth2.5
DGS-6600:15(config-if)# access vlan 4
```

Step 3: configure IP address of vlan

```
DGS-6600:15(config-if)#interface vlan2
DGS-6600:15(config-if)# ip address 2.0.0.1/8
DGS-6600:15(config-if)#interface vlan3
DGS-6600:15(config-if)# ip address 3.0.0.1/8
DGS-6600:15(config-if)#interface vlan4
DGS-6600:15(config-if)# ip address 4.0.0.1/8
```

Step 4: set OSPF

```
DGS-6600:15(config-if)#router ospf
DGS-6600:15(config-router)# network 2.0.0.0/8 area 0
DGS-6600:15(config-router)# network 3.0.0.0/8 area 0
DGS-6600:15(config-router)# network 4.0.0.0/8 area 0
```

R2 (Router 2) Configuration Steps**Step 1: create vlan 4,5,6**

```
DGS-6600:15(config)#vlan 4
DGS-6600:15(config-vlan)#vlan 5
DGS-6600:15(config-vlan)#vlan 6
```

Step 2: add port into vlan

```
DGS-6600:15(config-vlan)#interface eth2.1
DGS-6600:15(config-if)# access vlan 5
DGS-6600:15(config-if)#interface eth2.3
DGS-6600:15(config-if)# access vlan 6
DGS-6600:15(config-if)#interface eth2.5
DGS-6600:15(config-if)# access vlan 4
```

Step 3: configure IP address of vlan

```
DGS-6600:15(config-if)#interface vlan4
DGS-6600:15(config-if)# ip address 4.0.0.2/8
DGS-6600:15(config-if)#interface vlan5
DGS-6600:15(config-if)# ip address 5.0.0.1/8
DGS-6600:15(config-if)#interface vlan6
DGS-6600:15(config-if)# ip address 6.0.0.1/8
```

Step 4: set OSPF

```
DGS-6600:15(config-if)#router ospf
DGS-6600:15(config-router)# network 4.0.0.0/8 area 0
DGS-6600:15(config-router)# network 5.0.0.0/8 area 0
DGS-6600:15(config-router)# network 6.0.0.0/8 area 0
```

Verifying The Configuration

Step 1: Use the following command to check the configuration. This command can be used to check both R1 and R2.

```
DGS-6600:15#show ip route
Codes: K - kernel, C - connected, S - static, R - RIP, B - BGP
       O - OSPF, IA - OSPF inter area
       N1 - OSPF NSSA external type 1, N2 - OSPF NSSA external type 2
       E1 - OSPF external type 1, E2 - OSPF external type 2
       i - IS-IS, L1 - IS-IS level-1, L2 - IS-IS level-2, ia - IS-IS inter area
       # - A number of slots are inactive
       * - candidate default

C       2.0.0.0/8 is directly connected, vlan2
C       3.0.0.0/8 is directly connected, vlan3
C       4.0.0.0/8 is directly connected, vlan4
O       5.0.0.0/8 [110/2] via 4.0.0.2, vlan4, ODT0H3M56S
O       6.0.0.0/8 [110/2] via 4.0.0.2, vlan4, ODT0H3M56S

Total Entries: 5 entries, 5 routes
```

```
DGS-6600:15#show ip route
Codes: K - kernel, C - connected, S - static, R - RIP, B - BGP
       O - OSPF, IA - OSPF inter area
       N1 - OSPF NSSA external type 1, N2 - OSPF NSSA external type 2
       E1 - OSPF external type 1, E2 - OSPF external type 2
       i - IS-IS, L1 - IS-IS level-1, L2 - IS-IS level-2, ia - IS-IS inter area
       # - A number of slots are inactive
       * - candidate default

O       2.0.0.0/8 [110/2] via 4.0.0.1, vlan4, ODT0H2M21S
O       3.0.0.0/8 [110/2] via 4.0.0.1, vlan4, ODT0H2M21S
C       4.0.0.0/8 is directly connected, vlan4
C       5.0.0.0/8 is directly connected, vlan5
C       6.0.0.0/8 is directly connected, vlan6
```

OSPFv2 Configuration Example 2

This OSPF configuration example contains three areas, virtual Link, NSSA, and external AS.

Topology

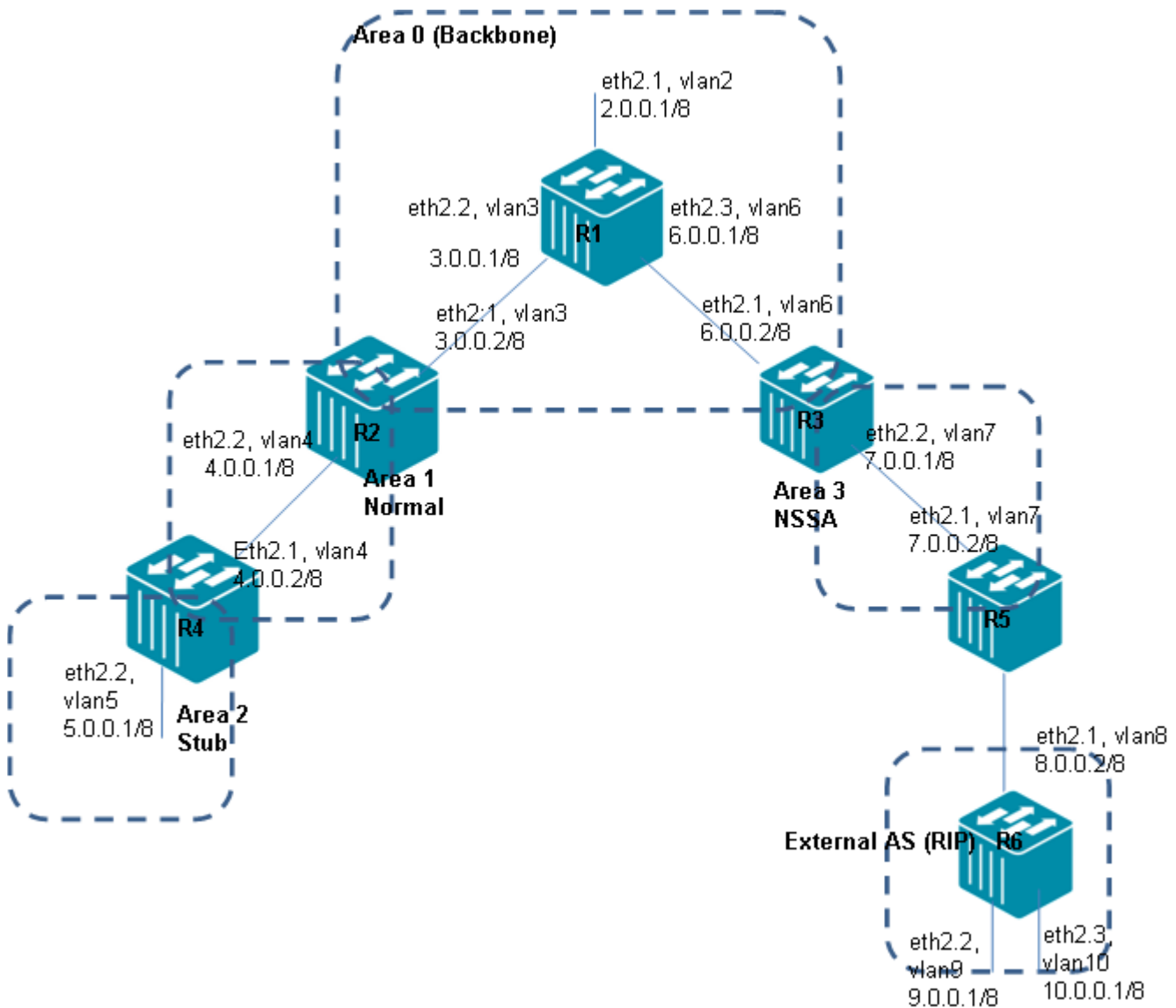

Figure 23-2 OSPFv2 Configuration Topology for Example 2

R1 (Router 1) Configuration Steps

Step 1: Step1. create vlan 2,3,6

```
DGS-6600:15(config)#vlan 2
DGS-6600:15(config-vlan)#vlan 3
DGS-6600:15(config-vlan)#vlan 6
```

Step 2: add port into vlan

```
GS-6600:15(config-vlan)#interface eth2.1
DGS-6600:15(config-if)# access vlan 2
DGS-6600:15(config-if)#interface eth2.2
DGS-6600:15(config-if)# access vlan 3
DGS-6600:15(config-if)#interface eth2.3
DGS-6600:15(config-if)# access vlan 6
```

Step 3: configure IP address of VLAN

```
DGS-6600:15(config-if)#interface vlan2
DGS-6600:15(config-if)# ip address 2.0.0.1/8
DGS-6600:15(config-if)#interface vlan3
DGS-6600:15(config-if)# ip address 3.0.0.1/8
DGS-6600:15(config-if)#interface vlan6
DGS-6600:15(config-if)# ip address 6.0.0.1/8
```

Step 4: set OSPF

```
DGS-6600:15(config-if)#router ospf
DGS-6600:15(config-router)# network 2.0.0.0/8 area 0
DGS-6600:15(config-router)# network 3.0.0.0/8 area 0
DGS-6600:15(config-router)# network 6.0.0.0/8 area 0
```

R2 (Router 2) Configuration Steps**Step 1: create vlan 3,4**

```
DGS-6600:15(config)#vlan 3
DGS-6600:15(config-vlan)#vlan 4
```

Step 2: add port into vlan

```
DGS-6600:15(config-vlan)#interface eth2.1
DGS-6600:15(config-if)# access vlan 3
DGS-6600:15(config-if)#interface eth2.2
DGS-6600:15(config-if)# access vlan 4
```

Step 3: configure IP address of VLAN

```
DGS-6600:15(config-if)#interface vlan3
DGS-6600:15(config-if)# ip address 3.0.0.2/8
DGS-6600:15(config-if)#interface vlan4
DGS-6600:15(config-if)# ip address 4.0.0.1/8
```

Step 4: set OSPF

```
DGS-6600:15(config-if)#router ospf
DGS-6600:15(config-router)# network 3.0.0.0/8 area 0
DGS-6600:15(config-router)# network 4.0.0.0/8 area 1
DGS-6600:15(config-router)# area 1 virtual-link 5.0.0.1
```

R3 (Router 3) Configuration Steps

Step 1: create vlan 6,7

```
DGS-6600:15(config)#vlan 6
DGS-6600:15(config-vlan)#vlan 7
```

Step 2: add port into vlan

```
DGS-6600:15(config-vlan)#interface eth2.1
DGS-6600:15(config-if)# access vlan 6
DGS-6600:15(config-if)#interface eth2.2
DGS-6600:15(config-if)# access vlan 7
```

Step 3: configure IP address of VLAN

```
DGS-6600:15(config-if)#interface vlan6
DGS-6600:15(config-if)# ip address 6.0.0.2/8
DGS-6600:15(config-if)#interface vlan7
DGS-6600:15(config-if)# ip address 7.0.0.1/8
```

Step 4: set OSPF

```
DGS-6600:15(config-if)#router ospf
DGS-6600:15(config-router)# area 3 nssa no-redistribution default-information-
originate
DGS-6600:15(config-router)# network 6.0.0.0/8 area 0
DGS-6600:15(config-router)# network 7.0.0.0/8 area 3
```

R4 (Router 4) Configuration Steps

Step 1: create vlan 4, 5

```
DGS-6600:15(config)#vlan 4
DGS-6600:15(config-vlan)#vlan 5
```

Step 2: add port into vlan

```
DGS-6600:15(config-vlan)#interface eth2.1
DGS-6600:15(config-if)# access vlan 4
DGS-6600:15(config-if)#interface eth2.2
DGS-6600:15(config-if)# access vlan 5
```

Step 3: configure IP address of VLAN

```
DGS-6600:15(config-if)#interface vlan4
DGS-6600:15(config-if)# ip address 4.0.0.2/8
DGS-6600:15(config-if)#interface vlan5
DGS-6600:15(config-if)# ip address 5.0.0.1/8
```

Step 4: set OSPF

```
DGS-6600:15(config-if)#router ospf
DGS-6600:15(config-router)# network 4.0.0.0/8 area 1
DGS-6600:15(config-router)# network 5.0.0.0/8 area 2
DGS-6600:15(config-router)# area 1 virtual-link 4.0.0.1
DGS-6600:15(config-router)# area 2 stub
```

R5 (Router 5) Configuration Steps**Step 1: create vlan 7, 8**

```
DGS-6600:15(config)#vlan 7
DGS-6600:15(config-vlan)#vlan 8
```

Step 2: add port into vlan

```
DGS-6600:15(config-vlan)#interface eth2.1
DGS-6600:15(config-if)# access vlan 7
DGS-6600:15(config-if)#interface eth2.2
DGS-6600:15(config-if)# access vlan 8
```

Step 3: configure IP address of VLAN

```
DGS-6600:15(config-if)#interface vlan7
DGS-6600:15(config-if)# ip address 7.0.0.2/8
DGS-6600:15(config-if)#interface vlan8
DGS-6600:15(config-if)# ip address 8.0.0.1/8
```

Step 4: set OSPF

```
DGS-6600:15(config-if)#router ospf
DGS-6600:15(config-router)#redistribute rip
DGS-6600:15(config-router)#area 3 nssa
DGS-6600:15(config-router)# network 7.0.0.0/8 area 3
```

Step 5: set RIP

```
DGS-6600:15(config-router)#router rip
DGS-6600:15(config-router)#network 8.0.0.1/8
```

R6 (Router 6) Configuration Steps

Step 1: create vlan 8

```
DGS-6600:15(config)#vlan 8
```

Step 2: add port into vlan

```
DGS-6600:15(config-vlan)#interface eth2.1  
DGS-6600:15(config-if)# access vlan 8
```

Step 3: configure IP address of VLAN

```
DGS-6600:15(config-if)#interface vlan8  
DGS-6600:15(config-if)# ip address 8.0.0.2/8
```

Step 4: set RIP

```
DGS-6600:15(config-if)#router rip  
DGS-6600:15(config-router)# network 8.0.0.2/8
```

Verifying The Configuration

Use "show ip route" command to check if the routing table can be correctly learned.

List of Constants and Default Settings

Constant Name	Value
Number of Supported MD5 Keys per Interface	255
Number of Supported OSPF Areas	16
Number of Supported OSPF Host Routes	64
Number of Supported OSPF Virtual Links	16
Number of Supported OSPF Neighbors	32
Maximum OSPF Link State Database Table Size	12288*2
Multicast Address for All OSPF Routers	224.0.0.5
Multicast Address for OSPF DR/BDR Router	224.0.0.6

Table 23-1 Constants Values

Variable Name	Default Value
OSPF Status	Disabled
Area Default Cost	1
Default Metric	20
IP OSPF Authentication	No Authentication
IP OSPF Authentication Mode	Plain-Text
Auto-Cost Reference Bandwidth	100 Mbps
IP OSPF Cost	Auto
IP OSPF Dead Interval	40 Seconds
IP OSPF Hello Interval	10 Seconds
IP OSPF Retransmit Interval	5 Seconds
IP OSPF Transmit Delay	1 Second
IP OSPF Priority	1
Router ID	Largest Configured Interface IP Address
IP OSPF Shutdown Interface	No Shutdown
Area Stub Configuration	Non-Stub
Default Summary Route Cost	1

Table 23-2 Default Variable Values

Chapter 24

ECMP

Chapter Overview

The following topics are included in this chapter, please go to the topic for more detailed information:

- [Chapter Overview](#)
- [An Introduction to ECMP](#)
- [ECMP Overview](#)
- [Configuring ECMP](#)

An Introduction to ECMP

Equal-cost multipath (ECMP) is a technique for routing packets along multiple paths of equal cost. If multiple equal-cost routes to the same destination exist, ECMP can be used to provide load balancing among the redundant paths. Since the forwarding logic has several next hops for any given destination, it must use some method to choose which next hop should be used for a given data packet. The ECMP support that allows the packet to be forwarded along one of 32 paths based on a CRC32 hashing of the following combinations:

SIP

SIP, DIP

SIP, Port

SIP, DIP, Port

Use this tool to calculate the ECMP route load-balancing path. The algorithm may take some bits from source IP address directly. Or take some bits from a CRC32 calculation result which bases on source IP address and, optionally, the destination IP address or TCP/UDP port. User can use the tool to get which one is the selected path. If the return values are the same, it means the pattern switched over the same path.

ECMP Overview

The ECMP algorithm tool is built into the runtime firmware in the DGS-6600 switch. Use the command to calculation the result of ecmp algorithm path. This command is a hidden command, but, it can be executed in EXEC mode with privilege admin user (15) rights.

Configuring ECMP

Use the command to configure the ECMP route load-balancing algorithm. The algorithm may take some bits from source IP address directly. Or take some bits from a CRC32 calculation result which bases on source IP address and, optionally, the destination address of TCP/UDP port. Use the no form of the command to reset to the default setting. Use the no command to remove the ecmp load-balance configuration. Then the ecmp load-balance will go back to default.

Command	Explanation
<code>ip route ecmp load-balance [{crc32-lower crc32-upper} [dip] [port]]</code>	The source IP address is always the calculation base. The ip route ecmp load-balance command is setup for the whole system. Users can use the show ip route ecmp load-balance command to display the ECMP setting. The ip route ecmp load-balance command without any parameters will only use the load-balance algorithm with the least significant number of bits in the IP address without CRC32 calculation.
<code>no ip route ecmp load-balance</code>	Use the no form of this command to disable ecmp.

This example shows how to set the ecmp algorithm to use the lower few bits if source IP address only:

```
DGS-6600#configure terminal
DGS-6600(config)#ip route ecmp load-balance
```

This example shows how to set the ecmp algorithm to use the upper few bits of CRC32 result which bases on the source IP and destination IP addresses:

```
DGS-6600#configure terminal
DGS6600(config)#ip route ecmp load-balance crc32-upper dip
```

Chapter 25

IPv6 Basics

Chapter Overview

The following topics are included in this chapter, please go to the topic for more detailed information:

- [Chapter Overview](#)
- [An introduction to Internet Protocol Version 6 \(IPv6\) Basics](#)
 - [Router Discovery & Automatic Parameter Configuration](#)
- [IPv6 Configuration Commands](#)
 - [Creating an IPv6 interface](#)
 - [IPv6 Enable.](#)
 - [Displaying IPv6 information](#)

An introduction to Internet Protocol Version 6 (IPv6) Basics

While Internet Protocol Version (IPv4) is the most popular protocol in use today, Internet Protocol Version 6 (IPv6) is a (relatively) new internet protocol standard designed to address the main issue surrounding addressing problems. IPv6 moves away from 32-bit addressing to a 128-bit addressing method. IPv6 also provides a simplified header format, flow labeling, authentication, privacy and newer unicast / broadcast methods. Some of the benefits of IPv6 seem obvious: greater addressing space, built-in Qos, and better routing performance and service.

An IPv6 address can be assigned either manually or automatically. The automatic configuration of an IPv6 address can be either stateless or stateful. A stateless address refers to address configuration based on a prefix passed from the router. A stateful address is an address that is obtained from the DHCPv6 server. This configuration guide will focus only on stateless addresses.

The core function of IPv6 that are commonly used include: resolving the link layer address of the neighbor node, maintaining the reach-ability of the neighbor node, and detecting duplicate addresses when an address is configured.

The core element of IPv6 functionality is the NDP protocol, it's purpose is to allow the IPv6 node to establish IPv6 connectivity.

The IPv6 core functionality on a host device includes obtaining prefix information from router for auto-configuring of an IP address, obtaining configuration parameters from routers, learning of default routers and establishing IPv6 communication with other nodes.

In comparison IPv6 core functionality on is the automatic configuration, on the host side, for the obtention of prefix information from routers for auto-configuration of an IP address, obtention of configuration parameters from routers, learning of default routers and the establishment of IPv6 communication with other nodes.

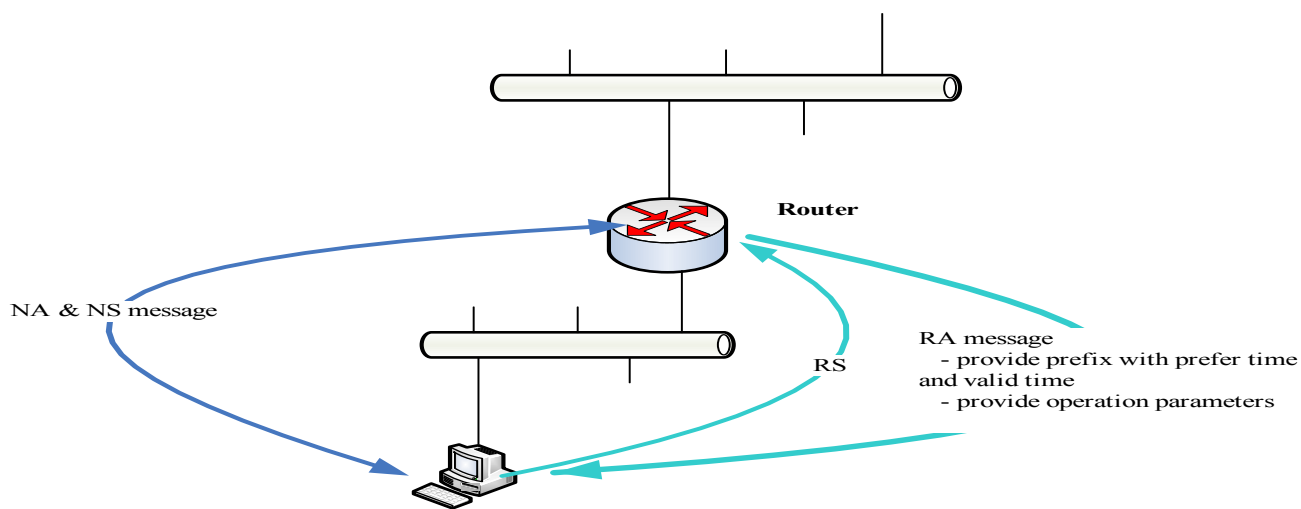

Figure 25-1

Router Discovery & Automatic Parameter Configuration

In IPv4 a default router is normally manually configured. In IPv6 the default router on the host’s side will be automatically learned. The router constantly sends out an RA message. The host will learn the router when it receives the RA. To speed up the discovery process, the host can send out the RS message and wait for the immediate RA message response from the router. Normally the host will send out an RS message whenever an IP interface comes up.

From the RA message, the host also automatically configures a variety of configuration parameters. The following describes the purpose of these parameters.

When the host receives RA messages from multiple routers it accepts all received information. However, when received information for a specific parameter (e.g., Link MTU) or an option (e.g., Lifetime on a specific Prefix) differs from information received earlier, and if the parameter/option can only have one value, the most recently received information is considered authoritative.

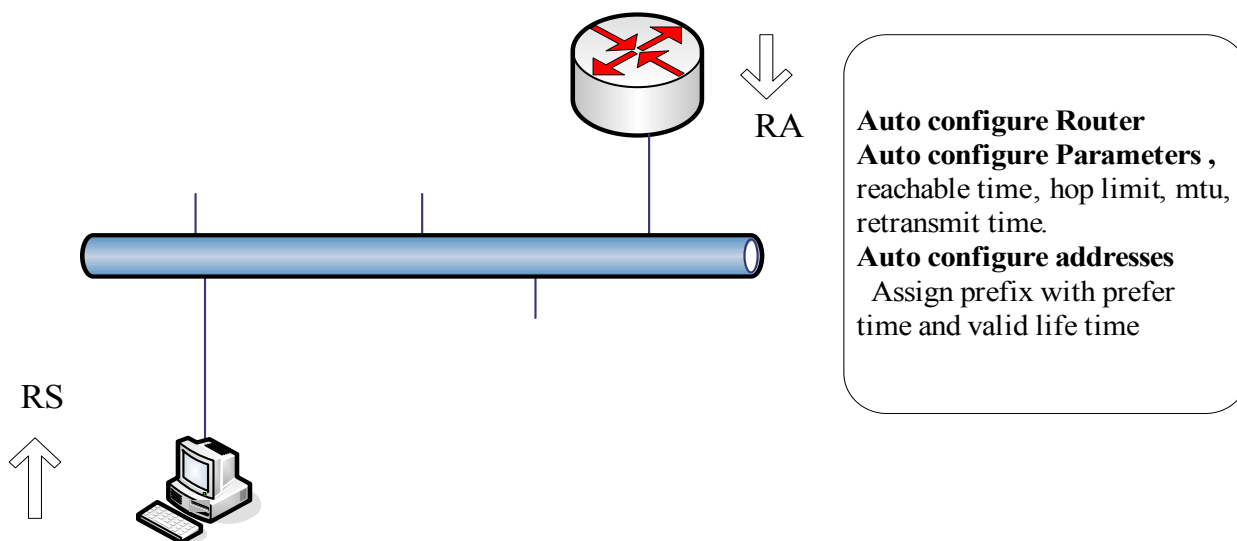

Figure 25-2

Operation parameters from the router	Explanation
Hop Limit.	The hop limit will be used as the initial hop limit for the outgoing IPv6 packet.
Manage Address Configure Flag.	The flag is an indication to the receiving hosts to use stateful address configuration protocol (DHCP) to obtain the address in addition to the address that might be derived from the stateless address auto-configure.
Other Configure Flag.	Instructs the receiving hosts to use DHCP to obtain the non-address information such as: DNS server and domain name.
Router Life Time.	The lifetime is applied only to the router's usefulness as a default router. If lifetime is zero, then the router is not the default router and should not appear in the default router list. The router will be removed from the default list after expiration of the life time.
Reachable Time.	The reachable time is used in a timeout of neighbor cache in REACHABLE state and a move to STALE state.
Retransmit Time.	Interval for retransmitted NS messages and unsolicited NA messages.
MTU.	In IPV4, both the source node and the intermediate node on the routing path are able to fragment the packet. In IPV6, only the source node is able to fragment the packet. The source node fragments a packet if the packet size is longer than the MTU. If the intermediate node receives a packet, but the packet is too big to be forwarded the intermediate node should return the ICMP message, too big error, to the source node; so that the source node can adjust the MTU.

Table 25-1

The following example illustrates the use of specifying MTU in RA. In this example, FDDI default link MTU is 4352. Ethernet link MTU is 1500. The intermediate node is a bridge device, which has no capability to reply ICMP too big error. If the source station send a packet 2000 bytes long, the packet will be dropped by the bridge. To solve this issue, the router can send an RA with MTU 1500 to configure the MTU in host side. The MTU in RA will be ignored if it is larger than link MTU.

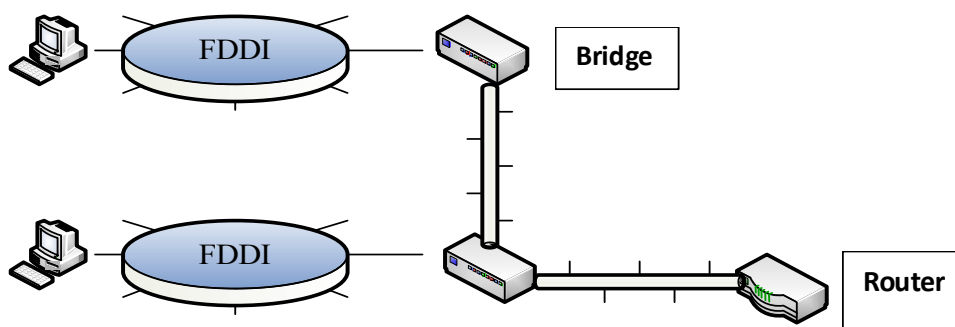

Figure 25-3

IPv6 Configuration Commands

Command	Explanation
<code>ipv6 address X:X::X:X/M</code>	This command is used to assign the IPv6 address to an interface of the switch.
<code>no ipv6 address X:X::X:X/M</code>	The no form of this command deletes the IPv6 address assigned to the interface.
<code>ipv6 hop-limit <0-255></code>	This command is used to configure the IPv6 hop limit setting for an interface of this switch.
<code>no ipv6 hop-limit</code>	The no form of this command resets the IPv6 hop limit to the default value.
<code>ipv6 nd managed-config-flag</code>	This command is used to turn on the IPv6 RA (router advertisement) management configure flag setting on an interface of this switch.
<code>no ipv6 nd managed-config-flag</code>	The no form of this command turns off this flag.
<code>ipv6 nd other-config-flag</code>	This command is used to turn on the IPv6 RA (router advertisement) other configure flag incidence per interface on this switch.
<code>no ipv6 nd other-config-flag</code>	The no form of this command turns off this flag.
<code>ipv6 nd prefix X:X::X:X/M <0-4294967295> <0-4294967295> [off-link no-autoconfig]</code>	This command is used to add or modify IPv6 prefix information to RA (router advertisement) for an interface of this switch. If the prefix already exists, then the command modifies the parameter.
<code>no ipv6 nd prefix</code>	The no form of the command removes it.
<code>ipv6 nd ra-interval <4-1800> [<3-1350>]</code>	This command is used to configure the IPv6 RA (router advertisement) interval timer for an interface of this switch.
<code>no ipv6 nd ra-interval</code>	The no form of this command sets the lifetime to the default value.
<code>ipv6 nd ra-lifetime <0-9000></code>	This command is used to configure the IPv6 RA (router advertisement) lifetime on an interface of this switch.
<code>no ipv6 nd ra-lifetime</code>	The no form of this command sets the lifetime to the default value.
<code>ipv6 nd reachable-time <0-3600000></code>	This command is used to configure IPv6 RA (router advertisement) reachable time on an interface of this switch.
<code>no ipv6 nd reachable-time</code>	The no form of this command sets the reachable time to the default value.
<code>ipv6 nd retrans-timer <0-4294967295></code>	This command is used to configure IPv6 RA (router advertisement) retrans timer per interface on this switch.
<code>no ipv6 nd retrans-timer</code>	The no form of this command sets the retrans timer to the default value.

Table 25-2

Command	Explanation
<code>ipv6 nd suppress-ra</code>	This command is used to suppress IPv6 RA (router advertisement) on an interface of this switch.
<code>no ipv6 nd suppress-ra</code>	Use the <code>no ipv6 nd suppress-ra</code> configuration command to enable the sending of IPv6 router advertisements on an ISATAP tunnel interface.
<code>ipv6 neighbor X:X:X:X IFNAME MAC</code>	This command is used to add a static ipv6 neighbor entry.
<code>no ipv6 neighbor</code>	The no form of this command deletes the IPv6 neighbor entry.

Table 25-2

Creating an IPv6 interface

The interface must be created before used `ipv6 enable` command. When the interface up, **ipv6 enable** will also add link-local address to the interface and vice versa. When global address had existed in the interface and using the "**no ipv6 enable**" command, it will take no effect (link-local address should not be removed).

```
DGS-6600# enable
DGS-6600# configure terminal
DGS-6600(config)# interface vlan1
```

IPv6 Enable.

Command	Explanation
<code>ipv6 enable</code>	This command is used to enable and disable the IPv6 protocol on an interface of the switch.
<code>no ipv6 enable</code>	The no form of this command can disable the IPv6 protocol.

Table 25-3

Please note that the VLAN interface must be created before use.

This example shows how to enable the IPv6 protocol:

```
DGS-6600# enable
DGS-6600# configure terminal
DGS-6600(config) # interface vlan1
DGS-6600(config-if) # ipv6 enable
```

Displaying IPv6 information

Commands	Explanation
<code>show ipv6 interface [IFNAME]</code>	This command is used to display IPv6 interface information.
<code>show ipv6 neighbors</code>	This command is used to display the IPv6 neighbor information.

Table 25-4

This example shows how to display IPv6 interface incidence:

```
DGS-6600# enable
DGS-6600# show ipv6 interface vlan1
vlan1 is down,
IPv6 is disable
link-local address is :
fe80::a01:2ff:fe39:1
global unicast address is :
3ffe:501:ffff:100:a01:2ff:fe39:1/64 (DAD check fail)
MAC Address is 08-01-02-39-00-01
IP MTU is 1500 bytes
IPv6 Hop Limit is 64
ICMP error messages limited to one every 100 milliseconds
ICMP redirects are enabled
ND DAD is enabled, number of DAD attempts: 1
ND reachable time is 30000 milliseconds
ND advertised is sending
ND advertised reachable time is 604151836 milliseconds
ND advertised retransmit interval is 257243264 milliseconds
ND router advertisements are sent between 604143192 to 5 seconds
ND router advertisements live for 54212 seconds
Hosts use stateless autoconfig for addresses.
DGS-6600#
```

The example shows how to display IPv6 neighbor information.

```
DGS6600#enable
DGS6600#show ipv6 neighbors
Codes: # - A number of slots are inactive

IPv6 Address          MAC Address          Interface  Type    Status
fe80::250:baff:fef9:b512  0050.baf9.b512  vlan1     DYNM    STALE
```

Chapter 26

IPv6 Static Route Configuration

Chapter Overview

The following topics are included in this chapter, please go to the topic for more detailed information:

- [An Introduction to IPv6 Static Route Configuration](#)
 - [An Introduction to IPv6 Static Route Configuration](#)
- [IPv6 Static Route Configuration Commands](#)
 - [Static Route with Specific Next Hop](#)
 - [Floating Static Route](#)
 - [Long Prefix Route](#)
- [Configuration Example](#)
- [IPv6 Static Route Configuration Example](#)

An Introduction to IPv6 Static Route Configuration

IPv6 Static route is used for forwarding IPv6 traffic. Users set the destination information for each static route entry on a network device. The destination information includes the expected network prefix, prefix length, and the next-hop associated interface and/or address. Using this information the network device can then forward IP packets to the destination via the expected next-hop network device.

Usually, static routing has a higher priority than dynamically learned routes. This priority can be referred to as a route preference or an administrative distance. The route priority can be configured for management purpose. By using a proper priority configuration, routing entries towards the same destination can form a backup-master relationship.

Provided below is a brief summary of possible configuration combinations to provide different types of IPv6 static route on the DGS-6600:

- Static Route with Specific Next Hop
- Floating Static Route

Each route (either static or dynamic) has its own distance/preference to be used for deciding the priority for registering routing tables. If two or more routes point to the same destination the higher priority (with smaller configured value) ones will be chosen. The default administrative distance of static route is 1.

On the DGS-6600 multiple paths toward the same destination are permitted, if the paths chosen have the same administrative distance allowing the load-balance feature of traffic forwarding. The commands "**ip route multi-path**" and "**maximum-paths**" are both for IPv4 and IPv6 enabling multi-path and to allow management of the maximum number of multi-path.

IPv6 Static Route Configuration Commands

Static Route with Specific Next Hop

When the network prefixes and prefix-length are given with a next hop address on a specific interface for a static route, the system will forward the packets (destined for the configured network) to the next hop address on a specific interface. (The DGS-6600 supports vlan interface with next hop) In this case, the next hop address must be found on the specific interface, so that the designated static route could be registered in the routing table.

The following example shows how to setup a static route on the DGS-6600:

```
DGS6600>enable
DGS6600#configure terminal
DGS6600(config)#ipv6 route 2001:0DB8::/32 vlan 1 fe80::0200:00ff:fe00:a0a0
```

By using this configuration, system will forward the IPv6 traffic destined to the network of 2001:0DB8::/32 via the next hop fe80::0200:00ff:fe00:a0a0 on interface vlan 1. Note that, when the network prefix and prefix length are both zero, the specific static route presents default route in the DGS-6600 for IPv6.

Floating Static Route

When the network prefixes and prefix-length are given with a next hop address on a specific interface for a static route, the system will forward the packets (destined for the configured network) to the next hop address on a specific interface. If an administrative priority is also assigned, the static route may be competed with the same routes that come from other protocols. If the priority of the static route is higher than other ones, it will be active. If the priority of the static route is not higher than other ones, it act as the backup route of the others. In this case, the less number presents the higher priority.

The following example shows how to setup a floating static route on the DGS 6600:

```
DGS6600>enable
DGS6600#configure terminal
DGS6600(config)#ipv6 route 2001:0DB8::/32 vlan 1 fe80::0200:00ff:fe00:a0a0 distance
22
DGS6600(config)#ipv6 route 2001:0DB8::/32 vlan 2 fe80::0200:00ff:fe00:b0b0 distance
11
```

By using this configuration, system will check whether the route to the network of 2001:0DB8::/32 has more than one protocol sources. The system will choose the highest priority one(s) to register into the routing table with the corresponding next hop address. In this case, the static route via fe80::0200:00ff:fe00:b0b0 on vlan 2 will be the master one towards the destination 2001:0DB8::/32.

Long Prefix Route

Because of chip limitation, IPv6 routes with a prefix more than 64 bits cannot be set to H/W routing table by default. When user configure static route with long prefix, the route entry cannot be set to H/W routing table.

Use “ipv6 unicast-routing long-prefix” to support the IPv6 route with prefix longer than 64 bits can configure to FP table. After CMD enable, user can not add static route with long prefix when check FP table full.

In the device, the long prefix route is not enabling. The follow flows are worked after long prefix route be enabled. The basic implement concept is check long prefix in HSL before route entry be added to

H/W. Another implement is when the command enables; it will check all long prefix route entries to add to FP table. Vice versa, the command disable will delete all long prefix entries from FP table.

Configuration Example

IPv6 Static Route Configuration Example

Configure static IPv6 routes in R1 and R2 All PCs in the topology can communicate each other by static routing.

Topology

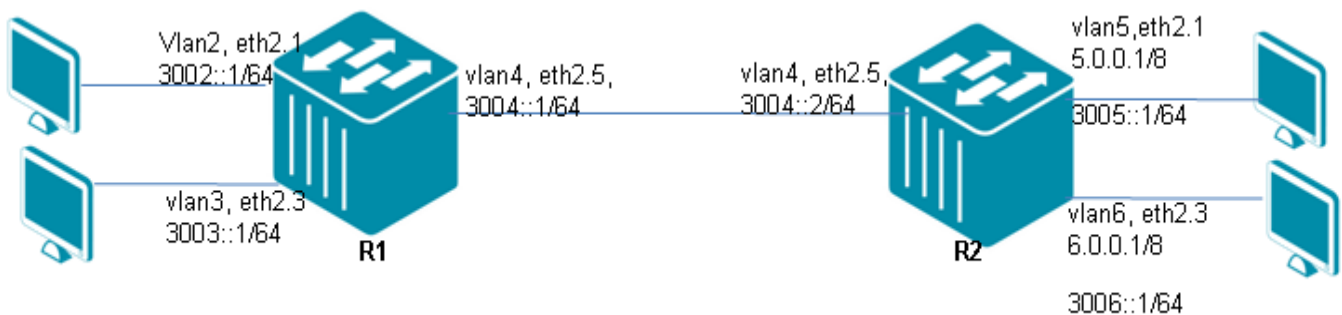

R1 (Router 1) Configuration steps

Step 1: create vlan 2,3,4

```
DGS-6600:15(config)#vlan 2
DGS-6600:15(config-vlan)#vlan 3
DGS-6600:15(config-vlan)#vlan 4
```

Step 2: add port into vlan

```
DGS-6600:15(config-vlan)#interface eth2.1
DGS-6600:15(config-if)# access vlan 2
DGS-6600:15(config-if)#interface eth2.3
DGS-6600:15(config-if)# access vlan 3
DGS-6600:15(config-if)#interface eth2.5
DGS-6600:15(config-if)# access vlan 4
```

Step 3: configure IPv6 address of VLAN

```
DGS-6600:15(config-if)#interface vlan2
DGS-6600:15(config-if)# ipv6 address 3002::1/64
DGS-6600:15(config-if)# ipv6 enable
DGS-6600:15(config-if)#interface vlan3
DGS-6600:15(config-if)# ipv6 address 3003::1/64
DGS-6600:15(config-if)# ipv6 enable
DGS-6600:15(config-if)#interface vlan4
DGS-6600:15(config-if)# ipv6 address 3004::1/64
DGS-6600:15(config-if)# ipv6 enable
```

Step 4: create ipv6 default route

```
DGS-6600:15(config)#ipv6 route 3005::/64 3004::2
DGS-6600:15(config)#ipv6 route 3006::/64 3004::2
```

R2 (Router 2) Configuration Steps**Step 1: create vlan 4,5,6**

```
DGS-6600:15(config)#vlan 4
DGS-6600:15(config-vlan)#vlan 5
DGS-6600:15(config-vlan)#vlan 6
```

Step 2: add port into vlan

```
DGS-6600:15(config-vlan)#interface eth2.1
DGS-6600:15(config-if)# access vlan 5
DGS-6600:15(config-if)#interface eth2.3
DGS-6600:15(config-if)# access vlan 6
DGS-6600:15(config-if)#interface eth2.5
DGS-6600:15(config-if)# access vlan 4
```

Step 3: configure IPv6 address of VLAN

```
DGS-6600:15(config-if)#interface vlan4
DGS-6600:15(config-if)# ipv6 address 3004::2/64
DGS-6600:15(config-if)# ipv6 enable
DGS-6600:15(config-if)#interface vlan5
DGS-6600:15(config-if)# ipv6 address 3005::1/64
DGS-6600:15(config-if)# ipv6 enable
DGS-6600:15(config-if)#interface vlan6
DGS-6600:15(config-if)# ipv6 address 3006::1/64
DGS-6600:15(config-if)# ipv6 enable
```

Step 4: create ipv6 default route

```
DGS-6600:15(config)#ipv6 route 3002::/64 3004::1
DGS-6600:15(config)#ipv6 route 3003::/64 3004::1
```

Verifying The Configuration

Check ipv6 Routing table, using the show ipv6 route command. This can be done for both R1 and R2.

```
DGS-6600:15#show ipv6 route
IPv6 Routing Table
Codes: K - kernel route, C - connected, S - static, R - RIP, O - OSPF,
       I - IS-IS, B - BGP, X - add to ACL table fail
       # - A number of slots are inactive

C   3002::/64 is directly connected, vlan2
C   3003::/64 is directly connected, vlan3
C   3004::/64 is directly connected, vlan4
S   3005::/64 [1/0] via 3004::2
S   3006::/64 [1/0] via 3004::2

Total Entries: 5 entries, 5 routes
```

Chapter 27

Routing Information Protocol Next Generation (RIPng)

Chapter Overview

The following topics are included in this chapter, please go to the topic for more detailed information:

- [Chapter Overview](#)
 - [An Introduction to RIPng](#)
 - [Differences between RIPv2 and RIPng](#)
 - [Architecture](#)
 - [Route Store](#)
 - [Interface Manager](#)
 - [Sockets Manager](#)
 - [Redistribution Manager](#)
 - [Distance-Vector Algorithm](#)
 - [RIPng workflow](#)
 - [Timers](#)
 - [RIPng Configuration Commands](#)
 - [ipv6 router rip](#)
 - [show ipv6 rip interface](#)
 - [show ipv6 protocols](#)
 - [Configuration Examples](#)
 - [RIPng Configuration Example](#)
 - [Limitations](#)

An Introduction to RIPng

Routing Information Protocol (RIP) is a dynamic routing protocol used in local and wide area networks. It is classified as an interior gateway protocol (IGP), and it uses the distance-vector routing algorithm. The protocol has since been extended several times, resulting in RIP Version 2. While both versions are still in use today they have been replaced by more advanced algorithms such as Open Shortest Path First (OSPF) and OSI protocol IS-IS. However, while RIP has been superseded it has been adapted for use in IPv6 networks, using a standard known as RIPng (RIP next generation).

RIPng has been adapted for use in IPv6 networks. It is a routing protocol based on a distance-vector algorithm known as the Bellman-Ford algorithm. Most of the concepts for RIPng have been taken from RIPv1 and RIPv2.

Differences between RIPv2 and RIPng

- RIPng Supports IPv6 networking
- While RIPv2 supports RIPv1 update authentications, RIPng does not. IPv6 routers were designed to support the use IPsec for authentication.

- RIPv2 allows attaching arbitrary tags to routes, RIPng does not.
- RIPv2 encodes the next-hop into each route entries; RIPng requires specific encoding of the next hop for a set of route entries.

Architecture

RIPng routers communicate the sets of destinations they can reach with each other and also the next hop address to which data should be sent in order to reach those destinations. This contrasts with link-state IGPs; vectoring protocols exchange routes with one another, whereas link state routers exchange topology information, and calculate their own routes locally. A vector routing protocol floods reach-ability information throughout all routers participating in the protocol. By flooding reach-ability information, every router has a routing table containing the complete set of destinations known to the participating routers.

The block diagram below shows the architecture of the RIPng stack.

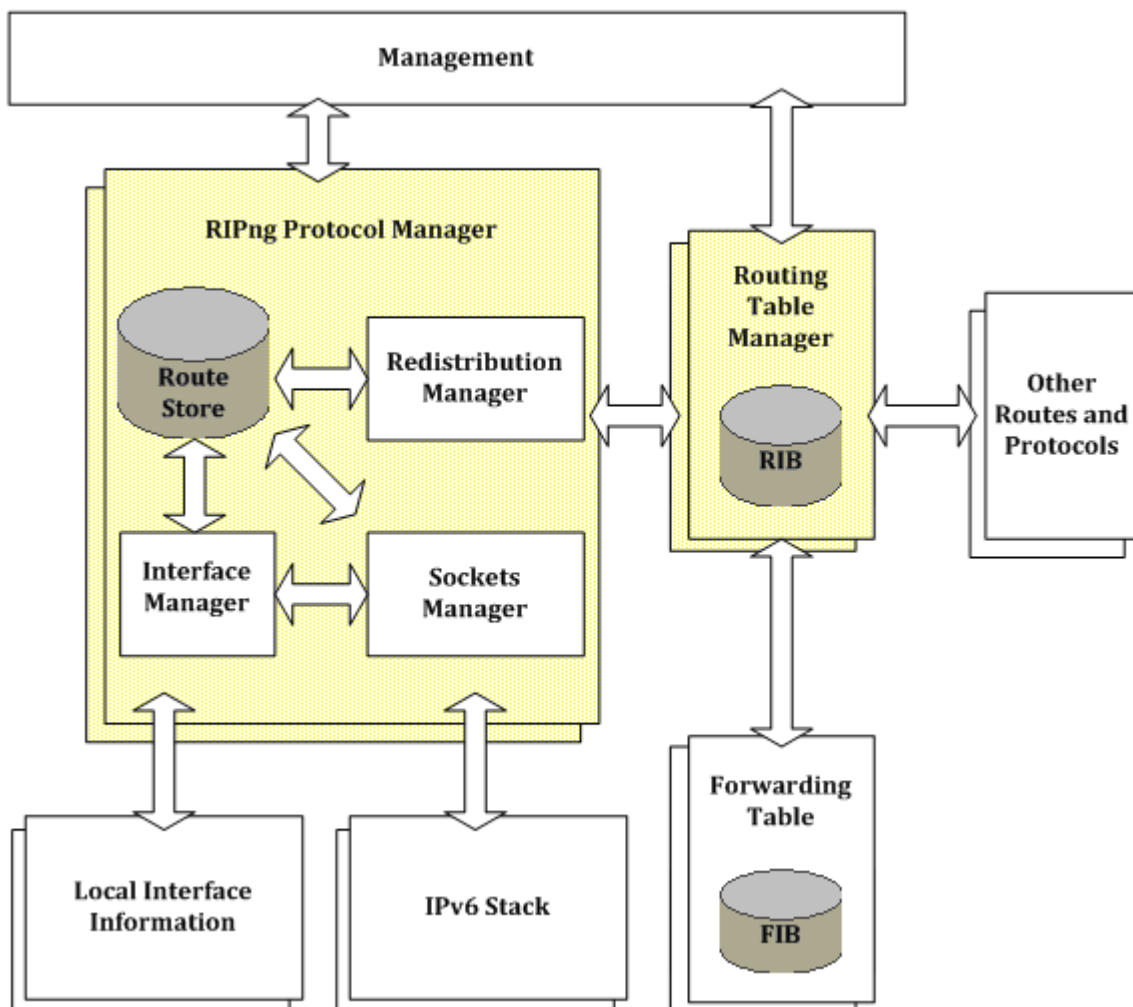

Route Store

- tracks all routes stored
- implements the soft state mechanism for timing out old routes
- calculates the updates needed to keep in synchronization with all changes to active routes
- provides the RIP Route MIB for querying the routes in the RIPng routing table

Interface Manager

- monitors the state of the interfaces and updates routes accordingly
- adds connected routes into the RIP routing table
- provides the Interface Configuration MIB
- records per-interface and per-peer statistics and presents these in the Interface Statistics and Peer MIBs

Sockets Manager

- sends and receives RIPng protocol messages (Requests and Responses)
- adds routes learnt from the RIPng protocol into the routing table
- carries out packet verification
- calls customized functions for applying policy on incoming or outgoing routes
- configures UDP sockets for use

Redistribution Manager

- communicates with one or more instances across the RPI interface, and sends and receives all RPI messages
- adds redistributed routes into the RIP routing table

Distance-Vector Algorithm

RIPng uses a simple mechanism to determine the metric of a route, by counting the number of routers to the destination, each router counts as one hop. Routes with a distance greater than or equal to 16 hops are considered to be unreachable. The router periodically distributes information about its routes to its directly connected neighbors using RIPng response messages. Upon receiving RIPng response messages from its neighbor, the router adds the distance between the neighbor and itself to the metric of each route received. The router then processes the newly received route entry using the Bellman-Ford algorithm (below).

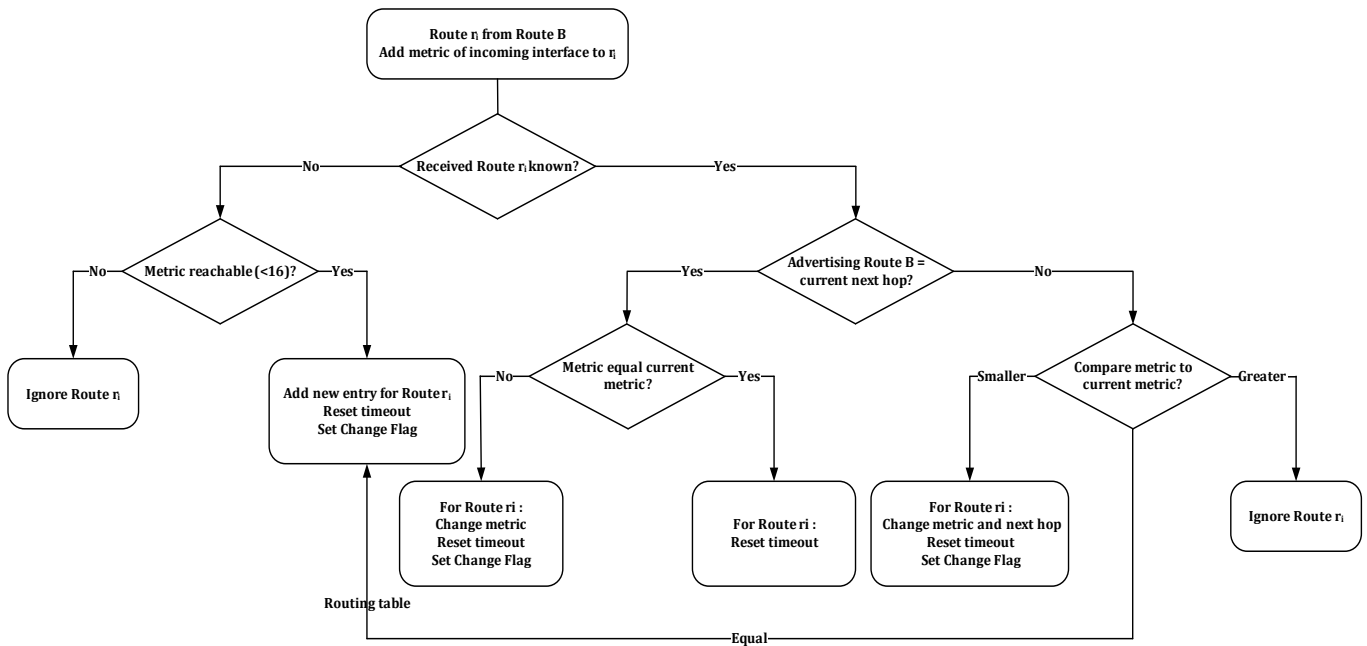

Figure 27-1

The RIPng process within each router maintains specific RIPng parameters for each route. To illustrate the distance vector algorithm, two of these parameters are briefly explained here. They are the route change flag, indicating a change of information of the corresponding route, and the timeout timer, indicating the lifetime of the route. The periodic updates prevent the route from expiring. Let's assume Router A and Router B are running RIPng. Router A receives a routing update from Router B and has already added the distance of 1 to each route r_i advertised by B. The next hop address for route r_i is Router B. For each route r_i , the router steps through the algorithm depicted above.

RIPng workflow

Using RIP, a gateway host with a router sends its entire routing table which lists all the other hosts it knows about to its closest neighbor host every 30 seconds. The neighbor host in turn will pass the information on to its next neighbor and so on until all hosts within the network have the same knowledge of routing paths, a state known as network convergence. RIP uses a hop count as a way to determine network distance. Other protocols use more sophisticated algorithms that include timing as well. Each host with a router in the network uses the routing table information to determine the next host to route a packet to for a specified destination.

RIP can be considered as an effective solution for small homogeneous networks. For larger, more complicated networks, RIP's transmission of the entire routing table every 30 seconds may put a heavy amount of extra traffic in the network. The workflow is shown below.

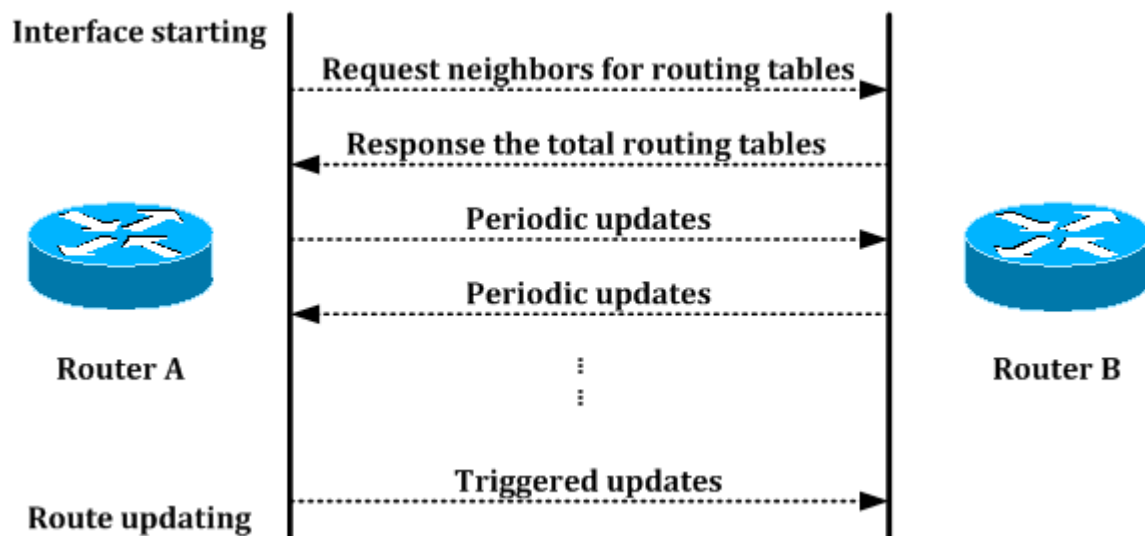

Figure 27-2

Timers

Update timer

By default, every 30 seconds the RIPng process wakes up on each interface to send an unsolicited response message to the neighboring routers. This response contains the entire routing table known to the RIP process, except for routes that follow the split horizon rule. One or more response messages may be needed. This timer is kept for each router interface.

Timeout timer

Each time a route entry is updated, the timeout time for this route entry is reset to zero. If the route entry reaches 180 seconds without another update, it is considered to have expired. The metric is set to 16, and the garbage collection process begins. In addition, the Route Change flag is raised to indicate a change. The output process uses this flag to trigger an update. This timer is kept for each routing table entry.

Garbage-collection timer

This timer is set for 120 seconds for each route entry that has timed out or has been received with a metric of 16. Only upon expiration of this timer will the route entry finally be removed from the routing table. If a new update to this route arrives before the garbage collection timer expires, the route is replaced and the garbage collection timer is cleared. This timer is kept for each routing table entry.

RIPng Configuration Commands

ipv6 router rip

Command	Explanation
<code>ipv6 router rip</code>	To enable the IPv6 RIP routing process on an interface, use the <code>ipv6 router rip</code> command. To disable the IPv6 RIP routing process on an interface, use the <code>no</code> form of this command.

The following example enables the IPv6 RIP routing process on VLAN 1.

```
DGS6600#enable
DGS6600#configure terminal
DGS6600(config)#interface vlan1
DGS6600(config-if)#ipv6 router rip
```

show ipv6 rip database

Command	Explanation
<code>show ipv6 rip database</code>	To display information about current IPv6 RIP processes, use the <code>show ipv6 rip database</code> command.

The following is sample output from the `show ipv6 rip database` command.

```
Codes: R - RIP, Rc - RIP connected, Rs - RIP static,
       K - Kernel, C - Connected, S - Static, O - OSPF, I - IS-IS, B - BGP

   Network                Next Hop                If          Met    Time
R 3ffe:1::/64             fe80::219:5bff:fef5:2cc1  vlan2       2
ODT0H2M31S
R 3ffe:2::/64             fe80::219:5bff:fef5:2cc1  vlan2       2
ODT0H2M31S
Rc 3ffe:3::/64            ::                       vlan3       1
Rc 3ffe:4::/64            ::                       vlan2       1

Total Entries: 4 entries, 4 routes
```

show ipv6 rip interface

Command	Explanation
show ipv6 rip interface [<i>IFNAME</i>]	To display the usability status of interfaces configured for IPv6 RIP, use the show ipv6 rip interface command.

The following is sample output in vlan1 from the show ipv6 rip interface command.

```
vlan1 is up, line protocol is up
  Routing Protocol: RIPng
    Passive interface: Disabled
    Split horizon: Enabled with Poisoned Reversed
    IPv6 interface address:
      fe80::a01:2ff:fe36:1/64
```

show ipv6 protocols

Command	Explanation
show ipv6 protocols [rip ospf]	To display the parameters and current state of the active IPv6 routing protocol process.

The following is sample output from the show ipv6 protocols ospf command.

```
Routing Protocol is "ospfv3 null"
Configured Router ID :8.1.2.64
Redistribute route default metric:20
Auto-cost Reference-bandwidth: 100
Distance: (default is 110)
metric-type 2 metric 16777215
Redistributing:
type          metric          metric_type
-----
connected    auto            2
static       auto            2
rip          auto            2
```

Configuration Examples

RIPng Configuration Example

Configure two DGS-6600 series routers to learn remote IPv6 routes by using RIPng protocol. In R1, routes 3005::1/64 and 3006::1/64 can be learned dynamically by RIPng protocol. In R2, routes 3002::1/64 and 3003::1/64 can be learned dynamically by RIPng protocol. All PCs in the topology can communicate each other by routing.

Topology

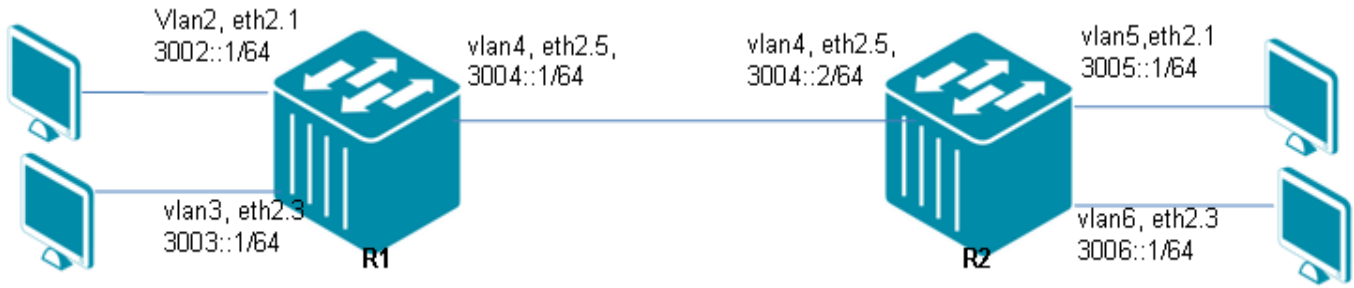

Figure 27-3 RIPng Configuration Example Topology

R1 (Router 1) Configuration Steps

Step 1: create vlan 2,3,4

```
DGS-6600:15(config)#vlan 2
DGS-6600:15(config-vlan)#vlan 3
DGS-6600:15(config-vlan)#vlan 4
```

Step 2: add port into vlan

```
DGS-6600:15(config-vlan)#interface eth2.1
DGS-6600:15(config-if)# access vlan 2
DGS-6600:15(config-if)#interface eth2.3
DGS-6600:15(config-if)# access vlan 3
DGS-6600:15(config-if)#interface eth2.5
DGS-6600:15(config-if)# access vlan 4
```

Step 3: configure IPv6 address of VLAN and enable ripng

```
DGS-6600:15(config-if)#interface vlan2
DGS-6600:15(config-if)# ipv6 address 3002::1/64
DGS-6600:15(config-if)# ipv6 enable
DGS-6600:15(config-if)# ipv6 router rip
DGS-6600:15(config-if)#interface vlan3
DGS-6600:15(config-if)# ipv6 address 3003::1/64
DGS-6600:15(config-if)# ipv6 enable
DGS-6600:15(config-if)# ipv6 router rip

DGS-6600:15(config-if)#interface vlan4
DGS-6600:15(config-if)# ipv6 address 3004::1/64
DGS-6600:15(config-if)# ipv6 router rip
```

Step 4: enable global ripng

```
DGS-6600:15(config-if)#router ipv6 rip
```

R2 (Router 2) Configuration Steps

Step 1: create vlan 4,5,6

```
DGS-6600:15(config)#vlan 4
DGS-6600:15(config-vlan)#vlan 5
DGS-6600:15(config-vlan)#vlan 6
```

Step 2: add port into vlan

```
DGS-6600:15(config-vlan)#interface eth2.1
DGS-6600:15(config-if)# access vlan 5
DGS-6600:15(config-if)#interface eth2.3
DGS-6600:15(config-if)# access vlan 6
DGS-6600:15(config-if)#interface eth2.5
DGS-6600:15(config-if)# access vlan 4
```

Step 3: configure IPv6 address of VLAN and enable ripng

```
DGS-6600:15(config-if)#interface vlan4
DGS-6600:15(config-if)# ipv6 address 3004::2/64
DGS-6600:15(config-if)# ipv6 enable
DGS-6600:15(config-if)# ipv6 router rip
DGS-6600:15(config-if)#interface vlan5
DGS-6600:15(config-if)# ipv6 address 3005::1/64
DGS-6600:15(config-if)# ipv6 enable
DGS-6600:15(config-if)# ipv6 router rip
DGS-6600:15(config-if)#interface vlan6
DGS-6600:15(config-if)# ipv6 address 3006::1/64
DGS-6600:15(config-if)# ipv6 enable
DGS-6600:15(config-if)# ipv6 router rip
```

Step 4: enable global ripng

```
DGS-6600:15(config-if)#router ipv6 rip
```

Verifying The Configuration

Check R1 & R2 routing table using the show ipv6 route

Limitations

- 1) The RIPng diameter is limited.
The longest path to any IPv6 route is limited to a metric of 15 when propagated with RIPng. Normally this corresponds with a path over a maximum of 15 hops. The protocol allows for larger costs to be assigned to any link, limiting the number of hops even further. Routes with a metric of 16 or greater are unreachable.
- 2) Routing loops can cause high convergence time.
When IPv6 routes that are no longer valid are being propagated in a looped environment, RIPng continues to increase the metric by one. The routes would be passed around indefinitely. The

mechanism of limiting the metric to 16 prevents this from happening. The routes will circle until they reach the maximum metric and are eventually eliminated.

- 3) The metric does not reflect line speed.
RIPng uses a fixed metric normally set to one for each link crossed. A route cannot be chosen based on bandwidth or real-time parameters such as measured delay, load, or reliability.
- 4) The function of ECMP is not supported in RIPng.
A single route has a single next hop in the current design. Therefore, the multipath is not supported.

Chapter 28

Open Shortest Path First Version 3 (OSPFv3)

Chapter Overview

The following topics are included in this chapter, please go to the topic for more detailed information:

- [Chapter Overview](#)
 - [An Introduction to OSPFv3](#)
 - [Interface state machine](#)
 - [Neighbor state machine](#)
 - [Protocol Packet Processing](#)
 - [OSPFv3 Configuration Commands](#)
 - [ipv6 router ospf area](#)
 - [router-id](#)
 - [show ipv6 ospf neighbor](#)
 - [Configuration Examples](#)
 - [OSPFv3 Configuration Example](#)
 - [Limitations](#)
 - [Behavior](#)

An Introduction to OSPFv3

OSPF is classified as an IGP, which are used within autonomous systems. It was designed to overcome some of the limitations introduced by RIP, such as the small diameter, long convergence time, and a metric that does not reflect the characteristics of the network. In addition, OSPF handles a much larger routing table to accommodate a large number of routes.

OSPF for IPv6 (OSPFv3) modifies the existing OSPF for IPv4 (OSPFv2) to support IPv6. The fundamentals of OSPF for IPv4 remain unchanged. Some changes have been necessary to accommodate the increased address size of IPv6 and the changes in protocol semantics between IPv4 and IPv6. OSPF for IPv6 is defined in RFC 2740 and RFC 5340, which emphasize the differences between OSPF for IPv4 and OSPF for IPv6. It contains a large number of references to the documentation of OSPF for IPv4.

Changes between OSPF for IPv4 and OSPF for IPv6 include the following. Addressing semantics have been removed from OSPF packets and the basic Link State Advertisements (LSAs). New LSAs have been created to carry IPv6 addresses and prefixes. OSPF now runs on a per-link basis rather than on a per-IP-subnet basis. Flooding scope for LSAs has been generalized. Authentication has been removed from the OSPF protocol and instead relies on IPv6's Authentication Header and Encapsulating Security Payload (ESP).

Even with larger IPv6 addresses, most packets in OSPF for IPv6 are almost as compact as those in OSPF for IPv4. Most fields and packet size limitations present in OSPF for IPv4 have been relaxed. In addition, option handling has been made more flexible. All of OSPF for IPv4's optional capabilities, including demand circuit support and Not-So-Stubby Areas (NSSAs), are also supported in OSPF for IPv6.

When going from IPv4 to IPv6, the basic OSPF mechanisms remain unchanged from those documented in OSPFv2. Both IPv6 and IPv4 have a link-state database composed of LSAs and synchronized between adjacent routers. Initial synchronization is performed through the Database Exchange process, which includes the exchange of Database Description, Link State Request, and Link State Update packets. Thereafter, database synchronization is maintained via flooding, utilizing Link State Update and Link State Acknowledgment packets. Both IPv6 and IPv4 use OSPF Hello packets to discover and maintain neighbor relationships, as well as to elect Designated Routers and Backup Designated Routers on broadcast and NBMA links. The decision as to which neighbor relationships become adjacencies, and the basic ideas behind inter-area routing, importing external information in AS-external-LSAs, and the various routing calculations are also the same.

The major OSPF data structures are the same for both IPv4 and IPv6: areas, interfaces, neighbors, the link-state database, and the routing table.

All LSAs with known LS type and AS flooding scope appear in the top-level data structure, instead of belonging to a specific area or link. AS-external-LSAs are the only LSAs defined by this specification that have AS flooding scope. LSAs with unknown LS type, U-bit set to 1, and AS flooding scope also appear in the top-level data structure.

1.The Area Data Structure

Area specific configurations are stored in the area descriptor. There are many parameters that are mostly used by the OSPFv3 protocol manager. The first stores the per area LS database. The second is a list of all active neighbors from the RIB. The OSPFv3 protocol tells the RIB when neighbors are created, deleted, or when their state changes. On the other hand active is only used by the OSPF protocol manager. Active tracks the number of neighbors which are in state FULL. If the number is zero the area is considered inactive. This counter is used to determine if a router is an area border router.

2.The Interface Data Structure

Every configured interface is represented by a struct iface. It stores values like the link state, baudrate, MTU, and interface type. There are some additional OSPFv3 specific parameters like the interface metric and interface state. Three neighbor pointers are pointers to the active DR or BDR neighbor or NULL if there is none. An interface can have up to three concurrent timers running and therefore three different event structures are needed.

3.The Neighbor Data Structure

Struct neighbor represents the neighbor relationship from the local point of view. To maintain a session successfully a LS retransmission and request list is required plus a list for the database. A few values are only used in the EXCHANGE phase when Database Description packets are transmitted. The interface, over which this neighbor is reached, is stored in iface. The neighbor structure is per interface so if two routers are connected via two different networks two different neighbor structures will be created for the same router but the structures are added to different interfaces.

Interface state machine

The finite state machine implemented in ospf6d is a simple table driven state machine. Any state transition may result in a specific action to be run. The resulting next state can either be a result of the action or is fixed and pre-determined. (See Diagram below)

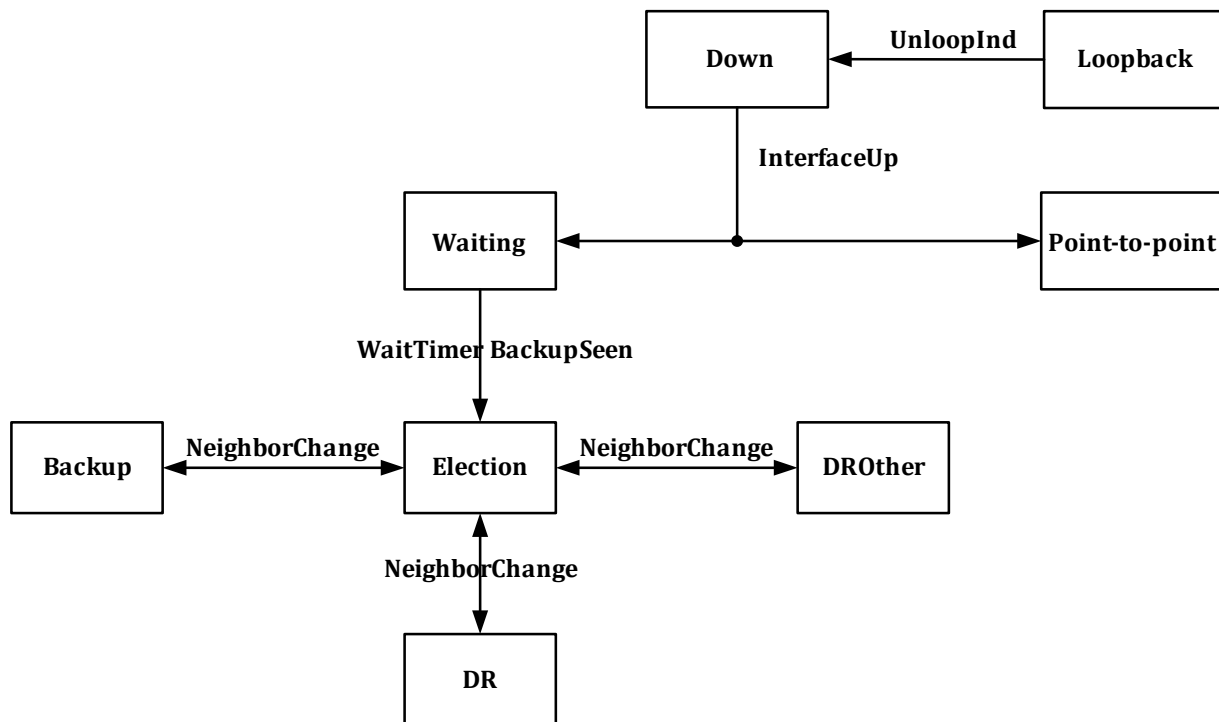

Figure 28-1

DOWN

In this state, the lower-level protocols have indicated that the interface is unusable. No protocol traffic at all will be sent or received on such an interface.

LOOPBACK

In this state, the router's interface to the network is looped back. Loopback interfaces are advertised in router-LSAs as single host routes, whose destination is the interface IP address.

POINT-TO-POINT

Point-to-point networks or virtual links enter this state as soon as the interface is operational.

WAITING

Broadcast or NBMA interfaces enter this state when the interface gets operational. While in this state no DR/BDR election is allowed. Receiving and sending of Hello packets is allowed and is used to try to determine the identity of the DR/BDR routers.

DROTHER

The router is neither DR nor BDR on the connected network. In this state the router will only form adjacencies to both the DR and the BDR. All other neighbors will stay in neighbor state 2-WAY.

BACKUP

The router is the BDR on the connected network segment. If the DR fails it will promote itself to be the new DR. The router forms adjacencies to all neighbors in the network segment.

DR

The router is the DR on the connected network segment. Adjacencies are established to all neighbors in the network segment. Additional duties are origination of a network-LSA for the network node and flooding of LS updates on behalf of all other neighbors.

Neighbor state machine

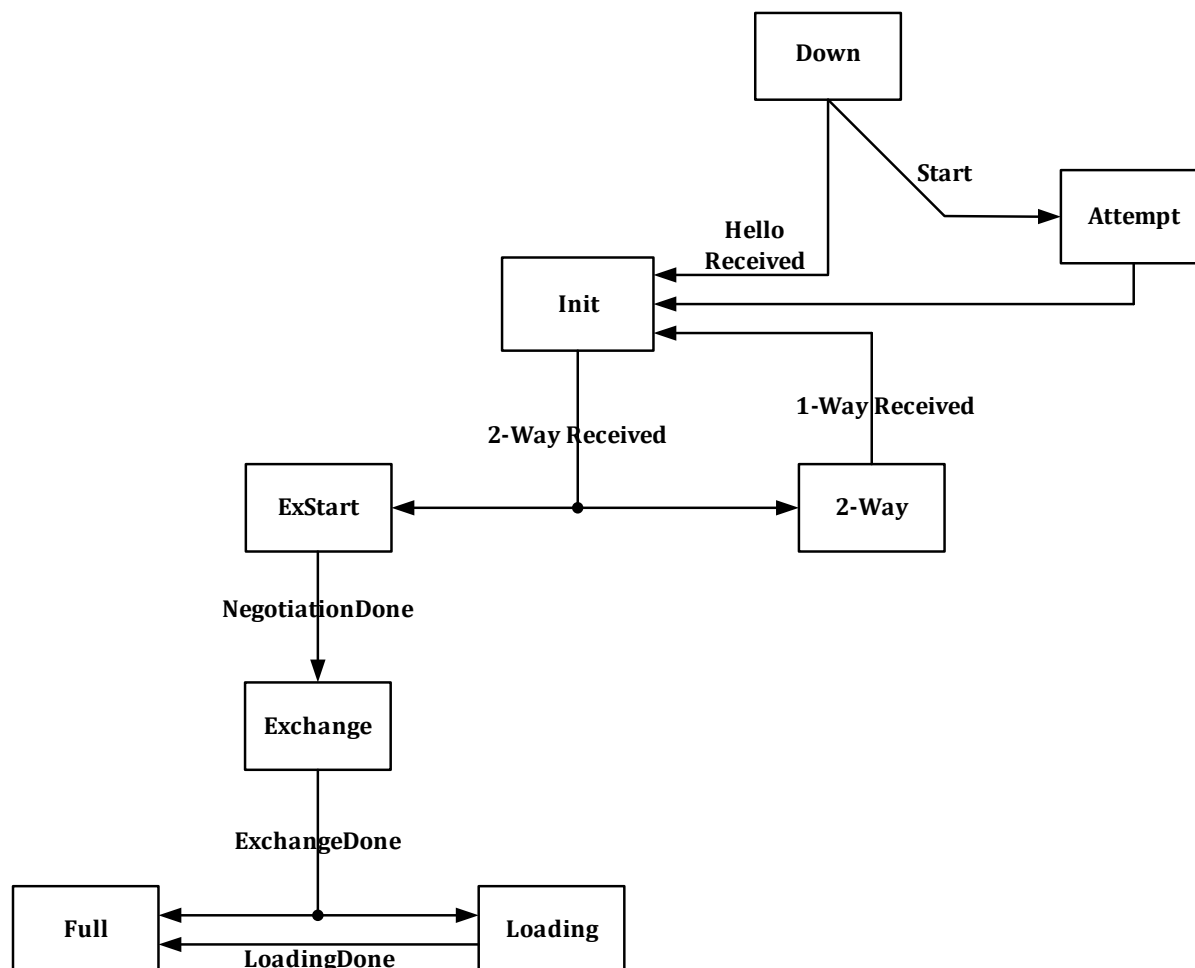

Figure 28-2

DOWN

A neighbor is considered down if no hello has been received for more than router-dead-time seconds. This is also the initial state of a neighbor.

ATTEMPT

This state is only valid for neighbors attached to NBMA networks. Therefore it is currently unused.

INIT

In this state, a Hello packet has recently been seen from the neighbor. However, bidirectional communication has not yet been established.

2-WAY

The communication between the neighbor and the router is bidirectional. Neighbors will remain in this state if both the router itself and the neighbor are neither DR nor BDR.

EXSTART

This is the first step in creating an adjacency between the two routers. In this state the initial DD sequence number and the master is selected for the upcoming database exchange phase.

EXCHANGE

This is the database exchange phase. Additionally all neighbors in state EXCHANGE or higher (LOADING, FULL) participate in the flooding procedure. Starting from this state all packet types can be received inclusive flooded LS updates.

LOADING

The state is only entered if the Link-State Request list is not empty. In that case Link-State Request packets are sent out to fetch the more recent LSAs from the neighbors LS database.

FULL

The two routers are now fully adjacent. The connection will now appear in router-LSAs and network-LSAs. Only in this state real traffic will be routed between the two routers.

Protocol Packet Processing

Before a Hello packet is accepted, a number of criteria must be met. The diagram below shows the decision process for the acceptance of a Hello packet.

The OSPF input process has already accepted the packet as described in the section "Message Format of OSPF for IPv6." Now the Hello Interval and the Router Dead Interval are checked. They must match the values set on the receiving interface. Next, the E and N bits in the Options field are examined. The settings of these bits must match the value set on the receiving interface.

At this point, if all the criteria matched, the packet is accepted and the neighbor is identified by its Router ID. The router keeps a neighbor state table for each interface. If there is already a full adjacency with this neighbor, the Hello timer is simply reset. Otherwise, the state of this neighbor changes to initialize (Init). The router examines the list of neighbors proclaimed in the received Hello packet. If the router identifies its own Router ID in that list, bidirectional communication has been established, and the neighbor's state changes to two-way. The router decides whether to form an adjacency with this neighbor. If the interface is a point-to-point state, an adjacency is formed with this neighbor. On a transit link, if the router itself or this neighbor is the DR/BDR, an adjacency is formed. If the router decides not to form an adjacency, this neighbor stays in a two-way state.

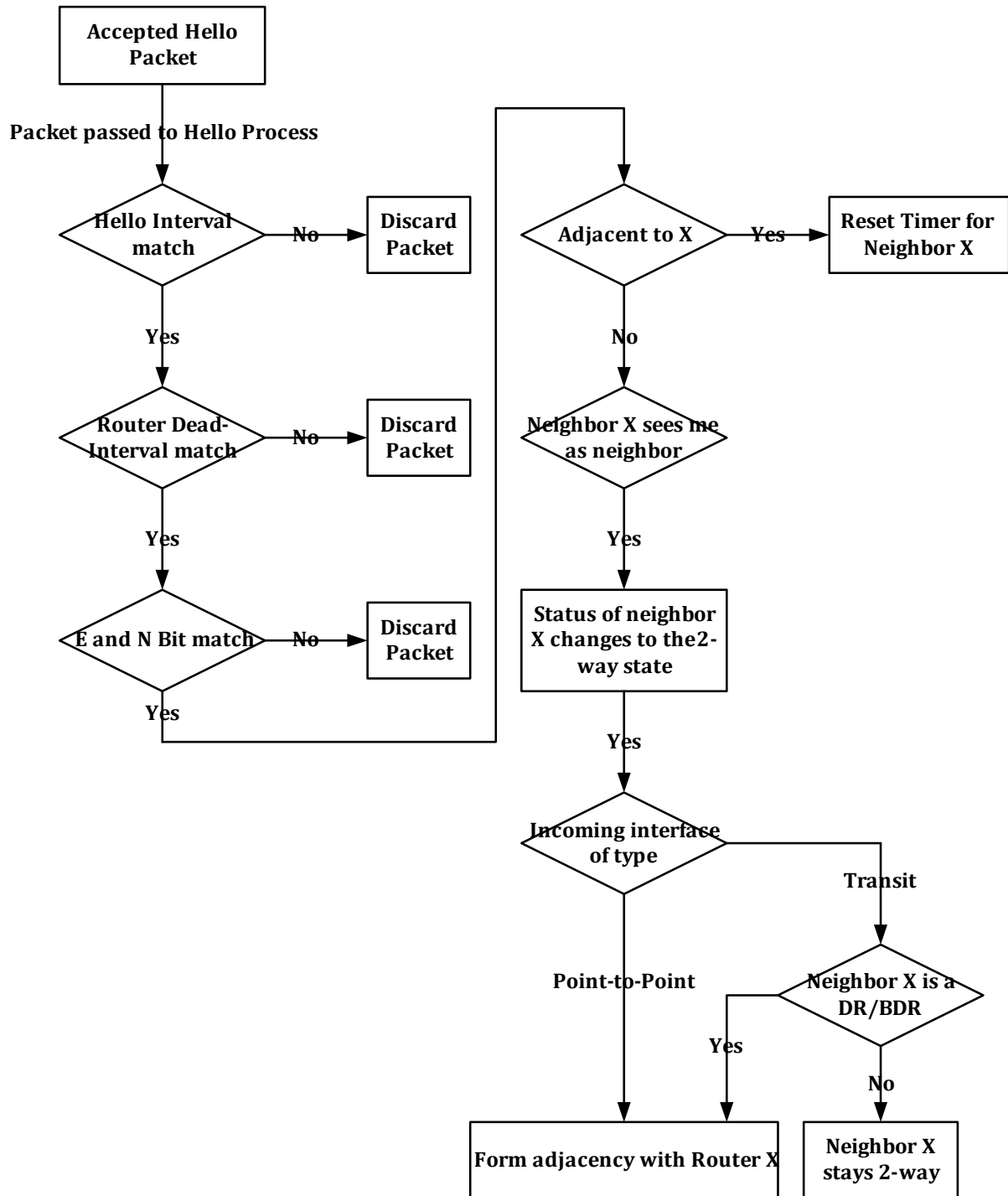

Figure 28-3

The diagram on the next page shows the different phases of forming an adjacency and the corresponding neighbor states.

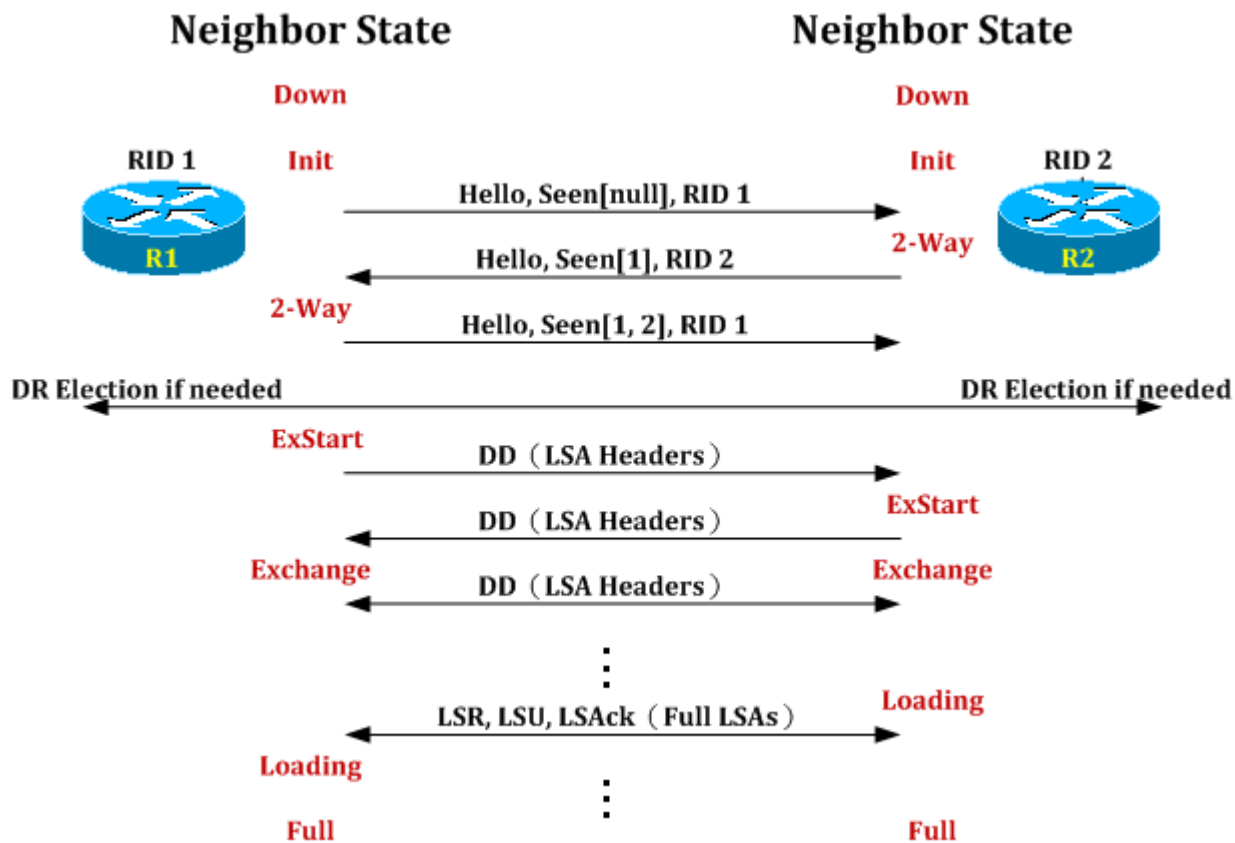

Figure 28-4

The link state database (LSDB) is the most important component of OSPF. The LSDB is a data structure consisting of LSAs exchanged in the AS. The link state information is structured to allow the building of a tree whose branches and leaves represent the shortest paths to all routes within the AS. Each router builds such a tree from its point of view. Most commonly, the routers use the algorithm developed by Dijkstra to build this tree of shortest paths (SPF tree). First, the router builds the intra-area tree to all destinations within its own area. Inter-area and external routes are then attached to the branch representing an ABR or ASBR. At the end, each route within the tree is added to one of four sections of the OSPF routing table: the intra-area routes, inter-area routes, external-1 routes, and finally, external-2 routes. The next hop is always the link-local address of first router in the shortest path to the route. The following sections describe each of these components, starting with the contents of the LSDB.

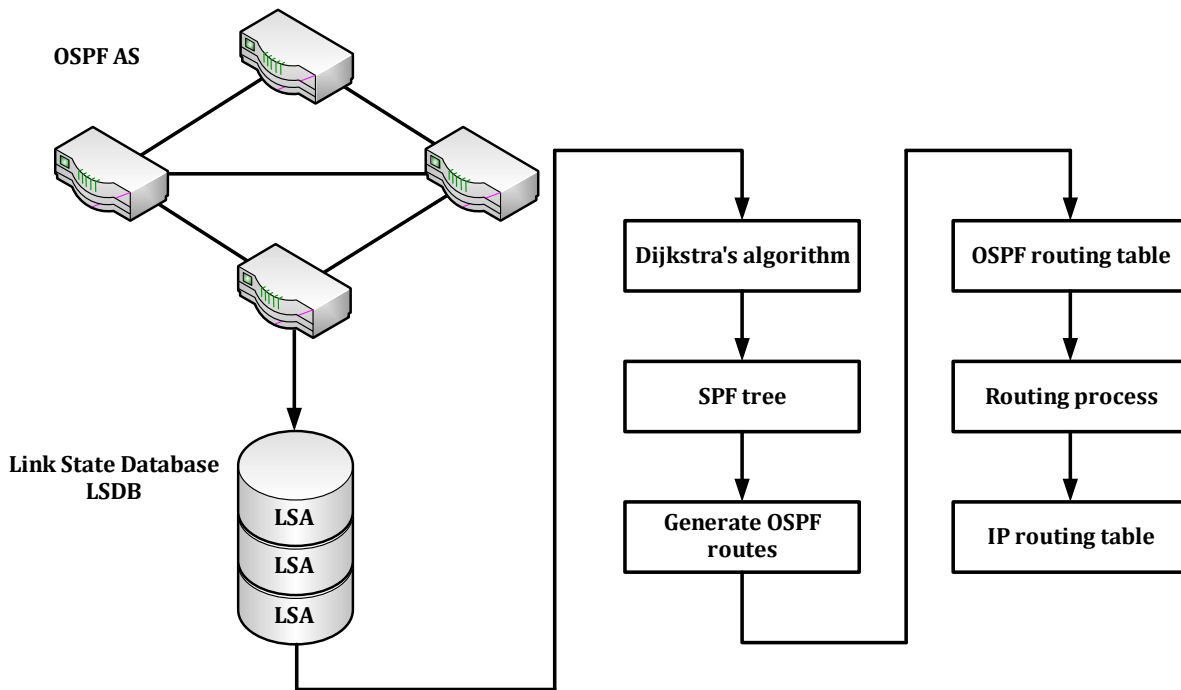

Figure 28-5

The diagram above shows how the routing decisions are including the following concerns:

- stores LS database
- calculates SPF tree
- informs parent process about routing table changes
- redistribution of networks (ASBR)
- summary LSA generation if ABR

Any change in the network causes certain link state information to change. Examples of such changes include the following:

- The state of a router's OSPF interfaces changes.
- A neighbor transitions to full state.
- A neighbor loses full adjacency.
- The DR on a transit link changes.
- A new IPv6 prefix is added or deleted on any given interface configured for OSPF.
- An interface configured for OSPF is added or deleted on a router.
- An area's summary information changes.
- An external route is added or withdrawn at the ASBR.
- The renewal timer ($\text{MaxAge}/2$) of an LSA requires an updated LSA.

OSPFv3 Configuration Commands

ipv6 router ospf area

Command	Explanation
<code>ipv6 router ospf area AREA-ID [tag PROCESS-ID] [instance-id INSTANCE-ID]</code>	To enable IPv6 OSPF on an interface, use the <code>ipv6 router ospf area</code> command. To disable IPv6 OSPF routing for interfaces defined, use the <code>no</code> form of this command.

The following example enables IPv6 OSPF on an interface.

```
DGS6600#enable
DGS6600#configure terminal
DGS6600(config)#interface vlan1
DGS6000(config-if)#ipv6 router ospf area 0 instance-id 2
```

router-id

Command	Explanation
<code>router-id IP-ADDRESS</code>	To assign a fixed router ID, use the <code>router-id</code> command in router configuration mode, and force IPv6 OSPF routing process with the previous IPv6 OSPF router ID. To disable this function, use the <code>no</code> form of this command.

The following example specifies a fixed router ID.

```
DGS6600#enable
DGS6600#configure terminal
DGS6600(config)#router ipv6 ospf
DGS6600(config-router)#router-id 10.1.1.1
```

show ipv6 ospf neighbor

Command	Explanation
<code>show ipv6 ospf [PROCESS-ID] neighbor [IFNAME NEIGHBOR-ID] [detail]</code>	To display IPv6 OSPF neighbor information on a per interface basis, use the show ipv6 ospf neighbor command.

The following is sample output from the show ipv6 ospf neighbor command with the detail keyword.

The result after executing this command is as follows.

```
OSPFv3 Process (null)
Neighbor ID      Pri   State                    Dead Time      Interface      Instance ID
10.76.37.3       1     Full/DR                  0DT0H0M33S    vlan2          0
10.76.37.3       1     Full/ -                   0DT0H0M38S    VLINK1         0

Total Entries: 2
```

Configuration Examples

OSPFv3 Configuration Example

Configure two DGS-6600 to learn remote IPv6 routes via OSPFv3 protocol. In R1, routes 3005::1/64 and 3006::1/64 can be learned dynamically by OSPFv3 protocol. In R2, routes 3002::1/64 and 3003::1/64 can be learned dynamically by OSPFv3 protocol. All PCs in the topology can communicate each other by routing.

Topology

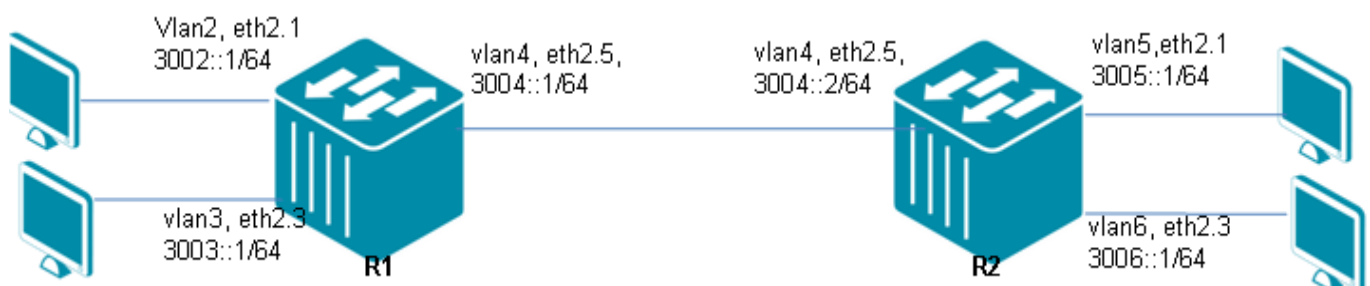

Figure 28-6 OSPFv3 Configuration Example Topology

R1 (Router 1) Configuration Steps

Step 1: create vlan 2,3,4

```
DGS-6600:15(config)#vlan 2
DGS-6600:15(config-vlan)#vlan 3
DGS-6600:15(config-vlan)#vlan 4
```

Step 2: add port into vlan

```
DGS-6600:15(config-vlan)#interface eth2.1
DGS-6600:15(config-if)# access vlan 2
DGS-6600:15(config-if)#interface eth2.3
DGS-6600:15(config-if)# access vlan 3
DGS-6600:15(config-if)#interface eth2.5
DGS-6600:15(config-if)# access vlan 4
```

Step 3: configure IPv6 address of VLAN and enable ospfv3

```
DGS-6600:15(config-if)#interface vlan2
DGS-6600:15(config-if)# ipv6 address 3002::1/64
DGS-6600:15(config-if)# ipv6 enable
DGS-6600:15(config-if)# ipv6 router ospf area 0
DGS-6600:15(config-if)#interface vlan3
DGS-6600:15(config-if)# ipv6 address 3003::1/64
DGS-6600:15(config-if)# ipv6 enable
DGS-6600:15(config-if)# ipv6 router ospf area 0
DGS-6600:15(config-if)#interface vlan4
DGS-6600:15(config-if)# ipv6 address 3004::1/64
DGS-6600:15(config-if)# ipv6 enable
DGS-6600:15(config-if)# ipv6 router ospf area 0
```

Step 4: enable global ospfv3

```
DGS-6600:15(config-if)#router ipv6 ospf
DGS-6600:15(config-router)#router-id 30.4.0.1
```

R2 (Router 2) Configuration Steps**Step 1: create vlan 4,5,6**

```
DGS-6600:15(config)#vlan 4
DGS-6600:15(config-vlan)#vlan 5
DGS-6600:15(config-vlan)#vlan 6
```

Step 2: add port into vlan

```
DGS-6600:15(config-vlan)#interface eth2.1
DGS-6600:15(config-if)# access vlan 5
DGS-6600:15(config-if)#interface eth2.3
DGS-6600:15(config-if)# access vlan 6
DGS-6600:15(config-if)#interface eth2.5
DGS-6600:15(config-if)# access vlan 4
```

Step 3: configure IPv6 address of VLAN and enable ospfv3

```
DGS-6600:15(config-if)#interface vlan4
DGS-6600:15(config-if)# ipv6 address 3004::2/64
DGS-6600:15(config-if)# ipv6 enable
DGS-6600:15(config-if)# ipv6 router ospf area 0
DGS-6600:15(config-if)#interface vlan5
DGS-6600:15(config-if)# ipv6 address 3005::1/64
DGS-6600:15(config-if)# ipv6 enable
DGS-6600:15(config-if)# ipv6 router ospf area 0
DGS-6600:15(config-if)#interface vlan6
DGS-6600:15(config-if)# ipv6 address 3006::1/64
DGS-6600:15(config-if)# ipv6 enable
DGS-6600:15(config-if)# ipv6 router ospf area 0
```

Step 4: enable global ospfv3

```
DGS-6600:15(config-if)#router ipv6 ospf
DGS-6600:15(config-router)#router-id 30.4.0.2
```

Verifying The Configuration

Check R1 & R2 routing table using the show ipv6 ospf neighbor command.

R1

```
DGS-6600:15#show ipv6 ospf neighbor
OSPFv3 Process (null)
Neighbor ID      Pri   State                    Dead Time           Interface   Instance ID
30.4.0.2         1    Full/DR                  0DT0H0M34S        vlan4      0
Total Entries: 1DGS-6600:15#show ipv6 route
IPv6 Routing Table
Codes: K - kernel route, C - connected, S - static, R - RIP, O - OSPF,
       I - IS-IS, B - BGP, X - add to ACL table fail
       # - A number of slots are inactive

C   3002::/64 is directly connected, vlan2
C   3003::/64 is directly connected, vlan3
C   3004::/64 is directly connected, vlan4
O   3005::/64 [110/2] via fe80::201:2ff:fe03:404, vlan4, 0DT0H5M43S
O   3006::/64 [110/2] via fe80::201:2ff:fe03:404, vlan4, 0DT0H5M43S

Total Entries: 5 entries, 5 routes
```

R2

```

DGS-6600:15#show ipv6 ospf neighbor
OSPFv3 Process (null)
Neighbor ID      Pri   State                Dead Time      Interface      Instance ID
30.4.0.1         1    Full/BDR              0DT0H0M34S    vlan4          0
Total Entries: 1
DGS-6600:15#show ipv6 route
IPv6 Routing Table
Codes: K - kernel route, C - connected, S - static, R - RIP, O - OSPF,
      I - IS-IS, B - BGP, X - add to ACL table fail
      # - A number of slots are inactive

O   3002::/64 [110/2] via fe80::40b:ff:fe27:4, vlan4, 0DT0H4M44S
O   3003::/64 [110/2] via fe80::40b:ff:fe27:4, vlan4, 0DT0H4M44S
C   3004::/64 is directly connected, vlan4
C   3005::/64 is directly connected, vlan5
C   3006::/64 is directly connected, vlan6

Total Entries: 5 entries, 5 routes

```

Limitations

OSPFv3 limitations include

- The prefix length of the summary route for the host route would not exceed 64 because of the H/W limitation. Please use the command: `ipv6 unicast-route long-prefix` to support IPv6 routes with a prefix length that is longer than 64bits.
- The unknown LSAs can't be counted in the current design. So the counter didn't work correctly.
- The function of NSSA is not supported.

Behavior

Regarding router id selection, there is a difference between IPv4 OSPF and IPv6 OSPF.

- IPv4 OSPF: If user configured router-id, it is possible to use the user's config, otherwise select the highest active ipv4 address from the ARP table as the router ID.
- IPv6 OSPF: If the user configured router-id, use the user's config, otherwise select the highest active ipv4 address of user's configured VLAN IP interfaces as the router ID.
- If all interfaces are down, we use 0.0.0.0 as router id. The process would shutdown at this time in IPv4 OSPF. However, we should remove all user's configured addresses to get 0.0.0.0 as router id in IPv6 OSPF.
- If the router id is changed with the user's config, the new router id will execute after the process restarts.
- IPv6 OSPF: If there were no configuration in any interface, the process would be down.
- IPv4 OSPF: If no "network area" were configured, the process would be down.

When the command “copy startup-config running-config” is enabled, the IPv4 address is added at the different time and maybe the highest address is not selected. The router ID is based on the configured IPv4 address at that time.

Chapter 29

IPv6 Tunneling

Chapter Overview

The following topics are included in this chapter, please go to the topic for more detailed information:

- [Chapter Overview](#)
 - [An Introduction to IPv6 Tunneling](#)
 - [Support RFC](#)
 - [IPv6 Manually Configured Tunnel](#)
 - [Automatic 6to4 Tunnel](#)
 - [ISATAP Tunnels](#)
 - [IPv6 Tunneling Configuration Commands](#)
 - [Configuration Examples](#)
 - [IPv6 tunneling manual Configuration Example](#)
 - [IPv6 tunneling 6to4 Configuration Example](#)
 - [IPv6 tunneling ISATAP Configuration Example](#)

An Introduction to IPv6 Tunneling

Tunneling mechanisms can be used to deploy an IPv6 forwarding infrastructure while the overall IPv4 infrastructure is still the basis, because it either should not, or cannot be modified or upgraded. Tunneling is also called encapsulation. With encapsulation, IPv6 protocol is encapsulated in the header of IPv4 protocol and forwarded over the infrastructure of the IPv4 protocol. Tunnels can be configured in a host or a router, however, each tunnel endpoint must support dual stack. In this device IPv6 supports the following types of tunneling mechanisms:

- 1) Manual
- 2) 6to4 (base on RFC 3056, but not support relay function)
- 3) Intra-Site Automatic Tunnel Addressing Protocol (ISATAP)

Support RFC

∅RFCs:

- RFC 3056, Connection of IPv6 Domains via IPv4 Clouds
- RFC 4213, Basic Transition Mechanisms for IPv6 Hosts and Routers
- RFC 5214, Intra-Site Automatic Tunnel Addressing Protocol (ISATAP)

Operation concept

IPv6 Manually Configured Tunnel

A manually configured tunnel is a permanent link between two IPv6 networks over an IPv4 infrastructure. The major use is for stable connections that require regular communication between two dual stack endpoints. An IPv6 address is manually configured on a tunnel interface, and manually configured IPv4 addresses are assigned to the tunnel source and the tunnel destination.

Automatic 6to4 Tunnel

RFC 3056, "Connection of IPv6 Domains via IPv4 Clouds," specifies a mechanism for IPv6 sites to communicate with each other over the IPv4 network without explicit tunnel setup. This mechanism is called 6to4. The wide area IPv4 network is treated as a unicast point-to-point link layer, and the native IPv6 domains communicate via 6to4 routers, also referred to as 6to4 gateways. The IPv6 packets are encapsulated in IPv4 at the 6to4 gateway. At least one globally unique IPv4 unicast address is required for this configuration. The IANA has assigned a special prefix for the 6to4 scheme: 2002::/16

The key difference between automatic 6to4 tunnels and manually configured tunnels is that the tunnel is not point-to-point; it is point-to-multipoint. In automatic 6to4 tunnels, routers are not configured in pairs. The IPv4 address embedded in the IPv6 address is used to find the other end of the automatic tunnel.

An automatic 6to4 tunnel may be configured on a border router in an isolated IPv6 network, which creates a tunnel on a per-packet basis to a border router in another IPv6 network over an IPv4 infrastructure. The tunnel destination is determined by the IPv4 address of the border router extracted from the IPv6 address that starts with the prefix 2002::/16, where the format is 2002: IPv4-address::/48. If tunnel interface has been configured tunnel destination address, it can't configure the tunnel type to 6to4 or ISATAP tunnel mode. The border router at each end of a 6to4 tunnel must support both the IPv4 and IPv6 protocol stacks.

The simplest deployment scenario for 6to4 tunnels is to interconnect multiple IPv6 sites, each of which has at least one connection to a shared IPv4 network. This IPv4 network could be the global Internet or a corporate backbone. The key requirement is that each site has a globally unique IPv4 address. As with other tunnel mechanisms, appropriate entries in a Domain Name System (DNS) that map between hostnames and IP addresses for both IPv4 and IPv6 allow the applications to choose the required address.

ISATAP Tunnels

The Intra-Site Automatic Tunnel Addressing Protocol (ISATAP) is designed to provide IPv6 connectivity for dual-stack nodes over an IPv4-based network. It treats the IPv4 network as one large link-layer network and allows those dual-stack nodes to automatically tunnel between themselves. You can use this automatic tunneling mechanism regardless of whether you have global or private IPv4 addresses. ISATAP addresses embed an IPv4 address in the EUI-64 interface identifier.

The ISATAP router provides standard router advertisement network configuration support for the ISATAP site. This feature allows clients to automatically configure themselves. ISATAP uses a well-defined IPv6 address format composed of any unicast IPv6 prefix (/64), which can be link local, or global (including 6to4 prefixes), enabling IPv6 routing locally or on the Internet. The IPv4 address is encoded in the last 32 bits of the IPv6 address, enabling automatic IPv6-in-IPv4 tunneling.

ISATAP uses unicast addresses that include a 64-bit IPv6 prefix and a 64-bit interface identifier. When the IPv4 address is known to be globally unique, the first 32bits of interface identifier is 0200:5EFE; otherwise is 0000:5EFE. The interface identifier is created in modified EUI-64 format. Table 1 describes an ISATAP address format.

Table 29-1

64 Bits (prefix)	32 Bits (first 32bits of interface identifier)	32 Bits (last 32bits of interface identifier)
link local or global IPv6 unicast prefix	0200:5EFE (global IPv4) 0000:5EFE (private IPv4)	IPv4 address of the ISATAP link

IPv6 Tunneling Configuration Commands

Command	Description
<code>interface tunnel {tunnel-ID}</code>	Use the interface tunnel configuration command to add a tunnel and to enter the interface configuration mode. Use the <code>no interface tunnel {tunnel-ID}</code> command to remove a tunnel.
<code>no interface tunnel {tunnel-ID}</code>	
<code>ipv6 nd suppress-ra</code>	This command is used to suppress IPv6 RA (router advertisement) on an interface of this switch. Use the <code>no ipv6 nd suppress-ra</code> configuration command to enable the sending of IPv6 router advertisements on an ISATAP tunnel interface.
<code>no ipv6 nd suppress-ra</code>	
<code>tunnel destination {IPv4-ADDRESS}</code>	Use the tunnel destination configuration command to add the destination IPv4 address for the tunnel interface. Use the <code>no tunnel destination</code> configuration command to remove it.
<code>no tunnel destination</code>	
<code>tunnel mode ipv6ip [6to4 isatap]</code>	Use the tunnel mode ipv6ip configuration command to manually specify an IPv6 configured tunnel. The optional parameter <code>6to4</code> or <code>isatap</code> means that tunnel type is 6to4 or ISATAP. Use the <code>no</code> form of the command to remove the IPv6 specification.
<code>no tunnel mode</code>	
<code>tunnel source {IPv4-ADDRESS}</code>	Use the tunnel source configuration command to add the source IPv4 address for the tunnel interface. Use the <code>no tunnel source</code> configuration command to remove it.
<code>no tunnel source</code>	

Table 29-2

Configuration Examples

IPv6 tunneling manual Configuration Example

R1 and R2 are connected by IPv4 network and they are reachable each other. Establish IPv6 manual tunnel between R1 and R2 to make two IPv6 networks can communicate to each other by this tunnel.

Topology

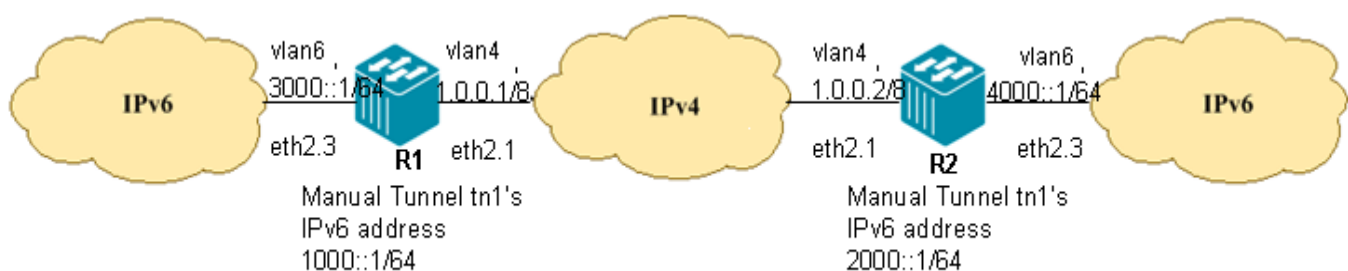

Figure 29-1 Ipv6 Tunneling Manual Configuration Example Topology

Configuration Prerequisites:

1. Create vlan4 and vlan6 on R1, assign an IPv4 address 1.0.0.1/8 to vlan4, assign an IPv6 address 3000::1/64 to vlan6, eth2.1 access vlan4, and eth2.3 access vlan6.

2. Create vlan4 and vlan6 on R2, assign an IPv4 address 1.0.0.2/8 to vlan4, assign an IPv6 address 4000::1/64 to vlan6, eth2.1 access vlan4, and eth2.3 access vlan6.
3. Ensure R1 and R2 is reachable by IPv4 network.
4. Ensure the R1's eth2.3 and R2's eth2.3 is up status.

R1 (Router 1) Configuration steps

Step 1: Create and configure manual tunnel

```
DGS-6600:15(config)#interface tunnell
DGS-6600:15(config-if)# tunnel source 1.0.0.1
DGS-6600:15(config-if)# tunnel destination 1.0.0.2
DGS-6600:15(config-if)# tunnel mode ipv6ip
DGS-6600:15(config-if)# ipv6 address 1000::1/64
```

Step 2: Create default route ::/0 to use manual tunnel "tunnel1"

```
DGS-6600:15(config)#ipv6 route ::/0 tunnel 1
```

R2 (Router 2) Configuration Steps

Step 1: Create and configure manual tunnel

```
DGS-6600:15(config)#interface tunnell
DGS-6600:15(config-if)#tunnel source 1.0.0.2
DGS-6600:15(config-if)#tunnel destination 1.0.0.1
DGS-6600:15(config-if)#tunnel mode ipv6ip
DGS-6600:15(config-if)#ipv6 address 2000::1/64
```

Step 2: Create default route ::/0 to use manual tunnel "tunnel1"

```
DGS-6600:15(config)#ipv6 route ::/0 tunnel 1
```

Verifying The Configuration

Use "show interface tunnel1" and "show ipv6 route" command, to check R1 (router 1) table.

```
DGS-6600:15#show interface tunnel1

tunnel1 is up, line protocol is up (connected)
  Hardware is Tunnel
  Description:
  inet6 1000::1/64
  Tunnel source 1.0.0.1, destination 1.0.0.2
  Tunnel protocol/transport IPv6/IP, key disabled, sequencing disabled
  Tunnel TTL 128
  Checksumming of packets disabled, path MTU discovery disabled

DGS-6600:15#show ipv6 route
IPv6 Routing Table
Codes: K - kernel route, C - connected, S - static, R - RIP, O - OSPF,
       I - IS-IS, B - BGP, X - add to ACL table fail
       # - A number of slots are inactive

S   ::/0 [1/0] tunnel1
C   1000::/64 is directly connected, tunnel1

Total Entries: 2 entries, 2 routes
```

IPv6 tunneling 6to4 Configuration Example

R1,R2 and R3 are connected by an IPv4 network and they are reachable by each other. There are 6to4 tunnels between R1, R2 and R3. To make three IPv6 networks can communicate to each other by this tunnel.

Topology

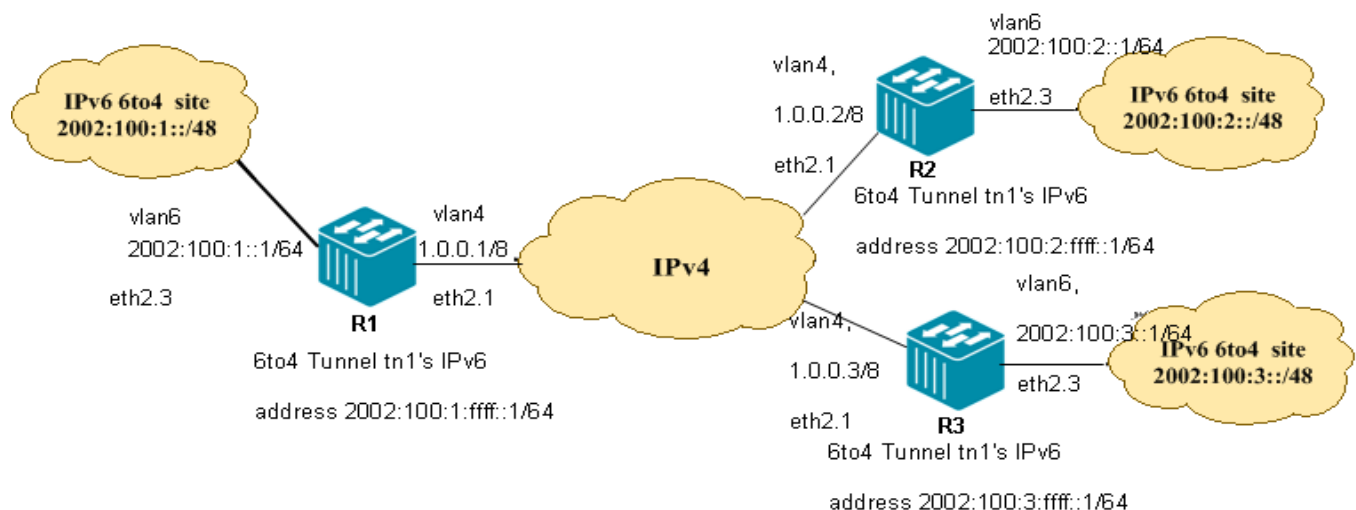

Figure 29-2 Ipv6 tunneling 6to4 Configuration Example Topology

Configuration Prerequisites:

- 1.Create vlan4 and vlan6 on R1, assign an IPv4 address 1.0.0.1/8 to vlan4, assign an IPv6 6to4 address 2002:100:1::1/64 to vlan6, eth2.1 access vlan4, and eth2.3 access vlan6.

Ensure R1 is reachable to IPv6 6to4 site 2002:100:1::/48.

2. Create vlan4 and vlan6 on R2, assign an IPv4 address 1.0.0.2/8 to vlan4, assign an IPv6 6to4 address 2002:100:2::1/64 to vlan6, eth2.1 access vlan4, and eth2.3 access vlan6.

Ensure R2 is reachable to IPv6 6to4 site 2002:100:2::/48.

3. Create vlan4 and vlan6 on R3, assign an IPv4 address 1.0.0.3/8 to vlan4, assign an IPv6 6to4 address 2002:100:3::1/64 to vlan6, eth2.1 access vlan4, and eth2.3 access vlan6.

Ensure R3 is reachable to IPv6 6to4 site 2002:100:3::/48.

R1 (Router 1) Configuration Steps

Step 1: Create and configure 6to4 tunnel

```
DGS-6600:15(config)#interface tunnell
DGS-6600:15(config-if)# tunnel source 1.0.0.1
DGS-6600:15(config-if)# tunnel mode ipv6ip 6to4
DGS-6600:15(config-if)# ipv6 address 2002:100:1:ffff::1/64
```

Step 2: Create 2002::/16 to use 6to4 tunnel "tunnel1"

```
DGS-6600:15(config-if)#ipv6 route 2002::/16 tunnel 1
```

R2 (Router 2) Configuration Steps

Step 1: Create and configure 6to4 tunnel

```
DGS-6600:15(config)#interface tunnell
DGS-6600:15(config-if)# tunnel source 1.0.0.2
DGS-6600:15(config-if)# tunnel mode ipv6ip 6to4
DGS-6600:15(config-if)# ipv6 address 2002:100:2:ffff::1/64
```

Step 2: Create 2002::/16 to use 6to4 tunnel "tunnel1"

```
DGS-6600:15(config-if)#ipv6 route 2002::/16 tunnel 1
```

R3 (Router 3) Configuration Steps

Step 1: Create and configure 6to4 tunnel

```
DGS-6600:15(config)#interface tunnell
DGS-6600:15(config-if)# tunnel source 1.0.0.3
DGS-6600:15(config-if)# tunnel mode ipv6ip 6to4
DGS-6600:15(config-if)# ipv6 address 2002:100:3:ffff::1/64
```

Step 2: Create 2002::/16 to use 6to4 tunnel "tunnel1"

```
DGS-6600:15(config-if)#ipv6 route 2002::/16 tunnel 1
```

Verifying The Configuration

Check R1 IPv6 tunneling 6to4 config. Use the same command, show interface tunnel1, to check other routers tables.

```
DGS-6600:15#show interface tunnel1

tunnel1 is up, line protocol is up (connected)
  Hardware is Tunnel
  Description:
  inet6 2002:100:1:ffff::1/64
  Tunnel source 1.0.0.1, destination UNKNOWN
  Tunnel protocol/transport IPv6/IP 6to4, key disabled, sequencing disabled
  Tunnel TTL 128
  Checksumming of packets disabled, path MTU discovery disabled

DGS-6600:15#show ipv6 route
IPv6 Routing Table
Codes: K - kernel route, C - connected, S - static, R - RIP, O - OSPF,
       I - IS-IS, B - BGP, X - add to ACL table fail
       # - A number of slots are inactive

S   2002::/16 [1/0] tunnel1
C   2002:100:1::/64 is directly connected, tunnel1

Total Entries: 2 entries, 2 routes
```

IPv6 tunneling ISATAP Configuration Example

R1 is connected between IPv4 and IPv6 networks. There are two ISATAP tunnels, one is between R1 and PC1, and another is between R1 and PC2. To make two PC can communicate to IPv6 network by this tunnel.

Topology

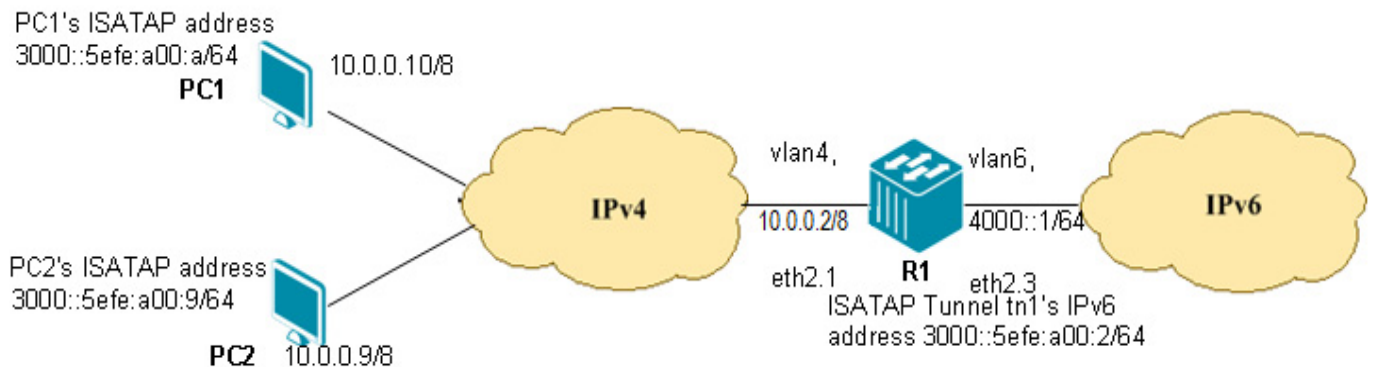

Figure 29-3 IPv6 Tunneling ISATAP Configuration Example Topology

Configuration Prerequisites

1. Create vlan4 and vlan6 on R1, assign an IPv4 address 10.0.0.2/8 to vlan4, assign an IPv6 address 4000::1/64 to vlan6, eth2.1 access vlan4, and eth2.3 access vlan6.

2. Configure ISATAP PC1's IPv4 address 10.0.0.10/8 and ensure PC1 and R1 is reachable by the IPv4 network.
3. Configure ISATAP PC2's IPv4 address 10.0.0.9/8 and ensure PC2 and R1 is reachable by the IPv4 network.
4. ISATAP host PC1 and PC2 runs Windows XP.

R1 (Router 1) Configuration Steps

Step 1: Create and configure ISATAP tunnel

```
DGS-6600:15(config)#interface tunnel1
DGS-6600:15(config-if)# tunnel source 10.0.0.2
DGS-6600:15(config-if)# tunnel mode ipv6ip isatap
DGS-6600:15(config-if)# ipv6 address 3000::5efe:a00:2/64
DGS-6600:15(config-if)# no ipv6 nd suppress-ra
```

ISATAP host PC1 Configuration Steps

Step 1: Using the command "ipv6 ifcr v6v4 10.0.0.10 10.0.0.2" to get ISATAP tunnel's interface index. Assumed that ISATAP tunnel's interface index is 2.

Step 2: Configure Host PC1's ISATAP IPv6 address by using "ipv6 adu 2/3000::5efe:10.0.0.10". ISATAP 64-bit global prefix should be set the same value as ISATAP R1.

Step 3: Create default route to use ISATAP tunnel interface, nexthop value is R1 ISATAP IPv6 address. "netsh interface ipv6 add route ::/0 2 nexthop=3000::5efe:10.0.0.2 publish=yes"

ISATAP host PC2 Configuration Steps

Step 1: Using the command "ipv6 ifcr v6v4 10.0.0.9 10.0.0.2" to get ISATAP tunnel's interface index. Assumed that ISATAP tunnel's interface index is 2.

Step 2: Configure Host PC2's ISATAP IPv6 address by using "ipv6 adu 2/3000::5efe:10.0.0.9". ISATAP 64-bit global prefix should be set the same value as ISATAP R1.

Step 3: Create default route to use ISATAP tunnel interface, nexthop value is R1 ISATAP IPv6 address. "netsh interface ipv6 add route ::/0 2 nexthop=3000::5efe:10.0.0.2 publish=yes"

Verifying The Configuration

Check R1 IPv6 tunneling ISATAP config. Use the same command, show interface tunnel1, to check other routers tables.

```
DGS-6600:15#show interface tunnel3
tunnel3 is up, line protocol is up (connected)
  Hardware is Tunnel
  Description:
  inet6 3000::5efe:a00:2/64
  inet6 fe80::5efe:a00:2/64
  Tunnel source 10.0.0.2, destination UNKNOWN
  Tunnel protocol/transport IPv6/IP ISATAP, key disabled, sequencing disabled
  Tunnel TTL 128
  Checksumming of packets disabled, path MTU discovery disabled
  ND router advertisements are sent between 600 and 600 seconds
  ND next router advertisement due in 0 seconds.
  ND router advertisements live for 1800 seconds
  Hosts use stateless autoconfig for addresses.
```

Chapter 30

Border Gateway Protocol (BGP)

Chapter Overview

The following topics are included in this chapter, please go to the topic for more detailed information:

- [Chapter Overview](#)
- [An Introduction to BGP](#)
- [BGP Configuration commands](#)
- [Configuration Examples](#)
 - [BGP Configuration Example](#)

An Introduction to BGP

The purpose of the BGP routing protocol is to provide loop-free routing between autonomous systems. An autonomous system is a routing domain that contains independent routing policies. In order to make the operation of BGP more reliable, BGP uses the TCP protocol as it is connection-oriented. BGP uses port 179 as the destination port and a random port number for the source port. The Switch supports BGP version 4, which is the same version that Internet Service Providers used when building the Internet. Several new BGP features were introduced in RFC 1771, which allowed BGP to meet the demands for Internet connectivity.

One of the main uses for BGP is when a user needs to connect their local network to an external network in order to access the Internet or the networks of other external organizations. Whenever a connection is made to an external organization, an external BGP (eBGP) peering session is made. Despite the fact that BGP was originally designed to work as an exterior gateway protocol (EGP), the increased complexity of internal networks has led to many organizations deploying BGP internally as it actually simplifies their internal network. In order for routing information to be exchanged between peers in the same organization, internal BGP (iBGP) peering sessions need to be established.

BGP exchanges network reachability information with other devices that are running BGP by using a path-vector routing algorithm. Routing updates are used to exchange information about network reachability between BGP peers. The information contained within the network reachability consists of the network number, attributes that are specific to a path, and a list that details the autonomous system numbers that must be traversed by the route in order to reach the destination network. The AS-path attribute of BGP contains the list of autonomous system numbers that are appended to an update as it traverses across networks. In order to prevent routing loops, BGP rejects any routing updates that contain a local autonomous system number. If a BGP routing update has a local autonomous system then a loop will be created since the route update has previously travelled through the local autonomous system. The distance-vector algorithm and the AS-path loop detection mechanism combined create the BGP path-vector algorithm.

By default, only a single-path to a destination host or network is selected as the best path by BGP. The algorithm that BGP uses to select the best path analyzes all the attributes of each path to identify the route that has been designated as the best path in the routing table of BGP. Several attributes are used to analyze the best BGP path. The attributes that are carried by each BGP path are the well-known mandatory, well-known discretionary, and optional transitive types. The user can use the Switch's CLI to alter some of the attributes to influence the way BGP chooses a path. Although it is also possible to configure the standard BGP algorithm that controls the path selection

One of the useful aspects of BGP is that it can interface with Interior Gateway Protocols (IGPs), which can help with the management of complicated internal networks. By Interfacing with IGPs, BGP can assist in scaling issues. For example, when an existing IGP is scaled to match new traffic demands, then BGP's interfacing capability to that IGP is important in order to maintain the efficiency of the network.

BGP Configuration commands

The following Configuration Topics are included in this sub-section:

- [Enabling BGP](#)
- [Optional Settings for a Basic BGP Configuration](#)
- [Configuring BGP Peers](#)
- [Available Customizing Options for BGP Peers](#)
- [Creating BGP Aggregate Entries](#)
- [Creating BGP Aggregate Entries](#)
- [To propagate network 172.0.0.0 and suppress the more specific route 172.10.0.0:](#)
- [Enabling the BGP Routing Process](#)
- [Configuring Fixed Router ID for LBG BGP Routing Process](#)
- [Comparing \(MED\) for Paths from Neighbors in Different Autonomous Systems](#)
- [Configuring BGP to Not Use As-Path Factor for Selecting the Best Path](#)
- [Comparing Router IDs for Identical eBGP Paths](#)
- [Configuring BGP Defaults and Activating IPv4-Unicast for Peers](#)
- [Changing Default Local Preference Value](#)
- [Configuring \(MED\) Values Inclusions Between Paths in Autonomous Systems](#)
- [Configuring BGP to Enforce First Autonomous Systems for eBGP Routes](#)
- [Enabling Logging of BGP Neighbor Resets](#)
- [Defining a BGP Autonomous System Path Access List](#)
- [Creating a Community List Entry](#)
- [Setting Minimum Interval Between BGP Routing Updates](#)
- [Creating a Description for a Neighbor](#)
- [Setting Up BGP Filters](#)
- [Creating a BGP Peer Group](#)
- [Adding a Neighbor to a BGP Peer Group](#)
- [Adding an Entry to the BGP Neighbor Table](#)
- [Applying Route Maps to Outgoing Routes](#)
- [Specifying that Communities Attribute should be Sent to BGP Neighbors](#)
- [Disabling a Neighbor or Peer Group](#)
- [Configuring the BGP Origin Code](#)
- [BGP Synchronization](#)
- [Displaying the BGP Routing Table](#)
- [Displaying the Configured Community Lists](#)
- [Displaying Routes that Conform to a Specified Filter List](#)
- [Displaying BGP Permitted Routes](#)
- [Displaying Information about BGP Neighbors](#)
- [Displaying IP Routes](#)

Enabling BGP

In order to start using BGP, the user needs to enter BGP router configuration mode and configure the related BGP protocol parameter settings. Enter the following command in global configuration mode to enable the BGP routing process:

Command	Explanation
<code>router bgp <i>AS-NUMBER</i></code>	Use this command to enable (configure) BGP routing process. This command mode must be entered to execute any BGP Router configuration commands, such as "neighbor remote-as". Use the no form of the command to remove a BGP routing process.

Optional Settings for a Basic BGP Configuration

The following commands provide optional settings for a basic BGP configuration:

Command	Explanation
<code>network {<i>NETWORK-NUMBER</i> [/ <i>SUBNET-LENGTH</i>] <i>NETWORK-NUMBER</i> [mask <i>NETWORK-NUMBER</i>] } [route-map <i>MAP-TAG</i>]</code>	Specifies the networks that will be included in BGP updates.
<code>bgp router-id <i>IP-ADDRESS</i></code>	Configures a fixed router ID for the local BGP routing process.
<code>timers bgp <i>KEEP-ALIVE</i> [<i>HOLD-TIME</i>]</code>	Configures the timers that will be used by BGP. If the user wants to specify the frequency that the Switch will send keepalive messages to its BGP peers, the <i>KEEP-ALIVE</i> argument can be used to specify the number of seconds between each keepalive message being sent. If the user wants to specify the interval <i>HOLD-TIME</i> .
<code>bgp log-neighbor-changes</code>	Use the <code>bgp log-neighbor-changes</code> command to enable logging of BGP neighbor resets. Use no <code>bgp log-neighbor-changes</code> to disable the logging.

Configuring BGP Peers

Command	Explanation
<code>neighbor {IP-ADDRESS PEER-GROUP-NAME} REMOTE-AS AS-NUMBER</code>	Use this command to add an entry to the Border Gateway Protocol (BGP) neighbor table. Use the no form of this command to remove an entry from the table.
<code>address-family ipv4 [unicast]</code>	Use this command to enter address family configuration mode to configure a routing session using standard IP Version 4 address prefixes. Use the no form of this command to remove the IPv4 address family configuration from the running configuration.

Configuration Example

The following example shows a configuration with the result that the autonomous system path for the paths advertised by 10.108.1.1 through autonomous system 100 will just contain "100":

```
dgs-6600:2>enable
dgs-6600:15#configure terminal
dgs-6600:15(config)#router bgp 100
dgs-6600:15(config-router)#neighbor 10.108.1.1 remote-as 65001
dgs-6600:15(config-router)#neighbor 10.108.1.1 description peer with private-as
```

Available Customizing Options for BGP Peers

Command	Explanation
<code>no bgp default ipv4-unicast</code>	the bgp default command enables the IP version 4 (IPv4) unicast address family for all neighbors. This affects the BGP global configuration. The no form of the command to disable this function.
<code>neighbor {IP-ADDRESS PEER-GROUP-NAME} remote-as AS-NUMBER</code>	Use this command to add an entry to the Border Gateway Protocol (BGP) neighbor table. Use the no form of this command to remove an entry from the table.
<code>neighbor {IP-ADDRESS PEER-GROUP-NAME} description TEXT</code>	Use this command to associate a text description with a neighbor. Use the no form of the command to remove the description.
<code>address-family ipv4 [unicast]</code>	Use this command to enter address family configuration mode to configure a routing session using standard IP Version 4 address prefixes. Use the no form of this command to remove the IPv4 address family configuration from the running configuration.
<code>neighbor {IP-ADDRESS PEER-GROUP-NAME} route-map MAP-NAME {in out}</code>	Use this command to apply a route map to incoming or outgoing routes. Use the no form of the command to remove the route map.
<code>neighbor {IP-ADDRESS PEER-GROUP-NAME} advertisement-interval SECONDS</code>	Use this command to set the minimum interval between each transmission of Border Gateway Protocol (BGP) routing updates. Use the no form of the command to return to the default configuration.
<code>neighbor {IP-ADDRESS PEER-GROUP-NAME} shutdown</code>	Use this command to disable a neighbor or peer group. Use the no form of this command to re-enable a neighbor or peer group.

Configuration Examples

The following example shows you how to enter address family configuration mode for the IP Version 4 address family:

```
dgs-6600:2>enable
dgs-6600:15#configure terminal
dgs-6600:15(config)#router bgp 65100
dgs-6600:15(config-router)#address-family ipv4
dgs-6600:15(config-router-af)#
```

Creating BGP Aggregate Entries

Use the **aggregate-address** command to configure BGP aggregate entries.

Aggregates are used to minimize the size of routing tables. Aggregation combines the characteristics of several different routes and advertises a single route. The **aggregate-address** command creates an aggregate entry in the BGP routing table if any more-specific BGP routes are available in the specified range. Using the **summary-only** parameter advertises the prefix only, suppressing the more-specific routes to all neighbors.

The **as-set** parameter creates an aggregate entry advertising the path for this route, consisting of all elements contained in all paths being summarized. Use the **as-set** parameter to reduce the size of path information by listing the AS number only once, even if it was included in multiple paths that were aggregated. The **as-set** parameter is useful when the aggregation of information results in incomplete path information.

Command	Explanation
<code>enable [privilege LEVEL]</code>	Enter privileged EXEC mode.
<code>configure terminal</code>	Enter Global configuration mode.
<code>router bgp AS-NUMBER</code>	Enter the following information to configure BGP routing process and enter into BGP configuration mode.
<code>aggregate-address NETWORK-NUMBERS/SUBNET-LENGTH [summary-only] [as-set]</code>	Enter the following information to configure BGP aggregate entries.

Configuration Examples

To propagate network 172.0.0.0 and suppress the more specific route 172.10.0.0:

```
dgs-6600:2>enable
dgs-6600:15#configure terminal
dgs-6600:15(config)#router bgp 65534
dgs-6600:15(config-router)#aggregate-address 172.0.0.0/8 summary-only
dgs-6600:15(config-router)#
```

Specifying the Networks Advertised by BGP

Use the **network** command in BGP router configuration mode to configure the networks advertised by the Border Gateway Protocol (BGP) process.

BGP networks can be learned from connected routes, from dynamic routing, and from static route sources.

Use this command to specify a network as local to this autonomous system and adds it to the BGP routing table. For exterior protocols the **network** command controls which networks are advertised. Interior protocols use the **network** command to determine where to send updates.

The maximum number of supported network entries is project dependent.

The BGP will advertise a network entry if the router has the route information for this entry if synchronize state is enabled.

Command	Explanation
<code>enable [privilege LEVEL]</code>	Enter privileged EXEC mode.
<code>configure terminal</code>	Enter Global configuration mode.
<code>router bgp AS-NUMBER</code>	Enter the following information to configure BGP routing process and enter into BGP configuration mode.
<code>network {NETWORK-NUMBER [/SUBNET-LENGTH] NETWORK-NUMBER [mask NETWORK-NUMBER]} [route-map MAP-TAG]</code>	Enter the command to setup the networks that will be included in BGP updates.

Configuration Example

The following example sets up network 10.108.0.0 to be included in the BGP updates for AS number 65100:

```
dgs-6600:2>enable
dgs-6600:15#configure terminal
dgs-6600:15(config)#router bgp 65100
dgs-6600:15(config-router)#network 10.108.0.0
dgs-6600:15(config-router)#
```

Enabling the BGP Routing Process

Use the `router bgp` command to enable and configure the BGP routing process.

Each public autonomous system that directly connects to the Internet is assigned a unique number that identifies both the BGP routing process and the autonomous system (a number from 1 to 64511). Private autonomous system numbers are in the range from 64512 to 65534 (65535 is reserved for special use).

The BGP support 4-byte AS number which following RFC 5396 and RFC 4893. About the 4-byte AS number represent, the BGP support "asplain" and "asdot" notation. The "65546" is similar to "1.10"

Private autonomous system numbers can be used for internal routing domains but must be translated for traffic that is routed out to the Internet. BGP should not be configured to advertise private autonomous system numbers to external networks.

Use this command to enter router configuration mode for the specified routing process.

Command	Explanation
<code>enable [privilege LEVEL]</code>	Enter privileged EXEC mode.
<code>configure terminal</code>	Enter Global configuration mode.
<code>router bgp AS-NUMBER</code>	Enter the following information to configure BGP routing process and enter into BGP configuration mode.

Configuration Example

The following example shows you how to configure a BGP process for autonomous system 65534:

```
dgs-6600:2>enable
dgs-6600:15#configure terminal
dgs-6600:15(config)#router bgp 6534
dgs-6600:15(config-router)#
```

Adjusting the BGP Network Timers

Use the **timers bgp** command to adjust BGP network timers.

The suggested default value for the KEEP-ALIVE is 1/3 of the HOLD-TIME. The timers configured for a specific neighbor or peer group (by the command **neighbor timers**) override the timers configured for all BGP neighbors using the **timers bgp** command.

When the minimum acceptable HOLD-TIME is configured on a BGP router, a remote BGP peer session is established only if the remote peer is advertising a HOLD-TIME that is equal to, or greater than, the minimum acceptable HOLD-TIME interval. If the minimum acceptable HOLD-TIME interval is greater than the configured HOLD-TIME, the next time the remote session tries to establish, it will fail and the local router will send a notification stating "unacceptable hold time."

Command	Explanation
enable [<i>privilege LEVEL</i>]	Enter privileged EXEC mode.
configure terminal	Enter Global configuration mode.
router bgp AS-NUMBER	Enter the following information to configure BGP routing process and enter into BGP configuration mode.
timers bgp KEEP-ALIVE [HOLD-TIME]	Enter the command to configure BGP network timers.

Configuration Example

To change the keepalive timer for BGP Autonomous System 65100 to 50 seconds and the hold-time timer to 150 seconds:

```
dgs-6600:2>enable
dgs-6600:15#configure terminal
dgs-6600:15(config)#router bgp 65100
dgs-6600:15(config-router)#timers bgp 50 150
```

Configuring Fixed Router ID for LBGP BGP Routing Process

Use the **bgp router-id** command to configure a fixed router ID for the local Border Gateway Protocol (BGP) routing process.

The local router ID is selected by the following rules:

- If a loopback interface is configured, the router ID is set to the IP address of the loopback. If multiple loopback interfaces are configured, the loopback with the highest IP address is used.
- If no loopback interface is configured, the router ID is set to the highest IP address on a physical interface.

The **bgp router-id** command is used to configure a fixed router ID for a local BGP routing process.

The address of a loopback interface is preferred to an IP address on a physical interface because the loopback interface is more effective than a fixed interface as an identifier because there is no physical link to go down.

You must specify a unique router ID within the network.

This command will reset all active BGP peering sessions.

It is recommended to configure a loopback interface, since the physical interface link may be up/down/removed for some reason.

Command	Explanation
<code>enable [privilege LEVEL]</code>	Enter privileged EXEC mode.
<code>configure terminal</code>	Enter Global configuration mode.
<code>router bgp AS-NUMBER</code>	Enter the following information to configure BGP routing process and enter into BGP configuration mode.
<code>bgp router-id IP-ADDRESS</code>	Enter the following command to configure a fixed router ID for the local BGP routing process.

Configuration Example

To change the router ID to 192.168.1.1 for the local BGP routing process:

```
dgs-6600:2>enable
dgs-6600:15#configure terminal
dgs-6600:15(config)#router bgp 65100
dgs-6600:15(config-router)#bgp router-id 192.168.1.1
dgs-6600:15(config-router)#
```

Comparing (MED) for Paths from Neighbors in Different Autonomous Systems

Use the **bgp always-compare-med** command to compare the Multi Exit Discriminator (MED) for paths from neighbors in different autonomous systems.

The MED, as stated in RFC 1771, is an optional non-transitive attribute that is a four octet non-negative integer. The value of this attribute may be used by the BGP best path selection process to discriminate among multiple exit points to a neighboring autonomous system.

The MED is one of the parameters that is considered when selecting the best path among many alternative paths. The path with a lower MED is preferred over a path with a higher MED. During the best-path selection process, MED comparison is done only among paths from the same autonomous system. The **bgp always-compare-med** command is used to change this behavior by enforcing MED comparison between all paths, regardless of the autonomous system from which the paths are received.

The **bgp deterministic-med** command can be configured to enforce deterministic comparison of the MED value between all paths received from within the same autonomous system.

Command	Explanation
<code>enable [privilege LEVEL]</code>	Enter privileged EXEC mode.
<code>configure terminal</code>	Enter Global configuration mode.
<code>router bgp AS-NUMBER</code>	Enter the following information to configure BGP routing process and enter into BGP configuration mode.
<code>bgp always-compare-med</code>	Enter the following command to enforce MED comparison between all paths.

Configuration Example

The following example shows you how to configure the Switch to compare the MED from alternative paths, regardless of the autonomous system the paths were received from:

```
dgs-6600:2>enable
dgs-6600:15#configure terminal
dgs-6600:15(config)#router bgp 65534
dgs-6600:15(config-router)#bgp always-compare-med
dgs-6600:15(config-router)#
```

Configuring BGP to Not Use As-Path Factor for Selecting the Best Path

Use the `bgp bestpath as-path ignore` command to configure BGP so that it does not use the as-path factor to select the best path.

The following are the best path selection rules:

- 1) If the next hop associated with the route is unreachable, then the route is dropped.
- 2) Then route with the largest weight is selected.
- 3) If the next hop associated with the router is unreachable, then the route is dropped.
- 4) Then the route with the largest weight is selected.
- 5) If the weight cannot be determined, then the largest LOCAL_PREF is used to determine the preferred route.
- 6) If the preferred route still cannot be determined, then the route with the shortest AS_PATH list is preferred.
- 7) If the preferred route still cannot be determined, then the lowest origin type is preferred.
- 8) If the preferred route still cannot be determined, then the lowest MED is preferred.
- 9) If the preferred route still cannot be determined, then eBGP is preferred over iBGP paths.
- 10) The path with the lowest IGP metric is preferred to the BGP next hop.
- 11) Determine if multiple paths require installation in the routing table for BGP Multipath.
- 12) When both paths are external, prefer the path that was received first (the oldest one). Skip this step if the `bgp bestpath compare-routerid` command is configured.
- 13) Prefer the route that comes from the BGP router with the lowest router ID.
- 14) If the originator or router ID is the same for multiple paths, prefer the path with the minimum cluster list length.
- 15) Prefer the path that comes from the lowest neighbor address.

The `bgp always-compare-med`, `bgp bestpath as-path ignore`, `bgp bestpath compare-router-id` or `bgp default local-preference` commands to customize the path selection process.

Command	Explanation
<code>enable [privilege LEVEL]</code>	Enter privileged EXEC mode.

Command	Explanation
<code>configure terminal</code>	Enter Global configuration mode.
<code>router bgp AS-NUMBER</code>	Enter the following information to configure BGP routing process and enter into BGP configuration mode.
<code>bgp bestpath as-path ignore</code>	Enter the following command to enforce the BGP as-path ignore factor to select the best path.

Configuration Example

The following example shows you how to configure BGP to ignore the AS-PATH for the best path for autonomous system 65534:

```
dgs-6600:2>enable
dgs-6600:15#configure terminal
dgs-6600:15(config)#router bgp 65534
dgs-6600:15(config-router)#bgp bestpath as-path ignore
dgs-6600:15(config-router)#
```

Comparing Router IDs for Identical eBGP Paths

Use the `bgp bestpath compare-routerid` command to compare router IDs for identical eBGP paths.

When comparing similar routes from peers the BGP router does not consider router ID of the routes. By default, it selects the first received route. Use this command to include router ID in the selection process; similar routes are compared and the route with lowest router ID is selected. The router-id is the highest IP address on the router, with preference given to loopback addresses. The Router ID can be manually set by using the `bgp router-id` command.

Command	Explanation
<code>enable [privilege LEVEL]</code>	Enter privileged EXEC mode.
<code>configure terminal</code>	Enter Global configuration mode.
<code>router bgp AS-NUMBER</code>	Enter the following information to configure BGP routing process and enter into BGP configuration mode.
<code>bgp bestpath compare-routerid</code>	Enter the following command to enforce BGP to compare router IDs for identical eBGP paths.

Configuration Example

To compare router IDs for identical eBGP paths for autonomous system 65534:

```
dgs-6600:2>enable
dgs-6600:15#configure terminal
dgs-6600:15(config)#router bgp 65534
dgs-6600:15(config-router)#bgp bestpath compare-router-id
dgs-6600:15(config-router)#
```

Configuring BGP Defaults and Activating IPv4-Unicast for Peers

The `bgp default ipv4-unicast` command is used to enable the automatic exchange of IPv4 address family prefixes.

Command	Explanation
<code>enable [privilege LEVEL]</code>	Enter privileged EXEC mode.
<code>configure terminal</code>	Enter Global configuration mode.
<code>router bgp AS-NUMBER</code>	Enter the following information to configure BGP routing process and enter into BGP configuration mode.
<code>bgp default ipv4-unicast</code>	Enter the following command to enable the automatic exchanged of IPv4 address family prefixes.

Configuration Example

To configure BGP defaults and activate IPv4-unicast for a peer by default for autonomous system 65534:

```
dgs-6600:2>enable
dgs-6600:15#configure terminal
dgs-6600:15(config)#router bgp 65534
dgs-6600:15(config-router)#bgp default ipv4-unicast
dgs-6600:15(config-router)#
```

Changing Default Local Preference Value

The **local preference** attribute is a discretionary attribute that is used to apply the degree of preference to a route during the BGP best path selection process.

This attribute is exchanged only between iBGP peers and is used to determine local policy. The route with the highest local preference is preferred.

Command	Explanation
<code>enable [privilege LEVEL]</code>	Enter privileged EXEC mode.
<code>configure terminal</code>	Enter Global configuration mode.
<code>router bgp AS-NUMBER</code>	Enter the following information to configure BGP routing process and enter into BGP configuration mode.
<code>bgp default local-preference NUMBER</code>	Enter the following command to change the default local preference value.

Configuration Example

To configure the default value of the local preference to 200 for autonomous system 65534:

```
dgs-6600:2>enable
dgs-6600:15#configure terminal
dgs-6600:15(config)#router bgp 65534
dgs-6600:15(config-router)#bgp default local-preference 200
dgs-6600:15(config-router)#
```

Configuring (MED) Values Inclusions Between Paths in Autonomous Systems

Use the **bgp deterministic-med** command to include the Multi Exit Discriminator (MED) value between all paths received from within the same autonomous system in the selection of the best route selection.

The **bgp always-compare-med** command is used to enable the comparison of the Multi Exit Discriminator (MED) for paths from neighbors in different autonomous systems. After the **bgp always-compare-med** command is configured, all paths for the same prefix that are received from different neighbors, which are in the same autonomous system, will be grouped together and sorted by the ascending MED value (received-only paths are ignored and not grouped or sorted).

The best path selection algorithm will then pick the best paths using the existing rules; the comparison is made on a per neighbor autonomous system basis and then on a global basis. The grouping and sorting of paths occurs immediately after this command is entered. For correct results, all routers in the local autonomous system must have this command enabled (or disabled).

Enter the following command to enforce the inclusion of the Multi Exit Discriminator (MED) value between all

Command	Explanation
<code>enable [privilege LEVEL]</code>	Enter privileged EXEC mode.
<code>configure terminal</code>	Enter Global configuration mode.
<code>router bgp AS-NUMBER</code>	Enter the following information to configure BGP routing process and enter into BGP configuration mode.
<code>bgp deterministic-med</code>	paths received from within the same autonomous system in the selection of the best route selection.

Configuration Example

To configure BGP to enable the compare MED value for autonomous system 65534:

```
dgs-6600:2>enable
dgs-6600:15#configure terminal
dgs-6600:15(config)#router bgp 65534
dgs-6600:15(config-router)#bgp deterministic-med
dgs-6600:15(config-router)#
```

Configuring BGP to Enforce First Autonomous Systems for eBGP Routes

The **bgp enforce-first-as** command specifies that any updates received from an external neighbor that do not have the neighbor's configured Autonomous System (AS) at the beginning of the AS_PATH in the received update must be denied. Enabling this feature add to the security of the BGP network by not allowing traffic from unauthorized systems.

Command	Explanation
<code>enable [privilege LEVEL]</code>	Enter privileged EXEC mode.
<code>configure terminal</code>	Enter Global configuration mode.
<code>router bgp AS-NUMBER</code>	Enter the following information to configure BGP routing process and enter into BGP configuration mode.
<code>bgp enforce-first-as</code>	Use the following command to enforce the first Autonomous System for the eBGP routes.

Configuration Example

The following example shows you how to enable the security of the BGP network for autonomous system 65534. All incoming updates from eBGP peers are examined to ensure that the first AS number in the AS-path is the local AS number of the transmitting pair:

```
dgs-6600:2>enable
dgs-6600:15#configure terminal
dgs-6600:15(config)#router bgp 65534
dgs-6600:15(config-router)#bgp enforce-first-as
dgs-6600:15(config-router)#
```

Enabling Logging of BGP Neighbor Resets

The **bgp log-neighbor-changes** command enables logging of BGP neighbor status changes (up or down) and resets for troubleshooting network connectivity problems and measuring network stability.

Unexpected neighbor resets might indicate high error rates or high packet loss in the network and should be investigated.

The neighbor status change messages are not tracked if the **bgp log-neighbor-changes** command is not enabled, except for the reset reason, which is always available as output of the **show ip bgp neighbors** command.

Command	Explanation
enable [<i>privilege LEVEL</i>]	Enter privileged EXEC mode.
configure terminal	Enter Global configuration mode.
router bgp AS-NUMBER	Enter the following information to configure BGP routing process and enter into BGP configuration mode.
bgp log-neighbor-changes	Use the following command to enable the logging of BGP neighbor resets.

Configuration Examples

The following example shows you how to enable the logging of BGP neighbor changes for autonomous system 65534:

```
dgs-6600:2>enable
dgs-6600:15#configure terminal
dgs-6600:15(config)#router bgp 65534
dgs-6600:15(config-router)#bgp log-neighbor-changes
dgs-6600:15(config-router)#
```

Defining a BGP Autonomous System Path Access List

Use the **ip as-path access-list** command to define a BGP Autonomous System (AS) path access list.

A named community list is a filter based on regular expressions. If the regular expression matches the specified string representing the AS path of the route, then the permit or deny condition applies. Use this command to define the BGP access list globally, use the **neighbor filter-list** router configuration command to apply a specific access list.

Multiple commands can be applied to a list name.

Command	Explanation
<code>enable [privilege LEVEL]</code>	Enter privileged EXEC mode.
<code>configure terminal</code>	Enter global configuration mode.
<code>ip as-path access-list ACCESS-LIST-NAME {permit deny} REGEXP</code>	Enter the following command to define a BGP Autonomous System (AS) path access list.

Configuration Example

To define an AS path access-list named *mylist* to deny access to the neighbor with AS number 65535:

```
dgs-6600:2>enable
dgs-6600:15#configure terminal
dgs-6600:15(config)#ip as-path access-list mylist deny 65535
dgs-6600:15(config)#
```

Creating a Community List Entry

Use the `ip community-list` command to add a community list entry.

Community Lists are used to specify BGP community attributes. The community attribute is used for implementing policy routing. It is an optional, transitive attribute and facilitates transfer of local policies through different autonomous systems. It includes community values that are 32 bits long.

The `ip community-list` command can be applied multiple times.

If the `no ip community access-list` command is used without specifying the `permit` or `deny` keywords, all communities bonded at the specified access lists will be removed.

Command	Explanation
<code>enable [privilege LEVEL]</code>	Enter privileged EXEC mode.
<code>configure terminal</code>	Enter global configuration mode.
<code>ip community-list COMMUNITY-LIST-NAME {permit deny} COMMUNITY</code>	Enter the <code>ip community-list</code> command to define community lists.

Configuration Example

The following example shows you how to create a community-list named *mycommlist*, that permits routes from network 10 in autonomous system 50000:

```
dgs-6600:2>enable
dgs-6600:15#configure terminal
dgs-6600:15(config)#ip community-list mycommlist permit 50000:10
dgs-6600:15(config)#
```

Setting Minimum Interval Between BGP Routing Updates

Use the `neighbor advertisement interval` command to set the minimum interval between the sending of Border Gateway Protocol (BGP) routing updates.

If you specify a BGP peer group by using the *PEER-GROUP-NAME* argument, all the members of the peer group will inherit the characteristic configured with this command.

Command	Explanation
<code>enable [privilege LEVEL]</code>	Enter privileged EXEC mode.
<code>configure terminal</code>	Enter global configuration mode.
<code>router bgp AS-NUMBER</code>	Use this command to enable (configure) BGP routing process. This command mode must be entered to execute any BGP Router configuration commands, such as "neighbor remote-as". Use the no form of the command to remove a BGP routing process.
<code>neighbor {IP-ADDRESS PEER-GROUP-NAME} advertisement-interval SECONDS</code>	Configures the minimum time between sending BGP routing updates. please note that this command can only be executed after you have enabled the configure BGP routing process mode (Please see router bgp AS-NUMBER). Use the no form of this command to remove an entry from the table.

Configuration Example

The following example configures the minimum time between sending BGP routing updates to be 15 seconds:

```
dgs-6600:2>enable
dgs-6600:15#configure terminal
dgs-6600:15(config)#router bgp 65100
dgs-6600:15(config-router)#address-family ipv4
dgs-6600:15(config-router-af)#neighbor 10.4.4.4 advertisement-interval 15
```

Creating a Description for a Neighbor

Use the **neighbor description** command to associate a description with a neighbor.

If you specify a BGP peer group by using the PEER-GROUP-NAME argument, all the members of the peer group will inherit the characteristic (description) configured with this command.

Command	Explanation
<code>enable [privilege LEVEL]</code>	Enter privileged EXEC mode.
<code>configure terminal</code>	Enter global configuration mode.
<code>router bgp AS-NUMBER</code>	Use this command to enable (configure) BGP routing process. This command mode must be entered to execute any BGP Router configuration commands, such as "neighbor remote-as". Use the no form of the command to remove a BGP routing process.

Command	Explanation
<code>neighbor {IP-ADDRESS PEER-GROUP-NAME} description TEXT</code>	Enter the following command to associate a description with a neighbor. Please note that this command can only be executed after you have enabled the configure BGP routing process mode (Please see <code>router bgp AS-NUMBER</code>). Use the no form of this command to remove an entry from the table.

Configuration Example

To configure a description of *ABC in China* for the neighbor 172.16.10.10:

```
dgs-6600:2>enable
dgs-6600:15#configure terminal
dgs-6600:15(config)#router bgp 109
dgs-6600:15(config-router)#neighbor 172.16.10.10 description ABC in China
dgs-6600:15(config-router)#
```

Setting Up BGP Filters

The **neighbor filter-list** command specifies an access list filter based on updates from the BGP autonomous system paths. Each filter is an as-path access list based on regular expressions.

Each neighbor can only have one in and one out access list.

Command	Explanation
<code>enable [privilege LEVEL]</code>	Enter privileged EXEC mode.
<code>configure terminal</code>	Enter global configuration mode.
<code>router bgp AS-NUMBER</code>	Use this command to enable (configure) BGP routing process. This command mode must be entered to execute any BGP Router configuration commands, such as "neighbor remote-as". Use the no form of the command to remove a BGP routing process.
<code>neighbor {IP-ADDRESS PEER-GROUP-NAME} filter-list AS-PATH-LIST-NAME {in out}</code>	Enter the following command to specify an access list filter based on updates from the BGP autonomous system paths. Please note that this command can only be executed after you have enabled the configure BGP routing process mode (Please see <code>router bgp AS-NUMBER</code>). Use the no form of this command to remove an entry from the table.

Configuration Example

To configure the BGP neighbor with IP address 172.16.1.1 to not send advertisements about any path through or from the adjacent autonomous system 123:

```
dgs-6600:2>enable
dgs-6600:15#configure terminal
dgs-6600:15(config)#ip as-path access-list myacl deny 123
dgs-6600:15(config)#ip as-path access-list myacl permit .*
dgs-6600:15(config)#router bgp 65100
dgs-6600:15(config-router)#network 10.108.0.0
dgs-6600:15(config-router)#neighbor 192.168.6.6 remote-as 123
dgs-6600:15(config-router)#neighbor 172.16.1.1 remote-as 47
dgs-6600:15(config-router)#neighbor 172.16.1.1 filter-list myacl out
dgs-6600:15(config-router)#
```

Creating a BGP Peer Group

Use the **neighbor peer-group** command to create a peer group.

Often in a BGP or multi-protocol BGP speaker, many neighbors are configured with the same update policies (that is, same outbound route maps, distribute lists, filter lists, update source, and so on). Neighbors with the same update policies can be grouped into peer groups to simplify configuration and make update calculation more efficient.

Command	Explanation
enable [<i>privilege LEVEL</i>]	Enter privileged EXEC mode.
configure terminal	Enter global configuration mode.
router bgp AS-NUMBER	Use this command to enable (configure) BGP routing process. This command mode must be entered to execute any BGP Router configuration commands, such as "neighbor remote-as". Use the no form of the command to remove a BGP routing process.
neighbor PEER-GROUP-NAME peer-group	Use this command to create a peer group. Use the no form of the command to remove the peer group

Configuration Example

The following example shows you how to create a peer group called ALPHA-GROUP:

```
dgs-6600:2>enable
dgs-6600:15#configure terminal
dgs-6600:15(config)#router bgp 65100
dgs-6600:15(config-router)#neighbor ALPHA-GROUP peer-group
dgs-6600:15(config-router)#
```

Adding a Neighbor to a BGP Peer Group

Use the **neighbor peer-group** command to add a neighbor to a peer group.

After adding a neighbor to the peer group, it will inherit all the configured options of the peer group.

Command	Explanation
<code>enable [privilege LEVEL]</code>	Enter privileged EXEC mode.
<code>configure terminal</code>	Enter global configuration mode.
<code>router bgp AS-NUMBER</code>	Use this command to enable (configure) BGP routing process. This command mode must be entered to execute any BGP Router configuration commands, such as "neighbor remote-as". Use the no form of the command to remove a BGP routing process.
<code>neighbor IPV4-ADDRESS peer-group PEER-GROUP-NAME</code>	Enter the following command to add a neighbor to a peer group. Please note that this command can only be executed after you have enabled the configure BGP routing process mode (Please see router bgp AS-NUMBER). Use the no form of this command to remove an entry from the table.

Configuration Example

The following example shows you how to add the group member 10.1.1.254 to the peer group called *ALPHA-GROUP*:

```
dgs-6600:2>enable
dgs-6600:15#configure terminal
dgs-6600:15(config)#router bgp 65100
dgs-6600:15(config-router)#neighbor ALPHA-GROUP peer-group
dgs-6600:15(config-router)#neighbor 10.1.1.254 peer-group ALPHA-GROUP
dgs-6600:15(config-router)#
```

Adding an Entry to the BGP Neighbor Table

Use the **neighbor remote-as** command to add an entry to the Border Gateway Protocol (BGP) neighbor table.

You can use this command to add the IP address of the neighbor in the specified autonomous system to the BGP neighbor table of the local router.

Specifying a neighbor with an autonomous system number that matches the autonomous system number specified in the router bgp global configuration command identifies the neighbor as internal to the local autonomous system. Otherwise, the neighbor is considered external.

If you specify a BGP peer group by using the PEER-GROUP-NAME argument, all the members of the peer group will inherit the characteristic configured with this command.

By default, neighbors that are defined using the **neighbor remote-as** command in router configuration mode exchange only unicast address prefixes.

Command	Explanation
<code>enable [privilege LEVEL]</code>	Enter privileged EXEC mode.
<code>configure terminal</code>	Enter global configuration mode.

Command	Explanation
<code>router bgp AS-NUMBER</code>	Use this command to enable (configure) BGP routing process. This command mode must be entered to execute any BGP Router configuration commands, such as "neighbor remote-as". Use the no form of the command to remove a BGP routing process.
<code>neighbor [IPV4-ADDRESS PEER-GROUP-NAME] remote-as AS-NUMBER</code>	Use this command to add an entry to the Border Gateway Protocol (BGP) neighbor table. Use the no form of this command to remove an entry from the table. Please note that this command can only be executed after you have enabled the configure BGP routing process mode (Please see <code>router bgp AS-NUMBER</code>). Use the no form of this command to remove an entry from the table.

Configuration Example

The following example shows you how to specify that a router with the IP address 10.108.2.1 is a neighbor in the autonomous system:

```
dgs-6600:2>enable
dgs-6600:15#configure terminal
dgs-6600:15(config)#router bgp 65100
dgs-6600:15(config-router)#network 10.108.0.0
dgs-6600:15(config-router)#neighbor 10.108.2.1 remote-as 100
dgs-6600:15(config-router)#
```

Applying Route Maps to Outgoing Routes

Use the `neighbor route-map` command to apply a route map to incoming or outgoing routes.

When specified in address family configuration mode, this command applies a route map to that particular address family only. When specified in router configuration mode, this command applies a route map to IP Version 4 unicast routes only.

If an outbound route map is specified, it is proper behavior to only advertise routes that match at least one section of the route map.

If you specify a BGP or multi-protocol BGP peer group by using the **PEER-GROUP-NAME** argument, all the members of the peer group will inherit the characteristic configured with this command. Specifying the command for a neighbor overrides the inbound policy that is inherited from the peer group.

Command	Explanation
<code>enable [privilege LEVEL]</code>	Enter privileged EXEC mode.
<code>configure terminal</code>	Enter global configuration mode.
<code>router bgp AS-NUMBER</code>	Use this command to enable (configure) BGP routing process. This command mode must be entered to execute any BGP Router configuration commands, such as "neighbor remote-as". Use the no form of the command to remove a BGP routing process.

Command	Explanation
<code>neighbor {IP-ADDRESS PEER-GROUP-NAME} route-map MAP-NAME {in out}</code>	Enter the following command to apply a route map to incoming or outgoing routes. Please note that this command can only be executed after you have enabled the configure BGP routing process mode (Please see <code>router bgp AS-NUMBER</code>). Use the <code>no</code> form of this command to remove an entry from the table.

Configuration Example

The following example applies a route map named *internal-map* to a BGP outgoing router from 172.16.70.24:

```
dgs-6600:2>enable
dgs-6600:15#configure terminal
dgs-6600:15 (config)#router bgp 5
dgs-6600:15 (config-router)#neighbor 172.16.70.24 route-map internal-map out
dgs-6600:15 (config-router)#exit
dgs-6600:15 (config-router)#route-map internal-map permit 1
dgs-6600:15 (config-router-map)#match as-path 1
dgs-6600:15 (config-router-map)#set origin egp
dgs-6600:15 (config-router-map)#end
```

Specifying that Communities Attribute should be Sent to BGP Neighbors

Use the `neighbor send-community` command to specify that the communities attribute should be sent to BGP neighbors.

If you have specified a BGP peer group using the *PEER-GROUP-NAME* argument, all the members of the peer group will inherit the characteristics configured with this command.

Command	Explanation
<code>enable [privilege LEVEL]</code>	Enter privileged EXEC mode.
<code>configure terminal</code>	Enter global configuration mode.
<code>router bgp AS-NUMBER</code>	Use this command to enable (configure) BGP routing process. This command mode must be entered to execute any BGP Router configuration commands, such as "neighbor remote-as". Use the <code>no</code> form of the command to remove a BGP routing process.
<code>address-family ipv4 [unicast]</code>	Enter the following command to enter IPv4 address family configuration mode. Please note that this command can only be executed after you have enabled the configure BGP routing process mode (Please see <code>router bgp AS-NUMBER</code>). Use the <code>no</code> form of this command to remove an entry from the table.

Command	Explanation
<code>neighbor {IP-ADDRESS PEER-GROUP-NAME} send-community [both standard extended]</code>	Enter the following command to specify that the communities attribute should be sent to BGP neighbors. Please note that this command can only be executed after you have enabled the configure BGP routing process mode (Please see router bgp AS-NUMBER). Use the no form of this command to remove an entry from the table.

Configuration Example

The following address family configuration mode example sets the send-community for both community types (standard and extended):

```
dgs-6600:2>enable
dgs-6600:15#configure terminal
dgs-6600:15(config)#router bgp 65100
dgs-6600:15(config-router)#address-family ipv4
dgs-6600:15(config-router-af)#neighbor 10.4.4.4 send-community both
dgs-6600:15(config-router-af)#
```

Disabling a Neighbor or Peer Group

The **neighbor shutdown** command can be used to terminate any active session for the specified neighbor or peer group and removes all associated routing information. In the case of a peer group, a large number of peering sessions could be terminated suddenly.

Command	Explanation
<code>enable [privilege LEVEL]</code>	Enter privileged EXEC mode.
<code>configure terminal</code>	Enter global configuration mode.
<code>router bgp AS-NUMBER</code>	Use this command to enable (configure) BGP routing process. This command mode must be entered to execute any BGP Router configuration commands, such as "neighbor remote-as". Use the no form of the command to remove a BGP routing process.
<code>address-family ipv4 [unicast]</code>	Enter the following command to enter IPv4 address family configuration mode. Please note that this command can only be executed after you have enabled the configure BGP routing process mode (Please see router bgp AS-NUMBER). Use the no form of this command to remove an entry from the table.
<code>neighbor {IP-ADDRESS PEER-GROUP-NAME} shutdown</code>	Enter the following commands to disable a neighbor or peer group. Please note that this command can only be executed after you have enabled the configure BGP routing process mode (Please see router bgp AS-NUMBER). Use the no form of this command to remove an entry from the table.

Configuring the BGP Origin Code

Use the **set origin** command to set the BGP origin code.

Use the **route-map** global configuration command, and the **match** and **set route-map** configuration commands, to define the conditions for redistributing routes from one routing protocol into another. Each **route-map** command has a list of **match** and **set** commands associated with it. The **match** commands specify the match criteria—the conditions under which redistribution is allowed for the current route-map command. The **set** commands specify the set actions—the particular redistribution actions to perform if the criteria enforced by the **match** commands are met. The **no route-map** command deletes the route map.

The **set route-map** configuration commands specify the redistribution set actions to be performed when all of the match criteria of a route map are met. When all match criteria are met, all set actions are performed.

The origin code (ORIGIN) is a well-known mandatory attribute that indicates the origin of the prefix or, rather, the way in which the prefix was injected into BGP. There are three origin codes, listed in order of preference:

- IGP: Means that the prefix originated from information learned from an interior gateway protocol.
- EGP: Means that the prefix originated from an exterior gateway protocol, which BGP replaced.
- INCOMPLETE: Means that the prefix originated from an unknown source.

Command	Explanation
<code>enable {privilege LEVEL}</code>	Enter privileged EXEC mode.
<code>configure terminal</code>	Enter global configuration mode
<code>route-map MAP-NAME {permit deny} SEQUENCE-NUM</code>	Enter this command to enter route-map configuration mode
<code>match aspath AS-PATH-LIST</code>	Enter the following command to match a BGP autonomous system path to an access-list
<code>set origin {igp egp incomplete}</code>	Enter the following command to set the BGP origin

Configuration Example

To set the origin of routes that pass the route map named *myPolicy* and match the AS path *PATH_ACL* to EGP:

```
dgs-6600:2>enable
dgs-6600:15#configure terminal
dgs-6600:15(config)#route-map myPolicy permit 1
dgs-6600:15(config-route-map)#match as-path PATH_ACL
dgs-6600:15(config-route-map)#set origin egp
dgs-6600:15(config-route-map)#
```

BGP Synchronization

Usually, a BGP speaker does not advertise a route to an external neighbor unless that route is local or exists in the IGP. By default, synchronization between BGP and the IGP is turned off to allow the switch to advertise a network route without waiting for route validation from the IGP. This feature allows routers and access servers within an autonomous system to have the route before BGP makes it available to other autonomous systems.

Command	Explanation
<code>enable [privilege LEVEL]</code>	Enter privileged EXEC mode.

Command	Explanation
<code>configure terminal</code>	Enter global configuration mode.
<code>router bgp AS-NUMBER</code>	Use this command to enable (configure) BGP routing process. Use the no form of the command to remove a BGP routing process.
<code>synchronization</code>	Enter the following command to enable the synchronization between a BGP and IGP system.

Configuration Example

To enable synchronization in autonomous system 65121:

```
dgs-6600:2>enable
dgs-6600:15#configure terminal
dgs-6600:15(config)#router bgp 65121
dgs-6600:15(config-router)#synchronization
dgs-6600:15(config-router)#
```

Displaying the BGP Routing Table

Use the **show ip bgp** command in user or privileged EXEC mode to display the entries in the Border Gateway Protocol (BGP) routing table.

Configuration Example

The following example shows you the output from a BGP routing table, using the **show ip bgp** command:

```
dgs-6600:2>show ip bgp
BGP table version: 13, local-router ID: 10.1.1.99
Status codes: s suppressed, d damped, h history, * valid, > best, i - internal,
               S Stale
Origin codes: i - IGP, e -EGP, ? - incomplete

   Network          Next Hop        Metric   LocPrf  Weight    Path
  -----          -
*> 10.1.1.0/24      0.0.0.0          0             32768    i
*> 172.17.1.0/24    0.0.0.0          0             0      45000 i

Total Entries: 2 entries, 2 routes
dgs-6600:2>
```

The following example shows you the output from a BGP routing table, using the **show ip bgp** command with the **route-map** keyword:

```
dgs-6600:2>show ip bgp route-map RMA1
BGP table version is 845, local router ID is 11.0.9.254
Status codes: s suppressed, d damped, h history, * valid, > best, i - internal,
               S Stale
Origin codes: i - IGP, e -EGP, ? - incomplete

   Network          Next Hop        Metric   LocPrf  Weight    Path
   -----          -
*> 201.0.1.0/24     11.0.9.1         0         0         0 1701 i
*> 201.0.2.0/24     11.0.9.1         0         0         0 1701 i
*> 201.0.3.0/24     11.0.9.1         0         0         0 1701 i
*> 201.0.4.0/24     11.0.9.1         0         0         0 1701 i

Total Entries: 4 entries, 4 routes
dgs-6600:2>
```

Displaying the Configured Community Lists

This command can be used without any arguments or keywords. If no arguments are specified, this command will display all community lists. However, the community list name can be specified when entering the **show ip community-list** command. This option can be useful for filtering the output of this command and verifying a single Command Syntax Use the following command in user or privileged EXEC mode to display the configured community lists:

Configuration Example

The following example shows you the output when using the **show ip community-list** command:

```
dgs-6600:2>show ip community-list
Named Community standard list C1
  permit internet
Named Community standard list C2
  permit internet
dgs-6600:2>
```

Displaying Routes that Conform to a Specified Filter List

Configuration Example

To display the contents of an access-list named *as-ACL_HQ*:

```

dgs-6600:2>show ip bgp filter-list as-ACL_HQ
BGP table version is 1738, local router ID is 172.16.72.24
BGP table version is 845, local router ID is 11.0.9.254
Status codes: s suppressed, d damped, h history, * valid, > best, i - internal,
               S Stale
Origin codes: i - IGP, e -EGP, ? - incomplete

   Network          Next Hop          Metric   LocPrf  Weight   Path
   -----          -
* 172.16.0.0        172.16.72.30      0         109     108     ?
* 172.16.1.0        172.16.72.30      0         109     108     ?
* 172.16.11.0       172.16.72.30      0         109     108     ?
* 172.16.14.0       172.16.72.30      0         109     108     ?
* 172.16.15.0       172.16.72.30      0         109     108     ?
* 172.16.16.0       172.16.72.30      0         109     108     ?
* 172.16.17.0       172.16.72.30      0         109     108     ?
* 172.16.18.0       172.16.72.30      0         109     108     ?
* 172.16.19.0       172.16.72.30      0         109     108     ?
* 172.16.24.0       172.16.72.30      0         109     108     ?
* 172.16.29.0       172.16.72.30      0         109     108     ?
* 172.16.30.0       172.16.72.30      0         109     108     ?
* 172.16.33.0       172.16.72.30      0         109     108     ?
* 172.16.35.0       172.16.72.30      0         109     108     ?
* 172.16.36.0       172.16.72.30      0         109     108     ?
* 172.16.37.0       172.16.72.30      0         109     108     ?
* 172.16.38.0       172.16.72.30      0         109     108     ?
* 172.16.39.0       172.16.72.30      0         109     108     ?

Total Entries: 18 entries, 18 routes
dgs-6600:2>

```

Displaying BGP Permitted Routes

Use the **show ip bgp community-list** command to display routes that are permitted by the Border Gateway Protocol (BGP) community list.

Configuration Example

The following example shows you the sample output from the **show ip bgp community-list** command:

```

dgs-6600:2>show ip bgp community-list MarketingCommunity
BGP table version is 716977, local router ID is 192.168.32.1
BGP table version is 845, local router ID is 11.0.9.254
Status codes: s suppressed, d damped, h history, * valid, > best, i - internal,
               S Stale
Origin codes: i - IGP, e -EGP, ? - incomplete

   Network          Next Hop          Metric   LocPrf  Weight   Path
   -----          -
* i10.3.0.0         10.0.22.1         0        100     0    1800 1239 ?
*>i                 10.0.16.1         0        100     0    1800 1239 ?
* i10.6.0.0         10.0.22.1         0        100     0    1800 690 568 ?
*>i                 10.0.16.1         0        100     0    1800 690 568 ?
* i10.7.0.0         10.0.22.1         0        100     0    1800 701 35 ?
*>i                 10.0.16.1         0        100     0    1800 701 35 ?
*                   10.92.72.24         0        100     0    1878 704 701 35 ?
* i10.8.0.0         10.0.22.1         0        100     0    1800 690 560 ?
*>i                 10.0.16.1         0        100     0    1800 690 560 ?
*                   10.92.72.24         0        100     0    1878 704 701 560 ?
* i10.13.0.0        10.0.22.1         0        100     0    1800 690 200 ?
*>i                 10.0.16.1         0        100     0    1800 690 200 ?
*                   10.92.72.24         0        100     0    1878 704 701 200 ?
* i10.15.0.0        10.0.22.1         0        100     0    1800 174 ?
*>i                 10.0.16.1         0        100     0    1800 174 ?
* i10.16.0.0        10.0.22.1         0        100     0    1800 701 i
*>i                 10.0.16.1         0        100     0    1800 701 i
*                   10.92.72.24         0        100     0    1878 704 701 i

Total Entries: 18 entries, 7 routes
dgs-6600:2>

```

The following fields are displayed in the output:

Field	Description
BGP Table Version	Internal version number of the table. This number is incremented whenever the table changes.
Local Router ID	IP address of the Router.
Status Codes	Status of the table entry. The status is displayed at the beginning of each line in the table. It can be one of the following values: s—The table entry is suppressed. S— The table entry is stale. *—The table entry is valid. >— The table entry is the best entry to use for that network. i — The table entry was learned via an internal BGP (iBGP) session.

Table 30-1 Fields Displayed in show ip bgp community-list Output

Field	Description
Origin Codes	Origin of the entry. The origin code is placed at the end of each line in the table. It can be one of the following values: i—Entry originated from an Interior Gateway Protocol (IGP) and was advertised with a network router configuration command. e—Entry originated from an Exterior Gateway Protocol (EGP). ?—Origin of the path is not clear. Usually, this is a router that is redistributed into BGP from an IGP.
Network	IP address of a network entity.
Next Hop	IP address of the next system that is used when forwarding a packet to the destination network. An entry of 0.0.0.0 indicates that the router has some non-BGP routes to this network.
Metric	If shown, this is the value of the inter-autonomous system metric. This field is frequently not used.
LocPrf	Local preference value as set with the set local-preference route-map configuration command. The default value is 100.
Weight	Weight of the route as set via autonomous system filters.
Path	Autonomous system paths to the destination network. There can be one entry in this field for each autonomous system in the path.

Table 30-1 (continued) Fields Displayed in show ip bgp community-list Output

Displaying Information about BGP Neighbors

Use the **show ip bgp neighbors** command to display BGP and TCP connection information for neighbor sessions. For BGP, this includes detailed neighbor attribute, capability path, and prefix information. For TCP, this includes statistics related to BGP neighbor session establishment and maintenance.

When BGP neighbors use multiple levels of peer templates, it can be difficult to determine which policies are applied to the neighbor.

The output of this command displays all address family information if the keyword **ipv4** is not specified. You can specify the IP address of a neighbor to display information about the specific neighbor.

Configuration Example

The following example shows you how to display the 10.108.50.2 neighbor information. The neighbor is an internal BGP (iBGP) peer. This neighbor supports the router refresh and graceful restart capabilities:

```
dgs-6600:2>show ip bgp neighbors
BGP neighbor: 10.108.50.2, remote AS 1, internal link
Member of peer-group G1 for session parameters:
  BGP version: 4, remote router ID: 192.168.252.252
  BGP state = Established, up for 00H24M25S
  Last read: 00H24M24S, last write: 00H00M24S, hold time: 180 sec,
    keepalive interval: 60 sec

Neighbor capabilities:
  Route refresh: advertised and received (old & new)
  Graceful Restart Capability: advertised
  Address family IPv4 Unicast: advertised and received

Message statistics:
  InQ depth: 0
  OutQ depth: 0

                Sent          Rcvd
Opens:           3             3
Notifications:  0             0
Updates:         0             0
Keepalives:     113           112
Route Refresh:  0             0
Total:          116           115

Default minimum time between advertisement runs: 5 sec

For address family: IPv4 Unicast
  BGP table version: 1, neighbor version 1/0

  Index: 1, Offset: 0, Mask: 0x2
  1 update-group member
  Outbound path policy configured
  Router map for outgoing advertisements: R1
  Accepted prefixes: 0
  Announced prefixes: 0
dgs-6600:2>
```

The following example shows you how to display the routes advertised for only the 172.16.232.178 neighbor:

```
dgs-6600:2>show ip bgp neighbors 172.16.232.178 advertised-routes
BGP table version: 27, local router ID: 172.16.232.181

Status codes: s suppressed, d damped, h history, * valid, > best, i - internal
Origin codes: i - IGP, e -EGP, ? - incomplete

   Network          Next Hop          Metric   LocPrf  Weight    Path
   -----          -
*>i10.0.0.0        172.16.232.179      0       100      0         ?
*> 10.20.2.0       10.0.0.0            0                32768      i

Total Entries: 2 entries, 2 routes
dgs-6600:2>
```

Displaying IP Routes

Use the **show ip route** command to display the current state of the routing table.

The **show ip route static** command provides a way to display all static routes with name and distance information, including active and inactive ones. The **show ip route** and **show ip route static** commands can be used to display all static routes.

Configuration Example

The following examples show the standard routing tables displayed by the show ip route command. Use the codes displayed at the beginning of each report and the information in the following table to understand the type of route:

The following fields are displayed in the show ip route output:

Field	Description
O	Indicates the protocol that derived the route. It can be one of the following values: K— kernel route R—Routing Information Protocol (RIP) derived O—Open Shortest Path First (OSPF) derived C—connected i — IS-IS derived S — static B — Border Gateway Protocol (BGP) derived

Table 30-2

Field	Description
E2	Type of route. It can be one of the following values: *—Indicates the last path used when a packet was forwarded. It pertains only to the nonfast-switched packets. However, it does not indicate which path will be used next when forwarding a nonfast-switched packet, except when the paths are equal cost. IA—OSPF interarea route E1—OSPF external type 1 route E2—OSPF external type 2 route L1—IS-IS Level 1 route L2—IS-IS Level 2 route N1—OSPF not-so-stubby area (NSSA) external type 1 route N2 – OSPF NSSA external type 2 route P - stale route info
*	The route entry of RIB is populated in FIB.
>	The selected route of multiple route entries.
10.110.0.0	Indicates the address of the remote network.
[160/5]	The first number in the brackets is the administrative distance of the information source; the second number is the metric for the route.
via 10.119.254.6	Specifies the address of the next router to the remote network.
0:01:00	Specifies the last time the route was updated (in hours:minutes:seconds).
Vlan2	Specifies the interface through which the specified network can be reached.

Table 30-2

The following example shows you a sample output from the **show ip route** command when entered without an IP address:

```
dgs-6600:2>show ip route
Codes: K - kernel, C - connected, S - static, R - RIP, B - BGP, O - OSPF,
      IA - OSPF inter area
      N1 - OSPF NSSA external type 1, N2 - OSPF NSSA external type 2
      E1 - OSPF external type 1, E2 - OSPF external type 2 i - IS-IS,
      L1 - IS-IS level-1, L2 - IS-IS level-2, ia - IS-IS inter area
      > - selected route, * - FIB route, p - stale info
Gateway of last resort is 10.119.254.240 to network 10.140.0.0

O E2 10.110.0.0 [160/5] via 10.119.254.6, 0:01:00, vlan2
R 10.67.10.0 [200/128] via 10.119.254.244, 0:02:22, vlan2
O E2 10.68.132.0 [160/5] via 10.119.254.6, 0:00:59, vlan2
O E2 10.130.0.0 [160/5] via 10.119.254.6, 0:00:59, vlan2
R 10.128.0.0 [200/128] via 10.119.254.244, 0:02:22, vlan2
R 10.129.0.0 [200/129] via 10.119.254.240, 0:02:22, vlan2
R 10.65.129.0 [200/128] via 10.119.254.244, 0:02:22, vlan2
R 10.10.0.0 [200/128] via 10.119.254.244, 0:02:22, vlan2
R 10.75.139.0 [200/129] via 10.119.254.240, 0:02:23, vlan2
R 10.16.208.0 [200/128] via 10.119.254.244, 0:02:22, vlan2
R 10.84.148.0 [200/129] via 10.119.254.240, 0:02:23, vlan2
R 10.31.223.0 [200/128] via 10.119.254.244, 0:02:22, vlan2

Total Entries: 12 entries, 12 routes
dgs-6600:2>
```

The following example shows the output from the **show ip route database** command:

```
dgs-6600:2>show ip route database
Codes: K - kernel, C - connected, S - static, R - RIP, B - BGP, O - OSPF,
       IA - OSPF inter area
       N1 - OSPF NSSA external type 1, N2 - OSPF NSSA external type 2
       E1 - OSPF external type 1, E2 - OSPF external type 2 i - IS-IS,
       L1 - IS-IS level-1, L2 - IS-IS level-2, ia - IS-IS inter area
       # - A number of slots are inactive
       > - selected route, * - FIB route, p - stale info

O    100.10.10.0/24 [110/1] is directly connected, vlan1, 01:17:03
C *> 100.10.10.0/24 is directly connected, vlan1
O    100.100.21.0/24 [110/1] is directly connected, vlan2, 04:40:52
C *> 100.100.21.0/24 is directly connected, vlan2
R *> 103.40.9.0/24 [120/2] via 100.10.10.65, vlan1, 00:01:05
O E2 103.40.9.0/24 [110/20] via 100.10.10.65, vlan1, 00:01:57 C
   *> 127.0.0.0/8 is directly connected, lo

Total Entries: 7 entries, 7 routes
dgs-6600:2>
```

Configuration Examples

BGP Configuration Example

This configuration has Two AS: 65101 and 65102. In AS65101, R1 runs BGP (IBGP) with R3, and R1, R2, R3 runs RIP. Between AS65101 and 65101, R3 and R4 run BGP (EBGP).

Topology

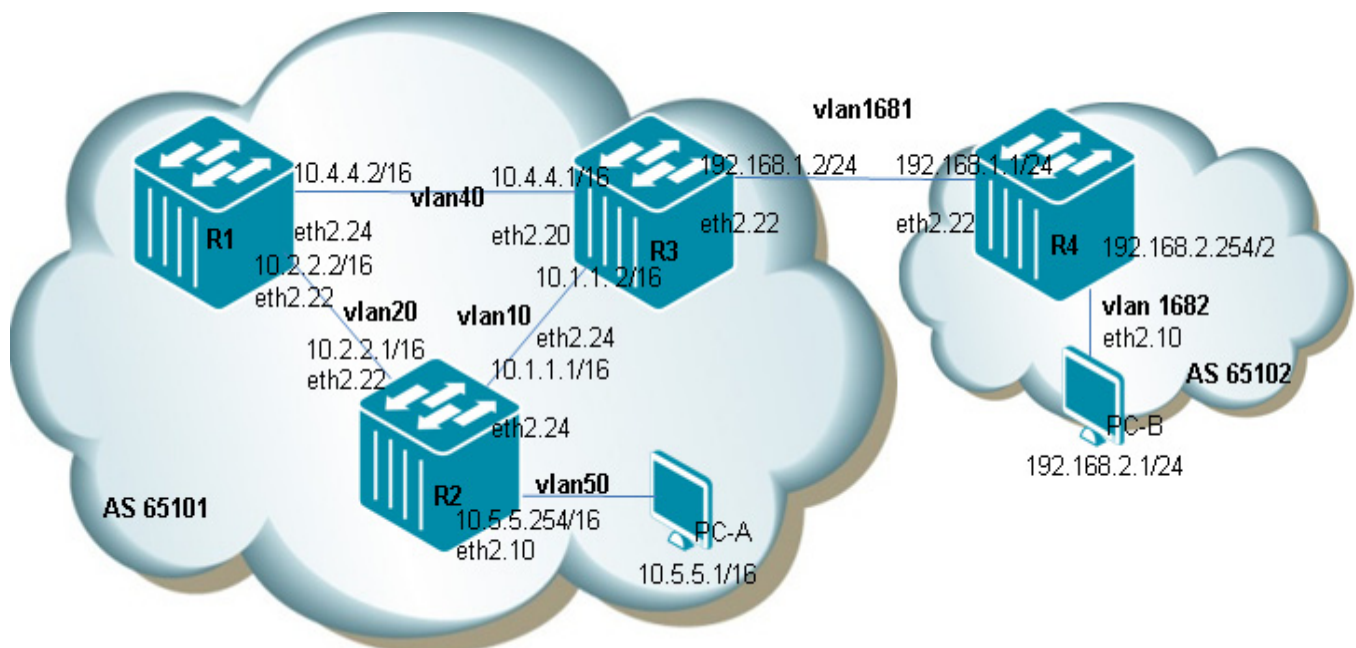

Figure 30-1 BGP Configuration Example Topology

R1 (Router 1) Configuration Steps

Step 1: create vlan 20, 40

```
DGS-6600:15(config)#vlan 20
DGS-6600:15(config-vlan)#vlan 40
```

Step 2: add port into vlan

```
DGS-6600:15(config-if)#interface range eth2.21-2.22
DGS-6600:15(config-if)# trunk allowed-vlan 20
DGS-6600:15(config-if)#interface range eth2.23-2.24
DGS-6600:15(config-if)# trunk allowed-vlan 40
```

Step 3: configure IP address of VLAN

```
DGS-6600:15(config-if)#interface vlan20
DGS-6600:15(config-if)# ip address 10.2.2.2/16
DGS-6600:15(config-if)#interface vlan40
DGS-6600:15(config-if)#ip address 10.4.4.2/16
```

Step 4: rip setting

```
DGS-6600:15(config-if)#router rip
DGS-6600:15(config-router)# network 10.2.2.2/16
DGS-6600:15(config-router)# network 10.4.4.2/16
```

Step 5: bgp setting

```
DGS-6600:15(config-router)#router bgp 65101
DGS-6600:15(config-router)# redistribute rip
DGS-6600:15(config-router)# neighbor 10.4.4.1 remote-as 65101
```

R2 (Router 2) Configuration Steps

Step 1: Create vlan 10, 20, 50.

```
DGS-6600:15(config)#vlan 10
DGS-6600:15(config-vlan)#vlan 20
DGS-6600:15(config-vlan)#vlan 50
```

Step 2: add ports into VLAN.

```
DGS-6600:15(config-vlan)#interface range eth2.21-2.22
DGS-6600:15(config-if)# trunk allowed-vlan 20
DGS-6600:15(config-if)#interface range eth2.23-2.24
DGS-6600:15(config-if)# trunk allowed-vlan 10
DGS-6600:15(config-if)#interface range eth2.1-2.10
DGS-6600:15(config-if)# access vlan 50
```

Step 3: configure IP address of VLAN

```
DGS-6600:15(config-if)#interface vlan10
DGS-6600:15(config-if)# ip address 10.1.1.1/16
DGS-6600:15(config-if)#interface vlan20
DGS-6600:15(config-if)# ip address 10.2.2.1/16
DGS-6600:15(config-if)#interface vlan50
DGS-6600:15(config-if)# ip address 10.5.5.254/16
```

Step 4: rip setting

```
DGS-6600:15(config-if)#router rip
DGS-6600:15(config-router)# network 10.2.2.1/16
DGS-6600:15(config-router)# network 10.1.1.1/16
DGS-6600:15(config-router)# network 10.5.5.254/16
```

R3 (Router 3) Configuration Steps**Step 1: create vlan 10, 40, 1681**

```
DGS-6600:15(config)#vlan 10
DGS-6600:15(config-vlan)#vlan 40
DGS-6600:15(config-vlan)#vlan 1681
```

Step 2: add port into vlan

```
DGS-6600:15(config-vlan)#interface range eth2.21-2.22
DGS-6600:15(config-if)#trunk allowed-vlan 1681
DGS-6600:15(config-if)#interface range eth2.23-2.24
DGS-6600:15(config-if)# trunk allowed-vlan 10
DGS-6600:15(config-if)#interface range eth2.19-2.20
DGS-6600:15(config-if)# trunk allowed-vlan 40
```

Step 3: configure IP address of VLAN

```
DGS-6600:15(config-if)#interface vlan10
DGS-6600:15(config-if)# ip address 10.1.1.2/16
DGS-6600:15(config-if)#interface vlan40
DGS-6600:15(config-if)# ip address 10.4.4.1/16
DGS-6600:15(config-if)# interface vlan1681
DGS-6600:15(config-if)# ip address 192.168.1.2/24
```

Step 4: rip setting

```
DGS-6600:15(config-if)#router rip
DGS-6600:15(config-router)# network 10.1.1.2/16
DGS-6600:15(config-router)# network 10.4.4.1/16
DGS-6600:15(config-router)# network 192.168.1.2/24
DGS-6600:15(config-router)# redistribute bgp
```

Step 5: bgp setting

```
DGS-6600:15(config-router)#router bgp 65101
DGS-6600:15(config-router)# redistribute rip
DGS-6600:15(config-router)# redistribute connected
DGS-6600:15(config-router)# neighbor 10.4.4.2 remote-as 65101
DGS-6600:15(config-router)# neighbor 192.168.1.1 remote-as 65102
```

R4 (Router 4) Configuration Steps**Step 1: create vlan 1681,1682**

```
DGS-6600:15(config)#vlan 1681
DGS-6600:15(config-vlan)#vlan 1682
```

Step 2: add port into vlan

```
DGS-6600:15(config-vlan)#interface range eth2.21-2.22
DGS-6600:15(config-if)#trunk allowed-vlan 1681
DGS-6600:15(config-if)#interface range eth2.1-2.10
DGS-6600:15(config-if)# access vlan 1682
```

Step 3: configure IP address of vlan

```
DGS-6600:15(config-if)#interface vlan1681
DGS-6600:15(config-if)# ip address 192.168.1.1/24
DGS-6600:15(config-if)#interface vlan1682
DGS-6600:15(config-if)# ip address 192.168.2.254/24
```

Step 4: bgp setting

```
DGS-6600:15(config-if)#router bgp 65102
DGS-6600:15(config-router)# neighbor 192.168.1.2 remote-as 65101
DGS-6600:15(config-router)# network 192.168.2.0/24
```

Verifying The Configuration

R2 is used as the example to check the correctness of tables. Use the same commands to check the other routers tables

```
DGS-6600:15#show ip bgp neighbors 10.4.4.2
BGP neighbor is 10.4.4.2, remote AS 65101, local AS 65101, internal link
BGP version 4, remote router ID 10.4.4.2
BGP state = Established, up for 0DT0H18M33S
Last read 0DT0H18M33S, hold time is 180, keepalive interval is 60 seconds
Neighbor capabilities:
  Route refresh: advertised and received (old and new)
  4-Byte AS number: advertised
  AS TRANS:
    Address family IPv4 Unicast: advertised and received
Received 0 in queue
Sent 0 in queue

                               Sent      Received
Opens:                          1          1
Notifications:                   0          0
Updates:                          3          1
Keepalives:                       21         19
Route Refresh:                     0          0
Dynamic Capability:                0          0
Total:                             25         21
Connect retry time is 120 seconds
In update elapsed time is 1112 seconds
Minimum time between advertisement runs is 5 seconds
Minimum time between as origination runs is 15 seconds

For address family: IPv4 Unicast
BGP table version 20, neighbor version 20
Index 0, Offset 0, Mask 0x1
AF-dependant capabilities:
  Graceful restart: advertised
  2 accepted prefixes
  6 announced prefixes

Connections established 1; dropped 0
Local host: 10.4.4.1, Local port: 49860
Foreign host: 10.4.4.2, Foreign port: 179
Nexthop: 10.4.4.1

For address family: IPv4 Unicast
BGP table version 24, neighbor version 24
Index 1, Offset 0, Mask 0x2
AF-dependant capabilities:
  Graceful restart: advertised
  1 accepted prefixes
  6 announced prefixes

Connections established 1; dropped 0
Local host: 192.168.1.2, Local port: 179
Foreign host: 192.168.1.1, Foreign port: 1024
Nexthop: 192.168.1.2
```



```
DGS-6600:15# show ip bgp neighbors 192.168.1.1
BGP neighbor is 192.168.1.1, remote AS 65102, local AS 65101, external link
  BGP version 4, remote router ID 192.168.2.254
  BGP state = Established, up for 0DT0H20M59S
  Last read 0DT0H20M59S, hold time is 180, keepalive interval is 60 seconds
  Neighbor capabilities:
    Route refresh: advertised and received (old and new)
    4-Byte AS number: advertised
    AS TRANS:
    Address family IPv4 Unicast: advertised and received
  Received 0 in queue
  Sent 0 in queue

                Sent          Received
Opens:          2             1
Notifications: 0             0
Updates:        2             1
Keepalives:     24            22
Route Refresh:  0             0
Dynamic Capability: 0         0
Total:          28            24
Connect retry time is 120 seconds
In update elapsed time is 1258 seconds
Minimum time between advertisement runs is 30 seconds
Minimum time between as origination runs is 15 seconds
```

```
DGS-6600:15#show ip bgp
BGP table version is 15, local router ID is 192.168.1.2
Status codes: s suppressed, d damped, h history, * valid, > best, i - internal, S
Stale
Origin codes: i - IGP, e - EGP, ? - incomplete

   Network          Next Hop          Metric      LocPrf      Weight      Path
* i 10.1.0.0/16     10.2.2.1          2           100          0           ?
*>                   0.0.0.0           0           32768        ?
*> 10.2.0.0/16     10.1.1.1          2           32768        ?
*> 10.4.0.0/16     0.0.0.0           0           32768        ?
* i 10.5.0.0/16     10.2.2.1          2           100          0           ?
*>                   10.1.1.1          2           32768        ?
*> 192.168.1.0/24  0.0.0.0           0           32768        ?
*> 192.168.2.0/24  192.168.1.1       0           0            65102

Total Entries: 6 entries, 8 route
```

```
DGS-6600:15#show ip route
Codes: K - kernel, C - connected, S - static, R - RIP, B - BGP
       O - OSPF, IA - OSPF inter area
       N1 - OSPF NSSA external type 1, N2 - OSPF NSSA external type 2
       E1 - OSPF external type 1, E2 - OSPF external type 2
       i - IS-IS, L1 - IS-IS level-1, L2 - IS-IS level-2, ia - IS-IS inter area
       # - A number of slots are inactive
       * - candidate default

C       10.1.0.0/16 is directly connected, vlan10
R       10.2.0.0/16 [120/2] via 10.1.1.1, vlan10, ODT0H24M55S
           [120/2] via 10.4.4.2, vlan40, ODT0H24M55S
C       10.4.0.0/16 is directly connected, vlan40
R       10.5.0.0/16 [120/2] via 10.1.1.1, vlan10, ODT0H24M55S
C       192.168.1.0/24 is directly connected, vlan1681
B       192.168.2.0/24 [20/0] via 192.168.1.1, vlan1681, ODT0H23M21S
Total Entries: 6 entries, 7 routes
```

Chapter 31

Policy Based Route Map (PBR)

Chapter Overview

The following topics are included in this chapter, please go to the topic for more detailed information:

- [Chapter Overview](#)
- [Usage Guideline](#)
 - [The Benefits of Policy-Based Routing](#)
 - [Cost Savings](#)
 - [Load Sharing](#)
 - [Differentiation between PBR and Static Route](#)
- [PBR Configuration Commands](#)
 - [The Concept of Policy base route](#)
- [Configuration example](#)
- [PBR Configuration Example](#)

An Introduction to Policy Based Route Map

Policy-Based Routing (PBR) provides a mechanism for expressing and implementing forwarding / routing /deny of data packets based on the policies defined by the network administrators.

Example:

User want a packet with a destination of 10.1.1.1 should go out interface eth1/0.

You could create a policy so that packets destined to 10.1.1.1, instead, go out interface eth1/0.

Or, you could make this happen ONLY when the source of that packet was 192.168.1.1.

With PBR you get the option to implement policies that selectively cause packets to take different paths.

Additionally, PBR can mark packets so that certain types of traffic get prioritized.

Policy Base Route is a kind of static route. The different is static route is base on “destination” but policy base route is base on “source”.

The Benefits of Policy-Based Routing

PBR have following benefits:

Source-Based Transit Provider Selection.

Internet service provider (ISP) can use policy-based routing to route traffic originating from different sets of users through different Internet connections across the policy routers

Quality of Service (QOS).

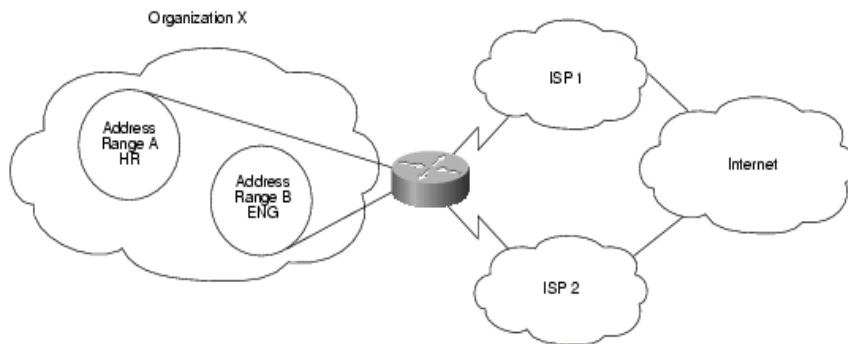

Figure 31-1

Organizations can provide QOS to differentiated traffic by setting the precedence or type of service (TOS) values in the IP packet headers at the periphery of the network and leveraging queuing mechanisms to prioritize traffic in the core or backbone of the network.

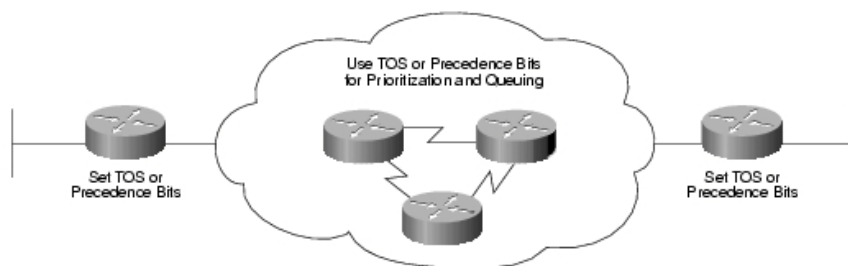

Figure 31-2

Cost Savings

Organizations can achieve cost savings by distributing interactive and batch traffic among low-bandwidth, low-cost permanent paths and high-bandwidth, high-cost, switched paths.

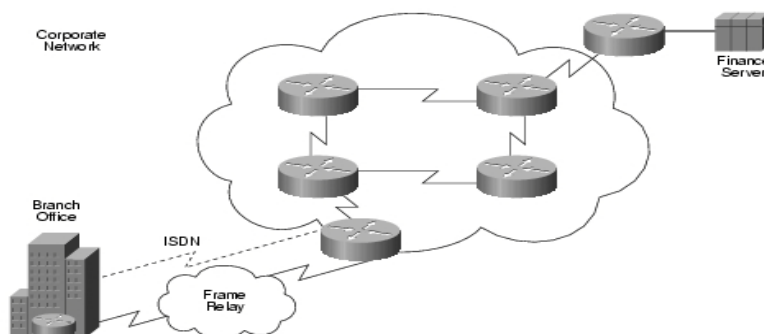

Figure 31-3

Load Sharing

Network managers can now implement policies to distribute traffic among multiple paths based on the traffic characteristics.

Differentiation between PBR and Static Route

	Policy Base Route	Static Route
Configuration	User Configure	User Configure
Filter rule	Base on source address	Base on destination address

PBR Configuration Commands

The Concept of Policy base route

- The traffic has to be identified "matched" according to the policy.
- The "matching" of the traffic is usually done with an ACL (access-control list) that is referenced by a route-map.
- In the route-map, there is a "match" for the traffic defined in that ACL then a "set" for that traffic where the network administrator defines what he or she wants to happen to that traffic (prioritize it, route it differently).

If the packet matches the permit statement in the ACL, the PBR logic executes the action specified by the set command to route the packet.

If the packet matches the deny statement in the ACL, the PBR logic is not applied and the packet is routed using the L3 routing table.

For example:

```
DGS-6600 > enable
DGS-6600# configure terminal
DGS-6600(config)# ip access-list test
DGS-6600(config-ip-acl)# deny host 1.1.1.4 any priority 10
DGS-6600(config-ip-acl)# permit 1.1.1.0 255.255.255.0 any priority 20
DGS-6600(config-ip-acl)# exit
DGS-6600(config)# route-map pbr permit 10
DGS-6600(config-route-map)# match ip address test
DGS-6600(config-route-map)# set ip next-hop 2.2.2.2
```

In the above scenario, if the packet comes from 1.1.1.4 it will be routed by the routing table. Should the packet come from 1.1.1.5 it will be policy routed to 2.2.2.2.

Configuration Guidelines

The **match** and **set** commands to define the conditions for policy routing packets. The **match** commands specify the conditions under which policy routing occurs. The **set** commands specify the

routing actions to perform if the criteria enforced by the **match** commands are met. You might want to policy route packets some way other than the obvious shortest path.

The route-map command format on policy base route is:

```
route-map MAP-NAME {permit | deny} SEQUENCE-NUM
```

```
no route-map MAP-NAME [permit SEQUENCE-NUM | deny SEQUENCE-NUM]
```

Command	Explanation
<i>MAP-NAME</i>	A meaningful name for the route map. Multiple route maps may share the same map tag name
permit	(Optional) If the match criteria is met for this route map, and the permit keyword is specified, the route is redistributed as controlled by the set actions. In the case of policy routing, the packet is policy routed.
deny	(Optional) In the case of policy routing, the packet will not be policy routed, and no further route maps sharing the same map name will be examined. If the packet is not policy routed, then the normal forwarding algorithm will be used.
<i>SEQUENCE-NUM</i>	(Optional) A number that indicates the position a new route map will have in the list of route maps already configured with the same name. When used with the no form of this command, the position of the route map will be deleted.

Table 31-1

Usage Guideline

Use the route-map command to enter route-map configuration mode.

The route map can be used in route redistribution, route filtering, and policy route application.

A route map could be defined by multiple route map statements. These route map statements share the same map name. The statement with a lower sequence number has higher priority. Within the same route map, for policy route, one match statement will be mapped to each set rule.

For example:

```
match ip address IPV4
```

```
set interface
```

```
set ip default next-hop
```

```
set ip precedence
```

All rules will be:

1. match ip address IPV4 + set interface
2. match ip address IPV4 + set default next-hop

3. match ip address IPV4 + set ip precedence

If other set clauses for policy based routing are used with the command, they will be evaluated based on the following ordering:

1. set ip next-hop
2. set interface
3. set ip default next-hop
4. set default interface

with this ordering, the set next-hop clauses and the set interface clauses will be evaluated before look up of the routing table. If route cannot be found for the packets, the set ip default next-hop and set default interface command will be evaluated.

Configuration example

PBR Configuration Example

R1 has PBR and default route. The traffic form source IP 2.x.x.x, destination IP any will direct to 7.0.0.2 (PBR) Other source IP packet will be direct to 4.0.0.2(default route)

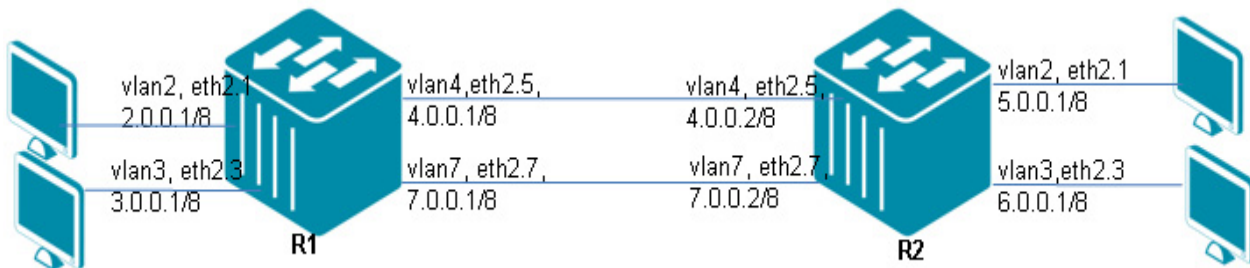

Figure 31-4 PBR Configuration Example Topology

R1 Configuration steps

Step 1: Create PBR route-map for PBR interface

```
DGS-6600:15(config)#route-map PBR permit 1
DGS-6600:15(config-route-map)# match ip address PBR-match_ip4
DGS-6600:15(config-route-map)# set ip next-hop 7.0.0.2
```

Step 2: create vlan 2, 3, 4, 7

```
DGS-6600:15(config-route-map)#vlan 2
DGS-6600:15(config-vlan)#vlan 3
DGS-6600:15(config-vlan)#vlan 4
DGS-6600:15(config-vlan)#vlan 7
```

Step 3: Create ACL for PBR route-map

```
DGS-6600:15(config-vlan)#ip access-list extended PBR-match_ip4
DGS-6600:15(config-ip-ext-acl)# permit 2.0.0.2 255.0.0.0 any priority 10
```

Step 4: add port into vlan

```
DGS-6600:15(config-ip-ext-acl)#interface eth2.1
DGS-6600:15(config-if)# access vlan 2
DGS-6600:15(config-if)#interface eth2.3
DGS-6600:15(config-if)# access vlan 3
DGS-6600:15(config-if)#interface eth2.5
DGS-6600:15(config-if)# trunk allowed-vlan 4
DGS-6600:15(config-if)#interface eth2.7
DGS-6600:15(config-if)# trunk allowed-vlan 7
```

Step 5: configure IP address of VLAN and bind PBR route-map to PBR interface vlan2

```
DGS-6600:15(config-if)#interface vlan2
DGS-6600:15(config-if)# ip address 2.0.0.1/8
DGS-6600:15(config-if)# ip policy route-map PBR
DGS-6600:15(config-if)#interface vlan3
DGS-6600:15(config-if)# ip address 3.0.0.1/8
DGS-6600:15(config-if)#interface vlan4
DGS-6600:15(config-if)# ip address 4.0.0.1/8
DGS-6600:15(config-if)#interface vlan7
DGS-6600:15(config-if)# ip address 7.0.0.1/8
```

Step 6: set default route

```
DGS-6600:15(config)#ip route 0.0.0.0/0 4.0.0.2
```

R2 Configuration Steps**Step 1: create vlan 2, 3, 4, 7**

```
DGS-6600:15(config-route-map)#vlan 2
DGS-6600:15(config-vlan)#vlan 3
DGS-6600:15(config-vlan)#vlan 4
DGS-6600:15(config-vlan)#vlan 7
```

Step 2: add port into vlan

```
DGS-6600:15(config-ip-ext-acl)#interface eth2.1
DGS-6600:15(config-if)# access vlan 2
DGS-6600:15(config-if)#interface eth2.3
DGS-6600:15(config-if)# access vlan 3
DGS-6600:15(config-if)#interface eth2.5
DGS-6600:15(config-if)# trunk allowed-vlan 4
DGS-6600:15(config-if)#interface eth2.7
DGS-6600:15(config-if)# trunk allowed-vlan 7
```

Step 3: configure IP address of VLAN

```
DGS-6600:15(config-if)#interface vlan2
DGS-6600:15(config-if)# ip address 5.0.0.1/8
DGS-6600:15(config-if)#interface vlan3
DGS-6600:15(config-if)# ip address 6.0.0.1/8
DGS-6600:15(config-if)#interface vlan4
DGS-6600:15(config-if)# ip address 4.0.0.2/8
DGS-6600:15(config-if)#interface vlan7
DGS-6600:15(config-if)# ip address 7.0.0.2/8
```

Step 4: set default route

```
DGS-6600:15(config)#ip route 0.0.0.0/0 4.0.0.1
```

Verifying Configuration Check R1 PBR configuration

```
DGS-6600:15#show route-map
route-map PBR, permit, sequence 1
  Match clauses:
    ip address PBR-match_ip4
  Set clauses:
    ip next-hop 7.0.0.2

DGS-6600:15#show access-list
access-list name          access-list type
-----
PBR-match_ip4           ip ext-acl

DGS-6600:15#show access-list ip PBR-match_ip4
10      permit 2.0.0.2 255.0.0.0 any

DGS-6600:15#show ip policy

Interface          Route-map
-----
vlan2              PBR

DGS-6600:15#show ip route
Codes: K - kernel, C - connected, S - static, R - RIP, B - BGP
       O - OSPF, IA - OSPF inter area
       N1 - OSPF NSSA external type 1, N2 - OSPF NSSA external type 2
       E1 - OSPF external type 1, E2 - OSPF external type 2
       i - IS-IS, L1 - IS-IS level-1, L2 - IS-IS level-2, ia - IS-IS inter area
       # - A number of slots are inactive
       * - candidate default

Gateway of last resort is 4.0.0.2 to network 0.0.0.0

S*    0.0.0.0/0 [1/0] via 4.0.0.2, vlan4
C     3.0.0.0/8 is directly connected, vlan3
C     4.0.0.0/8 is directly connected, vlan4
C     7.0.0.0/8 is directly connected, vlan7
```

Chapter 32

Virtual Router Redundancy Protocol (VRRP)

Chapter Overview

The following topics are included in this chapter, please go to the topic for more detailed information:

- [Chapter Overview](#)
 - [An introduction to VRRP](#)
 - [Election of a master router](#)
 - [Behavior of a master router](#)
 - [Behavior of the backup router](#)
 - [Behavior of Initialization state](#)
 - [Critical IP Address](#)
 - [VRRP Configuration Commands](#)
 - [vrrp ip](#)
 - [show vrrp](#)
 - [Configuration Example](#)
 - [VRRP Configuration Example](#)

An introduction to VRRP

Virtual Router Redundancy Protocol (VRRP) is a redundancy protocol designed to increase the availability of the default gateway servicing hosts on the same subnet. This increased reliability is achieved by advertising a “virtual router” (an abstract representation of master and backup routers acting as a group) as a default gateway to the host(s) instead of one physical router. Two or more physical routers are then configured to stand in for the virtual router, with only one doing the actual routing at any given time. If the current physical router that is routing the data on behalf of the virtual router fails, an arrangement is made for another physical router to automatically replace it. The physical router that is currently forwarding data on behalf of the virtual router is called the master router. Physical routers standing by to take over from the master router in case something goes wrong are called backup routers.

Election of a master router

Routers have a priority range from 1 to 255 and the router with the highest priority will become the master router and the other routers with a lower priority will then become the backups for the virtual router. The priority of 255 is reserved for the router that is the IP address owner. The IP address owner will always be the master of the virtual router.

If there's more than one router that has the same highest priority value; the router with the greatest primary IP address becomes master.

The following diagram below shows a simple network with two VRRP routers implementing one virtual router

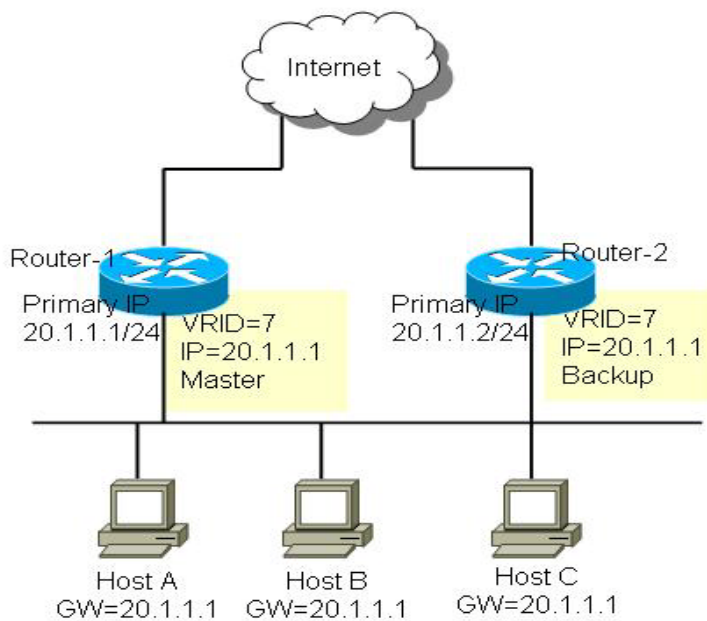

Figure 32-1 a simple network with two VRRP routers

Each router has its own IP address (Primary IP address) for the interface that connects to the end hosts and the exact the same virtual router IP address (20.1.1.1) is also assigned to these routers with virtual router identifier (VRID) 7. The gateway of the end hosts, A, B, and C is assigned to the virtual router's IP address, 20.1.1.1. One of the virtual routes will be elected as the designated router for forwarding the packets from the end hosts.

In this case, the Router-1 is the IP Address Owner, so it becomes the Master and responsible for forwarding the packets from the end hosts. The Router-2 would therefore the Backup for the virtual router.

The following diagram shows a simple network with two VRRP routers implementing one virtual router and none of the routers is IP address Owner.

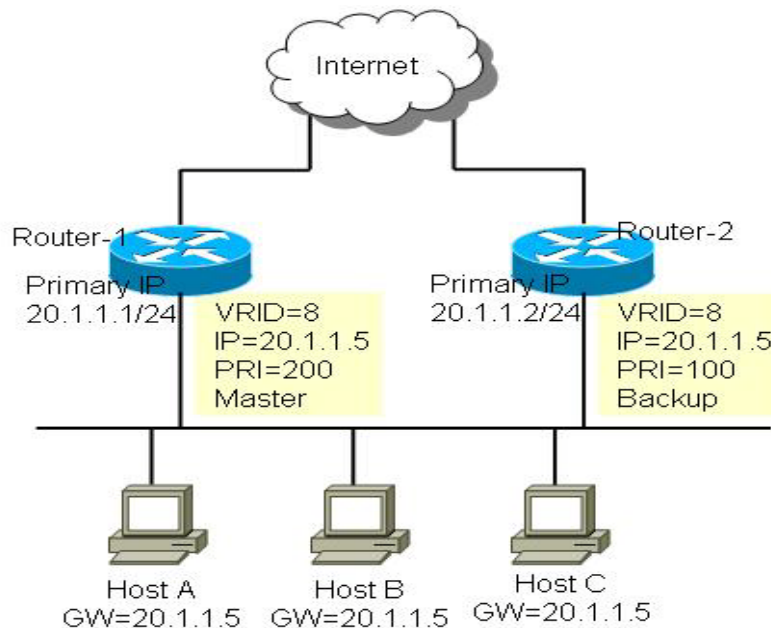

Figure 32-2 a simple network with two VRRP routers implementing one virtual router

In this case, Router-1 is configured with a priority value (PRI) of 200 and Router-2 100. The higher value gets higher priority. So the Router-1 becomes the master and Router-2 becomes the backup of the virtual router.

Behavior of a master router

When a router becomes the master, it would broadcast a ARP request containing the virtual router's MAC address, 00-00-5E-00-01-XX. The last byte of the address (XX) is the Virtual Router Identifier.

Master router sends periodic VRRP Advertisement message with multicast IP address 224.0.0.18 and IP protocol number 112 to declare the master router's state and its priority. And it forwards the packets from host that send to this virtual router.

Behavior of the backup router

The backup router will not send VRRP advertisement message, Instead it monitors the advertisement message that is sent from the master. If the Advertisement message isn't received within a certain period of time ($3 * \text{Advertisement Interval} - ((256 - \text{priority})/256)$), it will assume that the master router is dead. The virtual router then transitions into an unsteady state and an election process is initiated to select the next master router from the backup routers.

If a backup router receives an advertisement message sent from a lower priority master, it will attempt to preempt the master if it has higher priority. There is a "preempt-mode" designed in the backup master controls which is used when a higher priority backup router preempts a lower priority master.

By default, the router preempt mode is enabled on the router, the backup takes over as master router for the virtual router if it has a higher priority than the current master router.

When preempt mode set to disabled, the backup will not attempt to preempt the master router even if it has a higher priority than the master router. One exception is when the router that is the virtual IP address owner always preempts.

Behavior of Initialization state

When activate VRRP, the virtual router will first be in this state. In this state, it will not perform any vrrp functions that have been described above. Until a Startup event is received. The startup events are:

- The router is the IP Address Owner. In this case, it will starts to acts as a master.
- If the router is not the IP Address Owner, it starts to acts as a backup.

Critical IP Address

The connection between end host and the first hop router may be good, but there might be problems between the first hop and second hop connection. If that connection goes down, the master router may not be able to perform its function properly. In cases like this, the IP address of the second hop's IP address is called the critical IP address.

Referring to the diagram below, Router-1 is the Master while the Router-2 is the Backup for virtual router 7 with IP address of 20.1.1.5. For the Master, the next hop router which provides the access to the Internet is Router-X and the interface IP address on Router-X that connects to the Router-1 is 60.5.1.1. This 60.5.1.1 is the critical IP address for it.

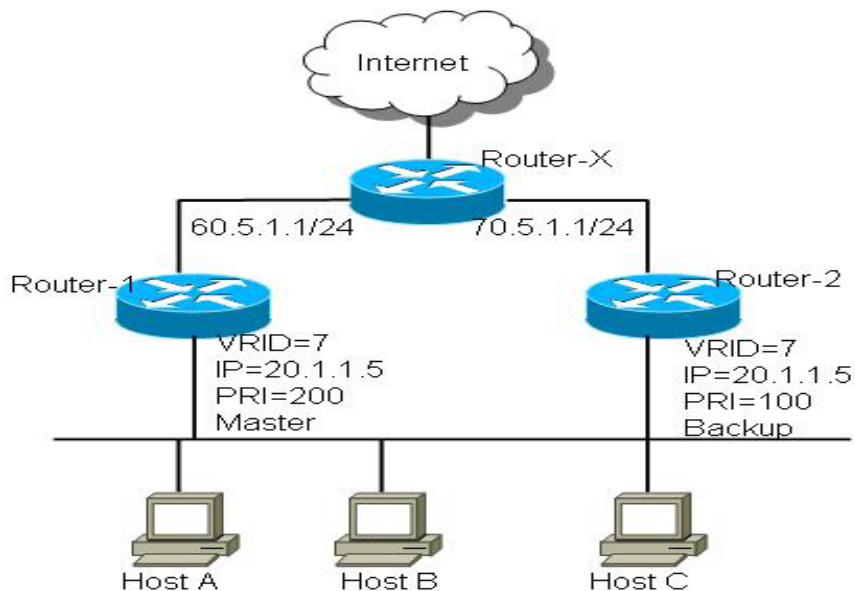

Figure 32-3

Configure the critical IP address on the Master virtual router and it will monitor the ARP cache of the critical IP address. Once the ARP cache of the critical IP is gone from the ARP table, the Master will give up its master status.

The Master will check the ARP cache of critical IP every 15 seconds. If the ARP cache does not present, it sends out an ARP request. If ARP is not present for more than 33 seconds, the master will give up its master status and change to initialize state and stays in that state until the critical IP ARP cache is recovered.

The Critical IP address is also able to be configured to the IP address of interfaces other than the virtual router interface Primary IP address itself. When set, the critical IP address configures to an interface IP, the virtual router will monitor the link state of that interface. If the link state of the interface changes to down, the virtual router will change to initialize state and stay in that state until the interface link is up again.

VRRP Configuration Commands

vrrp ip

Command	Explanation
<code>vrrp VRID ip IP-ADDRESS</code>	To enable the Virtual Router Redundancy Protocol (VRRP) on an interface and identify the IP address of the virtual router, use the vrrp ip command.

The following example shows how to enable VRRP on vlan1. The virtual router identifier is 7, and 10.1.1.1 is the IP address of the virtual router.

```
DGS6600(config)#interface vlan1
DGS6600(config-if)#vrrp 7 ip 10.1.1.1
```

show vrrp

Command	Explanation
<code>show vrrp [interface <i>INTERFACE-ID</i> [<i>VRID</i>]]</code>	This command is used to view the VRRP status.

The following is an example from show vrrp. There are 2 VRID, 7 and 8, configured in the interface vlan1, a VRID 5 configured in interface vlan2 and a VRID 1 configured in interface vlan3.

```
vlan1 - VRID 8
State is Master
  Virtual IP address is 20.1.1.2
  Virtual MAC address is 00-00-5e-00-01-08
  Advertisement interval is 1 sec
  Preemption disabled
  Priority is 200
  Critical IP address is 0.0.0.0
  Master router is 20.0.1.1 (local)
  Master Down interval is 3.218 sec

vlan2 - VRID 5
State is Initialize
  Virtual IP address is 30.1.1.254
  Virtual MAC address is 00-00-5e-00-01-05
  Advertisement interval is 1 sec
  Preemption enable
  Priority is 100
  Critical IP address is 70.5.1.1
  Master router is unknown
  Master Down interval is 3.609 sec

vlan3 - VRID 1
State is Backup
  Virtual IP address is 50.1.1.254
  Virtual MAC address is 00-00-5e-00-01-01
  Advertisement interval is 1 sec
  Preemption disabled
  Priority is 80
  Critical IP address is 0.0.0.0
  Master router is 50.0.1.2
  Master Down interval is 3.687 sec (expires in 3.550 sec)

Total Entries: 4
```

Configuration Example

VRRP Configuration Example

R1 is VRRP master and R2 is VRRP backup. The PC's packet will go through R1. If R1 is broken, R2 will become the VRRP master.

Topology

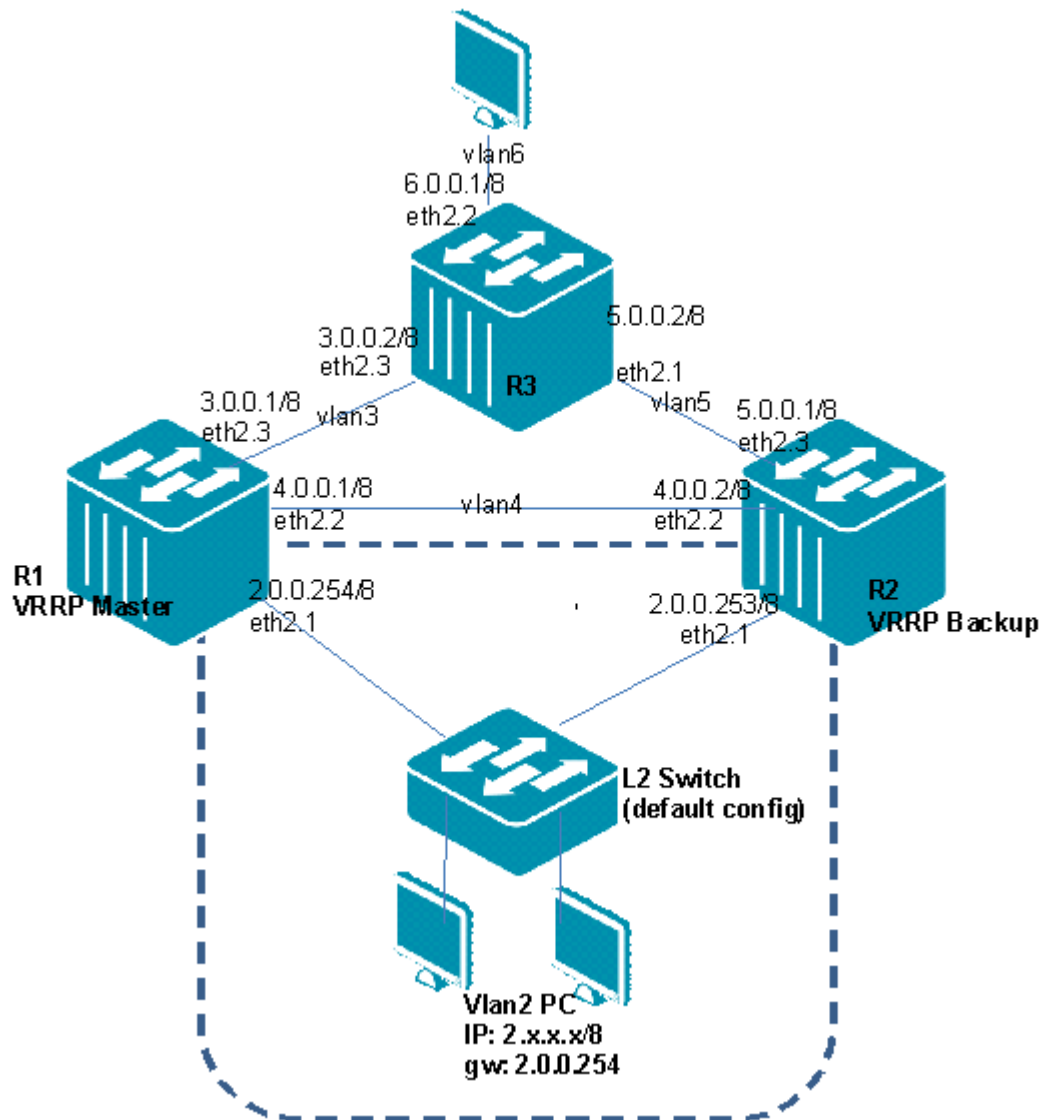

Figure 32-4 VRRP Configuration Example Topology

R1 (Router 1) Configuration Steps

Step 1: create vlan 2, 4, 3

```
DGS-6600:15(config)#vlan 2
DGS-6600:15(config-vlan)#vlan 4
DGS-6600:15(config-vlan)#vlan 3
```

Step 2: add port into vlan

```
DGS-6600:15(config)#interface eth2.1
DGS-6600:15(config-if)# access vlan 2
DGS-6600:15(config-if)#interface eth2.2
DGS-6600:15(config-if)# access vlan 4
DGS-6600:15(config-if)#interface eth2.3
DGS-6600:15(config-if)# access vlan 3
```

Step 3: configure IP address of VLAN and assign ip 2.0.0.254 is vrrp master

```
DGS-6600:15(config-if)#interface vlan2
DGS-6600:15(config-if)# ip address 2.0.0.254/8
DGS-6600:15(config-if)# vrrp 2 ip 2.0.0.254
DGS-6600:15(config-if)#interface vlan3
DGS-6600:15(config-if)# ip address 3.0.0.1/8
DGS-6600:15(config-if)#interface vlan4
DGS-6600:15(config-if)# ip address 4.0.0.1/8
```

Step 4: enable rip

```
DGS-6600:15(config)#router rip
DGS-6600:15(config-router)#network 2.0.0.254/8
DGS-6600:15(config-router)#network 3.0.0.1/8
DGS-6600:15(config-router)#network 4.0.0.1/8
```

R2 (Router 2) Configuration Steps**Step 1: create vlan 2, 4 ,5**

```
DGS-6600:15(config)#vlan 2
DGS-6600:15(config-vlan)#vlan 4
DGS-6600:15(config-vlan)#vlan 5
```

Step 2: add port into vlan

```
DGS-6600:15(config)#interface eth2.1
DGS-6600:15(config-if)# access vlan 2
DGS-6600:15(config-if)#interface eth2.2
DGS-6600:15(config-if)# access vlan 4
DGS-6600:15(config-if)#interface eth2.3
DGS-6600:15(config-if)# access vlan 5
```

Step 3: Configure IP address of VLAN and assign ip 2.0.0.253 is vrrp backup

```
DGS-6600:15(config-if)#interface vlan2
DGS-6600:15(config-if)# ip address 2.0.0.253/8
DGS-6600:15(config-if)# vrrp 2 ip 2.0.0.254
DGS-6600:15(config-if)#interface vlan4
DGS-6600:15(config-if)# ip address 4.0.0.2/8
DGS-6600:15(config-if)#interface vlan5
DGS-6600:15(config-if)# ip address 5.0.0.1/8
```

Step 4: enable rip

```
DGS-6600:15(config)#router rip
DGS-6600:15(config-router)#network 2.0.0.253/8
DGS-6600:15(config-router)#network 4.0.0.2/8
DGS-6600:15(config-router)#network 5.0.0.2/8
```

R3 (Router 3) Configuration Steps**Step 1: create vlan 3, 5 ,6**

```
DGS-6600:15(config)#vlan 3
DGS-6600:15(config-vlan)#vlan 5
DGS-6600:15(config-vlan)#vlan 6
```

Step 2: add port into vlan

```
DGS-6600:15(config)#interface eth2.1
DGS-6600:15(config-if)# access vlan 5
DGS-6600:15(config-if)#interface eth2.2
DGS-6600:15(config-if)# access vlan 6
DGS-6600:15(config-if)#interface eth2.3
DGS-6600:15(config-if)# access vlan 3
```

Step 3: configure IP address of VLAN

```
DGS-6600:15(config-if)#interface vlan3
DGS-6600:15(config-if)# ip address 3.0.0.2/8
DGS-6600:15(config-if)#interface vlan5
DGS-6600:15(config-if)# ip address 5.0.0.2/8
DGS-6600:15(config-if)#interface vlan6
DGS-6600:15(config-if)# ip address 6.0.0.1/8
```

Step 4: enable rip

```
DGS-6600:15(config)#router rip
DGS-6600:15(config-router)#network 3.0.0.2/8
DGS-6600:15(config-router)#network 5.0.0.2/8
DGS-6600:15(config-router)#network 6.0.0.1/8
```

Verifying The Configuration

Step 1: Use the show vrrp command to check VRRP configuration on R1 and R2

VLAN2 PC should be able to ping VLAN6 PC.

Shutdown R1 (VRRP master), R2 will become the master. VLAN2 PC should be able to still ping VLAN6 PC as R2 acts as the new master.

R1

```
DGS-6600:15#show vrrp
vlan2 - VRID 2
  State is Master
  Virtual IP address is 2.0.0.254
  Virtual MAC address is 00-00-5e-00-01-02
  Advertisement interval is 1 sec
  Preemption enabled
  Priority is 255
  Critical IP address is 0.0.0.0
  Master router is 2.0.0.254 (local)
  Master Down interval is 3.003 sec

Total Entries: 1
```

R2

```
DGS-6600:15#show vrrp
vlan2 - VRID 2
  State is Backup
  Virtual IP address is 2.0.0.254
  Virtual MAC address is 00-00-5e-00-01-02
  Advertisement interval is 1 sec
  Preemption enabled
  Priority is 100
  Critical IP address is 0.0.0.0
  Master router is 2.0.0.254
  Master Down interval is 3.609 sec (expires in 3.006 sec)

Total Entries: 1
```



Part 5- Multiprotocol Label Switching (MPLS)

The following chapters are included in this volume:

- **Multiprotocol Label Switching (MPLS)**
- **Virtual Private Wire Service (VPWS)**
- **Virtual Private Lan Services (VPLS)**

Chapter 33

Multiprotocol Label Switching (MPLS)

Chapter Overview

The following topics are included in this chapter, please go to the topic for more detailed information:

- [An Introduction to MPLS Authentication](#)
 - [An Introduction to MPLS Authentication](#)
 - [MPLS Operation](#)
- [MPLS Configuration Commands](#)
 - [Enabling MPLS Function](#)
 - [Enabling/Disabling MPLS on Interface](#)
 - [Configuring MPLS QoS](#)
 - [Creating static LSP](#)
 - [Data Plane Failure Detection](#)
 - [LSP Ping](#)
 - [LSP Traceroute](#)
- [Configuration Examples](#)
 - [MPLS, LDP \(Dynamic Label\) Configuration Example](#)
 - [MPLS \(Static Label\) Configuration Example](#)
 - [MPLS QoS Configuration Example](#)
- [Configuration Restrictions](#)

An Introduction to MPLS Authentication

MPLS Operation

Multiprotocol Label Switching (MPLS) is a high-performance packet forwarding technology that integrates both Layer 2 fast switching and Layer 3 routing and forwarding, satisfying the requirements for speed, scalability, QoS management, traffic engineering and virtual private network (VPN) in backbone network.

In conventional IP forwarding, each router independently chooses a next hop for the packet, based on its analysis of the packet's header and the results of running the routing algorithm.

In MPLS, as a packet enters the network, it is assigned to a Forwarding Equivalence Class (FEC) and labeled a short fixed length value. At subsequent hops, there is no further analysis of the packet's network layer header; all forwarding is driven by the label. It makes the MPLS forwarding can be done by switches are not capable of analyzing the network layer headers at adequate speed.

In MPLS, the FEC assignment can be based on any information, such as IP prefix, ingress port, packet content, etc., and the FEC assignment is flexible. Since the FEC determines the packet's forwarding behavior in the MPLS network, so the flexible FEC assignment provides powerful support for QoS and traffic engineering.

The MPLS label stack can be used to provide a MPLS tunnel. It make the MPLS-VPN can be implemented easily.

The MPLS is independent of the L2 and L3 protocols. It supports all L3 protocols, such as IPv4, IPv6, IPX, etc. It is also can run on any L2 network, such as ATM, Ethernet, PPP, etc.

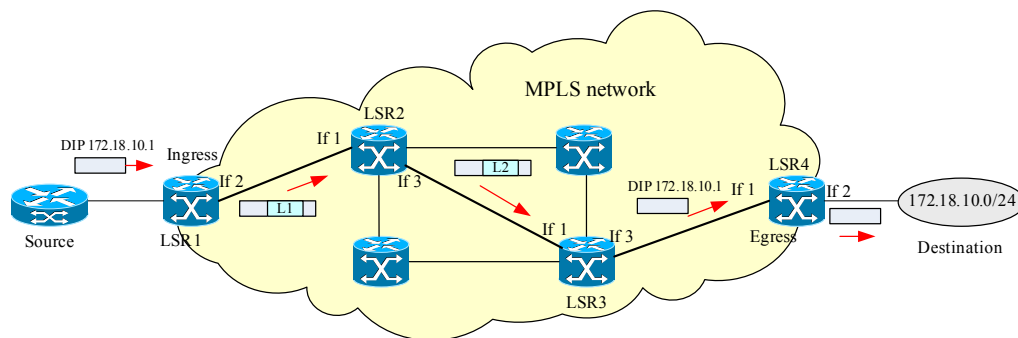

Figure 33-1 Example of MPLS network

The node in the network is known as Label Switching Router (LSR). All LSRs use MPLS to communicate in the network.

The path from the source to the destination is selected by typical routing protocols. The path is known as Label Switched Path (LSP). In figure 1, the LSP is <LSR1, LSR2, LSR3, LSR4>. LSR1 is the ingress LSR and LSR4 is the egress LSR. LSR1 and LSR4 are also called Label Edge Router (LER). The Label Distribution Protocol (LDP) is used to establish the unidirectional LSP. Along the path, each LSR uses LDP to assign a label for the FEC and to distribute the assigned label to its upstream LSR. The upstream LSR records the advertised label to its Label Information Base (LIB). In above example, LSR1 receives label advertisement of (L1, IP prefix 172.18.10.0/24) from LSR2 hence LSR1 is LSR2 upstream router for this LSP.

Once the MPLS packet destination to LSR1 enters the MPLS network, the LSR1 assigns it to FEC (IP prefix 172.18.10.0/24) and push the label L1 for it. When the LSR2 received the labeled packet from LSR1, it uses the label L1 as key to lookup its LIB, and swaps the L1 to L2, and then send out the packet to LSR3. Because the LSR3 is the penultimate hop in the LSP, it pops the label and forwards the packet to LSR4. At egress, LSR4 forwards the unlabeled packet to destination.

MPLS Configuration Commands

Enabling MPLS Function

Once the global MPLS is enabled, it will be running as LSR. If MPLS is disabled, all assigned labels shall be released, all established LSPs shall be destroyed and all LDP sessions shall be closed.

By default, it is disabled.

Command	Explanation
mpls ip	Use mpls ip command in global configuration mode to enable the MPLS to forward globally. Use no mpls ip command in global configuration mode to disable MPLS forwarding globally

Table 33-1

Enabling/Disabling MPLS on Interface

You can enable or disable MPLS on an interface. MPLS shall be enabled on these interfaces that connected to MPLS network. If you disable MPLS on an interface, the MPLS capability is removed from that interface. The default value of MPLS on an interface is disabled.

Command	Explanation
<code>mpls ip</code>	Use <code>mpls ip</code> command in interface configuration mode to enable the MPLS forward on this interface. Use the <code>no mpls ip</code> command in interface configuration mode to disable the MPLS forward on this interface.

Configuring MPLS QoS

You can enable the MPLS QoS so that the switch uses the EXP field of incoming labeled packets as its QoS. By default, the system does not trust the EXP field of received MPLS packets.

If the EXP value of NHLFE is set, the EXP field of outbound label will be set according to the EXP value. Otherwise, the EXP value is set according to packet's QoS value. If the DSCP and user priority are trusted at the same time, the DSCP is preference. If no DSCP, prefer EXP. By default the MPLS QoS is disabled. The mapping between EXP and CoS is configurable. The default CoS is 0.

Command	Explanation
<code>mpls qos policy <NAME></code>	Use <code>mpls qos policy</code> command to enter MPLS QoS configuration mode. If the policy doesn't exist, a new policy will be created. Use <code>no mpls qos policy</code> to remove the policy.

Creating static LSP

Usually, the LSP is established by LDP, but you can also create a static LSP by manual configuration. The maximum LSP number is 128. For establishing a static LSP, you shall configure it at each node on the path. The established LSP also can be deleted.

Data Plane Failure Detection

The LSP ping and LSP traceroute provide mechanisms to detect the MPLS data plane failure.

LSP Ping

LSP ping uses MPLS echo request and reply packets to test a particular LSP. Table 33-2, "LSP ping example," on page 353 shows an example of LSP ping.

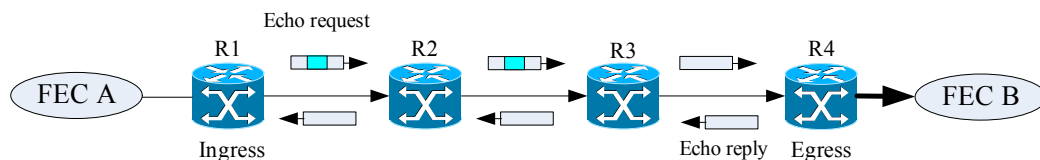

Figure 33-2 LSP ping

For test the LSP of FEC B, the MPLS echo request is sent from R1. The MPLS echo request is a UDP packet. The IP header is set as follows: the source IP address is the IP address of the sender; the destination IP address is 127.x.y.z/8 address, which prevents the IP packet is routed to its destination if the LSP is broken. The source UDP port is chosen by the sender; the destination UDP

port is set to 3503. The corresponding label is pushed to the label stack of the echo request. The TTL in the outmost label is set to 255.

The labeled echo request is forwarded via the LSP. When the echo request arrive the egress, it is sent to control plane of the egress LSR. The egress LSR validates the echo request and sends reply packet to R1. The MPLS echo reply is a UDP packet. The source IP address is the replier; the source port is 3503. The destination IP address and UDP port are copied from the source IP address and UDP port of the echo request. The IP TTL is set to 255.

Step	Router	Action
1	R1	Initiates an LSP ping request for an FEC at the target router R4 and sends an echo request to R2.
2	R2	Receives the echo request packets and forwards it through transit router R3 to the penultimate router R4.
3	R4	Receives the IP packet, processes the echo request, and sends an MPLS echo reply R1.
4	R4 to R2	Receives the echo reply and forwards it back towards R1, the originating router.
5	R1	Receives the MPLS echo reply in response to its MPLS echo request.

Table 33-2 LSP ping example

LSP Traceroute

LSP traceroute also uses MPLS echo request and reply packets to test an LSP.

The TTL in the outmost label of the MPLS echo requests is set successively to 1, 2, 3, and so on. It force the echo request expired at each successive LSR along the LSP. The LSR returns an MPLS echo reply containing information about the successive LSR in response to the TTL-expired MPLS packet.

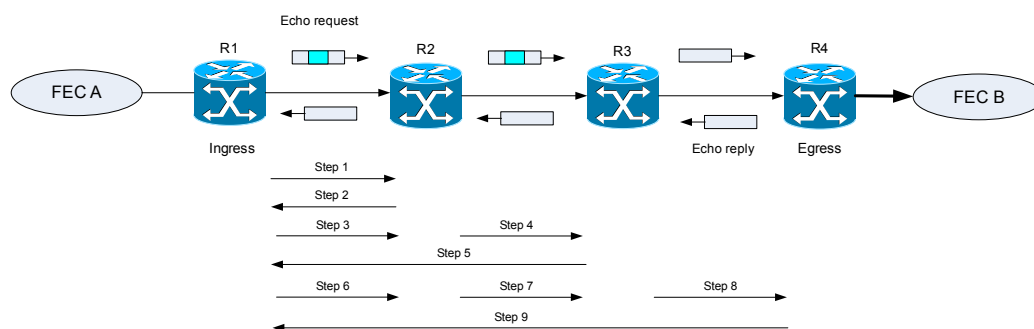

Figure 33-3 LSP traceroute

Step	Router	Packet Type and Description	Router Action (Receive or Send)
1	R1	Echo request: With a target FEC pointing to R4 and to a downstream mapping.	<ol style="list-style-type: none"> 1. Sets the TTL of the label stack to 1 2. Sends the request to R2
2	R2	Echo to reply.	<ol style="list-style-type: none"> 1. Receives the packet with a TTL =1 2. Processes the User Datagram Protocol (UDP) packet as an echo request 3. Finds a downstream mapping and replies to R1 with its own downstream mapping, based on the incoming label
3	R1	Echo request: With the same target FEC and the downstream mapping received in the echo reply from R2.	<ol style="list-style-type: none"> 1. Sets the TTL of the label stack to 2 2. Sends the request to R2
4	R2	Echo request.	<ol style="list-style-type: none"> 1. Receives the packet with a TTL=2 2. Decrements the TTL 3. Forwards the echo request to R3
5	R3	Echo reply.	<ol style="list-style-type: none"> 1. Receives the packet with TTL=1 2. Processes the UDP packet as an echo request 3. Finds a downstream mapping and replies to R1 with its own downstream mapping based on the incoming label
6	R1	Echo request: With the same target FEC and the downstream mapping received in the echo reply from R3.	<ol style="list-style-type: none"> 1. Sets the TTL of the packet to 3 2. Sends the request to R2
7	R2	Echo request	<ol style="list-style-type: none"> 1. Receives the packet with a TTL=3 2. Decrements the TTL 3. Forwards the echo request to R3
8	R3	Echo request	<ol style="list-style-type: none"> 1. Receives the packet with TTL=2 2. Decrements the TTL 3. Forwards the echo request to R4
9	R4	Echo reply	<ol style="list-style-type: none"> 1. Receives the packet with TTL = 1 2. Processes the UDP packet as an MPLS echo request 3. Finds a downstream mapping and also finds that the router is the egress router for the target FEC 4. Replies to R1

Configuration Examples

MPLS, LDP (Dynamic Label) Configuration Example

Configuring the MPLS protocol in R1, R2 and R3. The MPLS label is learned by LDP protocol. The DGS-6600 router can forward packets by the learned label information.

Topology

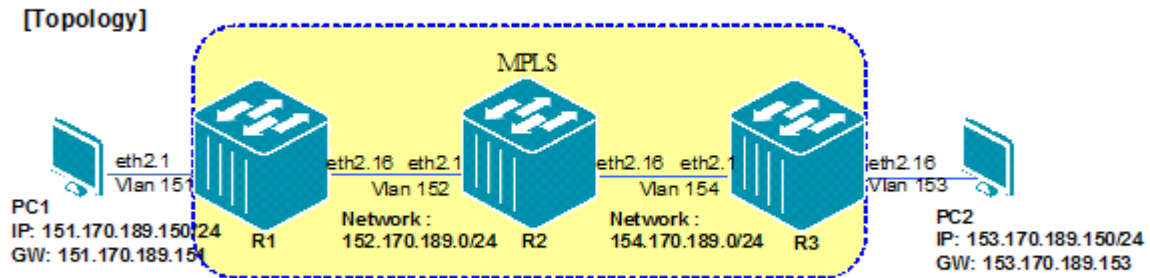

R1 (Router 1) Configuration Steps

Step 1. Create VLAN and add ports into VLAN.

```
DGS6600:15(config)#vlan 151
DGS6600:15(config-vlan)#!
DGS6600:15(config-vlan)#vlan 152
DGS6600:15(config-vlan)#!
DGS6600:15(config-vlan)#interface eth2.1
DGS6600:15(config-if)#access vlan 151
DGS6600:15(config-if)#!
DGS6600:15(config-if)#interface eth2.16
DGS6600:15(config-if)#hybrid vlan 152 tagged
DGS6600:15(config-if)#pvid 152
```

Step 2. Configure IP address of VLAN

```
DGS6600:15(config-if)#interface vlan151
DGS6600:15(config-if)#ip address 151.170.189.151/24
DGS6600:15(config-if)#!
DGS6600:15(config-if)#interface vlan152
DGS6600:15(config-if)#ip address 152.170.189.151/24
```

Step 3. Set OSPF route

```
DGS6600:15(config-if)#router ospf
DGS6600:15(config-router)#network 151.170.189.0/24 area 0.0.0.0
DGS6600:15(config-router)#network 152.170.189.0/24 area 0.0.0.0
```

Step 4. Enable MPLS and LDP globally; Set the label protocol LDP on the interface

```
DGS6600:15(config)#mpls ip
DGS6600:15(config)#mpls label protocol ldp
DGS6600:15(config-if)#interface vlan152
DGS6600:15(config-if)#mpls ip
DGS6600:15(config-if)#mpls label protocol ldp
```

R2 (Router 2) Configuration Steps

Step 1. Create a VLAN and add ports into the VLAN

```
DGS6600:15 (config)#vlan 152
DGS6600:15 (config-vlan)#!
DGS6600:15 (config-vlan)#vlan 154
DGS6600:15 (config-vlan)#!
DGS6600:15 (config-vlan)#interface eth2.1
DGS6600:15 (config-if)# hybrid vlan 152 tagged
DGS6600:15 (config-if)# pvid 152
DGS6600:15 (config-if)#!
DGS6600:15 (config-if)#interface eth2.16
DGS6600:15 (config-if)#hybrid vlan 154 tagged
DGS6600:15 (config-if)#pvid 154
```

Step 2. Configure the IP address of VLAN

```
DGS6600:15 (config-if)#interface vlan152
DGS6600:15 (config-if)#ip address 152.170.189.152/24
DGS6600:15 (config-if)#!
DGS6600:15 (config-if)#interface vlan154
DGS6600:15 (config-if)#ip address 154.170.189.152/24
```

Step 3. Set OSPF route

```
DGS6600:15 (config-if)#router ospf
DGS6600:15 (config-router)#network 152.170.189.0/24 area 0.0.0.0
DGS6600:15 (config-router)#network 154.170.189.0/24 area 0.0.0.0
```

Step 4. Enable MPLS and LDP globally; Set the label protocol LDP on the interface

```
DGS6600:15 (config)#mpls ip
DGS6600:15 (config)#mpls label protocol ldp
DGS6600:15 (config-if)#interface vlan152
DGS6600:15 (config-if)#mpls ip
DGS6600:15 (config-if)#mpls label protocol ldp
DGS6600:15 (config-if)#interface vlan154
DGS6600:15 (config-if)#mpls ip
DGS6600:15 (config-if)#mpls label protocol ldp
```

R3 (Router 3) Configuration Steps

Step 1. Create a VLAN and add ports into the VLAN

```
DGS6600:15 (config)#vlan 153
DGS6600:15 (config-vlan)#!
DGS6600:15 (config-vlan)#vlan 154
DGS6600:15 (config-vlan)#!
DGS6600:15 (config-vlan)#interface eth2.1
DGS6600:15 (config-if)#access vlan 153
DGS6600:15 (config-if)#!
DGS6600:15 (config-if)#interface eth2.16
DGS6600:15 (config-if)#hybrid vlan 154 tagged
DGS6600:15 (config-if)#pvid 154
```

Step 2. Configure the IP address of the VLAN

```
DGS6600:15 (config-if)#interface vlan153
DGS6600:15 (config-if)#ip address 153.170.189.153/24
DGS6600:15 (config-if)#!
DGS6600:15 (config-if)#interface vlan154
DGS6600:15 (config-if)#ip address 154.170.189.153/24
```

Step 3. Set the OSPF route

```
DGS6600:15 (config-if)#router ospf
DGS6600:15 (config-router)#network 153.170.189.0/24 area 0.0.0.0
DGS6600:15 (config-router)#network 154.170.189.0/24 area 0.0.0.0
```

Step 4. Enable MPLS and LDP globally; Ste the label protocol LDP on the interface

```
DGS6600:15 (config)#mpls ip
DGS6600:15 (config)#mpls label protocol ldp
DGS6600:15 (config-if)#interface vlan154
DGS6600:15 (config-if)#mpls ip
DGS6600:15 (config-if)#mpls label protocol ldp
```

Verifying the configuration

Use the following command to check the MPLS relative information. This command can be used to check R1, R2 and R3.

```
DGS-6600:15#show mpls ldp neighbor
Peer : 152.170.189.152
-----
Protocol Version   : 1
Transport address  : 152.170.189.152
Keep Alive Time    : 30 (sec)
Distribute Method  : DU
Loop Detect         : Disabled
Path vector limit  : 254
Max PDU Length     : 4096

Total Entries: 1

DGS-6600:15#show mpls ldp session
Peer                Status          Role           Keep Alive      Distribution Mode
-----
152.170.189.152    OPERATIONAL     Passive        40 (Sec)        DU

Total Entries: 1

DGS-6600:15#show mpls forwarding-table
LSP  FEC                               In Label Out Label      Out Interface Next Hop
-----
1    153.170.189.0/24                 -        Push 53221      vlan152       152.170.189.152
2    154.170.189.0/24                 -        push 3         vlan152       152.170.189.152

Total Entries: 2
```

At the end of this configuration, PC1 (IP: 151.170.189.150/24) should be able to ping PC2 (IP: 153.170.189.150/24).

MPLS (Static Label) Configuration Example

Configuring MPLS protocol in R1, R2 and R3. The label of MPLS is set manually. DGS-6600 can forward the packets by these label information. PC1 and PC2 are at different network. PC1 can communicate with PC2 by MPLS

Topology

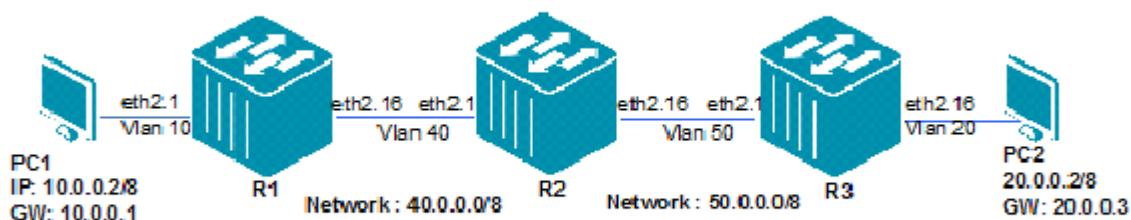

R1 (Router 1) Configuration Steps

Step 1. Create VLAN and add ports into VLAN

```
DGS6600:15(config)#vlan 10
DGS6600:15(config-vlan)#!
DGS6600:15(config-vlan)#vlan 40
DGS6600:15(config-vlan)#!
DGS6600:15(config-vlan)#interface eth2.1
DGS6600:15(config-if)#access vlan 10
DGS6600:15(config-if)#!
DGS6600:15(config-if)#interface eth2.16
DGS6600:15(config-if)#trunk allowed-vlan 40
```

Step 2. Configure IP address of VLAN

```
DGS6600:15(config-if)#interface vlan10
DGS6600:15(config-if)#ip address 10.0.0.1/8
DGS6600:15(config-if)#!
DGS6600:15(config-if)#interface vlan40
DGS6600:15(config-if)#ip address 40.0.0.1/8
```

Step 3. Set Static Route

```
DGS6600:15(config-if)#ip route 20.0.0.0/8 40.0.0.2
DGS6600:15(config)#ip route 50.0.0.0/8 40.0.0.2
```

Step 4. Enable MPLS globally and on the interface; set the static label of MPLS on the interface, set in/out-label behavior.

```
DGS6600:15(config)#mpls ip
DGS6600:15(config-if)#interface vlan40
DGS6600:15(config-if)# mpls ip
DGS6600:15(config)#mpls static ftn 20.0.0.0/8 out-label 400 nexthop 40.0.0.2
DGS6600:15(config)#mpls static ilm in-label 401 forward-action pop nexthop 10.0.0.4
fec 10.0.0.0/8
```

R2 (Router 2) Configuration Steps

Step 1. Create VLAN and add ports into VLAN

```
DGS6600:15 (config)#vlan 40
DGS6600:15 (config-vlan)#!
DGS6600:15 (config-vlan)#vlan 50
DGS6600:15 (config-vlan)#!
DGS6600:15 (config-vlan)#interface eth2.1
DGS6600:15 (config-if)#trunk allowed-vlan 40
DGS6600:15 (config-if)#pvid 40
DGS6600:15 (config-if)#!
DGS6600:15 (config-if)#interface eth2.16
DGS6600:15 (config-if)#trunk allowed-vlan 50
DGS6600:15 (config-if)#pvid 50
```

Step 2. Configure IP address of VLAN

```
DGS6600:15 (config-if)#!
DGS6600:15 (config-if)#interface vlan40
DGS6600:15 (config-if)#ip address 40.0.0.2/8
DGS6600:15 (config-if)#!
DGS6600:15 (config-if)#interface vlan50
DGS6600:15 (config-if)#ip address 50.0.0.2/8
```

Step 3. Set Static Route

```
DGS6600:15 (config-if)#ip route 10.0.0.0/8 40.0.0.1
DGS6600:15 (config)#ip route 20.0.0.0/8 50.0.0.3
```

Step 4. Enable MPLS globally on the interface. Set the static label of the MPLS on the interface. Set in-label behavior.

```
DGS6600:15 (config)#mpls ip
DGS6600:15 (config-if)#interface vlan40
DGS6600:15 (config-if)#mpls ip
DGS6600:15 (config-if)#interface vlan50
DGS6600:15 (config-if)#mpls ip
DGS6600:15 (config)#mpls static ilm in-label 400 forward-action swap-label 500
nextthop 50.0.0.3 fec 20.0.0.0/8
DGS6600:15 (config)#mpls static ilm in-label 501 forward-action swap-label 401
nextthop 40.0.0.1 fec 10.0.0.0/8
```

R3 (Router 3) Configuration Example

Step 1. Create VLAN and add ports into VLAN

```
DGS6600:15 (config) #vlan 20
DGS6600:15 (config-vlan) #!
DGS6600:15 (config-vlan) #vlan 50
DGS6600:15 (config-vlan) #!
DGS6600:15 (config-vlan) #interface eth2.1
DGS6600:15 (config-if) #trunk allowed-vlan 50
DGS6600:15 (config-if) #!
DGS6600:15 (config-if) #interface eth2.16
DGS6600:15 (config-if) #access vlan 20
```

Step 2. Configure IP address of VLAN

```
DGS6600:15 (config-if) #interface vlan20
DGS6600:15 (config-if) #ip address 20.0.0.3/8
DGS6600:15 (config-if) #!
DGS6600:15 (config-if) #interface vlan50
DGS6600:15 (config-if) #ip address 50.0.0.3/8
```

Step 3. Set Static Route

```
DGS6600:15 (config-if) #ip route 10.0.0.0/8 50.0.0.2
DGS6600:15 (config) #ip route 40.0.0.0/8 50.0.0.2
```

Step 4. Enable MPLS globally on the interface. Set the static label of MPLS on the interface. Set in-label behavior.

```
DGS6600:15 (config) #mpls ip
DGS6600:15 (config-if) #interface vlan50
DGS6600:15 (config-if) #mpls ip
DGS6600:15 (config) #mpls static ftn 10.0.0.0/8 out-label 501 nexthop 50.0.0.2
DGS6600:15 (config) #mpls static ilm in-label 500 forward-action pop nexthop 20.0.0.4
fec 20.0.0.0/8
```

Verifying the Configuration

Use following commands to check the MPLS label forwarding path information.

R1.

```
DGS6600:15#show mpls forwarding-table
LSP  FEC                               In Label  Out Label  Out Interface  Next Hop
-----
1    20.0.0.0/8                          -         Push 400   vlan40         40.0.0.2
2    10.0.0.0/8                          401      Pop       vlan10         10.0.0.4

Total Entries: 2
```

R2.

```
DGS6600:15#show mpls forwarding-table
LSP  FEC                               In Label  Out Label  Out Interface  Next Hop
-----
1    20.0.0.0/8                          400      Swap 500   vlan50         50.0.0.3
2    10.0.0.0/8                          501      Swap 401   vlan40         40.0.0.1

Total Entries: 2
```

R3.

```
DGS6600:15#sho mpls forwarding-table
LSP  FEC                               In Label  Out Label  Out Interface  Next Hop
-----
1    10.0.0.0/8                          -         Push 501   vlan50         50.0.0.2
2    20.0.0.0/8                          500      Pop       vlan20         20.0.0.4

Total Entries: 2
```

PC 1 (10.0.0.2/8) should be able to ping PC2 (20.0.0.2/8).

MPLS QoS Configuration Example

DGS-6600 can provide QoS base on the EXP value of MPLS label.

Mapping rule:

Inbound mapping: DGS-6600 assign ingress packets priority according to EXP value

Outbound mapping: DGS-6600 changes EXP value according to egress packets priority.

In the following example, the DGS-6600 R1 will implement MPLS QoS according to mapping rule if the packet's destination matches 20.0.0.0/8

Topology

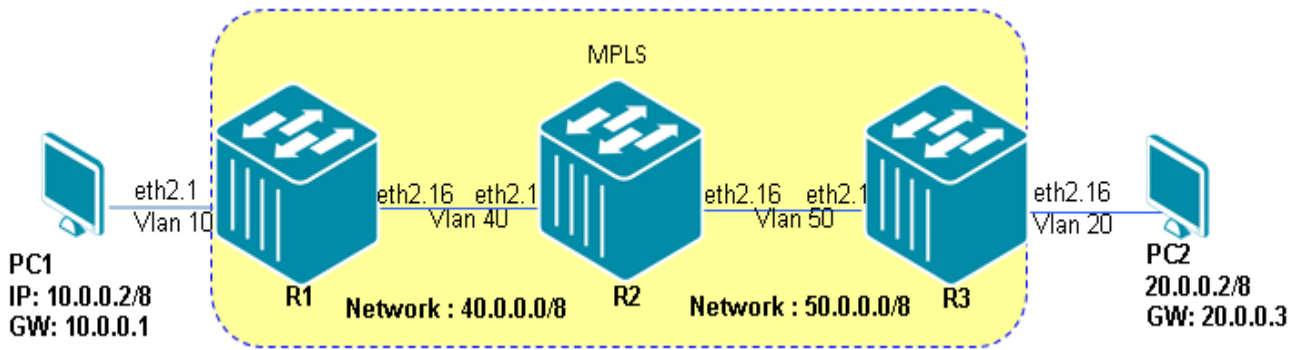

R1 (Router 1) Configuration Steps

Step 1. Create VLAN and add ports into VLAN.

```
DGS-6600:15(config)#vlan 10
DGS-6600:15(config-vlan)#!
DGS-6600:15(config-vlan)#vlan 40
DGS-6600:15(config-vlan)#!
DGS-6600:15(config-vlan)#interface eth2.1
DGS-6600:15(config-if)# access vlan 10
DGS-6600:15(config-if)#!
DGS-6600:15(config-if)#interface eth2.16
DGS-6600:15(config-if)# trunk allowed-vlan 40
DGS-6600:15(config-if)#end
```

Step 2. Enable MPLS QOS and set inbound/outbound mapping rule.

```
DGS-6600:15(config)#mpls qos policy policy1
DGS-6600:15(config-mpls-router)#trust-exp
DGS-6600:15(config-mpls-router)#match ip 20.0.0.0/8
DGS-6600:15(config-mpls-router)#class-map inbound exp 0 priority 0
DGS-6600:15(config-mpls-router)#class-map inbound exp 1 priority 1
DGS-6600:15(config-mpls-router)#class-map inbound exp 2 priority 2
DGS-6600:15(config-mpls-router)#class-map inbound exp 3 priority 3
DGS-6600:15(config-mpls-router)#class-map inbound exp 4 priority 4
DGS-6600:15(config-mpls-router)#class-map inbound exp 5 priority 5
DGS-6600:15(config-mpls-router)#class-map inbound exp 6-7 priority 6
DGS-6600:15(config-mpls-router)#class-map outbound priority 1 exp 6
DGS-6600:15(config-mpls-router)#class-map outbound exp 3
```

Step 3. Configure IP address of VLAN.

```
DGS-6600:15(config-if)#interface vlan10
DGS-6600:15(config-if)# ip address 10.0.0.1/8
DGS-6600:15(config-if)#!
DGS-6600:15(config-if)#interface vlan40
DGS-6600:15(config-if)# ip address 40.0.0.1/8
```

Step 4. Set static route

```
DGS-6600:15(config-if)#ip route 20.0.0.0/8 40.0.0.2
DGS-6600:15(config)#ip route 50.0.0.0/8 40.0.0.2
```

Step 5. Enable MPLS globally and on the interface; Set the static label of MPLS on the interface. ; Set in/out-label behavior

```
DGS-6600:15(config)#mpls ip
DGS-6600:15(config-if)#interface vlan40
DGS-6600:15(config-if)# mpls ip
DGS-6600:15(config)#mpls static ftn 20.0.0.0/8 out-label 400 nexthop 40.0.0.2
DGS-6600:15(config)#mpls static ilm in-label 401 forward-action pop nexthop
10.0.0.4 fec 10.0.0.0/8
```

R2 (Router 2) Configuration Steps**Step 1. Create VLAN and add ports into VLAN.**

```
DGS-6600:15(config)#vlan 40
DGS-6600:15(config-vlan)#!
DGS-6600:15(config-vlan)#vlan 50
DGS-6600:15(config-vlan)#!
DGS-6600:15(config-vlan)#interface eth2.1
DGS-6600:15(config-if)# trunk allowed-vlan 40
DGS-6600:15(config-if)# pvid 40
DGS-6600:15(config-if)#!
DGS-6600:15(config-if)#interface eth2.16
DGS-6600:15(config-if)# trunk allowed-vlan 50
DGS-6600:15(config-if)# pvid 50
```

Step 2. Enable MPLS QOS and set inbound/outbound mapping rule.

```
DGS-6600:15(config)#mpls qos policy policy1
DGS-6600:15(config-mpls-router)#trust-exp
DGS-6600:15(config-mpls-router)#match ip 20.0.0.0/8
DGS-6600:15(config-mpls-router)#class-map inbound exp 0 priority 0
DGS-6600:15(config-mpls-router)#class-map inbound exp 1 priority 1
DGS-6600:15(config-mpls-router)#class-map inbound exp 2 priority 2
DGS-6600:15(config-mpls-router)#class-map inbound exp 3 priority 3
DGS-6600:15(config-mpls-router)#class-map inbound exp 4 priority 4
DGS-6600:15(config-mpls-router)#class-map inbound exp 5 priority 5
DGS-6600:15(config-mpls-router)#class-map inbound exp 6-7 priority 6
DGS-6600:15(config-mpls-router)#class-map outbound priority 1 exp 6
DGS-6600:15(config-mpls-router)#class-map outbound exp 3
```

Step 3. Set Static Route

```
DGS-6600:15(config-if)#!  
DGS-6600:15(config-if)#interface vlan40  
DGS-6600:15(config-if)# ip address 40.0.0.2/8  
DGS-6600:15(config-if)#!  
DGS-6600:15(config-if)#interface vlan50  
DGS-6600:15(config-if)# ip address 50.0.0.2/8
```

Step 4. Set static route

```
DGS-6600:15(config-if)#ip route 10.0.0.0/8 40.0.0.1  
DGS-6600:15(config)#ip route 20.0.0.0/8 50.0.0.3
```

Step 5. Enable MPLS globally and on the interface; Set the static label of MPLS on the interface. ; Set in-label behavior.

```
DGS-6600:15(config)#mpls ip  
DGS-6600:15(config-if)#interface vlan40  
DGS-6600:15(config-if)# mpls ip  
DGS-6600:15(config-if)#interface vlan50  
DGS-6600:15(config-if)# mpls ip  
DGS-6600:15(config)#mpls static ilm in-label 400 forward-action swap-label 500  
nexthop 50.0.0.3 fec 20.0.0.0/8  
DGS-6600:15(config)#mpls static ilm in-label 501 forward-action swap-label 401  
nexthop 40.0.0.1 fec 10.0.0.0/8
```

R3 (Router 3) Configuration Example

Step1. Create VLAN and add ports into VLAN.

```
DGS-6600:15(config)#vlan 20  
DGS-6600:15(config-vlan)#!  
DGS-6600:15(config-vlan)#vlan 50  
DGS-6600:15(config-vlan)#!  
DGS-6600:15(config-vlan)#interface eth2.1  
DGS-6600:15(config-if)# trunk allowed-vlan 50  
DGS-6600:15(config-if)#!  
DGS-6600:15(config-if)#interface eth2.16  
DGS-6600:15(config-if)# access vlan 20
```

Step 2. Enable MPLS QOS and set inbound/outbound mapping rule.

```
DGS-6600:15(config)#mpls qos policy policy1
DGS-6600:15(config-mpls-router)#trust-exp
DGS-6600:15(config-mpls-router)#match ip 20.0.0.0/8
DGS-6600:15(config-mpls-router)#class-map inbound exp 0 priority 0
DGS-6600:15(config-mpls-router)#class-map inbound exp 1 priority 1
DGS-6600:15(config-mpls-router)#class-map inbound exp 2 priority 2
DGS-6600:15(config-mpls-router)#class-map inbound exp 3 priority 3
DGS-6600:15(config-mpls-router)#class-map inbound exp 4 priority 4
DGS-6600:15(config-mpls-router)#class-map inbound exp 5 priority 5
DGS-6600:15(config-mpls-router)#class-map inbound exp 6-7 priority 6
DGS-6600:15(config-mpls-router)#class-map outbound priority 1 exp 6
DGS-6600:15(config-mpls-router)#class-map outbound exp 3
```

Step 3. Configure IP address of VLAN

```
DGS-6600:15(config-if)#interface vlan20
DGS-6600:15(config-if)# ip address 20.0.0.3/8
DGS-6600:15(config-if)#!
DGS-6600:15(config-if)#interface vlan50
DGS-6600:15(config-if)# ip address 50.0.0.3/8
```

Step 4. Enable MPLS globally on the interface. Set the static label of MPLS on the interface. Set in-label behavior.

```
DGS-6600:15(config-if)#ip route 10.0.0.0/8 50.0.0.2
DGS-6600:15(config)#ip route 40.0.0.0/8 50.0.0.2
```

Step 4. Enable MPLS globally on the interface. Set the static label of MPLS on the interface. Set in-label behavior.

```
DGS-6600:15(config)#mpls ip
DGS-6600:15(config-if)#interface vlan50
DGS-6600:15(config-if)# mpls ip
DGS-6600:15(config)#mpls static ftn 10.0.0.0/8 out-label 501 nexthop 50.0.0.2
DGS-6600:15(config)#mpls static ilm in-label 500 forward-action pop nexthop
20.0.0.4 fec 20.0.0.0/8
```

Verifying the Configuration

Use following command to check the MPLS QoS mapping rules.

```
DGS-6600:15#show mpls qos

MPLS QoS Policy: policy1, Trust EXP
  Inbound Mapping
    EXP      : 0, 1, 2, 3, 4, 5, 6, 7
    Priority: 0, 1, 2, 3, 4, 5, 6, 6
  Outbound Mapping
    Priority: 0, 1, 2, 3, 4, 5, 6, 7
    EXP      : 3, 6, 3, 3, 3, 3, 3, 3
  Binding FECs:
    20.0.0.0/8

Total Entries: 1
```

Configuration Restrictions

For support MPLS, the hardware must support label operation. In addition, L3 route and LDP shall be supported.

The MPLS interface is L3 interface. LSR ID is an IPv4 address of a L3 interface. Suggest using the loop back interface address as the LSR ID.

LDP is MPLS signaling protocol defined for distributing label binding information. To enable LDP, you must enable MPLS at first.

The LSP establishment depends on the L3 route information. The route information can be created by route protocol or static configuration.

Constant	Value
Static ILM entries	16
Static FTN entries	16
QoS entries	256
Qos matched rules	32
MPLS interface number	64
Max Prefix FEC	128
Max FEC number	2128
LDP Max Targeted Peer	64
LDP Max Peer	128
LDP Max Adjacency	128
LDP Max Interface	300
LDP Max LSP Trigger rules	128

Chapter 34

Virtual Private Wire Service (VPWS)

Chapter Overview

The following topics are included in this chapter, please go to the topic for more detailed information:

- [Chapter Overview](#)
- [An Introduction to VPWS \(Virtual Pseudo Wire Service\)](#)
- [VPWS Configuration Commands](#)
 - [MPLS ip](#)
 - [mpls label protocol ldp](#)
 - [xconnect and show mpls forwarding-table](#)
- [Configuration examples](#)
 - [Configuring a VPWS](#)
- [Configuration Restrictions and constants](#)

An Introduction to VPWS (Virtual Pseudo Wire Service)

The Virtual Private Wire Service (VPWS) is a L2VPN solution that provides L2 point-to-point virtual circuit connectivity between customer sites over a provider network. VPWS enables the sharing of a provider's core network infrastructure between IP and L2VPN services, reducing the cost of providing those services.

The tunneling mechanism of the VPWS can use any tunneling protocols. In this specification, it uses MPLS for the transport layer.

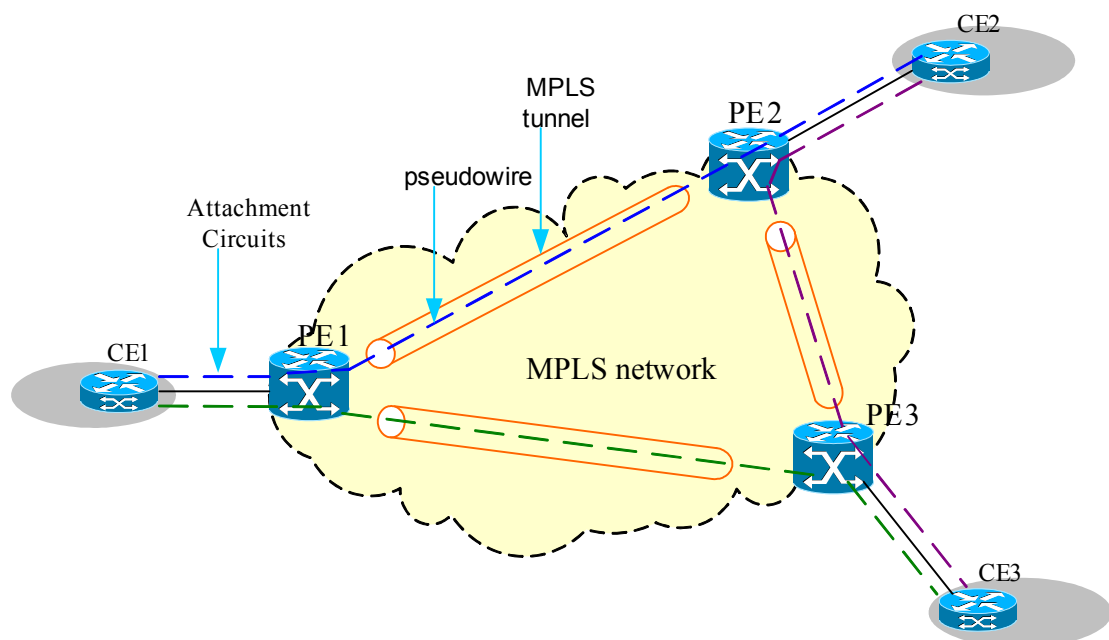

Figure 34-1 MPLS-based VPWS

In above figure, MPLS network is the packet switched network (PSN). Each customer edge device (CE) is connected to the provider edge (PE) via an attachment circuit (AC). The PE does a one-to-one mapping between the pseudo wire (PW) and AC based on local information. A PW is an emulated point-to-point connection over a packet switched network that allows the interconnection of two nodes with any L2 technology.

The required functions of PWs include encapsulating service-specific bit streams, cells, or PDUs arriving at an ingress port and carrying them across an IP path or MPLS tunnel [4].

PWs provide the following functions in order to emulate the behavior and characteristics of the native service.

- 1.Encapsulation of service-specific PDUs or circuit data arriving at the PE-bound port (logical or physical).
- 2.Carriage of the encapsulated data across a PSN tunnel.
- 3.Establishment of the PW, including the exchange and/or distribution of the PW identifiers used by the PSN tunnel endpoints.
- 4.Managing the signaling, timing, order, or other aspects of the service at the boundaries of the PW. Service-specific status and alarm management.

One or more PWs are carried in a MPLS tunnel from one PE to another. Any given frame travels first on its ingress AC, then on a PW, and then on its egress AC. A particular combination of <AC, PW, AC> forms a virtual circuit between two CE devices.

NOTICE: If one port joins a MPLS L2VPN, it is supposed that all traffic to this port should be transparently sent on MPLS L2VPN. The user should not configure an IP interface in this port. If IP interface is configured, it should be a configuration error.

VPWS Configuration Commands

MPLS ip

Command	Explanation
<code>mpls ip</code>	Use mpls ip command in global configuration mode to enable the MPLS to forward globally.

This example shows how to enable MPLS globally.

```
DGS6600 (config)#mpls ip
```

mpls label protocol ldp

Command	Explanation
<code>mpls label protocol ldp</code>	Use mpls label protocol ldp command in global configuration mode to enable LDP globally. Use no mpls label protocol ldp in global configuration mode to disable LDP globally.

This example shows how to enable LDP globally.

```
DGS6600(config)#mpls label protocol ldp
DGS6600(config-mpls-router)#
```

xconnect and show mpls forwarding-table

Command	Explanation
<code>xconnect VC-ID IP-ADDRESS encapsulation mpls [raw tagged]</code>	Use the xconnect command to enable the VPWS service on the interface. Use the no form of this command to cancel VPWS service.
<code>show mpls forwarding-table [vc VC-ID IP-ADDRESS] [detail]</code>	Use this command to show the MPLS label forwarding path information.

This sample shows all MPLS label forwarding path information.

LSP	FEC	In Label	Out Label	Out Interface	Next Hop
1	201.1.1.0/24	20	swap 30	VLAN 10	172.18.1.1
2	201.2.1.0/24	60	swap 40	VLAN 20	192.1.1.2
3	172.1.1.1/32	50	pop	VLAN 10	172.18.1.1
4	192.1.1.0/24	-	push 70	VLAN 10	172.18.1.1
5	VC11/192.1.1.1	-	push 100/70	VLAN 10	172.18.1.1
6	VC11/192.1.1.1	200	pop for VC	Eth3.5	-

Total Entries: 6

In the above example, LSP 5 is the outbound LSP of the VC FEC whose VC ID is 11 and peer is 192.1.1.1.

It pushes VC label 100 and tunnel label 70. The inbound LSP of the VC FEC is LSP 6. It pops incoming VC label 200 and forwards the terminated packets to Ethernet port 3.5.

Configuration examples

Configuring a VPWS

The follows example shows how to configure a VPWS (Raw Mode).

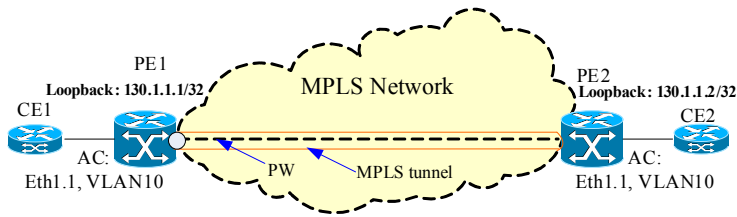

The AC from CE (Customer Edge Bridge) to PE is the VLAN 10 of port 1. Assume the MPLS interfaces of PEs are VLAN 20 and the VC-ID is 2. For untagged packets from CE one can be transmitted to the other end through the MPLS network, user shall configure PE1 and PE2 as follows:

Configuring PE 1

```
DGS6600:15(config)#interface vlan 20
DGS6600:15(config-if)#mpls ip
DGS6600:15(config-if)#mpls label protocol ldp
DGS6600:15(config-if)#exit
DGS6600:15(config)#mpls ip
DGS6600:15(config)#mpls label protocol ldp
DGS6600:15(config-mpls-router)#transport-address 130.1.1.1
DGS6600:15(config-mpls-router)#exit
DGS6600:15(config)#interface eth1.1
DGS6600:15(config-if)# xconnect 2 130.1.1.2 encapsulation mpls raw
```

Configuring PE 2

```
DGS6600:15(config)#interface vlan 20
DGS6600:15(config-if)#mpls ip
DGS6600:15(config-if)#mpls label protocol ldp
DGS6600:15(config-if)#exit
DGS6600:15(config)#mpls ip
DGS6600:15(config)#mpls label protocol ldp
DGS6600:15(config-mpls-router)# transport-address 130.1.1.2
DGS6600:15(config-mpls-router)#exit
DGS6600:15(config)#interface eth1.1
DGS6600:15(config-if)# xconnect 2 130.1.1.1 encapsulation mpls raw
```

The following example shows how to configure a VPWS (Tagged Mode).

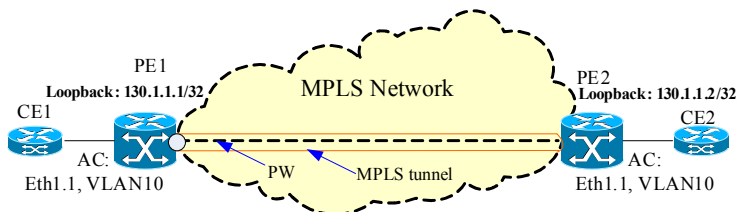

The AC from CE (Customer Edge Bridge) to PE is the VLAN 10 of port 1. Assume the MPLS interfaces of PEs are VLAN 20 and the VC-ID is 2. For tagged packets from CE one can be transmitted to the other end through the MPLS network, user shall configure PE1 and PE2 as follows:

Configuring PE 1

```
DGS6600:15(config)#interface vlan 20
DGS6600:15(config-if)#mpls ip
DGS6600:15(config-if)#mpls label protocol ldp
DGS6600:15(config-if)#exit
DGS6600:15(config)#mpls ip
DGS6600:15(config)#mpls label protocol ldp
DGS6600:15(config-mpls-router)#transport-address 130.1.1.1
DGS6600:15(config-mpls-router)#exit
DGS6600:15(config)#interface eth1.1
DGS6600:15(config-if)# encapsulation dot1q 10
DGS6600:15(config-subif)# xconnect 2 130.1.1.2 encapsulation mpls tagged
```

Configuring PE 2

```
DGS6600:15(config)#interface vlan 20
DGS6600:15(config-if)#mpls ip
DGS6600:15(config-if)#mpls label protocol ldp
DGS6600:15(config-if)#exit
DGS6600:15(config)#mpls ip
DGS6600:15(config)#mpls label protocol ldp
DGS6600:15(config-mpls-router)# transport-address 130.1.1.2
DGS6600:15(config-mpls-router)#exit
DGS6600:15(config)#interface eth1.1
DGS6600:15(config-if)# encapsulation dot1q 10
DGS6600:15(config-subif)# xconnect 2 130.1.1.1 encapsulation mpls tagged
```

Configuration Restrictions and constants

For support MPLS-based VPWS, the MPLS function shall be supported by hardware. In addition, the LDP software module shall be supported.

The VPWS uses MPLS tunnel label to transmit packet and use VC label as PW demultiplexer.

At same time, VPWS uses LDP to distribute label and maintain PW status.

Constant	Value
Max VPWS entries (Static and Dynamic)	1024
Max Peers	2000
Max AC	2000

Chapter 35

Virtual Private Lan Services (VPLS)

Chapter Overview

The following topics are included in this chapter, please go to the topic for more detailed information:

- [Chapter Overview](#)
- [An Introduction to VPLS](#)
 - [Attachment Circuit \(AC\)](#)
 - [Pseudowire \(PW\)](#)
 - [MPLS Tunnel](#)
 - [VPLS Service](#)
- [VPLS Configuration Commands](#)
 - [Creating a VPLS](#)
 - [Setting a VPLSID](#)
 - [Pseudowire configuration](#)
 - [Encapsulation Configuration](#)
 - [Setting a local AC link MTU of a VPLS](#)
 - [Clearing Mac Address Tables for VPLS](#)
- [Configuration Examples](#)
 - [MPLS - VPLS Configuration Example](#)
- [Configuration Restrictions and Constants](#)

An Introduction to VPLS

A Virtual Private LAN Service (VPLS) is an L2VPN service that emulates LAN service across a Wide Area Network (WAN). The primary motivation of VPLS is to provide connectivity between geographically dispersed customer sites across MANs and WANs, as if they were connected using a LAN.

All PEs which participate in a VPLS interconnect each other via a full mesh of Pseudowires (PWs) through the provider network (i.e. MPLS network in this specification). A CE connects to a VPLS by attaching to one of the PEs via an Attachment Circuit (AC).

VPLS operation emulates an IEEE Ethernet bridge and it is fully capable of learning and forwarding a frame on Ethernet MAC address. So a CE can transmit the frames to multiple remote CEs. When a CE transmits a frame, the PE that receiving it examines the addressing information in the frame's L2 header in order to determine how to forward the frame (to a local CE or a remote PE via PW). Forwarding decisions are made in the manner that is normal for bridges, which is based on MAC source address learning.

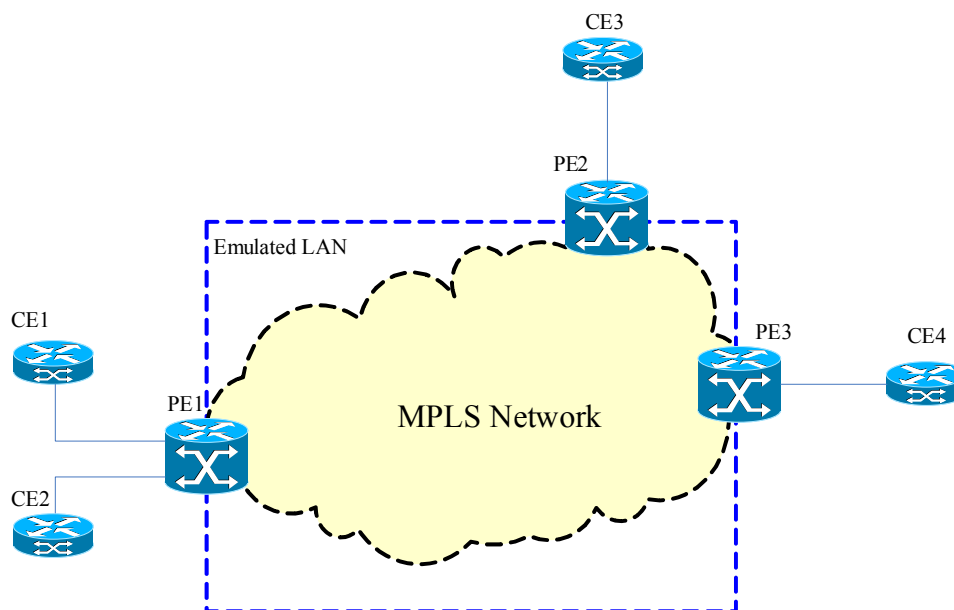

Figure 35-1 VPLS Deployment

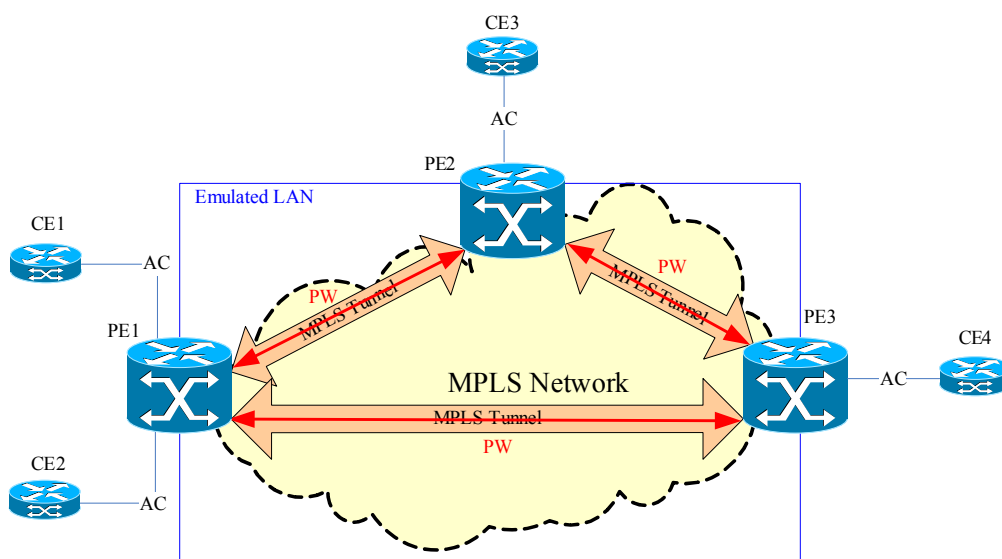

Figure 35-2 VPLS Reference Model - shows a VPLS reference model where the PEs that are VPLS-capable provide a logical interconnect such that the CEs belonging to a VPLS appear to be on a single emulated bridged Ethernet LAN.

Attachment Circuit (AC)

In a VPLS, a CE device attaches through an Attachment Circuit (AC) to a PE. The AC carries the Ethernet frames from the CE to the PE or from the PE to the CE. The AC can be an Ethernet port or an Ethernet VLAN port which is associated with an Ethernet port and a specified VLAN.

Pseudowire (PW)

A PE connects through a full mesh of Pseudowires (PWs) to other PEs in the VPLS. A PW carry MPLS packets which encapsulate Ethernet frame belonging to a VPLS through MPLS network from a PE to another PE.

The encapsulation mode of PW can be Ethernet raw mode and Ethernet tagged mode. All PWs in a VPLS should have same encapsulation mode.

MPLS Tunnel

MPLS tunnels are set up between PEs to aggregate MPLS packet traffic. The multiple PWs belonging to different VPLS instances can be carried in a single MPLS tunnel from one PE to another PE.

VPLS Service

In the PE, a Virtual Switching Instance (VSI) for a VPLS will map multiple ACs to multiple PWs. It makes the forwarding decision when a frame is forwarded from an AC to a PW or a frame is forwarded from a PW to an AC in the PE. A VPLS instance consists of a set of VSI form emulated LAN over a provider network.

1.Emulated Service

The service emulated by a VPLS instance can be Ethernet service or Ethernet VLAN service. This decides the emulated service on the PWs in this VPLS. If VPLS service is the Ethernet service, the encapsulation mode of the PWs is Ethernet raw mode; If VPLS service is the Ethernet VLAN service, the encapsulation mode of PWs is Ethernet tagged mode.

In the default, the emulated service of a VPLS is Ethernet VLAN service.

2.MTU

The MTU (Maximum Transmission Unit) of the VPLS must be the same across all the PWs in the mesh.

3.L2 Protocols

802.3x Pause frames send from a CE will not be transported over a VPLS. L2 Protocol PDUs (e.g. STP PDUs, GVRP PDUs, etc) need to be sent from a local CE to remote CEs are simply tunneled through the provider network.

VPLS Configuration Commands

listed below are some of the more commonly used VPLS commands, used in the examples below.

Command	Explanation
<code>vpls VPLS-NAME</code>	Use the <code>vpls</code> command in global configuration mode to create a VPLS and enter VPLS configuration mode. Use <code>no vpls</code> command in global configuration mode to delete a VPLS. The name range 1 - 32 characters.
<code>vpls-id VPLS-ID</code>	Use the <code>vpls-id</code> command in VPLS configuration mode to set VPLSID of a VPLS.
<code>xconnect vpls VPLS-NAME</code>	Use <code>xconnect vpls</code> command in interface configuration mode to create a local AC in a VPLS. Use <code>no xconnect vpls</code> command in interface configuration mode to delete a local AC in a VPLS.
<code>peer IP-ADDRESS [{network spoke}]</code>	Use the <code>peer</code> command in VPLS configuration mode to create a peer i.e. a pseudowire in a VPLS. Use <code>no peer</code> command in VPLS configuration mode to delete a peer in a VPLS.
<code>encapsulation {raw tagged}</code>	Use <code>encapsulation</code> command in VPLS configuration mode to set pseudowire encapsulation type of a VPLS

Table 35-1 VPLS (Abbreviated) command list

Command	Explanation
mtu 0-65535	Use mtu command in VPLS configuration mode to set local AC link MTU of a VPLS.
clear mac address-table vpls dynamic [VPLS-NAME [{peer IP-ADDRESS ac interface INTERFACE-ID [vlan VLAN-ID] address MAC-ADDR}]]	Use clear mac address-table vpls command in EXEC mode to clear VPLS MAC address.
show vpls [VPLS-NAME] [detail]	Use the show vpls command in EXEC mode to show VPLS information.
show mac address-table vpls [VPLS-NAME [{peer IP-ADDRESS ac interface INTERFACE-ID [vlan VLAN-ID}]]] [address MAC-ADDR]	Use the show mac address-table vpls command in EXEC mode to show a VPLS MAC address information.

Table 35-1 VPLS (Abbreviated) command list

Creating a VPLS

The follow example shows how to create a VPLS which name is “vpls100” and enter VPLS configuration mode.

```
DGS-6000:15(config)#vpls vpls100
```

Setting a VPLSID

The follow example shows how to set VPLSID of a VPLS to 100.

```
DGS-6000:15(config)#vpls vpls100
DGS-6000:15(config-vpls)#vpls-id 100
```

Psuedowire configuration

The following example shows how to create a peer i.e. a psuedowire which ip address 2.2.2.2 is a network psuedowire and then create a peer, which ip address 3.3.3.3 is a spoke psuedowire.

```
DGS-6000:15(config)#vpls vpls100
DGS-6000:15(config-vpls)#peer 2.2.2.2
DGS-6000:15(config-vpls)#peer 3.3.3.3 spoke
```

Encapsulation Configuration

The follow example shows how to set pseudowire encapsulation type of a VPLS to Ethernet-raw mode.

```
DGS-6000:15(config)#vpls vpls100
DGS-6000:15(config-vpls)#encapsulation raw
```

Setting a local AC link MTU of a VPLS

The follow example shows how to set local AC link MTU of a VPLS to 1000.

```
DGS-6000:15(config)#vpls vpls100
DGS-6000:15(config-vpls)#mtu 1000
```

Clearing Mac Address Tables for VPLS

The following example show how to clear all VPLS MAC addresses.

```
DGS-6000:15(config)#clear mac address-table vpls dynamic
```

The following example shows how to clear VPLS MAC address for a VPLS.

```
DGS-6000:15(config)#clear mac address-table vpls dynamic vpls100
```

The following example shows how to clear VPLS MAC address for a peer of a VPLS.

```
DGS-6000:15(config)#clear mac address-table vpls dynamic vpls100 peer 1.1.1.1
```

The following example shows how to clear VPLS MAC address for a local AC of a VPLS.

```
DGS-6000:15(config)#clear mac address-table vpls dynamic vpls100 ac interface
eth1.1 vlan 100
```

The following example shows how to clear one VPLS MAC address.

```
DGS-6000:15(config)#clear mac address-table vpls dynamic vpls100 address
00:11:22:33:44:55
```

Configuration Examples

MPLS - VPLS Configuration Example

Configuring MPLS protocol for R1, R2 and R3. The label of MPLS is learned by LDP protocol.

VPLS tunnel are established on R1 and R2. All PCs sites in a VPLS appear to be on the same Local Area Network (LAN), regardless of their locations. For example, PC1 and PC2 are at same network but connected on different sites. PC1 can communicate with PC2 through VPLS over MPLS.

Topology

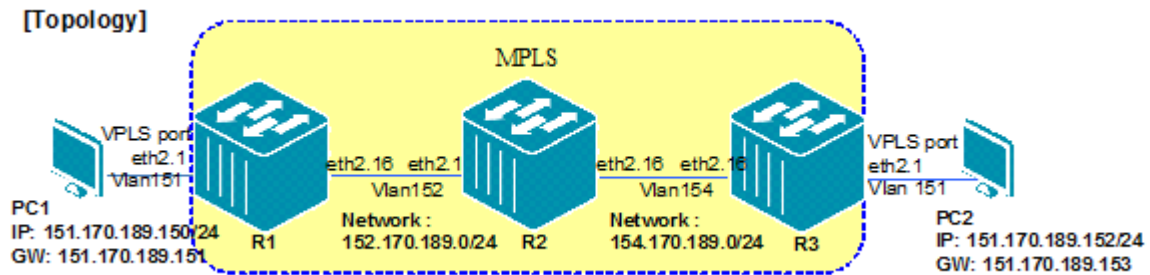

R1 (Router 1) Configuration Steps

Step 1. Create VLAN and add ports into VLAN.

```
DGS6600:15(config)#vlan 151
DGS6600:15(config-vlan)#!
DGS6600:15(config-vlan)#vlan 152
DGS6600:15(config-vlan)#!
DGS6600:15(config-vlan)#interface eth2.1
DGS6600:15(config-if)# access vlan 151
DGS6600:15(config-if)#!
DGS6600:15(config-if)#interface eth2.16
DGS6600:15(config-if)#hybrid vlan 152 tagged
DGS6600:15(config-if)#pvid 152
```

Step 2. Configure an IP address for the VLAN.

```
DGS6600:15(config-if)#interface vlan152
DGS6600:15(config-if)# ip address 152.170.189.151/24
```

Step 3. Set OSPF route.

```
DGS6600:15(config-if)#router ospf
DGS6600:15(config-router)#network 152.170.189.0/24 area 0.0.0.0
```

Step 4. Enable MPLS and LDP globally. Set the label protocol LDP on the interface.

```
DGS6600:15(config)#mpls ip
DGS6600:15(config)#mpls label protocol ldp
DGS6600:15(config-if)#interface vlan152
DGS6600:15(config-if)#mpls ip
DGS6600:15(config-if)#mpls label protocol ldp
```

Step 5. Set a loopback address and configure VPLS.

```
DGS6600:15(config-if)#interface loopback1
DGS6600:15(config-if)#ip address 11.34.55.31/24
DGS6600:15(config-if)#interface eth2.1
DGS6600:15(config-if)#xconnect vpls 3006
DGS6600:15(config)#vpls 3006
DGS6600:15(config-vpls)#vpls-id 3006
DGS6600:15(config-vpls)#peer 12.34.55.32
```

R2 (Router 2) Configuration Steps.**Step 1. Create VLAN and add ports into VLAN.**

```
DGS6600:15(config)#vlan 152
DGS6600:15(config-vlan)#!
DGS6600:15(config-vlan)#vlan 154
DGS6600:15(config-vlan)#!
DGS6600:15(config-vlan)#interface eth2.1
DGS6600:15(config-if)#hybrid vlan 152 tagged
DGS6600:15(config-if)#pvid 152
DGS6600:15(config-if)#!
DGS6600:15(config-if)#interface eth2.16
DGS6600:15(config-if)#hybrid vlan 154 tagged
DGS6600:15(config-if)#pvid 154
```

Step 2. Configure IP address of VLAN.

```
DGS6600:15(config-if)#interface vlan154
DGS6600:15(config-if)#ip address 154.170.189.152/24
```

Step 3. Set OSPF route.

```
DGS6600:15(config-if)#router ospf
DGS6600:15(config-router)#network 154.170.189.0/24 area 0.0.0.0
```

Step 4. Enable MPLS and LDP globally. Set the label protocol LDP on the interface.

```
DGS6600:15(config)#mpls ip
DGS6600:15(config)#mpls label protocol ldp
DGS6600:15(config-if)#interface vlan152
DGS6600:15(config-if)#mpls ip
DGS6600:15(config-if)#mpls label protocol ldp
DGS6600:15(config-if)#interface vlan154
DGS6600:15(config-if)#mpls ip
DGS6600:15(config-if)#mpls label protocol ldp
```

R3 (Router 3) Configuration Steps.

Step 1. Create a VLAN and add ports into the VLAN.

```
DGS6600:15 (config)#vlan 151
DGS6600:15 (config-vlan)#!
DGS6600:15 (config-vlan)#vlan 154
DGS6600:15 (config-vlan)#!
DGS6600:15 (config-vlan)#interface eth2.1
DGS6600:15 (config-if)# access vlan 151
DGS6600:15 (config-if)#!
DGS6600:15 (config-if)#interface eth2.16
DGS6600:15 (config-if)#hybrid vlan 154 tagged
DGS6600:15 (config-if)#pvid 154
```

Step 2. Configure the IP address of the VLAN.

```
DGS6600:15 (config-if)#interface vlan151
DGS6600:15 (config-if)#ip address 151.170.189.153/24
DGS6600:15 (config-if)#!
DGS6600:15 (config-if)#interface vlan154
DGS6600:15 (config-if)#ip address 154.170.189.153/24
```

Step 3. Set the OSPF route.

```
DGS6600:15 (config-if)#router ospf
DGS6600:15 (config-router)#network 151.170.189.0/24 area 0.0.0.0
DGS6600:15 (config-router)#network 154.170.189.0/24 area 0.0.0.0
```

Step 4. Enable MPLS and LDP globally. Set the label protocol LDP on the interface.

```
DGS6600:15 (config)#mpls ip
DGS6600:15 (config)#mpls label protocol ldp
DGS6600:15 (config-if)#interface vlan154
DGS6600:15 (config-if)#mpls ip
DGS6600:15 (config-if)#mpls label protocol ldp
```

Step 5. Set a loopback address and configure the VPLS.

```
DGS6600:15 (config-if)#interface loopback1
DGS6600:15 (config-if)#ip address 12.34.55.32/24
DGS6600:15 (config-if)#interface eth2.1
DGS6600:15 (config-if)#xconnect vpls 3006
DGS6600:15 (config)#vpls 3006
DGS6600:15 (config-vpls)#vpls-id 3006
DGS6600:15 (config-vpls)#peer 11.34.55.31
```

Verifying the Configuration

Use the following command to check the VPLS relative information. This command can be used to check R1 and R3.

```
MPLS-3:15(config)# show vpls detail
VPLS Name: 3006, Operate Status: Up
VPLS ID: 3006, Pseudowire Encap: Tagged, MTU: 0
Peers via Pseudowires:
 VC ID                Peer                Type                Oper Status
-----
 3006                12.34.55.32        Network            Up

Local ACs:
Local AC                Oper Status
-----
eth2.1                Up
```

At the end of the configuration, PC1 (IP: 151.170.189.150/24) should be able to ping PC2 (IP: 151.170.189.152/24).

Configuration Restrictions and Constants

To support VPLS module, the software shall be able to handle MPLS, LDP and Pseudowire protocols. And, the hardware shall to be able to transmit/receive the frames on the Pseudowires and support the MAC bridge function on the VPLS.

VPLS module is based on the work of MPLS and LDP module.

LDP protocol needs to add MAC address withdraw message support.

Constant	Value
Max VPLS entries	1024
Max Peers	2000
Max Peers per VPLS entry	64
Max AC	2000
Max AC per VPLS entry	64



Part 6- Quality of Service (QoS)

The following chapters are included in this volume:

- **Quality of Service (QoS)**

Chapter 36

Quality of Service (QoS)

Chapter Overview

The following topics are included in this chapter, please go to the topic for more detailed information:

- [Chapter Overview](#)
- [An Introduction to QoS](#)
- [Policing and Color Markers](#)
- [QoS Configuration Commands](#)
 - [Defining the Queuing Criteria](#)
 - [Setting the Default Class of Service Value on an Interface](#)
 - [Setting the Bandwidth Limit at Port Level](#)
 - [Creating DSCP Mutation Map](#)
 - [Attaching DSCP Mutation Map to an Interface](#)
- [Scheduling](#)
- [Defining the Policing](#)
 - [Specifying a Policing Rule](#)
 - [Creating a Class-Map to Classify Traffic](#)
 - [Configuring Policing](#)
 - [Configuring Single-rate Policing](#)
 - [Changing Single-rate Policing to Two-rate Policing](#)
 - [Configuring Aggregate Policing](#)
 - [Specifying a Marking Rule](#)
 - [Attach a Policy Map to an Interface](#)
- [Configuration Examples](#)
 - [Configuring QoS Examples](#)
 - [QoS Strict Mode Configuration Example](#)
 - [QoS WRR Mode Configuration Example](#)

An Introduction to QoS

In a network without Quality of Service (QoS) support, all packets have the same priority. Generally in a network where all packets have the same priority, the network will deliver the packet on a best-effort basis. When congestion on the network occurs, all packets have a chance of being dropped causing packet loss.

In a network it is not unusual for different service requirements to be requested for different users. For example, voice traffic requires non-delay delivery. User traffic, such as e-mail, needs to be delivered without being dropped but in most circumstances it is not as time-critical as voice traffic. Some user traffic needs guaranteed service and some does not as guarantee service is more expensive than non-guarantee service.

The purpose of QoS is to make traffic delivery more predictable to meet different user's requirement and make more effective use of the bandwidth. This functionality is achieved by the following major functional components: classification, marking, policing, and congestion avoidance.

To utilize the network bandwidth more efficiently, normally the aggregated guarantee bandwidth needs to be within the available bandwidth, but the aggregate of non-guarantee service can be over-provisioned.

Normally, when user traffic enters the edge node, they will be classified based on the fields of the packet and polices based on the service agreement in terms of Committed Information Rate (CIR), or size of burst. The result of classification or policing will mark the packet with an appropriate QoS label. With this marked QoS label, the internal node can simply trust it and provide the QoS treatment accordingly.

The QoS can be either labeled via IEEE 802.1p priority tag or the DSCP field for IP packets. Since different packets may have different latency requirements, and the traffic from a user normally comes in bursts, the packet will be put in different transmit queues of the egress port. The packet with different QoS labels can have different drop probability during the transmit link's congestion. Thus, the QoS label of a packet will affect how the transmit queue is selected, and how the packet is handled during congestion.

Policing and Color Markers

Policing is the monitoring of the data rates for a particular class of traffic. When the data rate exceeds user-configured values, marking or dropping of packets occurs immediately. When traffic exceeds the data rate, you instruct the system to either drop the packets or mark QoS fields in them.

You can define single-rate, dual-rate, and color-aware policers.

Single-rate policers monitor the committed information rate (CIR) of traffic. Dual-rate policers monitor both CIR and peak information rate (PIR) of traffic. In addition, the system monitors associated burst sizes. IP packet stream are metered and it's packets are marked based on two rates, Peak Information Rate (PIR) and Committed Information Rate (CIR), and their associated burst sizes to be either green, yellow, or red. A packet is marked red if it exceeds the PIR. Otherwise it is marked either yellow or green depending on whether it exceeds or doesn't exceed the CIR.

Color-aware policers assume that traffic has been previously marked with a color. This information is then used in the actions taken by this type of policer.

QoS Configuration Commands

Defining the Queuing Criteria

One of the most important factors when configuring QoS on the Switch is to determine the transmit queue.

The first step in determining the transit queue is to determine the trust state of the interface. The next step is to configure the CoS mapping to a queue. Finally, the DCSP needs to be mapped to CoS.

If the user specifies that a port will be configured to trust the DSCP value, the DSCP of the IP packet will be mapped to the CoS value specified by the **qos map dscp-cos** command. The Switch will map CoS to a queue to determine the scheduling queue as soon as CoS has been determined.

Command	Explanation
qos trust {cos dscp}	Configures the trust state of the interface.
qos map dscp-cos <i>DSCP-LIST</i> to <i>COSVALUE</i>	Defines a differentiated services code point (DSCP) to a class of service (CoS) map.

In the following example the user configures a qos map dscp-cos green.

```
DGS-6600:2>enable
DGS-6600:15#configure terminal
DGS-6600:15(config)#interface eth4.5
DGS-6600:15(config-if)#qos trust cos
DGS-6600:15(config-if)#qos map dscp-cos 1 to 4
DGS-6600:15(config-if)#end
```

Setting the Default Class of Service Value on an Interface

Use the following command to set the default class of service value on an interface:

Command	Explanation
qos cos <i>COS-VALUE</i>	Configures the default class of service (CoS) value for a port.

In the following example, the user configures default COS of eth4.7 is set to 3:

```
DGS-6600:2#enable
DGS-6600:15#configure terminal
DGS-6600:15(config)#interface eth4.7
DGS-6600:15(config-if)#qos cos 3
DGS-6600:15(config-if)#end
```

Setting the Bandwidth Limit at Port Level

Use the following command to set the bandwidth limit for the specified port:

Command	Explanation
qos bandwidth {egress ingress} <i>NUMBERKBPS</i>	Configures the transmitted or received bandwidth limit value on an interface.

In the following example, the user configures the received bandwidth limit value 1024KBps on interface eth4.7

```
DGS:6600:2#enable
DGS-6600:15#configure terminal
DGS-6600:15(config)#interface eth4.7
DGS-6600:15(config-if)#qos bandwidth ingress 1024
DGS-6600:15(config-if)#
```

Creating DSCP Mutation Map

The scheduling of processing packet across multiple queues is a very important part of QoS.

After configuring the DSCP-Mutation on an interface, the ingress DSCP mutation packet will be mutated, after the packet has been received on an interface. Use the following command to configure the DSCP Mutation for the specified port:

Command	Explanation
qos map dscp-mutation <i>MAP-NAME INPUT-DSCP-LIST to OUTPUT-DSCP</i>	Use this command to define a named differentiated service code point (DSCP) mutation map.

This example shows how to map DSCP 30 to mutated DSCP value 8, DSCP 20 to mutated DSCP 10, the mutation map named, mutemap and mutemap1:

```
DGS:6600:2>enable
DGS-6600:15#configure terminal
DGS-6600:15(config)#qos map dscp-mutation mutemap 30 to 8
DGS-6600:15(config)#qos map dscp-mutation mutemap1 20 to 10
DGS-6600:15(config)#end
```

Attaching DSCP Mutation Map to an Interface

The scheduling of processing packet across multiple queues is a very important part of QoS.

After configuring the DSCP-Mutation on an interface, the ingress DSCP mutation packet will be mutated, after the packet has been received on an interface.

Use the following command to configure the DSCP Mutation for the specified port:

Command	Explanation
qos dscp-mutation <i>DSCP-MUTATION-TABLENAME</i>	Configures the DSCP Mutation for the specified port.

In the following example, the user maps DSCP 30 to mutated DSCP value 8 and then attaches the ingress-DSCP mutation map named mutemap1 to Ethernet port 4.1

```
DGS:6600:2>enable
DGS-6600:15#configure terminal
DGS-6600:15(config)#qos map dscp-mutation mutemap1 30 to 8
DGS-6600:15(config)#interface eth4.1
DGS-6600:15(config)#qos dscp-mutation mutemap1
DGS-6600:15(config)#end
```

Scheduling

The scheduling of processing packets across multiple queues is a very important part of QoS.

It is possible to configure the proper weight for each queue, so that different scheduling algorithms can be emulated. The weights should be configured as follows:

Strict Priority: Configure each queue with quantum or weight 0.

- Weight Round Robin: Configure each queue with weight n (n as 0~15).
- Deficit Round Robin: Configures each queue with quantum n (n is project dependant).

The port CoS queue can be either strict priority mode, deficit round robin (DRR) mode or Weight round robin (WRR) mode. The strict priority scheduler mode provides strict priority access to the egress port across the transmit priority queue from the highest priority index to the lowest. The purpose of the strict priority scheduler is to provide lower latency service to the higher CoS classes of traffic.

DRR operates by serving a amount of backlogged credits into the transmit queue in round robin order. Initially, each queue set its credit counter to a configurable quantum value. Every time a packet from a CoS queue is sent, the size of the packet is subtracted from the corresponding credit counter. When the credit counter drops below 0, the queue is no longer serviced until its credits are replenished.

All queues are serviced until their credit counter is zero or negative and a packet is transmitted completely. As this condition happens, the credits are replenished. When the credits are replenished, as quantum of credits are added to each CoS queue credit counter. The quantum for each CoS queue may different based on the user configuration.

To set a CoS in strict priority mode, any higher priority CoS must be in strict priority mode. For example if you would like to set CoS 5 in strict priority mode, CoS 6 and 7 have to be in strict priority mode.

WRR operates by transmitting permitted packets into the transmit queue in round robin order. Initially, each queue set its weight to a configurable weighting. Every time a packet from a higher priority CoS queue is sent, the number of the packet is subtracted from the corresponding weight. When the credit counter reach zero, the queue is no longer serviced until its weight is replenished. After all, the lower priority CoS queue has the service in turn.

All queues are serviced until their weight is zero and a packet is transmitted completely. As this condition happens, the weights are replenished. When the weights are replenished, as weight are added to each CoS queue credit counter. The weight for each CoS queue may different based on the user configuration.

Command	Explanation
<code>qos {deficit-round-robin [COS-QUEUE quantum WEIGHT] weight-round-robin [COS-QUEUE weight WEIGHT]}</code>	Enable the Deficit Round Robin (DRR) / Weighted Round Robin (WRR) packet scheduling mechanism.
<code>default qos</code>	To restore the packet scheduling mechanism, use the default form of this command.

In the following example, the user configures the scheduling mechanism on Ethernet interface 4.7 to use CoS queue 2 and a quantum weight value of 1:

```
DGS:6600:2>enable
DGS-6600:15#configure terminal
DGS-6600:15(config)#int eth4.7
DGS-6600:15(config-if)#qos deficit-round-robin
DGS-6600:15(config-if)#qos deficit-round-robin 2 quantum 1
DGS-6600:15(config-if)#end
```

Defining the Policing

The QoS feature includes a policing function, which is used to determine whether traffic levels meet the level defined in the specified profile or contract. The policing function allows the user to specify the action that should be taken for any traffic that does not match the profile. The available actions that the user can take is to either drop traffic that does not conform to the profile or change the value of the traffic's Differential Services Code Point (DSCP). Since traffic not conforming to defined profiles has the DSCP value lowered or is dropped, transmission is not delayed as there is not need to buffer out-of-profile packets.

Specifying a Policing Rule

The **color-aware** command specifies that the configured policer for the traffic class will operate in color aware mode. In color aware mode, the initial color of the packet and the policer metering result determine the final color. The initial color of the packet is mapped from the incoming DSCP based on the DSCP to color map if the receipt port trusts DSCP. The initial color is mapped from the incoming CoS based on the CoS to color map if the receipt port trusts CoS.

If the configured policer operates in color blind mode, the policer metering result determines the final color.

The default policy-map works with color-blind mode.

Enter the following commands to configure the policy-map work with which mode:

Command	Explanation
color-aware	To define the policy-map works with color-aware mode
no color-aware	To define the policy-map works with color-blind mode.

The following example creates the policy map *pcolor-map1* and configures the policy of doing a color aware for the *class1* class in the policy map.

```
DGS:6600:2>enable
DGS-6600:15#configure terminal
DGS-6600:15(config)#policy-map pcolor-map1
DGS-6600:15(config-pmap)#class class1
DGS-6600:15(config-pmap-c)#color-aware
DGS-6600:15(config-pmap-c)#end
```

Enter the following commands to configure the DSCP-color or CoS-color mapping for traffic initial color when the policy-map works with color-aware mode:

Command	Explanation
<code>qos map dscp-color <i>DSCP-LIST</i> to {green yellow red}</code>	To define the DSCP to color for mapping of packet's initial color.
<code>qos map cos-color <i>COS-LIST</i> to {green yellow red}</code>	To define the CoS to color for mapping of packet's initial color.

The following example defines DSCP61~63 as yellow color, others are green color at eth 3.1.

```
DGS:6600:2>enable
DGS-6600:15#configure terminal
DGS-6600:15(config)#interface eth3.1
DGS-6600:15(config-if)#qos map dscp-color 61-63 to yellow
```

Creating a Class-Map to Classify Traffic

Use the following commands to create a Class-Map to classify different types of traffic:

Command	Explanation
<code>class-map [<i>match-any</i>] <i>NAME</i></code>	Determines how to evaluate the multiple match criteria. Match statements in the class map will be evaluated based on the logical "or" function.
<code>match {<i>access-list ACCESS-LIST-NAME</i> <i>cos COS-LIST</i> [<i>ip</i>] <i>dscp DSCP-LIST</i> [<i>ip</i>] <i>precedence IP-PRECEDENCE-LIST</i> <i>protocol PROTOCOL-NAME</i> <i>vlan VLAN-LIST</i>}</code>	Configures the match criteria for a class map.

In the following example, the user configures a class map called "class1" and specifies the matching LAN to be 2:

```
DGS-6600:2>enable
DGS-6600:15#configure terminal
DGS-6600:15(config)#class-map match-any class1
DGS-6600:15(config-cmap)#match vlan 2
DGS-6600:15(config-cmap)#
```

Configuring Policing

The Switch supports two types of policing, single policing and aggregate policing. The user should implement single policing if they only want to police traffic for a single QoS class. If the user would like to police traffic for multiple QoS classes, the user should implement aggregate policing.

Use the following command to create a policy-map or enter policy-map configuration mode to modify the configuration of a policy map:

Command	Explanation
policy-map <i>NAME</i>	Enters policy-map configuration mode.
class <i>NAME</i>	Specifies the class-map that will be used for the class policy.

In the following example, the user creates a new policy-map called "new-policy" and specifies that the class-map called "dscp-class-col-red" will be used by the policy-map:

```
DGS-6600:2>enable
DGS-6600:15#configure terminal
DGS-6600:15 (config)#policy-map new-policy
DGS-6600:15 (config-pmap)#class dscp-class-col-red
DGS-6600:15 (config-pmap-c)#end
```

Configuring Single-rate Policing

Use the following commands to configure single-rate policing:

In the following example, the user configures a policy-map, police-map1 and have a traffic class, class-movie with a single-rate police:

Command	Explanation
configure terminal	Enters global configuration mode.
policy-map <i>NAME</i>	Enters policy-map configuration mode.
class <i>NAME</i>	Specifies the name of the class map that the traffic policy will be defined for and enters policy-map class configuration mode.
police <i>BPS</i> [<i>BURST-NORMAL</i>] [<i>BURST-MAX</i>] exceed-action <i>ACTION</i> [violate-action <i>ACTION</i>]	Configures traffic policing to use a single rate.
end	Exits policy-map class configuration mode.

```
DGS-6600:2>enable
DGS-6600:15#configure terminal
DGS-6600:15 (config)#policy-map police-map1
DGS-6600:15 (config-pmap)#class class-movie
DGS-6600:15 (config-pmap-c)#police 8000 1000 exceed-action drop
DGS-6600:15 (config-pmap-c)#end
```

Changing Single-rate Policing to Two-rate Policing

Use the following commands to change a single-rate policing configuration to two rate policing:

Command	Explanation
<code>configure terminal</code>	Enters global configuration mode.
<code>policy-map <i>NAME</i></code>	Enters policy-map configuration mode.
<code>class <i>NAME</i></code>	Specifies the name of the class map that the traffic policy will be defined for and enters policy-map class configuration mode.
<code>police cir <i>CIR</i> [bc CONFORM-BURST] pir <i>PIR</i> [be PEAK-BURST] [exceed-action <i>ACTION</i>] [violate-action <i>ACTION</i>]</code>	Configures traffic policing to use two rates
<code>end</code>	Exits policy-map class configuration mode.

In the following example, the user configures a policy-map, police-map1 and have a traffic class, class-movie with a two-rate police:

```
DGS-6600:2#enable
DGS-6600:15#configure terminal
DGS-6600:15(config)#policy-map police-map1
DGS-6600:15(config-pmap)#class class-movie police cir 8000 pir 1000 exceed-action
drop violate-action drop
DGS-6600:15(config-pmap)#end
```

Configuring Aggregate Policing

In a policy-map, multiple traffic classes can be policed by an aggregate policer. However, an aggregate policer can not be referred to by a different policy map. Since the marking or policing rules in a policy-map are defined on the basis of a traffic class, the class-map for each rule needs to be specified. Use the following commands to configure aggregate policing:

Command	Explanation
<code>qos aggregate-policer <i>NAME</i> <i>BPS</i> [<i>BURST-NORMAL</i>] [<i>BURST-MAX</i>] exceed-action <i>ACTION</i> [violate-action <i>ACTION</i>]</code>	Defines a named aggregate policer that will be used in policy maps.
<code>police aggregate <i>NAME</i></code>	Configures a named aggregate policer as the policy that will be used for the traffic classes in a policy map.

In the following example, the user configures a named aggregate policer and applies the policer to multiple classes in a policy map:

```
DGS-6600:15(config)#qos aggregate-policer agg_policer1 10000 1000 exceed-action drop
DGS-6600:15(config)#policy-map policy2
DGS-6600:15(config-pmap)#class class1
DGS-6600:15(config-pmap-c)#police aggregate agg_policer1
DGS-6600:15(config-pmap-c)#exit
DGS-6600:15(config-pmap)#class class2
DGS-6600:15(config-pmap-c)#police aggregate agg_policer1
DGS-6600:15(config-pmap-c)#exit
DGS-6600:15(config-pmap)#class class3
DGS-6600:15(config-pmap-c)#police aggregate agg_policer1
DGS-6600:15(config-pmap-c)#exit
```

Specifying a Marking Rule

A marking rule is used to set new precedence, DSCP, and CoS values in a packet. Use the following commands to create a new marking rule:

Command	Explanation
set {[ip] precedence <i>PRECEDENCE</i> [ip] dscp <i>DSCP</i> cos <i>COS</i> internal-cos <i>COS</i> }	Set precedence of available arriving packets. For non-IP packets, L2 CoS information will be trusted for traffic classification.

The following example sets the IP precedence value to be 1 for the policy-map called HQ and the class called *Sales*:

```
DGS-6600:2>enable
DGS-6600:15#configure terminal
DGS-6600:15(config)#policy-map HQ
DGS-6600:15(config-pmap)#class Sales
DGS-6600:15(config-pmap-c)#set ip precedence 1
DGS-6600:15(config-pmap-c)#end
```

Attach a Policy Map to an Interface

Use the following commands to attach a policy map to an input interface:

Command	Explanation
service-policy <i>NAME</i>	Attaches a service policy to an interface.

In the following example, the user attaches a policy map called "cust1-classes" to eth4.10:

```
DGS-6600:2>enable
DGS-6600:15#configure terminal
DGS-6600:15(config)#interface eth4.10
DGS-6600:15(config-if)#service-policy cust1-classes
DGS-6600:15(config-if)#end
```

Configuration Examples

Configuring QoS Examples

The following example demonstrates how to limit AF11 traffic (Assured Forwarding class 1 and low drop precedence, DSCP=10) at physical interface 6.1. The example sets the limit-rate to 6604 Kbps, the burst size to 1000KB (single rate, two-color policing) and packets that exceed the committed rate to a new DSCP to 14 (high drop precedence).

Step 1-Create a traffic class-map to classify AF11 (DSCP=10). The class-map is named *class-dscpred*:

```
DGS-6600:2>enable
DGS-6600:15#configure terminal
DGS-6600:15(config)#class-map match-any class-dscp-red
DGS-6600:15(config-cmap)#match ip dscp 10
DGS-6600:15(config-cmap)#exit
```

Step 2- Create a traffic policy-map by referring to the previously defined traffic class, *class-dscp-red*, with one or more QoS features, use single-rate two-color policing, a committed rate of 6604 Kbps, and a normal burst size of 1000K Bytes. The exceed action sets packets to use DSCP 14. The policy-map is named *policy1*.

```
DGS-6600:2>enable
DGS-6600:15#configure terminal
DGS-6600:15(config)#policy-map policy1
DGS-6600:15(config-pmap)#class class-dscp-red
DGS-6600:15(config-pmap-c)#police 6604 1000 exceed-action set-dscp-transmit 14
DGS-6600:15(config-pmap-c)#exit
DGS-6600:15(config-pmap)#exit
```

Step 3- Attaches the policy-map, *policy1*, to Ethernet interface 6.1. Since the DSCP of the ingress packet will be used to select the scheduling queue and determine the initial color of the packet, set the mode trust to DSCP.

```
DGS-6600:2>enable
DGS-6600:15#configure terminal
DGS-6600:15(config)#interface eth6.1
DGS-6600:15(config-if-gi)#qos trust dscp
DGS-6600:15(config-if-gi)#service-policy policy1
DGS-6600:15(config-if-gi)#exit
```

Verifying the Configuration

Confirming the Class-Map

```
DGS-6600:15#show class-map
Class Map match-any class-dscp-red
match ip dscp 10
Total Entries: 1
DGS-6600:15#
```

Confirming the Policy-Map

```
DGS-6600:15#show policy-map
Policy Map policy1
Class class-dscp-red
police rate:6604 burst-normal: 1000
exceed-action: set-dscp-transmit 14
DGS-6600:15#
```

Confirming the Association of a Policy-Map for Ethernet Interface 6.1

```
DGS-6600:15#show policy-map interface eth6.1
Policy Map policy1
Class class-dscp-red
police rate:6604 burst-normal: 1000
exceed-action: set-dscp-transmit 14
DGS-6600:15#
```

Confirming the Trust State for Ethernet Interface 6.1

```
DGS-6600:15#show qos interface eth6.1 trust
Interface Trust State
-----
eth6.1 trust DSCP
Total Entries: 1
DGS-6600:15#
```

QoS Strict Mode Configuration Example

Description

The strict priority scheduler mode provides strict priority access to the egress port across the transmit priority queue, from the highest priority index to the lowest priority index. In the following worked example, we will configure the switch so that when traffic congestion occurs, the high priority packet will be forwarded first.

Topology

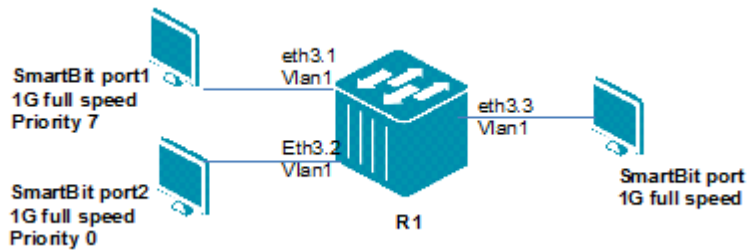

Step 1.

R1. Set eth3.1-3.3 to tag port with vlan 1 and enable COS

```
DGS6600:15(config)#interface range eth3.1-3.3
DGS6600:15(config-if)#trunk allowed-vlan 1
DGS6600:15(config-if)#qos trust cos
```

Step 2.

Enable cos and set WRR weight=0, for this the user needs to use strict mode.

```
DGS6600:15(config)#interface eth3.3
DGS6600:15(config-if)#qos weight-round-robin
DGS6600:15(config-if)#qos weight-round-robin 1 weight 0
DGS6600:15(config-if)#qos weight-round-robin 0 weight 0
DGS6600:15(config-if)#qos weight-round-robin 2 weight 0
DGS6600:15(config-if)#qos weight-round-robin 3 weight 0
DGS6600:15(config-if)#qos weight-round-robin 4 weight 0
DGS6600:15(config-if)#qos weight-round-robin 5 weight 0
DGS6600:15(config-if)#qos weight-round-robin 6 weight 0
DGS6600:15(config-if)#qos weight-round-robin 7 weight 0
```

Verification

Use following commands to check the QOS information.

```
DGS6600:15#show qos interface eth3.3 trust
Interface      Trust State
-----
eth3.3         trust CoS
```

```
DGS6600:15#show qos interface eth3.3 weight-round-robin
eth3.3
  CoS    weight
  =====
  0      strict priority
  1      strict priority
  2      strict priority
  3      strict priority
  4      strict priority
  5      strict priority
  6      strict priority
  7      strict priority
```

QOS WRR Mode Configuration Example

Description

WRR operates by transmitting permitted packets into the transmit queue in round robin order. Initially, each queue sets its weight to a configurable weighting. Every time a packet from a higher priority CoS queue is sent, the number of the packet is subtracted from the corresponding weight. When the credit counter reaches zero, the queue is no longer serviced until its weight is replenished.

The lower priority CoS queue is serviced in turn.

In the following example, when traffic congestion occurs, the packet will be forward by each cos weight.

Topology

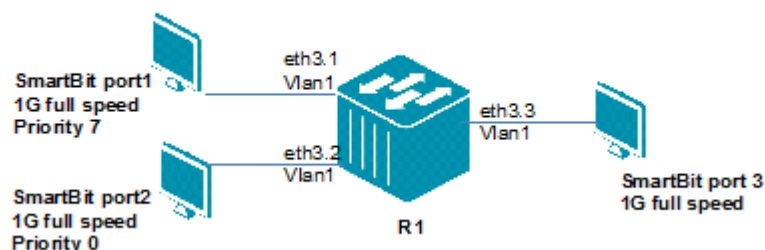

Step 1.

R1. Set eth3.1-3.3 to tag port with vlan 1 and enable COS

```
DGS6600:15(config)#interface range eth3.1-3.3
DGS6600:15(config-if)#trunk allowed-vlan 1
DGS6600:15(config-if)#qos trust cos
```

Step 2.

R1. Set WRR priority 7 with weight 5, others are set as weight 1

```
DGS6600:15(config)#interface range eth3.1-3.3
DGS6600:15(config-if)#qos weight-round-robin
DGS6600:15(config-if)#qos weight-round-robin 0 weight 1
DGS6600:15(config-if)#qos weight-round-robin 1 weight 1
DGS6600:15(config-if)#qos weight-round-robin 2 weight 1
DGS6600:15(config-if)#qos weight-round-robin 3 weight 1
DGS6600:15(config-if)#qos weight-round-robin 4 weight 1
DGS6600:15(config-if)#qos weight-round-robin 5 weight 1
DGS6600:15(config-if)#qos weight-round-robin 6 weight 1
DGS6600:15(config-if)#qos weight-round-robin 7 weight 5
```

Verification

Use the following command to verify the QOS and WRR information

```
DGS6600:15#show qos interface eth3.3 trust
Interface      Trust State
-----
eth3.3         trust CoS

Total Entries: 1
```

```
DGS6600:15#show qos interface eth3.3 weight-round-robin
eth3.3
CoS    weight
=====
0      1
1      1
2      1
3      1
4      1
5      1
6      1
7      5
```



Part 7- Multicast Configurations

The following chapter is included in this volume:

- **Multicast Configuration**

Chapter 37

Multicast Configuration

Chapter Overview

The following topics are included in this chapter, please go to the topic for more detailed information:

- [Chapter Overview](#)
 - [An Introduction to Multicast](#)
- [Multicast Filter Mode Configuration Commands](#)
 - [Multicast Filter mode Introduction](#)
 - [Configuring Multicast Filtering on an Interface](#)
- [PIM](#)
 - [Enabling the ip multicast routing service](#)
 - [Enabling PIM](#)
 - [Creating a static ip multicast route](#)
- [Configuration Examples](#)
 - [PIM-DM configuration Examples](#)
 - [PIM-SM Configuration Example](#)
 - [DVMRP Configuration Example](#)
 - [IGMP Snooping Configuration Example](#)

An Introduction to Multicast

This Chapter deals with **Multicast** commands, the delivery of information to a group destination computers simultaneously in a single transmission from the source; while creating copies automatically in the other elements, like routers, on the network. **Multicast filtering mode** command, to configure the switch to handles unknown multicast packets. **Protocol independent multicast (PIM)** to provide one-to-many and many-to-many distributions of data over a LAN or WAN using routing information supplied by other routing protocols such as BGP. This switch supports **PIM** sparse mode (**PIM-SM**) to build unidirectional shared trees rooted at a rendezvous point (best used for scalable networking) and **PIM** dense mode (**PIM-DM**) to build shortest path trees by flooding multicast traffic domain wide to check where no receivers are present.

Multicast refers to a network technology that forwards packets to more than one receiver through a multicast flow. Only the hosts joining the group can receive the packets from the specific multicast group. Multicast can save network bandwidth greatly as only a single packet is transmitting on any link of the network, no matter how many receivers are deployed. the most common transport layer protocol used in multicast addressing are User Datagram Protocol (UDP) packets with a best effort service. It does not provide as reliable a transmission and error control as TCP. The multicast environment consists of senders and receivers. Sender sends multicast packets with a multicast group address used to distinguish different multicast flows. However, only the members of a group can receive the message destined for this group. Membership in a multicast group is dynamic; hosts can join and leave at any time. There is no restriction on the location or number of members in a multicast group. If necessary, a host can be a member of more than one multicast group at a time. Therefore, the active status of a group and the number of group members vary from time to time. Devices run a multicast routing protocol (such as PIM-DM, PIM-SM, etc.) to maintain their routing tables to forward multicast messages, and use the Internet Group Management Protocol (IGMP) to learn the status of the members within a group on their directly attached subnets. A host can join or leave

an IGMP group by sending corresponding IGMP Report messages.

Multicast Filter Mode Configuration Commands

Multicast Filter mode Introduction

User could decide the unknown multicast packets forwarding rules by configuring the multicast filter mode. The multicast filter mode function is per vlan based in this device. Please see below for its detail description.

Forward All Groups – All frames destined for group MAC addresses are forwarded according to the VLAN rules.

Forward Unregistered Groups – If the Group MAC address registration entries exist in the Multicast Table, frames destined for that corresponding Group MAC addresses are forwarded, only on ports identified in the member port set. In other words, if the Group MAC Address doesn't exist, the packet will be forwarded according to the VLAN rules.

Filter Unregistered Groups – Frames destined for group MAC address are forwarded only if such forwarding is explicitly permitted by a Group Address entry in the Multicast table. In other words, if the Group MAC Address doesn't exist, the packet will be filtered.

Configuring Multicast Filtering on an Interface

The user can configure the method that the Switch uses for handling unknown multicast packets received on a VLAN interface. Use the following commands to configure and display the handling method used for the unknown multicast packets received on an interface:

Command	Explanation
<code>multicast filtering-mode {forward-all forward-unregistered filter-unregistered}</code>	Configures the handling method used for any unknown multicast packets received on an interface.
<code>show multicast filtering-mode [interface INTERFACE-ID]</code>	Displays the handling method used for any unknown multicast packets received on an interface.

In the following example, the user configures interface VLAN2 to filter-unregistered multicast packets based on the forwarding table and flood drop all unregistered multicast packets. Finally, the user displays the multicast filtering mode for all VLANs:

```

DGS-6600:2>enable
DGS-6600:15#configure terminal
DGS-6600:15(config)#interface vlan2
DGS-6600:15(config-if)#multicast filtering-mode filter-unregistered
DGS-6600:15(config-if)#end
DGS-6600:15#show multicast filtering-mode
Interface          Multicast Filtering Mode
-----
VLAN1              forward-unregistered
VLAN2              filter-unregistered
VLAN3              forward-unregistered
VLAN4              forward-unregistered
VLAN5              forward-unregistered
VLAN6              forward-unregistered
VLAN99             forward-unregistered
VLAN100            forward-unregistered
VLAN121            forward-unregistered
Total Entries: 9
DGS-6600:15#

```

PIM

The device supports PIM sparse-mode and PIM dense-mode. The implementation refers to the following standards:

RFC3973 - Protocol Independent Multicast - Dense Mode (PIM-DM)

RFC4601 - Protocol Independent Multicast - Sparse Mode (PIM-SM)

RFC5059 - Bootstrap Router (BSR) Mechanism for Protocol Independent Multicast (PIM)

Enabling the ip multicast routing service

Use the following command in global configuration mode to globally enable ip multicast routing.

Command	Explanation
<code>ip multicast-routing</code>	Use this command to enable multicast routing. The no form of this command can disable IP multicast routing.

Please note this command must be enabled to use any of the multicast commands.

Example

This example shows how to enable IP multicast routing.

```
DGS-6600(config)# ip multicast-routing
```

Enabling PIM

To enable PIM on the interface for either sparse mode or dense mode operation use the following commands.

Command	Explanation
<code>ip pim sparse-mode</code>	Use this command to specify the PIM operating mode for an interface, operated in sparse mode.
<code>ip pim dense-mode</code>	Use this command to specify the PIM operating mode for an interface, operated in dense mode.
<code>no ip pim sparse-mode</code>	Use this command to disable the PIM sparse operating mode for an interface.
<code>no ip pim dense-mode</code>	Use this command to disable the PIM dense operating mode for an interface.

This command is only valid for the VLAN interface. Using this command to specify the PIM operating mode for an interface in either a sparse or dense mode.

To switch the PIM operating mode use `no ip pim {sparse-mode | dense-mode}` to disable PIM at first then set the new mode required. The PIM needs to be disabled first since only one multicast routing protocol can be enabled on one interface. When the command `ip pim dense-mode` is issued, PIM dense mode will be configured on the interface. Therefore when the command `ip pim sparse-mode` is issued, attempting to execute sparse mode on the interface, the system will reply with an error message because PIM dense mode is already configured on that interface. Enabling PIM on an interface also enables Internet Group Management Protocol (IGMP) operation on that interface.

Creating a static ip multicast route

The `ip mroute` command statically configures where multicast sources are located even when the unicast routing table shows something different.

The commands can be used as

```
ip mroute SOURCE-NETWORK {RPF-ADDRESS | Null} [DISTANCE]
```

```
no ip mroute SOURCE-NETWORK
```

Syntax	Description	Explanation
<i>SOURCE-NETWORK</i>		Network address of the multicast source. Format: A.B.C.D/M.
<i>RPF-ADDRESS</i>		RPF neighbor address for the multicast route.
Null		Indicates Null interface. When set to Null, the RPF check result will always be failed.
<i>DISTANCE</i>		(Optional) Specifies whether a unicast route or multicast static route is used for the RPF lookup. Lower distances have preference. If the multicast static route has the same distance as the other RPF sources, the multicast static route takes preference. Default is 0. Range is 0-255.

Examples

The following example configures the multicast data source within network 192.168.6.0/24 to be accessible with the neighbor router 10.1.1.1.

```
DGS-6600(config)#ip mroute 192.168.6.0/24 10.1.1.1
```

The following example configures the multicast data source within network 192.168.7.0/24 to be accessible with the neighbor router 10.1.1.1 and with the distance value of 100.

```
DGS-6600(config)#ip mroute 192.168.7.0/24 10.1.1.1 100
```

The following example configures the multicast data source within a network number 192.168.8.0/24 to be discarded.

```
DGS-6600(config)#ip mroute 192.168.8.0/24 null
```

The following example removes a previously configured ip mroute entry of 192.168.8.0/24.

```
DGS-6600(config)#ip mroute 192.168.8.0.24
```

Configuration Examples

PIM-DM configuration Examples

R1 and R2 run PIM-DM multicast routing protocol. IPTV multicast stream can be routed from R1 to R2, and forwarded to VLAN when PC joins.

Topology

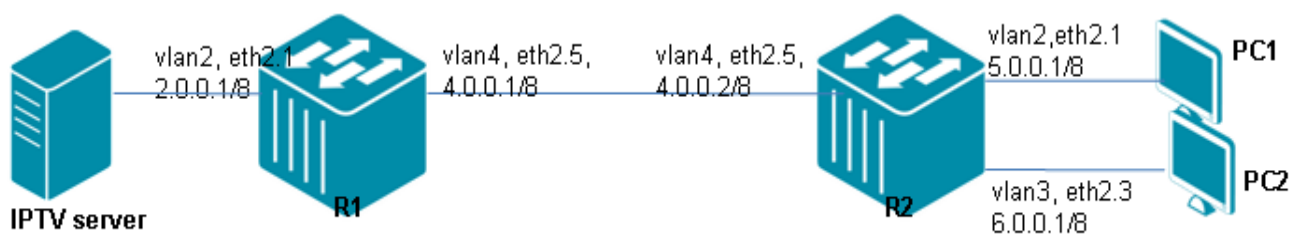

Figure 37-1 PIM-DM Configuration Example Topology

R1 (Router 1) Configuration Steps

Step 1: enable multicast routing

```
DGS-6600:15 (config)#ip multicast-routing
```

Step 2: create vlan 2,4

```
DGS-6600:15 (config)#vlan 2
DGS-6600:15 (config-vlan)#vlan 4
```

Step 3: add port into vlan

```
DGS-6600:15(config-vlan)#interface eth2.1
DGS-6600:15(config-if)# access vlan 2
DGS-6600:15(config-if)#interface eth2.5
DGS-6600:15(config-if)# access vlan 4
```

Step 4: configure IP address of VLAN and enable pim-dm

```
DGS-6600:15(config-if)#interface vlan2
DGS-6600:15(config-if)#ip address 2.0.0.1/8
DGS-6600:15(config-if)#ip pim dense-mode
DGS-6600:15(config-if)#interface vlan4
DGS-6600:15(config-if)#ip address 4.0.0.1/8
DGS-6600:15(config-if)#ip pim dense-mode
```

Step 5: enable and set rip

```
DGS-6600:15(config)#router rip
DGS-6600:15(config-router)#network 2.0.0.1/8
DGS-6600:15(config-router)#network 4.0.0.1/8
```

R2 (Router 2) Configuration Steps**Step 1: enable multicast routing**

```
DGS-6600:15(config)#ip multicast-routing
```

Step 2: create vlan 2,3,4

```
DGS-6600:15(config)#vlan 2
DGS-6600:15(config-vlan)#vlan 3
DGS-6600:15(config-vlan)#vlan 4
```

Step 3: add port into vlan

```
DGS-6600:15(config-vlan)#interface eth2.1
DGS-6600:15(config-if)# access vlan 2
DGS-6600:15(config-if)#interface eth2.3
DGS-6600:15(config-if)# access vlan 3
DGS-6600:15(config-if)#interface eth2.5
DGS-6600:15(config-if)# access vlan 4
```

Step 4: configure IP address of VLAN and enable pim-dm

```
DGS-6600:15(config-if)#interface vlan2
DGS-6600:15(config-if)#ip address 5.0.0.1/8
DGS-6600:15(config-if)#ip pim dense-mode
DGS-6600:15(config-if)#interface vlan3
DGS-6600:15(config-if)#ip address 6.0.0.1/8
DGS-6600:15(config-if)#ip pim dense-mode
DGS-6600:15(config-if)#interface vlan4
DGS-6600:15(config-if)#ip address 4.0.0.2/8
DGS-6600:15(config-if)#ip pim dense-mode
```

Step 5: enable and set rip

```
DGS-6600:15(config)#router rip
DGS-6600:15(config-router)#network 5.0.0.1/8
DGS-6600:15(config-router)#network 6.0.0.1/8
DGS-6600:15(config-router)#network 4.0.0.2/8
```

Verifying The Configuration

Check R1 and R2 PIM-DM config using show ip pim interface command.

```
DGS-6600:15#show ip pim interface
Address          Interface  Mode   Neighbor  DR      DR      Generation
Count           Priority  Count
-----
2.0.0.1         vlan2     Dense  0         0       0.0.0.0  747610331
4.0.0.1         vlan4     Dense  1         0       0.0.0.0  1393976666
DGS-6600:15#show ip igmp interface vlan4

vlan4
  IP Address/Netmask      : 4.0.0.1/8
  IGMP State              : Enabled
  Access Group            : (None)
  Version                 : 3
  Query Interval          : 125 seconds
  Query Maximum Response Time : 10 seconds
  Robustness Value        : 2
  Last Member Query Interval : 1000 milliseconds
  Querier                 : 4.0.0.1
  Querier Timer countdown value : -
  Configured Query Interval : 125
  Configured Maximum response time : 10
  Configured Robustness   : 2
```

PIM-SM Configuration Example

R1 and R2 run PIM-SM multicast routing protocol. IPTV multicast stream can be routed from R1 to R2, and forwarded to VLAN when PC joins.

Topology

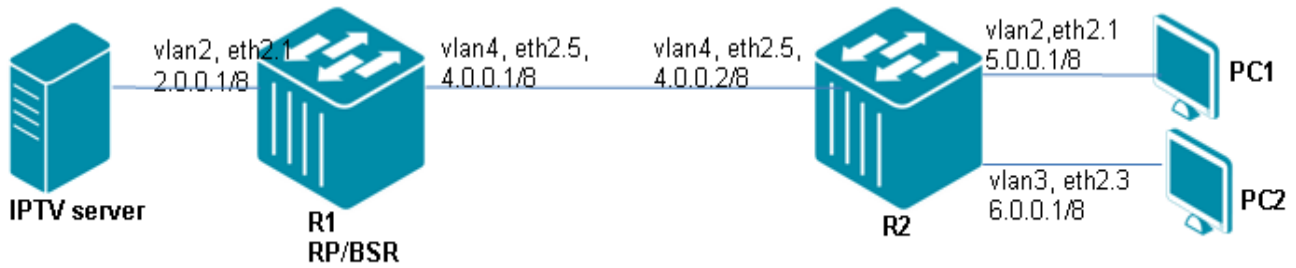

Figure 37-2 PIM-SM Configuration Example

R1 (Router 1) Configuration Guide

Step 1: enable multicast routing

```
DGS-6600:15(config)#ip multicast-routing
```

Step 2: create vlan 2,4

```
DGS-6600:15(config)#vlan 2
DGS-6600:15(config-vlan)#vlan 4
```

Step 3: set R1 is RP and BSR

```
DGS-6600:15(config)#ip pim bsr-candidate vlan4
DGS-6600:15(config)#ip pim rp-candidate vlan4
```

Step 4: add port into vlan

```
DGS-6600:15(config)#interface eth2.1
DGS-6600:15(config-if)# access vlan 2
DGS-6600:15(config-if)#interface eth2.5
DGS-6600:15(config-if)# access vlan 4
```

Step 5: configure IP address of VLAN and enable pim-sm

```
DGS-6600:15(config-if)#interface vlan2
DGS-6600:15(config-if)#ip address 2.0.0.1/8
DGS-6600:15(config-if)#ip pim sparse-mode
DGS-6600:15(config-if)#interface vlan4
DGS-6600:15(config-if)#ip address 4.0.0.1/8
DGS-6600:15(config-if)#ip pim sparse-mode
```

Step 6: enable and set rip

```
DGS-6600:15(config)#router rip
DGS-6600:15(config-router)#network 2.0.0.1/8
DGS-6600:15(config-router)#network 4.0.0.1/8
```

R2 (Router 2) Configuration Steps**Step 1: enable multicast routing**

```
DGS-6600:15(config)#ip multicast-routing
```

Step 2: create vlan 2,3,4

```
DGS-6600:15(config)#vlan 2
DGS-6600:15(config-vlan)#vlan 3
DGS-6600:15(config-vlan)#vlan 4
```

Step 3: add port into vlan

```
DGS-6600:15(config)#interface eth2.1
DGS-6600:15(config-if)# access vlan 2
DGS-6600:15(config-if)#interface eth2.3
DGS-6600:15(config-if)# access vlan 3
DGS-6600:15(config-if)#interface eth2.5
DGS-6600:15(config-if)# access vlan 4
```

Step 4: configure IP address of VLAN and enable pim-sm

```
DGS-6600:15(config-if)#interface vlan2
DGS-6600:15(config-if)#ip address 5.0.0.1/8
DGS-6600:15(config-if)#ip pim sparse-mode
DGS-6600:15(config-if)#interface vlan3
DGS-6600:15(config-if)#ip address 6.0.0.1/8
DGS-6600:15(config-if)#ip pim sparse-mode
DGS-6600:15(config-if)#interface vlan4
DGS-6600:15(config-if)#ip address 4.0.0.2/8
DGS-6600:15(config-if)#ip pim sparse-mode
```

Step 5: enable and set rip

```
DGS-6600:15(config)#router rip
DGS-6600:15(config-router)#network 5.0.0.1/8
DGS-6600:15(config-router)#network 6.0.0.1/8
DGS-6600:15(config-router)#network 4.0.0.2/8
```

Verifying The Configuration

Check R1 and R2 PIM-SM configured by using the command show ip pim interface.

```
DGS-6600:15#show ip pim interface
Address          Interface      Mode   Neighbor  DR      DR      Generation
                |             |      |         |      |      |          |
                |             |      |         |      |      |          |
ID              |             |      |         |      |      |          |
-----|-----|-----|-----|-----|-----|-----|-----|
2.0.0.1        | vlan2      | Sparse | 0       | 1     | 2.0.0.1 | 616674348
4.0.0.1        | vlan4      | Sparse | 1       | 1     | 4.0.0.2 | 691905135

Total Entries: 2

DGS-6600:15#show ip pim
PIM Configurations:
Register Checksum Include Data: Disabled, group-list: (None)
Register Suppression Time      : 60 seconds
Accept Register Group List     : (None)

RP Address
  (None)

RP Candidate
  vlan4, group-list: (None), interval: 60, priority: 192

BSR Candidate
  vlan4, hash-mask-length:30, priority: 64

DGS-6600:15#show ip pim rp mapping
PIM Group-to-RP Mappings
This system is the Bootstrap Router (v2)
Group(s): 224.0.0.0/4
  RP: 4.0.0.1
  Info source: 4.0.0.1, via bootstrap, priority 192
  Uptime: 0DT0H3M28S, expires: 0DT0H2M7S

DGS-6600:15#show ip pim bsr
PIMv2 Bootstrap information
This system is the Bootstrap Router (BSR)
BSR address: 4.0.0.1
Uptime:      0DT0H3M45S, BSR Priority: 64, Hash mask length: 30
Next bootstrap message in 0DT0H0M26S

Candidate RP: 4.0.0.1(vlan4)
Next C-RP advertisement in 0DT0H0M21S
```

DVMRP Configuration Example

R1 and R2 run DVMRP multicast routing protocol. IPTV multicast stream can be routed from R1 to R2, and forwarded to VLAN when PC joins.

Topology

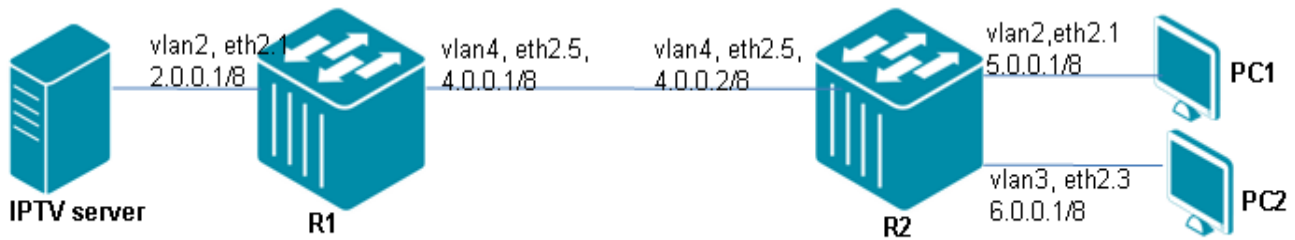

Figure 37-3 DVMRP Configuration Example Topology

R1 (Router 1) Configuration Steps

Step 1: enable multicast routing

```
DGS-6600:15(config)#ip multicast-routing
```

Step 2: create vlan 2, 4

```
DGS-6600:15(config)#vlan 2
DGS-6600:15(config-vlan)#vlan 4
```

Step 3: add port into vlan

```
DGS-6600:15(config-vlan)#interface eth2.1
DGS-6600:15(config-if)# access vlan 2
DGS-6600:15(config-if)#interface eth2.5
DGS-6600:15(config-if)# access vlan 4
```

Step 4: configure IP address of VLAN and enable dvmrp

```
DGS-6600:15(config-if)#interface vlan2
DGS-6600:15(config-if)#ip address 2.0.0.1/8
DGS-6600:15(config-if)#ip dvmrp
DGS-6600:15(config-if)#interface vlan4
DGS-6600:15(config-if)#ip address 4.0.0.1/8
DGS-6600:15(config-if)#ip dvmrp
```

Step 5: enable and set rip

```
DGS-6600:15(config)#router rip
DGS-6600:15(config-router)#network 2.0.0.1/8
DGS-6600:15(config-router)#network 4.0.0.1/8
```

R2 (Router 2) Configuration Steps

Step 1: enable multicast routing

```
DGS-6600:15(config)#ip multicast-routing
```

Step 2: create vlan 2,3,4

```
DGS-6600:15(config)#vlan 2  
DGS-6600:15(config-vlan)#vlan 3  
DGS-6600:15(config-vlan)#vlan 4
```

Step 3: add port into vlan

```
DGS-6600:15(config-vlan)#interface eth2.1  
DGS-6600:15(config-if)# access vlan 2  
DGS-6600:15(config-if)#interface eth2.3  
DGS-6600:15(config-if)# access vlan 3  
DGS-6600:15(config-if)#interface eth2.5  
DGS-6600:15(config-if)# access vlan 4
```

Step 4: configure IP address of VLAN and enable dvmrp

```
DGS-6600:15(config-if)#interface vlan2  
DGS-6600:15(config-if)#ip address 5.0.0.1/8  
DGS-6600:15(config-if)#ip dvmrp  
DGS-6600:15(config-if)#interface vlan3  
DGS-6600:15(config-if)#ip address 6.0.0.1/8  
DGS-6600:15(config-if)#ip dvmrp  
DGS-6600:15(config-if)#interface vlan4  
DGS-6600:15(config-if)#ip address 4.0.0.2/8  
DGS-6600:15(config-if)#ip dvmrp
```

Step 5: enable and set rip

```
DGS-6600:15(config)#router rip  
DGS-6600:15(config-router)#network 5.0.0.1/8  
DGS-6600:15(config-router)#network 6.0.0.1/8  
DGS-6600:15(config-router)#network 4.0.0.2/8
```

Verifying The Configuration

Check R1 DVMRP config using the example below

```
DGS-6600:15#show ip dvmrp interface
Interface  Address           Metric  Generation ID
-----  -
vlan2     2.0.0.1          1      736149015
vlan4     4.0.0.1          1      736149015

Total Entries: 2

DGS-6600:15#show ip dvmrp neighbor
Interface      Neighbor Address  Generation ID  ExpTime
-----
vlan4          4.0.0.2          1331887776    0DT0H0M32S

Total Entries: 1

DGS-6600:15#show ip dvmrp route
State: H = Hold-down
Source Network  Upstream Neighbor  Metric  Learned  Interface  State  ExpTime
-----
2.0.0.0/8      2.0.0.1          1      Local    vlan2     -
4.0.0.0/8      4.0.0.1          1      Local    vlan4     -
5.0.0.0/8      4.0.0.2          2      Dynamic  vlan4     0DT0H1M47S
6.0.0.0/8      4.0.0.2          2      Dynamic  vlan4     0DT0H1M47S
```

IGMP Snooping Configuration Example

When PC2 join group 239.255.0.1, then traffic goes down to PC2.

Topology

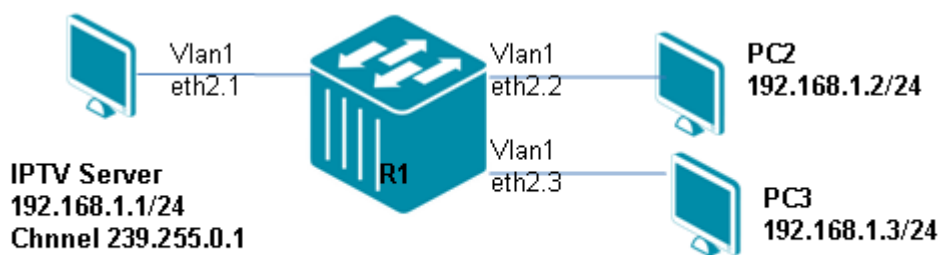

Figure 37-4 IGMP Snooping Configuration Example Topology

R1 (Router 1) Configuration Steps

Step 1:

```
DGS-6600:15(config)#interface vlan1
DGS-6600:15(config-if)# ip igmp snooping
```

Verifying The Configuration

Step 1: Check IGMP snooping configuration and group:

```
DGS-6600:15#show ip igmp snooping
```

```
IGMP Snooping is enabled in the following VLANs
```

```
Codes- v3:IGMP v3 host compatibility mode, v2: IGMP v2 host compatibility mode
       v1:IGMP v1 host compatibility mode
```

Vlan	Querier State	Querier Router	Immediate Leave	Timer State
(v3)1	Disabled	-	Disabled	-

Total Number of VLANs = 1

```
DGS-6600:15#show ip igmp snooping group
```

```
IGMP Snooping Connected Group Membership: ((s)-static configuration)
```

Group address	Source address	Interface	Port
239.255.0.1	*	vlan1	eth2.2

```
Total Entries: 1 entries, 1 records
```

```
DGS-6600:15#show ip igmp snooping group detail
```

```
IGMP version      : V3
Interface         : vlan1
Group             : 239.255.0.1
Port              : eth2.2
Uptime           : 0DT0H1M40S
Expires           : 0DT0H2M41S , dynamic
Group mode        : Exclude
Last reporter:    : 192.168.1.2
Source list is empty
```

```
Total Entries : 1 entries, 1 records
```



Part 8- Security & Authentication

The following chapters are included in this volume:

- **Access Control Lists (ACL)**
- **Authentication, Authorization and Accounting (AAA) Configuration**
- **802.1X Authentication**
- **DoS Protection**
- **Dynamic ARP Inspection**
- **Port Security**
- **IP Source Guard**
- **DHCP Server Screening**
- **DHCP Snooping Configuration**
- **Safeguard Engine Settings**
- **Traffic Segmentation Configuration**

Chapter 38

Access Control Lists (ACL)

Chapter Overview

The following topics are included in this chapter, please go to the topic for more detailed information:

- [Chapter Overview](#)
- [An Introduction to Access Control Lists](#)
- [Configuration Overview](#)
- [ACL Configuration Commands](#)
 - [Configuring a Time Range Profile](#)
 - [Configuring Access Control Lists](#)
 - [Configuring IP Basic Access Control Lists](#)
 - [Configuring IP Extended Access Control Lists](#)
 - [Configuring IPv6 Extended Access Control Lists](#)
 - [Configuring MAC Extended Access Control Lists](#)
 - [Re-sequencing the Criteria Statements in Access Control Lists](#)
 - [Displaying Access Control Lists](#)
 - [Applying Access Control Lists to Interfaces](#)
- [Configuration Examples](#)
 - [ACL Configuration Example](#)
- [List of Constants and Default Settings](#)

An Introduction to Access Control Lists

An Access Control List (ACL) provides security by controlling the filtering and forwarding of packets. When an access control list is setup, the device will examine the contents of the packet to determine whether to drop or forward the packet based on the specified criteria within the access list. The criteria can be the source or destination address of the packet, the type of protocol, etc. The checking of access control lists is performed by the filter processor of the Switch controller.

An access control list can be used in many places. For example, an access control list can be applied to a routing protocol to control route updates. An access control list can also be used to control the traffic flow to provide the security guard for the network. When no access control lists are configured, all packets passing through the Switch can be forwarded to all parts of the network. Configuring access control lists allows the user to determine which hosts can access the network and which hosts cannot access the network.

There are three types of access control lists, MAC access control lists, IP access control lists and IPv6 access control lists. MAC access control lists define the criteria based on the MAC layer fields in a packet. IP access control lists are further divided into IP basic access control lists and IP extended access control lists. IP basic access control lists define the criteria based on the source and destination IP address. IP extended access control lists allow the user to define the criteria based on additional fields such as the TCP port number, UDP port number, or IP layer header field, including the upper layer protocol type. IPv6 access control lists define the criteria based on the IPv6 packet fields.

The user can apply access control lists to physical port interfaces to act as ingress check lists. A packet ingressing to a switch port will be checked and matched against the ingress access control list to determine whether to drop or permit the packet.

For each individual port, up to one MAC access control list, one IP access control list and one IPv6 access control list can be applied. Be aware that any ingress packet that matches ACL criteria will follow the ACL statement, including control packets such as BPDU, IGMP, etc. Before using an ACL to filter out traffic, the user has to make sure whether the ACL will also filter out all of the traffic, which may be BPDU, IGMP, etc., control packets.

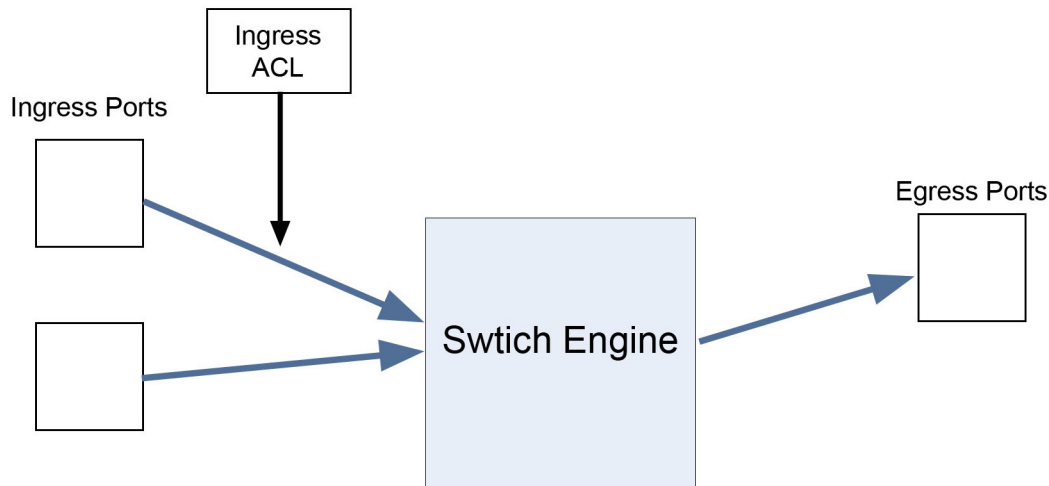

Figure 38-1 Access Control List Operation

MAC, IP and IPv6 access control lists can be applied to physical ports for traffic filtering. IP basic access control lists can also be applied to upper layer protocol modules such as PIM or route map to control the update of routes

Configuration Overview

The following section provides an overview for configuring an access control list.

1) Create a Time Range

This step is optional and allows the user to define a time range control that can be associated with an ACL entry. If a time range control does not need to be defined for the ACL entry, the user can skip this step and configure an access control list following the steps outlined below. The settings that are configured in the ACLs will take effect as soon as the Switch is powered up and will be retained until the user removes the ACL entry.

2) Setup Criteria for Access Control Lists

Multiple criteria can be defined by the user, as either a permit or deny statement.

• The Implied “Deny All Traffic” Criteria Statement

At the end of every access list is an implied “deny all traffic” criteria statement. Therefore, if a packet does not match any of the defined criteria statements, the packet will be dropped.

- **The Order in Evaluating Criteria Statements**

When an access list with multiple criteria statements is applied to a port, the device will test each packet against each criteria statement in the order that the criteria statements are located. After a criteria statement is matched, an action is taken based on the matched statement and no more criteria statements are checked. That is, prior criteria statements get a higher precedence for being checked.

The ordering of a statement can be explicitly defined or automatically assigned. To manually control the ordering, the user can define the statement with a priority number. A smaller priority number means a higher precedence. If the user does not specify the priority number when entering a criteria statement, a priority number will be automatically assigned.

- **Associating a Time Range with a Criteria Statement**

The user can also associate a criteria statement with a time range profile. If a criteria statement is associated with a time range profile, the statement will only be checked for the periods defined by the profile. If a time range is not specified, the criteria statement will be checked without any time constraints.

3) Applying Access Control Lists to Interfaces

The user can apply up to one MAC access control list, one IP access control list and one IPv6 access control list to an interface. If both a MAC access control list and an IP access control list are applied, the device will check the MAC access control list for the packet first. If the packet matches the criteria statement in the MAC access control list and is permitted, the device will proceed and check if the packet matches an IP ACL entry if the packet is an IPv4 packet or a IPv6 ACL entry if the packet is an IPv6 packet. If a deny statement is matched, the packet is dropped without any further ACL checking.

The following diagram shows an example of how to attach an ingress ACL to an interface:

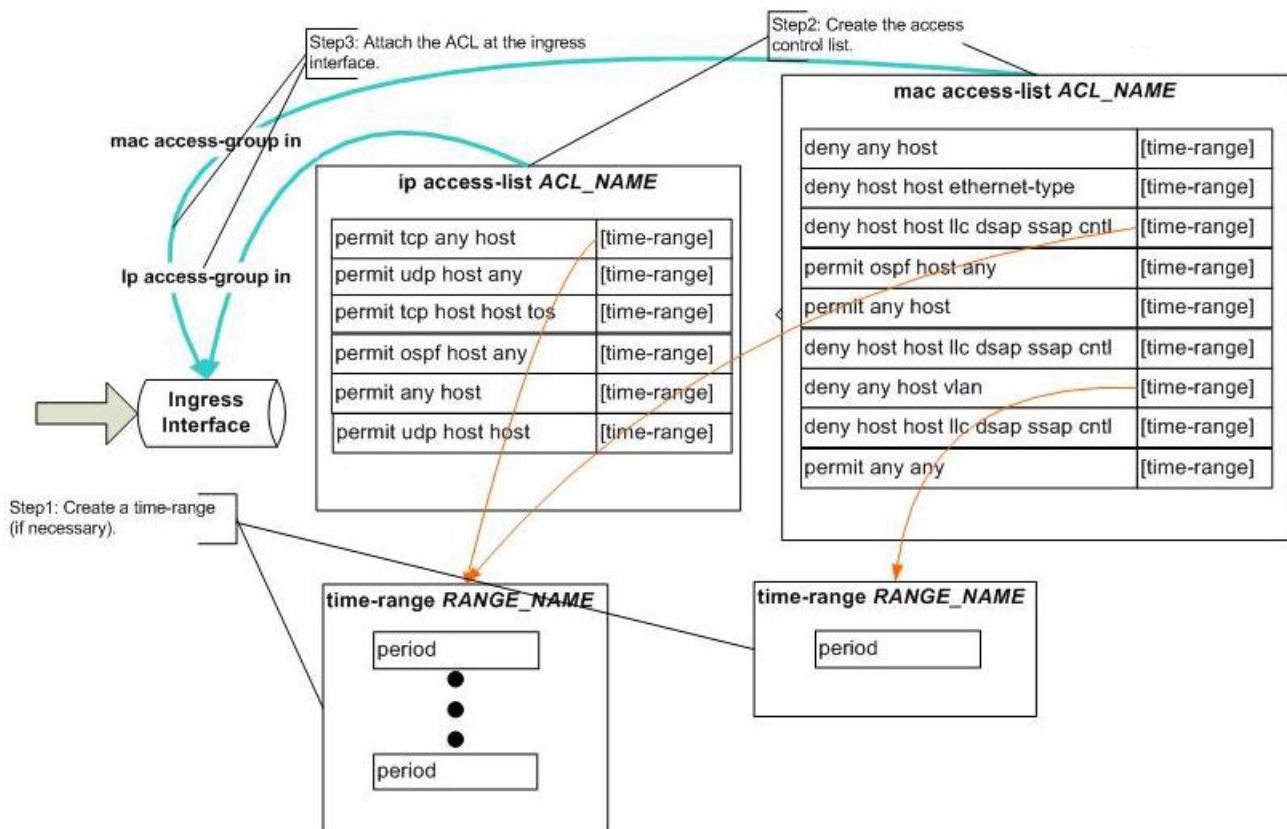

Figure 38-2 Attaching an Ingress ACL to an Interface

ACL Configuration Commands

Configuring a Time Range Profile

In a time range profile, the user can define multiple periods. The defined time-range profile can be associated with an access control list criteria statement to provide time-based access control.

To configure a new time-range profile and verify existing time-range profile settings, access global configuration mode and enter the following commands:

Command	Explanation
<code>time-range NAME</code>	Enters time-range configuration mode.
<code>periodic {daily HH:MM to HH:MM monthly DATE HH:MM to [DATE] HH:MM weekly WEEKLY-DAY HH:MM to [WEEKLY-DAY] HH:MM}</code>	Specifies the periods covered by the time-range profile.
<code>end</code>	Exits time-range configuration mode.
<code>show time-range [NAME]</code>	Displays the configured time-range profiles.

In the following example, the user creates a time-range profile called “lunch-time”, that is active between 12:00 and 13:00 everyday, and verifies the settings:

```
DGS-6600:2>enable
DGS-6600:15#configure terminal
DGS-6600:15 (config)#time-range lunch-time
DGS-6600:15 (config-time-range)#periodic daily 12:00 to 13:00
DGS-6600:15 (config-time-range)#end
DGS-6600:15#show time-range lunch-time
time range name : lunch-time
12:00 ~ 13:00, every day
DGS-6600:15#
```

Configuring Access Control Lists

There are three types of access control lists, MAC access control lists, IP access control lists and IPv6 access control lists. IP access control lists are further divided into IP basic access control lists and IP extended access control lists.

The following topics are included in this section:

- [Configuring IP Basic Access Control Lists](#)
- [Configuring IP Extended Access Control Lists](#)
- [Configuring IPv6 Extended Access Control Lists](#)
- [Configuring MAC Extended Access Control Lists](#)
- [Re-sequencing the Criteria Statements in Access Control Lists](#)
- [Displaying Access Control Lists](#)
- [Applying Access Control Lists to Interfaces](#)

Configuring IP Basic Access Control Lists

The user can define permit/deny statements for IP basic access control lists based on the source IP address or destination IP address.

Use the following commands to define permit/deny access control statements:

Command	Explanation
<code>ip access-list <i>NAME</i></code>	Creates or modifies an IP basic access control list.
<code>{permit deny} {any host <i>SRC-IP-ADDR</i> <i>SRC-IP-ADDR MASK</i>} {any host <i>DST-IP-ADDR</i> <i>DST-IP-ADDR MASK</i>} [<i>time-range PROFILE-NAME</i>] [<i>priority PRIORITY</i>]</code>	Permits or denies traffic based on the specified source/destination IP address.

The ordering of statements can be explicitly defined or automatically assigned. If the user defines the statement with a priority number, the ordering is manually determined. A smaller priority number means a higher precedence. If the user does not specify a priority number when entering a criteria statement, a priority number will be automatically assigned.

In the following example, the user creates an access control list called “IT-Management” that allows IP host 192.168.50.222 to access the Switch, which has an IP address of 192.168.50.1, and disallows all other hosts from making a connection to the Switch. The user then applies the ACL to Ethernet interface 4.5, which is connected to the IP host that has an IP address of 192.168.50.222:

```
DGS-6600:2>enable
DGS-6600:15#configure terminal
DGS-6600:15(config)#ip access-list IT-Management
The maximum available of IP access-list is 255
DGS-6600:15(config-ip-acl)#permit 192.168.50.222 255.255.255.255 host 192.168.50.1
DGS-6600:15(config-ip-acl)#deny any host 192.168.50.1
DGS-6600:15(config-ip-acl)#end
DGS-6600:15#configure terminal
DGS-6600:15(config)#interface eth4.5
DGS-6600:15(config-if)#ip access-group IT-Management
The maximum available entry of IP ACL bind to interface in ingress direction is:
1278
The maximum available port operator (gt/lt) is:
16
DGS-6600:15(config-if)#end
```

Configuring IP Extended Access Control Lists

For IP extended access control lists, the user can define the permit/deny statement based on IP address, layer 4 port ID, and classification of service information. The user can also enter the statement with a time-range profile.

Use the following commands to create or modify an IP extended access control list:

Command	Explanation
<code>ip access-list extended <i>NAME</i></code>	Creates or modifies an IP extended access control list.
<code>{permit deny} tcp {any host <i>SRC-IP-ADDR</i> <i>SRC-IP-ADDR</i> <i>MASK</i>} [<i>OPERATOR</i> <i>PORT</i>] {any host <i>DST-IP-ADDR</i> <i>DST-IP-ADDR</i> <i>MASK</i>} [<i>OPERATOR</i> <i>PORT</i>] [<i>precedence</i> <i>PRECEDENCE</i> <i>tos</i> <i>TOS</i> <i>dscp</i> <i>DSCP</i>] [<i>time-range</i> <i>PROFILE-NAME</i>] [<i>priority</i> <i>PRIORITY</i>]</code>	Permits or denies TCP packets based on the specified source/destination IP address, TCP port, or IP header traffic class information.
<code>{permit deny} udp {any host <i>SRC-IP-ADDR</i> <i>SRC-IP-ADDR</i> <i>MASK</i>} [<i>OPERATOR</i> <i>PORT</i>] {any host <i>DST-IP-ADDR</i> <i>DST-IP-ADDR</i> <i>MASK</i>} [<i>OPERATOR</i> <i>PORT</i>] [<i>precedence</i> <i>PRECEDENCE</i> <i>tos</i> <i>TOS</i> <i>dscp</i> <i>DSCP</i>] [<i>time-range</i> <i>PROFILE-NAME</i>] [<i>priority</i> <i>PRIORITY</i>]</code>	Permits or denies UDP packets based on the specified source/destination IP address, UDP port, or IP header traffic class information.
<code>{permit deny} [<i>gre</i> <i>esp</i> <i>eigrp</i> <i>icmp</i> <i>igmp</i> <i>ospf</i> <i>pim</i> <i>vrrp</i> <i>protocol-id</i> <i>PROTOCOL-ID</i>]{any host <i>SRC-IP-ADDR</i> <i>SRC-IP-ADDR</i> <i>MASK</i>} {any host <i>DST-IP-ADDR</i> <i>DST-IP-ADDR</i> <i>MASK</i>} [<i>precedence</i> <i>PRECEDENCE</i> <i>tos</i> <i>TOS</i> <i>dscp</i> <i>DSCP</i>] [<i>time-range</i> <i>PROFILE-NAME</i>] [<i>priority</i> <i>PRIORITY</i>]</code>	Permits or denies the specified layer 4 protocol packet based on the specified source/destination IP address, port, or IP header traffic class information.

The ordering of statements can be explicitly defined or automatically assigned. If the user defines the statement with a priority number, the ordering is manually determined. A smaller priority number means a higher precedence. If the user does not specify a priority number when entering a criteria statement, a priority number will be automatically assigned.

In the following example, the user creates an access control list called “Web-Management” that allows host 192.168.0.222 to make an HTTP connection to the web server within the 192.168.50.0/24 IP subnet, in between the times specified in the “lunch-time” time range profile. The hosts in the 192.168.0.0/24 subnet will be disallowed to make HTTP connections to the web server at all other times, if applied to the interface connected to the web server:

```
DGS-6600:2>enable
DGS-6600:15#configure terminal
DGS-6600:15 (config)#ip access-list extended Web-Management
DGS-6600:15 (config-ip-ext-acl)#permit tcp host 192.168.0.222 eq 80 192.168.50.0
255.255.255.0 time-range lunch-time
DGS-6600:15 (config-ip-ext-acl)#end
```

Configuring IPv6 Extended Access Control Lists

For IPv6 extended access control lists, the user can define the permit/deny statement based on IPv6 address, layer 4 port ID, and classification of service information. The user can also enter the statement with a time-range profile.

Use the following commands to create or modify an IPv6 extended access control list:

Command	Explanation
<code>ipv6 access-list extended <i>NAME</i></code>	Creates or modifies an IPv6 extended access control list.
<code>{permit deny} {tcp udp} {any host <i>SRC-IPV6-ADDR</i> <i>SRC-IPV6-ADDR MASK</i>} [<i>OPERATOR PORT</i>] {any host <i>DST-IPV6-ADDR</i> <i>DST-IPV6-ADDR MASK</i>} [<i>OPERATOR PORT</i>] [<i>traffic-class TRAFFIC-CLASS</i>] [<i>time-range PROFILE-NAME</i>] [<i>priority PRIORITY</i>]</code>	Permits or denies TCP or UDP packets based on the specified source/destination IPv6 address, TCP port, UDP port, or IPv6 header traffic class information.
<code>{permit deny} [<i>icmpv6</i> <i>ospfv3</i> <i>nextheader NEXTHEADER</i>] {any host <i>SRC-IPV6-ADDR</i> <i>SRC-IPV6-ADDR MASK</i>} {any host <i>DST-IPV6-ADDR</i> <i>DST-IPV6-ADDR MASK</i>} [<i>traffic-class TRAFFIC-CLASS</i>] [<i>time-range PROFILE-NAME</i>] [<i>priority PRIORITY</i>]</code>	Permits or denies traffic based on the ICMPv6 packets, OSPFv3 packets, or on the value in the IPv6 next header field for a specified source/destination IPv6 address, TCP port, UDP port, or the traffic class information included in the IPv6 header.

In the following example, the user creates an access control list called “ipv6-control”. The user creates three entries in the IPv6 access list. The first entry permits tcp packets destined to the

network ff02::0:2/16, the second entry permits packets destined to host ff02::1:2, and the third entry permits all ICMP packets:

```
DGS-6600:2>enable
DGS-6600:15#configure terminal
DGS-6600:15 (config)#ipv6 access-list extended ipv6-control
The maximum available of IPv6 extended access-list is 255
DGS-6600:15 (config-ip6-ext-acl)#permit tcp any ff02::0:2 ffff:::
DGS-6600:15 (config-ip6-ext-acl)#permit tcp any host ff02::1:2
DGS-6600:15 (config-ip6-ext-acl)#permit icmpv6 any any
DGS-6600:15 (config-ip6-ext-acl)#end
```

Configuring MAC Extended Access Control Lists

For MAC extended access control lists, the user can define permit/deny statements based on the MAC address, Ethernet packet type, LLC service access point, 802.1p priority bits, or VLAN information. The user can enter the statement with a time range profile.

Use the following commands to configure a MAC extended access control list:

Command	Explanation
<code>mac access-list extended <i>NAME</i></code>	Creates or modifies a MAC extended access control list.
<code>{permit deny} {any host <i>SRC-MAC-ADDR</i> <i>SRC-MAC-ADDR MASK</i>} {any host <i>DST-MAC-ADDR</i> <i>DST-MAC-ADDR MASK</i>} [<i>ethernet-type TYPE</i> <i>llc dsap DSAP ssap SSAP cntl CNTL</i>] [<i>dot1p PRIORITY-TAG</i>] [<i>vlan VLAN-ID</i>] [<i>time-range PROFILE-NAME</i>] [<i>priority PRIORITY</i>]</code>	Permits or denies packets based on the MAC address, Ethernet packet type, LLC service access point, P802.1p priority bits, or VLAN information.

The ordering of statements can be explicitly defined or automatically assigned. If the user defines the statement with a priority number, the ordering is manually determined. A smaller priority number means a higher precedence. If the user does not specify a priority number when entering a criteria statement, a priority number will be automatically assigned.

In the following example, the user creates a new MAC extended access control list called "Block-Server", which blocks connections from 00-1d-60-a1-37-b5 to 00-1a-92-24-80-f7, when applied to the interface connected to the host 00-1d-60-a1-37-b5. Any traffic originating from 00-1a-92-24-80-f7 that is destined for 00-1d-60-a1-37-b5 will be permitted if the traffic sent does not require a reply from 00-1d-60-a1-37-b5:

```
DGS-6600:2>enable
DGS-6600:15#configure terminal
DGS-6600:15 (config)#mac access-list extended Block-Server
The maximum available of MAC access-list is 6
DGS-6600:15 (config-mac-ext-acl)#deny host 00-1d-60-a1-37-b5 host 00-1a-92-24-80-f7
DGS-6600:15 (config-mac-ext-acl)#permit any any
DGS-6600:15 (config-mac-ext-acl)#end
```

Re-sequencing the Criteria Statements in Access Control Lists

Since the priority of criteria is explicitly specified for some statements and auto-assigned for others, the user may need to re-number the priority numbers to easily configure new statements. When the priority is renumbered, the number is adjusted based on the specified start sequence number and increment number. The ordering of statements is not changed.

Use the following command to re-sequence the priority of the access control list entries in an access control list:

Command	Explanation
resequence access-list <i>NAME</i> <i>STARTING-SEQUENCE-NUMBER</i> <i>INCREMENT</i>	Re-sequences the priority of the entries in an access control list.

In the following example, the user displays the configuration for the “ip server-security” access control list and re-sequences the access control list with an initial value of 1 and an increment value of 2. The user then re-displays the configuration for the “ip server-security” access control list to verify that the changes have been made correctly:

```
DGS-6600:2>enable
DGS-6600:15#show access-list ip server-security
10      deny    tcp    host 192.168.0.222 eq 80  192.168.50.0 255.255.255.0
20      deny    tcp    host 192.168.0.121 eq 23  192.168.100.0 255.255.255.0
30      permit  tcp    192.168.50.0 255.255.255.0 eq 80  host 192.168.0.222
DGS-6600:15#configure terminal
DGS-6600:15(config)#resequence access-list server-security 1 2
DGS-6600:15(config)#end
DGS-6600:15#show access-list ip server-security
1       deny    tcp    host 192.168.0.222 eq 80  192.168.50.0 255.255.255.0
3       deny    tcp    host 192.168.0.121 eq 23  192.168.100.0 255.255.255.0
5       permit  tcp    192.168.50.0 255.255.255.0 eq 80  host 192.168.0.222
DGS-6600:15#
```

Displaying Access Control Lists

Use the following command to display the access control lists that have been setup on the Switch:

Command	Explanation
show access-list [ip <i>NAME</i> mac <i>NAME</i> ipv6 <i>NAME</i>]	Displays the access control lists setup on the Switch.

In the following example, the user displays all the access control lists that have been setup on the Switch:

```
DGS-6600:2>show access-list
access-list name                access-list type
-----
First-Floor-Filter             mac ext-acl
Block-Server                   mac ext-acl
Management                     ip acl
Test                           ip acl
IT-Management                 ip acl
Strict-Control                 ip ext-acl
Telnet-Management             ip ext-acl
TestTel                        ip ext-acl
Web-Management                 ip ext-acl
server-security                ip ext-acl
ipv6-control                   ipv6 ext-acl
Total Entries : 11
DGS-6600:2>
```

Applying Access Control Lists to Interfaces

The user can apply up to one MAC access control list, one IP access control list, and one IPv6 access control list to an interface in the ingress direction. If a MAC access control list, an IP access control list, and an IPv6 access control list are applied to an interface, the device will check the MAC access control list for an ingress packet first. If the packet matches a criteria statement in the MAC access control list and is permitted, the device will continue to check the IP access control list if the packet is an IPv4 packet or an IPv6 access control list if the packet is an IPv6 packet. If a deny statement is matched in the IP access control list, the packet will be dropped without any further ACL checking.

Use the following commands to apply an IP/MAC access control list to an interface and verify the settings:

Command	Explanation
<code>ip access-group <i>NAME</i></code>	Applies an IP access control list to an interface for ingress traffic.
<code>ipv6 access-group <i>NAME</i></code>	Applies an IPv6 access control list to an interface for ingress traffic.
<code>mac access-group <i>NAME</i></code>	Applies a MAC access control list to an interface for ingress traffic.
<code>show access-group [interface <i>INTERFACE-ID</i>] [ip [<i>NAME</i>] mac [<i>NAME</i>] ipv6 [<i>NAME</i>]]</code>	Displays the access control list configuration.

In the following example, the user applies the IP access list called “Web-Management” for inbound connections to Ethernet Port 4.5 and verifies the configuration:

```
DGS-6600:2>enable
DGS-6600:15#configure terminal
DGS-6600:15(config)#interface eth4.5
DGS-6600:15(config-if)#ip access-group Web-Management
The maximum available entry of IP ACL bind to interface in ingress direction is:
 1278
The maximum available port operator (gt/lt) is: 16
DGS-6600:15(config-if)#end
DGS-6600:15#show access-group interface eth4.5
eth4.5
  Inbound mac access-list : N/A
  Inbound ip access-list : Web-Management
  Inbound ipv6 access-list: N/A
DGS-6600:15#
```

In the following example, the user applies the IPv6 access list called “ipv6-control” for inbound connections to Ethernet Port 4.9 and verifies the configuration:

```
DGS-6600:2>enable
DGS-6600:15#configure terminal
DGS-6600:15(config)#interface eth4.9
DGS-6600:15(config-if)#ipv6 access-group ipv6-control
The maximum available entry of IPv6 ACL bind to interface in ingress direction is:
 1278
The maximum available port operator (gt/lt) is: 16
DGS-6600:15(config-if)#end
DGS-6600:15#show access-group interface eth4.9
eth4.9
  Inbound mac access-list : N/A
  Inbound ip access-list : N/A
  Inbound ip access-list : ipv6-control
DGS-6600:15#
```

In the following example, the user applies the MAC access control list called “Block-Server” for inbound connections to Ethernet Port 4.12 and verifies the configuration:

```
DGS-6600:2>enable
DGS-6600:15#configure terminal
DGS-6600:15(config)#interface eth4.12
DGS-6600:15(config-if)#mac access-group Block-Server in
The maximum available entry of MAC ACL bind to interface in ingress direction is:
 447
DGS-6600:15(config-if)#end
DGS-6600:15#show access-group interface eth4.12 mac
eth4.12
  Inbound mac access-list : Block-Server
DGS-6600:15#
```

Configuration Examples

ACL Configuration Example

Block specific IP subnet but permit others in specific time range.

In this example, ACL is configured to deny Net2 PC (e.g., 2.0.0.2) to Net1 PC (e.g., 1.0.0.2), but permit others in time range 18:00-23:59 every day.

Topology

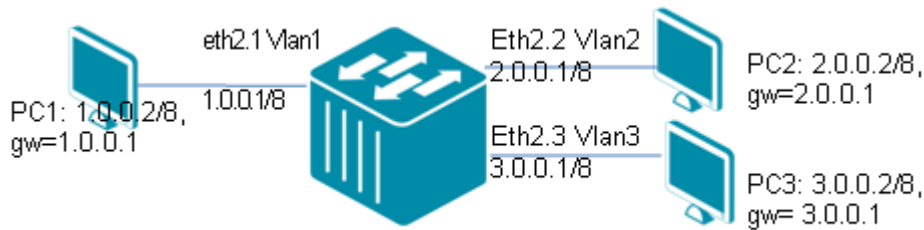

Figure 38-3 ACL Configuration Example Topology

Configuration Steps

Step 1: Create VLAN2 and VLAN3

```
DGS-6600:15(config)#vlan 2
DGS-6600:15(config)#vlan 3
```

Step 2: Assign port to VLAN

```
DGS-6600:15(config-if)#interface eth2.2
DGS-6600:15(config-if)# access vlan 2
DGS-6600:15(config-if)#interface eth2.3
DGS-6600:15(config-if)# access vlan 3
```

Step 3: Assign IP address to each VLAN

```
DGS-6600:15(config-if)#interface vlan1
DGS-6600:15(config-if)# ip address 1.0.0.1/8
DGS-6600:15(config-if)#interface vlan2
DGS-6600:15(config-if)# ip address 2.0.0.1/8
DGS-6600:15(config-if)#interface vlan2
DGS-6600:15(config-if)# ip address 3.0.0.1/8
```

Step 4: Set time-range ACL-1t and valid time is daily 18:00~23:59.

```
DGS-6600:15(config)#time-range ACL-1t
DGS-6600:15(config-time-range)# periodic daily 18:00 to 23:59
```

Step 5: Create ACL name ACL-1 and set deny and permit rule, and apply time-range.

```
DGS-6600:15(config)# ip access-list ACL-1
DGS-6600:15(config-ip-acl)# deny 2.0.0.2 255.0.0.0 1.0.0.2 255.0.0.0 time-range
ACL-1t
DGS-6600:15(config-ip-acl)# permit any any priority 20
```

Step 6: Apply ACL rule into eth2.2

```
DGS-6600:15(config)#interface eth2.2
DGS-6600:15(config-if)# ip access-group ACL-1 in
```

Verifying the Configuration

Use the following commands to check the ACL configuration.

```
DGS-6600:15#show access-list ip ACL-1
10      deny      2.0.0.2 255.0.0.0 1.0.0.2 255.0.0.0 time-range ACL-1t
20      permit   any any

DGS-6600:15#show access-list
access-list name          access-list type
-----
ACL-1                      ip acl
Total Entries : 1

DGS-6600:15#show access-group interface eth2.2
eth2.2
  Inbound mac access-list : N/A
  Inbound ip access-list  : ACL-1
  Inbound ipv6 access-list: N/A

DGS-6600:15#show time-range ACL-1t
time range name : ACL-1t
18:00 ~ 23:59, every day
```

PC2 (2.0.0.2, the IP to be denied) cannot ping PC1 (1.0.0.2). But PC3 (3.0.0.2, not in the deny list) can ping PC1 in specific time range 18:00 to 23:59.

PC2 can ping PC1 in other time range.

List of Constants and Default Settings

Constant Name	Value
Maximum Number of IP Basic Access Control Lists	256
Maximum Number of IP Extended Access Control Lists	256
Maximum Number of IPv6 Access Control Lists	256
Maximum Number of Rules per IP or IPv6 Access Control List	32
Maximum Number of MAC Access Control Lists	7
Maximum Number of Rules per MAC Access Control List	64
Maximum Number of Periods in a Time Range Profile	6
Maximum Number of each type of Access Control Lists that can be Applied to an Interface	1
Maximum Number of Time-Ranges	64

Table 38-1 Constants Values

Variable Name	Default Value
Default ACL Ending	Implicit Deny
ACL Priority Interval Value	10
ACL Resequencing	Disabled

Table 38-2 Default Variable Values

Chapter 39

Authentication, Authorization and Accounting (AAA) Configuration

Chapter Overview

The following topics are included in this chapter, please go to the topic for more detailed information:

- [Chapter Overview](#)
- [An Introduction to AAA Configuration](#)
- [AAA Configuration Commands](#)
 - [Configuring AAA Server Groups](#)
 - [Configuring Authentication Method Lists](#)
 - [Enabling Authorization from a Server](#)
- [List of Constants and Default Settings](#)

An Introduction to AAA Configuration

The AAA module allows the administrator to define methods for authenticating users that attempt to access the system via a console, Telnet, SSH, or HTTP connection. To configure an authentication method, the user must first define a server group. A server group contains a list of server hosts, with each server being able to run its own protocol. The ordering of the server hosts in the group determines the precedence of the servers that will be used for authentication.

A method list is a sequential list of server groups that describes the authentication methods that will be queried in order to authenticate a user. Method lists enable the user to designate one or more of the server groups that will be used for authentication, which ensures that a backup system is available for authentication if the initial method fails. The Switch system uses the first listed method to authenticate users. If that method fails to respond, the Switch system selects the next authentication method listed in the method list. This process continues until there is successful communication with a listed authentication method, or all the methods defined in the method list are exhausted.

It is important to note that the Switch system will only attempt authentication with the next listed authentication method when there is no response from the previous method. If authentication fails at any point in this cycle (meaning that the security server or local username database has responded by denying the user access) the authentication process will stop and no other authentication methods will be attempted.

Local authentication uses locally configured login and enable passwords to authenticate login attempts. The login and enable passwords are local to each switch and are not mapped to individual usernames. By default, local authentication is used. Once an authentication method list is specified for the login/enable password on some applications, the Switch will not attempt local authentication and even the specified authentication methods will fail.

If the method list is empty local authentication will be used.

AAA Configuration Commands

Configuring AAA Server Groups

A server group may contain a list of server hosts, with each group having different protocol methods specified. A server group, referenced by a group name, will be used to define the authentication methods for login users and 802.1x users etc. To define a server group, the user should use the **aaa group Server** command and enter AAA group server configuration mode. The user can then enter the **server** command to create server hosts with the available protocol methods. The order that servers are created in will be the order that clients will use when attempting to authenticate on the network.

Creating AAA Server Groups

Enter the following command in global configuration mode to create a new AAA server group:

Command	Explanation
aaa group server <i>GROUP-NAME</i>	Creates a new AAA server group.

In the following example, the user creates a new AAA server group called “group1”:

```
DGS-6600:2>enable
DGS-6600:15#configure terminal
DGS-6600:15 (config)#aaa group server group1
DGS-6600:15 (config-aaa-group-server)#end
```

Displaying AAA Server Groups

Enter the following command in privilege EXEC mode to display the AAA authentication groups:

Command	Explanation
show aaa group server [<i>GROUP-NAME</i>]	Creates a new AAA server group.

In the following example, the user creates a new AAA server group called “group1”:

```
DGS-6600:2>enable
DGS-6600:15#show aaa group server group1

Group Name      IP Address      Protocol Port  Timeout Retransmit Key
-----
group1          172.19.10.31   TACACS  1200  30      2
DGS-6600:15#
```

Defining AAA Server Hosts

The user can define a server host with the TACACS, XTACACS, TACACS+, or RADIUS protocol methods.

The following commands are used to create a server host in the server group.

Command	Explanation
<code>server {tacacs xtacacs} IP-ADDRESS [auth-port PORT] [timeout SECONDS] [retransmit COUNT]</code>	Specifies that the server will use the TACACS or XTACACS authentication method.
<code>server tacacs+ IP-ADDRESS [auth-port PORT] {key KEY-STRING no-encrypt}</code>	Specifies that the server will use the TACACS+ authentication method.
<code>server radius IP-ADDRESS [auth-port PORT] {key KEY-STRING no-encrypt} [timeout SECONDS] [retransmit COUNT]</code>	Specifies that the server will use the RADIUS authentication method.

In the following example, the user configures the Switch to recognize a TACACS host, that has the IP address 172.19.10.31 and uses the UDP destination port 1200, and configures the connection to timeout if a reply has not been received in 30 seconds:

```
DGS-6600:2>enable
DGS-6600:15#configure terminal
DGS-6600:15 (config)#aaa group server group1
DGS-6600:15 (config-aaa-group-server)#server tacacs 172.19.10.31 auth-port 1200
timeout 30
DGS-6600:15 (config-aaa-group-server)#end
```

In the following example, the user configures the Switch to recognize the RADIUS host. The RADIUS host 172.19.10.100 uses the UDP destination port 1500 and the RADIUS host 172.19.10.200 uses the UDP destination port 1600, with both RADIUS hosts not using encryption:

```
DGS-6600:2>enable
DGS-6600:15#configure terminal
DGS-6600:15 (config)#aaa group server group2
DGS-6600:15 (config-aaa-group-server)#server radius 172.19.10.100 auth-port 1500
no-encrypt
DGS-6600:15 (config-aaa-group-server)#server radius 172.19.10.200 auth-port 1600
no-encrypt
DGS-6600:15 (config-aaa-group-server)#end
```

Configuring Authentication Method Lists

The user can specify the method lists for the authentication of login users or enable passwords that are attempted via a console, Telnet or Web connection:

Command	Explanation
<code>aaa authentication [login enable] [console telnet http ssh] METHOD1 [METHOD2...]</code>	Used to configure a new authentication method list.
<code>show aaa [login enable] [console telnet http ssh] [brief]</code>	Displays the login or enable method lists for all applications.

In the following example, the user configures a login method list for authenticating login attempts from all supported applications (including console, Telnet, and HTTP). The methods start from group2. If there is no response, the local database will be used for authentication.

If no local databases are available on the network, authentication will not be carried out. Finally, the user enters the **show aaa** command to verify the configuration:

```
DGS-6600:2>enable
DGS-6600:15#configure terminal
DGS-6600:15 (config)#aaa authentication login group group2 local
DGS-6600:15 (config)#end
DGS-6600:15#show aaa
```

Console Session:

```
Login authentication:
Group Name: group2
Local Authentication: yes
  IP Address      Protocol  Port   Timeout  Retransmit  Key
  -----
  172.19.10.100   RADIUS   1500   5         2           no-encrypt
  172.19.10.200   RADIUS   1600   5         2           no-encrypt
Enable authentication:
Local Authentication: yes
```

Telnet Session:

```
Login authentication:
Group Name: group2
Local Authentication: yes
  IP Address      Protocol  Port   Timeout  Retransmit  Key
  -----
  172.19.10.100   RADIUS   1500   5         2           no-encrypt
  172.19.10.200   RADIUS   1600   5         2           no-encrypt
Enable authentication:
Local Authentication: yes
```

Ssh Session:

```
Login authentication:
Group Name: group2
Local Authentication: yes
  IP Address      Protocol  Port   Timeout  Retransmit  Key
  -----
  172.19.10.100   RADIUS   1500   5         2           no-encrypt
  172.19.10.200   RADIUS   1600   5         2           no-encrypt
Enable authentication:
Local Authentication: yes
```

Http Session:

```
Login authentication:
Group Name: group2
Local Authentication: yes
  IP Address      Protocol  Port   Timeout  Retransmit  Key
  -----
  172.19.10.100   RADIUS   1500   5         2           no-encrypt
  172.19.10.200   RADIUS   1600   5         2           no-encrypt
Enable authentication:
Local Authentication: yes
DGS-6600:15#
```

Enabling Authorization from a Server

The authorization function configures the Switch to only use settings that have been authorized by a RADIUS server. These settings include the VLAN assignment, user priority assignment, and bandwidth assignment.

Enter the following command to enable the authorization function:

Command	Explanation
<code>aaa authorization</code>	Enables the authorization function.

In the following example, the user enables the Switch to only use the AAA settings that have been authorized by the RADIUS server:

```
DGS-6600:2>enable
DGS-6600:15#configure terminal
DGS-6600:15 (config) #aaa authorization
DGS-6600:15 (config) #end
```

List of Constants and Default Settings

Constant Name	Value
Maximum Number of Method Lists per Application	2
Maximum Number of AAA Server Groups	8
Maximum Number of Server Hosts in an AAA Server Group	64

Table 39-1 Constants Values

Variable Name	Default Value
AAA Authentication Method	None
AAA Authorization	Disabled.
Default Timeout for Server Reply	5 seconds
Default number of times authentication requests will be resent by the Switch when no response is received.	2
Number of AAA Group Servers	None

Table 39-2 Default Variable Values

Chapter 40

802.1X Authentication

Chapter Overview

The following topics are included in this chapter, please go to the topic for more detailed information:

- [Chapter Overview](#)
- [An Introduction to 802.1X Authentication](#)
 - [802.1X Operation](#)
 - [Client](#)
 - [Authenticator](#)
 - [Authentication Server](#)
 - [Authentication Process](#)
 - [Port-based Access Control](#)
 - [Host-based Network Access Control](#)
- [802.1X Configuration Commands](#)
 - [Configuring 802.1X Authentication](#)
 - [Enabling Authentication](#)
 - [Initializing the 802.1x Protocol Operation](#)
 - [Starting the Re-Authentication of Clients](#)
 - [Specifying the Access Control Mode](#)
 - [Specifying the Port Control Direction](#)
 - [Configuring Port Guest VLANs](#)
 - [Specifying the Authentication Protocol](#)
 - [Creating the Local User Table](#)
 - [802.1X PDU Forwarding](#)
 - [Resetting the Port Level 802.1X Setting to Defaults](#)
 - [Displaying 802.1X Configuration and Status](#)
 - [Displaying Port Authentication Status](#)
 - [Displaying Configuration Settings](#)
 - [Displaying EAPOL Statistics](#)
 - [Displaying State Machine Information for Diagnostics](#)
 - [Displaying Session Statistics](#)
- [Configuration Examples](#)
 - [802.1x Guest VLAN Configuration Example](#)
- [Relations with Other Modules](#)
- [List of Constants and Default Settings](#)

An Introduction to 802.1X Authentication

802.1X Operation

802.1X is a security measure that uses a Client and Server based access control model to authorize and authenticate users trying to gain access to various wired or wireless devices on a specified Local Area Network (LAN). The 802.1X protocol accomplishes this by using a RADIUS server, that authenticates users trying to access the network, and relaying Extensible Authentication Protocol over LAN (EAPOL) packets between the Client and the Server.

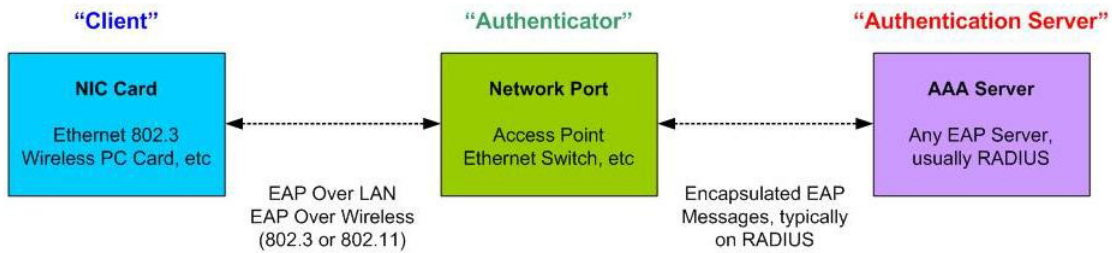

Figure 40-1 The Three Roles of 802.1X

Client

The Client is simply an end station that wishes to gain access to the LAN or Switch services. All end stations must be running software that is compliant with the 802.1X protocol. For users running Windows XP, Windows Vista, and Windows 7, the required software is included within the operating system. All other users are required to attain 802.1X client software from an outside source. The Client will request access to the LAN and or Switch through EAPOL packets and, in turn, will respond to requests from the Switch.

Authenticator

The Authenticator (the Switch) is an intermediary between the Authentication Server and the Client. The Authenticator serves two purposes when utilizing the 802.1X function. The first purpose is to request certification information from the Client using EAPOL packets, which is the only information allowed to pass through the Authenticator before access is granted to the Client. The second purpose of the Authenticator is to verify the information gathered from the Client with the Authentication Server, and to then relay that information back to the Client.

Authentication Server

The Authentication Server is a remote device that is connected to the same network as the Client and Authenticator. The Authentication Server must be running a RADIUS Server program and must be configured properly on the Authenticator (Switch). Clients connected to a port on the Switch must be authenticated by the Authentication Server (RADIUS) before attaining any services offered by the Switch on the LAN. The role of the Authentication Server is to certify the identity of the Client attempting to access the network by exchanging secure information between the RADIUS server and the Client through EAPOL packets and, which in turn informs the Switch whether or not the Client is granted access to the LAN and/or the Switch's services.

Authentication Process

Utilizing the three roles stated above, the 802.1X protocol provides a stable and secure way of authorizing and authenticating users attempting to access the network. Only EAPOL traffic is allowed to pass through the specified port before a successful authentication is made. This port is "locked" until the point when a Client with the correct user name and password (and MAC address if 802.1X is enabled by MAC address) is granted access, which would successfully "unlock" the port. Once unlocked, normal traffic is allowed to pass through the port. The following figure displays a

more detailed explanation of how the authentication process is completed between the three roles stated previously.

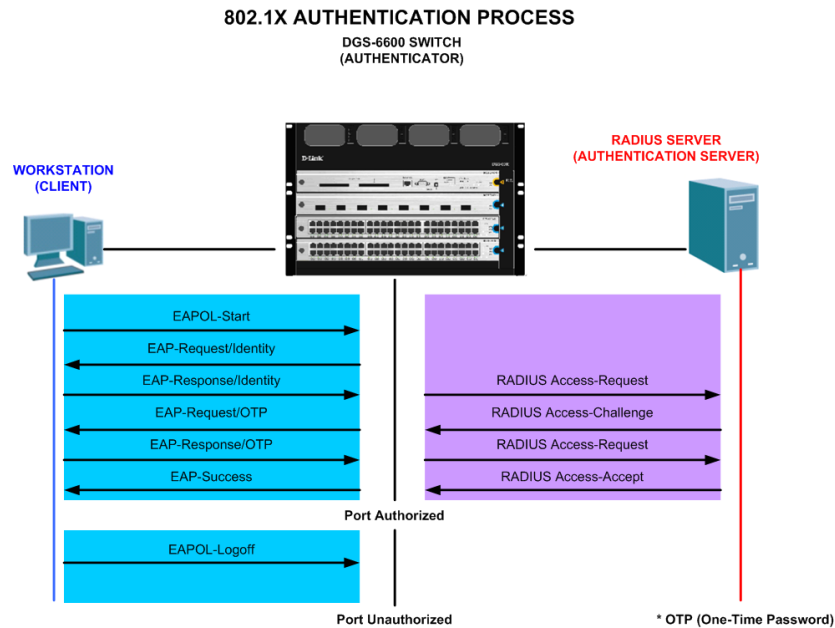

Figure 40-2 802.1X Authentication Process

Port-based and Host-based Access Control

Port-based Access Control

Once the connected device has successfully been authenticated, the Port will become an Authorized port, and all subsequent traffic on the Port will not be subject to access control restrictions until an event occurs that causes the Port to become Unauthorized. Hence, if the Port is actually connected to a shared media LAN segment with more than one attached device, successfully authenticating one of the attached devices will effectively allow LAN access to all the devices on the shared segment.

Host-based Network Access Control

In order to successfully make use of 802.1X in a shared media LAN segment, “logical” ports need to be created for each attached device that requires access to the LAN. The Switch would regard the single physical port that is connected to the shared media segment as consisting of a number of distinct logical ports, with each logical Port being independently controlled from the point of view of EAPOL exchanges and the authorization state. The Switch learns each attached devices’ individual MAC address, and effectively creates a logical port, which the attached device can use to communicate with the LAN via the Switch.

802.1X Configuration Commands

Configuring 802.1X Authentication

The following topics are included in this section:

- [Enabling Authentication](#)
- [Initializing the 802.1x Protocol Operation](#)

- [Starting the Re-Authentication of Clients](#)
- [Specifying the Access Control Mode](#)
- [Specifying the Port Control Direction](#)
- [Configuring Port Guest VLANs](#)
- [Specifying the Authentication Protocol](#)
- [Creating the Local User Table](#)
- [802.1X PDU Forwarding](#)
- [Resetting the Port Level 802.1X Setting to Defaults](#)

Enabling Authentication

To enable 802.1X authentication on a port, the user needs to enable the global setting, and then enable the authentication on the specific port, by using the commands below:

Command	Explanation
<code>dot1x system-auth-control</code>	Globally enables IEEE 802.1X authentication on the Switch.
<code>dot1x pae authenticator</code>	Specifies that the port will act as an IEEE 802.1X Port Access Entity (PAE) authenticator.

In the following example, the user globally enables IEEE 802.1X authentication and specifies that Ethernet interface 4.10 will act as a PAE authenticator:

```
DGS-6600:2>enable
DGS-6600:15#configure terminal
DGS-6600:15(config)#dot1x system-auth-control
DGS-6600:15(config)#interface eth4.10
DGS-6600:15(config-if)#dot1x pae authenticator
DGS-6600:15(config-if)#end
```

Specifying the 802.1X Timers and Parameters

The following table describes the timers that are used for 802.1x protocol operation:

Timer	Description
Quiet Period	The number of seconds that a port will stay in a silent state before processing the next PDU if the authentication process fails.
Re-authentication Period	The number of seconds between each authentication attempt.
Server Timeout	The number of seconds that the Switch will wait for a request from the RADIUS server before timing out the RADIUS server.
Supplicant Timeout	The number of seconds that the Switch will wait for a response from the supplicant before timing out the supplicant (client).

Table 40-1 802.1X Timer Values

Timer	Description
TX Period	The number of seconds that the Switch will wait for a response from an EAP-Request/Identity frame before retransmitting the request.
Maximum Request	The maximum number of messages that can be retransmitted to the client.

Table 40-1 802.1X Timer Values

Enter the following commands in interface configuration mode to specify the 802.1X timers and parameters:

Command	Explanation
<code>dot1x timeout {quiet-period SECONDS reauth-period SECONDS server-timeout SECONDS supp-timeout SECONDS tx-period SECONDS}</code>	Configures the 802.1x protocol related timers on the specified interface.
<code>dot1x max-req TIMES</code>	Configures the maximum number of times an EAP message is retransmitted to the client.

In the following example, the user sets the quiet period, reauthentication period, server timeout, supplicant timeout, and EAP request transmission period on port 4.10 to be 20, 1000, 15, 15, and 10 seconds, respectively:

```
DGS-6600:2>enable
DGS-6600:15#configure terminal
DGS-6600:15 (config)#interface eth4.10
DGS-6600:15 (config-if)#dot1x timeout quiet-period 20
DGS-6600:15 (config-if)#dot1x timeout reauth-period 1000
DGS-6600:15 (config-if)#dot1x timeout server-timeout 15
DGS-6600:15 (config-if)#dot1x timeout supp-timeout 15
DGS-6600:15 (config-if)#dot1x timeout tx-period 10
DGS-6600:15 (config-if)#end
```

In the following example, the user specifies that an EAP message can be transmitted a maximum of 3 times on Ethernet interface 4.17:

```
DGS-6600:2>enable
DGS-6600:15#configure terminal
DGS-6600:15 (config)#interface eth4.17
DGS-6600:15 (config-if)#dot1x max-req 3
DGS-6600:15 (config-if)#end
```

Initializing the 802.1x Protocol Operation

The user can use the following command to re-initialize the state machine associated with a specific port or user:

Command	Explanation
<code>dot1x initialize [interface <i>INTERFACE-ID</i> [mac-address <i>MAC-ADDRESS</i>]]</code>	Re-initializes the state machine associated with the specific port or user.

In the following example, the user initializes the authenticator state machine on Ethernet interface 4.12:

```
DGS-6600:2>enable
DGS-6600:15#dot1x initialize interface eth4.12
```

In the following example, the user initializes the authenticator state machine associated with the MAC address 00-40-10-28-19-78 on Ethernet interface 4.25:

```
DGS-6600:2>enable
DGS-6600:15#dot1x initialize interface eth4.25 mac-address 00-40-10-28-19-78
```

Starting the Re-Authentication of Clients

The user may use the following command to re-authenticate a specific port or a specific MAC address if they suspect the authority of a specific user or the users of a specific port:

Command	Explanation
<code>dot1x re-authenticate [interface <i>INTERFACE-ID</i> [mac-address <i>MAC-ADDRESS</i>]]</code>	Re-authenticates a specific port or a specific MAC address.

In the following example, the user re-authenticates Ethernet interface 4.43:

```
DGS-6600:2>enable
DGS-6600:15#dot1x re-authenticate interface eth4.43
```

In the following example, the user re-authenticates the MAC address 00-40-10-28-19-78 on Ethernet port 4.10:

```
DGS-6600:2>enable
DGS-6600:15#dot1x re-authenticate interface eth4.10 mac-address 00-40-10-28-19-78
```

Specifying the Access Control Mode

The following command sets the port to operate in either port-based mode or host-based mode:

Command	Explanation
<code>dot1x auth-mode {port-based host-based}</code>	Specifies the authentication mode of the specified interface.

In the following example, the user configures Ethernet interface 4.10 to use 802.1X port-based authentication:

```
DGS-6600:2>enable
DGS-6600:15#configure terminal
DGS-6600:15 (config) #interface eth4.10
DGS-6600:15 (config-if) #dot1x auth-mode port-based
DGS-6600:15 (config-if) #end
```

Specifying the Port Control Direction

The Switch allows the user to specify the direction of traffic that must be prevented from passing through an 802.1X controlled port. One option that the user can configure specifies that only incoming traffic will be prevented from passing through an 802.1X controlled port. The other option specifies that both incoming and outgoing traffic will be prevented from passing through an 802.1X controlled port.

Enter the following command to specify if the traffic for a controlled port should be prevented in both the inbound and outbound direction or only for the inbound direction:

Command	Explanation
<code>dot1x control-direction {both in}</code>	Specifies if the traffic for the controlled port should be prevented in both the inbound and outbound direction or only for the inbound direction.

In the following example, the user specifies that traffic for the controlled port Ethernet interface 4.43 should only be prevented in the inbound direction:

```
DGS-6600:2>enable
DGS-6600:15#configure terminal
DGS-6600:15 (config) #interface eth4.43
DGS-6600:15 (config-if) #dot1x control-direction in
DGS-6600:15 (config-if) #end
```

Specifying the Port Authorization State

The user can manually configure a port to be in an 802.1X authorized or unauthorized state by entering the following command in interface configuration mode:

Command	Explanation
<code>dot1x port-control {auto force-authorized force-unauthorized}</code>	Manually configures the authorization state on the specified port.

In the following example, the user forces Ethernet interface 4.40 to change to the unauthorized state, which denies all access to the port by ignoring all authentication attempts:

```
DGS-6600:2>enable
DGS-6600:15#configure terminal
DGS-6600:15 (config) #interface eth4.40
DGS-6600:15 (config-if) #dot1x port-control force-unauthorized
DGS-6600:15 (config-if) #end
```

Configuring Port Periodical Re-Authentication

The re-authentication function can be controlled on a per-port basis.

Enter the following command in interface configuration mode to enable the periodic re-authentication function on an interface:

Command	Explanation
<code>dot1x re-authentication</code>	Enables periodic re-authentication on the specified interface.

In the following example, the user enables periodic re-authentication on Ethernet interface 4.43:

```
DGS-6600:2>enable
DGS-6600:15#configure terminal
DGS-6600:15 (config) #interface eth4.43
DGS-6600:15 (config-if) #dot1x re-authentication
DGS-6600:15 (config-if) #end
```

Configuring Port Guest VLANs

In order to increase security, the Switch can be configured so that any users attempting to authenticate and gain permission to access the Switch will be placed into a guest VLAN, before have been successfully authenticated. When a guest VLAN is assigned to a port, the user on this port is only allowed to access the guest VLAN. After successful authentication, the user will be allowed to access the original access VLAN or a new VLAN that was assigned by the RADIUS server during authentication.

Enter the following command to enable and configure the guest VLAN function on an interface:

Command	Explanation
<code>dot1x guest-vlan VLAN-ID</code>	Enables and configures the guest VLAN function on the specified interface.

In the following example, the user configures Ethernet interface 4.2 to be a member of guest VLAN 2:

```
DGS-6600:2>enable
DGS-6600:15#configure terminal
DGS-6600:15(config)#interface eth4.2
DGS-6600:15(config-if)#dot1x guest-vlan 2
DGS-6600:15(config-if)#end
```

In the following example, the user removes Ethernet interface 4.2 from guest VLAN 2:

```
DGS-6600:2>enable
DGS-6600:15#configure terminal
DGS-6600:15(config)#interface eth4.2
DGS-6600:15(config-if)#no dot1x guest-vlan
DGS-6600:15(config-if)#end
```

Specifying the Authentication Protocol

Typically, 802.1x user access will be authenticated via a remote RADIUS server. For some special purposes, authentication can also be carried out via the local user table on the Switch. When authentication will be carried out by a remote RADIUS server, the 802.1X protocol will forward the request to the RADIUS server that was configured in the AAA module.

Enter the following command to specify the 802.1X authentication method that will be used on the ports that are using IEEE 802.1X authentication:

Command	Explanation
<code>dot1x auth-protocol {local radius}</code>	Specifies the 802.1X authentication method that will be used on the ports that are using IEEE 802.1X authentication.

In the following example, the user configures the Switch to use the RADIUS authentication method for the ports that are using IEEE 802.1X authentication:

```
DGS-6600:2>enable
DGS-6600:15#configure terminal
DGS-6600:15(config)#dot1x auth-protocol radius
DGS-6600:15(config)#end
```

Creating the Local User Table

When the user configures the Switch to use local authentication, the local user table is used to define the user names and passwords that are required for accessing the device.

Enter the following commands to create and display the local accounts that will be used for 802.1X authentication:

Command	Explanation
<code>dot1x user NAME password PASSWORD</code>	Creates a local account for 802.1X authentication.
<code>show dot1x user</code>	Displays the local accounts that can be used for 802.1X authentication.

In the following example, the user creates a new local account called “dlink” with the password “switch6604”. Finally, the user displays all the local accounts that will be used for 802.1X authentication:

```
DGS-6600:2>enable
DGS-6600:15#configure terminal
DGS-6600:15(config)#dot1x user dlink password switch6604
DGS-6600:15(config)#end
DGS-6600:15#show dot1x user
```

Username	Password
dlink	switch6604
robert	5t@nm0r31

```
Total Entries: 2
DGS-6600:15#
```

802.1X PDU Forwarding

When the 802.1X authentication function is disabled on an interface, an 802.1x BPDU arriving on an interface can be dropped or forwarded based on the interface’s access VLAN.

Enter the following command in interface configuration mode to specify that an interface will still forward 802.1X BPDUs if the 802.1X function is disabled on the interface:

Command	Explanation
<code>dot1x forward-pdu</code>	Allows the interface to forward 802.1X BPDUs if the interface is 802.1X disabled.

In the following example, the user allows Ethernet interface 4.32 to forward 802.1X BPDUs if the 802.1X function is disabled on Ethernet interface 4.32:

```
DGS-6600:2>enable
DGS-6600:15#configure terminal
DGS-6600:15(config)#interface eth4.32
DGS-6600:15(config-if)#dot1x forward-pdu
DGS-6600:15(config-if)#end
```

Resetting the Port Level 802.1X Setting to Defaults

Enter the following command in interface configuration mode to reset the 802.1X settings on an interface back to default settings:

Command	Explanation
<code>dot1x default</code>	Specifies that the IEEE 802.1X parameters on the specified interface will be reset to default settings.

In the following example, the user resets the IEEE 802.1X parameters on Ethernet interface 4.46 back to default settings:

```
DGS-6600:2>enable
DGS-6600:15#configure terminal
DGS-6600:15 (config) #interface eth4.46
DGS-6600:15 (config-if) #dot1x default
DGS-6600:15 (config-if) #end
```

Displaying 802.1X Configuration and Status

The following information about the 802.1X configuration and status can be displayed by the Switch:

- [Displaying Port Authentication Status](#)
- [Displaying Configuration Settings](#)
- [Displaying EAPOL Statistics](#)
- [Displaying State Machine Information for Diagnostics](#)
- [Displaying Session Statistics](#)

Enter the following command to view information about the 802.1X configuration and status:

Command	Explanation
<code>show dot1x [interface <i>INTERFACE-ID</i> {auth-state auth-configuration statistics diagnostics session-statistics}]</code>	Displays information about the 802.1X configuration and status.

Displaying Port Authentication Status

In the following example, the user displays the IEEE 802.1X authentication state for Ethernet interface 4.22:

```
DGS-6600:2>show dot1x interface eth4.22 auth-state
```

Port	User	Authenticator State	Backend State	Port Status
eth4.22		ForceAuth	Success	Authorized

```
Total Entries: 1  
DGS-6600:2>
```

Displaying Configuration Settings

In the following example, the user displays the IEEE 802.1X configuration for Ethernet interface 4.23:

```
DGS-6600:2>show dot1x interface eth4.23 auth-configuration
```

```
System Auth Control: Enabled  
Authentication Protocol: Radius
```

```
eth4.23  
  PAE: None  
  Control Direction: Both  
  Port Control: Auto  
  Quiet Period: 60  
  Tx Period: 30  
  Supp Timeout: 30  
  Server Timeout: 30  
  Max-req: 2  
  Reauth Period: 3600  
  Re-authentication: Disabled  
  Authentication Mode: Port-based  
  Guest VLAN: Disabled  
  Forward 1x PDU: Disabled  
Total Entries: 1  
DGS-6600:2>
```

Displaying EAPOL Statistics

In the following example, the user displays the IEEE 802.1X statistics for Ethernet port 4.24:

```
DGS-6600:2>show dot1x interface eth4.24 statistics

eth4.24
  EAPOL Frames RX: 0
  EAPOL Frames TX: 0
  EAPOL-Start Frames RX: 0
  EAPOL-Logoff Frames RX: 0
  EAPOL-Resp/Id Frames RX: 0
  EAPOL-Resp Frames RX: 0
  EAPOL-Req/Id Frames TX: 0
  EAPOL-Req Frames TX: 0
  Invalid EAPOL Frames RX: 0
  EAP-Length Error Frames RX: 0
  Last EAPOL Frame Version: 0
  Last EAPOL Frame Source: 00-00-00-00-00-00
Total Entries: 1
DGS-6600:2>
```

Displaying State Machine Information for Diagnostics

In the following example, the user displays the IEEE 802.1X diagnostics for Ethernet port 4.25:

```
DGS-6600:2>show dot1x interface eth4.25 diagnostics

eth4.25
  EntersConnecting: 0
  EAP-LogoffsWhileConnecting: 0
  EntersAuthenticating: 0
  SuccessesWhileAuthenticating: 0
  TimeoutsWhileAuthenticating: 0
  FailsWhileAuthenticating: 0
  ReauthsWhileAuthenticating: 0
  EAP-StartsWhileAuthenticating: 0
  EAP-LogoffsWhileAuthenticating: 0
  ReauthsWhileAuthenticated: 0
  EAP-StartsWhileAuthenticated: 0
  EAP-LogoffsWhileAuthenticated: 0
  BackendResponses: 0
  BackendAccessChallenges: 0
  BackendNonNakResponsesFromSupplicant: 0
  BackendAuthSuccesses: 0
  BackendAuthFails: 0

Total Entries: 1
DGS-6600:2>
```

Displaying Session Statistics

In the following example, the user displays the authentication session statistics on Ethernet port 4.26:

```
DGS-6600:2>show dot1x interface eth4.26 session-statistics

eth4.26
  SessionOctetsRX: 0
  SessionOctetsTX: 0
  SessionFramesRX: 0
  SessionFramesTX: 0
  SessionId:
  SessionAuthenticationMethod:
  SessionTime: 0
  SessionTerminateCause: PortAdminDisabled
  SessionUserName:

Total Entries: 1
DGS-6600:2>
```

Configuration Examples

802.1x Guest VLAN Configuration Example

In this example, PC1 is connected to the 802.1x guest VLAN enabled port. If PC1 is not yet pass the 802.1x authentication, it will stay in guest VLAN (VLAN2). After it passes the 802.1x authentication, it will be assigned to authenticated (target) VLAN (VLAN4).

Topology

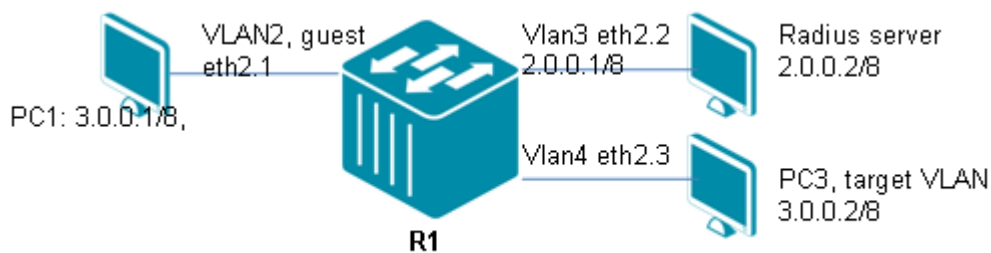

Figure 40-3 802.1x Guest VLAN Configuration Topology

R1 (Router 1) Configuration Steps

Step 1: Create VLAN2, VLAN3 and VLAN4

```
DGS-6600:15(config)# vlan 2
DGS-6600:15(config-vlan)# vlan 3
DGS-6600:15(config-vlan)# vlan 4
```

Step 2: Assign port to VLANs and set IP address to VLAN.

```
DGS-6600:15(config-if)#interface eth2.2
DGS-6600:15(config-if)# access vlan 3
DGS-6600:15(config-if)#interface eth2.3
DGS-6600:15(config-if)# access vlan 4
DGS-6600:15(config-if)#interface vlan3
DGS-6600:15(config-if)# ip address 2.0.0.1/8
```

Step 3: Assign eth2.1 to vlan2, 802.1x authenticator, and guest VLAN port.

```
DGS-6600:15(config)#interface eth2.1
DGS-6600:15(config-if)# access vlan 4
DGS-6600:15(config-if)# dot1x pae authenticator
DGS-6600:15(config-if)# dot1x guest-vlan 2
```

Step 4: Configure RADIUS server, and enable global 802.1x.

```
DGS-6600:15(config)#aaa group server rs-1
DGS-6600:15(config-aaa-group-server)# server radius 2.0.0.2 key 123456
DGS-6600:15(config-aaa-group-server)#dot1x system-auth-control
DGS-6600:15(config)#aaa authorization
```

Radius Server Configuration Steps

Step 1: create username/password list (e.g., test/123).

Step 2: Configure the VID to be assigned in RADIUS VLAN attribute "Tunnel-Private-Group-ID". In this example, assign to 4.

Verifying The Configuration

Step 1: Use the following commands to check the 802.1x configuration.

```
DGS-6600:15#show aaa group server

Group Name          IP Address          Protocol Port   Timeout Retransm
it Key
-----
rs-1                2.0.0.2            RADIUS   1812   5       2
*****

DGS-6600:15#show dot1x interface eth2.1 auth-configuration

System Auth Control: Enabled
Authentication Protocol: Radius

eth2.1
 PAE: Authenticator
Control Direction: Both
Port Control: Auto
Quiet Period: 60
Tx Period: 30
Supp Timeout: 30
Server Timeout: 30
Max-req: 2
Reauth Period: 3600
Re-authentication: Disabled
Authentication Mode: Port-based
Guest VLAN: 2
Forward 1x PDU: Disabled
```

Step 2: Before PC1 passes the 802.1x authentication, it's still in "Guest VLAN", and cannot ping PC3 in authenticated VLAN.

Step 3: In PC1, run 802.1x client program, and key in username/password = test/123. After passed the 802.1x authentication, the port eth2.1 will become VLAN4 membership (target VLAN) and PC1 can ping PC3.

Relations with Other Modules

- 1) 802.1x cannot be enabled on a port-security enabled port.
- 2) 802.1x cannot be configured on a channel-group member port.
- 3) 802.1x cannot be configured on a port-channel.
- 4) 802.1x cannot be enabled on a packet monitoring destination port.

List of Constants and Default Settings

Constant Name	Value
Maximum Number of Allowed Users per Interface in Host-based Mode	16
Maximum Number of Entries in Local User Table	128

Table 40-2 Constants Values

Variable Name	Default Value
802.1X Authentication	Disabled
Authentication Mode	Port-based
Authentication Protocol	RADIUS
802.1X Control Direction	Bi-directional
802.1X Controlled Port Authorization State	Auto
Maximum Number of Times Switch will Transmit EAP Request Frames to Supplicant before Authentication Process Restarts	2
802.1X Quiet Period	60 Seconds
802.1X Re-authentication Period	3600 Seconds
802.1X Server Timeout Period	30 Seconds
802.1X Supplicant Timeout Period	30 Seconds
802.1X Transmit Period	30 Seconds
802.1X Guest VLAN	Disabled
802.1X PAE Authentication State on an Interface	Disabled
802.1X Local User Accounts	None
Re-authentication	Disabled
Forward 802.1x PDU	Disabled

Table 40-3 Default Variable Values

Chapter 41

DoS Protection

Chapter Overview

The following topics are included in this chapter, please go to the topic for more detailed information:

- [Chapter Overview](#)
 - [An Introduction to DoS Protection](#)
- [DoS Prevention Overview](#)
 - [Architecture](#)
- [Operation Concepts](#)
 - [Mechanism](#)
 - [Actions](#)
- [Attack Types](#)
- [Configuration Examples](#)
- [Parameters](#)

An Introduction to DoS Protection

A denial-of-service (DoS) attack is an attempt to make device resource unavailable to its intended users. The DoS attack are usually implemented by consuming resource of device and let device cannot reply to legitimate user or reply slowly. The DoS Prevention gives one solution to recognize well-known DoS attacking pattern and do relating actions. User can configure the device to drop packets to prevent device or other hosts from DoS attack.

DoS Prevention Overview

Architecture

The architecture of DoS is shown as below. There is one local database located in DoS prevention module. The database is used to keep configuration and counters. When the DoS prevention of specific attacking type are enable/disable, the value will be set to hardware chip. There is one counter task in DoS module, the counter task will gather counter from chip every five minutes. If the log action configured, DoS module will add log when counter increased in five minutes.

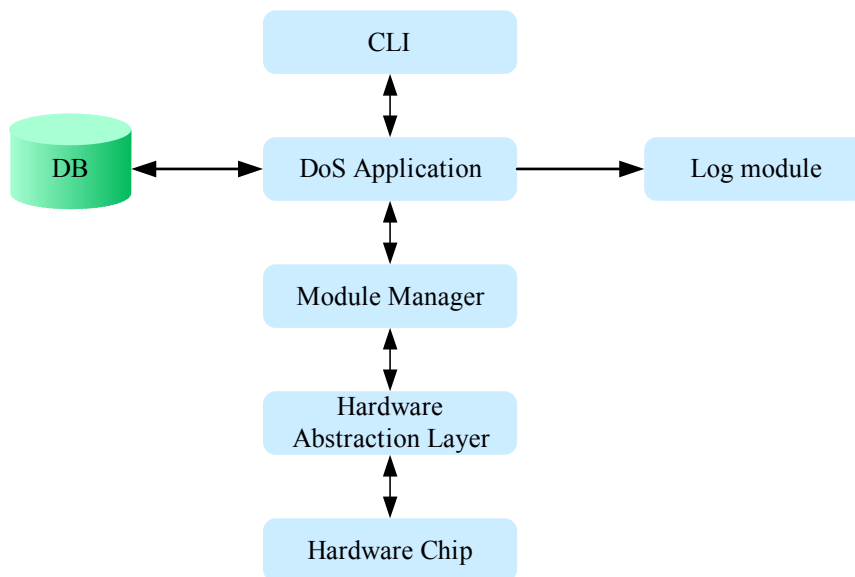

Operation Concepts

Mechanism

When the DoS prevention mechanism turn on, inbound packets will be compared to pre-defined DoS attack pattern. If the pattern matched, the device will drop//log the packet according to user configured action. Most packet matching and actions (drop) are handled by hardware. (Due to the hardware limitation the Smurf Attack will be handled by software.)

Actions

Action	Description
Drop	Will drop all attacking packets. By default drop is turned on and cannot be disabled.
Trap/Log	Users can configure trap/log action to log or send trap. When the action configured, the trap/log will be triggered once every 5 minutes, if there are attacking packets received in previous 5 minutes, the module will log and send trap.

Attack Types

The following table lists different DoS attack types.

Attack Type	Description
Land Attack	A Land attack is an attack where IP packets source and destination addresses are set to the address of the targeted device. It may cause a target device to reply to itself continuously.
Trap/Log	Users can configure trap/log action to log or send trap. When the action configured, the trap/log will be triggered once every 5 minutes, if there are attacking packets received in previous 5 minutes, the module will log and send trap.
Blat Attack	This type of attack will send packets with TCP/UDP source ports equal to the destination port of the target device. This may cause target device to respond to itself.
Smurf Attack	Attacker sends a large number of ICMP request packets to IP broadcast addresses, the SIP of attacking packets equals the victim's IP address. If a router delivers traffic to the IP broadcast address, all hosts in that IP network will reply with ICMP to the victim IP address.
TCP Null scan	TCP sequence number is zero and all control bits are zero.
TCP Xmas scan	TCP packets with FIN, URG, PSH bits set and sequence number is zero.
TCP SYN FIN	TCP packets with SYN, FIN bit set.
TCP SYN source port <1024	TCP packets with SYN bit set, and source port <1024.

Configuration Commands

Commands	Description
<code>clear dos_prevention counter</code>	Use this command to clear the counter of all attack types.
<code>dos_prevention action {trap_log}</code>	Use this command to specify the action to perform when a DoS attack occurs, use the no form to disable.
<code>dos_prevention type {ATTACK-TYPES}</code>	Use this command to enable/disable DoS prevention mechanism. The packet matching and actions are handled by hardware. For each type of attack, the device will match the specific pattern automatically, use the no form to disable.
<code>show dos_prevention</code>	Use this command to show DoS prevention status and related drop counters.

Configuration Examples

This example shows how to clear counters.

```
DGS-6600(config)# clear dos_prevention counter
```

The following examples shows how to enable action trap_log.

```
DGS-6600# configure terminal
DGS-6600(config)# dos_prevention action trap_log
```

The following example shows how to remove action trap_log.

```
DGS-6600# configure terminal
DGS-6600(config)# no dos_prevention action trap_log
```

The following example shows how to enable the DoS prevention mechanism for a land_attack

```
DGS-6600# configure terminal
DGS-6600(config)# dos_prevention type land_attack
```

The following example shows how to enable the DoS prevention mechanism for all supported types.

```
DGS-6600# configure terminal
DGS-6600(config)# dos_prevention type all
```

The following example shows how to disable the DoS prevention mechanism for all supported types. The following example shows the information of a DoS configuration example.

```
DGS-6600# configure terminal
DGS-6600(config)# no dos_prevention type all
```

User has configured to enable DoS on attacking type "Land Attack", "Blat Attack" and the action "Drop", "Log" are enabled. (Please note that enable dos prevention to block blat_attack may block the Syslog packets). The "Action" row shows users have enabled "Drop", "Log" actions. The original received attacking packets of "Land Attack", "Blat Attack" will be dropped. Each packet dropped by

DoS module will cause “Frame Count” increasing by 1. For every five minutes, DoS module will add one log to system log if any attacking packet is received in this interval.

```
DGS-6600# show dos_prevention
DoS Prevention Information
Action: Drop Log
Frame Counts: 12345678
DoS Type State
-----
Land Attack Enabled
Blat Attack Enabled
Smurf Attack Disabled
TCP Null Disabled
TCP Xmas Disabled
TCP SYNFIN Disabled
TCP SYN SrcPort Less Than 1024 Disabled
DGS-6600#
```

Parameters

Parameter Name	Attribute	Default Value	Value Range	Description
Type	Config	None	land_attack / blat_attack / smurf_attack / tcp_null_scan / tcp_xmasscan / tcp_synfin / tcp_syn_srcport_less_1024 / all	Enable DoS prevention mechanism for specific or all attacking type.
Action	Config	drop	Drop / trap_log	Enable DoS prevention actions.

Chapter 42

Dynamic ARP Inspection

Chapter Overview

The following topics are included in this chapter, please go to the topic for more detailed information:

- [Chapter Overview](#)
- [An Introduction to Dynamic ARP Inspection](#)
- [Dynamic ARP Inspection Configuration Commands](#)
 - [IP ARP inspection trust](#)
 - [IP ARP inspection validate](#)
 - [IP ARP Inspection VLAN](#)

An Introduction to Dynamic ARP Inspection

Dynamic ARP Inspection in this chapter, refers to the inspection of the validity of received ARP packets. Illegal ARP packets will be discarded.

ARP itself does not check the validity of incoming ARP packets, this is a drawback of ARP. In this way, attackers can launch ARP spoofing attacks easily by exploiting the drawback of the protocol. The most typical one is the man in the middle attack, which is described as follows:

Devices x, y and z are connected to the switch and located in the same subnet. Their IP and MAC addresses are respectively represented by (IP x, MAC x), (IP y, MAC y) and (IP z, MAC z). When device x needs to communicate with device y in the network layer, device x broadcasts an ARP request in the subnet to query the MAC value of device y. Upon receiving this ARP request packet, device y updates its ARP buffer using IP x and MAC x, and sends an ARP response. Upon receiving this response, device x updates its ARP buffer using IP y and MAC y.

With this model, device z will cause the corresponding relationship of ARP entries in device x and device y to be incorrect. The policy is to broadcast the ARP response to the network continuously. The IP address in this response is IP x / IP y, and the MAC address is MAC z. Then, ARP entries (IP y and MAC z) will exist in device x, and ARP entries (IP x and MAC z) exist in device y. Communication between device x and device y is changed to communication with device z, which is unknown to devices x and y. Device z acts as an intermediary and it modifies the received packets appropriately and forwards to another device. This is a well-known man in the middle attack.

Dynamic ARP Inspection ensures that only legal ARP packets are forwarded by the device. It performs the following operations:

Interception of all ARP requests and response packets at the un-trusted port that corresponds to the VLAN with the Dynamic ARP inspection function enabled.

It checks the validity of the intercepted ARP packets according to the setting of DHCP database before further processing.

It Releases the packets that do not pass inspection.

Appropriate processing of packets that pass the inspection and sending them to their destinations, according to the DHCP snooping binding database, whether ARP packets is valid or not can be checked. For details, refer to *DHCP Snooping Configuration*.

Dynamic ARP Inspection Configuration Commands

IP ARP inspection trust

ARP packets are checked according to the trust status of each port on the device. DAI check is ignored for the packets that are received through trust ports and are considered as legal ARP packets. DAI check will be performed strictly for the ARP packets that are received through un-trusted ports. In a typical network configuration, layer 2 port connected to the network device should be set as a trust port, and layer 2 port connected to the host device should be set as an un-trusted port.

Use the command **ip arp inspection trust** to trust an interface for dynamic ARP inspection. Use the no form of the command to disable the trust state.

When an interface is in ip arp inspection trust state, the ARP packets arriving at the interface will not be inspected. When an interface is in ip arp inspection un-trusted state, the ARP packets arriving at the port and belong to the VLAN that is enabled for inspection will be inspected.

Example

This example shows how to configure port 3.3 to be trusted for DAI:

```
DGS-6600# configure terminal
DGS-6600(config)# interface eth3.3
DGS-6600(config-if)# ip arp inspection trust
DGS-6600(config-if)#
```

IP ARP inspection validate

Use the **ip arp inspection validate** command to specify the additional checks to be performed during ARP inspection check.

Syntax	Description	Explanation
src-mac		(Optional) Specify to check, for both ARP request response packets, the consistency of the source MAC address in the Ethernet header against the sender MAC address in the ARP payload.
dst-mac		(Optional) Specify to check, for ARP response packets, the consistency of the destination MAC address in the Ethernet header against the target MAC address in the ARP payload.

Syntax	Description	Explanation
ip		<p>(Optional) Checks the ARP body for invalid and unexpected IP addresses.</p> <p>Specify to check the validity of IP address in the ARP payload. Sender IP in both ARP request and response and target IP in ARP response are validated. Packets with addresses including 0.0.0.0, 255.255.255.255, and all IP multicast addresses are dropped. Sender IP addresses are checked in all ARP requests and responses, and target IP addresses are checked only in ARP responses.</p>

Example

This example shows how to enable source MAC validation:

```
DGS-6600# configure terminal
DGS-6600(config)# ip arp inspection validate src-mac
DGS-6600(config)#
```

This example shows how to disable source MAC validation:

```
Switch# configure terminal
Switch(config)# no ip arp inspection validate src-mac
Switch(config)#
```

IP ARP Inspection VLAN

Use the **ip arp inspection vlan** command to enable specific VLANs for dynamic ARP inspection.

Command	Explanation
vlan <i>VLAN-ID</i>	Specify the VLAN to enable or disable the ARP inspection function.
,	(Optional) Specify a series of VLANs, or separate a range of VLANs from a previous range. Enter a space before and after the comma.
-	(Optional) Specify a range of VLANs. Enter a space before and after the hyphen.

Example

This example shows how to enable ARP inspection on VLAN2:

```
DGS-6600# configure terminal
DGS-6600(config)# ip arp inspection vlan 2
DGS-6600(config)#
```

Chapter 43

DHCP Server Screening

Chapter Overview

The following topics are included in this chapter, please go to the topic for more detailed information:

- [Chapter Overview](#)
 - [An introduction to DHCP Server Screening Configuration](#)
 - [DHCP Server Screening](#)
 - [DHCP Server Screening Operating Concept](#)
 - [Configuring DHCP Server Screening/Client Filtering](#)
- [DHCP Server Screening/Client Filtering Configuration Commands](#)
 - [Configuring ip dhcp screening ports](#)
 - [Configuring ip dhcp screening suppress-time](#)
 - [Configuring ip dhcp screening](#)
 - [Enable DHCP Server screening function on ports](#)
 - [Add "permit" rule to DHCP server screening](#)
 - [Configuring ip dhcp screening trap-log](#)
- [DHCP Server Screening Default Settings](#)
- [DHCP Server Screening Limitation](#)

An introduction to DHCP Server Screening Configuration

The following chapter discusses the different commands available for use in using and configuring DHCP Server screening and Snooping commands.

The DHCP protocol is widely used to dynamically allocate the recycled network resources, for example, IP address. The DHCP Client sends a DHCP DISCOVER broadcast packet to the DHCP Server. The Client will send the DHCP DISCOVER again if it does not receive a response from the server within a specified time. After the DHCP Server receives the DHCP DISCOVER packet, it allocates resources to the Client, for example, IP address according to the appropriate policy, and sends the DHCP OFFER packet. After receiving the DHCP OFFER packet, the DHCP Client sends a DHCP REQUEST packet to obtain the server lease. After receiving the DHCP REQUEST packet, the server verifies whether the resources are available. If so, it sends a DHCP ACK packet. If not, it sends a DHCP NAK packet. Upon receiving the DHCP ACK packet, the DHCP Client starts to use the resources assigned by the server in condition that the ARP verification resources are available. If it receives the DHCP NAK packet, the DHCP Client will send the DHCP DISCOVER packet again.

DHCP Snooping TRUST port: Because the packets for obtaining IP addresses through DHCP are in the form of broadcast, some illegal servers may prevent users from obtaining IP addresses, or even cheat and steal user information. To solve this problem, DHCP Snooping classifies the ports into two types: TRUST port and UNTRUST port. The device forwards only the DHCP reply packets received through the TRUST port while discarding all the DHCP reply packets from the UNTRUST port. In this way, the illegal DHCP Server can be shielded by setting the port connected to the legal DHCP Server as a TRUST port and other ports as UNTRUST ports. **DHCP Snooping binding database:** By snooping the packets between the DHCP Clients and the DHCP Server, DHCP Snooping combines the IP address, MAC address, VID, port and lease time into an entry to form a DHCP Snooping user database.

DHCP Server Screening

The typical exchanged message flow is described in the diagram below. When DHCPDISCOVER is broadcast, both server A and Server B will receive the broadcast packet, both Server A and Server B then send the DHCPOFFER packet back. Users can filter certain types of DHCPOFFER by DHCP server screening.

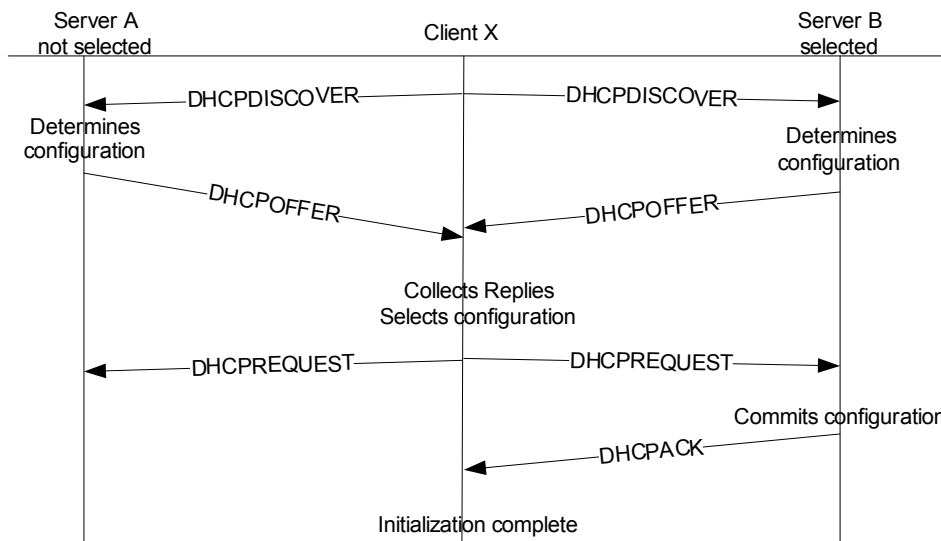

Take the diagram above as an example, if administrators don't want Client X to receive the DHCPOFFER sent from Server A, the administrators can enable per port control of DHCP screening on port1, port2 and set the filter rule, the 3-tuple of Server B's IP (10.1.2.1), Client X's MAC (00:80:c8:00:00:01) and port number (port 2). As a result, the DHCPOFFER sent from Server A will be dropped and when the switch receives it on port 1. Eventually, Client X has no chance to receive the DHCPOFFER from Server A but Server B.

the diagram below is an example of a filter DHCP server.

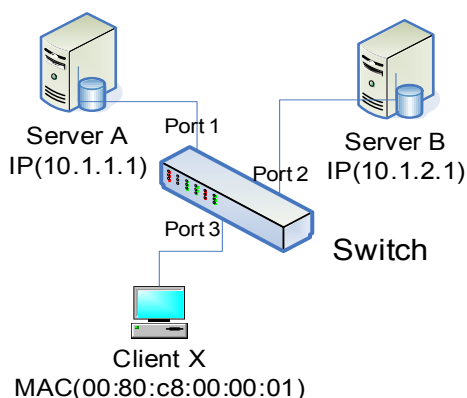

DHCP Server Screening Operating Concept

DHCP server screening can be enabled on physical port or port channel, but it can't enable on any member ports of a port channel. When DHCPserver screening enables on ports, it will drop all DHCP server packets by default. Deny all DHCP server packets by default and "DHCP Server Screening" is used to specify explicit "permit" rules for the 3-tuple (DHCP server IP, client's MAC, port list from which DHCP server is allowed come). The user needs turn on the port's "DHCP Server Screening" to make all DHCP server packets are denied by default. If a port's "DHCP Server Screening" doesn't turn on, the "permit" rule is not effective, because all DHCP server packets received from this port are permit. In other words, for a simple scenario, if the user makes sure none DHCP server packets is allowed from a port, he can just turn on this port's "DHCP Server

Screening" to deny all DHCP server packets. Also, user is able to determine if device needs to send trap and log when illegal DHCP server is detected. The same illegal DHCP server IP address detected just is sent once to the trap receivers within the log ceasing unauthorized duration configured command "ip dhcp screening suppress-duration".

DHCP Server Screening/Client Filtering Configuration Commands

Configuring DHCP Server Screening/Client Filtering

this sub-section contains the following topics:

- [Configuring ip dhcp screening ports](#)
- [Configuring ip dhcp screening suppress-time](#)
- [Configuring ip dhcp screening](#)
- [Enable DHCP Server screening function on ports](#)
- [Add "permit" rule to DHCP server screening](#)
- [Configuring ip dhcp screening trap-log](#)

Configuring ip dhcp screening ports

Command	Explanation
<code>ip dhcp screening ports <i>INTERFACE-ID</i> [, -]</code>	Use this command to configure the state of the function for filtering of DHCP server packet on ports.
<code>no ip dhcp screening trap-log</code>	Use the no form of this command to disable function on ports.

The ip screening ports command can be used to enable per port control of the DHCP server screening function. If a port is configured to enable DHCP server screening function, it will deny all DHCP server packets (UDP source port = 67). You can add a permit binding rule by command "ip dhcp screening".

The following example enable the DHCP server screening function on port eth4.1 and eth5.3:

```
DGS-6600# configure terminal
DGS-6600(config)#ip dhcp screening ports eth4.1,eth5.3
```

Configuring ip dhcp screening suppress-time

Command	Explanation
ip dhcp screening suppress-duration <i>SUPPRESS-TIME</i>	Use this command to set the interval that device will send trap when illegal DHCP server is detected. The same illegal DHCP server IP address detected just is send once to the trap receivers within the specified ceasing unauthorized duration.
no ip dhcp screening suppress-duration	Use the no form to restore default settings.

The following example shows to specify the suppress time to 20 minutes:

```
DGS-6600# configure terminal
DGS-6600(config)# ip dhcp screening suppress-duration 20
```

Configuring ip dhcp screening

Command	Explanation
ip dhcp screening server-ip <i>IP-ADDRESS</i> [client-mac <i>MAC-ADDRESS</i>] ports <i>INTERFACE-ID</i> [, -]	Use this command to add/delete the DHCP server/client binding entry.

This command is used to specify explicit "permit" rules for the 3-tuple (DHCP server IP, client's MAC, port list from which DHCP server is allowed come) to allow DHCP server packets. DHCP server packets except those met explicated configured met the server IP / .client MAC binding will be filtered on specified ports. If client MAC address is not specified, then DHCP server packets will pass as long as .the server IP matches.

Note: The user needs turn on the port's "DHCP Server Screening" to make all DHCP server packets are denied by default by command: "ip dhcp screening ports". If a port's "DHCP Server Screening" doesn't turn on, the "permit" rule is not effective.

The following example configures a permit rule to allow DHCP server packet with source IP address 10.1.1.1 and client MAC address 00-08-01-02-03-04 on eth4.1-4.34.

```
DGS-6600# configure terminal
DGS-6600(config)# ip dhcp screening server-ip 10.1.1.1 client-mac 00-08-01-02-03-04
ports eth4.1-4.34
```

Enable DHCP Server screening function on ports

The configuration below describes the common case and enable DHCP server screening function on ports or port list, in which a port list ranged from eth4.1-4.48 is to be enabled.

```
DGS-6600> enable
DGS-6600# configure terminal
DGS-6600(config)# ip dhcp screening ports eth4.1-4.48
```

Add "permit" rule to DHCP server screening

User could specify explicit "permit" rules for the 3-tuple (DHCP server IP, client's MAC, port list from which DHCP server is allowed come) to determine only DHCP server packets which matches rule can pass. The configuration below describes how to enable DHCP server screening function on ports or port list, in which a port list ranged from eth4.1-4.48 is to be enabled and specify device only allow DHCP server packet if the server IP address is 10.1.1.1 and the client's clients MAC address is 00-08-01-02-03-04 only if the ingress ports are eth4.1-4.48.

```
switch> enable
switch# configure terminal
switch(config)# ip dhcp screening ports eth4.1-4.48
switch(config-if)# ip dhcp screening server-ip 10.1.1.1 client-mac 00-08-01-02-03-04 ports eth4.1-4.48
```

The provided Command Line Interface (CLI) allows each port to be independently configured to enable DHCP server screening function. User could also explicitly specify the "permit" rule to restrict some pre-defined DHCP server packets to be passed. Following is the example configuration under the Ethernet environment.

Configuring ip dhcp screening trap-log

The provided Command Line Interface (CLI) allows each port to be independently configured to enable DHCP server screening function. User could also explicitly specify the "permit" rule to restrict some pre-defined DHCP server packets to be passed. Following is the example configuration under the Ethernet environment.

Command	Explanation
<code>ip dhcp screening trap-log</code>	Used to enable trap/log function and use the no form to disable trap/log function.

Use this command to enable the function of trap/log. It will log illegal server IP address, ingress port and send trap if any DHCP server packet is not authorized and dropped if user turns on this function.

The following example shows to enable trap/log function of DHCP screening:

```
DGS-6600# configure terminal
DGS-6600(config)# ip dhcp screening trap-log
```

DHCP Server Screening Default Settings

Parameter Name	Attribute	Default Value	Value Range	Description
DHCP Server screening state	Config/show	Disabled	Enable/Disable	Enable/Disable the DHCP server screening to provide the service for the ports. It's a per port control.
Permit rule entry	Config/show	None	Enable/Disable	The form of 3-tuple (DHCP server IP, client's MAC, port list from which the DHCP server is allowed)
Trap/log state	Config/show	Disabled	Enable/Disable	Enable/Disable the trap/log function in DHCP server screening.
Suppress duration	Config/show	10	1-30	The interval that the same illegal server IP will be logged once.

Table 43-1

DHCP Server Screening Limitation

Parameter Name	Maximum Number	Description
Permit Rule Number	255	The maximum number of configurable rules.
Illegal IP addresses	255	The Maximum Number of IP addresses not accepted by permit rules will be kept.

Chapter 44

DHCP Snooping Configuration

Chapter Overview

The following topics are included in this chapter, please go to the topic for more detailed information:

- [Chapter Overview](#)
- [An Introduction to DHCP Snooping](#)
 - [DHCP Operation concept](#)
- [DHCP Snooping Configuration Commands](#)
 - [Enabling and Disabling DHCP Snooping](#)
 - [Configuring an "allow-untrusted port"](#)
 - [Configuring Snooping Trusts](#)
 - [Configuring the verification of a source MAC address from a DHCP packet](#)
 - [Configuring an ip dhcp snooping vlan](#)
 - [Verifying ip dhcp snooping settings](#)

An Introduction to DHCP Snooping

DHCP snooping is a technique that ensures IP integrity. It works with information from a DHCP server to:

- Track the physical location of hosts.
- Ensure that hosts only use the IP addresses assigned to them.
- Ensure that only authorized DHCP servers are accessible.

The switch offers the DHCP snooping to snoop DHCP packet that received or forward by switch. DHCP snooping acts just like a firewall between DHCP client and server.

DHCP snooping is a DHCP security feature that provides network security by filtering untrusted DHCP messages and by building and maintain DHCP snooping binding database. You can use DHCP snooping to differentiate between untrusted interface connected to DHCP client and trusted interface connected to the DHCP server or another switch. The "trust" is only conceptual; user can specify the interface as trusted port. For DHCP snooping, all DHCP servers MUST be connected to the switch through trusted interfaces.

In DHCP snooping, the switch builds DHCP snooping binding entries automatically. The DHCP snooping binding database has the MAC address, the IP address, the lease time, the binding type, the VLAN number, and the interface information that corresponds to the local untrusted interface of a switch. It does not have information that host connected with trusted interface.

The DHCP server should be connected to a trusted interface. This is mandatory to make sure that the DHCP server functions can process properly. When a switch receives a packet on an untrusted interface and the interface belongs to a VLAN that is enabled DHCP snooping, the switch compares

the source MAC address and the DHCP client hardware address. If the addresses match (default), the switch forwards the packet. Otherwise the switch drops the packet.

The switch validates DHCP packets received on the untrusted interfaces of VLANs with DHCP snooping enabled.

DHCP Operation concept

Because the packets for obtaining IP addresses through DHCP are in the form of broadcast, some illegal servers may prevent users from obtaining IP addresses, or even cheat and steal user information. To solve this problem, DHCP Snooping classifies the ports into two types: TRUST port and UNTRUST port. The device forwards only the DHCP reply packets received through the TRUST port while discarding all the DHCP reply packets from the UNTRUST port. In this way, the illegal DHCP Server can be shielded by setting the port connected to the legal DHCP Server as a TRUST port and other ports as UNTRUST ports. DHCP Snooping binding database: By snooping the packets between the DHCP Clients and the DHCP Server, DHCP Snooping combines the IP address, MAC address, VID, port and lease time into an entry to form a DHCP Snooping user database.

DHCP Snooping Configuration Commands

Enabling and Disabling DHCP Snooping

The DHCP snooping function snoops the DHCP packets arriving at the un-trusted interface on VLAN that is enabled for DHCP snooping. With this function, the DHCP packets come from the un-trusted interface can be validated, and a DHCP binding database will be constructed for the DHCP snooping enabled VLAN. The binding database provides IP and MAC binding information that can be further used by the IP source guard and dynamic ARP inspection process.

Use the `ip dhcp snooping` command to globally enable DHCP snooping and use the `ip dhcp snooping vlan` command to enable DHCP snooping for a VLAN. DHCP snooping process occurs during the relay agent relays the packet. To enable the DHCP relay service, relay agent service must be enabled by `service dhcp` command, and the server address to relay the packet must be configured by the `ip helper address`.

Command	Explanation
<code>ip dhcp snooping</code>	Use this command to globally enable DHCP snooping. Use <code>no</code> command to disable DHCP snooping.
<code>no ip dhcp snooping</code>	

These examples shows how to enable and disable DHCP snooping:

```
DGS-6600:15# configure terminal
DGS-6600:15(config)# ip dhcp snooping
DGS-6600:15(config)#
-----
DGS-6600:15# configure terminal
DGS-6000:15(config)# no ip dhcp snooping
DGS-6600:15(config)#
```

Configuring an “allow-untrusted port”

The DHCP snooping function validates the DHCP packets when it arrives at the port on the VLAN that is enabled for DHCP snooping. By default, the validation process will drop the packet if gateway address!=0 or option 82 is present. Use the `ip dhcp snooping information option allow-untrusted` command to allow the packet with relay option 82 arriving at the un-trusted interface.

Command	Explanation
<code>ip dhcp snooping information option allow-untrusted</code>	Use this command to globally allow DHCP packets with relay option 82 on the un-trusted interface. Use the no form of the command to not allow the packets with relay option 82.

This example shows how to enable DHCP snooping option-82 allow-untrusted port:

```
DGS-6600# configure terminal
DGS-6600(config)# ip dhcp snooping information option allow-untrusted
DGS-6600(config)#
```

Configuring Snooping Trusts

Normally, the ports connected to DHCP server or to other switches should be configured as a trusted interface. The ports connected to DHCP clients should be configured as un-trusted interface. When a port is configured as an un-trusted interface, the DHCP message arrives at the port on a vlan that is enabled for DHCP and snooping will be validated by the following checks.

- (1)The received message should be all sent by the client. If the message is sent by the DHCP server, the message will be dropped.
- (2)If `ip dhcp snooping verify mac-address` is enabled, the source MAC in the Ethernet header must be the same as the DHCP client hardware address to pass the validation.
- (3)For the received release and decline packets, the received port is also checked against the binding database entry. The packet will be dropped if inconsistent.
- (4)If gateway address!=0 or option 82 is present, the packet is dropped. In addition to doing the validation, DHCP snooping also create a binding entry based on the IP address assigned to client by the server in DHCP snooping binding database. The binding entry contains information including MAC address, IP address, the VLAN ID and port ID where the client is located, and the expiry of the lease time.

Command	Explanation
<code>ip dhcp snooping trust</code>	Use this command to configure a port as interface trusted for DHCP snooping. Use the no form of this command to return to the default setting.

This example shows how to enable DHCP snooping trust for port 3.3:

```
DGS-6600(config)# interface eth3.3
DGS-6600(config-if)# ip dhcp snooping trust
DGS-6600(config)#
```

Configuring the verification of a source MAC address from a DHCP packet

The DHCP snooping function validates the DHCP packets when it arrives at the port on the VLAN that is enabled for DHCP snooping. By default, DHCP snooping will verify that the source MAC in the Ethernet header be the same as the DHCP client hardware address to pass the validation.

Command	Explanation
<code>ip dhcp snooping verify mac-address</code>	Use this command to enable the verification that the source MAC address in a DHCP packet matches the client hardware address. Use the <code>no</code> command to disable the verification of the MAC address.

This example shows how to enable the verification that the source MAC address in a DHCP packet matches the client hardware address:

```
DGS-6600# configure terminal
DGS-6600(config)# ip dhcp snooping verify mac-address
```

Configuring an ip dhcp snooping vlan

Use the `ip dhcp snooping` command to globally enable DHCP snooping and use the `ip dhcp snooping vlan` command to enable DHCP snooping for a VLAN. DHCP snooping process occurs during the relay agent relaying the packet. The DHCP snooping function snoops the DHCP packets arriving at the untrusted interface on VLAN that is enabled for DHCP snooping. With this function, the DHCP packets that come from an un-trusted interface can be validated, and a DHCP binding database will be constructed for the DHCP snooping enabled VLAN. The binding database provides IP and MAC binding information that can be further used by the IP source guard and dynamic ARP inspection process. The DHCP snooping enabled status for a secondary VLAN follows the status for its primary VLAN. Thus, the DHCP snooping setting does not take effect if it is configured on a secondary VLAN.

Command	Explanation
<code>ip dhcp snooping vlan VLAN-ID [, -]</code>	Use this command to enable DHCP snooping on a VLAN or a group of VLANs. Use the <code>no</code> version of this command to disable DHCP snooping on a VLAN or a group of VLANs.

This example shows how to enable DHCP snooping on vlan10:

```
DGS-6600# configure terminal
DGS-6600(config)# ip dhcp snooping vlan 10
DGS-6600(config)#
```

Verifying ip dhcp snooping settings

The following commands can be used to verify the various settings.

Command	Explanation
<code>show ip dhcp snooping</code>	Use this command to display DHCP snooping configuration.
<code>show ip dhcp snooping binding [IP-ADDRESS] [MAC-ADDRESS] [vlan VLAN-ID] [interface INTERFACE-ID [, -]]</code>	Use the command to display DHCP snooping binding entries.
<code>show ip dhcp snooping database</code>	This command is used to display the statistics of the DHCP snooping database.

Chapter 45

Port Security

Chapter Overview

The following topics are included in this chapter, please go to the topic for more detailed information:

- [Chapter Overview](#)
- [An Introduction to Port Security Configuration](#)
- [Port Security Configuration Commands](#)
- [Relations with Other Modules](#)
- [List of Constants and Default Settings](#)

An Introduction to Port Security Configuration

Port Security is a function that secures a port by restricting the number of MAC addresses that are allowed to access the port. Configuring port security on a port allows the Switch to automatically learn the valid MAC addresses. The Switch stops learning valid MAC addresses once a port has reached the maximum number of MAC addresses that the port can learn. These valid MAC addresses are referred to as secured MAC addresses.

When port security is configured for a port, the Switch restricts the maximum number of MAC addresses that can access the port. The Switch enforces port-security by reserving the specified number of entries in the MAC address table. The valid MAC addresses can then be automatically learned in the reserved space. The system uses a software approach to conduct the automatic learning of secured MAC address. That is, when a new user arrives, the new address is reported to the CPU. The software takes over and determines if the MAC address should be learned in the MAC address table or be reported as a violated MAC address.

When configuring port security for a port, the following attributes can be specified:

1) Number of Restrictions

The maximum number of MAC addresses that are allowed to access the secured port. If the maximum number of MAC addresses is not exceeded, the port continues the learning process. The learning process stops when the port reaches the maximum number of allowed MAC addresses.

2) Address Learning Mode

This learning mode determines the way a secured MAC address should be learned in the MAC address table:

- **delete-on-timeout**

The secured MAC address will be learned as a dynamic entry and will be subject to the aging function. When this address entry is aged out, the address learning process will resume so that new secured MAC addresses can be learned.

- **permanent**

The secured MAC address will be learned as static entry and stored in NVRAM so that the entry is retained if the Switch is rebooted.

3) Violation Action

The following action causes a security violation:

- If the number of source MAC addresses seen on an interface is more than the port-security limit.
When a security violation occurs, the system takes one of the following actions, based on the user's configuration:
- **Protect**- If the number of source MAC addresses seen on the secured port is more than the port-security limit, packets with unknown source addresses will be dropped.
- **Shutdown**- The secured port is error disabled when a security violation occurs. The error disabled port can be recovered by entering the **shutdown** command, followed by the **no shutdown** in interface configuration mode.

Port Security Configuration Commands

The following commands are used to configure and verify port security settings:

Command	Explanation
<code>switchport port-security [maximum VALUE violation {protect shutdown} mode {permanent delete-on-timeout}</code>	Configures port-security related attributes.
<code>show port-security [interface INTERFACE-ID[, -]</code>	Displays port-security related settings.

In the following example, the user configures Ethernet interface 4.5 to have to use the delete-on-timeout security mode, restricts the number of MAC addresses that can be learned on the port to 10, and specifies that the port should be shutdown if a violation occurs:

```
DGS-6600:2>enable
DGS-6600:15#configure terminal
DGS-6600:15(config)#interface eth4.5
DGS-6600:15(config-if)#switchport port-security maximum 10
DGS-6600:15(config-if)#switchport port-security violation shutdown
DGS-6600:15(config-if)#end
DGS-6600:15#show port-security interface eth4.5
```

Interface	Max No.	Current No.	Violation	Secure Type	State
eth4.5	10	0	Shutdown	Delete-on-Timeout	Disabled

```
Total Entries: 1
DGS-6600:15#
```

Relations with Other Modules

- 1) Cannot enable port security on 802.1x enabled ports.
- 2) Cannot configure port security settings on a channel group member port.

- 3) Cannot configure port security settings on a port channel.
- 4) Cannot enable port security on the packet monitoring destination port.

List of Constants and Default Settings

Constant Name	Value
Maximum Restrict Number	16
Minimum; default number of allowed MAC Addresses per Port	1

Table 45-1 Constants Values

Variable Name	Default Value
Port Security	Disabled
Port Security Mode	Delete-on-Timeout
Violation Action	Shutdown

Table 45-2 Default Variable Values

Chapter 46

IP Source Guard

Chapter Overview

The following topics are included in this chapter, please go to the topic for more detailed information:

- [Chapter Overview](#)
- [An Introduction to IP Source Guard](#)
- [IP Source Guard Configuration Commands](#)
 - [ip verify source vlan dhcp-snooping port-security](#)
 - [ip source binding](#)

An Introduction to IP Source Guard

IP Source Guard is a security application used on edge switches are usually directly connected to hosts. IP Source Guard provides administrators to configure pairs of MAC and IP addresses that are allowed to access networks through the switch. IP Source Guard binds together the network layer, which uses an IP address, and the Ethernet link layer, which uses a MAC address, to authenticate packets from host.

The feature uses dynamic DHCP snooping and static IP source binding to match IP addresses to hosts on untrusted Layer 2 access ports.

In IP Source Guard, all IP packets will be drop by default ACL rule if enable IP Source Guard. While user enables IP Source Guard will use ACL rules to authorize IP packet. After a client receives an IP address from the DHCP server, or after static IP source binding is configured by the administrator, all traffic with that IP source address is permitted from that client. Traffic from other hosts is denied. All L2 packets will be drop before IP packet with same MAC address authorized by IP source guard. The key of IP Source Guard database is MAC address and VLAN.

When user configures (IP, MAC, VLAN, Port) in IP Source Guard will add a ACL permit rule. The IP packets received by switch not match the IP Source Guard database will be blocked by the ACL deny rule and the non-IP packets will be passed. If the IP Source Guard is disabled, all ACL deny and permit rules which configure by user will be removed from the hardware ACL table. Each permit and deny rule of ACL will use a double wide slice (two single wide slices) to add rules. So if ACL has no enough slices even has enough entries to enable IP source guard or config static IP source guard entry, config will be failed and prompt warning message under this situation.

While user configures an IP Source guard static entry then FDB will add a dynamic entry. If user config a static FDB entry and the MAC address is conflict with IP source guard entry before this dynamic FDB entry age out, then static FDB entry will not be add and prompt message. If the dynamic FDB entry that IP source guard is age out, then static FDB entry will be add success. If user configure a static entry of IP source guard and conflict with static FDB will log and prompt error message then this configure will fail.

If user config a static ARP entry conflict with the IP address of IP source guard entry, then static ARP entry will be release the entry that IP source guard configure. If user configure a static entry of IP source guard and conflict with the IP address of static ARP will log and prompt error message then this configure will fail.

If the sender of the packet is an authorized client, the packets sent from this client will be forwarded. While user configures a static entry to IP Source Guard, if the HW ACL table has no enough entry or

has no enough slice to create deny or permit entry, then the static entry will not be set in IP Source Guard database and this entry should be as inactive. The Switch needs to log and prompt warning message under this situation.

The maximum entry of IP Source Guard is 512 include a deny rule. When the active entries are less than max entry, but total number of active and inactive entries is exceeds double max entry, IP source Guard will delete the inactive entry first build, and build new active entry. IP source guard only displays the active entries.

IP source guard has two modes to filter (IP, MAC VLAN, Port), IP filter and IP-MAC filter. In IP filter mode, IP source guard will add an ACL permit rule as (IP, Port). In IP-MAC filter mode, IP source guard will add an ACL permit rule as (IP, MAC, Port). If user configures filter mode as IP filter and configure IP-MAC filter mode next time, then the filter mode of port will be change as the latest filter mode that user configure.

While IP packet is unauthorized by IP source guard, this invalid IP packet will not records in any blocked or invalid table and L2 FDB will not has any blocked entry.

Because IP source guard is not support IPv6 in Release2, while user runs IP source guard then the FDB table will be configured by software. But the IPv6 packets not support so the MAC address will not be configured in FDB table. IPv6 and IPv4 must not configure on same VLAN while IP source guard enable in Release2.

IP Source Guard Configuration Commands

ip verify source vlan dhcp-snooping port-security

Command	Explanation
ip verify source vlan dhcp-snooping port-security	Use this command to enable IP source guard for a port. Use the no form of the command to disable IP source guard.
no ip verify source vlan dhcp-snooping port-security	

Use the command the enable the IP source guard on the configured port.

When a port is enabled for IP source guard, the IP packet arrives at the port will be validated via port ACL. Port ACL is a hardware mechanism and its entry can come from either the manual configured entry or the DHCP snooping binding database. The packet fails to pass the validation will be dropped.

The IP to MAC address binding pair must match the entries in port ACL to pass the validation.

Example

This example shows how to enable IP Source Guard for port 3.1:

```
DGS-6600# configure terminal
DGS-6600(config)# interface eth3.1
DGS-6600(config-if)# ip verify source vlan dhcp-snooping port security
DGS-6600(config-if)#
```

ip source binding

Command	Explanation
ip source binding MAC-ADDRESS vlan VLAN-ID IP-ADDRESS interface PORT [, -]	Use this command to create a static entry used for IP source guard. Use the no form of the command to delete a static entry.
no ip source binding MAC-ADDRESS vlan VLAN-ID IP-ADDRESS interface PORT [, -]	

Syntax

<i>MAC-ADDRESS</i>	Specifies the MAC address of the IP to MAC address binding entry.
vlan <i>VLAN-ID</i>	Specified the VLAN that the valid host belongs to.
<i>IP-ADDRESS</i>	Specifies the IP address of the IP to MAC address binding entry.
<i>PORT</i>	Specified the port that the valid host is connected.
,	(Optional) Specify a series of interfaces, or separate a range of interfaces from a previous range. No space before and after the comma.
-	(Optional) Specify a range of interfaces. No space before and after the hyphen.

Use the command to create a static binding entry used for IP source guard check.

Use the no command to delete a static binding entry. The parameters specified for the command must exact match the configured parameter to be deleted.

If the MAC address and the VLAN for the configured entry already exist, the existing binding entry is updated.

The interface specified for the command can be a physical port interface.

Example

This example shows how to configure an IP Source Guard entry with IP address 10.1.1.1 and MAC address 00-01-02-03-04-05, at VLAN 2 on interface eth3.10:

```
DGS-6600# configure terminal
DGS-6600(config)# ip source binding 00-01-02-03-04-05 vlan 2 10.1.1.1 interface eth3.10
DGS-6600#
```

Chapter 47

Safeguard Engine Settings

Chapter Overview

The following topics are included in this chapter, please go to the topic for more detailed information:

- [Chapter Overview](#)
 - [An Introduction to Safeguard Engine Settings](#)
- In Fuzzy mode, once the Safeguard Engine has entered the Exhausted mode, the Safeguard Engine will decrease the packet flow by half. After returning to Normal mode, the packet flow will be increased by 25%. The switch will then return to its interval checking and dynamically adjust the packet flow to avoid overload of the Switch.
- [Configuration Commands](#)
 - [Configuration Command Examples](#)

An Introduction to Safeguard Engine Settings

Periodically, malicious hosts on the network will attack Switches by utilizing packet flooding (ARP Storm) or other attack methods and these attacks may increase the switch load beyond its capability. To alleviate this problem, the Safeguard Engine function was added to the DGS-6600.

The Safeguard Engine can help the overall operability of the Switch by minimizing the workload of the Switch while the attack is ongoing, thus making it capable to forward essential packets over its network in a limited bandwidth. The Safeguard Engine has two operating modes that can be configured by the user, Strict and Fuzzy. In Strict mode, when the Switch either (a) receives too many packets to process or (b) exerts too much memory, it will enter the Exhausted mode. When in this mode, the Switch will drop all ARP and IP broadcast packets and packets from un-trusted IP addresses for a calculated time interval. Every five seconds, the Safeguard Engine will check to see if there are too many packets flooding the Switch. If the threshold has been crossed, the Switch will initially stop all ingress ARP and IP broadcast packets and packets from un-trusted IP addresses for five seconds. After another five-second checking interval arrives, the Switch will again check the ingress flow of packets. If the flooding has stopped, the Switch will again begin accepting all packets. Yet, if the checking shows that there continues to be too many packets flooding the Switch, it will stop accepting all ARP and IP broadcast packets and packets from un-trusted IP addresses for double the time of the previous stop period. This doubling of time for stopping these packets will continue until the maximum time has been reached, which is 320 seconds and every stop from this point until a return to normal ingress flow would be 320 seconds. For a better understanding, see the figure below.

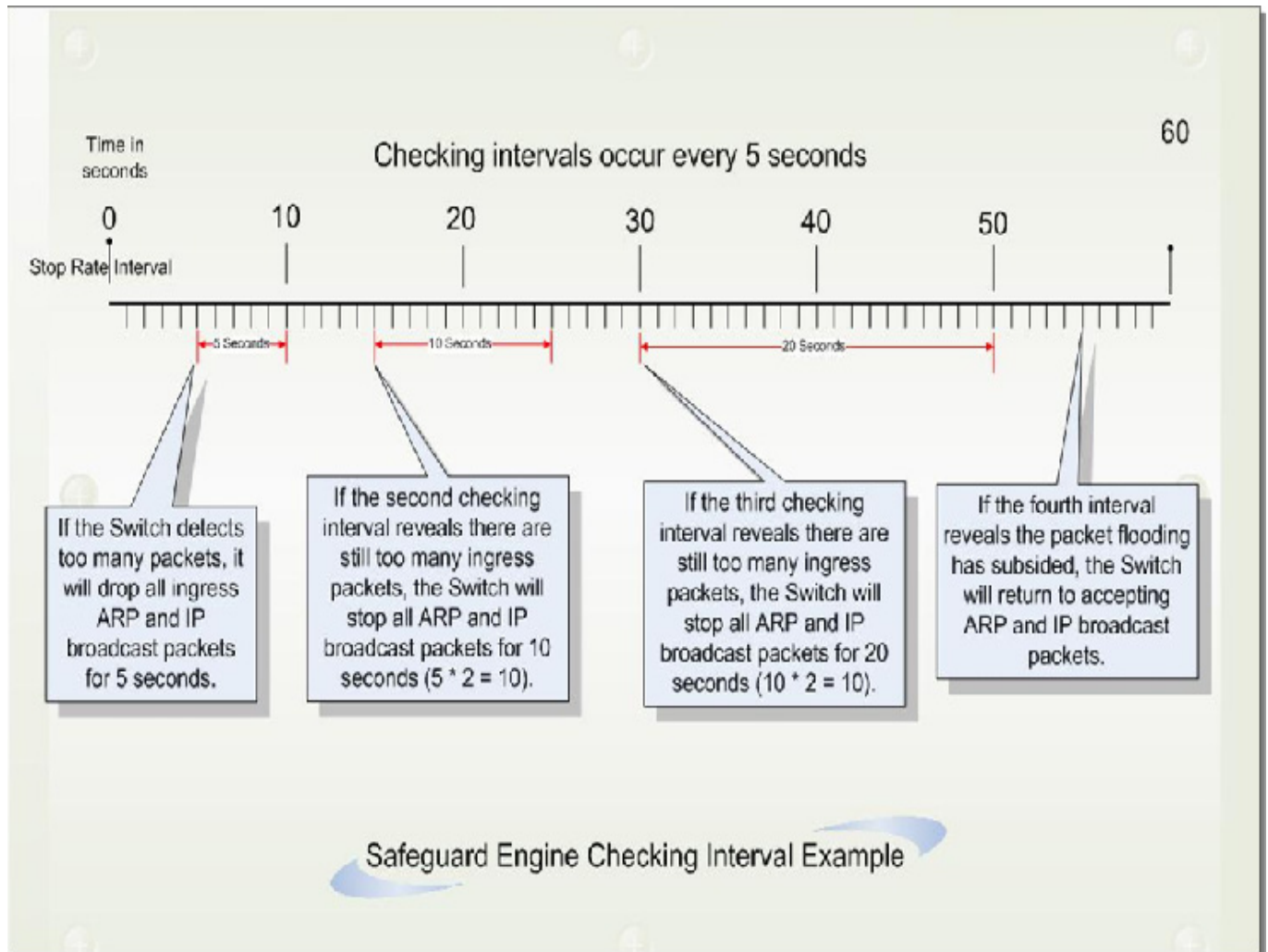

For every consecutive checking interval that reveals a packet flooding issue, the Switch will double the time it will discard ingress ARP and IP broadcast packets and packets from the illegal IP addresses. In the example above, the Switch doubled the time for dropping ARP and IP broadcast packets when consecutive flooding issues were detected at 5-second intervals. (First stop = 5 seconds, second stop = 10 seconds, third stop = 20 seconds) Once the flooding is no longer detected, the wait period for dropping ARP and IP broadcast packets will return to 5 seconds and the process will resume.

In Fuzzy mode, once the Safeguard Engine has entered the Exhausted mode, the Safeguard Engine will decrease the packet flow by half. After returning to Normal mode, the packet flow will be increased by 25%. The switch will then return to its interval checking and dynamically adjust the packet flow to avoid overload of the Switch.

Configuration Commands

Commands	Description
<code>clear cpu-protect counters [sub-interface [manage protocol route] type [PROTOCOLNAME]]</code>	Use this command to clear the cpu-protect related counters.
<code>cpu-protect type PROTOCOL-NAME pps RATE</code>	Use this command to configure the rate-limit of traffic destined to CPU by protocol type.
<code>cpu-protect safeguard threshold RISING-THRESHOLD FALLING-THRESHOLD</code>	Use this command to enable and configure the threshold for Safeguard Engine. Use the no form of this command to disable Safeguard Engine.
<code>cpu-protect sub-interface {manage protocol route} pps RATE</code>	Use this command to configure the rate-limit for traffic destined to CPU by subinterface type.
<code>show cpu-protect safeguard</code>	Use this command to display the settings and status of Safeguard Engine.
<code>show cpu-protect sub-interface {manage protocol route} [UNIT-ID]</code>	Use this command to show the rate-limit and statistics by sub-interface.

Configuration Command Examples

The following example shows how to clear all cpu-protect related statistics.

```
DGS-6600#clear cpu-protect counters
```

The following example shows how to set threshold of OSPF protocol packet as 100 packets per second.

```
DGS-6600(config)#cpu-protect type ospf pps 100
```

The following example shows how to configure the thresholds and enable Safeguard Engine. The rising and falling threshold are 60 and 40 respectively.

```
DGS-6600(config)#cpu-protect safeguard threshold 60 40
```

The following example shows how to set rate limit of manage packet group, and set threshold to 1000 packets per seconds.

```
DGS-6600(config)# cpu-protect sub-interface manage pps 1000
```

Chapter 48

Traffic Segmentation Configuration

Chapter Overview

The following topics are included in this chapter, please go to the topic for more detailed information:

- [Chapter Overview](#)
 - [An Introduction to Traffic Segmentation](#)
- [Traffic Segmentation Configuration Commands](#)
 - [Configuring Traffic Segmentation](#)
- [Configuration Examples](#)
 - [Traffic Segmentation Configuration Example](#)
- [Relations with Other Modules](#)
- [List of Constants and Default Settings](#)

An Introduction to Traffic Segmentation

Traffic segmentation is a feature that can be used to restrict the packet forwarding domain of a port. Unlike the VLAN function, which forwards packets based on VLAN IDs, traffic segmentation defines a list of ports that packets can be forwarded to. The VLAN function can determine the forwarding port for a packet, or the list of ports that a packet should be flooded to if the forwarding port is unknown. Implementing traffic segmentation restricts the ports that a forwarding port can send packets to.

Traffic Segmentation Configuration Commands

Configuring Traffic Segmentation

By default, no traffic segmentation port lists are defined for any ports. The default behavior specifies that packets received on a port can be forwarded to any other port. When traffic segmentation is configured on a port, the forwarding domain of the port is restricted to the ports specified in the forwarding list.

Use the following commands to configure and verify the traffic segmentation settings:

Command	Explanation
<code>traffic-segmentation forward interface INTERFACE-ID [, -]</code>	Segments or restricts the forwarding domain of a port to a set of specified ports.
<code>no traffic-segmentation [forward [interface INTERFACE-ID [, -]]]</code>	Used to remove a port or group of ports from the forwarding domain of a port.

Command	Explanation
<code>show traffic-segmentation [interface <i>INTERFACE-ID</i> [, -]]</code>	Used to display the traffic segmentation settings for a port or group of ports.

In the following example, the user configures traffic segmentation on Ethernet interface 4.48 so that the forwarding domain is restricted to Ethernet interfaces 4.1-4.8. The user then verifies the traffic segmentation settings on Ethernet interface 4.48:

```
DGS-6600:2>enable
DGS-6600:15#configure terminal
DGS-6600:15(config)#interface eth4.48
DGS-6600:15(config-if)#traffic-segmentation forward interface eth4.1-4.8
DGS-6600:15(config-if)#end
DGS-6600:15#show traffic-segmentation interface eth4.48
Interface          Forwarding Interface(s)
-----
eth4.48            *eth4.1, eth4.2,*eth4.3,*eth4.4,
                   eth4.5, *eth4.6, *eth4.7, *eth4.8
DGS-6600:15#
```

In the following example, the user removes Ethernet interface 4.8 from the forwarding domain of Ethernet interface 4.48 and verifies the configuration:

```
DGS-6600:2>enable
DGS-6600:15#configure terminal
DGS-6600:15(config)#interface eth4.48
DGS-6600:15(config-if)#no traffic-segmentation forward interface eth4.8
DGS-6600:15(config-if)#end
DGS-6600:15#show traffic-segmentation interface eth4.48
Interface          Forwarding Interface(s)
-----
eth4.48            *eth4.1, eth4.2,*eth4.3, eth4.4,
                   eth4.5,*eth4.6,*eth4.7
DGS-6600:15#
```

Configuration Examples

Traffic Segmentation Configuration Example

In the following example, we will configure traffic segmentation function so that:

- 1.All PCs can communicate to Server, e.g.
- 2.PCs at same "group" can communicate each other.
- 3.PCs at different segments CANNOT communicate each other.

Topology

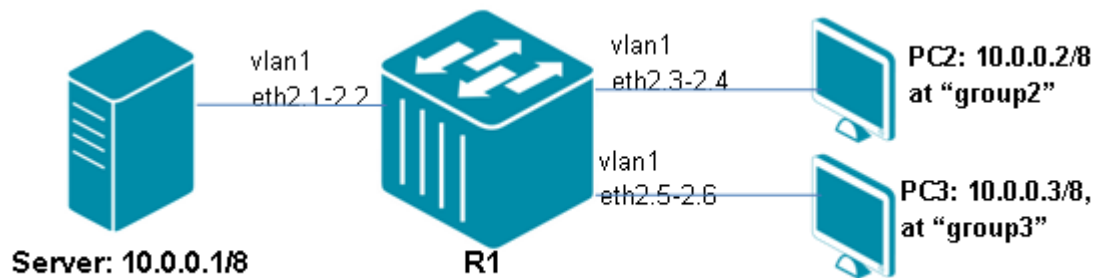

Figure 48-1 Traffic Segmentation Configuration Topology

R1 (Router 1) Configuration Steps

Step 1: Follow the example below,

```
DGS-6600:15(config)#interface range eth2.3-2.4
DGS-6600:15(config-if)# traffic-segmentation forward int eth2.1-2.4
DGS-6600:15(config-if)#interface range eth2.5-2.6
DGS-6600:15(config-if)#traffic-segmentation forward interface eth2.1-2.2,eth2.5-2.6
```

Verifying The Configuration

Step 1: Check R1 Traffic segment configuration by command:

```
DGS-6600:15(config-if)#show traffic-segmentation
Interface          Forwarding Interface(s)
-----
eth2.1             Forwarding to all ports
eth2.2             Forwarding to all ports
eth2.3             eth2.1, eth2.2, eth2.3, eth2.4
eth2.4             eth2.1, eth2.2, eth2.3, eth2.4
eth2.5             eth2.1, eth2.2, eth2.5, eth2.6
eth2.6             eth2.1, eth2.2, eth2.5, eth2.6
eth2.7             Forwarding to all ports
eth2.8             Forwarding to all ports
eth2.9             Forwarding to all ports
eth2.10            Forwarding to all ports
eth2.11            Forwarding to all ports
eth2.12            Forwarding to all ports
eth2.13            Forwarding to all ports
eth2.14            Forwarding to all ports
eth2.15            Forwarding to all ports
eth2.16            Forwarding to all ports
```

Step 2: It is possible to ping the various devices to determine configuration status:

PC2 (10.0.0.2/8) can ping Server (10.0.0.1/8), but cannot ping PC3 (10.0.0.3/8).

PC3 (10.0.0.3/8) can ping Server (10.0.0.1/8), but cannot ping PC2 (10.0.0.2/8).

Relations with Other Modules

- 1) Ports that are members of a port-channel cannot be specified as a forwarding interface.
- 2) If a port is currently a forwarding interface and becomes a member port of a channel group in the future, the port will no longer be an effective forwarding interface.
- 3) When a port is removed from a channel group, the port will become an effective forwarding interface.

List of Constants and Default Settings

Variable Name	Default Value
Traffic Segmentation	No segmentation. Packets received on a port can be flooded to all other ports.

Table 48-1 Default Variable Values



Part 9- Network Application

The following chapters are included in this volume:

- **DHCP Server Configuration**
- **DHCP Relay Configuration**
- **DHCPv6 Client Configuration**
- **sFlow**

Chapter 49

DHCP Server Configuration

Chapter Overview

The following topics are included in this chapter, please go to the topic for more detailed information:

- [Chapter Overview](#)
- [An Introduction to DHCP SERVER](#)
 - [Architecture](#)
 - [Operation concept](#)
 - [Selecting IP address pool](#)
 - [DHCP DISCOVER/REQUEST with 'requested IP address](#)
 - [Choosing IP address in address pool](#)
 - [Responding DHCP DISCOVER/REQUEST packet](#)
 - [Receiving DHCP DECLINE](#)
 - [Sending back DHCP packet to client](#)
 - [PING operation](#)
 - [Behavior under multi-netting](#)
 - [DHCP server and DHCP relay agent global mode](#)
 - [High availability in DHCP server](#)
- [DHCP Server Configuration Commands](#)
 - [Enabling the DHCP Server](#)
 - [Configuring the DHCP Address Pool Name and Entering DHCP Pool configuration Mode](#)
 - [Configuring the DHCP IP Address Pool and Subnet Mask](#)
 - [Configuring the Domain Name for a DHCP Client.](#)
 - [Configuring the IP Domain Name System Servers for the Client](#)
 - [Configuring the NetBIOS Windows Internet Naming Service Servers for the Client](#)
 - [Configuring the NetBIOS Node Type for the client](#)
 - [Configuring the Default Router for the Client](#)
 - [Configuring the Lease Duration of an IP Address](#)
 - [Configuring the DHCP Bootfile](#)
 - [Configuring DHCP Ping Packets](#)
 - [Monitoring and Maintaining the DHCP Server Functions](#)
- [Limitations](#)

An Introduction to DHCP SERVER

The DHCP (Dynamic Host Configuration Protocol), provides configuration parameters for hosts over the Internet. The DHCP works in the client/server mode. The DHCP server assigns IP addresses for the hosts dynamically and provides configuration parameters. The DHCP assigns IP address in

three ways: 1. Assign IP addresses automatically. The DHCP server assigns permanent IP addresses to the clients; 2. Assign IP addresses dynamically. The DHCP server assigns IP addresses that will expire after a period of time to the clients; 3. Configure IP addresses manually.

Network administrators can specify IP addresses and send specified IP addresses to the clients through the DHCP. Among the above mentioned three methods, only dynamic assignment allows reuse of the IP address that the client does not need any more.

Architecture

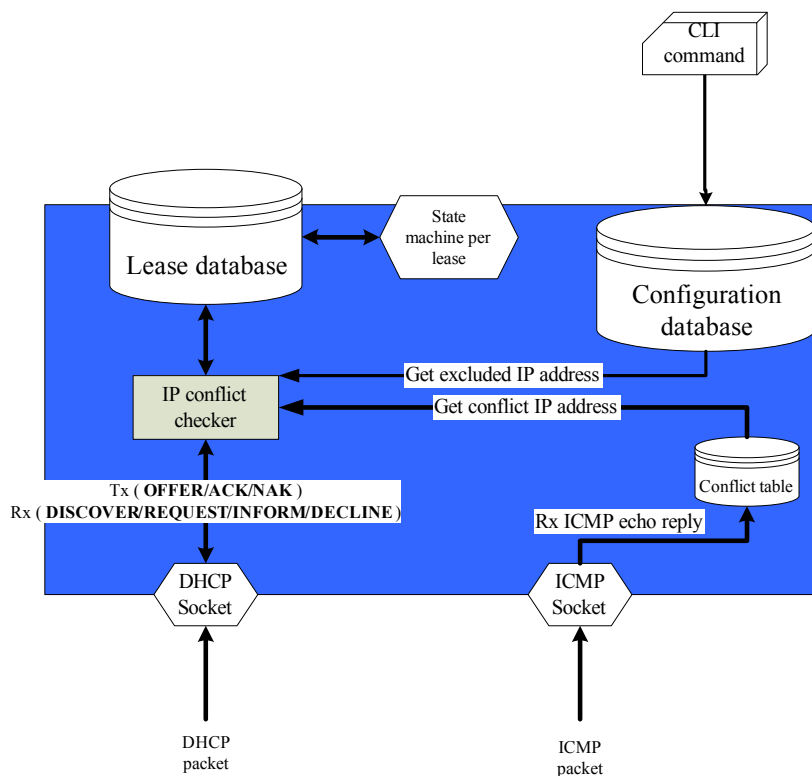

Lease database

The Lease database is used to store the allocations of IP address. It maintains the lease time and state for each entry.

IP conflict checker

The IP conflict checker checks if the ready-to-assign IP address is already occupied by other client or reserved by user configuration.

Conflict table

The Conflict table records the IP address detected and already used by other host via ICMP echo request/reply.

Operation concept

Configuring the binding address pool

Users can configure the address binding rules, within the address pool, to decide upon which criteria the IP addressed will be offered. The DGS-6600, provides 8 kinds of commands to configure these binding rules, which are listed below:

- based on hardware mac address

- based on client identifier
- based on customer vlan tag number
- based on service provider vlan tag number
- based on IP address of ingress interface
- based on IP address of relay agent
- based on vendor identifier class
- based on user class.

The binding rules (above) are all logical, operational conditions with other rules are set by other "based-on" commands. The ingress DHCPDISCOVER or DHCPREQUEST message must be checked according to the configuration. For example: If user configures an IP address '10.75.60.23' for client if client's MAC address matches 0001.03AA.BC3A, c-tag is 4 and s-tag is 5. Then if the incoming DHCPDISCOVER only matched the MAC address. Server will not assign the specific address '10.75.60.23' to this client. Instead server looks up and assignable address from other matched binding address pool for client. The address pool could also be configured to evaluate client identifier or to accept relay option 82 or not. If this address pool is configured as evaluate client identifier, server evaluates if the client identifier matches the client's hardware type and hardware address if client sends client identifier option. User could configure whether to accept DHCP messages according to if it contains remote ID or circuit ID in option 82 or not by command "accept dhcp relay agent".

Please note that the configured IP address may not be within the same subnet as the IP address of the interface which receives the DHCP messages from the MAC/client identifier mapped client. The system administrator must assure the valid route to the assigned IP address in routing table. If unraised, unexpected error result might occurred, e.g. finding if no routes while sending packets out.

Also, upon receiving DHCP RELEASE, the device will delete binding information in every address pool if one's IP matched 'ciaddr' in DHCP RELEASE if the 'server identifier' in DHCP RELEASE matched the interface address of the device.

Selecting IP address pool

When DHCP server received DISCOVER,REQUEST packet, it will first go checking if this incoming packet belongs to which address pool by its MAC address, client-identifier, vlan double tags and other criteria. Then server evaluates client identifier and content in option 82 to decide if to evaluate the content of packet.

Note: The DHCP pool name plays an important role. If the DHCP host's request meets the IP address binding rules at more than one DHCP address pools. The pool name in shortest name and lowest alphabet is the only pool allowed to offer the correct IP address to the host.

DHCP DISCOVER/REQUEST with 'requested IP address

While the device received DHCP message with 'requested IP address' option filled. It will check the validation of this requested IP address according to the following rules.

- Check if the requested IP is equal to the address in field 'giaddr' or addressed of local interfaces.
- Check if the requested IP is within the range of assignable IP address in address pool chosen by section 40-3-2.

- Check if the requested IP is conflicted with other host. (can be viewed by command 'show ip dhcp conflict')
- Check if the requested IP is already released to other clients.

If any of the above rules is not satisfied, then the device would drop this REQUEST packet and send DHCPNAK back to client as response to DHCPREQUEST or do nothing for DHCPDISCOVER.

Choosing IP address in address pool

Server will select the IP address from configured IP address which is not interface or broadcast IP address, not conflicted with IP address occupied by other host in address pool.

Responding DHCP DISCOVER/REQUEST packet

If the packet is a DHCP REQUEST packet and dropped by server, then server sends DHCP NAK back to client. If the packet passes the check, then server follows the section 40-3-4 to select the IP address. After selecting the IP address, the test for checking if the IP address has been mis-configured by other host is required. The test procedure will be done by sending ICMP echo packet out (refer to 40-3-8 PING operation). If the probing test is passed, server then denoted the tested IP address as available and will dispatch this IP address and wait for DHCP REQUEST from client. Server will wait 180 seconds for the DHCP REQUEST. After received REQUEST, then server sends out DHCP OFFER back to client if prior DHCP packet is DISCOVER or DHCP ACK if prior DHCP packet is REQUEST.

Receiving DHCP DECLINE

Server adds the IP address in "requested IP address" option within DHCP DECLINE packet into IP address conflict table and denoted the detection method as "GRATUITOUS ARP". The conflict table can be viewed by command 'show ip dhcp conflict'.

Sending back DHCP packet to client

If a received DHCP packet is broadcast from a client, then server will send DHCP messages back to client according to the field 'flags' or 'ciaddr' in prior received DHCP message. If the broadcast bit in 'flags' is not set and 'ciaddr' is zero, the device will send back via unicast. If broadcast bit is set, then the responding DHCP message will be sent via broadcast. On the other hand, the received packet is relayed by DHCP relay agent. Server then sends the response packet to DHCP relay agent via unicast.

PING operation

DHCP server pings a pool address before assigning the address to a requesting client. If the ping is unanswered, the DHCP server assumes (with a high probability) that the address is not in use and assigns the address to the requesting client. Otherwise, it means this tested IP address is already used by other host (probably misconfigured) and the device added this IP address into conflict table with marking the detection method as 'PING'. DHCP server in the device can specify the number of ping packets and how long server waits for a ping relay. (ping packets can be set by command 'ip dhcp ping packets count' and timeout value can be set by command 'ip dhcp ping packets')

Behavior under multi-netting

When the ingress interface is under multi-netting configuration, the DHCP server will always select the address pool takes primary IP address of ingress interface as ingress interface IP address. If your address pool is configured based on secondary IP address, the device will not select this address pool. Therefore, you might not be able to get DHCP OFFER.

DHCP server and DHCP relay agent global mode

In this device, DHCP server and DHCP relay can be enabled at the same time(DHCP server can be enabled by command "service dhcp" and relay can be enabled by command "ip dhcp relay") but function mutual exclusively. The device decides which module takes responsibility for the ingress DHCP packet by following rules:

- DHCP server and relay both enable:
- Ingress interface is configured relay server address (by command "ip dhcp relay address"):
- Action: Only DHCP relay agent functions for this packet.
- Ingress interface is not configured relay server address:
- Action: DHCP server handles this packet.

Note: If DHCP relay is not enabled and DHCP server is enabled, then server handles packets even if ingress interface is configured relay server address.

High availability in DHCP server

DHCP server in the device will synchronize its lease information for clients with internal high availability mechanism every 600 seconds and only lease information which already completes the DHCP handshake will be synchronized. And in the device, the maximum number of entries that will be synchronised is 12288 in current design.

DHCP Server Configuration Commands

Below are some of the DHCP server functions that can be configured. For a full list of commands and options please refer to the CLI guide.

- [Enabling the DHCP Server](#)
- [Configuring the DHCP Address Pool Name and Entering DHCP Pool configuration Mode](#)
- [Configuring the DHCP IP Address Pool and Subnet Mask](#)
- [Configuring the Domain Name for a DHCP Client.](#)
- [Configuring the IP Domain Name System Servers for the Client](#)
- [Configuring the NetBIOS Windows Internet Naming Service Servers for the Client](#)
- [Configuring the NetBIOS Node Type for the client](#)
- [Configuring the Default Router for the Client](#)
- [Configuring the Lease Duration of an IP Address](#)
- [Configuring the DHCP Bootfile](#)
- [Configuring DHCP Ping Packets](#)
- [Monitoring and Maintaining the DHCP Server Functions](#)

Enabling the DHCP Server

By default the DHCP server is disabled on the DGS-6600. To enable these features use the following command in the global configuration mode.

Command	Explanation
<code>service dhcp</code>	Use this command to enable DHCP server function. The DHCP server function is disabled by default.

The following example shows how to enable the DHCP server function.

```
DGS66600#enable
DGS6600#configure terminal
DGS6600(config)#service dhcp
```

Configuring a DHCP Address Pool

It is possible to configure a DHCP address pool with a name that is a symbolic string (such as "D-Link") or an integer (such as 0). Configuring a DHCP address pool also places the router in DHCP pool configuration mode—identified by the (dhcp-config)# prompt—In this mode, the administrator can configure pool parameters, for example, the IP subnet number and default router list. To configure a DHCP address pool, please use the following sections to better understand the configuration options.

Configuring the DHCP Address Pool Name and Entering DHCP Pool configuration Mode

To configure the DHCP address pool name and enter DHCP pool configuration mode, use the following command in the global configuration mode.

Command	Explanation
<code>ip dhcp pool <i>NAME</i></code>	Use this command to configure a DHCP address pool on a DHCP Server and enter the DHCP pool configuration mode. Use the no form of this command to remove the address pool.

The following example configures the address pool named "pool1".

```
DGS6600#configure terminal
DGS6600#(config)#ip dhcp pool pool1
```

Configuring the DHCP IP Address Pool and Subnet Mask

The following commands are used to define the IP address list and Subnet Mask for a DHCP pool. Reasonable IP addresses should be carefully defined for the pool and the subnet masks are only valid for the associated DHCP address pools only. For example, use the same network ID or same subnet for the all IP addresses. Specify a host by specifying the IP address explicitly or specify a range of IP addresses using a hyphen between the start IP address and end IP address. Both the

host and the range of IP addresses can be mixed together. Verify and confirm that the IP addresses chosen are part of the same network.

Command	Explanation
<code>ip address-list IP-ADDRESS [, -]</code>	Use this command to specify the IP address range in a DHCP address pool and one of which is allowed to be bound with a DHCP client. Use the no form of this command to remove the range of IP addresses from the DHCP address pool.
<code>subnet-mask MASK</code>	Use this command to configure the subnet mask for a DHCP address pool of the DHCP Server. Use the no form of this command to restore the configuration of a subnet mask to the default mask 255.255.255.0.

This example shows how to configure the IP address range for pool1 in the IP address range of 10.1.1.1~10.1.1.255, exclude the address 10.1.1.200 from the pool and configure 255.0.0.0 as the DHCP pool's subnet mask.

```
DGS6600#configure terminal
DGS6600(config)#ip dhcp pool pool1
DGS6600(config-dhcp)#ip address-list 10.1.1.1-10.1.1.255
DGS6600(config-dhcp)#no ip address-list 10.1.1.200
DGS6600(config-dhcp)#subnet-mask 255.0.0.0
```

Configuring the Domain Name for a DHCP Client.

The domain name for a DHCP client places the client in the general grouping of networks, making up the domain. To configure a domain name string for the client, use the domain-name command. Use the no form of this command to remove the domain name.

Command	Explanation
<code>domain-name DOMAIN</code>	This command configures the domain name for a DHCP client. Use the no form of this command to remove the domain name.

This example shows how to specify domain name as "dlink.com" in a DHCP address pool named "pool1".

```
DGS6600#configure terminal
DGS6600(config)#ip dhcp pool pool1
DGS6600(config-dhcp)#domain-name dlink.com
```

Configuring the IP Domain Name System Servers for the Client

DHCP clients query DNS IP servers when they need to correlate host names to IP addresses. When configuring DNS IP servers it is important to note that servers are listed in order of preference, if the number of servers is more than 1, then execute the following command multiple times with different

server IP addresses. To configure the IP address list of DNS servers available to DHCP clients under the DHCP pool configuration mode use the following command.

Command	Explanation
dns-server <i>IP-ADDRESS</i>	This command configures the IP address list of DNS servers available to DHCP clients. Use the no form of this command to remove the DNS server list.

This example shows how to specify 10.1.1.1 as the IP address of DNS server in a DHCP address pool named "pool1".

```
DGS6600#configure terminal
DGS6600(config)#ip dhcp pool pool1
DGS6600(config-dhcp)#dns-server 10.1.1.1
```

Configuring the NetBIOS Windows Internet Naming Service Servers for the Client

Windows Internet Naming Service (WINS) is a name resolution service that Microsoft DHCP clients use to match host names to IP addresses in a grouping of networks. It possible to configure a primary and secondary WINS server on the DGS-6600 Series Switch. The primary preference is the old WINS. The maximum number of configurable WINS servers is dependent on each project. To configure the NetBIOS WINS servers available to a Microsoft DHCP client, use the following command in DHCP pool configuration mode:

Command	Explanation
netbios wins-server <i>IP-ADDRESS</i>	To configure the IP address of a WINS server for Microsoft Dynamic Host Configuration Protocol (DHCP) clients. Use the no form of this command to remove the configuration of WINS server.

The following example configures a primary WINS server as 10.1.1.100, a secondary WINS server as 10.1.1.200 in DHCP pool "pool1"

```
DGS6600#configure terminal
DGS6600(config)#ip dhcp pool pool1
DGS6600(config-dhcp)#netbios wins-server 10.1.1.100
DGS6600(config-dhcp)#netbios wins-server 10.1.1.200
```

Configuring the NetBIOS Node Type for the client

The NetBIOS node type for Microsoft DHCP clients can be one of four settings: broadcast, peer-to-peer, mixed, or hybrid. the recommended type is h - (Hybrid) mode. It determines what methods NetBios will use to register and resolve names.

- b-node - The broadcast system uses broadcasts.
- p-node - A p-node system uses only point-to-point name queries to a name server (WINS).
- m-node - An m-node system broadcasts first, and then queries the name server.
- Hybrid - A hybrid system queries the name server first, and then broadcasts.

Resolution through LMHOSTS and/or Domain Name Service (DNS), if enabled, will follow these methods. To configure the NetBIOS node type for a Microsoft DHCP, use the following command in DHCP pool configuration mode:

Command	Explanation
<code>netbios node-type <i>NTYPE</i></code>	This command is used to configure the NetBIOS node's type for Microsoft Dynamic Host Configuration Protocol (DHCP) clients. Use the no form of this command to restore the configuration of the NetBIOS node's type back to default configuration (Hybrid).

The following is sample of configuring the Netbios node type as h-node.

```
DGS6600#configure terminal
DGS6600(config)#ip dhcp pool pool1
DGS6600(config-dhcp)#netbios node-type h-node
```

Configuring the Default Router for the Client

After a DHCP client has booted, the client begins sending packets to its default router. The IP address of the default router should be on the same subnet as the client. If the number of servers is more than one, then execute this command multiple times with different server IP addresses. Routers are listed in order of preference (address1 is the most preferred router, address2 is the next most preferred router, and so on). To specify a default router for a DHCP client, use the following command in DHCP pool configuration mode:

Command	Explanation
<code>default-router <i>IP-ADDRESS</i></code>	This command specifies the default router list for a DHCP client. Use the no form of this command to remove the default router list.

This example shows how to specify 10.1.1.1 as the IP address of default-router in DHCP address pool "pool1".

```
DGS6600#configure terminal
DGS6600(config)#ip dhcp pool pool1
DGS6600(config-dhcp)#default-router 10.1.1.1
```

Configuring the Lease Duration of an IP Address

By default, each IP address assigned by a DHCP Server comes with a 1 day lease. It is possible to change the lease time for an IP address, please use the following command in DHCP pool configuration mode to alter the lease duration time:

Command	Explanation
<code>lease {<i>DAYS</i> [<i>HOURS</i> <i>MINUTES</i>] <i>infinite</i>}</code>	Use this command to configure the lease duration of an IP address that is assigned from a DHCP server to a client. Use the no form of this command to restore the default value.

The following is sample of configuring the lease, in address pool "pool1", to 1 hour.

```
DGS6600#configure terminal
DGS6600(config)#ip dhcp pool pool1
DGS6600(config-dhcp)#lease 0 1
```

Configuring the DHCP Bootfile

The boot file is used to store the boot image for the DHCP client. Use the following command is possible to specify the name of the default boot image for a (DHCP) client. The boot image can be located on the same DHCP server or other network servers. To specify a boot file for the DHCP client, use the following command in DHCP pool configuration mode:

Command	Explanation
bootfile <i>URL</i>	Use this command to specify the name of the default boot image for a Dynamic Host Configuration Protocol (DHCP) client. The boot image can be located in the same DHCP server or other network servers.

The following example specifies *mdubootfile* as the name of the boot file for DHCP pool1.

```
DGS6600#enable
DGS6600#configure terminal
DGS6600(config)#ip dhcp pool pool1
DGS6600(config-dhcp)#bootfile \dgs-6600\bootimage\mdubootfile.bin
```

Configuring DHCP Ping Packets

By default, the DHCP Server pings a pool address twice before assigning a particular address to a requesting client, with the DHCP server waiting 500 milliseconds before timing out the ping packet. If the ping is unanswered, the DHCP Server assumes (with a high probability) that the address is not in use and assigns the address to the requesting client. To change the number of ping packets and the length of time before a timeout, use the following command in global configuration mode:

Command	Explanation
ip dhcp ping packets <i>COUNT</i>	Use this command to specify the number of packets that the DHCP server will send as a part of the ping operation. Use the no form of this command to prevent the server from pinging pool addresses.
ip dhcp ping timeout <i>MILLISECONDS</i>	Use this command to specify how long the DHCP server will wait for the ping reply from a pool address. Use the no form of this command to restore the wait time for the ping reply back to the default value (500ms).

The following is a sample of configuring the number of ping packets as 3 and the timeout of 100 milliseconds.

```
DGS6600#configure terminal
DGS6600(config)#ip dhcp ping packets 3
DGS6600(config)#ip dhcp ping timeout 100
```

Monitoring and Maintaining the DHCP Server Functions

To clear or display Server commands and information, please use the following commands :

Command	Explanation
<code>clear ip dhcp binding [pool NAME] [ADDRESS]</code>	Use this command to delete an address binding from the DHCP Server database.
<code>clear ip dhcp conflict [pool NAME] [ADDRESS]</code>	Use this command to clear an address conflict from the DHCP server database.
<code>clear ip dhcp server statistics</code>	Use this command to reset all Dynamic Host Configuration Protocol (DHCP) server counters.
<code>show ip dhcp binding [pool NAME] [ADDRESS]</code>	Use this command to display the current status of address bindings on the DHCP Server.
<code>show ip dhcp conflict [pool NAME] [ADDRESS]</code>	Use this command to display the conflict IP addresses while a DHCP Server attempts to assign the IP addresses for a client.
<code>show ip dhcp pool [NAME]</code>	Use this command to display information about the Dynamic Host Configuration Protocol (DHCP) address pools.
<code>show ip dhcp server</code>	Use this command to display the current status of DHCP server.
<code>show ip dhcp server statistics</code>	This command to display Dynamic Host Configuration Protocol (DHCP) server statistics.

The following example deletes address binding 10.13.2.99 from the address pool named pool1, deletes all the address conflicts from the address pool named pool1 and resets all DHCP counters to zero.

```
DGS6600#clear ip dhcp pool pool1 binding 10.13.2.99
DGS6600#clear ip dhcp conflict pool pool1
DGS6600#clear ip dhcp server statistics
```

The following example shows the binding status of the entire address pool1.

```
DGS6600# show ip dhcp binding pool pool1
IP address      Hardware address      Lease start           Lease expiration
-----
10.1.1.1        00b8.3493.32b5        18:38:56, 2012-12-28 18:38:56, 2012-12-29
10.1.9.1        00b8.3493.32b5        18:38:56, 2012-12-28 18:38:56, 2012-12-29
10.1.11.10     00b8.3493.32b5        18:38:56, 2012-12-28 18:38:56, 2012-12-29
```

The following example shows the conflict status of all DHCP IP address pools.

```
DGS6600#show ip dhcp conflict
Pool name: pool1
IP address Detected Method Detection time
-----
10.1.1.1 Ping 18:38:56, 2012-12-28

Pool name: pool2
IP address Detected Method Detection time
-----
172.1.1.1 Gratuitous ARP 18:38:56, 2012-12-28
```

The following example shows DHCP address pool information for an On-Demand Address Pool (ODAP), pool 1. The table below describes the significant fields in the display.

```
DGS6600#show ip dhcp pool1
Pool name: pool1
  Accept client ID: Yes
  Accept relay Agent: No
  Boot file: boot.bin
  Default router: 10.1.2.1
  DNS server: 10.1.2.1
  Domain name: alphanetworks.com
  Lease: 3600 seconds
  NetBIOS node type: hybrid
  NetBIOS scpoe ID: alpha
  Next server: 10.1.2.1
  Subnet:255.255.0.0
  Based-on mac-address:00:01:02:03:04:05-00:01:02:03:04:FF
  Based-on mac-address:00:08:02:03:04:05
  Based-on mac-address:00:09:02:03:04:05
  Based-on client ID: 0x01000102030405
  Based-on C-VID: 2
  Based-on C-VID: 10-20
  Based-on S-VID: 100
  Based-on S-VID: 300-400
  Based-on interface ip-address: 10.0.3.1
  Based-on relay-ip-address: 10.5.3.1
  Based-on vendor-class: Alpha
  Based-on user-class: MSFT

IP addresses: total 511
10.0.0.1
10.0.1.1-10.0.1.255
10.0.3.1-10.0.3.255
Number of leased address: 100
Number of conflict addresses: 2
DGS6600#
```

This example shows how to display the status of DHCP server.

```
DGS6600# show ip dhcp server
DHCP server: Disable
Ping packets number: 3
Ping timeout: 500 ms
```

List of DHCP server configured address pool

pool1	pool2	pool3	pool4
pool5	pool6	pool7	pool8
pool9	pool10	pool11	pool12

The following example resets all DHCP counters to zero. The table below describes the significant fields in the display.

```
DGS6600# show ip dhcp server statistics
Address pools      2
Malformed messages 0
Renew messages     0

Message           Received
BOOTREQUEST      12
DHCPDISCOVER     200
DHCPREQUEST      178
DHCPDECLINE      0
DHCPRELEASE      0
DHCPINFORM       0

Message           Sent
BOOTREPLY        12
DHCPOFFER        190
DHCPACK          172
DHCPNAK          6
DGS6600#
```

Limitations

Table 49-1

Parameter Name	Maximum Number	Description
Default Router	8	DHCP server fills the option "default router" with a list of IP addresses for routers on the client's subnet up to 8.
DNS Server	8	DHCP server fills the option "DNS server" with a list of IP addresses for servers on the client's subnet up to 8.
WINS Server	8	DHCP server fills the option "WINS server" with a list of IP addresses for servers on the client's subnet up to 8.
Address Pool	12288	Maximum number of configurable address pools.
Supported Client Number	12288	Affordable maximum number of clients.

Chapter 50

DHCP Relay Configuration

Chapter Overview

The following topics are included in this chapter, please go to the topic for more detailed information:

- [Chapter Overview](#)
- [An Introduction to DHCP Relay Agent Operation](#)
- [DHCP Relay Configuration Commands](#)
 - [Enabling the DHCP Relay Agent Service](#)
 - [Specifying the Maximum Number of DHCP Relay Hops](#)
 - [Specifying a DHCP Relay Address](#)
- [Configuring the Relay Agent Information Option](#)
 - [Enabling the Insertion of the Relay Agent Information Option](#)
 - [Specifying the Policy for Inserting the Relay Agent Information Option](#)
 - [Checking the Validity of Reply Messages](#)
- [Configuring Trusted Interfaces](#)
 - [Trusting a Single Interface](#)
 - [Displaying Trusted Interfaces](#)
 - [Displaying the Relay Agent Configuration](#)
- [List of Constants and Default Settings](#)
- [List of Constants and Default Settings](#)

An Introduction to DHCP Relay Agent Operation

The DHCP relay agent is a device that is located between a host and a DHCP server. The DHCP relay agent can be used to forward DHCP packets sent from a client to a server on a different network segment. After the DHCP packet has been received by the DHCP server, the DHCP relay agent offers the reply packet sent by the server back to the client.

In order to provide the information needed by the DHCP server to assign an address or other parameters to the user, the relay agent can be configured to do the following:

- Insert the relay agent information, such as the option 82 information, into the client packet while the packet is being relayed to the server.
- Remove the relay agent information from the reply packet as the packet is sent to the client.

DHCP Relay Operation

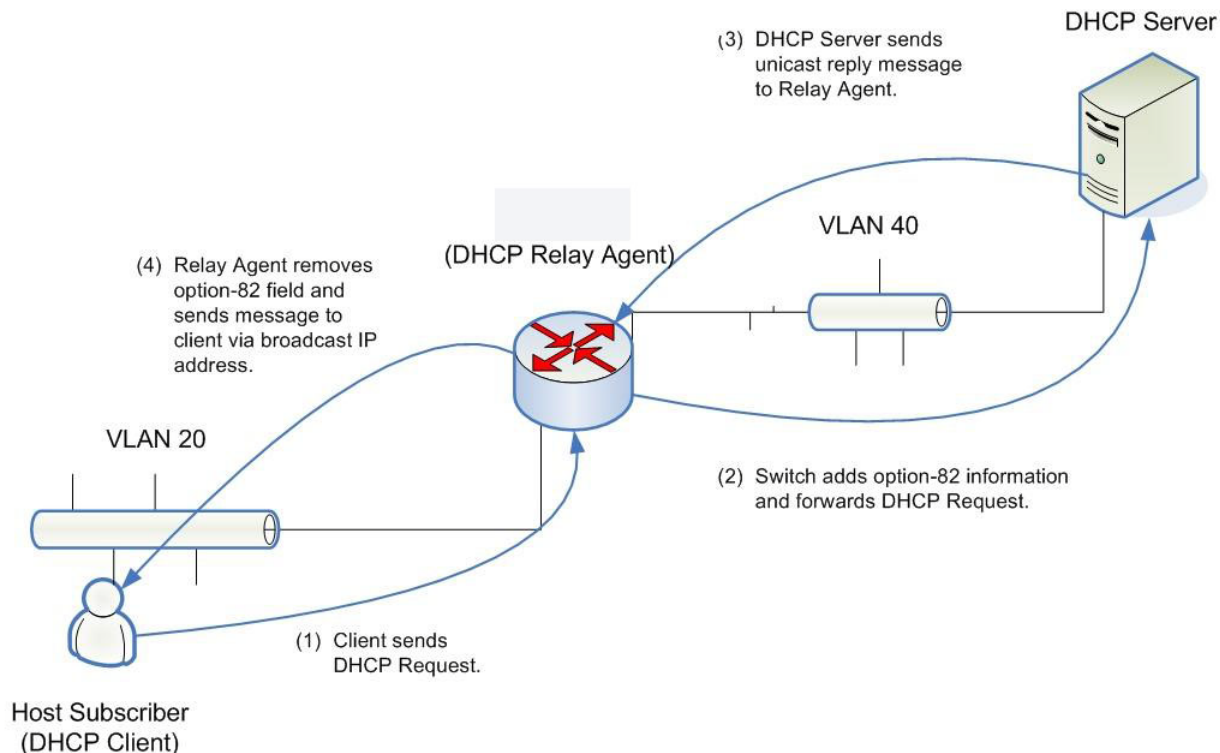

Figure 50-1 DHCP Relay Operation

The DHCP 82 option contains two sub-options which are the circuit ID sub-option and the remote ID sub-option.

The circuit ID is encoded based on the following format:

Byte	1	2	3	4	5	6	7	8
Field	Sub-option Type	Length	Circuit ID Type	Length	VLAN ID		Module #	Port #
Value	1	6	0	4	XXXX		X	X

VLAN ID: The incoming VLAN ID of the DHCP client packet.

Module #: For a standalone switch, the Module # is always 0. For a stackable switch, the Module # is the Unit ID.

Port #: The receiving port number of the DHCP client packet, port number starts from 1.

Figure 50-2 Circuit ID Sub-Option Format

The remote ID sub-option is encoded based on the following format:

Byte	1	2	3	4	5	6	7	8	9	10
Field	Sub-option Type	Length	Remote ID Type	Length	MAC Address					
Value	2	8	0	6	M1	M2	M3	M4	M5	M6

MAC address: The Switch's system MAC address.

Figure 50-3 Remote ID Sub-Option Format

When a message is being relayed by the relay agent, several messages are exchanged between the relay agent and the DHCP server in the following sequence:

- 1) The client sends a DHCP message with a broadcast destination IP address.
- 2) The relay agent then intercepts the DHCP message, inserts the option-82 field in the message (if configured to do so), populates the gateway IP address field in the message with its own IP address, and sends a unicast message to the DHCP server.
- 3) When the DHCP server receives the message, the message is processed and a unicast reply message is sent to the relay agent.
- 4) When the relay agent receives the message, the option-82 field is removed from the message (if configured to do so) and the message is sent back to the client via a broadcast IP address.

DHCP Relay Configuration Commands

- [Enabling the DHCP Relay Agent Service](#)
- [Specifying the Maximum Number of DHCP Relay Hops](#)
- [Specifying a DHCP Relay Address](#)

Enabling the DHCP Relay Agent Service

Use the following command in global configuration mode to globally enable the relay agent on the Switch:

Command	Explanation
<code>ip dhcp relay</code>	Globally enables the DHCP relay agent service.

In the following example, the user globally enables the DHCP relay agent service:

```
DGS-6600:2>enable
DGS-6600:15#configure terminal
DGS-6600:15 (config)#ip dhcp relay
DGS-6600:15 (config)#end
```

Specifying the Maximum Number of DHCP Relay Hops

A DHCP client may be relayed by relay agents over multiple hops before arriving at the DHCP server. The user can use the following command in global configuration mode to restrict the maximum number of relay agents that a DHCP message can traverse:

Command	Explanation
<code>ip dhcp relay hops <i>HOP-COUNT</i></code>	Specifies the maximum number of relay agents that a DHCP message can traverse.

In the following example, the user sets the maximum number of relay hops that a DHCP packet can traverse to 5:

```
DGS-6600:2>enable
DGS-6600:15#configure terminal
DGS-6600:15 (config)#ip dhcp relay hops 5
DGS-6600:15 (config)#end
```

Specifying a DHCP Relay Address

The user can configure DHCP relay addresses on IP interfaces that need to relay DHCP client messages. When the IP addresses of DHCP servers are configured on an interface, any DHCP client messages received on this interface will be relayed to all the DHCP servers specified in this command.

Enter the following command in interface VLAN mode to specify the IP address of a DHCP server that will be forwarded all DHCP request packets received on the specified VLAN interface:

Command	Explanation
<code>ip dhcp relay address IP-ADDRESS</code>	Specifies the IP address of a DHCP server that will be forwarded all DHCP request packets received on the specified VLAN interface.

In the following example, the user enables the DHCP relay function and configures interface VLAN 100 to use a DHCP server with the IP address 10.1.1.1. After configuring this command, all DHCP packets received on VLAN 100 will also be relayed to the DHCP server with the IP address 10.1.1.1:

```
DGS-6600:2>enable
DGS-6600:15#configure terminal
DGS-6600:15 (config)#ip dhcp relay
DGS-6600:15 (config)#interface vlan100
DGS-6600:15 (config-if)#ip dhcp relay address 10.1.1.1
DGS-6600:15 (config-if)#end
```

Configuring the Relay Agent Information Option

The following topics are included in this section:

- [Enabling the Insertion of the Relay Agent Information Option](#)
- [Specifying the Policy for Inserting the Relay Agent Information Option](#)
- [Checking the Validity of Reply Messages](#)

Enabling the Insertion of the Relay Agent Information Option

The user can enable the insertion of the option-82 field in a message when relaying a DHCP message.

Enter the following command in global configuration mode to globally enable the insertion of the relay agent information option (option 82) in an IP packet:

Command	Explanation
<code>ip dhcp relay information option</code>	Enables the insertion of the relay agent information option.

In the following example, the user enables the insertion of the relay information option (option-82) for relayed DHCP request packets:

```
DGS-6600:2>enable
DGS-6600:15#configure terminal
DGS-6600:15(config)#ip dhcp relay information option
DGS-6600:15(config)#end
```

Specifying the Policy for Inserting the Relay Agent Information Option

If the device is already configured to insert the relay agent information option, but the received DHCP message that will be relayed already has the option-82 field encoded, the user can specify the action for the message. The user can specify to drop the message, leave the option-82 field untouched, or replace the field with a new option-82 value.

Enter the following command in global configuration mode to configure the information re-forwarding policy for the DHCP relay agent:

Command	Explanation
<code>ip dhcp relay information policy {drop keep replace}</code>	Configures the information re-forwarding policy for the DHCP relay agent.

In the following example, the user sets the IP DHCP relay information policy to drop any DHCP request packets that were relayed by other DHCP agents and already have the DHCP option-82 inserted:

```
DGS-6600:2>enable
DGS-6600:15#configure terminal
DGS-6600:15(config)#ip dhcp relay information policy drop
DGS-6600:15(config)#end
```

Checking the Validity of Reply Messages

By default, the relay agent will check the validity of the option-82 field in the reply DHCP message and drop the invalid messages. The user can disable this checking function and forward all of the relay messages.

The following commands are used to specify if the validity of the DHCP reply messages should be checked or not:

Command	Explanation
<code>no ip dhcp relay information check</code>	Specifies that the validity of reply messages should not be checked by the Switch.
<code>ip dhcp relay information check</code>	Specifies that the validity of reply messages should be checked by the Switch.

In the following example, the user enables the DHCP relay agent to check the validity of reply packets:

```
DGS-6600:2>enable
DGS-6600:15#configure terminal
DGS-6600:15 (config)#ip dhcp relay information check
DGS-6600:15 (config)#end
```

Configuring Trusted Interfaces

An interface may receive a DHCP message that has the relay information encoded, but has a value of zero in the gateway IP address field. This type of message may be generated by sources that are trying to spoof the DHCP server. The user can configure interfaces to be un-trusted, meaning that any DHCP message received from the un-trusted interface will be dropped as they could be spoofed messages. If an interface is configured as a trusted interface, all messages from the interface will be trusted and forwarded by the Switch.

- [Trusting/Un-Trusting All Interfaces](#)
- [Trusting a Single Interface](#)
- [Displaying Trusted Interfaces](#)
- [Displaying the Relay Agent Configuration](#)

Trusting/Un-Trusting All Interfaces

The user can use the following command in global configuration mode to trust all interfaces on the Switch:

Command	Explanation
<code>ip dhcp relay information trust-all</code>	Specifies that all interfaces will be trusted.

In the following example, the user enables the DHCP relay agent to trust all interfaces that already have the relay agent information option present in the packet:

```
DGS-6600:2>enable
DGS-6600:15#configure terminal
DGS-6600:15 (config)#ip dhcp relay information trust-all
DGS-6600:15 (config)#end
```

Trusting a Single Interface

The user can use the following command in VLAN interface configuration mode to trust a specific VLAN interface:

Command	Explanation
<code>ip dhcp relay information trusted</code>	Specifies that the VLAN interface will be trusted.

In the following example, the user enables the DHCP relay agent to trust all the packets originating from the VLAN100 interface that already have the relay agent information option present in the packet:

```
DGS-6600:2>enable
DGS-6600:15#configure terminal
DGS-6600:15 (config) #interface vlan100
DGS-6600:15 (config-if) #ip dhcp relay information trusted
DGS-6600:15 (config-if) #end
```

Displaying Trusted Interfaces

The following command can be used to display all the interfaces that are configured as trusted sources for the DHCP relay option:

Command	Explanation
<code>show ip dhcp relay information trusted-sources</code>	Displays all the interfaces that have been configured as trusted sources for the DHCP relay option.

In the following example, the user displays all the interfaces that have been configured as trusted sources for the DHCP relay option:

```
DGS-6600:2>show ip dhcp relay information trusted-sources

List of trusted sources of relay agent information option:
vlan1          vlan100          vlan200          vlan300
vlan400        vlan500          vlan600          vlan700
vlan800
Total Entries: 9
DGS-6600:2>
```

Displaying the Relay Agent Configuration

The user can use the following command to display the IP DHCP relay agent configuration:

Command	Explanation
<code>show ip dhcp relay</code>	Displays the IP DHCP relay agent configuration.

In the following example, the user displays the DHCP relay agent configuration:

```
DGS-6600:2>show ip dhcp relay

DHCP relay                :enabled
Relay Hop Count          :5
DHCP Relay Information Option :disabled
DHCP Relay Information Policy :drop
DHCP Relay Information Check Reply :enabled
DHCP Relay Information Trusted :enabled

vlan100 Relay IP Address
 10.1.1.1 0.0.0.0 0.0.0.0 0.0.0.0

List of Trusted sources of relay agent information option:
vlan1          vlan100          vlan200          vlan300

vlan400          vlan500          vlan600          vlan700

vlan800

DGS-6600:2>
```

List of Constants and Default Settings

Constant Name	Value
Number of Supported DHCP Server Addresses per Interface	4

Table 50-1 Constants Values

Variable Name	Default Value
IP DHCP Relay	Disabled
IP DHCP Relay Hops	4
IP DHCP Relay Information Check	Enabled
IP DHCP Relay Information Option	Disabled
IP DHCP Relay Information Policy	Replace
Interface Trusted Interface	Un-trusted

Table 50-2 Default Variable Values

Chapter 51

DHCPv6 Client Configuration

Chapter Overview

The following topics are included in this chapter, please go to the topic for more detailed information:

- [Chapter Overview](#)
- [An Introduction to the DHCPv6 Client](#)
 - [Operation concept](#)
 - [Protocol and Addressing](#)
 - [Prefix Delegation](#)
 - [Address Information Refresh](#)
- [DHCPv6 Configurations Commands](#)
 - [Enabling the IPv6 DHCP client function](#)
 - [Configuring a DHCPv6 Client minimum refresh time](#)
 - [Configuring an IPv6 address based on an IPv6 general prefix](#)
 - [Showing an ipv6 general prefix](#)
 - [Showing ipv6 dhcp configurations](#)
- [Default Settings](#)
- [Restriction/Limitation](#)

An Introduction to the DHCPv6 Client

Dynamic Host Configuration Protocol for IPv6 (DHCPv6) is designed to provide dynamic IPv6 addressing and other information configurations. Although the IPv6's stateless address auto configuration removes the primary motivation for DHCP in IPv4, DHCPv6 can still be used to assign addresses if the network administrator desires more control over addressing. DHCPv6 can also be used to distribute information which is not otherwise discoverable; for example the DNS server. Although, DNS addresses can also be sent through the Neighbor Discovery Protocol.

DHCPv6 is a client/server protocol. DHCPv6 client can provide a device with an address and other configuration information assigned by a DHCPv6 server. The DHCPv6 client is a node that initiates requests on a link to obtain configuration parameters from one or more DHCPv6 servers.

Operation concept

What follows is an example of how A DHCPv6 client (abbreviate to "client" below) requests an address in a client-server exchange involving four messages.

To request the assignment of one or more IPv6 address the client first locates a DHCPv6 server (abbreviate to "server" below) and then requests the assignment of addresses and other configuration information from the server. The client sends a Solicit message to the ALL_DHCP_Relay_Agents_and_Servers address (i.e. FF02::1:2) to find any available servers. Any server that meets the client's requirements responds with an advertise message. The client then chooses one of the servers and sends a request message to the server asking for a confirmed

assignment of addresses and other configuration information. The server responds with a Reply message that either contains the confirmed addresses or configuration.

Meanwhile, also as illustrated in the following diagram, the client sends a renew message to the server to extend the lifetimes associated with its addresses, allowing the client to continue using the specific addresses without interruption.

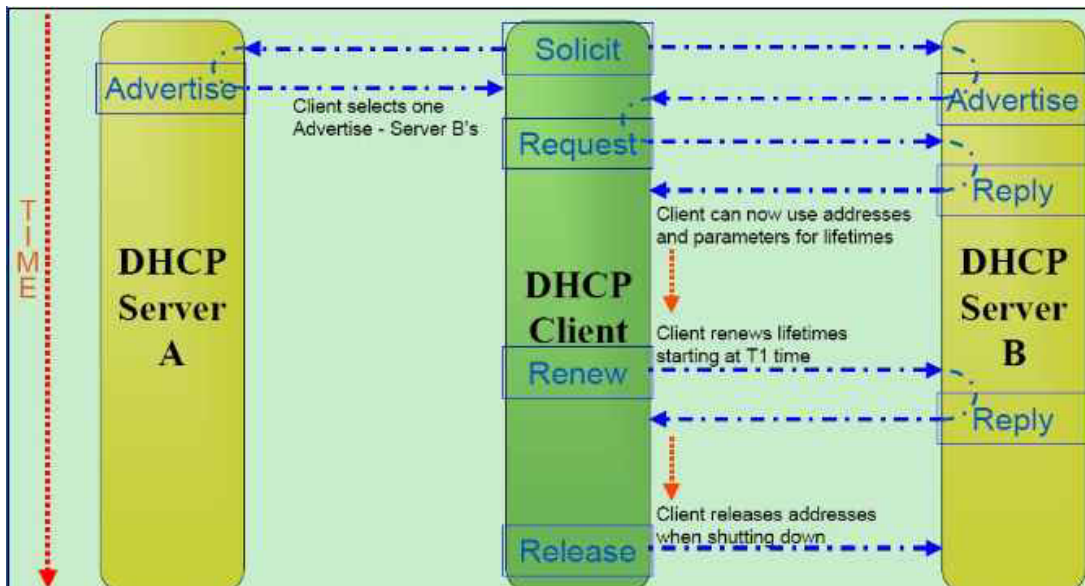

Figure 51-1

Protocol and Addressing

Clients and servers exchange DHCPv6 messages using UDP. The client uses a link-local address or addresses determined through other mechanisms for transmitting and receiving DHCPv6 messages.

The DHCPv6 server receives messages from clients using a reserved link-scoped multicast address, called ALL_DHCP_Relay_Agents_and_Servers (FF02::1:2). A DHCPv6 client transmits most messages to this reserved multicast address, so that client needs not to be configured with the address or addresses of DHCPv6 servers.

Once the client has determined the address of a server, it may send messages directly to the server using unicast.

DHCPv6 clients listen to UDP port number 546, and DHCPv6 servers listen to UDP port number 547.

Table 51-1

Information of sending packet	DHCPv6 V Client	DHCPv6 Server
DA IP of sending packet	FF02::1:2	Client link-local address
SA IP of sending packet	Client link-local address	Server IP address
UDP port of sending packet	547	546

Basic Message Format

All DHCPv6 messages sent between clients and servers share an identical fixed format header and a variable format area for options. The following diagram illustrates the format of a DHCPv6 message sent between clients and servers:

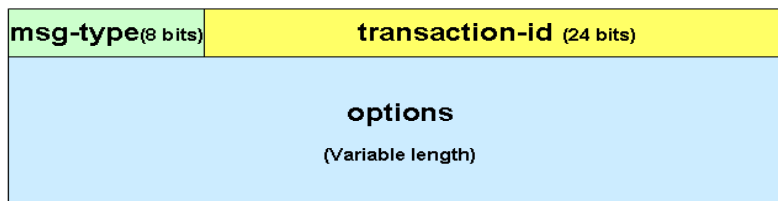

Message Types

Table 51-2

Message Name	Message Value	Message Description
SOLICIT	1	A client sends a Solicit message to locate servers.
ADVERTISE	2	A Server sends an advertise message to indicate that it is available for DHCPv6 Services, in response to a solicit message received from a client.
REQUEST	3	A client sends a request message to request configuration parameters, including IP addresses from a specific server.
CONFIRM	4	A client sends a confirm message to any available server to determine whether the addresses it was assigned are still appropriate to the link to which the client is connected.
RENEW	5	A client sends a renew message to the server that originally provided the client's address and configuration parameters to extend the lifetimes on the addresses assigned to the client and to update other configuration parameters.
REBIND	6	A client sends a rebind message to any available server to extend the lifetimes on the addresses assigned to the client and to update other configuration parameters; this message is sent after a client receives no response to a renew message.
REPLY	7	A server sends a reply message containing assigned addresses and configuration parameters in response to a solicit, request, renew or rebind message containing configuration parameters in response to an information-request message. A server sends a reply message in response to a confirm message confirming or denying that the addresses assigned to the client are appropriate to the link to which the client is connected. A server sends a reply message to acknowledge receipt of a release or decline message.
RELEASE	8	A client sends a release message to the server that assigned addresses to the client to indicate that the client will no longer use one or more of the assigned addresses.
DECLINE	9	A client sends a decline message to a server to indicate that the client will no longer use one or more of the assigned addresses.

Table 51-2

Message Name	Message Value	Message Description
RECONFIGURE	10	A server sends a reconfigure message to a client to inform the client that the server has new or updated configuration parameters and that the client is to initiate a renew/reply or an information-request/reply transaction with the server in order to receive the updated information.
INFORMATION -REQUEST	11	A client sends an information-request message to the server to request configuration parameters without the assignment of any IP address to the client.
RELAY-FORWARD	12	A relay agent sends a relay-forward message to relay messages to servers, either directly or through another relay agent. The received message, either a client message or a relay-forward message from another relay agent, is encapsulated in an option in the relay-forward message.
RELAY-REPLY	13	A server sends a relay-reply message to relay agents containing a message that the relay agent delivers to a client. The relay-reply message may be relayed by other relay agents for delivery to the destination relay agent. The server encapsulates the client message as an option in the relay-reply message, which the relay agent extracts and relays to the client.

The following table lists DHCPv6 vs. DHCPv4 message type comparison.

Table 51-3

DHCPv6 Message Type	DHCPv4 Message Type
SOLICIT (1)	DHCPDISCOVER
ADVERTISE (2)	DHCPOFFER
REQUEST (3), RENEW (5), REBIND (6)	DHCPREQUEST
REPLY (7)	DHCPACK/DHCPNAK
RELEASE (8)	DHCPRELEASE
INFORMATION-REQUEST (11)	DHCPINFORM
DECLINE (9)	DHCPDECLINE
CONFIRM (4)	-
RECONFIGURE (10)	DHCPFORCERENEW
RELAY-FORWARD (12), RELAY-REPLY (13)	-

Prefix Delegation

The Prefix Delegation options provide a mechanism for automated delegation of IPv6 prefixes using DHCPv6. The prefix delegation mechanism is intended for delegating a long-lived prefix from a delegating router (DHCPv6 server) to a requesting router (DHCPv6 client), across an administrative boundary, where the delegating router does not require knowledge about the topology of the links in the network to which the prefixes will be assigned.

A delegating router provides IPv6 prefixes to be delegated to requesting routers. The delegating router chooses a prefix for delegation, and responds with prefixes which are sent to the requesting router. The requesting router is then responsible for the delegated prefixes. For example, the requesting router might assign a subnet from a delegated prefix to one of its interfaces, and begin sending router advertisements for the prefix on the link.

Each prefix has an associated valid and preferred lifetime, which constitutes an agreement about the length of time over which the requesting router is allowed to use the prefix. A requesting router can request an extension of the lifetimes on a delegated prefix and is required to terminate the use of a delegated prefix if the valid lifetime of the prefix expires.

The following diagram shows a network architecture in which prefix delegation could be used.

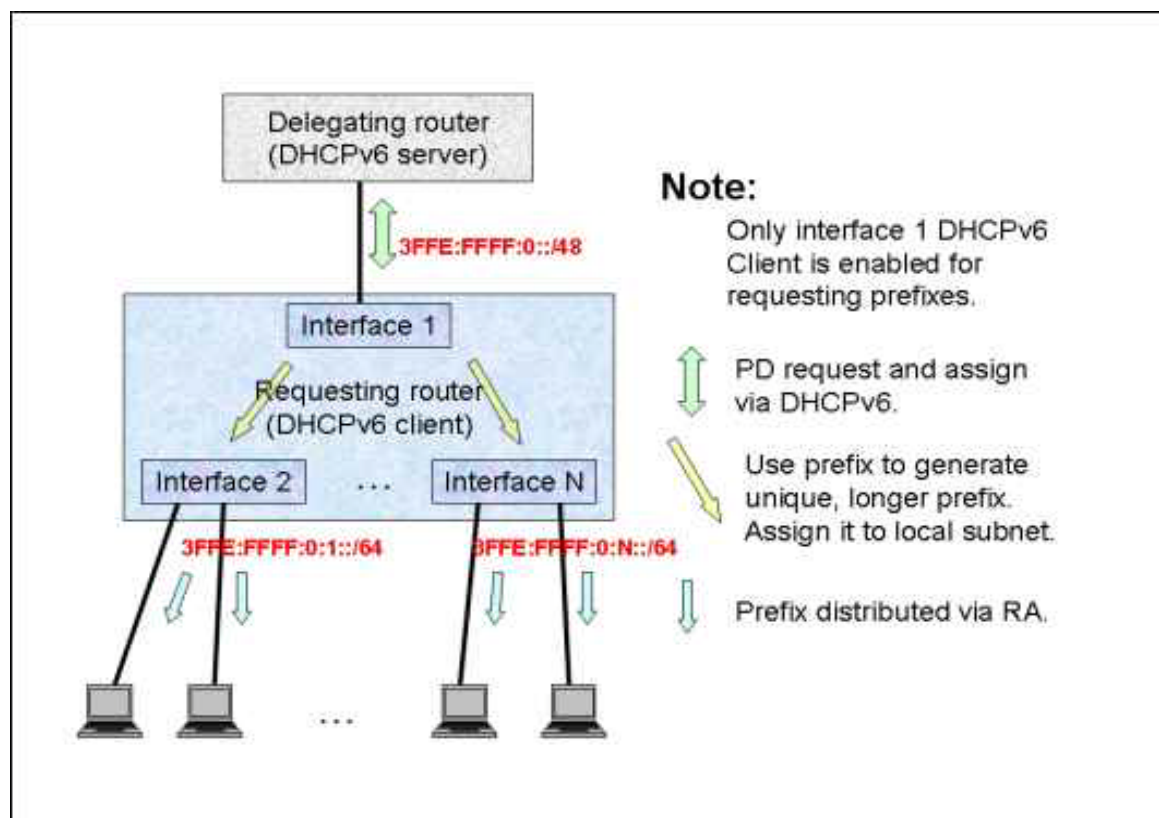

Figure 51-2

When a router's subnet requests a delegated prefix, it must assign additional bits to the prefix to generate unique, longer prefixes. For example, if the delegating router in the figure delegates `3FFE:FFFF:0::/48`, it might generate `3FFE:FFFF:0:1::/64`, `3FFE:FFFF:0:2/64` ..., `3FFE:FFFF:0:N/64` for assignment to links in the other interfaces. If the delegating router assigns a delegated prefix to a link to which the router is attached, and begins to send router advertisements for the prefix on the link, the requesting router must set the valid lifetime in those advertisements to be no later than the valid lifetime specified in the IA_PD Prefix option. A requesting router may use the preferred lifetime specified in the IA_PD Prefix option.

In the example, each interface will assign a new IP address, and N+1 routing entries will be added into routing table. The following table shows a simple instance of adding entries:

Table 51-4

Route	Next Hop	Type
3FFE:FFFF:0::/48	interface 1	Local
3FFE:FFFF:0:1::/64	Interface 2	Local
...
3FFE:FFFF:0:N::/64	interface N	Local

Restrictions

If the delegated prefix’s prefix-length is greater than the sub-prefix’s prefix-length (which is the interface prefix length of the configuration), the address and prefix will not be set. For example, DHCPv6 client delegated prefix 3ffe:1:2:3:/64, and interface configured sub-prefix is ::1:1:1:1/48. The interface will not be add a new address for the DHCPv6 delegated prefix, since a64 is greater than 48.

Rapid Commit

The DHCPv6 client can obtain configuration parameters from a server; either through a rapid two-message exchange (solicit, reply) or through a normal four-message exchange (solicit, advertise, request, reply). By default, the four-message exchange is used. When the rapid-commit option is enabled by both the client and server, the two -message exchange is used instead of the four-message exchange. The diagram below shows use of the ipv6 dhcp client pd prefix-name rapid commit to enable prefix request with rapid-commit option.

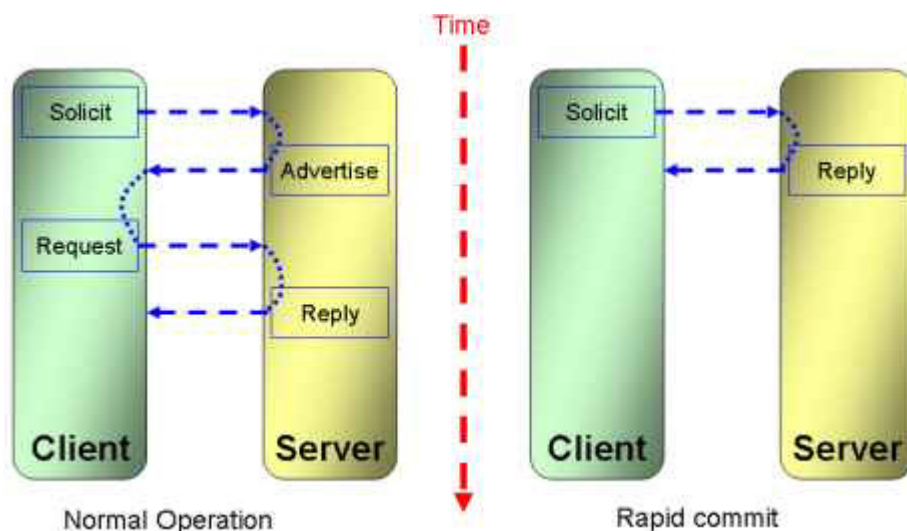

Address Information Refresh

An IA_NA or IA_PD has no explicit “lifetime” or “lease length” of its own. When the valid lease lengths of all the addresses in an IA_NA or IA_PD have expired, the IA_NA or IA_PD can be considered to have expired. T1 and T2 are included to give servers explicit control over when a client recontacts the server about a specific IA_NA or IA_PD.

In a message sent by a client to a server, values in the T1 and T2 fields indicate the client's preference for those parameters. The client sets T1 and T2 to 0 if it has no preference for those values. In a message sent by a server to a client, the client uses the values in the T1 and T2 fields

for the T1 and T2 parameters, unless those values in those fields are 0. The values in the T1 and T2 fields are the number of seconds until T1 and T2.

The server selects the T1 and T2 times to allow the client to extend the lifetimes of any addresses in the IN_NA or IN_PD before the lifetimes expire, even if the server is unavailable for some short period of time. Recommended values for T1 and T2 are .5 and .8 times the shortest preferred lifetime of the addresses in the IA that the server is willing to extend, respectively. If the “shortest” preferred lifetime is 0xffffffff (“infinity”), the recommended T1 and T2 values are also 0xffffffff. If the time at which the addresses in an IA_NA or IA_PD are to be renewed is to be left to the discretion of the client, the server sets T1 and T2 to 0.

If a server receives an IA_NA or IA_PD with T1 greater than T2, and both T1 and T2 are greater than 0, the server ignores the invalid values of T1 and T2 and processes the IA_NA or IA_PD as though the client had set T1 and T2 to 0.

If a client receives an IA_NA or IA_PD with T1 greater than T2, and both T1 and T2 are greater than 0, the client discards the IA_NA or IA_PD option and processes the remainder of the message as though the server had not included the invalid IA_NA or IA_PD option.

There is also a command to limit the minimum value of T1 and T2, called `ipv6 dhcp client information refresh minimum seconds`. If the configured value is greater than the T1 or T2, T1 or T2 will be set to the configured value.

DHCPv6 Configurations Commands

- [Enabling the IPv6 DHCP client function](#)
- [Configuring a DHCPv6 Client minimum refresh time](#)
- [Configuring an IPv6 address based on an IPv6 general prefix](#)
- [Showing an ipv6 general prefix](#)
- [Showing ipv6 dhcp configurations](#)

Enabling the IPv6 DHCP client function

To enable the IPv6 DHCP client function use the IPv6 DHCP client `pd` command to enable the IPv6 DHCP client function. The function is disabled by default. The `no` version of the command disabled the function.

Command	Explanation
<code>ipv6 dhcp client pd { PREFIX-NAME hint IPV6-PREFIX } [rapid-commit]</code>	Use this command to enable Dynamic Host Configuration Protocol (DHCP) for IPv6 client.
	Use the <code>no</code> form of this command to disable DHCPv6 features.

The following example enables prefix delegation, where `dhcp-prefix` is the general prefix name configured by `ipv6 address` command:

```
DGS-6600 > enable
Switch# configure terminal
DGS-6600(config)# interface vlan2
DGS-6600(config-if)# ipv6 address dhcp-prefix 0:0:0:7272::72/64
DGS-6600(config-if)# exit
DGS-6600(Config)# interface vlan1
DGS-6600(config-if)# ipv6 dhcp client pd dhcp-prefix
```

The following example configures a hint for prefix-delegation:

```
DGS-6600 > enable
DGS-6600# configure terminal
DGS-6600(config)# interface vlan1
DGS-6600(config-if)# ipv6 dhcp client pd hint 2001:0DB8:1::/48
```

The following example configures a rapid-commit delegation:

```
DGS-6600 > enable
DGS-6600# configure terminal
DGS-6600(config)# interface vlan1
DGS-6600(config-if)# ipv6 dhcp client pd dhcp-prefix rapid-commit
```

The following example configures a delegation with hint prefix and rapid-commit simultaneously:

```
DGS-6600> enable
DGS-6600# configure terminal
DGS-6600(config)# interface vlan1
DGS-6600(config-if)# ipv6 dhcp client pd hint 2001:0DB8:1::/48
DGS-6600(config-if)# ipv6 dhcp client pd dhcp-prefix rapid commit
```

Configuring a DHCPv6 Client minimum refresh time

Use this command to specify the DHCPv6 Client information refresh time.

Command	Explanation
<code>ipv6 dhcp client information refresh minimum SECONDS</code>	Use this command to specify configure the minimum acceptable Dynamic Host Configuration Protocol (DHCP) for IPv6 client information refresh time on a specified interface. Only VLAN interfaces are valid interfaces for this command.

The following example configures an upper limit of 2 hours:

```
DGS-6600 > enable
DGS-6600# configure terminal
DGS-6600(config)# interface vlan1
DGS-6600(config-if)# ipv6 dhcp client
DGS-6600(config-if)# ipv6 dhcp client information refresh minimum 7200
```

Configuring an IPv6 address based on an IPv6 general prefix

Command	Explanation
ipv6 address { <i>IPv6-ADDRESS</i> <i>PREFIX-LENGTH</i> <i>PREFIX-NAME SUB-BITS</i> <i>PREFIX-LENGTH</i> }	Use this command to add or delete an IPv6 address on an interface. It configures an IPv6 address based on an IPv6 general prefix and enable IPv6 processing on an interface.
	Use the no form of this command to disable.

The following example shows how to enable IPv6 processing on the interface and configure an address that is based on the general prefix called “my-prefix” and the directly specified bits:

```
DGS-6600 > enable
DGS-6600# configure terminal
DGS-6600(config)# interface vlan2
DGS-6600(config-if)# ipv6 address my-prefix 0:0:0:1::1/64
```

Assuming the general prefix named my-prefix has the value of 3ffe:1:2:1::1/64. if there is no general prefix named my-prefix set, no IPv6 address will be set.

If the general prefix named my prefix is acquired via DHCPv6 client prefix delegation, the global address would be configured after the prefix is obtained via the DHCPv6 client.

The following example shows how to remove a general prefix named my-prefix on the interface:

```
DGS-6600 > enable
DGS-6600# configure terminal
DGS-6600(config)# interface vlan2
DGS-6600(config-if)# no ipv6 address my-prefix 0:0:0:1::1/64
```

The following example shows how to set a global address by manual configuration:

```
DGS-6600 > enable
DGS-6600# configure terminal
DGS-6600(config)# interface vlan2
DGS-6600(config-if)# ipv6 address 3ffe:22:22:22::2/64
```

After the command is entered, the global address 3ffe:22:22:22::2/64 will be set.

The following example shows how to remove a global address by manual configuration:

```
DGS-6600 > enable
DGS-6600# configure terminal
DGS-6600(config)# interface vlan2
DGS-6600(config-if)# no ipv6 address 3ffe:22:22:22::2/64
```

After the command is entered, the global address 3ffe:22:22:22::2/64 will be removed.

Showing an ipv6 general prefix

Command	Explanation
show ipv6 general-prefix [<i>PREFIX-NAME</i>]	This command is used to display IPv6 general prefix information.

The following example shows how to display all IPv6 general prefixes on the system:

```
DGS-6600 > enable
DGS-6600# show ipv6 general-prefix
IPv6 prefix dhcp-prefix
Acquired via DHCP Client:
  vlan1
Apply to interface:
  vlan3
  ::3:3:3:3:3:3/64
  vlan2
  ::4:4:4:4:4:4/64
  ::2:2:2:2:2:2/64
IPv6 prefix my-prefix
Acquired via Manual configuration:
  3ffe:1:1::/48
Apply to interface:
  vlan2
  ::1:1:1:1:1:1/64
DGS-6600#
```

The following example shows how to display a specified general prefix named my-prefix:

```
DGS-6600 > enable
DGS-6600# show ipv6 general-prefix my-prefix
IPv6 prefix my-prefix
Acquired via Manual configuration:
  3ffe:1:1::/48
Apply to interface:
  vlan2
  ::1:1:1:1:1:1/64
DGS-6600#
```

Showing ipv6 dhcp configurations

Command	Explanation
<code>show ipv6 dhcp [interface [INTERFACE-NAME]]</code>	This command is used to display DHCPv6 client configuration running information of interface(s).

The `show ipv6 dhcp` command shows the DHCP for IPv6 client configuration and running information of the specified interface. If the interface argument is not presented, the DHCPv6 Client DUID will be showed.

The following example shows the DHCPv6 client's DUID:

```
DGS-6600 > enable
DGS-6600 # show ipv6 dhcp
This device's DHCPv6 unique identifier (DUID):
0001000111A8040D001FC6D1D47B.
```

The following example shows the DHCPv6 client for interface `vlan1`, when `vlan1` is DHCPv6 client disabled:

```
DGS-6600 > enable
DGS-6600 # show ipv6 dhcp interface vlan1
DGS-6600 #
```

The following example shows the DHCPv6 client for interface `vlan1`, when `vlan1` is in the REQUEST state:

```
DGS-6600 > enable
DGS-6600 # show ipv6 dhcp interface vlan1
Interface vlan1 is in DHCPv6 client mode.
State: REQUEST
Server IP: N/A
Server DUID: N/A
Preference: 0
Event expire: 10
IA is not acquired.
```

The following example shows the DHCPv6 client for interface vlan1, when vlan1 is in the ACTIVE state:

```
DGS-6600 > enable
DGS-6600 # show ipv6 dhcp interface vlan1
Interface vlan1 is in DHCPv6 client mode.
State: ACTIVE
Server IP: fe80::21d:92ff:fe2b:af48%vlan1
Server DUID: 0001000611D6EE73001D922BAF48
Preference: 87
IA Type: PD
IA ID: 0003
T1: 300
T2: 800
Prefer Lifetime: 3600
Valid Lifetime: 7200
Prefix: 3000:1:2::/48
IA expire: 299
Addr expire: 7199
```

The following example shows the DHCPv6 client for interface vlan1, when vlan1 is in the RENEW state:

```
DGS-6600 > enable
DGS-6600 # show ipv6 dhcp interface vlan1
Interface vlan1 is in DHCPv6 client mode.
State: RENEW
Server IP: fe80::21d:92ff:fe2b:af48%vlan1
Server DUID: 0001000611D6EE73001D922BAF48
Preference: 87
Event expire: 17
IA Type: PD
IA ID: 0003
T1: 300
T2: 800
Prefer Lifetime: 3600
Valid Lifetime: 7200
Prefix: 3000:1:2::/48
IA expire: 219
Addr expire: 5119
```

The following example shows the DHCPv6 client for interface vlan1, when vlan1 is in the REBIND state:

```
DGS-6600 > enable
DGS-6600 # show ipv6 dhcp interface vlan1
Interface vlan1 is in DHCPv6 client mode.
State: REBIND
Server IP: fe80::21d:92ff:fe2b:af48%vlan1
Server DUID: 0001000611D6EE73001D922BAF48
Preference: 87
Event expire: 26
IA Type: PD
IA ID: 0003
T1: 300
T2: 800
Prefer Lifetime: 3600
Valid Lifetime: 7200
Prefix: 3000:1:2::/48
Addr expire: 3192
```

Default Settings

For each DHCPv6 Client interface, default values are recommended in the following table:

Table 51-5

Item	Default Value
DHCPv6 Client state	Disabled
DHCP6_CLIENT_DEFAULT	DHCPC6_DNS_SRV DHCPC6_SNTP_SRV DHCPC6_IA_PD
T1 in SOLICIT	1800 seconds
T2 SOLICIT	2880 seconds
Preference lifetime in SOLICIT	3600 seconds
Valid lifetime in SOLICIT	7200 seconds
Minimum refresh time	0 (not set, no limit)

Restriction/Limitation

The following table lists the restriction/limitation range.

Table 51-6

Item	Range
Configure minimum refresh time	600-65535 (seconds)
General prefix name length	1-16 (characters)
Maximum prefix length of general prefix	64

Table 51-6

Item	Range
General prefix name length	1 -16 (characters)

Chapter 52

sFlow

Chapter Overview

The following topics are included in this chapter, please go to the topic for more detailed information:

- [Chapter Overview](#)
- [An Introduction to sFlow](#)
- [sFlow Design Overview](#)
- [Configuration Commands](#)
- [Configuration Command Examples](#)
- [sFlow Configuration Example](#)

An Introduction to sFlow

sFlow® is an industrial standard of sampling technology for monitoring high speed switched networks. This chapter describes functional requirements, MIB, high level design and parameters of the sFlow module for this device. The sFlow module in the DGS6600 complies with sFlow Version 5.

sFlow uses two forms of sampling: statistical packet-based sampling of packet flows, and the time-based sampling of interface counters. The sFlow agent on the device encodes the samples into sFlow datagrams and sends the datagrams to remote sFlow collector for network monitoring and analyzing. This is shown in the Figure below.

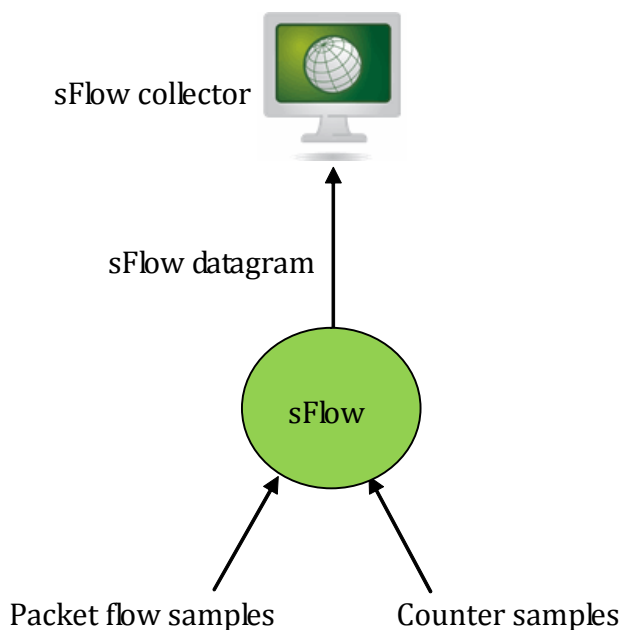

The sFlow agent can be configured to sample the packets and counters of each interface independently.

Packet flow sampling: On average, $1/(\text{sampling rate})$ packets is sampled for each interface. The agent is free to adjust the value. The flow information and the packet headers of the sampled packets are used for sFlow datagram. The sampling rate can be configured and the sFlow agent is free to adjust the value.

Counter sampling: A maximum polling interval for each interface is assigned to the sFlow agent, but the agent is free to schedule polling in order to maximize internal efficiency.

Both types of samples are combined to sFlow datagrams according to sFlow Version 5. One sFlow datagram can contain multiple flow and counter samples. sFlow datagrams are sent as UDP packets to the remote sFlow collector.

sFlow Design Overview

According to the SFLOW-MIB, the sFlow agent can be divided to four types of objects: Agent, Receiver, Sampler and Poller. The Agent represents the whole switch. Each Receiver is represented by one row in the sFlowRcvrTable. There are 4 Receivers. User can configure them. Each Sampler is represented by one row in the SFlowFsTable and each Poller is represented by one row in the sFlowCpTable. User can add, configure and delete the Samplers and Pollers. The parameters can be configured according to the SFLOW-MIB. Below are the definitions of the four types of objects:

Agent

Only one Agent is created to represent the whole switch. Although the sFlow Version 5 describes multiple agents by sub-ids, the device creates only one Agent.

Receiver

Each Receiver represents the remote collector and encodes samples into UDP datagrams and sends them to the remote collector through both switch ports and management port.

Sampler

Each sampler has a unique sFlowFsDataSource that represents an interface and an unique sFlowFsReceiver that represents a Receiver. The Sampler collects packet samples from sFlowFsDataSource and passes the packet and flow information to sFlowFsReceiver.

Poller

A Poller is similar to a Sampler except that it collects time-sampled counter samples. Each Poller has a unique sFlowCpDataSource that represents an interface and a unique sFlowCpReceiver that represents a Receiver. The Poller collects counter samples of sFlowCpDataSource and passes the interface statistical information to sFlowCpReceiver.

One Agent represents the whole switch. Agent can hold multiple Samplers, Pollers and Receivers. Each Sampler and Poller points to only one Receiver and one interface. Each Receiver points to one unique remote sFlow collector.

The sFlowRcvrOwner must be configured first so that other parameters of the same Receiver can be configured. The Receiver with a non-empty sFlowRcvrOwner is a "claimed" Receiver. The sFlowFsReceiver must be assigned to a claimed Receiver so that other parameters of the same Sampler can be configured. Similarly, the sFlowCpReceiver must be assigned to a claimed Receiver so that other parameters of the same Poller can be configured. Once the sFlowRcvrTimeout expires or the sFlowRcvrOwner is configured to empty string (unclaimed), the other parameters of the same Receiver and all the Samplers and Pollers associated with the Receiver will be restored to their default values.

When the `sFlowFsPacketSamplingRate` of a Sampler is set, then that sampling rate should be passed to the switch hardware for the associated interface. Packet samples will be taken and appear for treatment in the Sampler. The Sampler will extract the sampled packets' flow and header information and then pass the information to its Receiver to be encoded into the next output sFlow datagram packet. A `sFlowFsPacketSamplingRate` of 0 disables the packet sampling.

According to sFlow Version 5 section 3.1, this device's hardware samples the packets by generating a random number for each packet, comparing the random number to a preset threshold and takes a sample whenever the random number is smaller than the threshold value. Because of the random number sampling, the number of sampled packets may be different from the sampling rate setting.

When the `sFlowCpInterval` of a Poller is set, the Poller is enabled. A `sFlowCpInterval` of 0 disables the counter sampling. The Poller uses a random start time between one second and `sFlowCpInterval` to start the countdown to the first counter sampling, and then samples the counter information every `sFlowCpInterval`. The random start time prevents the synchronization of counter sampling with other Pollers. When the countdown reaches zero, the Poller gets the counter statistics of the associated interface and then passes the information to its Receiver to be encoded into the next output sFlow datagram packet.

The sFlow datagram consists of a header followed by one or more flow or counter samples. The Receiver packs the samples into a contiguous buffer, and sends it out in the next datagram. If the buffer is full and there is no room for the next sample to go into it, then the buffer is sent out and then reset. The sample then becomes the first sample in the next datagram. The sFlow Agent may at most delay a sample by 1 second before it is required to send the datagram. If the 1-second tick comes around and there are samples in the buffer, then the datagram is sent out and the buffer is reset. This is a simple way to ensure that samples are never delayed for more than 1 second in the agent.

Each interface may be associated with multiple Samplers with different sampling rates and multiple Pollers with different polling intervals. There is no problem for multiple polling intervals with one interface because the counter sampling is software-based. But the switch is only capable of sampling packets at a single sampling rate. At the situation of multiple sampling rates with a unique interface, the sampling rates must be powers of two to allow the smallest sampling rate to be set in hardware and all other sampling rates to be obtained in software by sub-sampling.

Configuration Commands

Commands	Description
sFlow	Use the sflow command to enable sFlow functions. Use the no form of this command to disable sFlow functions.
sflow poller <i>INSTANCE</i> [receiver <i>RECEIVER</i>] [interval <i>SECONDS</i>]	Use the sflow poller command to create/configure a Poller for the sFlow agent. Use the no form of this command to delete one Poller or all Pollers.
sflow receiver <i>INDEX</i> [owner <i>NAME</i>] [expiry { <i>SECONDS</i> infinite }] [max-datagram-size <i>SIZE</i>] [host { <i>IP-ADDRESS</i> <i>IPV6-ADDRESS</i> }] [udp-port <i>PORT</i>]	Use the sflow receiver command to configure a Receiver for the sFlow agent. Receivers cannot be added to or removed from the sFlow agent. Use the no form of this command to reset one Receiver or all Receivers to the default settings.
sflow sampler <i>INSTANCE</i> [receiver <i>RECEIVER</i>] [sampling-rate <i>RATE</i>] [max-header-size <i>SIZE</i>]	Use the sflow sampler command to create/configure a Sampler for the sFlow agent. Use the no form of this command to delete one Sampler or all Samplers.

Configuration Command Examples

This example shows how to enable sFlow functions.

```
DGS-6600(config)#sflow
```

This example shows how to create/configure the Poller of INSTANCE 1 with RECEIVER as 1, and INTERVAL as 20 seconds.

```
DGS-6600(config-if)#sflow poller 1 receiver 1 interval 20
```

This example shows how to configure the Receiver of INDEX 1 with owner name as collector1, TIMEOUT as 86400 seconds, SIZE as 1400 bytes, remote sFlow collector's IP-ADDRESS as 10.1.1.2 and PORT as 6343.

```
DGS-6600(config)#sflow receiver 1 owner collector1 expiry 86400 max-datagramsize 1400 host 10.1.1.2 udp-port 6343
```

This example shows how to create/configure the Sampler of INSTANCE 1 with RECEIVER as 1, RATE as 1024 and SIZE as 128 bytes.

```
DGS-6600(config-if)# sflow sampler 1 receiver 1 sampling-rate 1024 max-headersize 128
```

This example shows how to display all types of sFlow objects' information. The flow samples and counter samples of eth3.1 are sent to 10.1.1.2. The flow samples and counter samples of eth3.2 are sent to both 10.1.1.2 and 10.1.1.3.

```
DGS-6600 (config)#show sflow

sFlow Agent Version: 1.3;D-Link Corporation;3.00
sFlow State          : Enabled
Receivers Information
Index                : 1
Owner                : collector1
Current Countdown Time: 86122
Max Datagram Size   : 1400
Address              : 10.1.1.2
```

sFlow Configuration Example

Description

R1 will monitor eth2.1 and send sflow packets to sflow server for analysis.

Topology

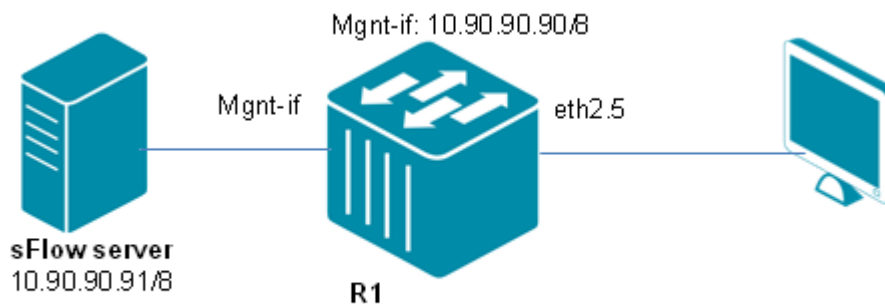

Configuration

R1

Step 1: Assign IP to mgmt-if

```
DGS-6600:15 (config)#mgmt
DGS-6600:15 (mgmt-if)#ip address 10.90.90.90/8
```

Step 2: Enable sflow and set Receiver collector1, sFlow collector's IP-ADDRESS as 10.90.90.91.

```
DGS-6600:15 (mgmt-if)#sflow
DGS-6600:15 (config)#mgmt
DGS-6600:15 (mgmt-if)#sflow receiver 1 owner collector1 expiry infinite host
10.90.90.91
```

Step 3: Set Sampler of INSTANCE 1 with RECEIVER as 1, RATE as 1024 and SIZE as 256 bytes.

```
DGS-6600:15(config)#interface eth2.1
DGS-6600:15(config-if)# sflow sampler 1 receiver 1 sampling-rate 1024 max-header-
size 256
DGS-6600:15(config-if)# sflow poller 1 receiver 1 interval 20
```

Verifying the Configuration

Use the "show sflow" command to check the sFlow configuration.

```
DGS-6600:15#show sflow

sFlow Agent Version: 1.3;D-Link Corporation;2.10
sFlow Agent Address: 0.0.0.0
sFlow State          : Enabled

Receivers Information
Index                : 1
Owner                : collector1(mgmt-if)
Current Countdown Time: Never Timeout
Max Datagram Size   : 1400
Address              : 10.90.90.91
Port                 : 6343
Datagram Version     : 5

Samplers Information
Interface  Instance  Receiver  Sampling-rate  Max-header-size
-----
eth2.1    1           1         1024           256

Pollers Information
Interface  Instance  Receiver  Interval
-----
eth2.1    1           1         20
```



Part 10- Network Management

The following chapters are included in this volume:

- **Simple Network Management Protocol (SNMP)**
- **RMON**
- **Error Disable Port Recovery**
- **Traffic Storm Control**

Chapter 53

Simple Network Management Protocol (SNMP)

Chapter Overview

The following topics are included in this chapter, please go to the topic for more detailed information:

- [Chapter Overview](#)
 - [An Introduction to SNMP Overview](#)
- [SNMP Configuring Commands](#)
 - [Setting up Basic SNMP Server Information](#)
 - [Enabling the SNMP Server](#)
 - [Configuration for SNMP Version 1 and 2c Users](#)
 - [Configuration for an SNMP Version 3 Users](#)
 - [Configuring an SNMP Trap Recipient](#)
 - [Controls for Sending Specific Types of Traps](#)
 - [Configuring an SNMPv3 Engine ID](#)
- [Configuration Examples](#)
 - [SNMPv2 With Trap Configuration Example](#)
 - [SNMP v3 with trap Configuration Example](#)
- [List of Constants and Default Settings](#)

An Introduction to SNMP Overview

SNMP (Simple Network Management Protocol) is a protocol that is used by an SNMP manager to communicate and manage an SNMP agent. SNMP is one of the available interfaces that a user can use to manage the device.

The SNMP manager (Network Management System) is a station that runs SNMP client software. Each system that requires managing with SNMP has an *Agent* running on it, which is a software component that informs the SNMP manager of any system status changes that have occurred. The type of information that is sent to SNMP managers is controlled by MIB (Management information base) objects. SNMP uses three basic operations, with the SNMP manager carrying out two basic operations and the SNMP agent carrying out one basic operation. The SNMP manager performs *GET* or *SET* operations on the agent's MIB objects and the SNMP agent can send unsolicited traps to inform the SNMP manager of any new events.

The Switch supports all three versions of SNMP; SNMP v1, SNMP v2c, and SNMP v3. Both SNMP v1 and SNMP v2c use the community-string based security model, which does not provide encryption and authentication for SNMP packets. SNMP v3 enhances the security model by providing encryption and authentication of SNMP packets. SNMP v3 also uses View-based Access Control, which allows different sets of MIB objects to be accessible to different sets of users. The features of the View-based Access Control Model (VACM) are described below:

- **Authentication-** A checksum over the packet is computed by the sender and verified by the receiver. This verification ensures that the packet is valid and that it has originated from a valid source.
- **Encryption-** Packets are encrypted to prevent eavesdroppers from learning the packet.

Figure 8-1 illustrates the communications relationship between the SNMP agent and manager.

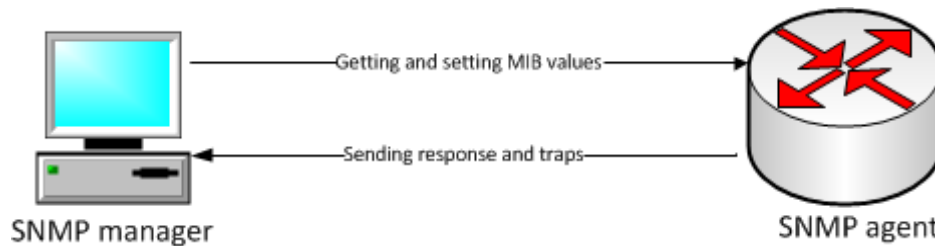

A manager can send the agent requests to get and set MIB values. The agent can respond to these requests.

User-based Security Model

SNMP v3 allows the administrator to define the users that are using different security models to manage the device. If the security model is SNMP v1 or SNMP v2c, no authentication and encryption will be performed. If the security model is SNMP v3, the security level, whether authentication or encryption are being used, must be specified. There are three alternative security levels available; **noAuthNoPriv**, **authNoPriv**, and **authPriv**. The alternative security levels are described in the following table:

Security Level	Authentication	Encryption
noAuthNoPriv	User name is used for authentication check.	No.
authNoPriv	The checksum based on the HMAC-MD5 or HMAC-SHA algorithms using the specified password are computed over the packet for authentication checks.	No.
authPriv	The checksum based on the HMAC-MD5 or HMAC-SHA algorithms using the specified password are computed over the packet for authentication checks.	The packet is encrypted based on DES 56-bit, using the specified password.

Table 53-1 Alternative SNMP v3 Security Models

View-based Access Control Model

View-based Access Control Model (VACM) is a feature that controls user's access to MIB objects in terms of MIB view records. Each MIB view record defines a set of MIB sub-trees. VACM allows the administrator to specify each user a MIB view for read-only access, a MIB view for write access, and another MIB view for notification access. Therefore, if a user attempts to read objects that are out of the scope of the read-only MIB view or write objects that are out of the scope of the write MIB view, the operation will fail. As for the notification view, the system will not be able to send traps with binding variables that are out of the scope of the notification MIB view of the trap receiver.

SNMP Configuring Commands

The following topics are included in this sub-section:

- [Setting up Basic SNMP Server Information](#)

- [Enabling the SNMP Server](#)
- [Configuration for SNMP Version 1 and 2c Users](#)
- [Configuration for an SNMP Version 3 Users](#)
- [Configuring an SNMP Trap Recipient](#)
- [Controls for Sending Specific Types of Traps](#)
- [Configuring an SNMPv3 Engine ID](#)

Setting up Basic SNMP Server Information

The following commands are used in global configuration mode to setup basic SNMP server information:

Command	Explanation
<code>snmp-server contact</code> <i>LINE</i>	Configures the SNMP contact information.
<code>snmp-server location</code> <i>LINE</i>	Used to configure the SNMP location information.
<code>system-name</code> <i>LINE</i>	Used to configure the SNMP system name.

In the following example the user defines the SNMP contact name as “sys-admin”, the SNMP location as “hq”, and configures the SNMP system name of the Switch to be “core-switch”:

```
DGS-6600:15#configure terminal
DGS-6600:15 (config)#snmp-server contact sys-admin
DGS-6600:15 (config)#snmp-server location hq
DGS-6600:15 (config)#system-name core-switch
```

Enabling the SNMP Server

Use the following command in global configuration mode to enable the SNMP server on the Switch:

Command	Explanation
<code>snmp-server</code>	Enables the sending of SNMP traps that are defined in RFC 1157.

In the following example the user enables the SNMP server and verifies the SNMP server has started:

```
DGS-6600:2>enable
DGS-6600:15#configure terminal
DGS-6600:15 (config)#snmp-server
DGS-6600:15 (config)#end
DGS-6600:15#show snmp-server

SNMP Server   : Enabled

System Name   : core-switch

Location      : hq

Contact       : sys-admin

DGS-6600:15#
```

Figure 8-2 (below) shows inform requests between core-switch and hq

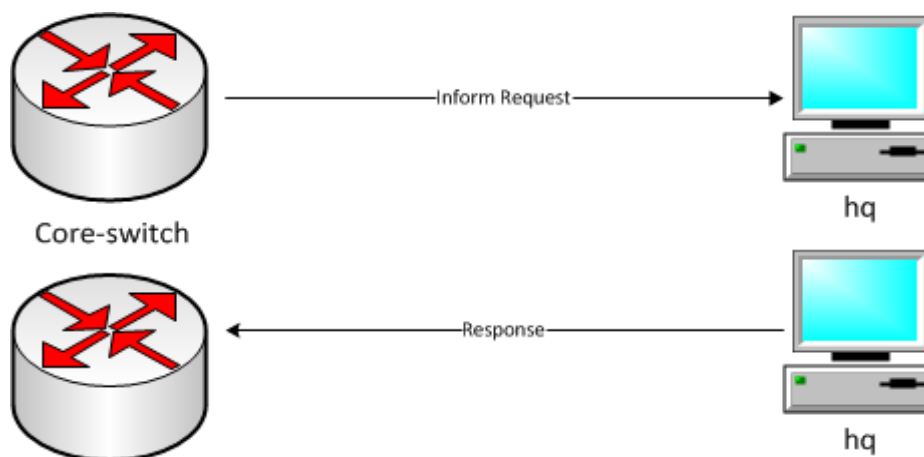

Configuration for SNMP Version 1 and 2c Users

SNMP v1 and SNMP v2c can run in parallel when the SNMP v3 agent is running on the system. Traditionally, SNMP v1/v2c users manage the device using the community name, with either read-only access rights or read/write access rights to all MIB objects supported by the system.

Under the SNMP v3 framework, view records are used to define the set of MIB objects that are accessible to specific users. In order to easily support SNMP v1/v2c, one view record, which includes all MIB objects except for SNMP v3 related objects, is created by default. Two community strings, one for read-only access rights and one for read/write access rights, are also created by default.

The following commands are used to display and configure the SNMP community string parameters:

Command	Explanation
<code>show snmp {community view group}</code>	Displays the current community string, view record, or group.

Command	Explanation
<code>snmp-server community COMMUNITY-STRING [view VIEW-NAME] [ro rw]</code>	Creates a new community string, specifying the access rights. The existing record "CommunityView" can be directly associated with the entry.
<code>no snmp-server community COMMUNITY-STRING</code>	Deletes an un-needed community string.

In the following example, the user creates a read/write community string called "commaccess". The user then displays the SNMP community strings that have been configured on the Switch:

```
DGS-6600:2>enable
DGS-6600:15#configure terminal
DGS-6600:15 (config)#snmp-server community commaccess rw
DGS-6600:15 (config)#end
DGS-6600:15#show snmp community

codes: ro - read only, rw - ReadWrite

(rw)private

(ro)public

(rw)commaccess

Total Entries: 3

DGS-6600:15#
```



NOTE: When a new community string is added, an entry in the user group table will be automatically created with a group name that is identical to the community string. Therefore, use the **show snmp community** command to display the associated MIB view settings.

In the following example, the user deletes the community string called "commaccess". The user then displays the SNMP community strings to verify that the entry has been removed from the Switch:

```
DGS-6600:2>enable
DGS-6600:15#configure terminal
DGS-6600:15 (config)#no snmp-server community commaccess
DGS-6600:15 (config)#end
DGS-6600:15#show snmp community

codes: ro - read only, rw - ReadWrite

(rw)private

(ro)public

Total Entries: 2
```

Configuration for an SNMP Version 3 Users

When creating SNMP v3 users, the administrator can thoroughly plan the management scheme to utilize the enhanced security features. First of all, the entire MIB tree can be partitioned into sub-trees, characterized by the access requirements for different levels of user. This enables a set of MIB view records to be defined.

Secondly, users can be classified into groups. Each group is defined with its own security model, security level, read-only MIB view, read/write MIB view, and notification MIB view.

Finally, the users need to be added to the groups and the keys required for authentication or encryption need to be defined.

The following commands are used to create an SNMP version 3 user:

Command	Explanation
<code>show snmp {community host view group engineID}</code>	Displays the current SNMP views or groups.
<code>snmp-server view VIEW-NAME OID-TREE {included excluded}</code>	Defines which MIB objects an SNMP manager can access.
<code>snmp-server group GROUP-NAME {v1 v2c v3 {auth noauth priv}} [read READ-VIEW] [write WRITE-VIEW] [notify NOTIFY-VIEW]</code>	Defines SNMP user groups.
<code>show snmp user [USER-NAME]</code>	Displays the existing SNMP users.
<code>snmp-server user USER-NAME GROUP-NAME v3 [encrypted] [auth {md5 sha} AUTH-PASSWORD] [priv PRIV-PASSWORD]</code>	Adds users to the SNMP user group.

The example below creates a new SNMP version 3 user with the following properties:

- 1) A new view named *testsnmpv3* is created that includes:
 - All MIBs under MIB-2 (1.3.6.1.2.1)
 - All MIBs under SNMP version 2 (1.3.6.1.6) except *snmpCommunityMIB* (1.3.6.1.6.3.18)
- 2) A new group named *snmpgroup1* is created and is assigned to the SNMP view called *testv3*, that was created previously. No write view is assigned to the *snmpgroup1* group, meaning that all users assigned to this group will be limited to read-only access.
- 3) A user named *dlink* is added to *snmpgroup1*. This user will inherit the qualities that were previously configured for *snmpgroup1*. The user *dlink* will use the MD5 algorithm for authentication purposes and the authentication password will be *pw123*.
- 4) The **show snmp user** command is entered to verify if the new SNMP user has been created properly.

```
DGS-6600:2>enable
DGS-6600:15#configure terminal
DGS-6600:15(config)#snmp-server view testsnmpv3 1.3.6.1.2.1 included
DGS-6600:15(config)#snmp-server view testsnmpv3 1.3.6.1.6 included
DGS-6600:15(config)#snmp-server view testsnmpv3 1.3.6.1.6.3.18 excluded
DGS-6600:15(config)#snmp-server group snmpgroup1 v3 auth read testsnmpv3
DGS-6600:15(config)#snmp-server user dlink snmpgroup1 v3 auth md5 pw123
DGS-6600:15(config)#end
DGS-6600:15#show snmp user

User name: dlink

Engine ID: 6604ab3660c10035

Authentication Protocol: MD5

Privacy protocol: (none)

Group name: snmpgroup1

User name: initial

Engine ID: 6604ab3660c10035

Authentication Protocol: (none)

Privacy protocol: (none)

Group name: initial

Total Entries: 2
```

Configuring an SNMP Trap Recipient

The SNMP agent sends unsolicited trap packets to notify the trap recipient Network Management Station (NMS) of any network events. The trap recipient must be explicitly configured. The agent can send trap packets to the recipient in v1, v2c, or v3. When a trap packet is sent in v1/v2c form, the community string representing the recipient of the trap will be encoded in the packet. When sent in v3 form, the user name representing the trap recipient will be encoded in the packet. If the recipient is a v3 user, the security level that should be used to send the packet can also be specified. If the highest security level is specified, the trap packet can be protected by the authentication and encryption mechanism.

The following commands are used to configure an SNMP trap recipient:

Command	Explanation
<code>snmp-server host {IP-ADDRESS} [version { 1 2c 3 {auth noauth priv} }] WORD [VLAN-INTERFACE]</code>	Configures the trap recipient. When the input IP-ADDRESS is an IPv6 link-local address, the user needs to choose an existing VLAN-INTERFACE to specify the output interface for the destination.
<code>show snmp host</code>	Displays the configured trap recipients.

In the following example, the user permits SNMP access to all objects with read-only permissions using the community string named *public*. The managed system will also send traps to the host 172.16.1.33 using SNMPv1 and to the host 172.16.1.27 using SNMPv2c. The community string named *public* is sent with the traps. Finally, the user displays the configured trap recipients to confirm that all the hosts have been configured properly:

```
DGS-6600:2>enable
DGS-6600:15#configure terminal
DGS-6600:15(config)#snmp-server community public
DGS-6600:15(config)#snmp-server host 172.16.1.27 version 2c public
DGS-6600:15(config)#snmp-server host 172.16.1.33 version 1 public
DGS-6600:15(config)#end
DGS-6600:15#show snmp host
```

Host IP Address	SNMP Version	Community Name	SNMPv3 User Name
172.16.1.27	v2c	public	
172.16.1.33	v1	public	

Total Entries: 2

When a trap recipient is configured, the version of the trap being sent must also be specified. If the specified SNMP version is v1/v2c, the specified community string must already be in the community table. If the specified version is v3, then the specified community string must be a user name belonging to a v3 group. If the specified version is inconsistent with the version as it appears in the user table, the host cannot be configured.

Before sending traps to a recipient, the system will check the variable binding list against the notification MIB view of the recipient. If any variable is out of the scope of the notification MIB view, the trap will not be sent to this recipient.

Controls for Sending Specific Types of Traps

In order for the agent to send traps to the recipient, the sending of individual trap types must be enabled. Use the following commands to control the sending of individual traps:

Command	Explanation
<code>snmp-server enable traps</code>	Enables sending for all trap types.
<code>no snmp-server enable traps</code>	Disables sending for all trap types.

Command	Explanation
<code>snmp-server enable traps snmp [authentication] [linkup] [linkdown] [coldstart] [warmstart]</code>	Controls sending of traps defined in RFC 1157.
<code>show snmp-server traps</code>	Displays the SNMP traps that are enabled on the Switch.

In the following example, the user disables the SNMP authentication trap and displays the configured traps recipients to confirm that the trap has been enabled:

```
DGS-6600:2>enable
DGS-6600:15#configure terminal
DGS-6600:15(config)#no snmp-server enable traps snmp authentication
DGS-6600:15(config)#end
DGS-6600:15#show snmp-server traps

Global Trap State : Enabled

SNMP

    coldstart           : Enabled
    warmstart           : Enabled
    linkdown            : Enabled
    linkup              : Enabled
    authentication      : Disabled

DGS-6600:15#
```

Configuring an SNMPv3 Engine ID

If using SNMP version 3, the user can configure a name for the Switch's local SNMP engine ID.

The following commands are used to configure an SNMPv3 engine ID:

Command	Explanation
<code>snmp-server engineID local <i>ENGINEID-STRING</i></code>	Configures the SNMPv3 engine ID.
<code>show snmp engineID</code>	Displays the SNMPv3 engine configuration.

In the following example, the user configures an SNMP engine ID value of 664499991100000000000000 and verifies the configuration:

```
DGS-6600:2>enable
DGS-6600:15#configure terminal
DGS-6600:15 (config)#snmp-server engineID local 6644999911
DGS-6600:15 (config)#end
DGS-6600:15#show snmp engineID
Local SNMP engineID: 664499991100000000000000
DGS-6600:15#
```

Configuration Examples

SNMPv2 With Trap Configuration Example

Create SNMP V2 trap receiver. Create Snmpv2 community Strings.

Topology

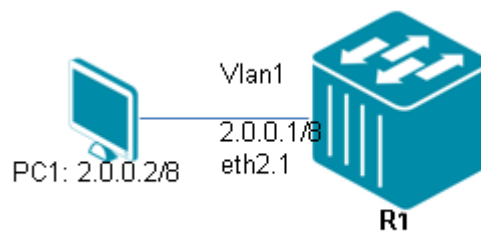

Figure 53-1 SNMPv2 With Trap Configuration Topology

R1 (Router 1) Configuration Steps

Step 1: Enable snmp and set snmpv2 trap server

```
DGS-6600:15 (config)#snmp-server
DGS-6600:15 (config)#snmp-server enable traps
DGS-6600:15 (config)#snmp-server host 2.0.0.2 version 2c public
```

Step 2: Create a view tree "dlink", and create community strings for read "dlinkr" and read/write "dlinkwr".

```
DGS-6600:15 (config)#snmp-server view dlink 1.3.6 included
DGS-6600:15 (config)#snmp-server community dlinkr view dlink ro
DGS-6600:15 (config)#snmp-server community dlinkwr view dlink rw
```

Step 3: configure IP address of VLAN

```
DGS-6600:15(config)#interface vlan1
DGS-6600:15(config-if)#ip address 2.0.0.1/8
```

Verifying The Configuration

Use the following command to check the configuration.

```
DGS-6600:15(config-if)#show snmp-server

SNMP Server   : Enabled
System Name   : N/A
Location      : N/A
Contact       : N/A

DGS-6600:15(config-if)#show snmp host
Host IP Address      SNMP Version      Community Name      SNMPv3 User Name
-----
2.0.0.2              v2c              public
-----
Total Entries: 1

DGS-6600:15(config)#show snmp view

View Name          Subtree          View Type
=====
dlink              1.3.6            Included
restricted         1.3.6.1.2.1.1   Included
restricted         1.3.6.1.2.1.11  Included
restricted         1.3.6.1.6.3.10.2.1 Included
restricted         1.3.6.1.6.3.11.2.1 Included
restricted         1.3.6.1.6.3.15.1.1 Included
CommunityView      1                Included
CommunityView      1.3.6.1.6.3      Excluded
CommunityView      1.3.6.1.6.3.1    Included

Total Entries: 9

DGS-6600:15(config)#show snmp community
codes: ro - read only, rw - ReadWrite
(rw)private
(ro)public
(ro)dlinkr
(rw)dlinkwr
Total Entries: 4
```

By plugging a cable into one of the DGS-6600 ports, PC1 can receive link-up v2 trap message.

SNMP v3 with trap Configuration Example

Create SNMP V3 trap receiver. Create Snmpv3 community Strings.

Topology

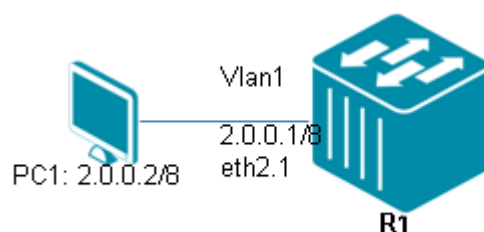

Figure 53-2 SNMPv3 with Trap Configuration Topology

R1 (Router 1) Configuration steps

Step 1: enable snmp and set snmpv2 trap server

```
DGS-6600:15(config)#snmp-server
DGS-6600:15(config)#snmp-server enable traps
DGS-6600:15(config)# snmp-server host 2.0.0.2 version 3 noauth initial
```

Step 2: create a view tree for dlink and add a group v3 gdlink, then set a user Roger into this group.

```
DGS-6600:15(config)#snmp-server view dlink 1.3.6 included
DGS-6600:15(config)#snmp-server group gdlink v3 auth read dlink write dlink
DGS-6600:15(config)#snmp-server user Roger gdlink v3 auth md5 12345678
```

Step 3: configure IP address of VLAN

```
DGS-6600:15(config)#interface vlan1
DGS-6600:15(config-if)#ip address 2.0.0.1/8
```

Verifying the Configuration

Step 1: Use the following command to check the configuration.

```
DGS-6600:15#show snmp-server
SNMP Server   : Enabled
System Name   : N/A
Location      : N/A
Contact       : N/A

DGS-6600:15#show snmp host
Host IP Address      SNMP Version      Community Name      SNMPv3 User Name
-----
2.0.0.2              v3              noauth              initial
Total Entries: 1

DGS-6600:15#show snmp view

View Name          Subtree          View Type
=====
dlink              1.3.6            Included
restricted         1.3.6.1.2.1.1   Included
restricted         1.3.6.1.2.1.11  Included
restricted         1.3.6.1.6.3.10.2.1 Included
restricted         1.3.6.1.6.3.11.2.1 Included
restricted         1.3.6.1.6.3.15.1.1 Included
CommunityView     1                Included
CommunityView     1.3.6.1.6.3      Excluded
CommunityView     1.3.6.1.6.3.1   Included

DGS-6600:15#show snmp group
groupname: gdlink                security model: v3 auth
readview: dlink                  writeview: dlink
notifyview: <no notifyview specified>
row status: active

DGS-6600:15#show snmp user

User Name: Roger
  Engine ID: 800000ab03060b00270000
  Authentication Protocol: MD5
  Privacy Protocol: (none)
  Group Name: gdlink

User Name: initial
  Engine ID: 800000ab03060b00270000
  Authentication Protocol: (none)
  Privacy Protocol: (none)
  Group Name: initial

Total Entries: 2
```

By plugging a cable into one of the DGS-6600 ports, PC1 can receive link-up v3 trap messages.

List of Constants and Default Settings

Variable Name	Default Value
Password Encryption	Enabled
SNMP Server Contact	None
SNMP Location	None
SNMP System Name	None
SNMP Server Service	Disabled
SNMP Server Hosts	None
SNMP Server Users	Initial

Table 53-2 Default Variable Values

[Group Name]	[Version]	[Security Level]	[Read View name]	[Write View Name]	[Notify View Name]
initial	SNMPv3	noauth	restricted	None	restricted
ReadGroup	SNMPv1	noauth	CommunityView	None	CommunityView
ReadGroup	SNMPv2c	noauth	CommunityView	None	CommunityView
WriteGroup	SNMPv1	noauth	CommunityView	CommunityView	CommunityView
WriteGroup	SNMPv2c	noauth	CommunityView	CommunityView	CommunityView

Table 53-3 Snmp Server Groups Default Values

Chapter 54

RMON

Chapter Overview

The following topics are included in this chapter, please go to the topic for more detailed information:

- [Chapter Overview](#)
 - [An Introduction to RMON](#)
- [RMON Overview](#)
 - [Configuring rmon statistics](#)
- [Configuration Examples](#)
 - [RMON Configuration Example](#)
- [Relations with Other Modules](#)
- [List of Constants and Default Settings](#)

An Introduction to RMON

Remote Monitoring (RMON) is a standard monitoring specification that enables various network monitors and console systems to exchange network-monitoring data. The RMON was developed by the IETF to support monitoring and protocol analysis of LANs. The original version (sometimes referred to as RMON1) focused on OSI Layer 1 and Layer 2 information in Ethernet. RMON provides network administrators with more freedom to monitor the specific network-monitoring information by configuring the network-monitoring RMON agents (also called RMON probes) to meet their network-monitoring needs.

The RMON specification defines a set of statistics and functions that can be exchanged between RMON managers and RMON probes. As such, RMON can help the network administrators fault tolerant and analysis network performance information.

RMON Overview

In this device, the RMON mechanism is disabled as default on any interfaces (the interface means physical ports). Therefore, when the administrator needs to monitor the LAN traffic from specific interface, the administrator should enable the RMON mechanism on the interface. When the administrator needs to enable the RMON mechanism on the interface, the administrator has to use the command "rmon" on specific interface mode. And the administrator also can disable the RMON mechanism by use the command "no rmon".

RMON delivers information in many RMON groups of monitoring elements, each providing specific sets of data to meet particular network-monitoring requirements. Each group within the Management Information Base (MIB) is optional to be implemented. This device supports four RMON groups described as followed.

Ethernet statistics group

History group

Alarm group

Event group

Ethernet statistics Group

The Ethernet statistics group contains statistics measured by the probe for each monitored interface on this device. These statistics take the form of counters that start from zero when RMON mechanism is active. This group currently has statistics defined only for Ethernet interfaces. Each Ethernet statistic entry contains statistics for one Ethernet interface. The statistics contains the number of packets dropped, packets sent, bytes sent, broadcast packets, multicast packets, CRC errors, jabbers, collisions, and counters for packets ranging from 64 to 128, 128 to 256, 256 to 512, 512 to 1024, and 1024 to 1518 bytes.

History Group

The History group controls and stores the periodic statistical sampling of data from various types of networks. In history group, the network-monitoring administrator can define the monitored interface, polling period and viewed the stored periodic statistical sampling of data. The history group contains statistics includes the number of dropped packets, packets sent, bytes sent, broadcast packets, multicast packets, CRC errors, jabbers, collisions.

Alarm Group

The Alarm group requires the implementation of the Event group. The alarm group periodically takes statistical samples and compares them with the configured thresholds. If the monitored variable crosses the configured threshold, an event is generated. The alarm group provides the time interval, sampling type and thresholds with the network monitoring administrators to configure.

Event Group

The Event group controls the generation and operation of events from this device. Each entry in the event group describes the parameters of the event that can be triggered. Each event may optionally specify that a log be created on its behalf whenever the event occurs. And the event entry may also specify that operation should occur by way of SNMP trap messages.

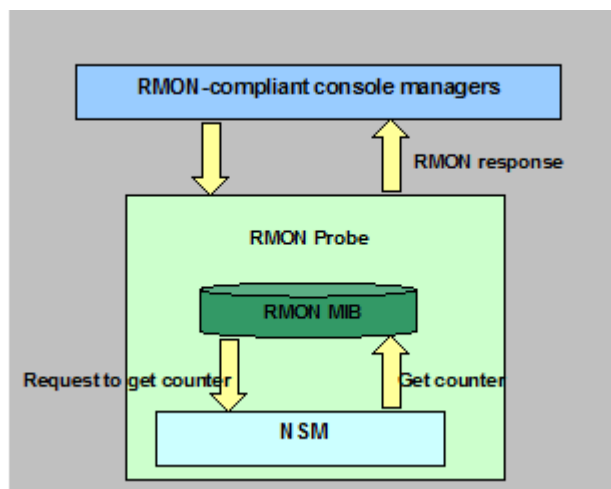

Configuring rmon statistics

This command allows the administrator to enable or disable RMON on Ethernet interfaces of the device. If the administrator enables the RMON mechanism on the specific interface, the device will automatically collect statistical information about the traffic for the interface. The administrator can also perform operations on the supported MIB RMON groups.

Command	Explanation
<code>rmon statistics</code> <i>ENTRY-NUMBER</i> [<code>owner</code> <i>NAME</i>]	Use the rmon collection stats interface configuration command to collect Ethernet group statistics.
<code>no rmon statistics</code> <i>ENTRY-NUMBER</i>	Use the no form of this command to return to disable RMON entry.

This example shows how to create two RMON entries on Ethernet interface 3.2:

```
DGS-6600>configure terminal
DGS-6600 (config)#interface eth3.2
DGS-6600 (config-if)#rmon statistics 3 owner monitor
DGS-6600 (config-if)#rmon statistics 4
```

This example shows how to disable the RMON entry on Ethernet interface 3.2:

```
DGS-6600>configure terminal
DGS-6600 (config)#interface eth3.2
DGS-6600 (config-if)#no rmon statistics 3
```

Configuration Examples

RMON Configuration Example

Remote Monitoring (RMON) is a standard monitoring specification that enables various network monitors and console systems to exchange network-monitoring data. By default the DGS-6600 RMON is enabled. In the following example we use RMON to collect ethernet group statistics.

Topology

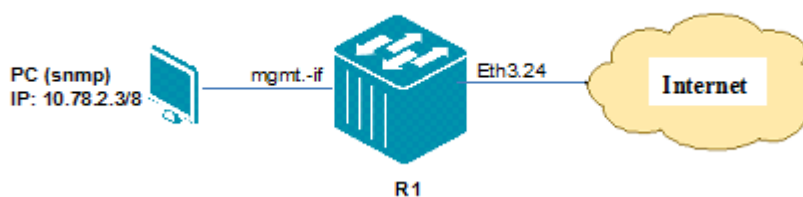

Figure 54-1 RMON Configuration Topology

R1 (Router 1) Configuration Steps

Step 1: set mgmt-if

```
DGS6600:15 (config) #mgmt-if
DGS6600:15 (mgmt-if) # ip address 10.78.2.157/8
```

Step 2: Enable SNMP

```
DGS6600:15 (mgmt-if) #snmp-server
```

Step 3: Set ethernet statistics group on eth3.24

```
DGS6600:15 (config) #interface eth3.24
DGS6600:15 (config-if) # rmon statistics 1
```

Verification

Use the following command to check ROM information.

```
DGS6600:15#show system protocol-state | include RMON
RMON                               :Enabled
```

Verifying The Configuration

Step 1: Check R1 Traffic segment configuration by command:

```
DGS-6600:15 (config-if) #show traffic-segmentation
Interface          Forwarding Interface(s)
-----
eth2.1             Forwarding to all ports
eth2.2             Forwarding to all ports
eth2.3             eth2.1, eth2.2, eth2.3, eth2.4
eth2.4             eth2.1, eth2.2, eth2.3, eth2.4
eth2.5             eth2.1, eth2.2, eth2.5, eth2.6
eth2.6             eth2.1, eth2.2, eth2.5, eth2.6
eth2.7             Forwarding to all ports
eth2.8             Forwarding to all ports
eth2.9             Forwarding to all ports
eth2.10            Forwarding to all ports
eth2.11            Forwarding to all ports
eth2.12            Forwarding to all ports
eth2.13            Forwarding to all ports
eth2.14            Forwarding to all ports
eth2.15            Forwarding to all ports
eth2.16            Forwarding to all ports
```

Step 2: It is possible to ping the various devices to determine configuration status:

PC2 (10.0.0.2/8) can ping Server (10.0.0.1/8), but cannot ping PC3 (10.0.0.3/8).

PC3 (10.0.0.3/8) can ping Server (10.0.0.1/8), but cannot ping PC2 (10.0.0.2/8).

Relations with Other Modules

- 1) Ports that are members of a port-channel cannot be specified as a forwarding interface.
- 2) If a port is currently a forwarding interface and becomes a member port of a channel group in the future, the port will no longer be an effective forwarding interface.
- 3) When a port is removed from a channel group, the port will become an effective forwarding interface.

List of Constants and Default Settings

Variable Name	Default Value
Traffic Segmentation	No segmentation. Packets received on a port can be flooded to all other ports.

Table 54-1 Default Variable Values

Chapter 55

Error Disable Port Recovery

Chapter Overview

The following topics are included in this chapter, please go to the topic for more detailed information:

- [Chapter Overview](#)
- [An introduction to Error Disable Port Recovery](#)
- [Error Disable Port Recovery Configuration Commands](#)
- [Configuring Error Disable Port Auto Recovery](#)
- [Displaying Error Disable Status](#)
- [List of Constants and Default Settings](#)

An introduction to Error Disable Port Recovery

A physical port may be put in the error disabled state if a violation takes place. When a port is in the error disabled state, the port cannot transmit or receive any traffic. When a physical port is in the error disabled state, the port can be recovered manually by applying the **shutdown** and the **no shutdown** command. The mechanism described in this chapter is used to automatically recover an error disabled port.

Error Disable Port Recovery Configuration Commands

Configuring Error Disable Port Auto Recovery

The user can configure a port to automatically recover from an error disabled state. If a port is error disabled due to a violation, the port cannot transmit or receive any traffic. With automatic recovery, the port will be recovered after the specified timer has expired. Automatic recovery can be individually controlled for different reasons.

The following commands are used to configure the auto recovery settings for an error disabled ports

Command	Explanation
<code>errdisable recovery cause {all loopback-detection} [interval SECONDS]</code>	Configures the auto recovery settings of an error disabled port.
<code>show errdisable recovery</code>	Displays the auto recovery settings that will be used on error disabled ports.

In the following example, the user specifies that a port should recover from an error-disabled state after 300 seconds, if a loop-back packet is detected:

```
dgs-6600:2>enable
dgs-6600:15#configure terminal
dgs-6600:15 (config)#errdisable recovery interval 300
dgs-6600:15 (config)#errdisable recovery cause loopback-detection
dgs-6600:15 (config)#end
```

Displaying Error Disable Status

The user can display the port's error disabled status. If a port is currently in the error disabled state, the reason that caused the error disabled state is also displayed.

The following command is used to display the error disable status for all ports on the Switch:

Command	Explanation
<code>show errdisable recovery</code>	Displays the error disabled configuration.

In the following example, the user displays the error disable status:

```
dgs-6600:2>show errdisable recovery

ErrDisable Reason   Timer Status   Timer Interval
-----
loopback-detection  enable        200 seconds

Interfaces that will be recovered at the next timeout:

Interface           Errdisable Reason  Time Left(sec)
-----
eth2.4              loopback-detection 179

Total Entries:1
dgs-6600:2>
```

List of Constants and Default Settings

Variable Name	Default Value
Error Disable Interval	300 Seconds
Error Disable Port Recovery	Disabled

Table 55-1 Default Variable Values

Chapter 56

Traffic Storm Control

Chapter Overview

The following topics are included in this chapter, please go to the topic for more detailed information:

- [Chapter Overview](#)
- [An Introduction to Traffic Storm Control](#)
- [Traffic Storm Configuration Commands](#)
 - [Configuring the Traffic Storm Control Timer](#)
 - [Enabling Traffic Storm Control on an Interface](#)
 - [Displaying the Traffic Storm Control Settings](#)
- [Relations with Other Modules](#)
- [List of Constants and Default Settings](#)

An Introduction to Traffic Storm Control

Traffic Storms are used to describe the situation when a network is flooded by packets. Packet floods cause excessive traffic on the network, which degrades the performance of the network. To prevent this situation, the Switch features a traffic storm control feature. Depending on how the traffic storm control function is configured, when the traffic storm control feature is enabled, any disruptions to a port can be alleviated in the event of a broadcast, multicast, or unicast traffic storm occurring on a physical interface.

The traffic storm control feature (also known as traffic suppression) have two actions that are drop and shutdown to take works by monitoring the level of incoming traffic. The traffic storm control feature will monitor the level for each specified traffic type in traffic storm control intervals of 1 second at drop action, and the shutdown action monitor intervals is dependant on the configuration, the default time interval is 5 seconds.

The traffic storm control supports two kinds of detection mod (level or a PPS).

Level: Specifies the rising threshold as a percentage of total bandwidth of the port.

PPS: specifies the rising threshold as a rate in packets per second at which traffic is recieved on the port. the range of PPS is from 1 to 148810 (for 100 Mbps). For 1000 Mbps, the range is 1 to 1488100 and so forth.

In order to enable the traffic storm control features to monitor traffic levels, the user needs to define the type of traffic that needs to be monitored. All packets are passed in default. After enable traffic storm control is enabled, packets exceeding the level will be dropped if the storm control action is drop, if the interface is set to shutdown, the action will be shutdown. The default action is too drop.

The shutdown action is only available for broadcast and multicast storm control. For unicast storm control, software levels are unable to identify unknown unicast (DLF) storm events due to hardware chip support. Exceeded, unknown unicasts will always be dropped.

If the action option is set to shutdown, the port will enter shutdown mode (port is blocked) when the threshold is exceeded. When a port is in "shutdown mode", before the port entered into shutdown

forever mode, if the receiving rate is higher than the falling threshold (80% of threshold) the port will be recovered immediately.

If the port is in block state, the traffic rate has become higher than the threshold for a configurable period (countdown timer), the port will go into shutdown forever mode (the port is disabled, the state is link down). The user can define the recovery time, if the recovery times value is non-zero, the port will automatically recover, entering a state that is the same as the normal situation (after recovery time). If recovery times are not set the port will not be automatically recovered. it can instead be recovered by “no shutdown” command.



NOTE: The traffic storm control function is disabled by default.

Traffic Storm Configuration Commands

Configuring the Traffic Storm Control Timer

The traffic storm control features uses a number of timers to implement the shutdown action that will be taken.

The following command is used to configure the storm control timer options:

Command	Explanation
<code>storm-control {time-interval SECONDS countdown SECONDS recover-time SECONDS}</code>	Specifies the storm control timer options.

In the following example, the user configures the amount of time that the software will monitor the counters for all traffic storm traffic to be 15 seconds, the amount of time that the port will remain in shutdown mode to be 180 seconds, and specifies that port will automatically recover after 300 seconds when it is in shutdown forever mode:

```
DGS-6600:2>enable
DGS-6600:15#configure terminal
DGS-6600:15(config)#storm-control time-interval 15
DGS-6600:15(config)#storm-control countdown 180
DGS-6600:15(config)#storm-control recover-time 300
DGS-6600:15(config)#end
```

Enabling Traffic Storm Control on an Interface

After configuring the global traffic storm control settings, the user needs to select the interfaces that the traffic storm control feature will be enabled on

The following commands are used to enable the traffic storm control feature on an interface:

Command	Explanation
<code>storm-control {broadcast multicast unicast}</code>	Specifies the traffic storm control type that will be enabled on the interface.
<code>storm-control {broadcast multicast unicast} level {LEVEL pps PPS}</code>	Configures the rising threshold for the traffic storm control function.
<code>storm-control {broadcast multicast} action {drop shutdown}</code>	Configures the action that should be taken by the traffic storm control function if the packet rate exceeds the defined level.

In the following example, the user enables broadcast storm control on interface port 4.1, specifies a percentage threshold value of 90, specifies the PPS threshold value of 500, and specifies that the port will be shutdown if the packet rate exceeds the defined level:

```
DGS-6600:2>enable
DGS-6600:15#configure terminal
DGS-6600:15 (config)#interface eth4.1
DGS-6600:15 (config-if)#storm-control broadcast
DGS-6600:15 (config-if)#storm-control broadcast level 90
DGS-6600:15 (config-if)#storm-control broadcast level pps 500
DGS-6600:15 (config-if)#storm-control broadcast action shutdown
DGS-6600:15 (config-if)#end
```

Displaying the Traffic Storm Control Settings

The following command is used to display the current traffic storm control settings:

Command	Explanation
<code>show storm-control [interface [INTERFACE-ID][, -] [broadcast multicast unicast]]</code>	Displays the current storm control settings.

In the following example, the user displays the storm control settings for broadcasts:

```
DGS-6600:2>show storm-control interface broadcast

Interface      Storm      Action      Type      Threshold
-----
eth4.1         Broadcast  Shutdown    pps       500

Total Entries: 1
DGS-6600:2>
```

In the following example, the user displays the storm control settings for all interfaces:

```
DGS-6600:2>show storm-control interface

Interface          Storm      Action      Type          Threshold
-----          -
eth4.1             Broadcast  Shutdown    pps           500

Total Entries: 1
DGS-6600:2>
```

In the following example, the user displays the storm control settings for the range of Ethernet interfaces 4.1 to 4.3:

```
DGS-6600:2>show storm-control interface eth4.1-4.3

Interface          Storm      Action      Type          Threshold
-----          -
eth4.1             Broadcast  Shutdown    pps           500

Total Entries: 1
DGS-6600:2>
```

In the following example, the user displays the storm control global settings:

```
DGS-6600:2>show storm-control
Time Interval      : 15 seconds
Countdown Timer    : 180 seconds
Auto Recover Time  : 300 seconds
DGS-6600:2>
```

Relations with Other Modules

- 1) Can be enabled on both physical ports and port channels.
- 2) Cannot be enabled on individual ports in a port-channel.
- 3) If the traffic storm control function is using shutdown forever mode to shutdown a port, the user will need to manually enable the port using the **no shutdown** command in interface configuration mode.

List of Constants and Default Settings

Variable Name	Default Value
Interface Storm Control	Disabled

Table 56-1 Default Variable Values

Variable Name	Default Value
Default Storm Control Level	131072 pps
Default Storm Control Action	Drop
Default Time Interval	5 seconds
Default Countdown Timer	0 seconds
Default Recover Time	0 seconds

Table 56-1 Default Variable Values



Part 11- System Management

The following chapters are included in this volume:

- **File System**

Chapter 57

File System

Chapter Overview

The following topics are included in this chapter, please go to the topic for more detailed information:

- [Chapter Overview](#)
- [An Introduction to the File System](#)
- [File System Configuration Commands](#)
 - [Managing Configuration Files](#)
 - [Managing the Running Configuration](#)
 - [Saving Running Configuration to a File](#)
 - [Applying Configuration File to Running Configuration](#)
 - [Clearing the Running Configuration](#)
 - [Setting the Boot Configuration File](#)
- [Loading Configuration Files](#)
 - [Downloading Configuration File using TFTP](#)
 - [Uploading Configuration File using TFTP](#)
- [Managing Image Files](#)
 - [Boot Image List](#)
 - [Verifying the File Header Information](#)
 - [Deleting Image Files](#)
- [Loading Image Files](#)
 - [Downloading Image Files using TFTP](#)
 - [Uploading Image Files Using TFTP](#)
 - [Rebooting the Switch](#)
- [List of Constants and Default Settings](#)

An Introduction to the File System

The DGS-6600 Series Switch uses a FAT32 file system for storing system files. The storage media supported by the Switch include the on-board flash and the optional flash cards. The user can use the file system commands to manage configuration files, image files, Syslog files, etc. The following table describes the names that the Switch assigns for each type of storage media:

Storage Type	Drive Name
On-board Flash	flash
Slot 1 Compact Flash	cf1

Table 57-1 Representative Drive for Each Storage Type

File System Configuration Commands

The following commands are used to manage the file system:

Command	Explanation
<code>dir [FILE-SYSTEM:] [PATH-NAME [FILE-NAME]]</code>	Displays information for a file or a list of files in the specified path name.
<code>delete [FILE-SYSTEM:] [PATH-NAME FILE-NAME]</code>	Used to delete a file on the Switch.
<code>copy SOURCE-URL DESTINATION-URL</code>	Used to copy files on the Switch.



NOTE: The specified URL must be represented by an absolute path. The specified URL cannot be represented by a relative path.

The following example displays the list of files in the root directory of the file system on the system's flash:

```
DGS-6600:2>dir flash:\
log                               <DIR>
images                            <DIR>
configurations                    <DIR>
DGS-6600:2>
```

The following example copies the file called "dgs-6604_log.txt", stored in the on-board flash memory, to a file called "dgs-6604_log.txt" on the card inserted in compact flash slot 1 (CF1):

```
DGS-6600:15#copy flash:\log\system_log.txt cf1:\system_log.txt

Copy from flash:\log\system_log.txt to cf1:\system_log.txt .....done
DGS-6600:15#
```

The following example deletes the file name "test" from the flash card inserted in CF1:

```
DGS-6600:15#delete cf1:\test
Delete cf1:\test (y/n) [n]?y
DGS-6600:15#
```

Managing Configuration Files

The device initializes with the default configuration. When the user changes the configuration, the updated configuration will automatically be stored in DRAM. This copy of the configuration is called the running configuration.

The running configuration can be stored in the Switch's file system. One of the stored configuration file can be specified to be reloaded as running configuration. This file is referred to as the boot configuration file.

Managing the Running Configuration

The **show running-config** command displays the contents of the current running configuration file.

Command	Explanation
<code>show running-config</code>	Displays the contents of the current running configuration file.

The following example displays the contents of the current running configuration file at privilege 15:

(Continued from Previous Page)

```
DGS-6600:15#show running-config
Building configuration...
Current configuration:
version 2.10.011

#Slot  Model
#----  -
# 1     DGS-6600-CM
# 2     -
# 3     -
# 4     DGS-6600-48P
!
!
!
!
mgmt-if
  ip mtu 1600
!
maximum-paths 1
spanning-tree mst 0 priority 0
logging host 10.1.2.111 severity warning
ip dhcp relay information policy drop
ip dhcp relay hops 5
snmp server 10.73.87.99

clock summer-time date 29 Mar 02:00 25 Oct 02:00
clock timezone + 8
snmp-server
system-name core-switch
snmp-server location hq
snmp-server contact sys-admin
snmp-server enable traps
snmp-server view testsnmpv3 1.3.6.1.6 included
snmp-server view testsnmpv3 1.3.6.1.2.1 included
snmp-server view testsnmpv3 1.3.6.1.6.3.18 excluded
snmp-server group snmpgroup1 v3 auth read testsnmpv3
snmp-server user dlink snmpgroup1 v3 auth md5 pw123
snmp-server host 172.16.1.27 version 2c public
snmp-server host 172.16.1.33 public
!
vlan-tunnel
!
vlan 2
  vlan name IT-Support
!
vlan 3
!
vlan 5
  mac-base 00-11-22-33-ab-cd
!
vlan 6
  subnet-base 20.0.1.0/8
  subnet-base 192.168.1.0/24
!
vlan 99
  subnet-base 10.0.0.0/8
!
```

(Continued from Previous Page)

```
vlan 100
!
ip pim register-checksum-include-data
!
time-range lunch-time
  periodic daily 12:00 to 13:00
!
mac access-list extended Block-Server
  deny    host 00-1d-60-a1-37-b5 host 00-1a-92-24-80-f7 priority 10
  permit  any any priority 20
!
ip access-list extended Web-Management
!
ip access-list extended server-security
  permit  tcp 192.168.50.0 255.255.255.0 eq 80 host 192.168.0.222 priority 1
  deny    tcp host 192.168.0.222 eq 80 192.168.50.0 255.255.255.0 priority 3
  deny    tcp host 192.168.0.121 eq 80 192.168.50.0 255.255.255.0 priority 5
!
ip access-list IT-Management
  permit  host 192.168.50.222 host 192.168.50.1 priority 10
  deny    any host 192.168.50.1 priority 20
!
interface eth4.2
  access vlan 2
!
interface eth4.3
  access vlan 3
  channel-group 5 mode on
  ip access-group IT-Management in
!
interface eth4.4
  description link to D-link PC
  access vlan 99
!
interface eth4.5
  access vlan 3
  spanning-tree tcnfilter
!
interface eth4.6
  access vlan 3
!
interface eth4.7
  access vlan 3
!
interface eth4.8
  access vlan 3
!
interface eth4.10
  dot1x timeout quiet-period 20
  dot1x timeout tx-period 10
  dot1x timeout server-timeout 15
  dot1x timeout reauth-period 1000
  dot1x pae authenticator
!
interface eth4.12
  vlan-tunnel tpid 0x88a0
  mac access-group Block-Server in
!
```

(Continued from Previous Page)

```
interface eth4.17
  dot1x max-req 3
!
interface eth4.20
  flowcontrol send on
  spanning-tree cost 20000
  spanning-tree mst 0 cost 17031970
!
interface eth4.22
  vlan-tunnel interface-type uni
  vlan encapsulation 2 4
  shutdown
  no spanning-tree
!
interface eth4.23
  vlan-tunnel interface-type uni
  vlan remarking 8 9
  no spanning-tree
!
interface eth4.24
  duplex full
  vlan-tunnel interface-type uni
  cos remarking 2 4
  no spanning-tree
!
interface eth4.32
  dot1x forward-pdu
!
interface eth4.33
  acceptable-frame tagged-only
  trunk allowed-vlan 2
  pvid 2
  vlan-tunnel interface-type uni
  vlan-tunnel ingress-checking
  no spanning-tree
!
interface eth4.40
  dot1x port-control force-authorized
!
interface eth4.43
  dot1x control-direction in
  dot1x re-authentication
!
interface eth4.45
  speed 100
!
interface eth4.46
  max-rcv-frame-size 6000
!
interface eth4.47
  access vlan 99
  spanning-tree guard root
!
interface eth4.48
  trunk allowed-vlan 2
  traffic-segmentation forward interface eth4.1,eth4.2,eth4.3,eth4.4,eth4.5,eth4.6,eth4.7
!
```

(Continued from Previous Page)

```

interface port-channel5
  access vlan 3
!
interface vlan2
  ip mtu 6000
!
interface vlan99
  description link to LAN
  ip address 10.73.87.100/8
!
interface vlan100
  ip dhcp relay address 10.1.1.1
!
?ip route 0.0.0.0/0 10.1.1.254
!
resequence access-list server-security 1 2
!
monitor session 1 destination interface eth4.2
monitor session 1 source interface eth4.3 tx
monitor session 1 source interface eth4.10 tx
monitor session 1 source interface eth4.3 rx
monitor session 1 source interface eth4.10 rx
monitor session 2 destination interface eth4.9
!
!
end
DGS-6600:15#

```

Saving Running Configuration to a File

The **copy running-config** command can be used to save the running configuration to a file on a remote server or local storage device.

Command	Explanation
copy running-config <i>DESTINATION-URL</i>	Used to copy the running configuration file to a file on a remote server or local storage device.

The following example copies the running configuration to a file called "switch-config.txt" in the "config" directory of the TFTP server with the IP address 10.1.1.254:

```

DGS-6600:15#copy running-config tftp://10.1.1.254/config/switch-config.txt
Upload configuration to tftp://10.1.1.254/config/switch-config.txt, (y/n) [n]? y
Configuration has been copied successfully.
DGS-6600:15#

```

Applying Configuration File to Running Configuration

The Switch allows a configuration file from a remote server to be copied to the running configuration or local storage device.

Command	Explanation
<code>copy SOURCE-URL running-config</code>	Copies a configuration file from a remote server to be the running configuration or local storage device.

Clearing the Running Configuration

The **clear running-config factory-defaults** command is used to clear the system configuration retained in DRAM. Executing the **clear running-config factory-defaults** command (at privilege level 15) causes all the all configuration information to be cleared.

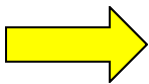

NOTICE: Ensure that a backup of the configuration is made using the copy command or that a configuration profile is uploaded before using the clear running-config command. When the clear running-config command is executed, the Switch will reset the running configuration back to factory default setting.



NOTE: Since the clear running-config command clears all system configuration settings including IP parameters. All the applications that are being used to manage the Switch will lose connection, due to the reset of the Switch IP address. Therefore, the user is recommended to implement a configuration file reload after executing the clear running-config command.

Use the following command in global configuration mode to clear the system running configuration:

Command	Explanation
<code>clear running-config factory-defaults</code>	Clears the system running configuration.

The following example clears the system running configuration:

```
DGS-6600:15#clear running-config factory-defaults
This command will clear all of system configuration as factory default setting
including IP parameters.
Do you want to continue (y/n) [n]? y
  devinfo ...
  dos ...
  web ...
  snmp ...
  slog ...
  ospf6 ...
  ripng ...
  dhcpc6 ...
  dhcpr6 ...
  dvmrp ...
  pim ...
  pdm ...
  bgp ...
  ospf ...
  rip ...
  sflow ...
  dhcps4 ...
  dhcpr4 ...
  dhcpc4 ...
  sntp ...
  erps ...
  traffic segmentation ...
  bandwidth control ...
  storm ...
  mirror ...
  plock ...
  acl ...
  mstp ...
  lacp ...
  asd ...
  common ...
DGS-6600:15#
```

Setting the Boot Configuration File

One of the configuration files in the file system can be specified as the configuration that be reloaded after the next reboot. This is referred to as the start-up configuration.

During the bootup process, if the boot configuration is not specified, does not exist, or is corrupt, the system will be initialized with the default settings.

The **boot config** command is used to specify the boot configuration file and overwrites the previous setting:

Command	Explanation
boot config <i>MEDIA: URL</i>	Specifies the boot-up configuration file.
show boot	Displays the software image and configuration file that the Switch will use next time the Switch boots up.
show startup-config	Display the contents of the system configuration file that has been specified by the boot config command.

In the following example, the user configures the Switch to use the configuration file called *def-usr.conf* when the Switch boots up:

```
DGS-6600:2>enable
DGS-6600:15#configure terminal
DGS-6600:15 (config) #boot config flash:\configurations\def_usr.conf
Success.
DGS-6600:15 (config) #end
DGS-6600:15#show boot
Boot loader version:1.00.007
Boot config:flash:\configurations\def_usr.conf
Boot image:flash:\images\runtime.2.10.011_DGS-6600.had
DGS-6600:15#end
```

Loading Configuration Files

Downloading Configuration File using TFTP

The following command is used to download a configuration file using TFTP:

Command	Explanation
<code>copy tftp:\\IP-ADDRESS\[DIRECTORY\ FILENAME DESTINATION-URL</code>	Downloads configuration file from a TFTP server.

The following example configures the running-configuration to use a configuration file called *switch-config.txt* that has been downloaded from a TFTP server with the IP address 10.1.1.254:

```
DGS-6600:15#copy tftp://10.1.1.254/config/switch-config.txt running-config
Configure using 10.1.1.254/config/switch-config.txt (y/n) [n]? y
Finished network download. (5709 bytes)
Apply to system configuration.
Reset configuration...Please Wait!
devinfo ...
dos ...
web ...
snmp ...
slog ...
ospf6 ...
ripng ...
dhcpc6 ...
dhcpr6 ...
dvmrp ...
pim ...
pdm ...
bgp ...
ospf ...
rip ...
sflow ...
dhcps4 ...
dhcpr4 ...
dhcpc4 ...
sntp ...
erps ...
traffic segmentation ...
bandwidth control ...
storm ....
mirror ...
plock ...
acl ...
mstp ...
lacp ...
asd ...
common ...
Reset configuration completed!
Execute configurations....Please wait!
Completed.
DGS-6600:15#
```



NOTE: Remember to use the Management Interface Mode under Global Configuration, if the connection to the LAN is from the Out-of-Band Management Port. i.e. use the same command as above but with the prompt: **DGS-6600:15(mgmt-if)#**

The following example configures the startup-configuration to use a configuration file called *switch-config.txt* that has been downloaded from a TFTP server with the IP address 10.1.1.254:

```
DGS-6600:15#copy tftp://10.1.1.254/config/switch-config.txt startup-config
Save system configuration (y/n) [n]? y
Configuration has been copied successfully.
DGS-6600:15#
```

Uploading Configuration File using TFTP

The following command is used to upload a configuration file to a TFTP server:

Command	Explanation
<code>copy running-config tftp://IP-ADDRESS/[DIRECTORY/] FILENAME DESTINATION-URL</code>	Uploads configuration file to a TFTP server.

The following example uploads the running configuration to a TFTP server for storage:

```
DGS-6600:2>enable
DGS-6600:15#copy running-config tftp://10.1.1.254/config/switch-config.txt
Upload configuration to tftp://10.1.1.254/config/switch-config.txt, (y/n) [n]? y
Configuration has been copied successfully.
DGS-6600:15#
```

The following example uploads the startup-config configuration to a TFTP server for storage:

```
DGS-6600:15#copy startup-config tftp://10.18.96.151/switch-config.txt
Upload startup configuration to tftp://10.18.96.151/switch-config.txt, (y/n) [n]
Configuration has been copied successfully.
DGS-6600:15#
```

Managing Image Files

Boot Image List

The boot image list contains a list of image files, with one image acting as the primary image and others as secondary and tertiary boot images, providing a reliable boot image from the Switch to select from.

When the system starts up, the boot loader will attempt to load the primary image. If the loading fails due to file corruption or if the file is absent, the boot loader will attempt to load the secondary image file. If the secondary file fails then the boot loader selects the tertiary image to load.

Showing the Boot Image List

To view the available boot images that the Switch has to select from when booting use the `show boot` command.

Command	Explanation
<code>show boot</code>	<p>Displays the current files used by the switch when booting including the:</p> <ul style="list-style-type: none"> • Boot Loader • Boot Config • Boot Image

The following example shows the `show boot` command issued and its output. The boot loader version is `1.00.007`, the configuration file is `flash:\configurations\def_usr.conf`, and the primary boot image is `flash:\images\runtime.2.10.011_DGS-6600.had`.

```
DGS-6600:15#show boot
Boot loader version:1.00.007
Boot config:flash:\configurations\def_usr.conf
Boot image:flash:\images\runtime.2.10.011_DGS-6600.had
DGS-6600:15#
```

Verifying the File Header Information

When the **boot image** command is issued, the associated boot image file will become the primary boot-up image file, with the previous primary boot image file becoming the secondary boot up image. If the Switch has three image files in the image list and the **boot image** command is reissued, the original tertiary boot image file will be removed from the boot image list.

However, if the last tertiary boot image is the only image left in the system, the image will not be removed from the boot image list as there must be at least one system flash image file in the boot image list.

Use the following command to configure the primary boot-up image:

Command	Explanation
<code>boot image MEDIA: URL</code>	Specifies the file that will be used as the image file for the next boot up.

The following example specifies that the Switch should use the image file named `runtime.1.00.024_DGS-6600.had` as the boot image file for the next startup boot image. The previous boot image, `flash:\images\runtime.2.10.011_DGS-6600.had`, will turn into the secondary boot image file in the list and will operate as the first backup boot image:

```
DGS-6600:15#configure terminal
DGS-6600:15(config)#boot image flash:\images\runtime.2.10.011_DGS-6600.had
Checking image at local flash:\images\runtime.2.10.011_DGS-6600.had ... Done.
Update bootlist ..... Done.

Success
DGS-6600:15(config)#end
```

Deleting Image Files

The image file in the boot-up image list cannot be deleted. If the user needs to delete an image file from the boot image list, the user needs to use the **boot image** command to remove the file at the bottom of the boot image list.

The following example specifies that the Switch should use the image file named *runtime.2.10.0.10_DGS-6600.had* as the boot image file for the next startup boot image. The last boot image in the boot image list will be removed from the boot image list:

```
DGS-6600:15 (config)#show boot
Boot loader version:1.00.005
Boot config:flash:\configurations\def_usr.conf
Boot image:flash:\images\runtime.2.10.011_DGS-6600.had,cf1:\runtime.2.00.022_DGS -
6600.had,cf1:\runtime.2.10.004_DGS-6600.had
DGS-6600:15 (config)#
DGS-6600:15 (config)#boot image cf1:\runtime.2.10.010_DGS-6600.had
Checking image at local cf1:\runtime.2.10.010_DGS-6600.had ... Done.
Update bootlist ..... Done.

Success
DGS-6600:15 (config)#show boot
Boot loader version:1.00.005
Boot config:flash:\configurations\def_usr.conf
Boot image:cf1:\runtime.2.10.010_DGS-6600.had,flash:\images\runtime.2.10.011_DGS-
6600.had,cf1:\runtime.2.00.022_DGS-6600.had
DGS-6600:15 (config)#
```

Loading Image Files

Downloading Image Files using TFTP

The following command is used to download an image file from a TFTP server:

Command	Explanation
<code>copy tftp:\\IP-ADDRESS\[DIRECTORY\] FILENAME DESTINATION-URL</code>	Downloads configuration file from a TFTP server.

Rebooting the Switch

The **reboot** command can be used to reboot the entire Switch or a module installed in a specified slot. If no slot ID is specified, all of the modules in the system will be rebooted:

Command	Explanation
<code>reboot [unit <i>SLOT_RANGE</i>]</code>	Uploads configuration file to a TFTP server.

In the following example, the user reboots the whole system:

```
DGS-6600:15#reboot

Warning: This command will cause system reboot.
Do you want to continue (y/n) [n]?y
Save log message before reboot(y/n) [n]?n
```

In the following example, the user reboots unit1:

```
DGS-6600:15#reboot unit 1

Warning: This command will cause system reboot.
Do you want to continue (y/n) [n]?y
Save log message before reboot(y/n) [n]?n
```

List of Constants and Default Settings

Constant Name	Value
Number of Boot Image Files	3

Table 57-2 Constants Values

Variable Name	Default Value
Default Boot Configuration	flash:\configuration\def_usr.conf
Default Boot Image Lists	flash:\images\runtime.3.00.080_DG S-6600.had (please note that the file name is dependant on the runtime version.)

Table 57-3 Default Variable Values



Part 12- Troubleshooting

The following chapters are included in this volume:

- **Displaying System Information**
- **Logging System Messages**
- **Port Mirroring**
- **Remote Switching Port Analyzer (RSPAN)**
- **Testing Network Connectivity**
- **Debug Information to Compact Flash**

Chapter 58

Displaying System Information

Chapter Overview

The following topics are included in this chapter, please go to the topic for more detailed information:

- [Chapter Overview](#)
 - [An Introduction to Displaying Information](#)
 - [Information Categories](#)
- [Displaying System Information Configuration Commands](#)
 - [Using the show system command](#)
 - [Using the show unit command](#)
 - [Using the show version command](#)
 - [Using the show environment](#)
 - [Example display output from the show running-config command](#)

An Introduction to Displaying Information

This chapter describes the commands used to display system or on-site information that may be useful for troubleshooting problems.

Information Categories

The Switch can display information about the following categories:

- Model of the Chassis
- MAC addresses allocated to the entire chassis and MAC addresses allocated to the inserted card.
- General information about the Control Management Unit or I/O cards inserted in the chassis. The information includes the model, operation status, and the time the card was inserted.
- Memory usage status for DRAM, Flash memory, or NVRAM on each card.
- Version and serial number information for backplane and inserted cards.
- Operation status of fans, temperatures, and power supply.
- Remote or local console sessions active in managing device.
- Running Configuration information.

Displaying System Information Configuration Commands

The following commands are used to display system information:

Command	Explanation
<code>show system</code>	Displays the following information about the Switch: <ul style="list-style-type: none">• Switch Type.• MAC addresses allocated to the chassis.• Hardware Version of the inserted cards.• Bootloader Version of the inserted cards.• Firmware Version of the inserted cards.• Serial Number of the inserted cards.• Model Name of insert cards.• MAC addresses allocated to the inserted cards.
<code>show unit</code>	Displays general information and memory usage about the inserted cards.
<code>show version</code>	Displays the versions and serial numbers of the inserted cards.
<code>show environment</code>	Displays the operating status of the fans, the temperature of the inserted cards, and the status of the power supplies.
<code>show user-session [console telnet ssh http https]</code>	Displays the remote or local console sessions that are currently managing the device.
<code>show running-config</code>	Displays the contents of the current running configuration file.

Using the show system command

The following example displays the output from the **show system** command:

```
DGS-6600:2>show system

Device Type                :Chassis-based High-Speed Switch

Hardware Version           :A1

S/N                        :P4YZ1C3000003
First MAC Address          :28:10:7B:DC:90:00
Number of MAC Address(es) :4096

Slot: 1
Hardware Version           :A1
Bootloader Version         :1.00.007
Firmware Version           :2.10.011
S/N                        :QT0X1C3000001
Model Name                 :DGS-6600-CM
First MAC Address          :cc:b2:55:03:3f:84
Number of MAC Address(es) :1

Slot: 3
Hardware Version           :A1
Bootloader Version         :1.00.008
Firmware Version           :2.10.011
S/N                        :QT101C3000010
Model Name                 :DGS-6600-48T
First MAC Address          :14:d6:4d:61:c9:10
Number of MAC Address(es) :48

DGS-6600:2>
```

Using the show unit command

The following example displays the output from the **show unit** command:

```
DGS-6600:2>show unit
```

Slot	Model	Status	Up-Time
1	DGS-6600-CM	ok	0DT0H38M0S
2	-	-	-
3	DGS-6600-48T	ok	0DT0H37M28S
4	-	-	-

Slot	Model	Description
1	DGS-6600-CM	CPU/Fabric Management Module
2	-	-
3	DGS-6600-48T	48-port GE Copper Module
4	-	-

Slot	DRAM			FLASH		
	Total	Used	Free	Total	Used	Free
1	2074152k	1214512k	859640k	996112k	56160k	939952k
2	-	-	-	-	-	-
3	516004k	453828k	62176k	-	-	-
4	-	-	-	-	-	-

```
DGS-6600:2>
```

Using the show version command

The following example displays the output from the **show version** command:

```
DGS-6600:2>show version

DGS-6600 System Version

Backplane H/W version:A1   PCBA version:1   CPLD version:2
Serial#:P4YZ1C3000003

Slot  Module Type          Versions
-----
1      DGS-6600-CM             Serial#:   QT0X1C3000001
                                     H/W:      A1
                                     PCBA:     1
                                     Bootloader: 1.00.007
                                     Runtime:   2.10.011
                                     CPLD:     ver-1

2      -                    -
3      DGS-6600-48T         Serial#:   QT101C3000010
                                     H/W:      A1
                                     PCBA:     6
                                     Bootloader: 1.00.008
                                     Runtime:   2.10.011
                                     CPLD:     ver-4

4      -                    -
DGS-6600:2>
```

Using the show environment

The following example displays the output from the **show environment** command:

```
DGS-6600:2>show environment

Environmental Status

Slot Inlet temperature          Center temperature          Outlet temperature
      current/operation range  current/operation range    current/operation range
-----
1     36 C/0 ~75 C              34 C/0 ~75 C              N/A
2     N/A                      N/A                      N/A
3     40 C/0 ~70 C              43 C/0 ~80 C              43 C/0 ~80 C
4     N/A                      N/A                      N/A

Status code: * temperature is out of operation range

Fans are operation in normal speed

Failed Fans: None

Power module      #1          #2          #3          #4
-----
Power status      in-operation empty        empty        empty
Max power         850         W -         -         -
Used power        117         W -         -         -

DGS-6600:2>
```

The following example displays the output from the **show user-session** command:

```
DGS-6600:2>show user-session
UI Codes: co - console, h - http, hs - https, s - ssh, te - telnet

  ID Login Time          From          UI Level  Username
-----
  0 09:08:40 01/11/10    0.0.0.0      co 2      anonymous
* 5 09:09:04 01/11/10    10.73.87.1   te 2      anonymous

Total Entries: 2
DGS-6600:2>
```

Example display output from the show running-config command

The following example displays the output from the **show running-config** command:

```
DGS-6600:15#show running-config
```

```
Building configuration...
```

```
Current configuration:
```

```
version 2.10.011
```

```
#Slot Model
```

```
#---- -
```

```
#1 DGS-6600-CM
```

```
#2 -
```

```
#3 DGS-6600-48T
```

```
#4 -
```

```
!
```

```
!
```

```
!
```

```
!
```

```
!
```

```
end
```

```
DGS-6600:15#vlan-tunnel
```

```
!
```

```
vlan 2
```

```
 subnet-base 192.168.2.0/24
```

```
!
```

```
vlan 5
```

```
 subnet-base 172.16.0.0/16
```

```
!
```

```
vlan 20
```

```
 subnet-base 10.0.0.0/8
```

```
!
```

```
vlan 21
```

```
!
```

(OUTPUT OMITTED)

```
!  
interface eth5.47  
  access vlan 2  
!  
interface eth5.48  
  description OSPF-Link-To-DGS-3828  
  access vlan 5  
!  
interface vlan2  
  ip address 192.168.2.1/24  
!  
interface vlan20  
  description Backbone-VLAN  
  ip address 10.90.90.100/8  
!  
interface vlan301  
  ip address 192.168.0.1/24  
!  
interface vlan505  
  ip address 192.168.50.1/24  
!  
end
```

Chapter 59

Logging System Messages

Chapter Overview

The following topics are included in this chapter, please go to the topic for more detailed information:

- [Chapter Overview](#)
- [An Introduction to Logging System Messages](#)
- [Logging System Messages Configuration Commands](#)
 - [Logging System Messages Configuration Commands](#)
 - [Managing Messages in the Local Buffer](#)
 - [Logging System Messages to a Syslog Server](#)
- [List of Constants and Default Settings](#)

An Introduction to Logging System Messages

During operation, the Switch will record any pre-defined events that have occurred on the Switch in the form of system messages. These messages can provide the administrator with information that may be useful for understanding what is happening on the network, therefore helping the administrator to troubleshoot any potential problems. Due to the broad coverage of reported events, the system messages enable the administrator to isolate many kinds of problems, regardless of whether they are hardware or software related. The system messages are associated with a severity level. Distinguishing messages with different severity levels, allows the administrator to efficiently manage the system messages.

Whenever an event occurs on the Switch, a message that describes the event will be sent to the Syslog process. On receiving the Syslog message, the Syslog process will add a time stamp to the message. The user can choose to log the system messages in the local buffer and can also specify if system messages should be reported to a Syslog server.

The system message can be reported by many functional modules operating on the Switch. A system message will encode the date, time, and message content.

Every system message has a severity, it represents the severity level of the message. (The different severity levels for messages are described in [Table 59-1](#))

Level Number	Severity Level	Description
0	Emergency	System is unusable.
1	Alert	Action must be taken immediately.
2	Critical	Critical conditions.
3	Error	Error conditions.
4	Warning	Warning conditions.
5	Notice	Normal but significant conditions.

Table 59-1 Descriptions of Severity Levels for Syslog Error Messages

Level Number	Severity Level	Description
6	Informational	Informational messages.
7	Debugging	Debugging messages.

Table 59-1 Descriptions of Severity Levels for Syslog Error Messages (continued)

Logging System Messages Configuration Commands

The following topics are included in this section.

- [Logging System Messages Configuration Commands](#)
- [Managing Messages in the Local Buffer](#)
- [Logging System Messages to a Syslog Server](#)

Enabling System Message Logging

The logging function on the Switch must be enabled in order for the Syslog process to log system messages in the local buffer or report system messages to a Syslog server.

To enable system message logging and display the logging settings, enter the following commands in global configuration mode:

Command	Explanation
<code>logging on</code>	Enables the logging function.
<code>logging level all <0-7></code>	Specifies the severity level of the messages that should be captured.
<code>end</code>	Exits global configuration mode.
<code>show logging</code>	Displays the logging settings.

In the following example, the user enables message logging, specifying that severity level 4 messages should be logged, and displays the logging settings:

```
DGS-6600:2>enable
DGS-6600:15#configure terminal
DGS-6600:15(config)#logging on
DGS-6600:15(config)#logging level all 4
DGS-6600:15(config)#end
DGS-6600:15#show logging
logging on           :enabled
logging buffer severity:warning

Host                Severity          Facility    Port    Mode
-----
10.1.2.111          warning           local7      514
DGS-6600:15(config)#
```

Managing Messages in the Local Buffer

The user can manage the messages in the local buffer in the following ways:

- 1) Define the severity level for selectively logging system messages in the local buffer.
- 2) Define the entry number for messages in the local buffer.
- 3) Display the messages stored in the local buffer.
- 4) Clear the local buffer.
- 5) Store the local buffer's messages to the **system-log** file on file system.
- 6) Upload the **system-log** file to a TFTP server.

The following commands are used to manage the messages in the local buffer:

Command	Explanation
<code>logging level all <0-7></code>	Specifies the severity level of messages that should be logged to the local buffer.
<code>show logging</code>	Displays the local buffer settings.
<code>show logging buffer [START-INDEX [STOP-INDEX] + NUMBER_OF_MESSAGES - NUMBER_OF_MESSAGES]</code>	Displays the messages stored in the logging buffer.
<code>clear logging</code>	Clears the log messages in the logging buffer.
<code>logging file</code>	Saves the contents of the local buffer to Flash memory.
<code>copy system-log tftp://IP-ADDRESS/[DIRECTORY\ FILENAME</code>	Uploads the the system log file to a TFTP server.

In the following example, the user specifies that messages with an "Error" severity will be stored in the local buffer and verifies the configuration by displaying the logging buffer settings:

```
DGS-6600:2>enable
DGS-6600:15#configure terminal
DGS-6600:15(config)#logging level all 3
DGS-6600:15(config)#end
DGS-6600:15#show logging
logging on           :enabled
logging buffer severity:error

Host                Severity          Facility    Port    Mode
-----
10.73.87.22         warning          local7     514

DGS-6600:15(config)#
```

In the following example, the user displays the contents of the logging buffer, saves the entries to flash memory, clears the logging buffer, and confirms that the contents of the logging buffer have been cleared:

```
DGS-6600:15#show logging buffer

Total logs:3

Index Date                Log Text
-----
3      14:27:50, 2012-05-24  Interface eth4.47 is up
2      14:27:50, 2012-05-24  Interface vlan1 is up
1      14:22:34, 2012-05-24  System is cold started

DGS-6600:15#configure terminal
DGS-6600:15 (config)#logging file
DGS-6600:15 (config)#end
DGS-6600:15#clear logging
DGS-6600:15#show logging buffer

Total logs:0

DGS-6600:15#
```

In the following example, the user uploads the system log to a TFTP server with the IP address 10.73.87.88:

```
DGS-6600:15#copy system-log tftp://10.73.87.88/system-log.txt
System-log has been copied successfully.
DGS-6600:15#
```

In the following example, the user saves the entries in the log to flash memory and views the contents of the flash directory to verify that the log file has been saved properly:

```
DGS-6600:2>enable
DGS-6600:15#configure terminal
DGS-6600:15 (config)#logging file
DGS-6600:15 (config)#end
DGS-6600:15#dir flash:\log
system_log.txt                               286 bytes
DGS-6600:15#
```

Logging System Messages to a Syslog Server

The user can configure the Switch so that system messages are logged to a remote Syslog server. The user can also apply a severity level filter, which only logs messages of the specified severity level to the Syslog server. Up to four Syslog servers can be configured on the Switch.

To enable the Switch to log system messages to a remote Syslog server, enter the following commands in global configuration mode:

Command	Explanation
<code>logging host IP-ADDRESS [port UDP-PORT] [severity {emergency alert critical error warning notice informational debugging}] [facility {local0 local1 local2 local3 local4 local5 local6 local7}]</code>	Configures the Syslog server that will receive the system messages.
<code>end</code>	Exits global configuration mode.
<code>show logging host</code>	Displays the Syslog server settings.

In the following example, the user enables a Syslog server with the IP address 10.73.87.22 to receive system messages from the Switch. The user also specifies that only messages with a "Warning" level or above should be logged. Finally, the user enters the **show logging host** command to verify the configuration:

```
DGS-6600:2>enable
DGS-6600:15#configure terminal
DGS-6600:15(config)#logging host 10.73.87.22 severity warning
DGS-6600:15(config)#end
DGS-6600:15#show logging host
```

```
Host                Severity          Facility  Port  Mode
-----
10.73.87.22         warning          local7    514
DGS-6600:15#
```

List of Constants and Default Settings

Constant Name	Value
Maximum Number of Syslog Servers	4
Maximum Number of Logging Buffer Entries	10000

Table 59-2 Constants Values

Variable Name	Default Value
Logging On	On
Logging Buffer	On
Logging Severity	Level 5(Notice)
Syslog Server	None

Table 59-3 Default Variable Values

Chapter 60

Port Mirroring

Chapter Overview

The following topics are included in this chapter, please go to the topic for more detailed information:

- [Chapter Overview](#)
 - [An Introduction to Port Mirroring](#)
- [Port Mirroring Configuration Commands](#)
 - [Creating Mirroring Sessions](#)
 - [Displaying Mirroring Sessions](#)
- [Configuration Examples](#)
 - [Mirror Configuration Example](#)
- [Relations with Other Modules](#)
- [List of Constants and Default Settings](#)

An Introduction to Port Mirroring

Packet Mirroring is a useful tool that can help a user troubleshoot network problems. With the packet mirroring function, traffic activity, regardless of RX or TX traffic, from a device connected to one of the ports can be replicated to the designated port for further analysis by traffic analyzer equipment.

Port Mirroring Configuration Commands

Creating Mirroring Sessions

In a mirroring session, the user can specify the port that requires its traffic activity to be mirrored and the port that the traffic will be replicated too. The mirrored port is referred to as the source port and the replicated port is referred to as the destination port. The user can define multiple mirroring sessions.

Use the following commands to create a mirroring session:

Command	Explanation
<code>monitor session <i>SESSION-NUMBER</i> destination interface <i>INTERFACE-ID</i> [<i>INGRESS</i>]</code>	Specifies the destination interface of the mirroring session.
<code>monitor session <i>SESSION-NUMBER</i> source interface <i>INTERFACE-ID</i> [, -] [both rx tx]</code>	Specifies the source interface of the mirroring session.

In the following example, the user creates a packet mirroring session with a session number of 1, assigning Ethernet interface 4.2 as the destination port and Ethernet interface 4.3 as the source port:

```
DGS-6600:2>enable
DGS-6600:15#configure terminal
DGS-6600:15 (config) #monitor session 1 destination interface eth4.2
DGS-6600:15 (config) #monitor session 1 source interface eth4.3
DGS-6600:15 (config) #end
```

Displaying Mirroring Sessions

Use the following command to view all or a specific packet mirroring session on an interface:

Command	Explanation
<code>show monitor session [SESSION-NUMBER]</code>	Specifies the packet mirroring sessions to display.

In the following example, the user displays the port mirroring session numbered 1:

```
DGS-6600:2>show monitor session 1
Session 1
Session Type: local session
Destination Port      : eth4.2
Ingress               : Disable
Source Ports         :
                     Both : eth4.3
                     RX   : -
                     TX   : -

DGS-6600:2>
```

In the following example, the user displays all port mirroring sessions:

```
DGS-6600:2>show monitor session
Session 1
Session Type: local session
Destination Port   : eth4.2
Ingress           : Disable
Source Ports      :
                  Both  : eth4.3
                  RX    : -
                  TX    : -

Session 2
Session Type: local session
Destination Port   : eth4.9
Ingress           : Disable
Source Ports      :
                  Both  : eth4.10
                  RX    : -
                  TX    : -

DGS-6600:2>
```

Configuration Examples

Mirror Configuration Example

The mirror function is configured so that PC1 can capture the PC2 (connected to ports eth2.2) traffic.

Topology

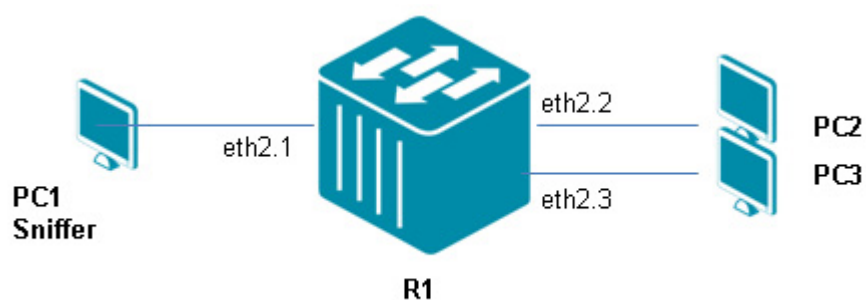

Figure 60-1 Mirror Configuration Topology

R1 (Router 1) Configuration Steps

Step 1: On R1 use the following command

```
DGS-6600:15(config)#monitor session 1 destination interface eth2.1
DGS-6600:15(config)#monitor session 1 source interface eth2.2 both
```

Verifying The Configuration

For verification Use the following command to check Mirror configuration on R1.

```
DGS-6600:15#show monitor session
Session 1
Session Type: local session
Destination Port : eth2.1
Ingress: Disable
Source Ports :
    Both : eth2.2
    RX : -
    TX : -
```

Please note PC1 running a "Sniffer program" can capture eth2.2 RX/TX packet of PC2.

Relations with Other Modules

- 1) A port channel virtual interface can be specified as either a source port or a destination port.
- 2) An 802.1x enabled port cannot be specified as a destination port.
- 3) A port security enabled port cannot be specified as a destination port.
- 4) A port cannot be specified as the source port in one session and as the destination port in another session.
- 5) Multiple source ports can be specified in the same session.

List of Constants and Default Settings

Constant Name	Value
Maximum Number of Mirroring Sessions	3

Table 60-1 Constants Values

Variable Name	Default Value
Default Mirroring Sessions	None

Table 60-2 Default Variable Values

Chapter 61

Remote Switching Port Analyzer (RSPAN)

Chapter Overview

The following topics are included in this chapter, please go to the topic for more detailed information:

- [Chapter Overview](#)
- [An Introduction to RSPAN](#)
 - [Operation Concepts](#)
- [RSPAN Configuration Commands](#)
 - [remote-span](#)
 - [monitor session](#)
 - [trunk allowed-vlan](#)
 - [show monitor session](#)
- [Configuration Examples](#)
 - [RSPAN Configuration Example](#)
- [RSPAN Configuration Commands](#)
 - [VLAN](#)
 - [Trunk](#)
 - [Parameters](#)
 - [Source Switch Parameters](#)
 - [Destination Switch Parameters](#)
- [RSPAN VLAN Parameters](#)

An Introduction to RSPAN

RSPAN (Remote Switched Port Analyzer) is a feature used to monitor and analyze the traffic passing through ports. The character 'R' is short for 'Remote' which means that the mirror source ports and the destination port are not within the same Switch. So a remote mirror session consists of at least two switches. To achieve the remote mirroring function, the mirrored traffic are tagged with a reserved VLAN which is called RSPAN VLAN, The RSPAN VLAN is reserved in such a way that traffic tagged with RSPAN tagged will be mirrored toward the associated destination port.

The following figure illustrates the remote mirroring via RSPAN VLAN.

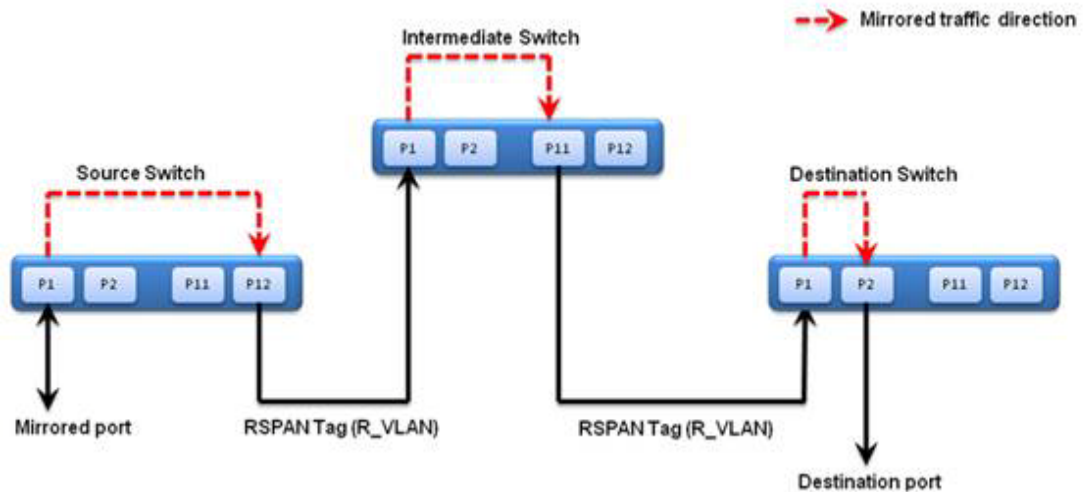

The source switch copies (or mirrors) packets received or sent (or both) on source ports (P1) to the destination port (P12). The traffic mirrored toward to the destination port will add an RSPAN tag.

The destination port (P12) used to transmit the monitor packets and the RSPAN VLAN used to tunnel the monitored packets to the remote site. The destination port does not need to be the member port of the RSPAN VLAN. The destination port can be either a physical port or a port channel.

The intermediate switch uses VLAN flooding technology to transmit the traffic flowing on RSPAN VLAN toward to destination port (P11).

For the intermediate switch involved in a RSPAN session, the port(P1) that the monitored packet arrives from and the port(P11) that the monitored packets will be sent out need to configured as tag member port of the RSPAN VLAN.

The destination switch uses VLAN flooding technology to transmit the traffic flowing on RSPAN VLAN toward to destination port(P2) specified by administrator, the RSPAN VAN tag will be removed according to 802.1Q VLAN egress rules.

Operation Concepts

There are three roles for switches in RSPAN.

1. Source Switch:

The switch which has the monitored ports on can be the source switch. All packets on the source ports are copied and sent to the destination switch. When the mirrored packets are sent out from source switch, an RSPAN VLAN tag is added to every packet. The incoming port on source switch for the mirrored packets is a source port. The outgoing port on source switch for the mirrored packets is source target port.

Mirrored traffic has 3 types:

- i. Receive (Rx) - The goal of receive (or ingress) RSPAN is to monitor as much as possible all the packets received by the source interface before any modification or processing is performed by the switch. A copy of each packet received by the source is sent to the destination port for that remote source session.
- ii. Transmit (Tx) - The goal of transmit (or egress) SPAN is to monitor as much as possible all the packets sent by the source interface after all modification and processing is performed by the switch.
- iii. Both - In a Monitor session, you can also monitor a port for both received and sent packets. This is the default.

More remote source session detail design, please reference to "MIRROR Command Reference 2.00.000(Chien-Ho) Sent to D-Link.doc"

2. Intermediate Switch:

The function of intermediate switch is to mirror traffic flowing in RSPAN VLAN toward the RSPAN destination. A switch can have the role of RSPAN VLAN intermediate switch as well as the role of source switch for another RSPAN VLAN.

3. Destination/Edge Switch:

Any switch which has a destination port on it can be a destination/edge switch. The edge switch may remove the RSPAN VLAN tags from the mirrored packets when they are sent to the final destination point. For more information on when a RSPAN VLAN tag will be removed please check 802.1Q VLAN standards, egress rules.

RSPAN Configuration Commands

The following commands are included in this section.

- [remote-span](#)
- [monitor session](#)
- [trunk allowed-vlan](#)
- [show monitor session](#)

remote-span

Command	Explanation
<code>remote-span</code>	Use the command to specify a VLAN as a RSPAN VLAN. Use the no form of the command to revert to a non RSPAN VLAN.

This example assigns VLAN 100 as the RSPAN VLAN in the middle switch of RSPAN session. Supposed that eth3.1 is where the monitored packets arrive and eth3.5 is where the monitored packet is transmitted.

```
DGS6600(config)# interface eth3.1
DGS6600(config-if)# trunk allowed-vlan 100
DGS6600(config-if)# exit
DGS6600(config)# interface eth3.5
DGS6600(config-if)# trunk allowed-vlan 100
DGS6600(config-if)# exit
DGS6600(config)# vlan 100
DGS6600(config-vlan)# remote-span
DGS6600(config-vlan)#exit
DGS6600(config)#
```

monitor session

Command	Explanation
<pre>monitor session <i>SESSION-NUMBER</i> destination interface <i>INTERFACE-ID</i> [ingress]</pre>	<p>Use monitor session to create a port mirroring session, allowing source ports as mirrored ports to be monitored through a destination port. Use the no form of this command to delete all or a specific port mirroring session, or remove either a destination port or a source port within a specific port mirroring session.</p>

This example shows how to create a port mirroring session with session number 1. It assigns a physical port (eth3.1) as a destination port and three source physical ports (eth3.2, eth3.3, and eth3.4) as mirrored ports.

```
DGS6600# configure terminal
DGS6600(config)# monitor session 1 destination interface eth3.1
DGS6600(config)# monitor session 1 source interface eth3.2-3.4
DGS6600(config)# end
```

trunk allowed-vlan

Command	Explanation
<pre>trunk allowed-vlan <i>VLAN-ID</i> [, -]</pre>	<p>Use the trunk allowed-VLAN configuration command to set the VLAN characteristic. It sets the allowable VLANs that can receive and send traffic on the interface in tagged format. Use the no trunk allowed-VLAN command to remove a tagged member port from a specified VLAN.</p>

This example shows how to set an interface eth1.1 to a tagged member of VLAN 1000.

```
DGS6600(config)# interface eth1.1
DGS6600(config-if)# trunk allowed-vlan 1000
```

show monitor session

Command	Explanation
<code>show monitor session [SESSION-NUMBER remote local]</code>	Use this command to show all or a specific port mirroring session.

This example shows how to display a created port mirroring session with session number 1.

```
DGS6600# show monitor session 1
Session 1
Session Type: local session
Destination Port : eth3.1
Ingress Disable
Source Ports :
  Both : eth3.2-3.4
  RX : eth3.5
  TX : eth3.7
DGS6600#
```

Configuration Examples

RSPAN Configuration Example

PC1 (Sniffer) connected in Destination switch can capture packets of monitored ports in Source Switch (eth2.2, eth2.3).

PC2 and PC3 are at VLAN2.

RSPAN VLAN is VLAN100. PC1 is at VLAN100.

Topology

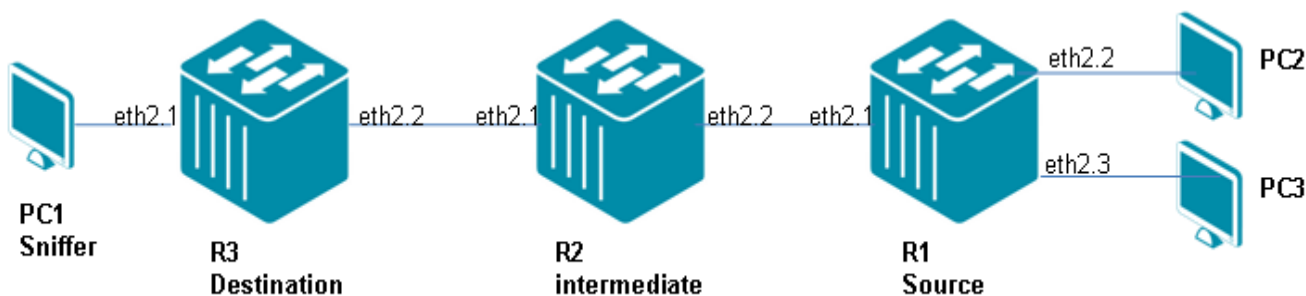

Figure 61-1 RSPAN Configuration Topology

R1 (Router 1 - source) Configuration Steps

Step 1: Create VLAN 2 and 100 (RSPAN VLAN)

```
DGS-6600:15(config)#vlan 2
DGS-6600:15(config-vlan)#interface range eth2.2-2.3
DGS-6600:15(config-if)#access vlan 2
DGS-6600:15(config-if)#vlan 100
DGS-6600:15(config-vlan)#remote-span
```

Step 2: Configure RSPAN

```
DGS-6600:15(config)#monitor session 1 destination remote vlan 100 interface eth2.1
DGS-6600:15(config)#monitor session 1 source interface eth2.2 both
DGS-6600:15(config)#monitor session 1 source interface eth2.3 both
```

R2 (Router 2 - Intermediate) Configuration Steps

Step 1: Create VLAN 100 (RSPAN VLAN).

```
DGS-6600:15(config)#vlan 100
DGS-6600:15(config-vlan)#remote-span
```

Step 2: Add ports into RSPAN VLAN

```
DGS-6600:15(config-vlan)#interface range eth2.1-2.2
DGS-6600:15(config-if)#trunk allowed-vlan 100
```

R3 (Router 3 - Destination) Configuration Steps

Step 1: Create VLAN 100(RSPAN VLAN).

```
DGS-6600:15(config)#vlan 100
DGS-6600:15(config-vlan)# remote-span
```

Step 2: Add ports into VLAN.

```
DGS-6600:15(config-vlan)#interface range eth2.1-2.2
DGS-6600:15(config-if)# trunk allowed-vlan 100
```

Step 3: Configure RSPAN mirroring ports.

```
DGS-6600:15(config)#monitor session 1 source remote vlan 100
DGS-6600:15(config)#monitor session 1 destination interface eth2.1
```

Verifying the configuration

Step 1: Use the following commands to check RSPAN configuration

R1-Source

```
DGS-6600:15#show monitor session 1
Session 1
Session Type: remote source session
Destination remote VLAN : VLAN 100
Destination Port      : eth2.1
Ingress: Disable
Source Ports         :
    Both : eth2.2-eth2.3
    RX   : -
    TX   : -
```

R2-intermediate

```
DGS-6600:15#show monitor session
Session 1
Session Type: remote destination session
Source remote VLAN : VLAN 100
Destination Port   : eth2.1
Ingress: Disable
```

R3-Destination

```
DGS-6600:15#show monitor session
Session 1
Session Type: remote destination session
Source remote VLAN : VLAN 100
Destination Port   : eth2.1
Ingress: Disable
```

Step 2: PC1 running sniffer program can “remotely” capture the packets between PC2 and PC3.

Relationship with other modules in the DGS-6600-Series Switch

VLAN

In the source switch, none of the ports need to be RSPAN VLAN tagged member port.

In the intermediate switch, target and source ports of the RSPAN VLAN packets must be the RSPAN VLAN tagged member port.

In the destination switch, the target port may be tagged port or not of the RSPAN VLAN. If it is tagged port, the packets send to Port Analyzer is tagged. Otherwise, it is untagged packets.

We will not support the function : when a VLAN is specified as a RSPAN VLAN, the access member port of the VLAN except the destination interface will become inactive.

The MAC address learning on the RSPAN VLAN is disabled.

Trunk

Link aggregation port must also be able to be set as RSPAN target port.

Parameters

The parameters that are listed below can be displayed and/or configured by the user. The "Attribute" field of the following table is given the definition below:

Config - indicate the value of the parameter is configurable

Show - indicate the value of the parameter and can be displayed

Config/show - indicate the parameter is both configurable and can be displayed

Source Switch Parameters

Table 61-1

Parameter Name	Attribute	Default Value	Value Range	Description
<i>SESSION-NUMBER</i>	Config/Show	None	1-3	Specify the session number for the port monitor session. The valid range is 1 to 3.
remote vlan <i>VLAN-ID</i>	Config/Show	None	2-4094	Specify the RSPAN VLAN used to tunnel the monitored packets to the remote site. The valid range is 2 to 4094.
interface <i>INTERFACE-ID</i>	n/a	n/a	n/a	Specify the interface to transmit the monitored packets to the remote site.

Destination Switch Parameters

Table 61-2

Parameter Name	Attribute	Default Value	Value Range	Description
<i>SESSION-NUMBER</i>	Config/Show	none	1-3	Specify the session number for the port monitor session. The valid range is 1 to 3.
remote vlan <i>VLAN-ID</i>	Config/Show	none	2-4094	Specify the VLAN that the monitored source packets are tunneled over from the remote site. The valid range is 2 to 4094.

RSPAN VLAN Parameters

Table 61-3

Parameter Name	Attribute	Default Value	Value Range	Description
VLAN-ID	Config/Show	none	1-4094	Specify the RSPAN VLAN by VLAN ID.

Chapter 62

Testing Network Connectivity

Chapter Overview

The following topics are included in this chapter, please go to the topic for more detailed information:

- [Testing Connectivity to a Specific Destination](#)
- [Tracing the Route to a Specific Destination](#)

Testing Connectivity to a Specific Destination

The failure of a network can be caused by many scenarios. One of the most common causes is the failure of a node. Whenever a network problem is encountered, the problem can usually be isolated by using the **ping** command to test the availability of intermediate nodes located on the packet's routing path.

The user can use the **ping** command to analyze the reliability of the routing path, the round trip delay time for test packets with different TOS fields, and whether packets of different lengths can be serviced.

The following command is used to test the connectivity to a specific destination:

Command	Explanation
<code>ping [OPTIONS] {IP-ADDRESS IPV6-ADDRESS}</code>	Invokes the echo protocol to ping a host.

In the following example, the user invokes the echo protocol to ping a host with the IP address 10.1.1.254:

```
DGS-6600:2>enable
DGS-6600:15#ping 10.1.1.254
PING 10.1.1.254 (10.1.1.254) 56(84) bytes of data.
64 bytes from 10.1.1.254: icmp_seq=1 ttl=64 time=4.08 ms
64 bytes from 10.1.1.254: icmp_seq=2 ttl=64 time=1.37 ms
64 bytes from 10.1.1.254: icmp_seq=3 ttl=64 time=3.38 ms
64 bytes from 10.1.1.254: icmp_seq=4 ttl=64 time=21.3 ms
64 bytes from 10.1.1.254: icmp_seq=5 ttl=64 time=1.34 ms

--- 10.1.1.254 ping statistics ---
packets transmitted = 5, received = 5, packet loss = 0 (0%)
round trip times min/avg/max/mdev = 1.344/6.311/21.366/7.605 ms
DGS-6600:15#
```

In the following example, the user invokes the echo protocol to ping a host with the IPv6 address 2052:1::47:65:52:101:

```
DGS-6600:2>enable
DGS-6600:15#ping 2052:1::47:65:52:101
PING 2052:1::47:65:52:101 (2052:1::47:65:52:101) 56(104) data bytes
64 bytes from 2052:1::47:65:52:101: icmp_seq=1 ttl=64 time=15.2 ms
64 bytes from 2052:1::47:65:52:101: icmp_seq=2 ttl=64 time=1.85 ms
64 bytes from 2052:1::47:65:52:101: icmp_seq=3 ttl=64 time=4.89 ms
64 bytes from 2052:1::47:65:52:101: icmp_seq=4 ttl=64 time=1.84 ms
64 bytes from 2052:1::47:65:52:101: icmp_seq=5 ttl=64 time=1.92 ms

--- 2052:1::47:65:52:101 ping statistics ---
packets transmitted = 5, received = 5, packet loss = 0 (0%)
round trip times min/avg/max/mdev = 1.840/5.143/15.200/5.163 ms
DGS-6600:15#
```

In the following example, the user invokes the echo protocol to ping a host with the IPv6 address fe80::215:e9ff:feb2:78e1. Since the IPv6 address is a link local address, the user is prompted to specify the output VLAN interface and specifies VLAN99:

```
DGS-6600:2>enable
DGS-6600:15#ping fe80::215:e9ff:feb2:78e1
Local-link address, Enter Output Interface: vlan99
PING fe80:215:e9ff:feb2:78e1 (fe80::215:e9ff:feb2:78e1) from fe80::460:cff:fe10:98
vlan99: 56(104) data bytes
64 bytes from fe80::215:e9ff:feb2:78e1: icmp_seq=1 ttl=128 time=1.32 ms
64 bytes from fe80::215:e9ff:feb2:78e1: icmp_seq=1 ttl=128 time=0.916 ms
64 bytes from fe80::215:e9ff:feb2:78e1: icmp_seq=1 ttl=128 time=0.926 ms
64 bytes from fe80::215:e9ff:feb2:78e1: icmp_seq=1 ttl=128 time=0.951 ms
64 bytes from fe80::215:e9ff:feb2:78e1: icmp_seq=1 ttl=128 time=1.41 ms

--- fe80::215:e9ff:feb2:78e1 ping statistics ---
packets transmitted = 5, received = 5, packet loss = 0 (0%)
round trip times min/avg/max/mdev = 0.916/1.106/1.415/0.220 ms
DGS-6600:15#
```

Tracing the Route to a Specific Destination

When the user has a problem accessing a specific destination, the user may need to check all the hops located on the routing path of the packet. The **tracert** command is commonly used to find all the hops located on a routing path.

The **tracert** command uses the TTL field in the IP header to cause routers and servers to generate specific return messages. The **tracert** utility initially sends a UDP datagram to the destination host with the TTL field set to 1. If a router finds a TTL value of 1 or 0, the datagram will be dropped and an ICMP "time-exceeded" message will be sent back to the sender. The **tracert** utility determines the address of the first hop by examining the source address field of the ICMP time-exceeded message.

To identify the next hop, the **tracert** utility sends another UDP packet, but this time with a TTL value of 2. The first router decrements the TTL field by 1 and sends the datagram to the next router. The second router sees a TTL value of 1, discards the datagram, and returns the time-exceeded message to the source. This process continues until the TTL is incremented to a value large enough for the datagram to reach the destination host (or until the maximum TTL is reached).

To determine when a datagram has reached its destination, the **traceroute** utility sets the UDP destination port in the datagram to a very large value that the destination host is unlikely to be using. When a host receives a datagram with an unrecognized port number, an ICMP “port unreachable” error message will be sent to the source. This message is the method that the **traceroute** utility uses to identify that the datagram has reached the intended destination.

The following command is used to trace the route to a specific destination:

Command	Explanation
traceroute [<i>OPTIONS</i>] { <i>IP-ADDRESS</i> <i>IPV6-ADDRESS</i> }	Traces the route to a specific destination.

In the following example, the user uses the **traceroute** command to trace the route to a host with the IP address 172.19.3.40:

```
DGS-6600:2>enable
DGS-6600:15#traceroute 172.19.3.40
traceroute to 172.19.3.40 (172.19.3.40), 30 hops max, 40 byte packets
 1  10.1.1.254 (10.1.1.254)  1.624 ms  1.380 ms  1.259 ms
 2  192.168.249.129 (192.168.249.129)  1.341 ms  1.218 ms  1.184 ms
 3  172.19.3.40 (172.19.3.40)  1.309 ms  1.163 ms  1.113 ms
DGS-6600:15#
```

In the following example, the user uses the **traceroute** command to trace the route to a host with the IPv6 address 2052:1::47:65:52:101:

```
DGS-6600:2>enable
DGS-6600:15#traceroute 2052:1::47:65:52:101
traceroute to 2052:1::47:65:52:101 (2052:1::47:65:52:101), 30 hops max, 40 byte
packets
 1  2052:1::47:65:52:101 (2052:1::47:65:52:101)  40.749 ms  1.716 ms  1.530 ms
DGS-6600:15#
```

Chapter 63

Debug Information to Compact Flash

Chapter Overview

This chapter describes how to update debug information to cf2 for the collection of detailed debug information in relation to the DGS-6600:

The following topics are included in this chapter, please go to the topic for more detailed information:

- [Updating Debug information to cf2, Overview](#)
 - [Terminology](#)
 - [Configuration Steps](#)

Updating Debug information to cf2, Overview

The **update debug cf2** command can collect very detailed debug information from the DGS-6600. It's very helpful to know DGS6600 device information on-site, especially if there is a problem that's non-replicable in the LAB.

Terminology

- 1) Compact Flash slot 1 (i.e., cf1).
- 2) Compact Flash slot 2 (i.e., cf2).
- 3) Management port (i.e., mgmt-if for out-of-band management).
- 4) RS-232 console port.
- 5) USB console port (mutually exclusive with RS-232. USB has a higher priority).

Configuration Steps

NOTE: This debug info collection needs to be done from Console, and is not supported from either telnet or web.

The debug dump will be stored to cf2 (proprietary format) automatically, and then it can be retrieved either using: Case 1: Copy to cf1, and then copy to PC by CF card reader, or Case 2: TFTP to PC

Case 1: Copy to cf1, and then copy to PC by CF card reader. This scenario is used when no TFTP server settings are needed. However, it needs (a) two CF cards and (b) a CF card reader in PC.

1.1: Insert a CF card (with "regular file format") to Compact Flash slot 1 (cf1). The Compact Flash slot 2 (cf2) should have a CF card there shipped with device. If not, insert another CF card (Note: will be formatted to proprietary format) to Compact Flash slot 2, and always kept there.

1.2: Type "update debug cf2" (in any mode) and wait until "End of retrieve data and save to storage". After finish, press enter. For example,

```
DGS-6600:15# update debug cf2
Start to retrieve data and save to storage. Please wait...
(42) (41) (40) (39) (38) ...
...
153,154,156,157,158,159,}
End of "retrieve data and save to storage"
DGS-6600:15#
```

1.3: In privilege EXEC mode, type "copy debug cf2 cf1:\filename.txt" (filename can be re-named as required). Wait few minutes until "done" is shown. For example,

```
DGS-6600:15# copy debug cf2 cf1:\dgs66debug.txt
Copy debug information from cf2 to cf1:\dgs66debug.txt
.....done
```

1.4: Un-plug CF1, insert it to card reader of PC, copy the file in CF card to your PC, zip it, and send back the file to us.

Case 2: TFTP to PC.

In this case, no card reader is needed, only one CF card at cf2 can be used, but a TFTP server environment is needed.

2.1: Insert CF card to "Compact Flash" slot 2.

2.2: Type "update debug cf2" (in any mode) and wait until "End of retrieve data and save to storage". After finish, press enter. For example,

```
DGS-6600:15# update debug cf2
Start to retrieve data and save to storage. Please wait...
(42) (41) (40) (39) (38) ...
...153,154, 156, 157, 158, 159,}
End of "retrieve data and save to storage"
DGS-6600:15#
```

2.3: Setup TFTP server environment at your PC. In this example, the mgmt-if is used. But the TFTP also can be done in regular IP interface. If from a mgmt-if configuration mode (see below), type "copy debug cf2 tftp:\<[TFTPIP]\filename.txt" (filename can be named by yourself). Wait few minutes until "done" is shown. For example,

```
DGS-6600:15(mgmt-if)# copy debug cf2 tftp:\<10.19.72.86\dgs66debug2.txt
Copy debug information from cf2 to 10.19.72.86\dgs66debug2.txt .....done
```

If from a "regular IPIF", in privilege EXEC mode, type the following command:

```
DGS-6600:15# copy debug cf2 tftp:\\10.19.72.86\dgs66debug_0505.txt
Copy debug information from cf2 to 10.19.72.86\dgs66debug_0505.txt
.....done
DGS-6600:15#
```

2.4: Find the file (in this case, dgs66debug2.txt, or dgs66debug_0505.txt) in your PC's TFTP directory, zip it, and transfer the file to us.

Free Manuals Download Website

<http://myh66.com>

<http://usermanuals.us>

<http://www.somanuals.com>

<http://www.4manuals.cc>

<http://www.manual-lib.com>

<http://www.404manual.com>

<http://www.luxmanual.com>

<http://aubethermostatmanual.com>

Golf course search by state

<http://golfingnear.com>

Email search by domain

<http://emailbydomain.com>

Auto manuals search

<http://auto.somanuals.com>

TV manuals search

<http://tv.somanuals.com>