

**D-Link®**

**DSM-510**



# HIGH-DEFINITION MEDIA PLAYER

**User Manual**

# Table of Contents

<b>Safety Information</b> .....	<b>4</b>	Adding a Device without an Intel® Viiv™ Technology Verified Router .....	23
<b>Product Overview</b> .....	<b>8</b>	Adding a Device.....	24
Package Contents .....	8	Setting Up the Intel® Viiv™ Media Library.....	25
Minimum System Requirements .....	8	Navigating to the Intel® Viiv™ Technology Settings Screen and Images on Your PC .....	25
Recommended .....	8		
Introduction.....	9		
Features.....	10		
<b>Wireless Installation Considerations</b> .....	<b>11</b>	<b>Windows® Media Player 11 Setup</b> .....	<b>26</b>
<b>Setup Your DSM-510 Using an Intel® Viiv™ Technology-Based PC</b> .....	<b>12</b>	Enable Media Sharing - Windows® Vista .....	32
Setup .....	13	<b>Settings</b> .....	<b>35</b>
Wireless Connection.....	14	Options.....	35
Wired Connection .....	14	On-Screen Keyboard.....	36
Connecting the DSM-510 .....	15	Network Settings .....	37
Video Connections .....	15	Wired LAN Settings.....	37
Audio Connections.....	16	Wireless LAN Settings .....	38
Network Connections .....	17	TV Settings.....	40
Using the Remote Control .....	18	Audio Output Settings .....	40
Power on the DSM-510 .....	19	Language Settings.....	41
Finalizing Your Wireless Connection with an Intel® Viiv™ Technology Verified Router.....	20	Settings for Ease of Use .....	41
Finalizing Your Wireless Connection without an Intel® Viiv™ Technology Verified Router.....	21	Reset Settings .....	42
Finalizing Your Wired Connection .....	22	Software Update .....	43
		Device Information .....	43
		<b>Windows® Connect Now for XP</b> .....	<b>44</b>
		Windows® Connect Now for Vista .....	50

<b>Operating the DSM-510</b> .....	<b>56</b>	<b>Contacting Technical Support</b> .....	<b>101</b>
Music .....	57	<b>Warranty</b> .....	<b>102</b>
Time Search .....	63	<b>Registration</b> .....	<b>107</b>
Podcasts.....	64		
Importing Podcasts.....	65		
Adding Podcasts .....	66		
Photo.....	69		
Video .....	72		
DivX® .....	73		
Time Search .....	75		
Search Filter .....	76		
Intel® Viiiv™ Zone .....	77		
Server.....	78		
USB.....	79		
<b>Troubleshooting</b> .....	<b>80</b>		
<b>Wireless Basics</b> .....	<b>86</b>		
<b>Networking Basics</b> .....	<b>91</b>		
Check your IP Address .....	91		
Statically Assign an IP Address .....	92		
<b>General Appendix</b> .....	<b>93</b>		
How to Check your Media.....	93		
Convert an Earlier WMV File into WMV9 .....	94		
Remote Control Table .....	100		

---

# Safety Information

For optimum performance, please read the following information carefully.

## Safety Precautions



The lightning flash with arrowhead symbol, within an equilateral triangle, is intended to alert users to the presence of uninsulated “dangerous voltage” within the product’s enclosure that may be of sufficient magnitude to constitute a risk of electric shock to persons.



The exclamation point within an equilateral triangle is intended to alert the user to the presence of important operating and maintenance (servicing) instructions in the literature accompanying the appliance.

**CAUTION!**  
THE POWER SUPPLY CORD IS USED AS THE MAIN DISCONNECT DEVICE. ENSURE THAT THE SOCKET-OUTLET IS LOCATED/INSTALLED NEAR THE EQUIPMENT AND IS EASILY ACCESSIBLE.

**CAUTION!**  
TO REDUCE THE RISK OF FIRE, ELECTRIC SHOCK, OR PRODUCT DAMAGE, DO NOT EXPOSE THE UNIT TO RAIN, MOISTURE, DRIPPING, OR SPLASHING. DO NOT PLACE OBJECTS FILLED WITH LIQUIDS UPON THE UNIT.

---

**CAUTION!**

- **DO NOT INSTALL OR PLACE THIS UNIT IN A BOOKCASE, BUILT-IN CABINET OR IN ANOTHER CONFINED SPACE. ENSURE THE UNIT IS WELL VENTILATED. TO PREVENT RISK OF ELECTRIC SHOCK OR FIRE HAZARD DUE TO OVERHEATING, ENSURE THAT CURTAINS AND ANY OTHER MATERIALS DO NOT OBSTRUCT THE VENTILATION VENTS.**
- **DO NOT OBSTRUCT THE UNIT'S VENTILATION OPENINGS WITH NEWSPAPERS, TABLECLOTHS, CURTAINS, AND SIMILAR ITEMS.**
- **DO NOT PLACE SOURCES OF NAKED FLAMES, SUCH AS LIGHTED CANDLES, ON THE UNIT.**
- **DISPOSE OF BATTERIES IN AN ENVIRONMENTALLY-FRIENDLY MANNER.**

**CAUTION!**

**TO PREVENT ELECTRIC SHOCK, MATCH THE WIDE BLADE OF THE PLUG TO THE WIDE SLOT OF THE ELECTRICAL OUTLET AND FULLY INSERT.**

This device is designed and manufactured to assure personal safety. Improper use can result in electric shock or fire hazard. The safeguards incorporated in this unit will protect you if you observe the following procedures for installation, use, and servicing. This device does not contain any user serviceable parts.

- **Carefully read and follow the Manual and Install Guide.**
- **Do not place the product near heat sources such as radiators, heat registers, stoves, or other products that produce heat.**
- **Do not use this product near water.**
- **Unplug the unit from the wall outlet before cleaning. Do not use liquid cleaners or aerosol cleaners. Use a damp cloth for cleaning.**
- **Power-supply cords should be routed so that they are not likely to be walked on or pinched by items placed upon or against them.**
- **Do not overload wall outlets.**
- **Do not use this product during a storm. Unplug the unit from the wall outlet. If the product is to be left unattended for a long period of time. This will prevent damage to the product due to lightning and power-line surges.**
- **Do not attempt to service this product yourself. Opening the cover may expose you to dangerous voltage or other hazards. For service, please contact a qualified service technician.**

---

## **Radio and TV Interference:**

This equipment has been tested and found to comply with the limits for a Class B digital device, pursuant to Part 15 of the FCC Rules. These limits are designed to provide reasonable protection against harmful interference in a residential installation. This equipment generates, uses and can radiate radio frequency energy and, if not installed and used in accordance with the instructions, may cause harmful interference to radio communications. However, there is no guarantee that interference will not occur in a particular installation. If this equipment does cause harmful interference to radio or television reception, which can be determined by turning the equipment off and on, the user is encouraged to try to correct the interference by one or more of the following measures:

- **Reorient or relocate the receiving antenna.**
- **Increase the separation between the equipment and receiver.**
- **Connect the equipment into an outlet on a circuit different from that to which the receiver is connected.**
- **Consult the dealer or an experienced radio/TV technician for help.**

Any unauthorized changes or modifications to this equipment would void the user's authority to operate this device. This device complies with Part 15 of the FCC Rules. Operation is subject to the following two conditions: (1) This device may not cause harmful interference, and (2) this device must accept any interference received, including interference that may cause undesired operation.

### ***Important Note:***

#### ***Radiation Exposure Statement:***

*This equipment complies with FCC radiation exposure limits set forth for an uncontrolled environment. This equipment should be installed and operated with a minimum distance of 20cm between the radiator and your body.*

*This transmitter must not be co-located or operating in conjunction with any other antenna or transmitter.*

*The availability of some specific channels and/or operational frequency bands are country dependent and are firmware programmed at the factory to match the intended destination. The firmware setting is not accessible by the end user.*

### ***Industry Canada statement:***

This device complies with RSS-210 of the Industry Canada Rules. Operation is subject to the following two conditions: (1) This device may not cause harmful interference, and (2) this device must accept any interference received, including interference that may cause undesired operation.

### ***Important Note:***

#### ***Radiation Exposure Statement:***

*This equipment complies with IC radiation exposure limits set forth for an uncontrolled environment. This equipment should be installed and operated with a minimum distance of 20cm between the radiator and your body.*

*This device has been designed to operate with an antenna having a maximum gain of 2dB. An antenna having a higher gain is strictly prohibited per regulations of Industry Canada. The required antenna impedance is 50 ohms.*

Disclaimers: Certain content and services accessible via the DSM-510 may include materials owned by third parties. The users shall be entirely responsible for ensuring that they have the necessary rights to access and use such third party content. D-Link assumes no liability for and shall not be responsible for a user's access of such content, including but not limited to unlawfully 'ripped' or downloaded content. Further, D-Link does not guarantee the availability of any third party content or services, including that which may

---

be referenced herein, and shall not be responsible for any changes to or the lack of availability of such third party content or services.

This product incorporates copyright protection technology that is protected by U.S. patents and other intellectual property rights. Use of this copyright protection technology must be authorized by Macrovision, and is intended for home and other limited viewing uses only unless otherwise authorized by Macrovision. Reverse engineering or disassembly is prohibited.

Consumers should note that not all high definition television sets are fully compatible with this product and may cause artifacts to be displayed in the picture. In case of 525 progressive scan picture problems, it is recommended that the user switch the connection to the "Standard Definition" output. If there are questions regarding our TV set compatibility with this model please contact our customer service center.

Subscription may be required for services from Yahoo, TotalVid, Live365™, My Kid's Tunes, or Napster™.

Certain features of this device may be unavailable when accessing stored media content on UPnP AV network attached storage devices.

USB flash drive and USB hard drive sold separately. D-Link is not responsible for damage to USB drives, or loss and/or damage to files on the USB drives, due to improper installation or usage.

This device supports the codec file formats listed herein, however D-Link cannot guarantee full compatibility or proper playback with all such codec files due to modifications and/or other variations that may occur with the end-user's encoded codec files. Certain file formats and/or features are not accessible from USB drives attached to the USB port.

Windows® Media Connect and Windows® Connect Now require Windows® XP SP2, and can be downloaded using Windows update on your computer.

24/7 Technical Support available only in the U.S.A.

1-Year Warranty available only in the U.S.A. and Canada.

Latest Software and Documentation are available at <http://support.dlink.com>.

MPEG-4 contains Advanced Simple Profile only without quarter pixel or global motion compensation.

Maximum wireless signal rate based on IEEE Standard 802.11g specifications. Actual data throughput will vary. Network conditions and environmental factors, including volume of network traffic, building materials and construction, and network overhead lower actual data throughput rate.

Copyright ©2006-2007 D-Link Corporation/D-Link Systems, Inc. All rights reserved. D-Link and the D-Link logo are registered trademarks of D-Link Corporation or its subsidiaries in the United States and other countries. Intel, the Intel logo and Intel Viiv are trademarks or registered trademarks of Intel Corporation or its subsidiaries in the United States and other countries. Other trademarks are the property of their respective owners. The PlaysForSure logo, Windows Media, Windows and the Windows logo are trademarks or registered trademarks of Microsoft Corporation in the United States and/or other countries. HDMI, the HDMI logo and High-Definition Multimedia Interface are trademarks or registered trademarks of HDMI Licensing LLC. Other trademarks are the property of their respective owners. All references to speed are for comparison purposes only. Product specifications, size and shape are subject to change without notice, and actual product appearance may differ from that depicted on the packaging. See inside packaging for warranty details. For an updated list of available online service providers, please visit <http://support.dlink.com>. This product is covered by certain intellectual property rights of Microsoft® Corporation. Use or distribution of such technology outside of this product is prohibited without a license from Microsoft or an authorized Microsoft subsidiary.

## Package Contents

- D-Link DSM-510 High-Definition Media Player
- Quick Install Guide
- Manual, QIG, software, and warranty on CD
- 2dBi Wireless Antenna
- Ethernet (CAT5-UTP/Straight-Through) Cable
- Composite RCA Audio/Video Cable
- Remote Control with 2AAA Batteries
- Power Adapter
- Vertical Stand

**Note:** Please remove the plastic covers attached to the unit so that proper ventilation is allowed. If any of the above items are missing, please contact your reseller.

## Minimum System Requirements

- PC with:
  - Windows® Vista™/XP
  - 1GHz plus processor
  - Memory Size: 512MB or above
  - 100MB of available hard drive space and a wireless or Ethernet network.
- TV with Composite Video, or HDMI Input.
- Stereo or A/V Receiver with Composite Audio, or Optical Digital.
- If you want to connect the DSM-510 to a Windows XP-based PC without Intel® Viiv™ technology, use the included CD for steps on how to configure Windows® Media Player 11 software and refer to this manual.

## Recommended

- Windows® Vista/XP MCE-based PC with Intel® Viiv™ technology.
- An Intel® Viiv™ technology verified router.
- Broadband Connection for Accessing Online Content.
- Wired or Wireless Network (Wired network is recommended for video streaming).



# Introduction

D-Link introduces the latest addition to its multimedia family of products: the D-Link DSM-510 High-Definition Media Player. The DSM-510 is a device that plays back video, audio, and photos that are stored on a Media Server.

The DSM-510 integrates home computer systems and home entertainment centers. Digital media content can be accessed directly from a computer, so that movies, music, and photos can be enjoyed from the comfort of your living room. The DSM-510 connects easily to a wired or wireless network, and features 802.11g wireless technology for transfer speeds on a wireless network. These options provide you with the maximum throughput for sharing and transferring digital media.

Simple to setup with a sleek design that makes it a natural addition to any home entertainment center. The AV jacks on the back panel of the DSM-510 allow for direct connection to your television. Use the included remote control to access media content stored on your PC. Browse music files, watch videos, and display photos, all on your television! In addition, the DSM-510 lets you access online media content through Intel® Viiv™ Zone with an existing broadband Internet connection.

The DSM-510 adheres to the universal Plug-&-Play AV specification, allowing it to communicate with other UPnP AV media devices.

The DSM-510 supports the majority of audio, video, and image file formats and streams them directly from your PC. You can stream MP3, WMA, WAV, OGG Vorbis, and AIFF files from your computer and enjoy them on your home stereo system. Watch stored videos in DVR-MS, MPEG1/2/4, AVI, DivX®, or Xvid format on your television. Enjoy slideshows of your favorite photos in JPEG, TIFF, GIF, BMP or PNG formats. Better yet, it's easy to access the files through the television interface using the remote control included with the DSM-510.

Experience digital media like never before with the DSM-510 High-Definition Media Player. The DSM-510 includes everything you need to instantly access and play music, videos, and photos using your home entertainment center.

This is an official DivX® Certified product that plays all versions of DivX® video (including DivX® 6) with standard playback of DivX® media files.

# Features

- Stream media content from a PC or D-Link Network Attached Storage to your entertainment center.
- Listen to digital music on your stereo system.
- View digital photos, slideshows with music, and high-definition videos on TV.
- Easily connect to your wireless network using 802.11g at up to 54Mbps.
- Connect using an Ethernet network cable at up to 100Mbps.
- UPnP AV compliant for maximum compatibility.
- Support for most popular digital media formats, including Microsoft Windows® recorded TV files (DVR-MS).
- Remote controlled TV interface for quick access to your media content.
- Experience a world of online media content through Intel® Viiv™ Zone.
- Sleek design complements your existing audio/video equipment.
- Optical digital audio output.
- HDMI output.
- 64-bit or 128-bit WEP & WPA security.
- Supports DHCP for easy connection to your home network.
- Color coded one-touch shortcut buttons on the remote, for quick access to music, photos, and videos.
- Podcasts can be used to access Internet radio streams.

# Wireless Installation Considerations

The D-Link High-Definition Media Player lets you access your network using a wireless connection from virtually anywhere within the operating range of your wireless network. Keep in mind, however, that the number, thickness and location of walls, ceilings, or other objects that the wireless signals must pass through, may limit the range. Typical ranges vary depending on the types of materials and background RF (radio frequency) noise in your home or business. The key to maximizing wireless range is to follow these basic guidelines:

1. Keep the number of walls and ceilings between the D-Link adapter and other network devices to a minimum - each wall or ceiling can reduce your adapter's range from 3-90 feet (1-30 meters.) Position your devices so that the number of walls or ceilings is minimized.
2. Be aware of the direct line between network devices. A wall that is 1.5 feet thick (.5 meters), at a 45-degree angle appears to be almost 3 feet (1 meter) thick. At a 2-degree angle it looks over 42 feet (14 meters) thick! Position devices so that the signal will travel straight through a wall or ceiling (instead of at an angle) for better reception.
3. Building Materials make a difference. A solid metal door or aluminum studs may have a negative effect on range. Try to position access points, wireless routers, and computers so that the signal passes through drywall or open doorways. Materials and objects such as glass, steel, metal, walls with insulation, water (fish tanks), mirrors, file cabinets, brick, and concrete will degrade your wireless signal.
4. Keep your product away (at least 3-6 feet or 1-2 meters) from electrical devices or appliances that generate RF noise.
5. If you are using 2.4GHz cordless phones or X-10 (wireless products such as ceiling fans, lights, and home security systems), your wireless connection may degrade dramatically or drop completely. Make sure your 2.4GHz phone base is as far away from your wireless devices as possible. The base transmits a signal even if the phone is not in use.

**Note:** For best video quality, a wired connection is recommended.

# Setup Your DSM-510 Using an Intel® Viiv™ Technology-Based PC

To get the most out of this guide, you must have an Intel® Viiv™ technology-based PC featuring the Intel® Viiv™ logo below. If you do not have an Intel® Viiv™ technology-based PC at this time, please continue to page 13.

If you already have wireless settings configured on your PC, instead of using the Intel® Viiv™ setup, you can use Windows® Connect Now (WCN) to configure the wireless settings on your DSM-510. Please see the user manual on the CD for further information.

Your High-Definition Media Player has been designed to work with Intel® Viiv™ technology-based PCs, which helps you add this device to your network and enjoy content from your PC. To enjoy these features, you may need to update the Intel® Viiv™ software on your PC.

Intel® Viiv™ technology-based PCs have this logo on them.



Insert the CD that came with your DSM-510 into your Intel® Viiv™ technology-based PC, and follow the on-screen instructions to guide you through the update process.

## IMPORTANT:

- This software will enable the instant on/off power management features of your computer, which allows your new device to “wake-up” your PC to access content and services marked “Enjoy with Intel® Viiv™ technology”.
- You may need to restart your PC to begin using the Intel® Viiv™ software.

Turn on the computer and insert the D-Link DSM-510 CD into the CD-ROM drive.

Click **Setup**

If the Autorun function does not automatically start on your computer, click Windows® **Start > Run**. In the Run command box type “**D:\DSM510.exe**”, where D: represents the drive letter of your CD-ROM.



## Setup

Clicking “Setup” on a PC that does not contain Intel® Viiv™ technology, will launch the Windows® Media Player and Setup Guide with instructions on how to setup your Windows® Media Player 11 for sharing. This is a UPnP AV compliant media server software that allows you to share your music, photos or video files to the DSM-510. Please continue to the section “Windows® Media Player 11 Installation” on page 26 for more information.

After configuring Windows® Media Player 11, refer to page 15 to connect your DSM-510.

If your PC is Intel® Viiv™ technology based, clicking on “Install Media Server” will confirm your PC has the latest version of the Intel® Viiv™ software and update it if necessary. This software includes the Intel® Viiv™ Media Server.

At the Intel® Viiv™ software setup screen, select the option **Yes, start Intel Viiv Settings now (recommended)**.

Click **Next** to start the installation process, and at the next screen click **add a device**.

**Note:** Click “Install DivX®” to install the DivX® player, DivX® codec, and the DivX® Converter software on the PC. The DivX® Converter software converts other file types to DivX® files.

# Wireless Connection

Select the option **wirelessly**.

If you select **connecting it to the router with an Ethernet network cable**, please skip to the “Wired Connection” section below.

If the Intel® Viiv™ software does not find an Intel® Viiv™ technology verified router, then connect your DSM-510 (see page 15). Power on your DSM-510 (see page 19) and follow the instructions that apply to finalizing your wireless connection without an Intel® Viiv™ technology verified router.

Intel® Viiv™ technology verified routers have this logo on them.



If an Intel® Viiv™ technology verified router is detected, you should see the **adding a device to your home network** screen. Proceed to page 15 to connect your DSM-510 and power it up for the first time.

# Wired Connection

For a wired connection, select the option **connecting it to the router with an Ethernet network cable**.

At the **adding a device to your home network** screen, leave your PC and connect your DSM-510 (see page 15).

**Connect your DSM-510, please continue to page 15.**

# Connecting the DSM-510

All audio, video, and networking connections are located on the rear panel of the DSM-510.

## Video Connections

Select one of two ways to connect video to your DSM-510:

### Composite Audio/Video Connector

- Plug the supplied 3.5mm mini-jack connector into the DSM-510. Plug the opposite end (the yellow video cable and the red and white audio cables) into your television input.



### HDMI

- Plug the HDMI cable into the HDMI connector on the back panel of the DSM-510. Plug the opposite end to the matching HDMI connector on your television or audio/video system.



**Note:** *This cable is not supplied.*

By default the DSM-510 will automatically detect and switch between Digital (HDMI) and Analog (Composite) modes.

High-Definition Multimedia Interface (HDMI) supports standard, enhanced, or high-definition video, plus multi-channel digital audio on a single cable.

## Audio Connections

Select one of two ways to connect audio to your DSM-510:

### Composite Audio/Video Connector

- Plug the supplied 3.5mm mini-jack connector into the DSM-510. Plug the opposite end (the yellow video cable and the red and white audio cables) into your television/receiver input.



### Optical Digital Audio

- Connect an optical audio connector into the S/PDIF connector on the DSM-510 and the matching opposite end of the cable to the audio input of your audio system.

**Note:** *This cable is not supplied.*





## Network Connections

Select one of two ways to connect your DSM-510 to your network:

### RJ-45 Ethernet Connector

- Connect the supplied Ethernet cable to the network cable connector, and attach the other end to a router or hub on your network.



### Wireless Antenna

- Attach the supplied antenna by threading it onto the antenna connector. Be sure the antenna is secure and in an upright position.



# Using the Remote Control

1. Power
2. Alphanumeric Keys
3. HOME
4. SHIFT
5. DELETE
6. VOLUME + & -
7. PAGE UP & DOWN
8. MUTE
9. BACK
10. Enter & Navigation Buttons
11. MENU
12. SETUP
13. Color-Coded Shortcut Keys
14. USB
15. Stop, Play/Pause, REV, FF, PREV, and NEXT
16. REPEAT
17. SHUFFLE
18. SEARCH
19. INFO
20. SLOW
21. A-B
22. L/R

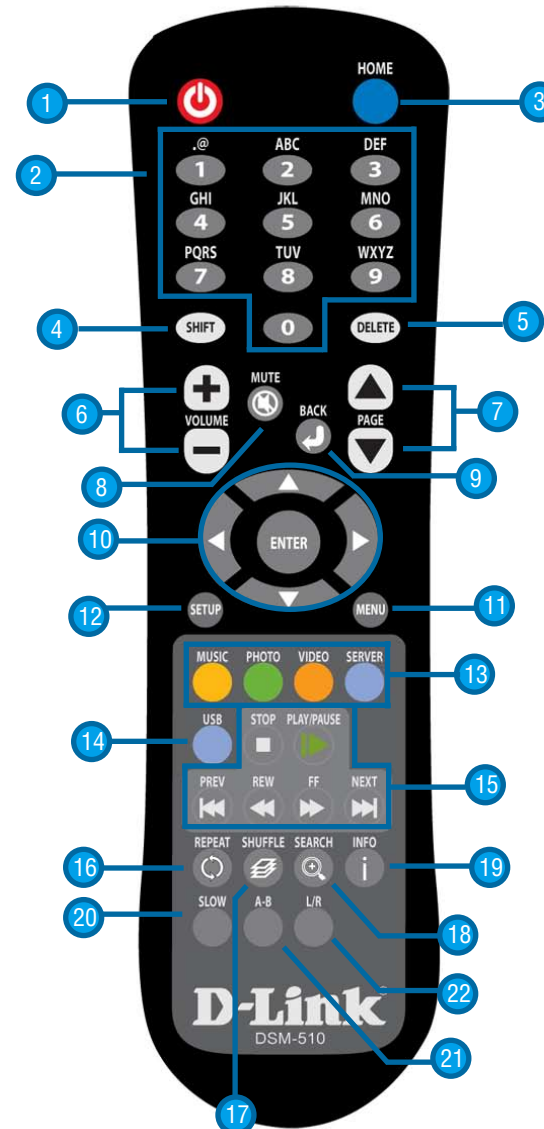

**Note:** Please see the Remote Control Table in the Appendix on page 100 for more information on the functionality of the DSM-510 remote control..

## Power on the DSM-510

Plug in the DSM-510's power cable into the back panel connector, the unit should power on immediately.

**Note:** *If you are using the composite or HDMI video connection, the DSM-510 will automatically detect the correct video signal.*



**If you do not have an Intel® Viiv™ technology-based PC at this time, or if you are connecting the DSM-510 wirelessly and do not have an Intel® Viiv™ technology verified router, please continue to page 21.**

**If you are connecting the DSM-510 wirelessly and have an Intel® Viiv™ technology verified router, please continue to page 20.**

**If you are connecting through a wired Ethernet cable, please continue to page 22.**

# Finalizing Your Wireless Connection with an Intel® Viiiv™ Technology Verified Router

**Note:** Skip to page 21, if you do not have an Intel® Viiiv™ technology verified router.

From the “Welcome to Setup” page of Express Setup, click **OK** if you have an Intel® Viiiv™ technology verified router.

- (1) After clicking **OK**, the next screen will provide you with a temporary four-character passcode. Please memorize or write down this passcode.
- (2) Return to your PC and follow the on-screen instructions to complete the addition of your device to the network. Click **next** to continue to the passcode screen.
- (3) Enter the passcode before the timer expires. and click **next**.

**Note:** If the timer expires before you enter the temporary passcode, you can obtain a new passcode by starting the timer again from the DSM-510.

- (4) After the device has been added to the network, and when you have clicked **OK**, a home page will appear. Please return to your PC to complete the addition of your device.

**Please Continue to page 24!**

# Finalizing Your Wireless Connection without an Intel® Viiv™ Technology Verified Router

From the “Welcome to Setup” page of Express Setup, click **CANCEL** or **MANUAL SETUP** if you do not have an Intel® Viiv™ technology verified router.

- (1) At the next screen, select **Scan for wireless LANs** and click **OK**.
- (2) Using your remote control, select a wireless network from the list and press **ENTER**.
- (3) Select the Encryption Type and the Cryptography Key (Network Password) to configure your wireless settings. Once you’ve completed all of your settings, please click **OK**.
- (4) If you need to manually configure the IP Settings, click the **IP Address Settings** button. You will see a new screen appear that allows you to manually enter in the values.
- (5) To manually enter the IP address information, select **NO** from Get IP Address and press the **ENTER** button on your remote control. The navigation arrows on your remote control will allow you to select the corresponding field that needs to be updated. Press the **ENTER** button on your remote control to select the field and use the number keys to input the information. Press **ENTER** when you have completed entering the information. Click **OK** after you’ve finished updating the IP Address Settings screen.

If you have an Intel® Viiv™ technology-based PC, please continue to page 23.

If you do not have an Intel® Viiv™ technology-based PC, please refer to page 26 for steps to configure Windows® Media Player 11.

**Please Continue to page 23!**

# Finalizing Your Wired Connection

If you connected to your network using a wired Ethernet cable, you will see a screen Congratulating you on a successful connection, click **OK**.

After you have clicked **OK**, a home page will appear. Please return to your PC to complete the addition of your device. At the adding a device to your home network screen click **next**.

**Please Continue to page 24!**

# Adding a Device without an Intel® Viiv™ Technology Verified Router

At the main settings screen, click **view network map**.

**Note:** Your device may have a “?” on it, this means that it is not approved yet.

- (1) After you've clicked on your media device, the next screen will provide details about this device. Click **next** to continue.
- (2) At the **device classification** screen, select **approved** if you want the media device to allow access to the network. Click **next** and you should notice that the following screen has automatically selected your media device. Click **next** to continue.
- (3) If you are using Windows® Vista, you have the opportunity to select a device location.
- (4) When you see the grant **Intel® Viiv™ Media Server access** screen, click **yes** to grant access for your media device. Click **next** to continue.
- (5) After you've granted access to the media device you should be returned to the **network map** menu. Notice that the “?” no longer appears on your media device. Click **back** to return to the main menu.
- (6) At the main menu screen click the **update media library** button to set up your Intel® Viiv™ Media Library.

**Please Continue to page 25!**

## Adding a Device

Your PC will begin adding the device. Please wait...this may take up to five minutes. When it has been added, you will see the **new device found** screen, listing the device name and type. Click **next** to continue.

The following screen should have automatically selected your media device. Click **next** to continue.

If you are using Windows® Vista, you have the opportunity to select a device location.

The next screen you should see is the **device added to the network** screen. When you see this screen, you have successfully added your device to the network.

**Please Continue to page 25!**



## Setting Up the Intel® Viiv™ Media Library

In order to access the media content on your PC, you must setup your Intel® Viiv™ Media Library. At the **get ready** screen, click **next**.

At the **choose a setup and go** screen, it is recommended to select **Standard Update**.

When you see the **update complete** screen, you have successfully completed the setup of your Intel® Viiv™ Media Library.

Click **finish** and return to your DSM-510 unit. You should see a menu, use your remote control to navigate through the menu.

## Navigating to the Intel® Viiv™ Technology Settings Screen and Images on Your PC

You may navigate to the Intel® Viiv™ settings window either by selecting the Intel® Viiv™ logo on your desktop or system tray. The logo can also be found in the **More Programs** area in Windows® XP Media Center Edition 2005.

**You are now ready to use your DSM-510!**

# Windows® Media Player 11 Setup

**Note:** Do not configure Windows® Media Player 11 sharing if you have an Intel® Viiv™ technology verified PC, because you can use the Intel® Viiv™ Media Server that is included with your Intel® Viiv™ technology verified PC.

To share audio, video, and photo files from your computer, it is necessary to have Windows® Media Player 11 or another UPnP™ AV server software on any PC that is not Intel® Viiv™ technology verified. Windows® Media Player 11 software allows you to share your PC's audio, video, and photo files with your media player. Windows® Media Player 11 software then streams the content to your DSM-510 via your wired/wireless network connection.

If more than one PC contains files you want to share, you can select one of the following options:

1. Copy all of the files to one computer designated to run the Windows® Media Player 11 software.
2. Map network drives on the computer with the Windows® Media Player 11 software to additional computers that contain files you want to share. This method also allows you to share files from computers that cannot run the Windows® Media Player 11 software such as Macintosh systems. The computer running the Windows® Media Player 11 software must always be on when streaming content from any computer.

**Note:** In order to share files from your MAC to your PC you must turn on Windows sharing from Preferences Menu and select Sharing.

3. Configure the Windows® Media Player 11 software on each computer. The DSM-510 will aggregate your media into one list under music/photo/video.
4. Power on your DSM-510, and do the following based on your network connection:
  - **Wireless:** Select the option **Cancel**. Connect to your network by selecting a network name and by providing the necessary information for authentication. Please refer to page 21 for step-by-step instructions.
  - **Wired:** After powering on your DSM-510 your network will automatically be detected. Click **Finish**.

To download Media Player 11, visit [microsoft.com](http://microsoft.com).

If you do not have an Intel® Viiv™ technology based PC, the autorun will provide you with steps to configure sharing through Windows® Media Player 11 instead.

In order to share media to your DSM-510 using Windows® Media Player 11 you must first allow your media player access in the software. Click the down arrow under **Library** and select **Media Sharing**.

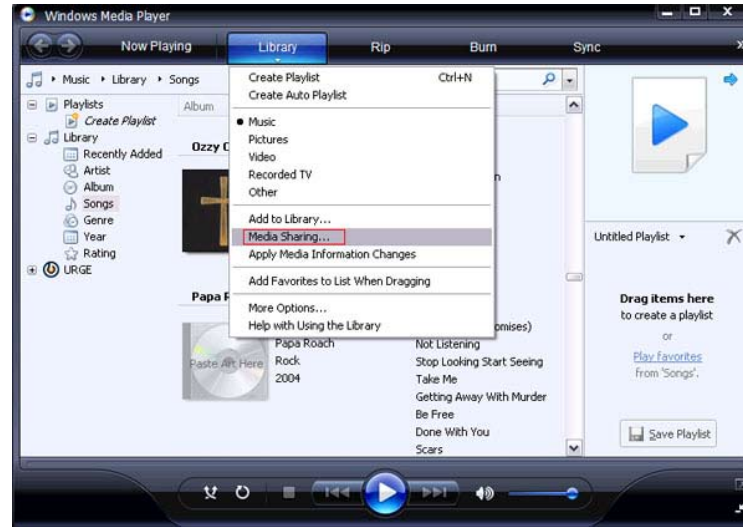

Click the **Share my media to:** check box. Select your **D-Link DSM-510** media player from the *Media Sharing* box and then click the **Allow** button.

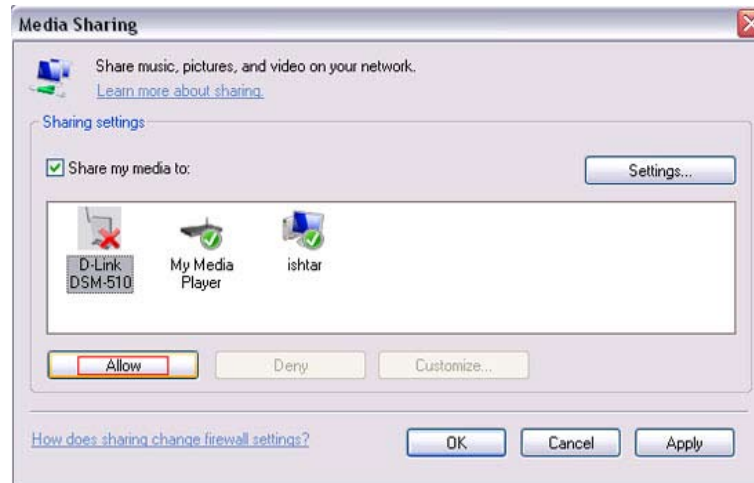

Your device will now have a green check mark. Click **Apply** and then click **OK**.

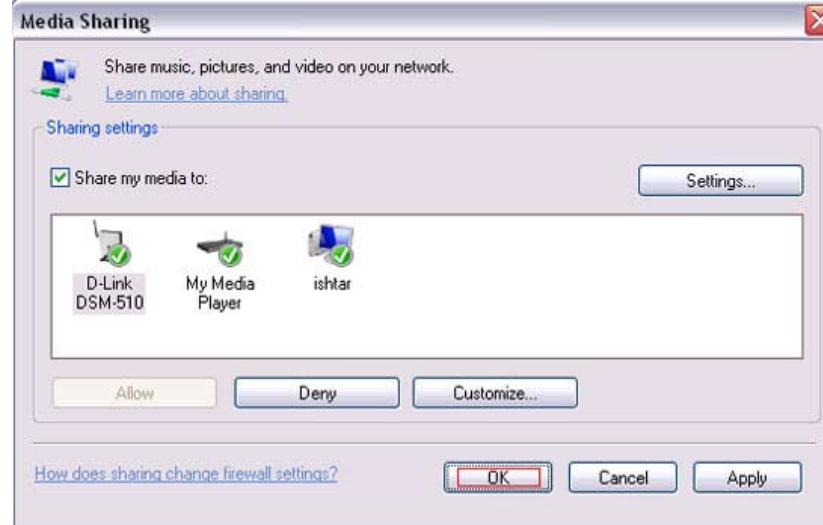

Now you need to add the folders containing media you want shared with your DSM-510. Click on **Library** and then click on **Add to Library**.



Click the **Advanced Options** button in the bottom left-hand corner. Click **Add** and choose the folders with media you wish to be shared. If you have folders in other areas of your hard drive or on other drives in your pc or network, you will need to select the **Add** button and select each folder manually. Once you have added the folder(s) you want to share click **OK**.

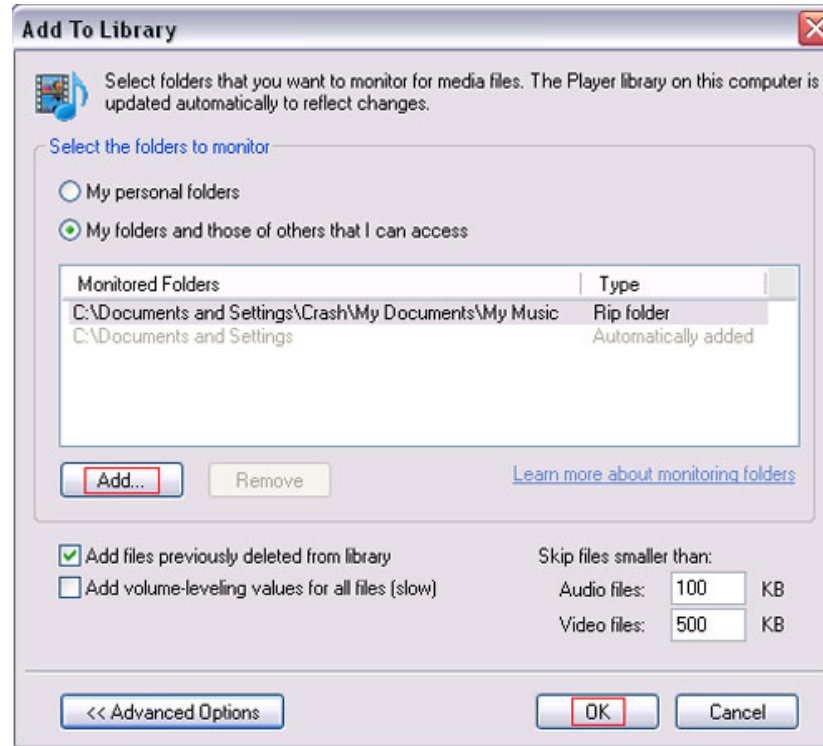

Windows® Media Player 11 will now search for supported media files in the folders you selected to share.

Click **Close** and you are ready to use Windows® Media Player 11 as your server.

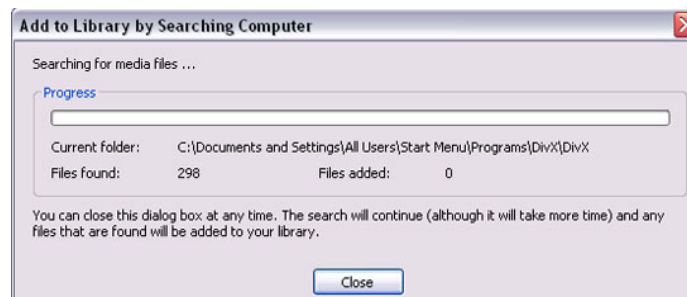

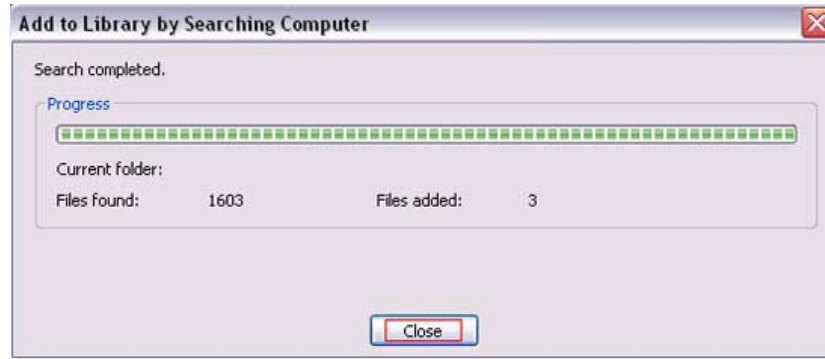

You can now return to your TV and select the **Server** option from the Home page of the D-Link DSM-510 or you can press the **Server** button on the D-Link DSM-510 remote control.



Once you have confirmed that your Windows® Media Player sharing has been enabled and is showing on your D-Link DSM-510 you can select your Music, Photos or Videos options in the **Home** menu or press the hotkeys on your remote control.



**Note:** Please refer to page 15 for information on connecting your DSM-510 device.

If you are using Windows Vista and Media Sharing is disabled, follow these steps to enable media sharing:

Open Windows® Media Player 11. Click the down arrow under **Library** and select **Media Sharing**.

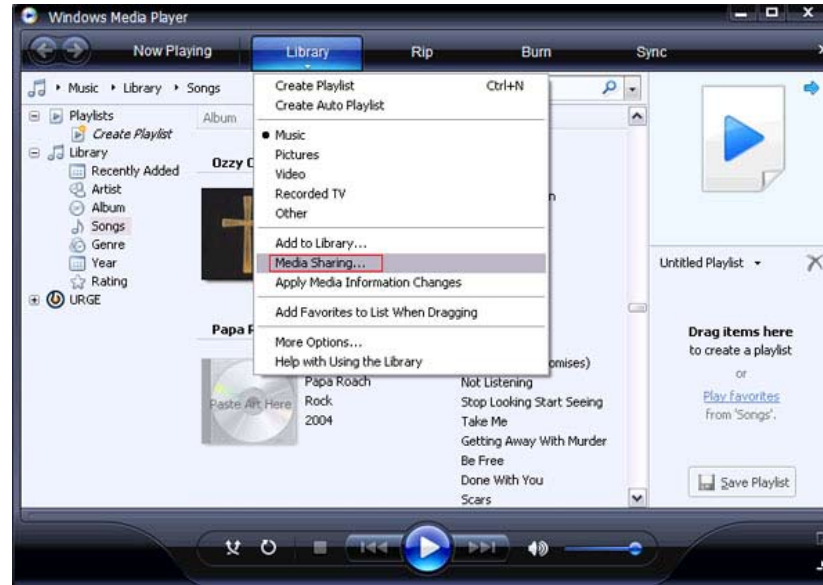

Click the **Networking** button.

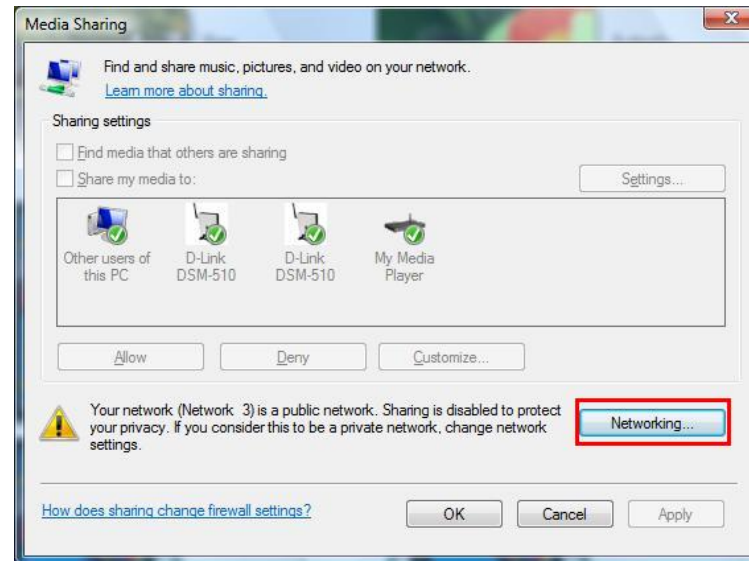



Click the Customize button.



Select **Private** under *Location Type*. Click the **Next** button.

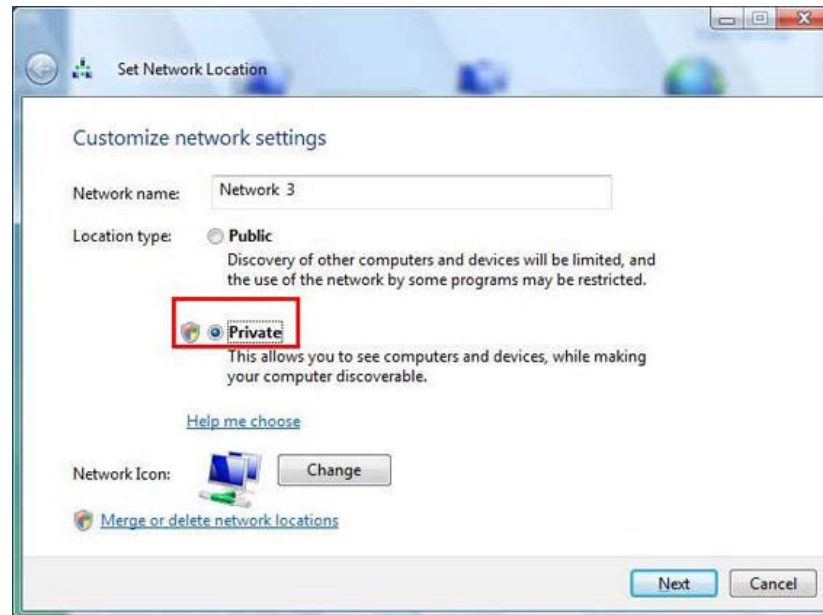

Click the **Close** button. Media sharing should now be accessible from your Windows® Vista machine.

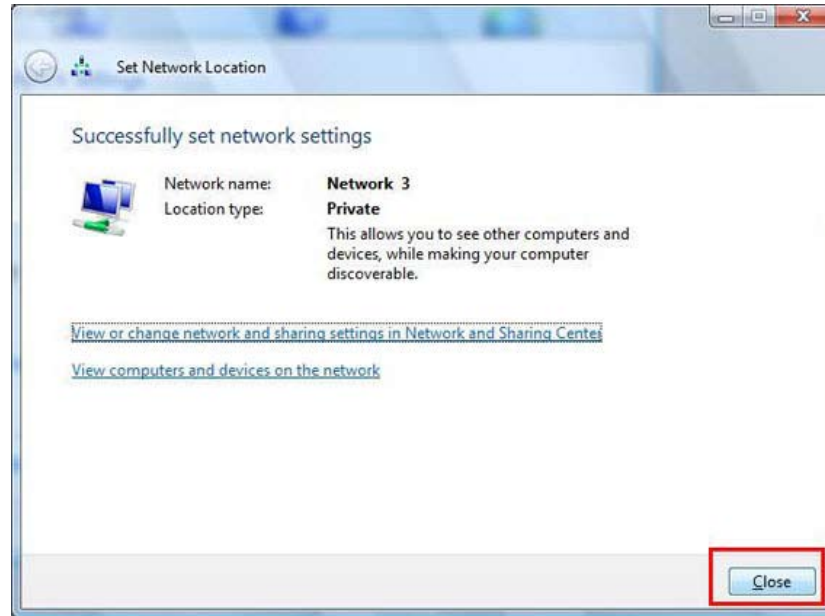

# Settings

Press the **Setup** button on your remote control to configure your DSM-510.

## Options

**Network Settings:** This option allows you to modify your wireless and wired settings. You can also access your WCN® setup wizard from this screen.

**TV Settings:** This option allows you to change your video output type between Digital (HDMI) and Analog (Composite), as well as the resolution size.

**Audio Output Settings:** Select the audio output type for different audio formats.

**Language Settings:** This option allows you to choose the language that the interface is displayed in.

**Settings for Ease of Use:** Here you can configure settings for your device's startup, which will allow easier access to your media.

**Reset Settings:** This will restart your device to factory settings.

**Software Update:** This option allows you to update the DSM-510.

**Device Information:** This option displays information concerning the DSM-510.

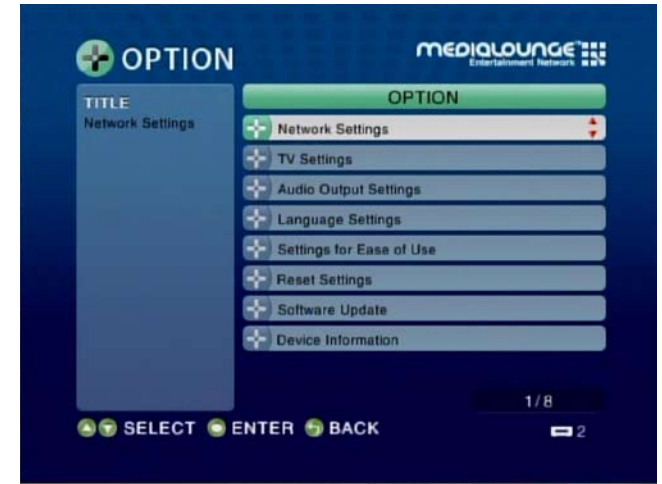

# On-Screen Keyboard

In order to input information, you must use the DSM-510 keyboard interface. When information is needed within an input box, click the **MENU** key on your remote control and select the Keyboard Input option.

Use the **selection arrows** and the **ENTER** button to select from Numbers, Lower (lower case alphabet), Upper (upper case alphabet), or Symbol. The **SHIFT** key on your remote control can also toggle between these options if pressed repeatedly. Once you've selected your character type, use the **selection arrows** on your remote control to select the characters you want to input. When you have finished, select **OK**.



# Network Settings

**Wired LAN Settings:** If you want to connect through an Ethernet cable, then select this option.

Select this option if you are using the antenna to connect wirelessly to a server.

## Wireless LAN Settings:



## Wired LAN Settings

**Get IP Address:** Clicking this button will retrieve the IP address automatically (Recommended).

Input the IP Address.

### IP Address:

Input the Subnet Mask.

### Subnet Mask:

Input the Default gateway.

### Default Gateway:

In case a DNS server exists in the network, input the IP Address of the DNS server.

### DNS Server:

Displays the MAC Address.

### MAC Address:



## Wireless LAN Settings

- Scan for wireless LANs:** Click this button to search for wireless LANs, and select your Access Point.
- Manual Configuration:** Click this button to manually connect to the network (see the following screen).
- Windows Connect Now:** Click this option if you want to use Windows Connect Now® to configure your device's wireless connection. If you want to configure your device's wireless connection, please continue to page 37.



## Wireless LAN Profile Settings

To exchange connection priorities, click the **MENU** button on your remote control.

**Set to Exchange:** Pick the wireless access point that you want to exchange connection priorities.

**Exchange:** This option will initialize the move between wireless access points.

This will remove the wireless access point profile from the list.

**Remove:**

**Note:** In order for the exchange to take effect, you must power cycle the DSM-510 (meaning you must turn off the DSM-510 and turn it back on again).

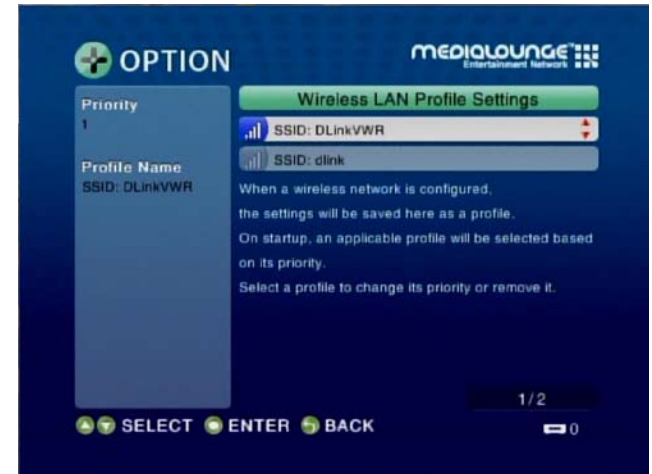

## Manual Configuration

**MODE:** Choose between **Ad-Hoc** or **Infrastructure**.

**Ad-Hoc** should be selected when the DSM-510 is directly connected to other wireless network devices without an access point.

**Infrastructure** should be selected when the DSM-510 is connected to the wireless LAN where an access point device exists. (Recommended)

Displays the Wireless LAN Type as 802.11b/g.

**Wireless LAN Type:**

Using the software keyboard input the SSID, which should be used by the

**SSID:** existing wireless network.

Select between None, WEP, or WPA.

**Encryption Type:**

When WEP or WPA is selected in Encryption Type, two boxes will appear (the **Index Selection** box and the **Cryptography Key** input box).

**Cryptography Key or Network Passcode:**

**Index Selection** box allows you to select an Index number from 1 to 4. Each index number saves a Cryptography Key.

**Cryptography Key** allows you to enter the WEP or WPA key used in the existing wireless network.

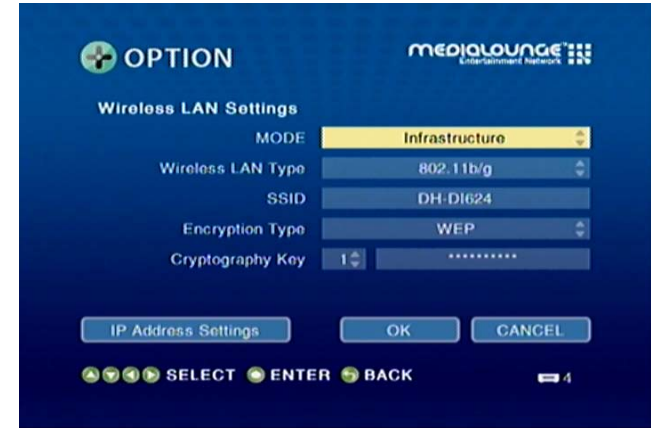

# TV Settings

**Output Type:** Select between Digital (HDMI) and Analog (Composite).

**Screen Size:** Select between 4:3 or 16:9.

**Resolution:** If the output type is set to Digital (HDMI), select between Auto, 480i, 480p, 1080i, and 720p. If the output type you selected is Analog (Composite), select between 480i, 480p, 1080i, and 720p.



# Audio Output Settings

**AAC:** You can choose to output audio in LPCM or have it turned off to the digital output.

**Dolby Digital:** You can choose to output audio in 2 channel or 5.1 for analog. You can also change the digital output from LPCM to Dolby Digital or off.

**WMA:** You can choose to output audio in 2 channel or 5.1 for analog. You can also change the digital output from LPCM to off.

**Auto Volume Control Strength:** There are three variable settings to select from: Small, Moderate, and Strong. These control the audio output depending on the strength of the media file.

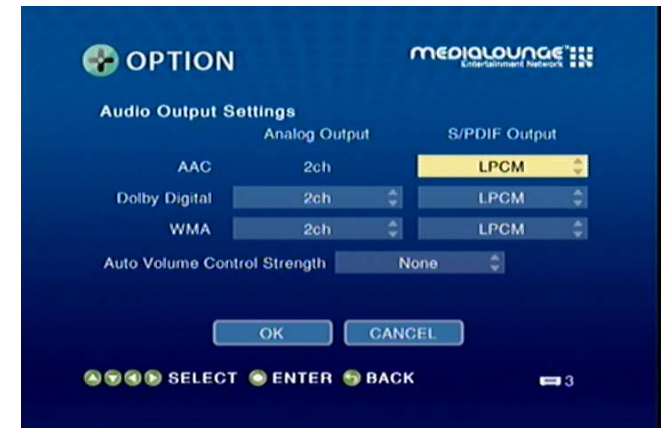



# Language Settings

Select the available language that best fits your interface.



# Settings for Ease of Use

**Connect to last accessed server automatically:** On startup your DSM-510 will try to access the last media source it was connected to.

**Connect to single server/USB automatically:** If only one media source or USB is detected the media server will connect to it automatically.

**Resume last screen from standby:** After turning on the unit, the last screen accessed will be displayed.

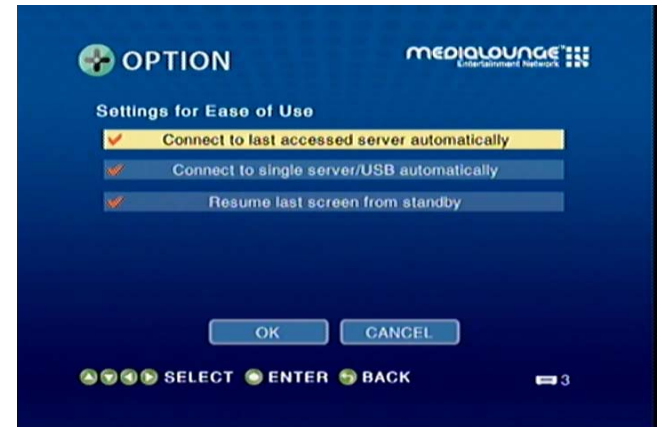

# Reset Settings

You can reset the DSM-510's settings from Options and select Reset Settings. On the following screen, select **RESET**.



To perform a hard reset, please locate the pinhole reset button on the bottom edge of the device. Insert a paperclip while the unit is powered on and hold it in for 10 seconds. After 10 seconds, remove the paperclip from the pinhole reset button.



# Software Update

**Update over Internet:** Select this option to update the DSM-510 through an Internet connection. Select **OK** and then select **Next** for the DSM-510 to check for an update. If an update is available, you will be able to click **Next** and the DSM-510 will download and install the updated software.

**Update from USB:** Select this option to update the DSM-510 through a USB device. Download the USB Update Software from <http://support.dlink.com>. Extract and copy the update folder from your PC onto your USB drive. Insert the USB drive into the DSM-510 and select **Next**. If an update is found, you will be able to select **Next** and continue updating your DSM-510 software.



# Device Information

This screen will display information about the DSM-510.

**Device Name:** Displays the name of the device.

**Version:** This will show the current version of the software that the device is using.

**MAC Address:** Shows the Wired and Wireless MAC address of the DSM-510.



# Windows® Connect Now for XP

If you already have wireless settings configured on your PC, instead of using the Intel® Viiv™ setup , you can use Windows® Connect Now (WCN) to configure the wireless settings on your DSM-510.

**Note:** WCN is only available on PCs running Windows® Vista and Windows® XP with Service Pack 2 installed. If you are running Windows® Vista on your PC, continue to page 44.

Go to **Start > All Programs > Accessories > Communications** and click **Wireless Network Setup Wizard**.

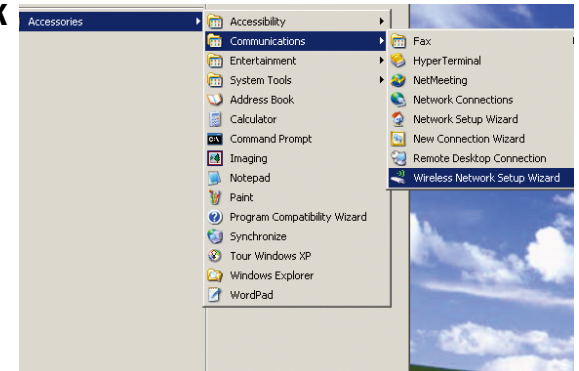

Your system will display the Setup Wizard Welcome screen. Click **Next** to continue.



Click **Next**

Select to add a new device to your existing wireless network and click **Next** to continue.

Click **Next**

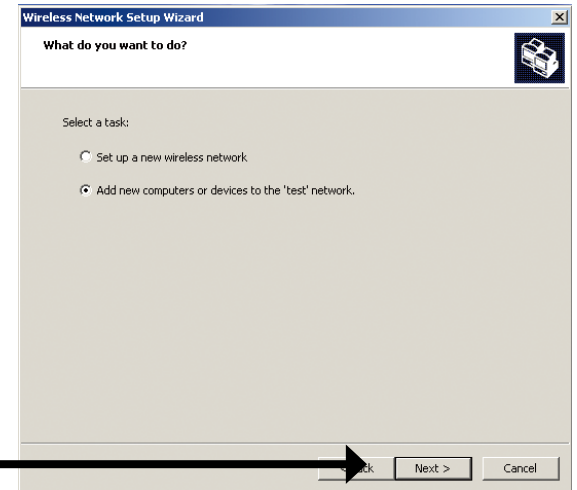

The wizard provides two methods for setting up a wireless network. Select to use a USB flash drive to save your wireless network settings and click **Next** to continue.

**Note:** Using a USB flash drive is recommended.

Click **Next**

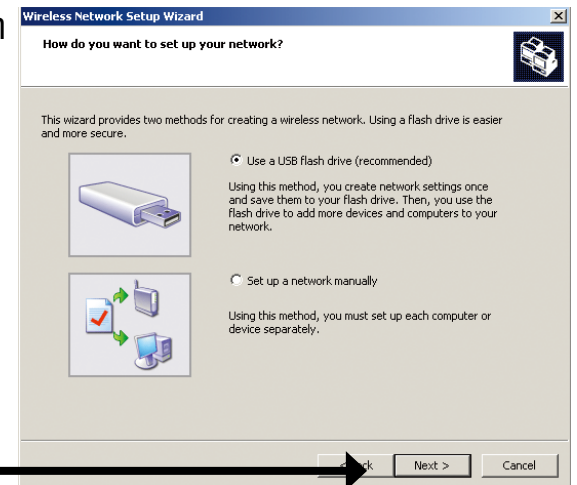

Plug your flash drive into a USB port on this computer. The drive letter will appear in the pull down menu. You can choose to use this drive or select another drive. Click **Next** to save your wireless settings to the USB flash drive. This may take a few seconds.

Click **Next**

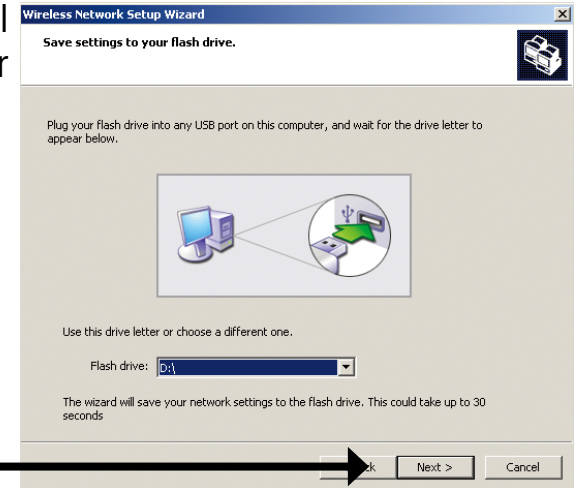

This screen will appear when the wireless settings have been saved to the USB flash drive.

Click **Next**

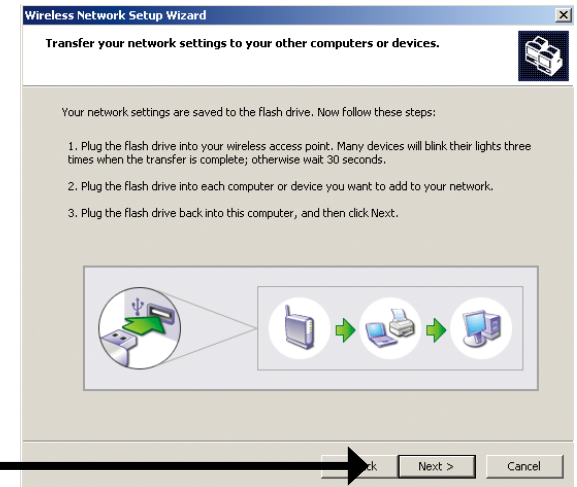

Next, remove the USB Flash Drive from your PC and insert into the USB port on the back panel of the DSM-510.

From the device, select the option **Windows Connect Now**. Click **OK**.



The following screen will appear, manually configure your Wireless LAN settings. After you've completed your settings, click **OK**.



The following screen confirms that your wireless settings have been applied. Click **OK**.



Next, return to your PC and remove the USB Flash Drive from the DSM-510 and insert it back into the USB port on your PC. Click **Next** to continue.

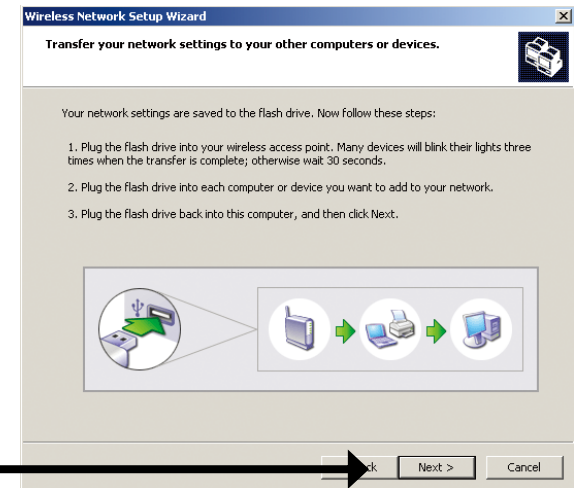

Click **Next**



Wireless configuration using WCN is now complete. The setup wizard will display the devices that have been setup with your wireless network. Click **Finish**.

Click **Finish**

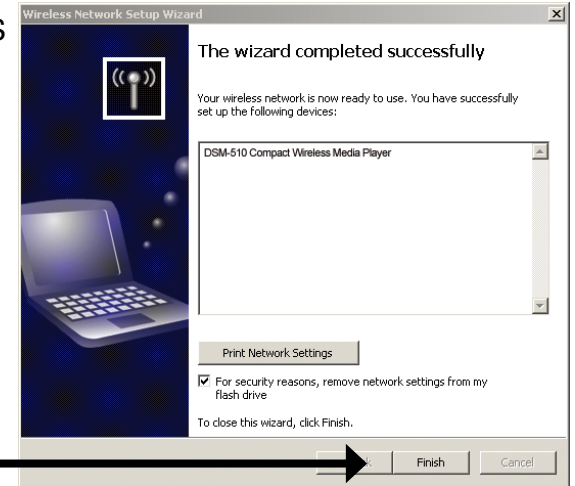

**Windows® Connect Now has been configured for Windows® XP/2000!**

# Windows® Connect Now for Vista

On your Windows® Vista PC, open up your Control Panel and select the **Network and Internet** option.



Next, select the **Network and Sharing Center** option.



On the following screen, select **Set up a connection or network**.

The choose a connection option window will appear. Select the **Set up a wireless router or access point** option and click **Next**.

The following screen offers more information, click **Next** to begin the wizard.

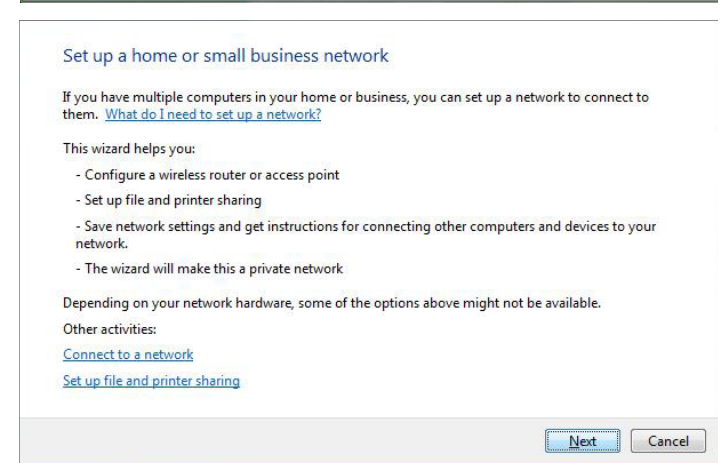
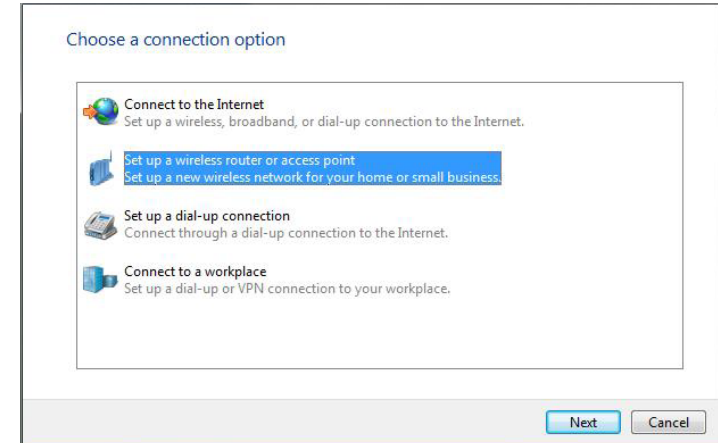
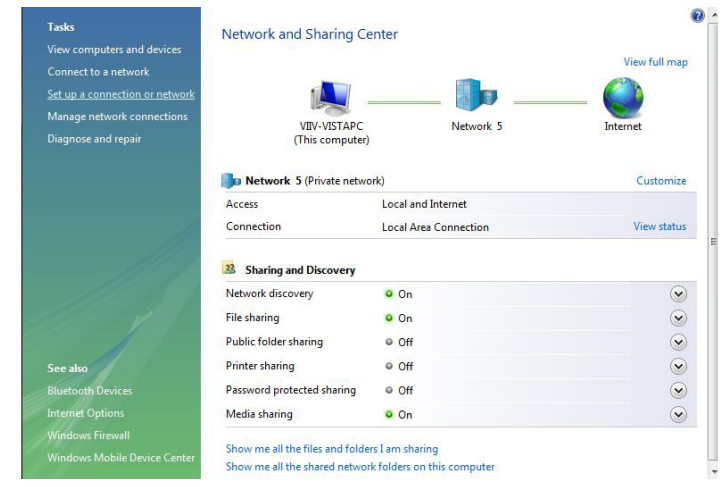

Select the **Create wireless network settings and save to USB flash drive** option.

Enter a passphrase to secure your network and click **Next**.

The following screen will provide you with a list of network security options. Select the best option and click **Next** to continue.

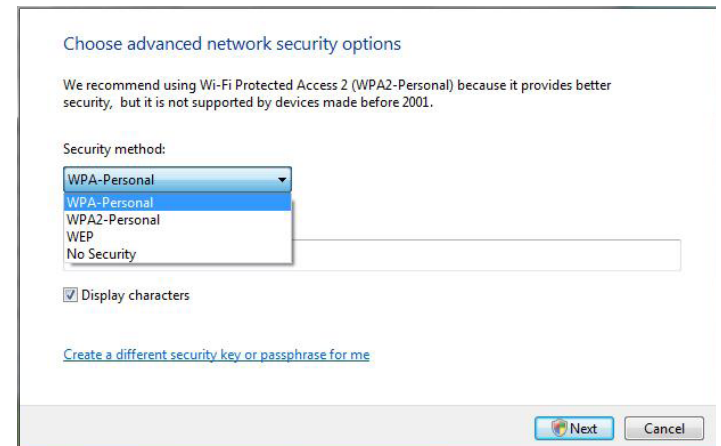
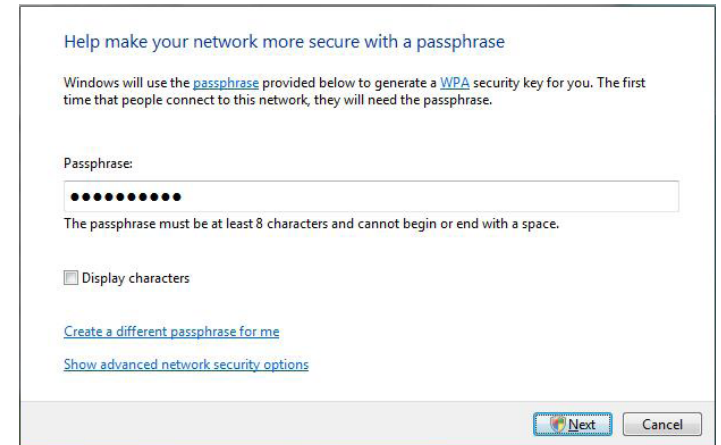
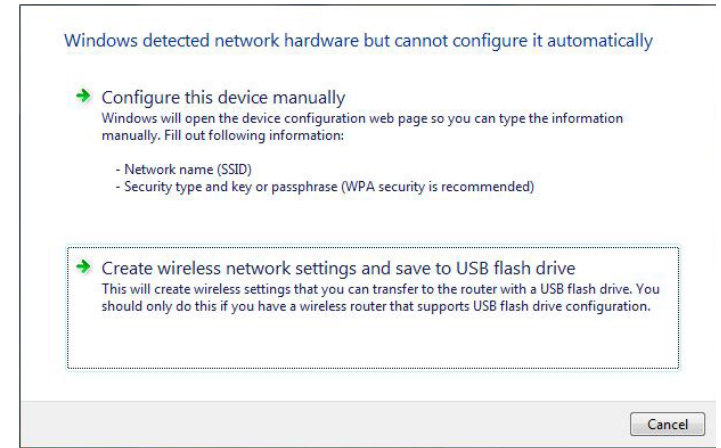

The choose file and printer sharing options window will appear, select the option to keep the custom setting you already have, and click **Next**.

Plug your flash drive into a USB port on your computer. The driver letter will appear in the pull down menu. You can choose to use the drive or select another drive. Click **Next** to save your wireless settings to the USB flash drive.

The following screen will begin saving the wireless settings to your USB flash drive. This may take a few seconds.

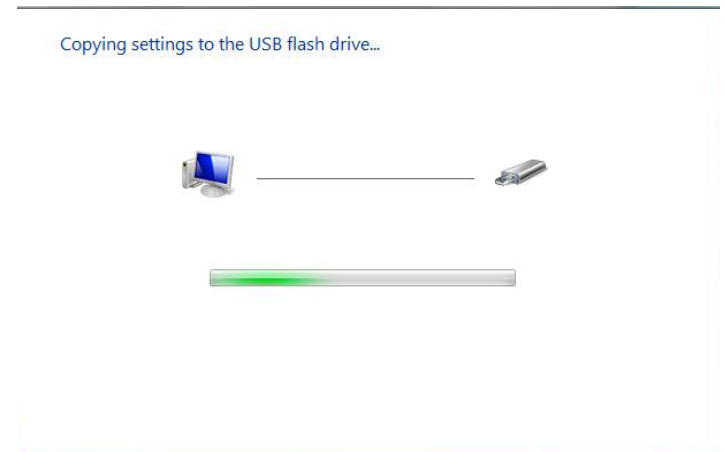
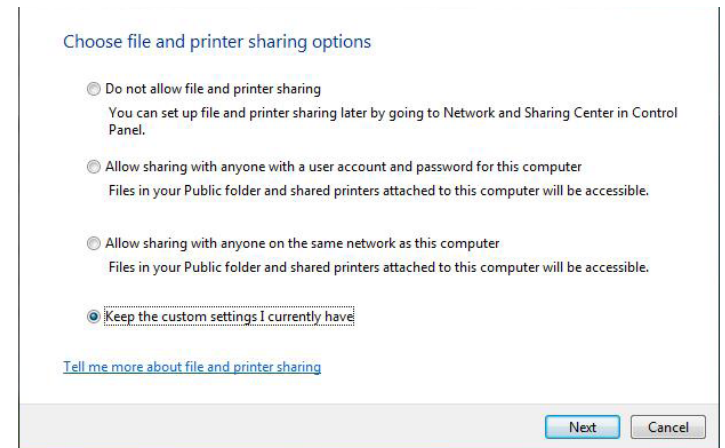

This screen will appear when the wireless settings have been saved to the USB flash drive.

Remove the USB flash drive from your PC and insert it into the USB port on the front panel of the DSM-510.

To add a device or computer, follow these instructions

- 1 Remove the USB flash drive from this computer.
- 2 Insert the USB flash drive into a USB port on the device or the computer. (Computers must be running Windows XP or Windows Vista.)
- 3 For devices, follow the instructions in the information that came with the device, or on the LCD of the device, if applicable.

[For more detailed instructions, click here.](#)



Repeat steps 2 and 3 for each device or computer that you want to add.

Close

From the device, select the option **Windows Connect Now**. Click **OK**.



OPTION MEDIALOUNGE Entertainment Network

Wireless LAN Settings

Select configuration method for wireless LAN

- Scan for wireless LANs
- Manual Configuration
- Windows Connect Now**
- Wireless LAN Profile Settings

OK CANCEL

SELECT ENTER BACK

The following screen will appear after you've verified your settings. Click **OK** to continue.



The following screen confirms that your wireless settings have been applied. Click **OK**.



**Windows® Connect Now has been configured for Windows® Vista!**



# Operating the DSM-510

**VIDEO:** Click **ENTER** on your remote control to show the Video Contents selection screen.

**MUSIC:** Click **ENTER** on your remote control to show the Music Contents selection screen.

**PHOTO:** Click **ENTER** on your remote control to show the Photo Contents selection screen.

**SERVER:** Click **ENTER** on your remote control to show the Server selection screen.

Click **ENTER** on your remote control to show the Connected USB Device List.

**USB:** Click **ENTER** on your remote control to show the Options screen.

**OPTION:**



**Note:** To directly access this screen, press the **HOME** button on the remote control.

**Note:** If the Intel® Viiv™ technology verified PC is powered down, selecting the Intel® Viiv™ Media Server will power it back up to provide access to music, photo, video, and the Intel® Viiv™ Zone.

## Menu Basics

The DSM-510 uses an on-screen menu interface. As you move through the menus, you will use the **selection arrows** on the remote control to move up, down, right and left. The highlight bar moves from item to item as you press the selection arrows. You will need to press **ENTER** on the remote control to access the item. The **Page Up** and **Page Down** buttons can be used to navigate through the track list one page at a time. Once you are in a particular category, you can press the **MENU** button on your remote control to access the pulldown menu within that category.



# Music

## Music Quality

Your music listening experience on the media player depends upon the quality of your digital music files on your PC. Avoid quality settings below 48kbps as they create low quality audio. For CD quality music, rip your MP3s at 128kbps or higher, with a sample rate of 44.1kHz.

## Supported Music Formats

The following music file formats are supported:

- **MP3** (up to 320 kbps)

MPEG-1, Layer 3 Audio file -The standard Internet music file format. This is the most commonly used audio format.

- **WMA** (Does not support WMA lossless)

Windows Media Audio file - Supported by the Microsoft Windows Media player and some music jukebox programs. Also supports WMDRM protected WMA files downloaded from online services and WMA Pro.

- **WAV**

WAV was developed by Microsoft and IBM. WAV sound files end in .wav and are compatible with Windows applications supporting audio.

- **AIFF** (AIFF files must be encoded in PCM format only.)

AIFF (Audio Interchange File Format) was developed by Apple Computers and is the standard audio format for Macintosh computers. File extensions are .AIF or .IEF.

- **MPEG 1** and **MPEG 2**

Moving Pictures Experts Group created standards for compressing audio and video. Audio uses the file extension .mp3.

- **OGG Vorbis**

Open source audio format. Uses the file extension .ogg.



## Accessing Music

Select the **MUSIC** category from the HOME page or click the **MUSIC** button on the remote control. Select a category, by using the **down arrow** and **up arrow** on the remote control to navigate (choose from Playlist, Genre, Artist, Album, All Music, Folders, or Favorites). Select your option by clicking **ENTER**. If you want to play all of the tracks within the category you selected, simply press the **Play** button. If you want to play just one track, use the **up arrow** and **down arrow** buttons to navigate one track at a time. After the appropriate track is highlighted, press **ENTER** on the remote control. The **Page Up** and **Page Down** buttons can be used to navigate through the track list one page at a time.

## Playing a Track

Once you enter the music menu, there are several ways that you can view tracks. You can view Playlist, Genre, Artist, Album, All Music, Folders, or Favorites.

If you select to view All Music (see the following menu), then use the **selection arrows** to navigate to the track you wish to play. Once you have located the appropriate track, highlight it and press **ENTER** or **Play** on the remote control. The track will begin playing on your stereo or television speakers.

To play all of the tracks visible in this category, simply press **Play**.



## Playing a Group of Songs

Select a music folder and press the **Play** button on the remote control, all of the songs within the selected folder will be played. You can highlight a genre of music and all files that are associated with that genre will be displayed. Genre categories are defined when an audio file is created.

You can play songs within a folder from a specified track forward. For instance, if you have a folder with ten tracks and select Track 3, clicking on the **Play** button will play tracks 3 through 10.

## Creating Music Playlists using 3rd Party Software

Use your favorite music software on your PC to create music playlists. A playlist allows you to specify exactly what tracks to play and in what order to play them. For example, create a “favorites” playlist and just listen to your favorite tracks.

The DSM-510 will play tracks from playlists you create on your computer. The media player supports playlists in three standard formats:

- **m3u** Playlist File
- **pls** Playlist File
- **wpl** Playlist File

Software for playing music on your PC can be used to create playlists. **WinAmp™** and Microsoft Windows® Media Player™ are two examples.

## Playing a Playlist

To play all the tracks in a playlist, select the playlist name and press the **Play** button. All tracks will be played in the playlist.



## Adding Favorites

Click the **MENU** button on your remote control and you should see the Add Favorite option. Highlight the Add Favorite option and press **ENTER** (see the following image).

Select the Favorites folder you want to add this Playlist, Genre, Artist, Album, or Folder to and click **OK**.



## Browsing for Music

There are many ways to browse for a music track. For example, let's use the following music file located in the following shared location:

*c:\Documents and Settings\Administrator\My Documents\My Music\Beethoven\Ode to joy.mp3*

*To browse for this track in the track list:*

1. Select **All Music**
2. Highlight **Ode to joy**

*To browse by artist:*

1. Select **Artist**
2. Select **Ludwig van Beethoven**
3. Select **Beethoven**
4. Highlight **Ode to joy**

*To browse by album:*

1. Select **Album**
2. Select **Beethoven**
3. Highlight **Ode to joy**

*To browse by genre:*

1. Select **Genre**
2. Select **Classical**
3. Select **Ludwig van Beethoven**
4. Select **Beethoven**
5. Highlight **Ode to joy**

*To browse by folder:*

1. Select **Folders**
2. Select **My Music**
3. Select **Beethoven**
4. Select **Ode to joy**

**Track:** *Ode to joy.mp3*

**Artist:** *Ludwig van Beethoven*

**Album:** *Beethoven*





**Genre:** *Classical*

## Controlling Music Playback

Your DSM-510 works just like a stereo or CD player. Controlling your music playback will be an easy and natural experience. Use the remote to **Play**, **Pause**, or **Stop** music. You can also use your remote control to **Fast Forward** or **Fast Reverse** the track. Press the **Previous** and **Next** buttons to skip to the previous or next track.

### Repeat

You can turn on the repeat function to continuously play individual tracks, playlists, or groups of tracks within a folder.

To repeat a track or a group of tracks, press **REPEAT** on the remote control. When the the Repeat icon appears in the lower right hand corner  , then you  in the repeat current group of tracks mode. Press **REPEAT** for the second time and the Repeat One icon will appear in the lower right hand corner  , this will repeat the track that  currently playing.

### Shuffle

When you are playing a group of tracks, you can randomize the play order by pressing the **SHUFFLE** button on the remote control. You will see the shuffle icon in the lower right hand corner light up  .



## Time Search

You can search to a specific time in a music file by using the Time Search function. While your music is playing, click the **MENU** button on your remote control. Navigate to the Time Search option and press **ENTER** (see the following image). Using your remote control, enter the minutes and seconds you want the player to start from, and click **OK**.

**Note:** The Time Search function may not be supported outside the Intel® Viiv™ Server.

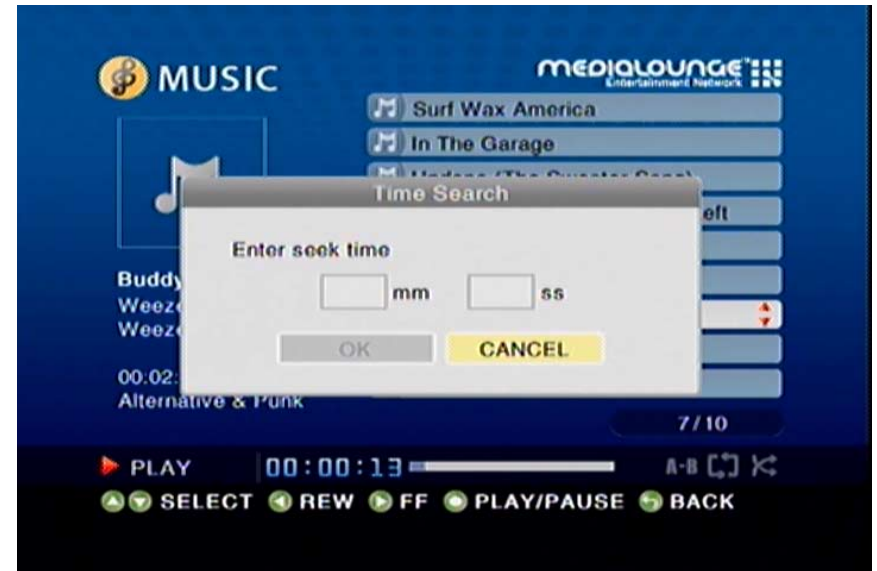

# Podcasts

After selecting the Music option from the DSM-510 main menu, a new menu will appear. Locate and select the **Podcast** option.



To add or import a podcast stream, use your remote control and select the **MENU** button.





## Importing Podcasts

You should see a menu that appears over the podcast section.

- (1) To import your Podcasts you will need a USB thumb drive. You can either export your podcasts from iTunes software or create your own list in notepad on your pc. If you are manually creating your list please use the following format.

```
<?xml version="1.0" encoding="UTF-8"?>
<opml version="1.0">
<head>
</head>
<body>
<outline type="rss" xmlUrl=" http://www.dlinktv.com/podcast" />
<outline type="rss" xmlUrl=" http://www.yourpodcasthere/url" />
</body>
</opml>
```

- (2) Once you have added your URL's to the notepad document, save the file as **Podcasts.opml**.

**Note:** Make sure that the save as type is set to All Files, and then click **Save**.

- (3) Next, copy your Podcasts.opml document to your USB thumb drive. Insert your USB thumb drive into the front panel of the DSM-510.
- (4) Next, go to **Music > Podcasts**. Select **MENU** on your remote control, locate the Import option and press **ENTER** on your remote control..
- (5) The DSM-510 will now search your USB drive for the Podcasts.opml file and save the links into your device.
- (6) Once the links have been loaded you may remove your USB thumb drive and access your Podcast stations.



## Adding Podcasts

Using your remote control, toggle down to the option **Add Podcast** and select the remote's **ENTER** button.

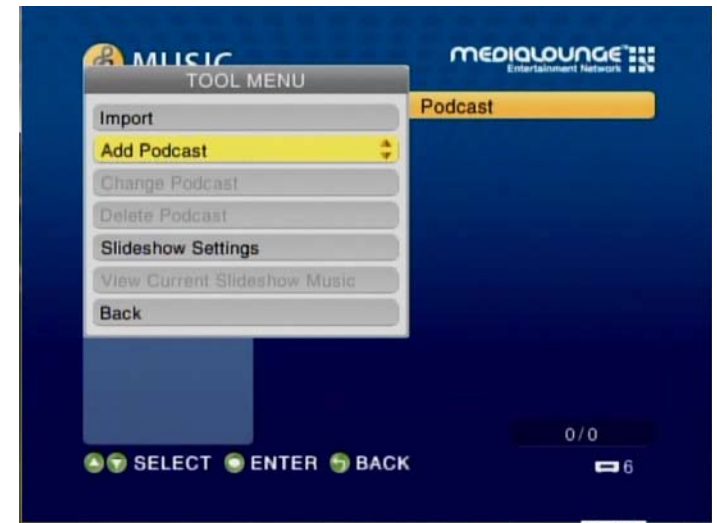

On the following screen, enter the URL of the podcast stream by accessing the on-screen keyboard option.



Using your remote control, toggle to the appropriate letter and press **ENTER**. After you've completed entering the URL, click **OK**.



The podcast stream should now appear on the podcast main menu screen. Select your stream by clicking the remote's **ENTER** button.

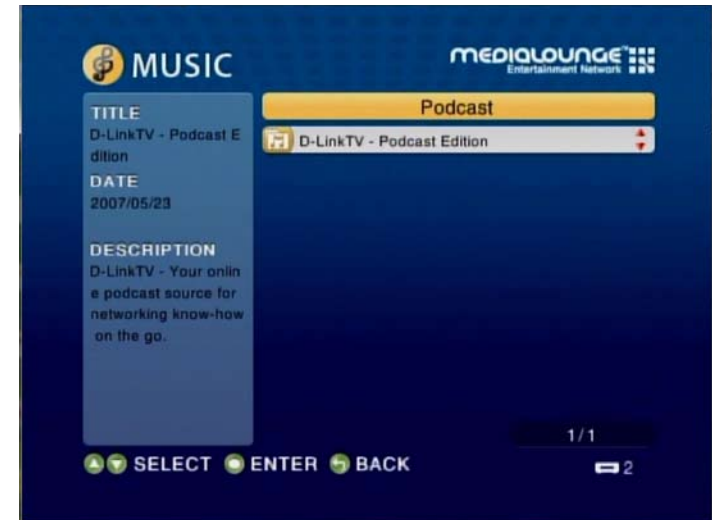

The following screen will showcase all available streams. Use your remote control to toggle and select your option.



After a selection has been made, the file will play.



# Photo

## Supported Photo Formats

The following photo file formats are supported:

- **BMP** (non-compressed)  
Windows bitmap file. Widely used in Microsoft Windows for pictures and backgrounds.
- **JPEG** (grayscale, RGB, YCbCy)  
(Does not support CMYK, YCCK.)  
The JPEG format is the Internet and digital photo format standard used by most digital cameras.
- **GIF**  
(Animated GIF's are not supported)  
Older format still widely available on the internet for photos, web pages, and clip art.
- **PNG** (Non-alpha channel only)  
Portable Network Graphics standard created in response to limitations in the GIF file format.
- **TIFF** (RGB)  
(Does not support CMYK, YMC, YMCK, KCMY)  
Tagged Image File Format is a raster file format.



Select the **PHOTO** category from the Home page or click the **PHOTO** button on the remote control. Select a category, by using the **down arrow** and **up arrow** on the remote control to navigate (choose between All Pictures, Album, or Favorites). Select your category by clicking **ENTER**. After the appropriate picture is highlighted, press **ENTER**, or **Play** to start a slideshow, on the remote control. The **Page Up** and **Page Down** buttons can be used to navigate through the picture list one page at a time.

## Organizing Photo Albums

Unlike music files, photos contain little information about their content. Therefore, photos are organized by their filename and by the folder they are in. Many digital cameras will organize your photos into folders when you connect and unload them to your PC. Each time you dock or connect, a new folder is created using the current date and time, and all photos are copied into that folder.

To simplify browsing on your DSM-510, you can create folders on your PC. For instance, create a folder in the My Pictures directory called **Vacation** and copy all of your vacation photos into it. Your DSM-510 will show the **Vacation** folder. To play a slideshow of the folder, highlight it and press the **Play** button. To view a list of photos in the folder, highlight it and press the **right arrow** button.

You can give your photos meaningful names by renaming the files on the PC. Most digital cameras number photos sequentially. For example, rename the photo **IM001125.jpg** to **sunset.jpg** on your PC. The photo will be displayed as **sunset.jpg** on your DSM-510\*.

**Right-click** on the file and select Rename.

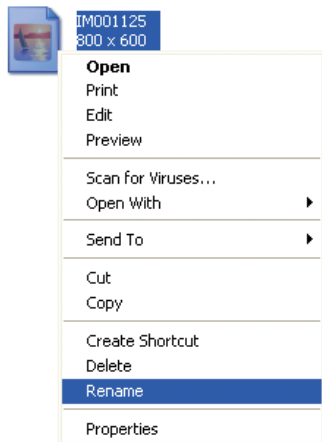

If the file extension does not appear as part of the name displayed when you select rename, then it is not necessary to enter the file extension (**.jpg**) at the end of the filename. To rename IM001125.jpg to sunset.jpg, type in **sunset** and hit Enter on your computer's keyboard.



**sunset**

If the file extension appears as part of the name when you select rename, then be sure to include the extension when renaming the file. To rename IM001125.jpg to sunset.jpg, type in **sunset.jpg** and hit Enter on your computer's keyboard.

You can create as many folders as you need. Create a folder for the year, then create folders inside for each of the months, and then folders in each month for special occasions (birthday, vacation, holidays, etc...).

*\*Folder creation and renaming files must be done on the PC via standard Windows® procedures.*

## Playing a Photo Slideshow

To start playing a photo slideshow, select a folder and press **Play** to start your slideshow. The first photo will be displayed, followed by the next photo in the folder, and so on. All the photos in the folder will display.

## Playing a Photo Slideshow with Music

To start playing a photo slideshow accompanied by music, start by selecting a music track in a folder and press the **Play** button. Next, press the **BACK** button on the remote control to exit the music playing screen and return to the list of music tracks. You can also press the **PHOTO** button and select the folder that has the photos to be displayed. Select the first photo to be viewed and press the **Play** button to start your slideshow. All the photos in the folder will display. Before you begin the slideshow, or after it ends, press the **MUSIC** button to return to the list of music tracks.

You can also play music from your favorite list by pressing the menu key during a photo slideshow and selecting the favorite group with your music.

If you wish to return to the music you were playing before starting the slideshow, press the **BACK** button on the remote control to leave the photo slideshow. Then press the **MENU** key on the remote control and select **View Current Slideshow Music**.

## Controlling Photo Playback

Controlling photo playback is very similar to controlling a CD player. Once you have started a photo slideshow, use the remote to **Play**, **Pause**, or **Stop** the show. Press the **Previous** and **Next** buttons to skip to the previous or next photo.

### Repeat

You can turn on the repeat function to repeat all of the photos in a slideshow.

To repeat a slideshow, press **REPEAT** on the remote control. When the Repeat icon appears in the lower right hand corner, you are in the repeat current slideshow mode.



### Shuffle

During slideshow playback you can shuffle the order by pressing the **SHUFFLE** button on the remote control.



# Video

## Supported Video Formats

The following video file formats are supported:

- **MPEG-1** (Resolution up to 480p)
- **MPEG-2** (Resolution up to 1080i)
- **MPEG-4** (ASP - Advanced Simple Profile)
- **AVI** (MPEG4 layer only, does not support uncompressed AVI, Resolution up to 1080i)
- **XVID** (with MP3 and PCM)
- **WMV9** (Resolution up to 720p)
- **DVR-MS** (Recorded TV files from Microsoft Windows® Media Center Edition)

## Viewing a Video

Once you enter the **VIDEO** menu, you can view your list of videos.

Use the **selection arrows** to navigate to the video folder you wish to view (choose from All Video, Genre, Actor, Folder, or Favorites). Highlight the video folder and press **ENTER**.

After you have selected a video folder, scroll down and highlight the video you wish to view and press **ENTER**. The **Page Up** and **Page Down** buttons can be used to navigate through the picture list one page at a time.





## DivX®

DivX® is a video technology that compresses video. When streaming video to devices like the DSM-510 it is important to use smaller bandwidth files in order to eliminate interrupted video transmission. Using DivX® to compress your videos allows you to save them and send them much more efficiently.

The DSM-510 is a DivX® Home Theater Certified device. Being certified by DivX® guarantees that the DSM-510 can playback DivX® video files.

### Playing a DivX® file

Playing a DivX® file on the D-Link DSM-510 is just like playing any other video file. Once you have placed the video file in your shared directory you will be able to view it by following the instructions listed on Pg. 72.

To create DivX® video files using the DivX® converter you can simply drag your pre-existing video files onto the DivX® converter software, select the video type by click the left or right arrow on the application and then click the convert button.

### Playing DivX® VOD content

In order to play back DivX® Video On Demand content with your DSM-510 you must first install the DivX® player software on your PC and register an account. Once you have installed the DivX® player software (either through the included Autorun CD or from <http://www.divx.com>) you may register an account by doing the following.

- Step 1. Open DivX® Player.
- Step 2. Select Tools > Device Management
- Step 3. If you have not registered for an account you will be prompted to register. Please enter in the required information to create your account.

- Step 4. Login to your DivX® account.
- Step 5. Click the register device button at the bottom.
- Step 6. Select D-Link from the brand list and then click **Next**.
- Step 7. Click the **next** button after entering your DivX® VOD code and a friendly device name.
- Step 8. Your DivX® player will now begin downloading the Activate video file. This needs to be played on your DSM-510 in order to complete the activation process.
- Step 9. Once the download is complete, rename the file from *friendlydevicename.divx* to *friendlydevicename.avi*.
- Step 10. Share this device from your media server and play it on your DSM-510 to finalize activation.

### How to display my DiVX Registration Code

- Step 1. Press the setup key on the remote control.
- Step 2. Select DivX® VOD Reigstration Code from the device menu.
- Step 3. Write down the Registration code provided, and when prompted by the DivX® Player enter the code for your devices activation code.

**Note:** Pressing the **SHIFT** button on your DSM-510 remote control allows you to switch in between different DivX® subtitles. Pressing the **L/R** button on your DSM-510 remote control allows you to switch in between different DivX® audio languages.

## Time Search

You can search to a specific time in a video file by using the Time Search function. While your video is playing, click the **MENU** button on your remote control. Navigate to the Time Search option and press **ENTER** (see the following image). Using your remote control, enter the minutes and seconds you want the player to start from, and click **OK**.

**Note:** *The Time Search function may not be supported outside the Intel® Viiv™ Server.*



## Search Filter

When browsing the menus of music, photos, and videos, you can press the **MENU** button on the remote control and select the filter option. You may also press the **SEARCH** button on your remote control to bring up the filter menu. Select the **Filter** option and press **ENTER** on your remote control.

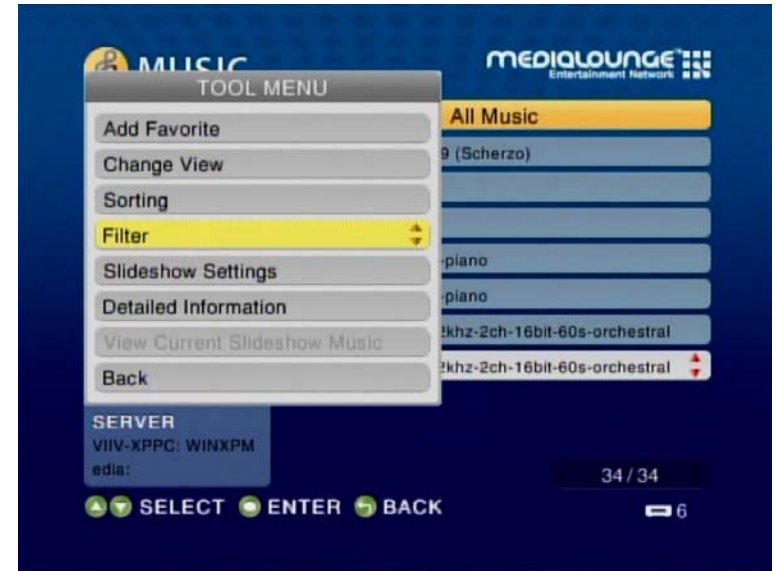

The following screen should reveal the filter menu. You can search your content for titles, albums, artists, and genres. The search filter will only work when accessing your music, photos, and videos through the top level menu. The search filter will not work when accessing your content through the server select screen.

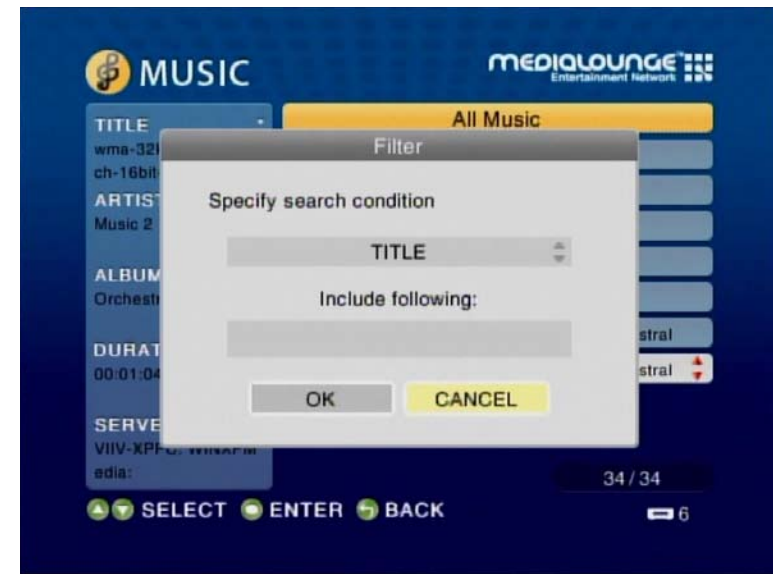

# Intel® Viiv™ Zone

The Intel® Viiv™ Zone is your gateway to a world of online applications and services, and is only made available to Viiv™ PCs only.



Click on a category by using the buttons on the left (see the following image) and browse the available applications and services.



# Server

Use the **selection arrows** and the **ENTER** button to select a media source for your photos, music, and video files.



Once the media server is selected you can browse your files that are being shared on your server.

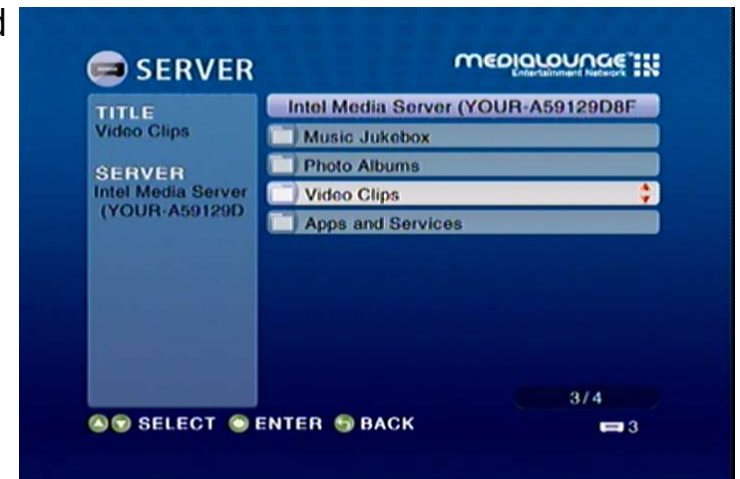

# USB

If there is a USB thumbdrive plugged in to the device, the DSM-510 will display a storage device menu. When you plug in a USB thumbdrive, the USB thumbdrive type will display.



Use the selection arrows and press **ENTER** to select a USB thumbdrive for viewing. Depending on your photo display options, your files will either display in a list or as thumbnails. Press **ENTER** to display the image in a full screen and use the up and down selection arrows to navigate back and forward through your files. You can also select Auto Play in the setup menu and your files will automatically play when a card is inserted.

**Note:** When playing MP3s, you can press the **INFO** button for information on the current track playing.

# Troubleshooting

## **1 What kind of files are supported by the DSM-510?**

Audio - MP3, WMA, WAV, AIFF, OGG

Video - WMV9, MPEG 1, 2, and 4, AVI, XVID, DVR-MS

Images - JPEG, PNG, BMP, GIF, TIFF

## **2. What do I need to set up the D-Link's DSM-510?**

You must have a Microsoft Windows®-based home network in place, with at least one Intel® Viiv™ technology-based PC or a PC running Microsoft Windows® Vista/XP.

## **3. What is required to run the server software?**

Intel® Viiv™ technology-based verified PC is required to run the Intel® Viiv™ media server, or a Windows® Vista/XP PC with Windows® Media Player 11 installed.

## **4. How does the D-Link DSM-510 get its files from my computer?**

The Intel® Viiv™ Media Server software on your PC will launch, allowing you to add media files. You may then select folders that contain music, photos, and videos that you want to play. If you have a PC running Windows® Vista/XP, the Windows® Media Player 11 software that supports the DSM-510 should already be installed on your Windows® PC or you can launch the Windows® Update service to download and install it.



### **5. Why do my WMA files fail to play?**

The following low bit rate WMA files may fail to play:

WMA 9.1 Quality 10 44kHz Stereo VBR

WMA 9.1 Lossless Quality 100 @ 96kHz 2channel 24bit VBR

WMA 9.1 Voice Quality 4kbps 8kHz mono

WMA 9.1 Voice Quality 20kbps 22kHz mono

WMA 9.1 Quality 98 44kHz Stereo

WMA 9.1 Lossless Quality 100 @ 44kHz 2channel 16 bit VBRnetwork.

### **6. What about Copy Protection and DRM support?**

The most common method of copy protection is WM DRM (Digital Rights Management). The DSM-510 can play these types of files from your Intel® Viiv™ technology verified PC or a Windows® PC, running WMP11 or Windows Media Connect.

### **7. Can I use my Universal remote control?**

No, the DSM-510 is not compatible with a universal remote but you can use a remote with learning ability.

### **8. Can I connect the DSM-510 directly to a PC without using a router or a hub?**

Yes, please make note of the following:

**Wireless Users:** Set the Mode to Ad-Hoc in the wireless settings.

**Wired Users:** Connect an Ethernet cable directly from the DSM-510's Ethernet port to the Ethernet port on your PC. The DSM-510's Ethernet port is Auto MDI/MDI-X, so a special Ethernet cable is not required.

**All Users:** If DHCP software isn't running on your computer, you will need to assign a static IP address to the DSM-510 by changing the network settings from automatic to manual.

**Note:** *The Viiv™ Zone and firmware upgrades are not available without an Internet connection.*

### **9. How do I change the bit rate of an audio file?**

There are various audio editing programs available for download on the Internet.

### **10. Why do my AVI files fail to play?**

The DSM-510 will only support MPEG-4 encoded AVI files. You may need to re-encode your AVI files with a video encoding software program, such as Nero Recode.

### **11. I cannot see anything when I turn on my DSM-510 player for the first time.**

- Make sure your TV is displaying the appropriate video source. You may need to use the **AV Input, Source, Select,** or **TV/Video** button on your TV or TV remote to change video sources. If you are having trouble changing the video source, refer to the instructions that came with your TV.
- If you did not connect the player directly to your TV, but are instead passing the signal through your VCR, make sure your VCR is displaying the appropriate video source. You may need to use the **Input** or **Source** button on your VCR or VCR's remote control. Some VCRs only pass the signal through when they are turned off. If you are having trouble displaying the correct video source, refer to the instructions that came with your VCR.
- Make sure cables are connected to the IN jacks on your TV or VCR, not the OUT jacks.
- The cables you are using to connect your receiver to your TV or other equipment may be damaged or defective. Try exchanging the cables connected to the receiver with other cables that you know are working properly.
- Make sure you have firmly attached the power adapter plug to the back of the player. Also, verify the power adapter is plugged into a working power outlet and that the outlet is not controlled by a light switch.

### **12. My remote control isn't working.**

- Make sure the batteries are inserted correctly.
- Try removing the batteries and reinserting them without touching any buttons on the remote control.
- Replace the batteries with new ones.

### **13. The volume and mute buttons on the remote control don't work when playing content that was encoded in 5.1 surround.**

- The volume can only be adjusted on your digital stereo receiver. The DSM-510 can pass-through the audio signal to a

compatible audio receiver for multi-channel decoding.

**14. I can't find any of my music, photos, or video.**

- If using a wired network, verify the Ethernet cable is properly attached to your DSM-510 and to a network switch, hub or router. Verify that the switch, hub or router is powered on.
- If you are using static IP addresses, verify the IP address and netmask are in the same range as other addresses on your network. Verify that the address is not already in use by another PC or device.
- Make sure the files you are sharing use a supported file format and encoding scheme.
- Verify the folder is shared in the Viiv Media Library on your Intel® Viiv™ technology verified PC.

**15. I can't hear any sound when I'm playing music.**

- Make sure the audio cables are properly connected.
- If the audio cables are connected to your TV, the TV must be on to hear any music.
- If the audio cables are connected to your stereo, make sure the stereo is on and you have the correct stereo input source selected. If you are having trouble selecting the correct audio source, refer to the instructions that came with your stereo.

**16. Some of my MP3 and WMA files don't appear.**

- The DSM-510 supports the most common music file formats. However, there are almost an infinite variety of bit rates and sample rates. If a file does not appear on the receiver, it most likely uses an unsupported rate.
- The files may be copy protected. To share your files, turn copy protection off when you rip them.
- The following MP3 sample rates are supported: 4, 8, 16, 22.05, 24, 32, 44.1, 48, 88.2 and 96 kHz.
- For best results, rip your MP3 files at 128 kbps or higher, with a sample rate of 44.1 kHz.

**17. I am not able to play certain media files.**

- The DSM-510 supports most industry standard file formats but even supported file formats can be encoded in ways that are not supported. Try exporting media with different encoding settings or using different software applications to encode your files.

### **18. Checking the bit and sample rates of a music file.**

- To check the bit and sample rates of a music file:

1. Right-click on the file and select **Properties**.
2. Select the **Summary** tab and click the **Advanced** button. Scroll to the bottom of the list.

In most cases, the sample rate does not matter unless you come across a file that will not play or appear on your player. Use the above procedure to check the file settings for supported rates.

### **19. I created a playlist on my computer, but it doesn't appear on my media player.**

- Make sure the playlist file is located in a folder shared by your media player. Copy the playlist to your shared music folder or click on the Media Server icon to add or change your folder options.

### **20. How do I reset my DSM-510?**

- Under normal circumstances, you should not need to reset your media player. However, to fully reset the media player, press the **SETUP** button and select **Reset Settings**.

### **21. What version of firmware do I have?**

- From the main home screen, press the **SETUP** button and select **Device Information**. The firmware version will be listed.

### **22. The DSM-510 will not play my AVI files.**

- Make sure that your AVI files are smaller than 2GB. AVI files have a limitation of 2GB. This is a limitation set in the AVI standard.

### **24. The DSM-510 will not play my WMV files.**

- Make sure that your WMV files are not recorded at a resolution above 1080i. Playback of WMV files will only work if the resolution is 1080i or below.

# Wireless Basics

D-Link wireless products are based on industry standards to provide easy-to-use and compatible high-speed wireless connectivity within your home, business or public access wireless networks. Strictly adhering to the IEEE standard, the D-Link wireless family of products will allow you to securely access the data you want, when and where you want it. You will be able to enjoy the freedom that wireless networking delivers.

A wireless local area network (WLAN) is a computer network that transmits and receives data with radio signals instead of wires. Wireless LANs are used increasingly in both home and office environments, and public areas such as airports, coffee shops and universities. Innovative ways to utilize WLAN technology are helping people to work and communicate more efficiently. Increased mobility and, the absence of cabling and other fixed infrastructures have proven to be beneficial for many users.

Under many circumstances, it may be desirable for mobile network devices to link to a conventional Ethernet LAN in order to use servers, printers or an Internet connection supplied through the wired LAN. A Wireless Router is a device used to provide this link.

## **What is Wireless?**

Wireless or WiFi technology is another way of connecting your computer to the network without using wires. WiFi uses radio frequency to connect wirelessly, so you have the freedom to connect computers anywhere in your home or office network.

## **Why D-Link Wireless?**

D-Link is the worldwide leader and award winning designer, developer, and manufacturer of networking products. D-Link delivers the performance you need at a price you can afford. D-Link has all the products you need to build your network.

## **How does wireless work?**

Wireless works similar to how cordless phones work, through radio signals that transmit data from point A to point B. But wireless technology has restrictions as to how you can access the network. You must be within the wireless network range area to be able to connect your computer. There are two different types of wireless networks Wireless Local Area Network (WLAN), and Wireless Personal Area Network (WPAN).

## **Wireless Local Area Network (WLAN)**

In a wireless local area network, a device called an Access Point (AP) connects computers to the network. The access point has a small antenna attached to it, which allows it to transmit data back and forth over radio signals. With an indoor access point, the signal can travel up to 300 feet. With an outdoor access point the signal can reach out up to 30 miles to serve places like manufacturing plants, industrial locations, college and high school campuses, airports, golf courses, and many other outdoor venues.

## **Who uses wireless?**

Wireless technology has become so popular in recent years that almost everyone is using it, whether it's for home, office, or business,

D-Link has a wireless solution for it.

### **Home**

- Gives everyone at home broadband access
- Surf the web, check email, instant message, and etc
- Gets rid of the cables around the house
- Simple and easy to use

### **Small Office and Home Office**

- Stay on top of everything at home as you would at office
- Remotely access your office network from home
- Share Internet connection and printer with multiple computers
- No need to dedicate office space

### **Where is wireless used?**

Wireless technology is expanding everywhere, not just at home or the office. People like the freedom of mobility and it's becoming so popular that more and more public facilities now provide wireless access to attract people. A wireless connection in a public place is usually called a "hotspot".



Using a D-Link Cardbus Adapter with your laptop, you can access the hotspot to connect to the Internet from remote locations like: Airports, Hotels, Coffee Shops, Libraries, Restaurants, and Convention Centers.

A wireless network is easy to setup, but if you're installing it for the first time it could be quite a task not knowing where to start. That's why we've put together a few setup steps and tips to help you through the process of setting up a wireless network.

## **Tips**

Here are a few things to keep in mind, when you install a wireless network.

### **Centralize your router or Access Point**

Make sure you place the router/access point in a centralized location within your network for the best performance. Try to place the router/access point as high as possible in the room, so the signal gets dispersed throughout your home. If you have a two-story home, you may need a repeater to boost the signal to extend the range.

### **Eliminate Interference**

Place home appliances such as cordless telephones, microwaves, and televisions as far away as possible from the router/access point. This would significantly reduce any interference that the appliances might cause since they operate on the same frequency.

### **Security**

Don't let your next-door neighbors or intruders connect to your wireless network. Secure your wireless network by turning on the WPA or WEP security feature on the router. Refer to the product manual for detailed information on how to set security up.

# Wireless Modes

There are basically two modes of networking:

- **Infrastructure** – All wireless clients will connect to an access point or wireless router.
- **Ad-Hoc** – Directly connecting to another computer, for peer-to-peer communication, using wireless network adapters on each computer, such as two or more WNA-1330 wireless network Cardbus adapters.

An Infrastructure network contains an Access Point or wireless router. All the wireless devices, or clients, will connect to the wireless router or access point.

An Ad-Hoc network contains only clients, such as laptops with wireless cardbus adapters. All the adapters must be in Ad-Hoc mode to communicate.

# Networking Basics

## Check your IP Address

After you install your new D-Link adapter, by default, the TCP/IP settings should be set to obtain an IP address from a DHCP server (i.e. wireless router) automatically. To verify your IP address, please follow the steps below.

Click on **Start > Run**. In the run box type *cmd* and click **OK**.

At the prompt, type *ipconfig* and press **Enter**.

This will display the IP address, subnet mask, and the default gateway of your adapter.

If the address is 0.0.0.0, check your adapter installation, security settings, and the settings on your router. Some firewall software programs may block a DHCP request on newly installed adapters.

If you are connecting to a wireless network at a hotspot (e.g. hotel, coffee shop, airport), please contact an employee or administrator to verify their wireless network settings.

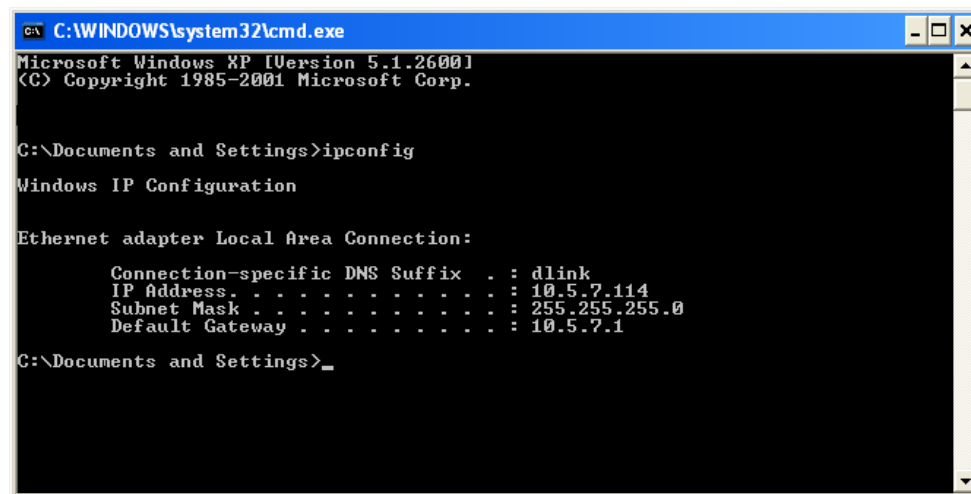

```
C:\WINDOWS\system32\cmd.exe
Microsoft Windows XP [Version 5.1.2600]
(C) Copyright 1985-2001 Microsoft Corp.

C:\Documents and Settings>ipconfig

Windows IP Configuration

Ethernet adapter Local Area Connection:

    Connection-specific DNS Suffix  . : dlink
    IP Address. . . . .               : 10.5.7.114
    Subnet Mask . . . . .             : 255.255.255.0
    Default Gateway . . . . .         : 10.5.7.1

C:\Documents and Settings>_
```

## Statically Assign an IP Address

If you are not using a DHCP capable gateway/router, or you need to assign a static IP address, please follow the steps below:

### Step 1

Windows® XP - Click on **Start > Control Panel > Network Connections**.

Windows® 2000 - From the desktop, right-click **My Network Places > Properties**.

### Step 2

Right-click on the **Local Area Connection** which represents your D-Link network adapter and select **Properties**.

### Step 3

Highlight **Internet Protocol (TCP/IP)** and click **Properties**.

### Step 4

Click **Use the following IP address** and enter an IP address that is on the same subnet as your network or the LAN IP address on your router.

Example: If the router's LAN IP address is 192.168.0.1, make your IP address 192.168.0.X where X is a number between 2 and 99. Make sure that the number you choose is not in use on the network. Set Default Gateway the same as the LAN IP address of your router (192.168.0.1).

Set Primary DNS the same as the LAN IP address of your router (192.168.0.1). The Secondary DNS is not needed or you may enter a DNS server from your ISP.

### Step 5

Click OK twice to save your settings.

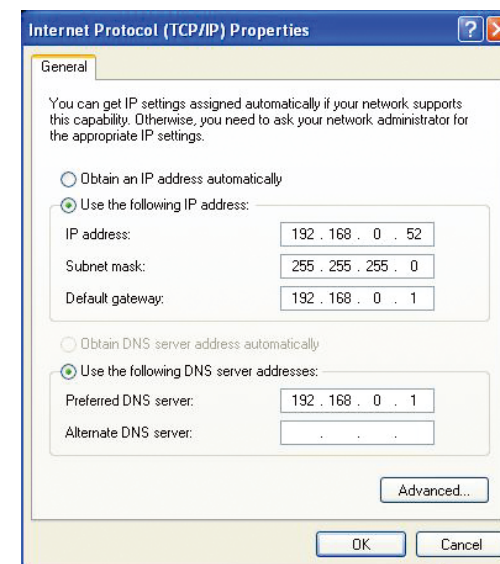

# General Appendix

## How to Check your Media

For WMA/WMV/MP3, you may use “Windows Media ASF Viewer 9 Series” to examine your media files. This tool can be downloaded from: <http://www.microsoft.com/windows/windowsmedia/format/ASFViewer.aspx>

Here is a sample screenshot of the Windows Media ASF Viewer examining a WMV file.

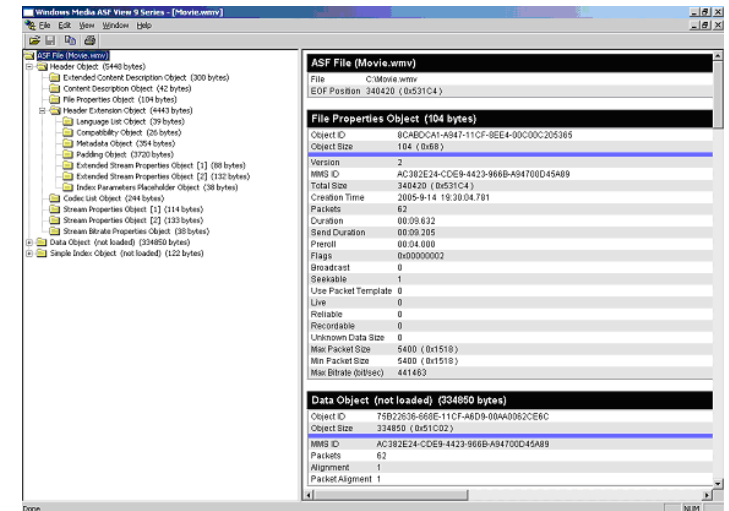

For AVI/WMV/OGG/MPEG/MP3, you may use “AVICodec” to examine your media files. This tool can be downloaded from:

<http://avicodec.duby.info/>

Here is a sample screenshot of AVICodec

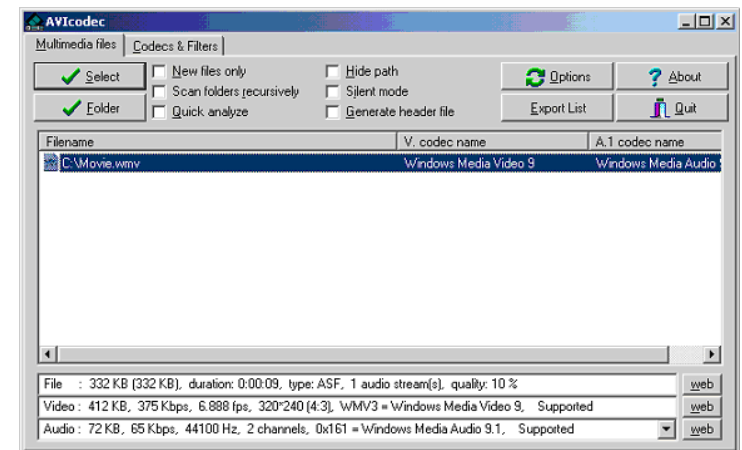

# Convert an Earlier WMV File into WMV9

There are many variations of video files (including WMV files) which may affect playback on the DSM-510. To alleviate this issue, there are software tools available on the web to check the properties of a video file and to convert an earlier WMV file into WMV9. If you have Windows® XP or ME, your Windows comes with a tool from Microsoft called “Movie Maker.” With this tool, you can create and edit video files into Windows Media Video 9 (WMV9) format. Here is an example of converting a WMV8 file into WMV9.

**Step 1:** Verify your WMV file codec using a validation tool. In the “Video” field, it tells you the selected video file is a WMV8 instead of a supported WMV9 by your HD media player. Therefore, we need to convert this file into a WMV9 format in order for you to play it.

This is AVIcodec, which is used to check for an earlier version of a WMV file.

**Step 2:** Open “Windows Movie Maker”. Import the video you wish to convert.

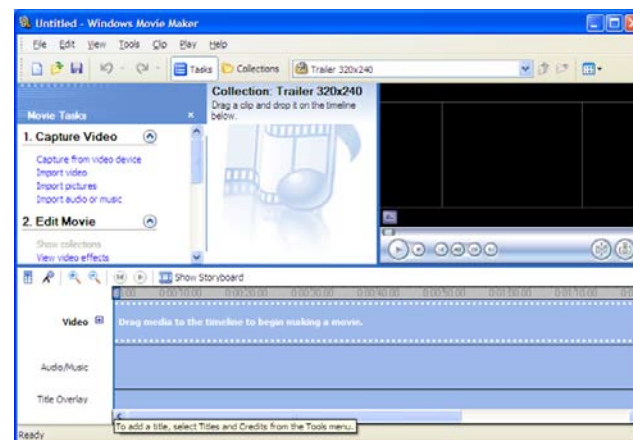
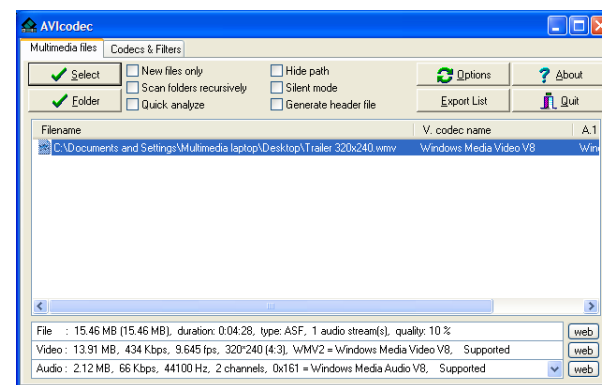

**Step 3:** Select the video file.

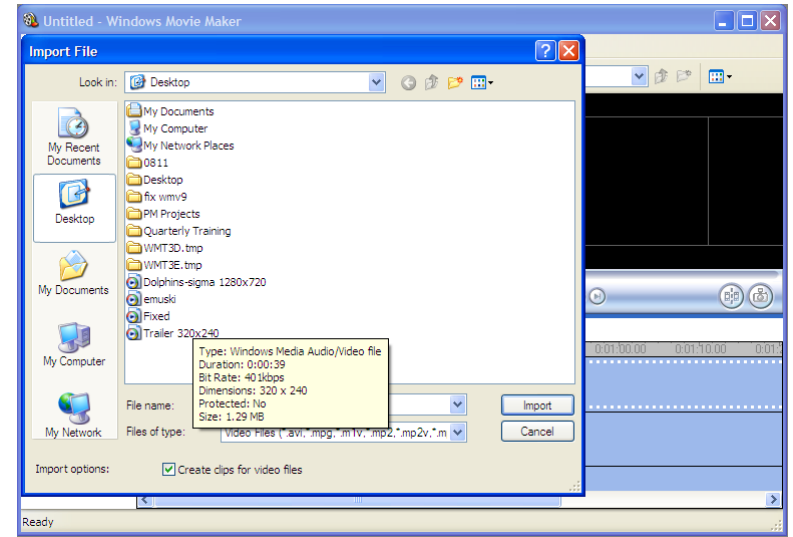

**Step 4:** Movie Maker will start importing the file.

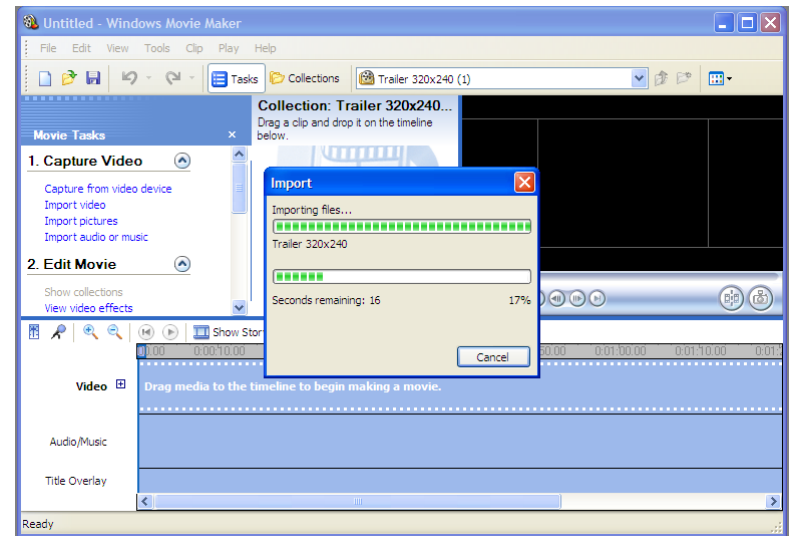

**Step 5:** The video file you selected will show up in display.

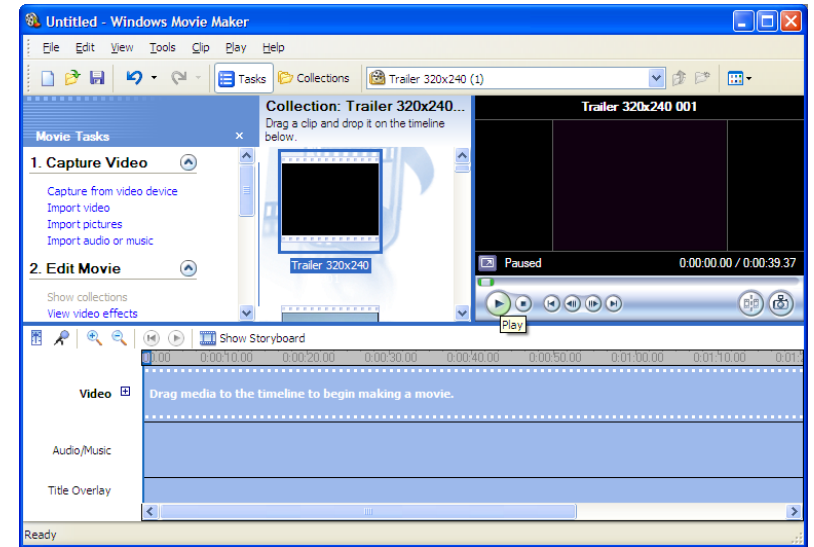

**Step 6:** Drag and drop the video into the bottom panel for editing.

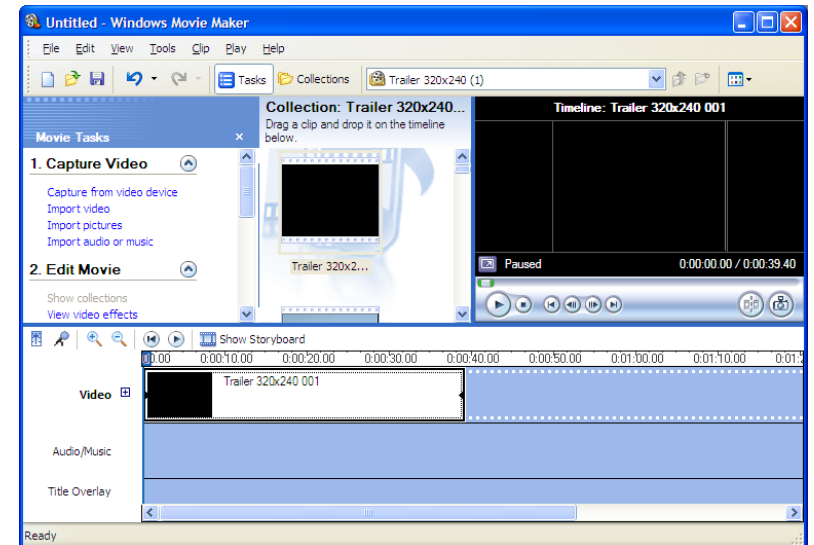



**Step 7:** Select “Save to my computer” on the left panel.

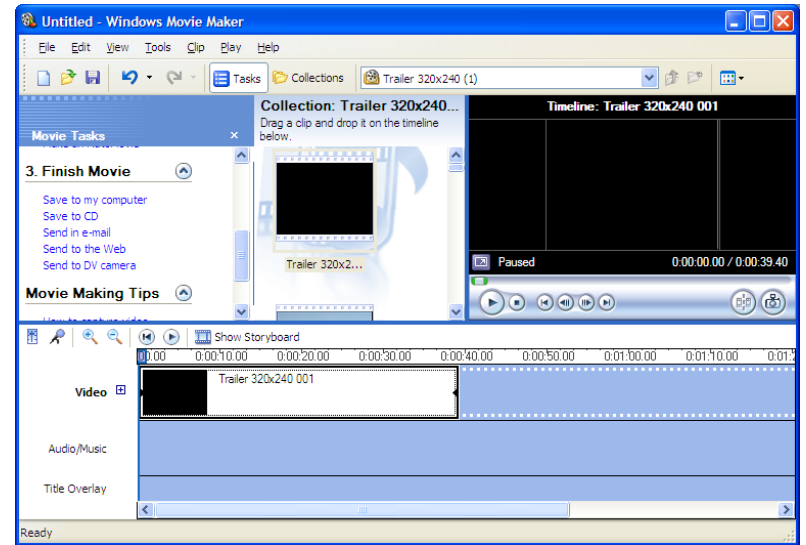

**Step 8:** Give the new file a name and select the desired location to save it.

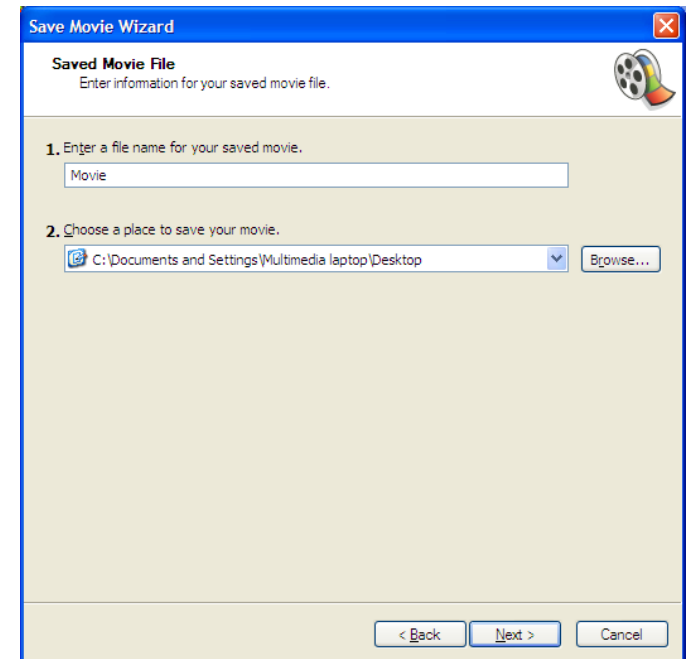

**Step 9:** Select the quality of your new video file.

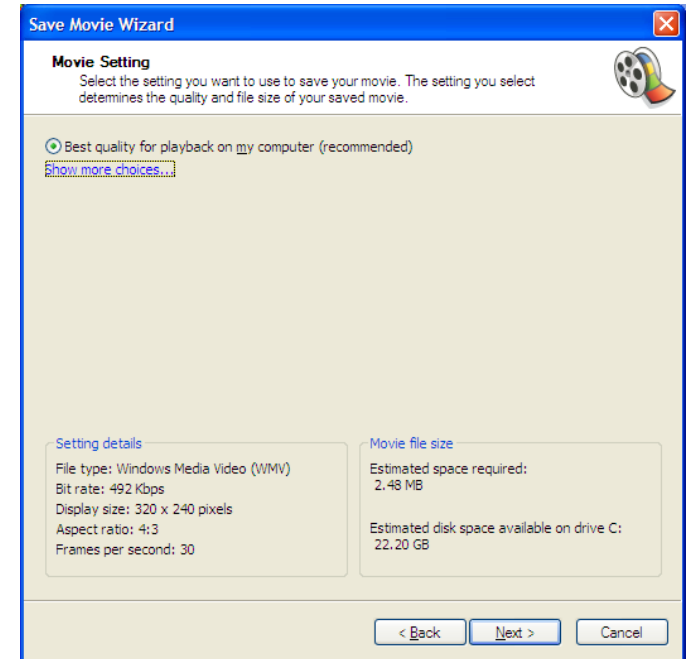

**Step 10:** Once selected, Movie Maker will start creating your new video file.

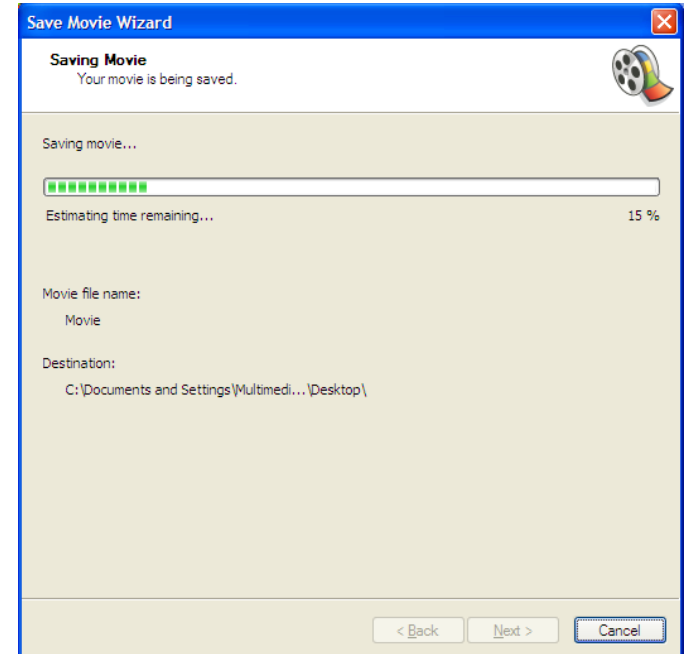

**Step 11:** Once completed, this screen will show up.

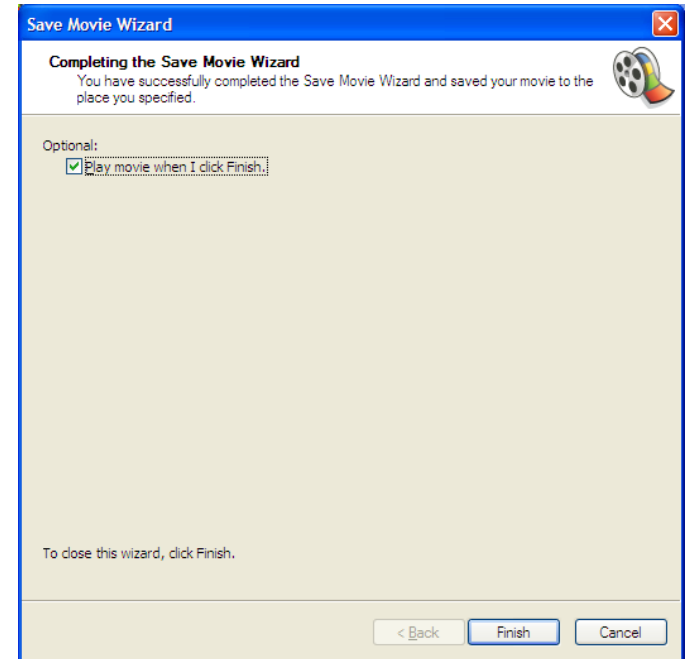

You can verify the new video file is created in WMV9 format. This screenshot shows you both the old file (WMV8) and the new file (WMV9).

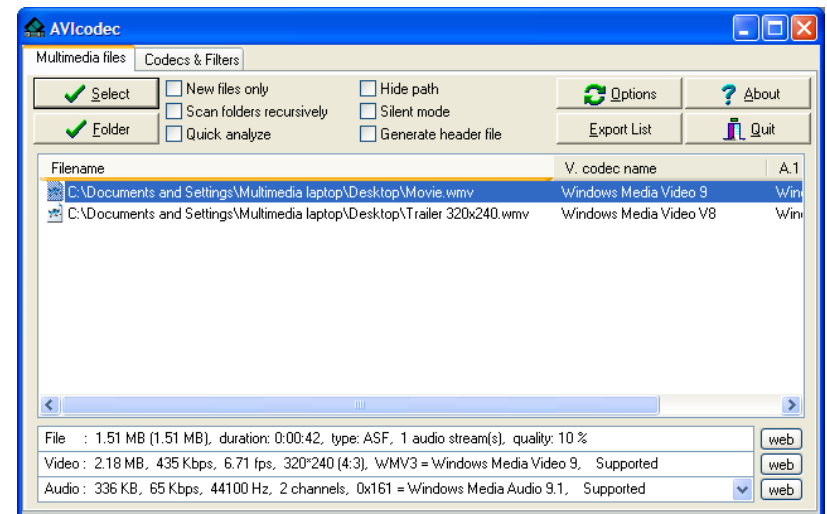

# Remote Control Table

<b>Power</b>	Turn the DSM-510 <b>ON</b> or <b>OFF</b> .
<b>HOME</b>	Returns to the Home menu page
<b>Number Keys</b>	Allows you to enter alphanumeric information
<b>SHIFT</b>	Allows you to use upper and lower case letters and/or numbers for entering characters. Pressing the <b>SHIFT</b> button on your DSM-510 remote control allows you to switch in between different DivX® subtitles.
<b>DELETE</b>	Delete numbers and text.
<b>BACK</b>	Return to the previous page.
<b>SETUP</b>	Access the Setup Menu.
<b>MUTE</b>	Turn OFF the audio.
<b>Page Up/Down</b>	Press Up to scroll up a page, and press Down to scroll down a page.
<b>Arrow keys</b>	Move the onscreen cursor to navigate through the user interface.
<b>ENTER</b>	Selects a single file for playback, and allows the selection of menu options.
<b>Vol +</b>	Increase the volume.
<b>Vol -</b>	Decrease the volume.
<b>MENU</b>	Access the current mode's menu.
<b>MUSIC</b>	Access the Music mode.
<b>PHOTO</b>	Access the Photo mode.
<b>VIDEO</b>	Access the Video mode.
<b>SERVER</b>	Access the Server mode.
<b>USB</b>	Access the USB thumbdrive mode.
<b>Play Functions</b>	While viewing and listening to your media, you can use these keys to <b>Stop</b> , <b>Play/Pause</b> , <b>Rewind</b> , <b>Fast Forward</b> , go back ( <b>Prev</b> ), or go to the next item ( <b>Next</b> ).
<b>REPEAT</b>	Repeat the current Music, Video, Photo Slideshow selection.
<b>SHUFFLE</b>	Randomize the current Music, Video, Photo Slideshow selection.
<b>SEARCH</b>	Search for a specific file or folder.
<b>INFO</b>	Access the information on a music, photo, or video file that is currently playing.
<b>SLOW</b>	Slows down the music or video file that is currently playing.
<b>A-B</b>	Select a start point (A) and an end point (B) of video to replay while viewig a video.
<b>L/R</b>	Changes a mode of a sound that is currently playing from a music or video file. Pressing the <b>L/R</b> button on your DSM-510 remote control allows you to switch in between different DivX® audio languages.

## Free Manuals Download Website

<http://myh66.com>

<http://usermanuals.us>

<http://www.somanuals.com>

<http://www.4manuals.cc>

<http://www.manual-lib.com>

<http://www.404manual.com>

<http://www.luxmanual.com>

<http://aubethermostatmanual.com>

Golf course search by state

<http://golfingnear.com>

Email search by domain

<http://emailbydomain.com>

Auto manuals search

<http://auto.somanuals.com>

TV manuals search

<http://tv.somanuals.com>