



Dell P2016 Monitor User's Guide

Model: P2016
Regulatory model: P2016t/P2016b



-  **NOTE:** A NOTE indicates important information that helps you make better use of your computer.
-  **CAUTION:** A CAUTION indicates potential damage to hardware or loss of data if instructions are not followed.
-  **WARNING:** A WARNING indicates a potential for property damage, personal injury, or death.

Copyright © 2015 Dell Inc. All rights reserved. This product is protected by U.S. and international copyright and intellectual property laws.

Dell™ and the Dell logo are trademarks of Dell Inc. in the United States and/or other jurisdictions. All other marks and names mentioned herein may be trademarks of their respective companies.

Contents



About Your Monitor	5
Package Contents	5
Product Features	6
Identifying Parts and Controls	7
Monitor Specifications	10
Plug-and-Play	18
LCD Monitor Quality and Pixel Policy	18
Setting Up the Monitor	19
Attaching the Stand	19
Connecting Your Monitor	21
Organizing Your Cables	22
Attaching the Cable Cover	22
Removing the Monitor Stand	23
Wall Mounting (Optional)	24
Operating the Monitor	25
Turning on the Monitor	25
Using the Front Panel Controls	25
Using the On-Screen Display (OSD) Menu	27
Using the Tilt, Swivel, and Vertical Extension	40

Troubleshooting	43
Self-Test	43
Built-in Diagnostics	44
Common Problems.	45
Product Specific Problems	47
Universal Serial Bus (USB) Specific Problems	47
Appendix	48
Safety Instructions	48
FCC Notices (U.S. only) and Other Regulatory Information	48
Contacting Dell	48
Setting Up Your Monitor	49
Maintenance Guidelines.	50

About Your Monitor

Package Contents

Your monitor ships with the components shown below. Make sure that you have received all the components and [contact Dell](#) if something is missing.

-  **NOTE:** Some items may be optional and may not ship with your monitor. Some features or media may not be available in certain countries.
-  **NOTE:** To set up with any other stand, please refer to the respective stand setup guide for setup instructions.



Monitor



Stand



Cable cover



Power cable (varies by country)



DisplayPort cable



USB upstream cable (enables the USB ports on the monitor)

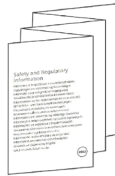

- Drivers and documentation media
- Quick Setup Guide
- Safety and Regulatory Information

Product Features

The **Dell P2016** flat panel display has an active matrix, thin-film transistor (TFT), liquid crystal display (LCD), and LED backlight. The monitor features include:

- 49.40 cm (19.45 inch) active area display (Measured diagonally) 1440 x 900 resolution, plus full-screen support for lower resolutions.
- Tilt, swivel, vertical extension and rotate adjustment capabilities.
- Removable pedestal and Video Electronics Standards Association (VESA™) 100 mm mounting holes for flexible mounting solutions.
- Plug and play capability if supported by your system.
- On-Screen Display (OSD) adjustments for ease of set-up and screen optimization.
- Software and documentation media includes an information file (INF), Image color Matching File (ICM), Dell Display Manager software application and product documentation. Dell Display Manager included (comes in the CD attached with the monitor).
- Security lock slot.
- Stand lock.
- Asset Management Capability.
- Energy Star Compliant.
- EPEAT Gold Compliant.
- RoHS compliant.
- BFR/PVC-free (excluding external cables).
- Arsenic-Free glass and Mercury Free for Panel only.
- Energy Gauge shows the energy level being consumed by the monitor in real time.
- TCO Certified Displays.
- Analog backlight dimming control for flicker free display.

Identifying Parts and Controls

Front view

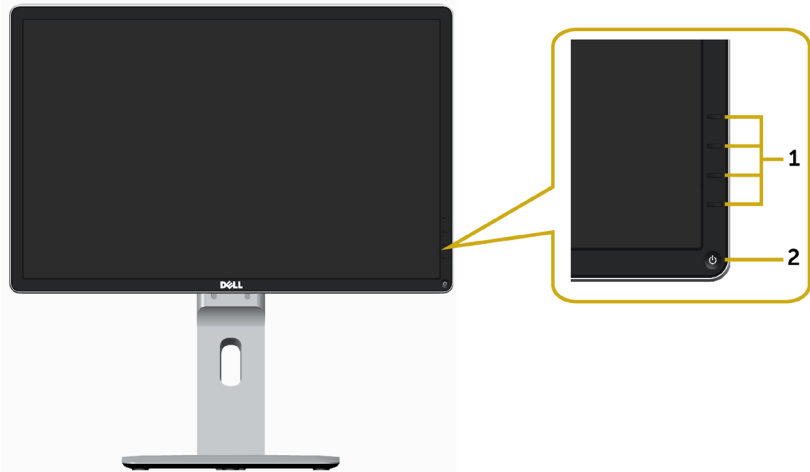

Label	Description
1	Function buttons (For more information, see Operating the Monitor)
2	Power on/off button (with LED indicator)

Back View

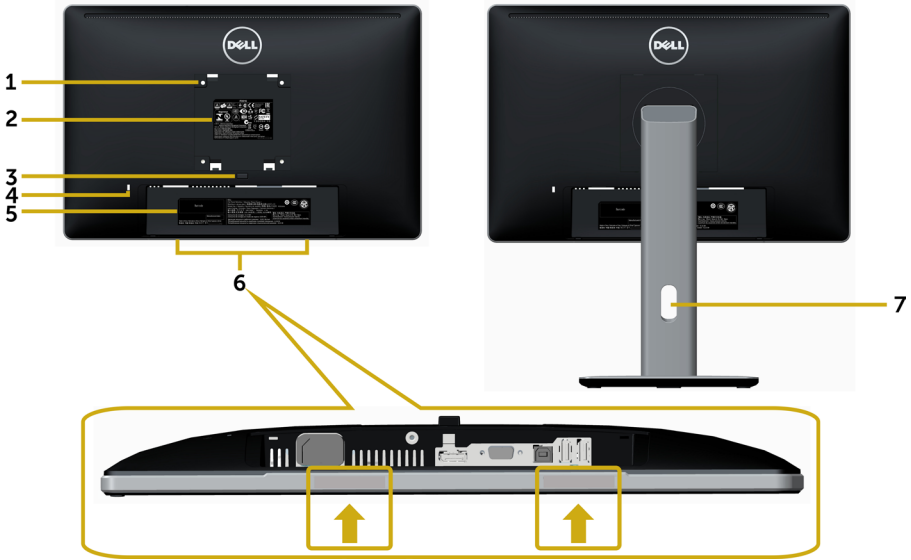

Label	Description	Use
1	VESA mounting holes (100 mm x 100 mm - behind attached VESA cover)	Wall mount monitor using VESA-compatible wall mount kit (100 mm x 100 mm).
2	Regulatory label	Lists the regulatory approvals.
3	Stand-release button	Release stand from monitor.
4	Security-lock slot	Secures monitor with security lock (sold separately).
5	Barcode serial number label	Refer to this label if you need to contact Dell for technical support. NOTE: Service tag printing (EMEA region only).
6	Dell Soundbar mounting slots	Attaches the optional Dell Soundbar. NOTE: Please remove the plastic strip covering the mounting slots before affixing the Dell Soundbar.
7	Cable-management slot	Use to organize cables by placing them through the slot.

Bottom View

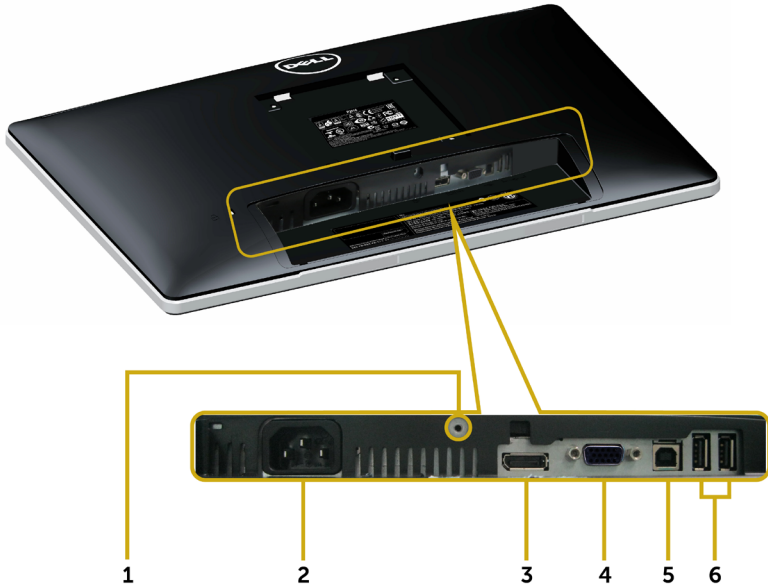

Label	Description	Use
1	Stand lock	Lock the stand to the monitor using a M3 x 6 mm screw (screw not included).
2	AC power connector	To connect the monitor power cable.
3	DP connector	Connect your computer with DP cable.
4	VGA port	Connect your computer with VGA cable (optional).
5	USB upstream port	Connect the USB cable to your computer and the monitor to enable the USB ports on the monitor.
6	USB downstream ports (2)	Connect USB devices. NOTE: You must connect the USB upstream cable to the monitor and your computer to be able to use these ports.

Monitor Specifications

Flat Panel Specifications

Screen type	Active matrix - TFT LCD
Panel type	In-plane switching type
Viewable image:	
Diagonal	49.40 cm (19.45 inches)
Active Area:	
Horizontal	418.61 mm (16.48 inches)
Vertical	262.35 mm (10.33 inches)
Area	109821.81 mm ² (170.22 inch ²)
Pixel pitch	0.2915 mm x 0.2915 mm
Viewing angle:	
Horizontal	178° (typical)
Vertical	178° (typical)
Luminance output	250 cd/m ² (typical)
Contrast ratio	1000:1 (typical)
Dynamic contrast ratio	2,000,000:1
Faceplate coating	AG type, hard-coating 3H
Backlight	LED
Response time	6ms Typ. g-to-g with OD (Fast mode)
Color depth	16.7 million colors
Color gamut (typical)	72%* (CIE1931)

*Color gamut (typical) is based on CIE1976 (85%) and CIE1931 (72%) test standards.

Resolution Specifications

Horizontal scan range	30 kHz to 83 kHz (automatic)
Vertical scan range	56 Hz to 76 Hz (automatic)
Maximum preset resolution	1440 x 900 at 60 Hz
Video display capabilities (DP playback)	480i, 576i, 480p, 576p, 720p,

Preset Display Modes

Display Mode	Horizontal Frequency (kHz)	Vertical Frequency (Hz)	Pixel Clock (MHz)	Sync Polarity (Horizontal/Vertical)
720 x 400	31.47	70	28.32	-/+
640 x 480	31.47	60	25.18	-/-
640 x 480	37.50	75	31.50	-/-
800 x 600	37.88	60	40	+/+
800 x 600	46.88	75	49.50	+/+
1024 x 768	48.36	60	65	-/-
1024 x 768	60.02	75	78.75	+/+
1152 x 864	67.50	75	108	+/+
1280 x 1024	64	60	108	+/+
1280 x 1024	80	75	135	+/+
1280 x 800	49.70	60	83.50	-/+
1440 x 900	55.94	60	106.50	-/+
1440 x 900	70.60	75	136.75	-/+

Electrical Specifications

Video input signals	<ul style="list-style-type: none">• Analog RGB, 0.7 Volts +/-5%, positive polarity at 75 ohm input impedance• DP 1.2 signal input support
Synchronization input signals	Separate horizontal and vertical synchronization, polarity-free TTL level, SOG (Composite SYNC on green)
AC input voltage/frequency/current	100 VAC to 240 VAC/ 50 Hz or 60 Hz + 3 Hz/1.5 A (Max.)
Inrush current	120 V:30 A (Max.) 240 V:60 A (Max.)

Physical Characteristics

Connector type	<ul style="list-style-type: none">• 15-pin D-subminiature (black connector).• DP, black connector.
Signal cable type	<ul style="list-style-type: none">• Digital: DisplayPort, 20 pins.• Analog: Detachable, D-Sub, 15 pins (Not included).
Dimensions (with stand):	
Height (extended)	481 mm (18.94 inches)
Height (compressed)	351 mm (13.82 inches)
Width	455.20 mm (17.92 inches)
Depth	180 mm (7.09 inches)
Dimensions (without stand):	
Height	299 mm (11.77 inches)
Width	455.20 mm (17.92 inches)
Depth	46.50 mm (1.83 inches)
Stand dimensions:	
Height (extended)	399.80 mm (15.74 inches)
Height (compressed)	354.20 mm (13.94 inches)
Width	225 mm (8.86 inches)
Depth	180 mm (7.09 inches)
Weight:	
With packaging	6.08 kg (13.38 lb)
With stand assembly and cables	4.42 kg (9.72 lb)
Without stand assembly (for wall mount or VESA mount considerations - no cables)	2.34 kg (5.15 lb)
Stand assembly	1.78 kg (3.92 lb)

Environmental Characteristics

Temperature:	
Operating	0°C to 40°C (32°F to 104°F)
Non-operating	-20°C to 60°C (-4°F to 140°F)
Humidity:	
Operating	10% to 80% (non-condensing)
Non-operating	5% to 90% (non-condensing)
Altitude:	
Operating	5,000 m (16,404 ft) (maximum)
Non-operating	12,192 m (40,000 ft) (maximum)
Thermal dissipation	<ul style="list-style-type: none"> • 102.36 BTU/hour (maximum) • 54.59 BTU/hour (typical)

Power Management Modes

If you have VESA's DPM-compliant video card or software installed in your PC, the monitor can automatically reduce its power consumption when not in use. This is referred to as power save mode*. If the computer detects input from the keyboard, mouse, or other input devices, the monitor automatically resumes functioning. The following table shows the power consumption and signaling of this automatic power saving feature.

VESA Modes	Horizontal Sync	Vertical Sync	Video	Power Indicator	Power Consumption
Normal operation	Active	Active	Active	White	30 W (maximum)** 16 W (typical)
Active-off mode	Inactive	Inactive	Off	Breathing White (blinking slowly)	Less than 0.3 W
Switch off	-	-	-	Off	Less than 0.3 W

The OSD operates only in the normal operation mode. If you press any button in the active-off mode, the following message is displayed:

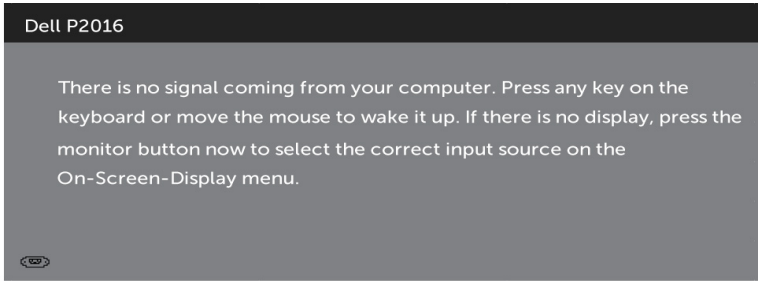

*Zero power consumption in OFF mode can only be achieved by disconnecting the power adapter from the monitor.

**Maximum power consumption with maximum luminance.

Activate the computer and the monitor to gain access to the OSD.



NOTE: This monitor is **ENERGY STAR** -compliant.



Pin Assignments

VGA port

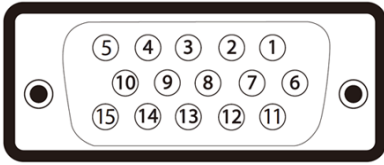

Pin number	15-pin side of the connected signal cable
1	Video-Red
2	Video-Green
3	Video-Blue
4	GND
5	Self-test
6	GND-R
7	GND-G
8	GND-B
9	Computer 5 V / 3.3 V
10	GND-sync
11	GND
12	DDC data
13	H-sync
14	V-sync
15	DDC clock

Displayport port

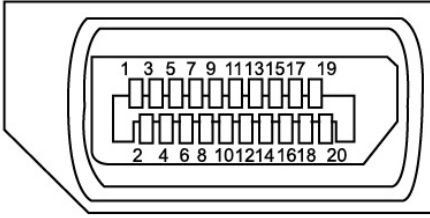

Pin number	20-pin side of the connected signal cable
1	ML_Lane 3 (n)
2	GND
3	ML_Lane 3 (p)
4	ML_Lane 2 (n)
5	GND
6	ML_Lane 2 (p)
7	ML_Lane 1 (n)
8	GND
9	ML_Lane 1 (p)
10	ML_Lane 0 (n)
11	GND
12	ML_Lane 0 (p)
13	CONFIG1
14	CONFIG2
15	AUX CH (p)
16	GND
17	AUX CH (n)
18	Hot Plug Detect
19	Return
20	DP PWR

Universal Serial Bus (USB)

This section gives you information about the USB ports available on your monitor. Your computer has the following USB ports:

- One USB upstream port
- Two USB downstream ports



NOTE: This monitor supports High-Speed Certified USB 2.0 interface.

Transfer speed	Data Rate	Power Consumption
Hi-Speed	480 Mbps	2.5 W each port (maximum)
Full speed	12 Mbps	2.5 W each port (maximum)
Low speed	1.5 Mbps	2.5 W each port (maximum)

USB Upstream port

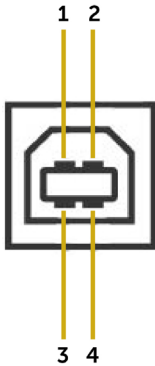

USB Downstream port

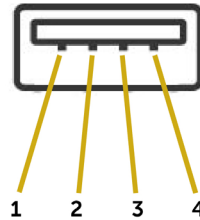

Pin Number	Signal name
1	DMU
2	VCC
3	DPU
4	GND

Pin Number	Signal name
1	VCC
2	DMD
3	DPD
4	GND



NOTE: USB 2.0 functionality requires a USB 2.0-capable computer.



NOTE: The monitor's USB ports work only when the monitor is on or in the power save mode. If you turn off the monitor and then turn it on, the attached peripherals may take a few seconds to resume normal functionality.

Plug-and-Play

You can install the monitor in any Plug-and-Play-compatible system. The monitor automatically provides the computer system with its extended display identification data (EDID) using display data channel (DDC) protocols so the computer can configure itself and optimize the monitor settings. Most monitor installations are automatic; you can select different settings if desired. For more information about changing the monitor settings, see [Operating the Monitor](#).

LCD Monitor Quality and Pixel Policy

During the LCD monitor manufacturing process, it is not uncommon for one or more pixels to become fixed in an unchanging state which are hard to see and do not affect the display quality or usability. For more information on LCD Monitor Pixel Policy, see Dell support site at: <http://www.dell.com/support/monitors>.

Setting Up the Monitor

Attaching the Stand



NOTE: The stand is detached from monitor when it is shipped from the factory.

NOTE: The procedure below is applicable for the default stand. If you purchased any other stand, see the documentation shipped with the stand to set it up.



CAUTION: Do not remove the monitor from the packaging box before attaching the stand.

Attach the stand assembly to the monitor.

- 1 Follow the instructions on the flaps of carton to remove the stand from the top cushion that secures it.
- 2 Lift the cover, as shown, to expose the VESA area for stand assembly.
- 3 Insert the two tabs on the upper part of the stand in the slots on the back of the monitor.
- 4 Press the stand down till it snaps into its place.

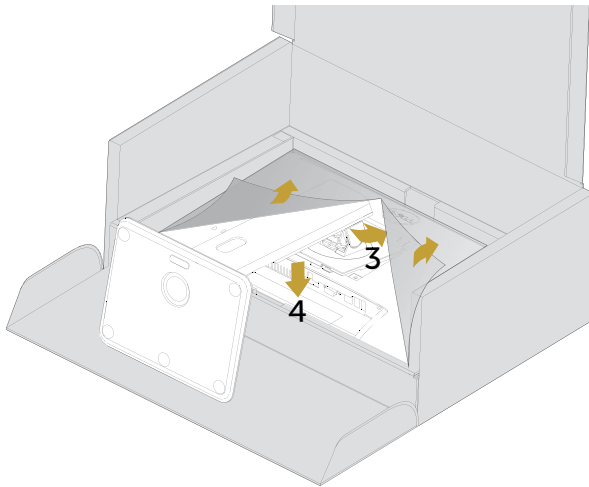

Place the monitor upright.

- 1 Slide one hand in the cutout area on the bottom cushion and use the other hand to hold the stand.
- 2 Lift the monitor carefully to prevent it from slipping or falling.
- 3 Remove the cover from the monitor.



CAUTION: Do not press on the panel screen when lifting the monitor.

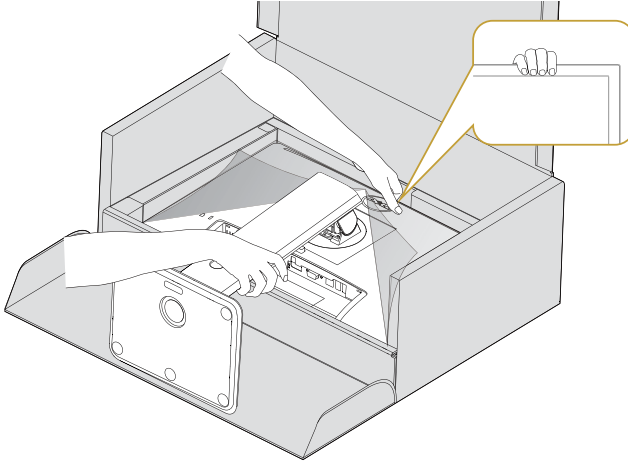

Connecting Your Monitor

⚠ WARNING: Before you begin any of the procedures in this section, follow the [Safety Instructions](#).

To connect your monitor to the computer:

- 1 Turn off your computer.
- 2 Connect the DisplayPort/VGA/USB cable from your monitor to the computer.
- 3 Switch on your monitor.

Connecting the DisplayPort cable

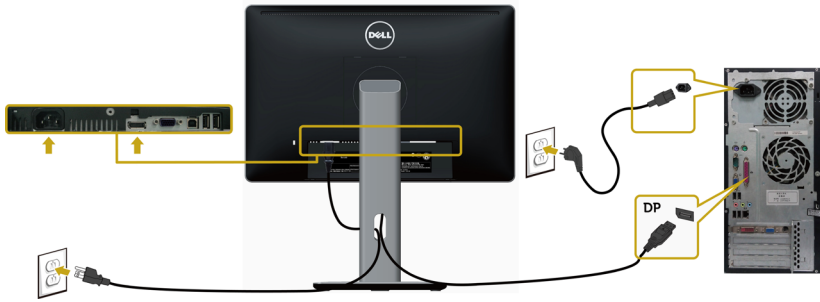

Connecting the VGA cable (optional)

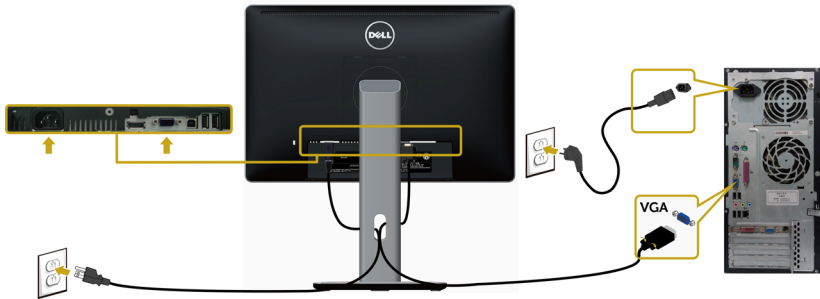

Connecting the USB cable

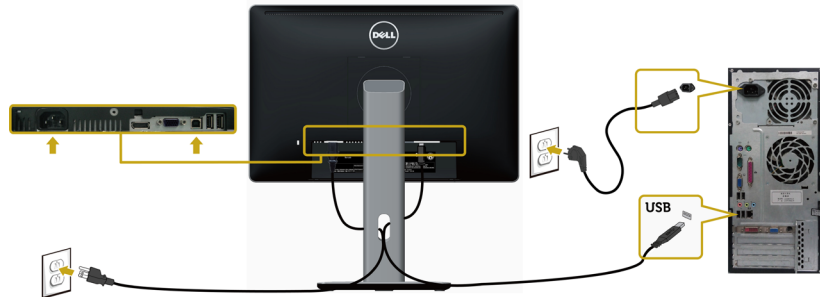

Organizing Your Cables



After attaching all necessary cables to your monitor and computer, (see [Connecting Your Monitor](#) for cable attachment) organize all cables as shown above.

Attaching the Cable Cover

 **NOTE:** The cable cover is detached when the monitor is shipped from the factory.

- 1 Insert the two tabs on the bottom part of the cable cover in the slots on the back of the monitor.
- 2 Press the cable cover till it snaps into place.



Removing the Monitor Stand



CAUTION: To prevent scratches on the LCD screen while removing the stand, make sure that the monitor is placed on a soft, clean surface.



NOTE: The procedure below is applicable for the default stand. If you purchased any other stand, see the documentation shipped with the stand to set it up.

To remove the stand:

- 1 Place the monitor on a soft cloth or cushion.
- 2 Press and hold the stand-release button.
- 3 Lift the stand up and away from the monitor.



Wall Mounting (Optional)



 **NOTE:** Use M4 x 10 mm screws to connect the monitor to the wall-mounting kit.

Refer to the instructions that come with the VESA-compatible wall mounting kit.

- 1 Place the monitor on a soft cloth or cushion on a stable, flat table.
- 2 Remove the stand.
- 3 Use a Phillips crosshead screwdriver to remove the four screws securing the plastic cover.
- 4 Attach the mounting bracket from the wall mounting kit to the monitor.
- 5 Mount the monitor on the wall by following the instructions that comes with the wall mounting kit.

 **NOTE:** For use only with UL or CSA or GS-listed wall mount bracket with minimum weight/load bearing capacity of 2.34 kg (5.15 lb).

Operating the Monitor

Turning on the Monitor

Press the  button to turn on the monitor.





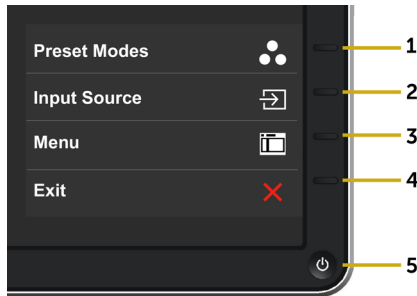

Using the Front Panel Controls

Use the control buttons on the front of the monitor to adjust the characteristics of the image being displayed. As you use these buttons to adjust the controls, an OSD shows the numeric values of the characteristics as they change.







The following table describes the front panel buttons:

Front-Panel Button	Description
<p>1</p>  <p>Shortcut key: Preset Modes</p>	Use this button to choose from a list of preset color modes.
<p>2</p>  <p>Shortcut key : Input Source</p>	Use this button to directly access the "Input Source" menu.
<p>3</p>  <p>Menu</p>	Use this menu button to launch the on-screen display (OSD) and select the OSD menu. See Accessing the Menu System .
<p>4</p>  <p>Exit</p>	Use this button to go back to the main menu or exit the OSD main menu.
<p>5</p>  <p>Power (with power light indicator)</p>	Use the Power button to turn the monitor on and off. The White LED indicates the monitor is on and fully functional. A blinking white LED indicates DPMS power save mode.

Front-Panel Button

Use the buttons on the front of the monitor to adjust the image settings.

Front Panel Button	Description
 <p>1</p>  <p>Up</p>  <p>Down</p>	Use the Up (increase) and Down (decrease) keys to adjust items in the OSD menu.
<p>2</p>  <p>OK</p>	Use the OK button to confirm your selection.
<p>3</p>  <p>Back</p>	Use the Back button to go back to the previous menu.









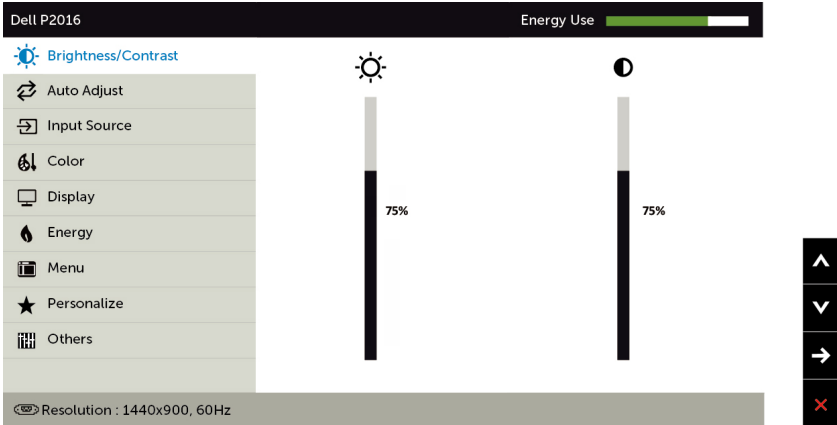

Using the On-Screen Display (OSD) Menu

Accessing the Menu System



 **NOTE:** Any changes you make using the OSD menu are automatically saved if you move to another OSD menu, exit the OSD menu, or wait for the OSD menu to disappear.



- 1 Press the  button to launch the OSD menu and display the main menu.

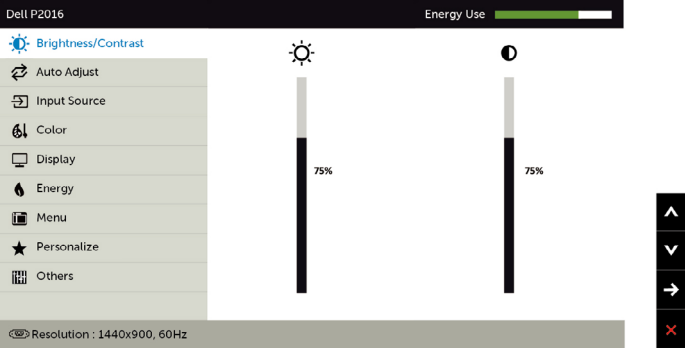

- 2 Press the  and  buttons to move between options. As you move from one icon to another, the option name is highlighted.
- 3 Press the  or  button once to activate the highlighted option.
- 4 Press the  and  buttons to select the desired parameter.
- 5 Press  to enter the slide bar and then use the  or  button, according to the indicators on the menu, to make your changes.
- 6 Press the  button once to return to the main menu to select another option or press the  button two or three times to exit from the OSD menu.

Icon	Menu and Submenus	Description
	Brightness/Contrast	Use this menu to activate Brightness/Contrast adjustment.
		

Brightness **Brightness** adjusts the luminance of the backlight (minimum 0; maximum 100).
 Press the  button to increase brightness.
 Press the  button to decrease brightness.
NOTE: Manual adjustment of **Brightness** is disabled when **Dynamic Contrast** is switched on.

Contrast Adjust the **Brightness** first, and then adjust **Contrast** only if further adjustment is necessary.
 Press the  button to increase contrast and press the  button to decrease contrast (between 0 and 100).
 Contrast adjusts the difference between darkness and lightness on the monitor.

Icon	Menu and Submenus	Description
------	-------------------	-------------



Auto Adjust

Even though your computer recognizes your monitor on startup, the **Auto Adjustment** function optimizes the display settings for use with your particular setup.

Auto Adjustment allows the monitor to self-adjust to the incoming video signal. After using **Auto Adjustment**, you can further tune your monitor by using the **Pixel Clock** (Coarse) and **Phase** (Fine) controls under **Display** menu.

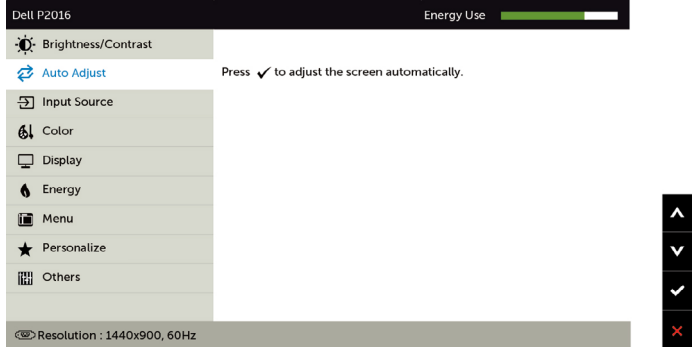

The following dialog appears on a black screen as the monitor automatically adjusts to the current input:



NOTE: In most cases, **Auto Adjust** produces the best image for your configuration.

NOTE: **Auto Adjust** feature option is only available when your monitor is connected using the VGA cable.

Icon	Menu and Submenus	Description
	Input Source	Use the Input Source menu to select between different video inputs that are be connected to your monitor.

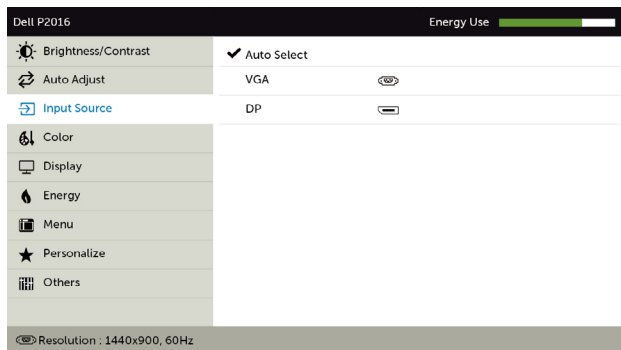

Auto Select Use  to select **Auto Select**, the monitor scans for available input sources.

VGA Select the **VGA** input when you are using the analog (VGA) connector.
Use  to select the VGA input source.

DP Select **DP** input when you are using the DP connector.
Use  to select the DP input source.

Icon

Menu and Submenus

Description



Color

Use the **Color** menu to adjust the color setting mode.

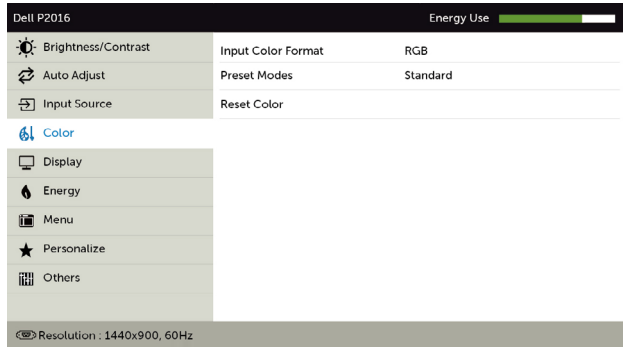





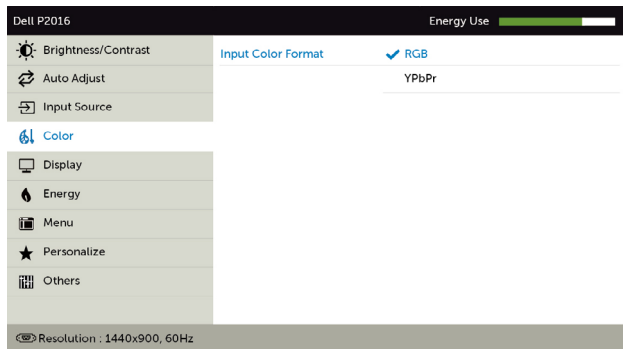

Input Color Format

Allows you to set the video input mode to:

RGB: Select this option if your monitor is connected to a computer (or DVD player) using the VGA cable.

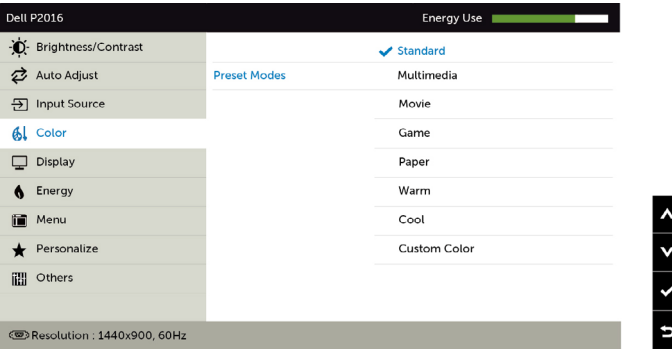
YPbPr: Select this option if your DVD player supports only YPbPr output.





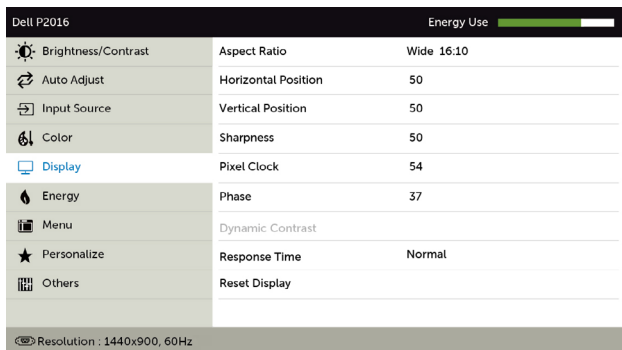

Icon	Menu and Submenus	Description
	Preset Mode	<p>When you select Preset Modes, you can choose Standard, Multimedia, Movie, Game, Paper, Warm, Cool, or Custom Color from the list.</p> <ul style="list-style-type: none"> • Standard: Default color settings. This is the default preset mode. • Multimedia: Ideal for multimedia applications. • Movie: Ideal for movies. • Game: Ideal for most gaming applications. • Paper: Loads brightness and sharpness settings ideal for viewing text. Blend the text background to simulate paper media without affecting color images. • Warm: Increases the color temperature. The screen appears warmer with a red/yellow tint. • Cool: Decreases the color temperature. The screen appears cooler with a blue tint. • Custom Color: Allows you to manually adjust the color settings. <p>Press the  and  buttons to adjust the Red, Green, and Blue values and create your own preset color mode.</p> 
	Hue	<p>Use  or  to adjust the hue from 0 to 100.</p> <p>NOTE: Hue adjustment is available only for Movie and Game mode.</p>
	Saturation	<p>This feature adjusts the color saturation of the video image.</p> <p>Use  or  to adjust the saturation from 0 to 100.</p> <p>NOTE: Saturation adjustment is available only for Movie and Game mode.</p>
	Reset Color	Resets your monitor's color settings to the factory defaults.

Icon	Menu and Submenus	Description
	Display	Use the Display menu to adjust image.







Aspect Ratio Adjust the image ratio to **Wide 16:10**, **4:3**, or **5:4**.

Horizontal Position Use  or  to adjust the image left or right. Minimum is '0' (-). Maximum is '100' (+).

Vertical Position Use  or  to adjust the image up or down. Minimum is '0' (-). Maximum is '100' (+).

NOTE: Horizontal Position and **Vertical Position** adjustments are only available for "VGA" input.

Sharpness Makes the image look sharper or softer. Use  or  to adjust the sharpness from '0' to '100'.

Pixel Clock The **Phase** and **Pixel Clock** adjustments allow you to adjust your monitor to your preference. Use the  or  buttons to adjust for best image quality.

Phase If satisfactory results are not obtained using the **Phase** adjustment, use the **Pixel Clock** (coarse) adjustment and then use **Phase** (fine) again. **NOTE: Pixel Clock** and **Phase** adjustments are only available when your monitor is connected using the VGA cable.

Dynamic Contrast Allows you to increase the level of contrast to provide sharper and more detailed image quality. Push the  button to select the **Dynamic Contrast** "On" or "Off".

NOTE: Dynamic Contrast provides higher contrast if you select **Game** or **Movie** preset mode.

Response Time Allows you to set the **Response Time** to **Normal** or **Fast**.



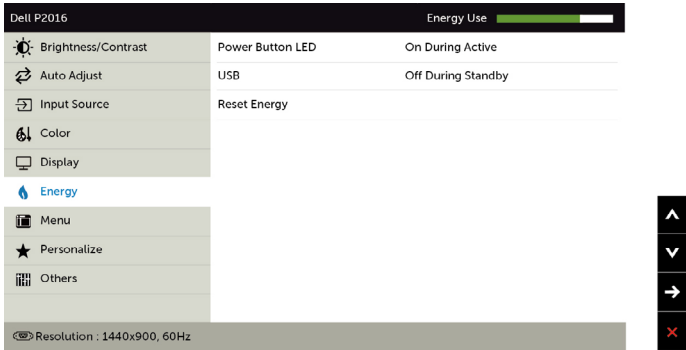

Reset Display Restores the display settings to factory defaults.

Icon	Menu and Submenus	Description
	Energy	

Power Button LED Allows you to set the state of the power light to save energy.

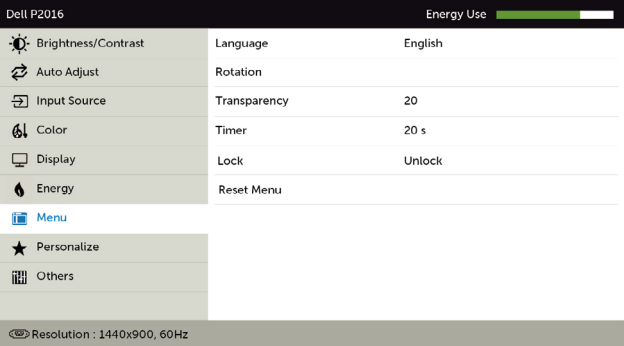
USB	System		
Monitor status	On	Standby	Off
Monitor with upstream connected	On	On	Off
Monitor without upstream connected	On	Off/On (depends on OSD selections)	Off

Reset Energy Select this option to restore default **Energy** settings.

Icon	Menu and Submenus	Description
	Menu	<p>Select this option to adjust the settings of the OSD, such as, the languages of the OSD, the amount of time the menu remains on screen, and so on.</p> 
	Language	<p>Set the OSD display to one of eight languages. (English, Spanish, French, German, Brazilian Portuguese, Russian, Simplified Chinese, or Japanese).</p>
	Rotation	<p>Rotates the OSD by 90 degrees counter-clockwise. You can adjust the menu according to your display rotation.</p>
	Transparency	<p>Select this option to change the menu transparency by using  and  (min. 0 / max. 100).</p>
	Timer	<p>OSD Hold Time: Sets the length of time the OSD remains active after you press a button. Use the  and  buttons to adjust the slider in 1-second increments, from 5 to 60 seconds.</p>
	Lock	<p>Controls user access to adjustments. When Lock is selected, no user adjustments are allowed. All buttons are locked.</p> <p>NOTE:</p> <p>Lock function – Either soft lock (through OSD menu) or hard lock (Press and hold the button above power button for 6 sec)</p> <p>Unlock function – Only hard unlock (Press and hold the button above power button for 6 sec)</p>
	Reset Menu	<p>Restore the menu settings to factory defaults.</p>

Icon	Menu and Submenus	Description
------	-------------------	-------------

	Personalize	Select from Preset Modes, Brightness/Contrast, Auto Adjust, Input Source, Aspect Ratio and Rotation set as shortcut key.
--	--------------------	--

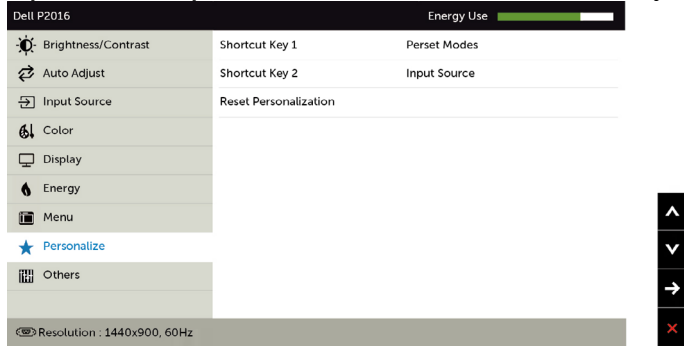

Reset Personalization	Restores shortcut keys to factory defaults.
------------------------------	---

	Other
--	--------------

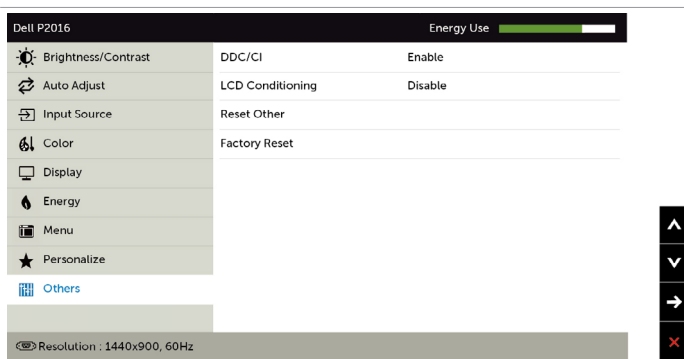

Select this option to adjust the OSD settings, such as the **DDC/CI, LCD conditioning**, and so on.

Icon	Menu and Submenus	Description
	DDC/CI	<p>DDC/CI (Display Data Channel/Command Interface) allows you to adjust the monitor settings using software on your computer.</p> <p>Select Disable to turn off this feature.</p> <p>Enable this feature for best user experience and optimum performance of your monitor.</p>

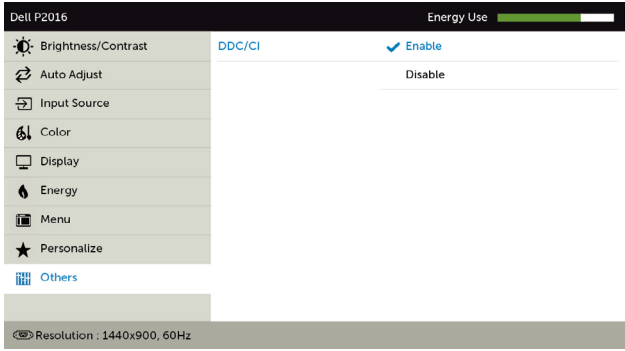

LCD Conditioning	<p>Helps reduce minor cases of image retention. Depending on the degree of image retention, the program may take some time to run. Select Enable to start the process.</p>
-------------------------	---

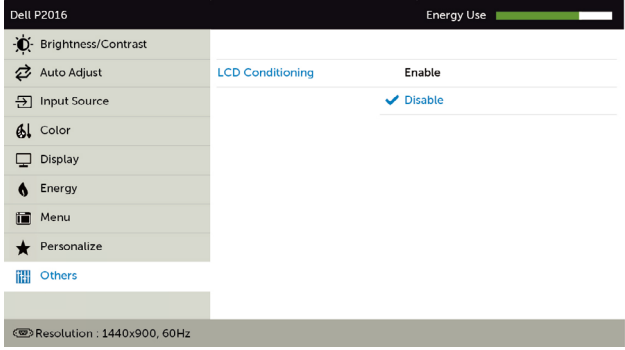

Reset Other	Restores other settings, such as DDC/CI to factory defaults.
Factory Reset	Restores all OSD settings to the factory defaults.

OSD Warning Messages

When the **Dynamic Contrast** feature is enabled (in these preset modes: **Game** or **Movie**), manual brightness adjustment is disabled.

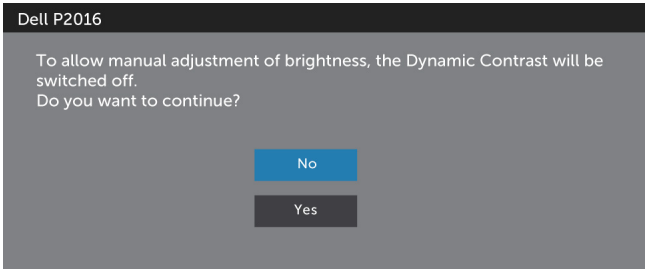

When the monitor does not support a particular resolution mode, you can see the following message:

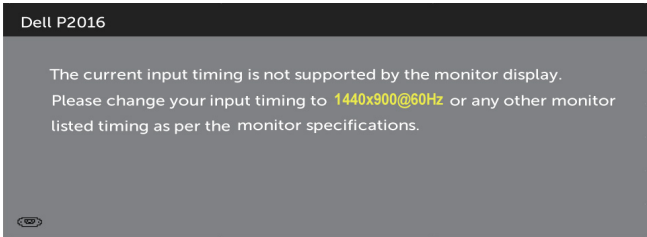

This means that the monitor cannot synchronize with the signal that it is receiving from the computer. See [Monitor Specifications](#) for the Horizontal and Vertical frequency ranges addressable by this monitor. Recommended mode is 1440 x 900.

You can see the following message before the DDC/CI function is disabled:

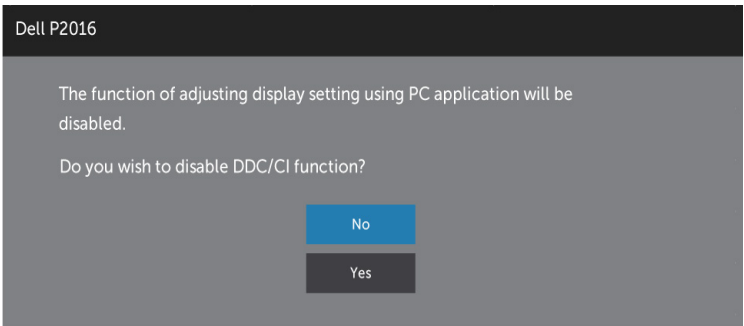

When the monitor enters the **Power Save** mode, the following message appears:

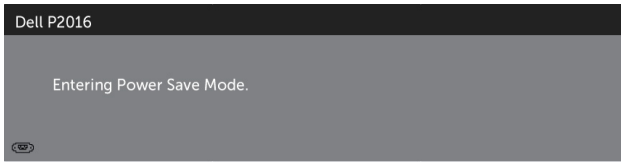

Activate the computer and wake up the monitor to gain access to the [OSD](#).

If you press any button other than the power button, one of the following messages will appear depending on the selected input:

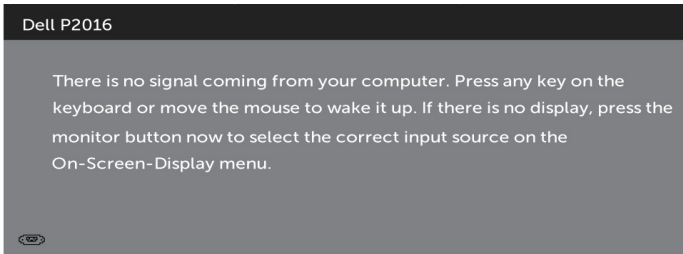

If either VGA or DP input is selected and the corresponding cable is not connected, a floating dialog box as shown below appears.

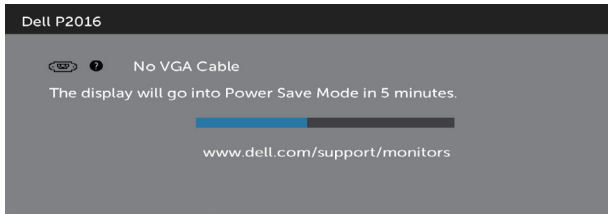

or

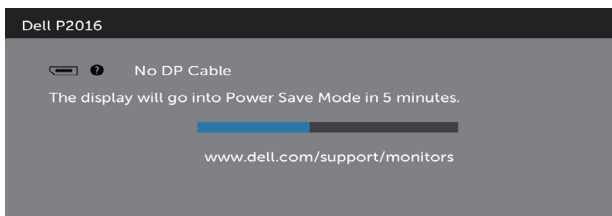

See [Troubleshooting](#) for more information.

Using the Tilt, Swivel, and Vertical Extension

NOTE: This is applicable for a monitor with a stand. If you purchased any other stand, refer to the respective stand setup guide for set up instructions.

Tilt, Swivel

With the built-in pedestal, you can tilt the monitor for the most comfortable viewing angle.

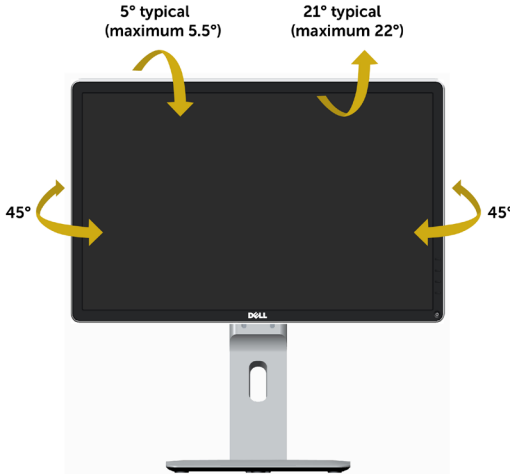

NOTE: The stand is detached when the monitor is shipped from the factory.

Vertical Extension

NOTE: The stand extends vertically up to 130 mm. The figure below illustrates how to extend the stand vertically.

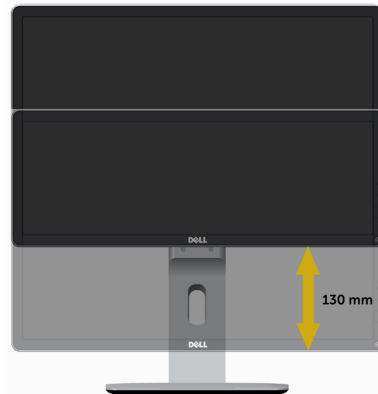

Rotating the Monitor

Before you rotate the monitor, your monitor should be fully vertically extended ([Vertical Extension](#)) and fully tilted ([Tilt](#)) up to avoid hitting the bottom edge of the monitor.

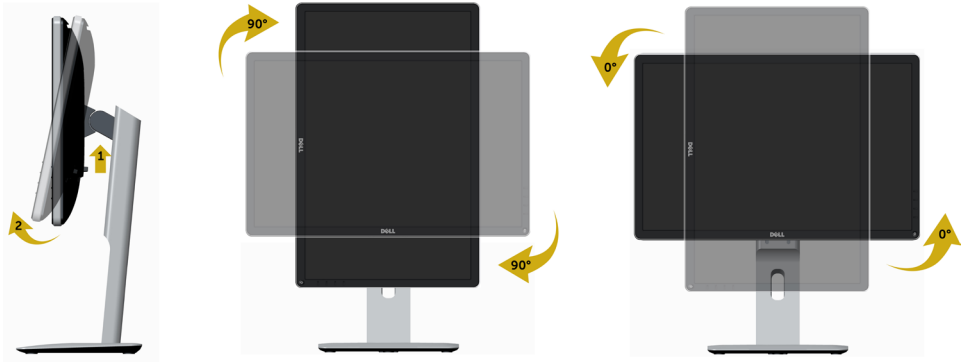

 **NOTE:** To use the Display Rotation function (Landscape versus Portrait view) with your Dell computer, you require an updated graphics driver that is not included with this monitor. To download the graphics driver, go to www.dell.com/support and see the download section for Video Drivers for latest driver updates.

 **NOTE:** When in the Portrait View Mode, you may experience performance degradation in graphic-intensive applications (3D Gaming and etc.).

Adjusting the Rotation Display Settings of Your System

After you have rotated your monitor, you need to complete the procedure below to adjust the Rotation Display Settings of your System.

 **NOTE:** If you are using the monitor with a non-Dell computer, you need to go the graphics driver website or your computer manufacturer website for information on rotating the 'contents' on your display.

To adjust the Rotation Display Settings:

- 1 Right-click on the desktop and click Properties.
- 2 Select the Settings tab and click Advanced.
- 3 If you have an ATI graphics card, select the Rotation tab and set the preferred rotation.

If you have an nVidia graphics card, click the nVidia tab, in the left-hand column select NVRotate, and then select the preferred rotation.

If you have an Intel® graphics card, select the Intel graphics tab, click Graphic Properties, select the Rotation tab, and then set the preferred rotation.

 **NOTE:** If you do not see the rotation option or it is not working correctly, go to www.dell.com/support and download the latest driver for your graphics card.

Troubleshooting

⚠ WARNING: Before you begin any of the procedures in this section, follow the [Safety Instructions](#).

Self-Test

Your monitor provides a self-test feature that allows you to check whether your monitor is functioning properly. If your monitor and computer are properly connected but the monitor screen remains dark, run the monitor self-test by performing the following steps:

- 1 Turn off both your computer and the monitor.
- 2 Unplug the video cable from the back of the computer.
- 3 Turn on the monitor.

The floating dialog box should appear on-screen (against a black background), if the monitor cannot sense a video signal and is working correctly. While in self-test mode, the power LED remains white also, depending upon the selected input, one of the dialogs shown below will continuously scroll through the screen.

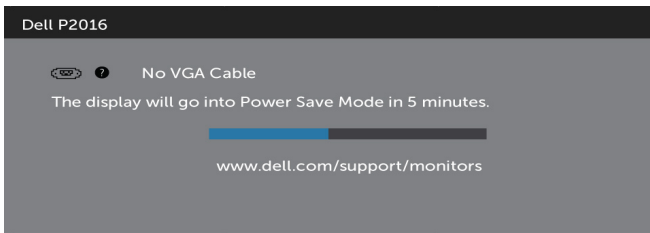

or

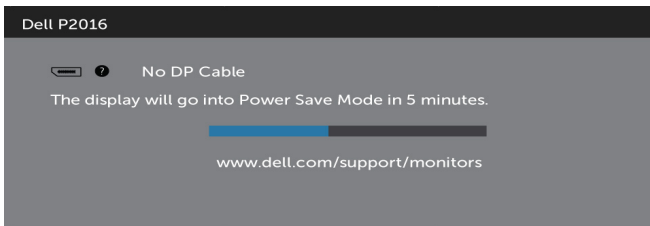

- 4 This box also appears during normal system operation, if the video cable becomes disconnected or damaged.
- 5 Turn off your monitor and reconnect the video cable; then turn on both your computer and the monitor.

If your monitor screen remains blank after you use the previous procedure, check your video controller and computer, because your monitor is functioning properly.

Built-in Diagnostics

Your monitor has a built-in diagnostic tool that helps you determine if the screen abnormality you are experiencing is an inherent problem with your monitor, or with your computer and video card.

 **NOTE:** You can run the built-in diagnostics only when the video cable is unplugged and the monitor is in self-test mode.

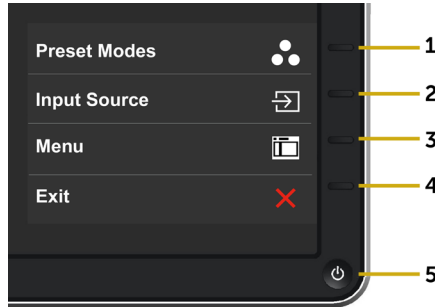

To run the built-in diagnostics:

- 1 Make sure that the screen is clean (no dust particles on the surface of the screen).
- 2 Unplug the video cable(s) from the back of the computer or monitor. The monitor then goes into the self-test mode.
- 3 Press and hold **Button 1** and **Button 4** on the front panel simultaneously for 2 seconds. A gray screen appears.
- 4 Carefully inspect the screen for abnormalities.
- 5 Press **Button 4** on the front panel again. The color of the screen changes to red.
- 6 Inspect the display for any abnormalities.
- 7 Repeat steps 5 and 6 to inspect the display in green, blue, black, white, and text screens.

The test is complete when the text screen appears. To exit, press **Button 4** again. If you do not detect any screen abnormalities upon using the built-in diagnostic tool, the monitor is functioning properly. Check the video card and computer.

Common Problems

The following table contains general information about common monitor problems you might encounter and the possible solutions:

Common Symptoms	What You Experience	Possible Solutions
No Video/Power LED off	No picture	<ul style="list-style-type: none"> • Ensure that the video cable connecting the monitor and the computer is properly connected and secure. • Verify that the power outlet is functioning properly using any other electrical equipment. • Ensure that the power button is depressed fully. • Ensure that the correct input source is selected in the Input Source menu.
No Video/Power LED on	No picture or no brightness	<ul style="list-style-type: none"> • Increase brightness & contrast controls via OSD. • Perform monitor self-test feature check. • Check for bent or broken pins in the video cable connector. • Run the built-in diagnostics. • Ensure that the correct input source is selected in the Input Source menu.
Poor Focus	Picture is fuzzy, blurry, or ghosting	<ul style="list-style-type: none"> • Perform Auto Adjust via OSD. • Adjust the Phase and Pixel Clock controls via OSD. • Eliminate video extension cables. • Reset the monitor to factory settings. • Change the video resolution to the correct aspect ratio.
Shaky/Jittery Video	Wavy picture or fine movement	<ul style="list-style-type: none"> • Perform Auto Adjust via OSD. • Adjust the Phase and Pixel Clock controls via OSD. • Reset the monitor to factory settings. • Check environmental factors. • Relocate the monitor and test in another room.
Missing Pixels	LCD screen has spots	<ul style="list-style-type: none"> • Cycle power on-off. • Pixel that is permanently off is a natural defect that can occur in LCD technology. • For more information on Dell Monitor Quality and Pixel Policy, see Dell Support site at: http://www.dell.com/support/monitors.
Stuck-on Pixels	LCD screen has bright spots	<ul style="list-style-type: none"> • Cycle power On-Off. • Pixel that is permanently off is a natural defect that can occur in LCD technology. • For more information on Dell Monitor Quality and Pixel Policy, see Dell Support site at: http://www.dell.com/support/monitors.
Brightness Problems	Picture too dim or too bright	<ul style="list-style-type: none"> • Reset the monitor to factory settings. • Auto Adjust via OSD. • Adjust brightness & contrast controls via OSD.
Geometric Distortion	Screen not centered correctly	<ul style="list-style-type: none"> • Reset the monitor to factory settings. • Auto Adjust via OSD. • Adjust horizontal & vertical controls via OSD.

Common Symptoms	What You Experience	Possible Solutions
Horizontal/ Vertical Lines	Screen has one or more lines	<ul style="list-style-type: none"> • Reset the monitor to factory settings. • Perform Auto Adjust via OSD. • Adjust Phase and Pixel Clock controls via OSD. • Perform monitor self-test feature check and determine if these lines are also in self-test mode. • Check for bent or broken pins in the video cable connector. • Run the built-in diagnostics.
Synchronization Problems	Screen is scrambled or appears torn	<ul style="list-style-type: none"> • Reset the monitor to factory settings. • Perform Auto Adjust via OSD. • Adjust Phase and Pixel Clock controls via OSD. • Perform monitor self-test feature check to determine if the scrambled screen appears in self-test mode. • Check for bent or broken pins in the video cable connector. • Restart the computer in safe mode.
Safety Related Issues	Visible signs of smoke or sparks	<ul style="list-style-type: none"> • Do not perform any troubleshooting steps. • Contact Dell immediately.
Intermittent Problems	Monitor malfunctions on & off	<ul style="list-style-type: none"> • Ensure that the video cable connecting the monitor to the computer is connected properly and is secure. • Reset the monitor to factory settings. • Perform monitor self-test feature check to determine if the intermittent problem occurs in self-test mode.
Missing Color	Picture missing color	<ul style="list-style-type: none"> • Perform monitor self-test. • Ensure that the video cable connecting the monitor to the computer is connected properly and is secure. • Check for bent or broken pins in the video cable connector.
Wrong Color	Picture color not good	<ul style="list-style-type: none"> • Change the settings of the Preset Modes in the Color menu OSD depending on the application. • Adjust R/G/B value under Custom. Color in Color menu OSD. • Change the Input Color Format to PC RGB or YPbPr in the Color menu OSD. • Run the built-in diagnostics.
Image retention from a static image left on the monitor for a long period of time	Faint shadow from the static image displayed appears on the screen	<ul style="list-style-type: none"> • Use the Power Management feature to turn off the monitor at all times when not in use (for more information, see Power Management Modes). • Alternatively, use a dynamically changing screensaver.

Product Specific Problems

Specific Symptoms	What You Experience	Possible Solutions
Screen image is too small	Image is centered on screen, but does not fill entire viewing area	<ul style="list-style-type: none">• Check the Aspect Ratio setting in the Display menu OSD.• Reset the monitor to factory settings.
Cannot adjust the monitor with the buttons on the front panel	OSD does not appear on the screen	<ul style="list-style-type: none">• Turn off the monitor, unplug the monitor power cable, plug it back, and then turn on the monitor.• Check whether the OSD menu is locked. If yes, press and hold the button beside the power button for 6 seconds to unlock (for more information, see Lock).
No Input Signal when user controls are pressed	No picture, the LED light is white	<ul style="list-style-type: none">• Check the signal source. Ensure the computer is not in the power saving mode by moving the mouse or pressing any key on the keyboard.• Check whether the signal cable is plugged in properly. Re-plug the signal cable if necessary.• Reset the computer or video player.
The picture does not fill the entire screen	The picture cannot fill the height or width of the screen	<ul style="list-style-type: none">• Due to different video formats (aspect ratio) of DVDs, the monitor may display in full screen.• Run the built-in diagnostics.

Universal Serial Bus (USB) Specific Problems

Specific Symptoms	What You Experience	Possible Solutions
USB interface is not working	USB peripherals are not working	<ul style="list-style-type: none">• Check that your monitor is turned ON.• Reconnect the upstream cable to your computer.• Reconnect the USB peripherals (downstream connector).• Switch off and then turn on the monitor again.• Reboot the computer.• Some USB devices like external portable HDD require higher electric current; connect the device directly to the computer system.
High Speed USB 2.0 interface is slow.	High Speed USB 2.0 peripherals working slowly or not working at all	<ul style="list-style-type: none">• Check that your computer is USB 2.0-capable.• Some computers have both USB 2.0 and USB 1.1 ports. Ensure that the correct USB port is used.• Reconnect the upstream cable to your computer.• Reconnect the USB peripherals (downstream connector).• Reboot the computer.

Appendix

Safety Instructions

 **WARNING:** Use of controls, adjustments, or procedures other than those specified in this documentation may result in exposure to shock, electrical hazards, and/or mechanical hazards.

For information on safety instructions, see the Product Information Guide.

FCC Notices (U.S. only) and Other Regulatory Information

For FCC notices and other regulatory information, see the regulatory compliance website located at www.dell.com/regulatory_compliance.

Contacting Dell

 **NOTE:** If you do not have an active Internet connection, you can find contact information on your purchase invoice, packing slip, bill, or Dell product catalog.

Dell provides several online and telephone-based support and service options. Availability varies by country and product, and some services may not be available in your area.

To get online Monitor support content:

See www.dell.com/support/monitors.

To contact Dell for sales, technical support, or customer service issues:

- 1 Go to www.dell.com/support.
- 2 Verify your country or region in the Choose A Country/Region drop-down menu at the top-left corner of the page.
- 3 Click **Contact Us** next to the country dropdown.
- 4 Select the appropriate service or support link based on your need.
- 5 Choose the method of contacting Dell that is convenient for you.

Setting Up Your Monitor

Setting Display Resolution to 1440 x 900 (maximum)

For best performance, set the display resolution to 1440 x 900 pixels by performing the following steps:

In Windows 7, Windows 8 and Windows 8.1 :

- 1 For Windows 8 and Windows 8.1 only, select the desktop tile to switch to classic desktop.
- 2 Right-click on the desktop and click **Screen Resolution**.
- 3 Click the Dropdown list of the Screen Resolution and select **1440 x 900**.
- 4 Click **OK**.

If you do not see the recommended resolution as an option, you may need to update your graphics driver. Please choose the scenario below that best describes the computer system you are using, and follow the given steps.

Dell computer

- 1 Go to www.dell.com/support, enter your service tag, and download the latest driver for your graphics card.
- 2 After installing the drivers for your graphics adapter, attempt to set the resolution to 1440 x 900 again.

 **NOTE:** If you are unable to set the resolution to 1440 x 900, please contact Dell to inquire about a graphics adapter that supports these resolutions.

Non-Dell computer

In Windows 7, Windows 8 and Windows 8.1 :

- 1 For Windows 8 and Windows 8.1 only, select the desktop tile to switch to classic desktop.
- 2 Right-click on the desktop and click **Personalization**.
- 3 Click **Change Display Settings**.
- 4 Click **Advanced Settings**.
- 5 Identify your graphics controller supplier from the description at the top of the window (e.g. NVIDIA, ATI, Intel etc.).
- 6 Refer to the graphic card provider website for updated driver (for example, <http://www.ATI.com> or <http://www.NVIDIA.com>).
- 7 After installing the drivers for your graphics adapter, attempt to set the resolution to **1440 x 900** again.

 **NOTE:** If you are unable to set the recommended resolution, please contact the manufacturer of your computer or consider purchasing a graphics adapter that supports the video resolution.

Maintenance Guidelines

Cleaning Your Monitor



WARNING: Before cleaning the monitor, unplug the monitor power cable from the electrical outlet.



CAUTION: Read and follow the [Safety Instructions](#) before cleaning the monitor.

For best practices, follow these instructions in the list below while unpacking, cleaning, or handling your monitor:

- To clean your anti-static screen, lightly dampen a soft, clean cloth with water. If possible, use a special screen-cleaning tissue or solution suitable for the anti-static coating. Do not use benzene, thinner, ammonia, abrasive cleaners, or compressed air.
- Use a lightly-dampened, soft cloth to clean the monitor. Avoid using detergent of any kind as some detergents leave a milky film on the monitor.
- If you notice white powder when you unpack your monitor, wipe it off with a cloth.
- Handle your monitor with care as a darker-colored monitor may get scratched and show white scuff marks more than a lighter-colored monitor.
- To help maintain the best image quality on your monitor, use a dynamically changing screen saver and turn off your monitor when not in use.

Free Manuals Download Website

<http://myh66.com>

<http://usermanuals.us>

<http://www.somanuals.com>

<http://www.4manuals.cc>

<http://www.manual-lib.com>

<http://www.404manual.com>

<http://www.luxmanual.com>

<http://aubethermostatmanual.com>

Golf course search by state

<http://golfingnear.com>

Email search by domain

<http://emailbydomain.com>

Auto manuals search

<http://auto.somanuals.com>

TV manuals search

<http://tv.somanuals.com>