



**Dell XC6320 Web-Scaled Hyperconverged  
Appliance  
Owner's Manual**



# Notes, cautions, and warnings

-  **NOTE:** A NOTE indicates important information that helps you make better use of your computer.
-  **CAUTION:** A CAUTION indicates either potential damage to hardware or loss of data and tells you how to avoid the problem.
-  **WARNING:** A WARNING indicates a potential for property damage, personal injury, or death.

© 2016 Dell Inc. All rights reserved. This product is protected by U.S. and international copyright and intellectual property laws. Dell and the Dell logo are trademarks of Dell Inc. in the United States and/or other jurisdictions. All other marks and names mentioned herein may be trademarks of their respective companies.

2016 - 05

Rev. A02

# Contents

<b>1 About the Dell XC6320.....</b>	<b>7</b>
About your system.....	7
Accessing system features during startup.....	7
Front panel features and indicators.....	8
Hard drive indicator patterns.....	10
Back panel features and indicators.....	10
System-board assembly configurations.....	12
LAN indicator codes.....	12
Power and system board indicator codes.....	14
Power Supply Unit indicator codes.....	15
1600 W AC/1600 W HVDC PSU.....	15
iDRAC heart beat LED.....	16
Documentation references.....	16
<b>2 Performing initial system configuration .....</b>	<b>17</b>
Setting up your system.....	17
Setting up and configuring the iDRAC IP address.....	17
Logging in to iDRAC.....	18
Methods of installing the operating system.....	18
Managing your system remotely.....	18
Downloading drivers and firmware.....	18
<b>3 Pre-operating system management applications.....</b>	<b>20</b>
Navigation keys.....	20
System Setup.....	20
Entering System Setup.....	21
System Setup details.....	21
System BIOS Settings details.....	21
System Information details.....	22
Memory Settings details.....	22
Processor Settings details.....	23
SATA Settings details.....	24
Boot Settings details.....	27
Network Settings screen details.....	27
Integrated Devices details.....	27
Serial Communication details.....	29
System Profile Settings details.....	29
System Security Settings details.....	30

Miscellaneous Settings details.....	32
System setup options at boot.....	32
About Boot Manager.....	33
Viewing Boot Manager.....	33
Boot Manager main menu.....	33
Changing the boot order.....	33
Choosing the system boot mode.....	33
Assigning a system and setup password .....	34
Deleting or changing system and setup password.....	35

#### **4 Installing and removing system components.....36**

Safety instructions.....	36
Recommended tools.....	36
Opening and closing the system .....	37
Removing the system cover.....	37
Installing the system cover.....	38
Inside the system.....	38
Cooling fans.....	38
Removing a cooling fan.....	38
Installing a cooling fan.....	40
Hard drives.....	41
Removing a 2.5-inch hard drive blank.....	41
Installing a 2.5-inch hard drive blank.....	42
Removing a hard drive.....	42
Installing a hard drive.....	43
Removing a hard drive from a hard drive carrier.....	44
Installing a hard drive into a hard drive carrier.....	45
SATADOM.....	45
Important information about SATADOM.....	45
Removing the SATADOM.....	46
Installing the SATADOM.....	47
Cable routing for SATADOM and LSI 2008.....	48
Power supply units.....	48
Removing a power supply unit.....	49
Installing a power supply unit.....	50
System board assembly.....	50
Removing the system board tray .....	50
Installing the system board tray .....	51
Removing the system board assembly .....	51
Installing the system board assembly .....	52
Air baffle .....	53
Removing the cooling shroud .....	53

Installing the cooling shroud .....	54
Heat sinks.....	54
Removing the heat sink .....	55
Installing the heat sink .....	56
Processors .....	56
Removing a processor .....	56
Installing a processor .....	57
Expansion card assembly and expansion card .....	58
Removing the expansion card.....	58
Installing the expansion card.....	60
Riser card .....	61
Removing the riser card.....	61
Installing the riser card.....	62
LSI 2008 Mezzanine Card.....	62
Removing the LSI 2008 SAS mezzanine card.....	63
Installing the LSI 2008 SAS mezzanine card .....	64
Mezzanine card bridge board .....	64
Removing the mezzanine card bridge board .....	64
Installing the mezzanine card bridge board .....	65
System memory.....	65
Memory slot features .....	66
Supported memory module configuration .....	66
Removing the memory modules .....	67
Installing the memory modules.....	68
System battery .....	69
Replacing the system battery .....	69
System board .....	71
Removing a system board .....	71
Installing a system board .....	72
Entering the system Service Tag using System Setup .....	73
<b>5 Troubleshooting your system.....</b>	<b>75</b>
Safety first—for you and your system.....	75
Minimum configuration to POST .....	75
Safety first – for you and your system .....	75
Installation-related issues.....	75
Troubleshooting system startup failure .....	76
Troubleshooting external connections.....	76
Troubleshooting the video subsystem .....	76
Troubleshooting a USB device.....	76
Troubleshooting a serial I/O device.....	77
Troubleshooting a NIC .....	77

Troubleshooting a wet system.....	77
Troubleshooting a damaged system .....	78
Troubleshooting the system battery.....	78
Troubleshooting PSUs.....	79
Troubleshooting system cooling issues.....	79
Troubleshooting a fan.....	80
Troubleshooting system memory.....	80
Troubleshooting a hard drive .....	81
Troubleshooting a storage controller .....	81
Troubleshooting expansion cards.....	82
Troubleshooting processors.....	82
IRQ assignment conflicts.....	83
<b>6 Jumpers and connectors .....</b>	<b>85</b>
Dell XC6320 system board connectors.....	85
LSI 2008 SAS mezzanine card connectors.....	87
Jumper settings.....	87
System configuration jumper settings on the Dell XC6320 system board.....	88
<b>7 Getting help.....</b>	<b>89</b>
Contacting Dell.....	89
Dell SupportAssist.....	89
Locating your system Service Tag.....	89
Quick Resource Locator.....	91

# About the Dell XC6320

## About your system

The Dell XC6320 system is a web-scale converged appliance based on the Dell PowerEdge C6320 and supports 512 GB memory (with 32 GB RDIMMs), six hard drives per node, and up to four nodes per chassis.

## Accessing system features during startup

The following keystrokes provide access to system features during startup.

 **NOTE:** The hot keys of SAS or SATA card or PXE support are available in BIOS boot mode only. There is no hot key to boot in the the UEFI mode.

<b>F2</b>	Enters the System Setup program.
<b>F11</b>	Enters the BIOS Boot Manager.
<b>F12</b>	Starts Preboot eXecution Environment (PXE)/iSCSI boot.
<b>Ctrl +C</b>	Enters the LSI 2008 SAS Mezzanine Card Configuration Utility. For more information, see the SAS adapter documentation.
<b>Ctrl+R</b>	Enters the PERC 9 Card Configuration Utility. For more information, see the documentation for your SAS RAID card.
<b>Ctrl+Y</b>	Enters the MegaPCLI SAS RAID Management Tool.
<b>Ctrl+S</b>	Enters the utility to configure onboard LAN settings for PXE boot. For more information, see the documentation for your integrated LAN.
<b>Ctrl+I</b>	Enters onboard SATA Controller's Configuration Utility.
<b>Ctrl+D</b>	Enters the Intel iSCSI setup menu.

# Front panel features and indicators

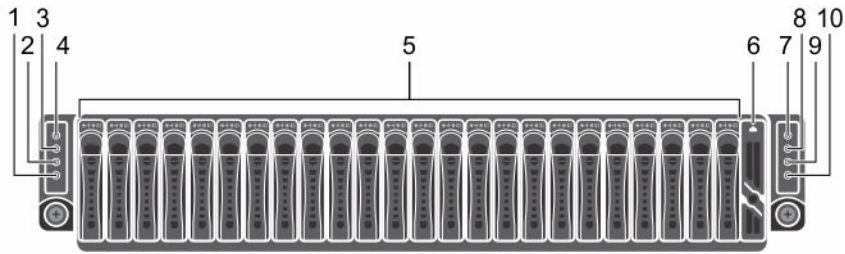







**Figure 1. Front panel features and indicators**

**NOTE:** For more information about the direction details of the 2.5-inch hard drive expander configuration support, see the HDD Zoning configuration tool at [Dell.com/support](http://Dell.com/support).

**Table 1. Front-panel features and indicators**

Item	Indicator, button or connector	Icon	Description
1	System identification indicator or button for system board 2		The identification button can be used to locate a particular system and system board within a chassis. When the button is pushed, the blue status indicator of the system on the front and rear blinks until the button is pushed again.
2	Power-on indicator or system state indicator or power button for system board 2		The power-on indicator turns to green when the system power is on.
3	System identification indicator or button for system board 1		The identification button can be used to locate a particular system and system board within a chassis. When the button is pushed, the blue status indicator of the system on the front and rear blinks until the button is pushed again.
4	Power-on indicator or system state indicator or power button for system board 1		The power-on indicator turns to amber when the system critical event occurs.
5	Hard drives		Up to 24, hot-swappable, 2.5--inch hard drives.



Item	Indicator, button or connector	Icon	Description
6	Drive cover		This is not a usable drive slot.
7	Power-on indicator or system state indicator or power button for system board 3		<p> <b>NOTE:</b> When turning on the system, the video monitor can take from several seconds to over two minutes to display an image, depending on the amount of DIMM installed in the system.</p> <p> <b>NOTE:</b> On ACPI-compliant operating systems (OSs), turning off the system by using the power button causes the system to perform a graceful shutdown before the system is turned off.</p> <p> <b>NOTE:</b> To force an ungraceful shutdown, press and hold the power button for five seconds.</p>
8	System identification indicator or button for system board 3		The identification button can be used to locate a particular system and system board within a chassis. When the button is pushed, the blue status indicator of the system on the front and rear blinks until the button is pushed again.
9	Power-on indicator or system state indicator or power button for system board 4		The power button controls the DC power supply unit (PSU) output to the system.
10	System identification indicator or button for system board 4		The identification button can be used to locate a particular system and system board within a chassis. When the button is pushed, the blue status indicator of the system on the front and rear blinks until the button is pushed again.

## Hard drive indicator patterns



Figure 2. Hard drive front view

1. hard drive status indicator (green and amber)
2. hard drive activity indicator (green)

Table 2. Hard drive indicator patterns

Controller	Hard drive type	Function	Activity LED	Status LED
			Green	Green
Onboard Controller	SATA2	Drive on-line	Off/Blinking when active	On
		Fail	Off	On

## Back panel features and indicators

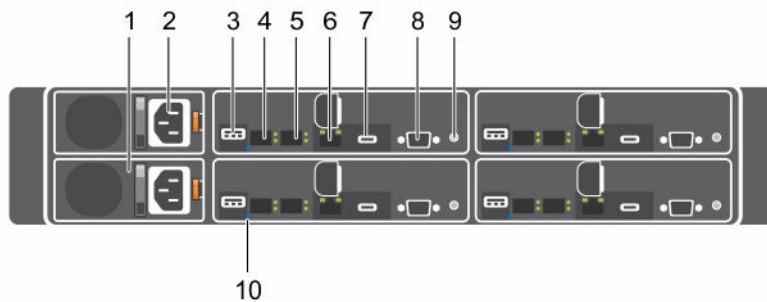











Figure 3. Back panel features and indicators

**Table 3. Back panel features and indicators**

Item	Indicator, button, or connector	Icon	Description
1	PSU 2		1600 W AC PSUs.
2	PSU 1		1600 W AC PSUs.
3	USB port		Enables you to connect USB devices to the system. The ports are USB 3.0-compliant.
4	Ethernet connector		10G NIC 1 connector.
5	Ethernet connector		10G NIC 2 connector.
6	Management port		Dedicated management port.
7	USB to serial port		Connects the system to a host.
8	VGA port		Connects a VGA display to the system.
9	Power button/power and system LED		<p>The power-on indicator glows green when the system power is on.</p> <p>The power-on indicator turns amber when the system critical event occurs.</p> <p>The power button controls the DC PSU output to the system.</p> <p> <b>NOTE:</b> When turning on the system, the video monitor can take from several seconds to over two minutes to display an image, on the basis of the disk space available in the system.</p> <p> <b>NOTE:</b> On ACPI-compliant operating systems, turning off the system by using the power button causes the system to perform a graceful shutdown before the system is turned off.</p>

Item	Indicator, button, or connector	Icon	Description
			<p> <b>NOTE:</b> To force an ungraceful shutdown, press and hold the power button for five seconds.</p>
10	System identification indicator		<p>The management software of both the systems and the identification buttons on the front can cause the indicator to flash blue to identify a particular system and system board. Indicators turn amber when the system requires attention because of an issue.</p>

## System-board assembly configurations



Figure 4. Enumeration four system boards for 1U node

## LAN indicator codes

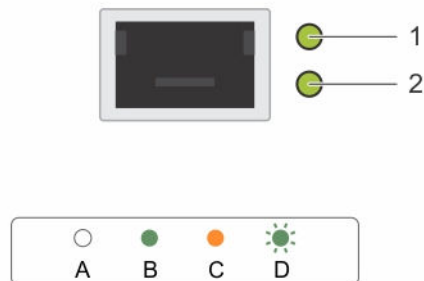
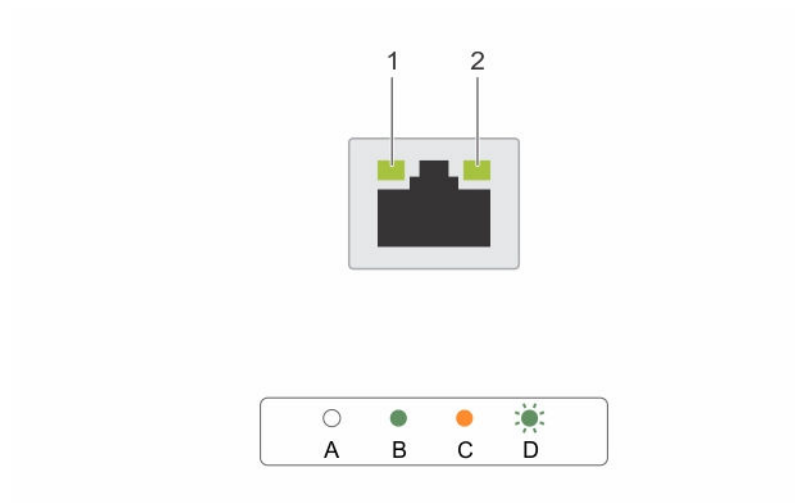

Figure 5. LAN indicators

1. activity indicator
2. link and network speed indicator

**Table 4. LAN indicator codes**

Component	Indicator	Condition
Link and network speed indicator	Solid amber	Linking at 1 Gbps speed
	Solid green	Linking at 10 Gbps speed
Activity indicator	Blinking green	Activity is present: <ul style="list-style-type: none"> <li>• Pre OS POST</li> <li>• OS without driver</li> <li>• OS with driver</li> </ul> Blinking at speed relative to packet density.
	Off	No link/activity present <ul style="list-style-type: none"> <li>• D0 (uninitialized)</li> <li>• D3 (cold)</li> <li>• S4 (hibernation)</li> </ul>



**Figure 6. LAN indicators (management port)**

1. speed indicator
2. link and activity indicator

**Table 5. LAN indicators (management port)**

Component	Indicator	Condition
Speed indicator	Solid green	Linking at 1 Gbps speed
	Solid amber	Linking at 10/100 Mbps speed
Link and activity indicator	Off	No access or Idle
	Blinking green	LAN access or Link up

## Power and system board indicator codes

The LEDs on the system front panel and back panel display status codes during system startup. For location of the LEDs on the front panel, see the Front panel features and indicators section. For location of the LEDs on the back panel, see the Back panel features and indicators section.

**Table 6. Status indicator codes**

Component	Indicator		Condition
Power-on indicator (A bicolor LED on power button)	Green	Solid	Power On (S0)
	Amber	Off	
	Green	Off	iDRAC critical condition event in Power Off mode (S4/S5)
	Amber	Blinking	
	Green	Off	iDRAC critical condition event in Power On mode (S0)
System identification indicator	Amber	Blinking	
	Steady blue		IPMI using Chassis Identify Command On or ID Button Press ID On
	Blinking blue		Only IPMI using Chassis Identify Command Blink On
	Off		IPMI using Chassis Identify Command Off or ID Button Press ID Off

# Power Supply Unit indicator codes

Each AC power supply unit (PSU) has an illuminated translucent handle that indicates whether power is present or whether a power fault has occurred.

## 1600 W AC/1600 W HVDC PSU

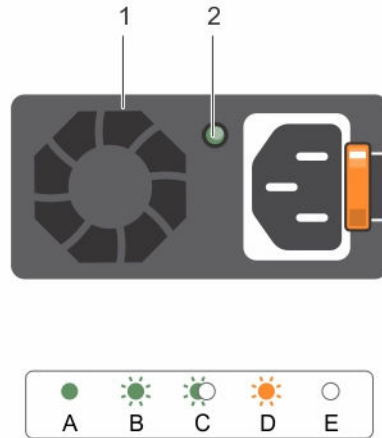

**Figure 7. PSU status indicator**

1. PSU

2. AC power indicator

**Table 7. 1600 W AC/1600 W HVDC PSU indicators**

Component	Indicator	Condition
AC power indicator	Solid amber	Standby mode with Fan Lock for 15 seconds.  Standby mode with OTP range  Active mode with +12 V DC Fault  Active mode with Fan Lock for 15 seconds.
	Solid green	DC_OK (power good)
	Blinking green	Standby mode normal
	Off	Unit without AC power

## iDRAC heart beat LED

The system board provides iDRAC heart beat LED (CR17) for iDRAC debugs. The iDRAC heart beat LED is green. When the system AC power is connected, the LED glows. When iDRAC firmware is ready, the iDRAC heart beat LED blinks.

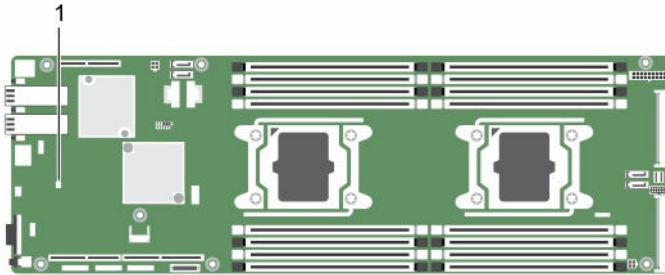

**Figure 8. iDRAC heart beat LED on the Dell XC6320 system board**

1. iDRAC heart beat LED

## Documentation references

For information about the Dell documents, see the Support Matrix specific for your product.

For information about the Nutanix documents that applies to a specific release of Nutanix solution software, see the Support Matrix specific for your product.



# Performing initial system configuration

After you receive your system, you must set up your system, install the operating system if it is not pre-installed, and set up and configure the system iDRAC IP address.

## Setting up your system

1. Unpack the system.
2. Install the system into the rack. For more information about installing the system into the rack, see your system *Rack Installation Placemat*.
3. Connect the peripheral devices to the system.
4. Connect the system to its electrical outlet.
5. Turn on the system by pressing the power button or by using iDRAC.
6. Turn on the attached peripheral devices.

## Setting up and configuring the iDRAC IP address

You can set up the Integrated Dell Remote Access Controller (iDRAC) IP address by using one of the following interfaces:

- Dell iDRAC Settings utility
- Dell Lifecycle Controller
- Dell OpenManage Deployment Toolkit

You can use the default iDRAC IP address 192.168.0.120 to configure the initial network settings, including setting up DHCP or a static IP for iDRAC.

You can configure iDRAC IP address by using the following interfaces:

 **NOTE:** Ensure that you change the default user name and password after setting up the iDRAC IP address.

- iDRAC Web interface: For more information, see the *Integrated Dell Remote Access Controller User's Guide*.
- Remote Access Controller Admin (RACADM): For more information, see the *RACADM Command Line Interface Reference Guide* and the *Integrated Dell Remote Access Controller User's Guide*.
- Remote Services that include Web Services Management (WS-Man): For more information, see the *Dell Lifecycle Controller Remote Services Quick Start Guide*.

For more information about setting up and configuring iDRAC, see the *Integrated Dell Remote Access Controller User's Guide* available at [Dell.com/esmanuals](http://Dell.com/esmanuals).

## Logging in to iDRAC

You can log in to iDRAC as an iDRAC local user, a Microsoft Active Directory user, or a Lightweight Directory Access Protocol (LDAP) user. You can also log in by using Single Sign-On or a Smart Card. The default user name is `root` and password is `calvin`. For more information about logging in to iDRAC and iDRAC licenses, see the *Integrated Dell Remote Access Controller User's Guide* available at [Dell.com/idracmanuals](https://Dell.com/idracmanuals).

You can also access iDRAC by using RACADM. For more information, see the *RACADM Command Line Interface Reference Guide* and the *Integrated Dell Remote Access Controller User's Guide* available at [Dell.com/idracmanuals](https://Dell.com/idracmanuals).

## Methods of installing the operating system

If the system is shipped without an operating system, install the supported OS on the system by using one of the following methods:

- Dell Systems Management Tools and Documentation media — see the operating system documentation available at [Dell.com/operatingsystemmanuals](https://Dell.com/operatingsystemmanuals).
- Dell Lifecycle Controller — see the Dell Lifecycle Controller documentation available at [Dell.com/idracmanuals](https://Dell.com/idracmanuals).
- Dell OpenManage Deployment Toolkit — see the Dell OpenManage documentation available at [Dell.com/openmanagemanuals](https://Dell.com/openmanagemanuals) → [OpenManage software](#).

For information about supported operating systems, see the operating systems support matrix available at [Dell.com/ossupport](https://Dell.com/ossupport).

## Managing your system remotely

To perform out-of-band systems management by using iDRAC, configure iDRAC for remote accessibility, set up the management station and managed system, and configure the supported web browsers. For more information, see the *Integrated Dell Remote Access Controller User's Guide* at [Dell.com/idracmanuals](https://Dell.com/idracmanuals).

You can also remotely monitor and manage the server by using the Dell OpenManage Server Administrator (OMSA) software and OpenManage Essentials (OME) systems management console. For more information, see [Dell.com/openmanagemanuals](https://Dell.com/openmanagemanuals) → [OpenManage Server Administrator](#) or [Dell.com/openmanagemanuals](https://Dell.com/openmanagemanuals) → [OpenManage Essentials](#).

## Downloading drivers and firmware

Dell recommends you to download and install the latest BIOS, drivers, and systems management firmware on your system.

Ensure that you clear the web browser cache.

1. Go to [Dell.com/support/drivers](https://Dell.com/support/drivers).
2. In the **Identify your product** section, enter the Service Tag of your system in **Enter a Service Tag or Express Service Code**.



**NOTE:** If you do not have the Service Tag, you can do one of the following:

- Select **Auto-detect your product** to allow the system to automatically detect your Service Tag
- Select **Browse for a product** to select your product from the **Select a product** page.

**3. Click Drivers and downloads.**

The drivers that are applicable to your selection are displayed.

**4. Repeat steps 1 through 3 to download the HDD zoning configuration utility.**

**5. Search on the basis of Category, and then click System Utilities.**

**HDD zoning configuration utility** is displayed.

# Pre-operating system management applications

You can manage basic settings and features of a system without booting to the operating system by using the system firmware.

## Navigation keys

The navigation keys can help you access the pre-operating system management applications.

<b>Page Up</b>	Moves to the previous screen.
<b>Page Down</b>	Moves to the next screen.
<b>Up arrow</b>	Moves to the previous field.
<b>Down arrow</b>	Moves to the next field.
<b>Enter</b>	Enables you to type a value in the selected field (if applicable) or follow the link in the field.
<b>Spacebar</b>	Expands or collapses a drop-down list, if applicable.
<b>Tab</b>	Moves to the next focus area.
	 <b>NOTE:</b> This feature is applicable for the standard graphical browser only.
<b>Esc</b>	Moves to the previous page until you view the main screen. Pressing Esc in the main screen exits System BIOS/iDRAC Settings/Device Settings/Service Tag Settings and proceeds with system boot.
<b>F1</b>	Displays the System Setup help information.
<b>F2</b>	Enables you to enter <b>System Setup</b> .
<b>F10</b>	Enables you to enter <b>Lifecycle Controller</b> .
<b>F11</b>	Enables you to enter <b>Boot Manager</b> .
<b>F12</b>	Enables you to enter <b>PXE boot</b> .

## System Setup

By using the **System Setup** screen, you can configure the BIOS settings, iDRAC settings, and device settings of your system.

These settings have already been preconfigured per solution requirements. Contact Dell before you change these settings.



**NOTE:** Help text for the selected field is displayed in the graphical browser by default. To view the help text in the text browser, press F1.

You can access system setup by using two methods:

- Standard graphical browser—The browser is enabled by default.
- Text browser—The browser is enabled by using Console Redirection.

## Entering System Setup

1. Turn on, or restart your system.
2. Press F2 immediately after you see the following message:  
F2 = System Setup

If your operating system begins to load before you press F2, wait for the system to finish booting, and then restart your system and try again.

## System Setup details

The **System Setup Main Menu** screen details are explained as follows:

<b>System BIOS</b>	Enables you to configure BIOS settings.
<b>iDRAC Settings</b>	Enables you to configure iDRAC settings. The iDRAC settings utility is an interface to set up and configure the iDRAC parameters by using UEFI (Unified Extensible Firmware Interface). You can enable or disable various iDRAC parameters by using the iDRAC settings utility. For more information about this utility, see <i>Integrated Dell Remote Access Controller User's Guide</i> at <a href="http://Dell.com/idracmanuals">Dell.com/idracmanuals</a> .
<b>Device Settings</b>	Enables you to configure device settings.

## System BIOS Settings details

The **System BIOS Settings** screen details are explained as follows:

<b>System Information</b>	Specifies information about the system such as the system model name, BIOS version, and Service Tag.
<b>Memory Settings</b>	Specifies information and options related to the installed memory.
<b>Processor Settings</b>	Specifies information and options related to the processor such as speed and cache size.
<b>SATA Settings</b>	Specifies options to enable or disable the integrated SATA controller and ports.
<b>Boot Settings</b>	Specifies options to specify the boot mode (BIOS or UEFI). Enables you to modify UEFI and BIOS boot settings.
<b>Network Settings</b>	Specifies options to change the network settings.
<b>Integrated Devices</b>	Specifies options to manage integrated device controllers and ports and specify related features and options.

<b>Serial Communication</b>	Specifies options to manage the serial ports and specify related features and options.
<b>System Profile Settings</b>	Specifies options to change the processor power management settings, memory frequency, and so on.
<b>System Security</b>	Specifies options to configure the system security settings, such as system password, setup password, Trusted Platform Module (TPM) security. It also manages the power and NMI buttons on the system.
<b>Miscellaneous Settings</b>	Specifies options to change the system date, time, and so on.

## System Information details



The **System Information** screen details are explained as follows:

<b>System Model Name</b>	Specifies the system model name.
<b>System BIOS Version</b>	Specifies the BIOS version installed on the system.
<b>System Management Engine Version</b>	Specifies the current version of the Management Engine firmware.
<b>System Service Tag</b>	Specifies the system Service Tag.
<b>System Manufacturer</b>	Specifies the name of the system manufacturer.
<b>System Manufacturer Contact Information</b>	Specifies the contact information of the system manufacturer.
<b>System CPLD Version</b>	Specifies the current version of the system complex programmable logic device (CPLD) firmware.
<b>UEFI Compliance Version</b>	Specifies the UEFI compliance level of the system firmware.

## Memory Settings details

The **Memory Settings** screen details are explained as follows:



<b>System Memory Size</b>	Specifies the memory size in the system.
<b>System Memory Type</b>	Specifies the type of memory installed in the system.
<b>System Memory Speed</b>	Specifies the system memory speed.
<b>System Memory Voltage</b>	Specifies the system memory voltage.
<b>Video Memory</b>	Specifies the amount of video memory.

<b>System Memory Testing</b>	Specifies whether the system memory tests are run during system boot. Options are <b>Enabled</b> and <b>Disabled</b> . This option is set to <b>Disabled</b> by default.
<b>Memory Operating Mode</b>	Specifies the memory operating mode. The options available are <b>Optimizer Mode</b> , <b>Advanced ECC Mode</b> , <b>Mirror Mode</b> , <b>Spare Mode</b> , <b>Spare with Advanced ECC Mode</b> , <b>Dell Fault Resilient Mode</b> and <b>Dell NUMA Fault Resilient Mode</b> . This option is set to <b>Optimizer Mode</b> by default. <ul style="list-style-type: none"> <li> <b>NOTE:</b> The <b>Memory Operating Mode</b> option can have different default and available options based on the memory configuration of your system.</li> <li> <b>NOTE:</b> The <b>Dell Fault Resilient Mode</b> option establishes an area of memory that is fault resilient. This mode can be used by an operating system that supports the feature to load critical applications or enables the operating system kernel to maximize system availability.</li> </ul>
<b>Node Interleaving</b>	Specifies if Non-Uniform Memory architecture (NUMA) is supported. If this field is set to <b>Enabled</b> , memory interleaving is supported if a symmetric memory configuration is installed. If the field is set to <b>Disabled</b> , the system supports NUMA (asymmetric) memory configurations. This option is set to <b>Disabled</b> by default.
<b>Snoop Mode</b>	Specifies the Snoop Mode options. The Snoop Mode options available are <b>Home Snoop</b> , <b>Early Snoop</b> , and <b>Cluster on Die</b> . This option is set to <b>Early Snoop</b> by default. This field is available only when the <b>Node Interleaving</b> is set to <b>Disabled</b> .

## Processor Settings details

The **Processor Settings** screen details are explained as follows:

<b>Logical Processor</b>	Enables or disables the logical processors and displays the number of logical processors. If this option is set to <b>Enabled</b> , the BIOS displays all the logical processors. If this option is set to <b>Disabled</b> , the BIOS displays only one logical processor per core. This option is set to <b>Enabled</b> by default.
<b>QPI Speed</b>	Enables you to control QuickPath Interconnect data rate settings.
<b>Alternate RTID (Requestor Transaction ID) Setting</b>	Modifies Requestor Transaction IDs, which are QPI resources. This option is set to <b>Disabled</b> by default. <ul style="list-style-type: none"> <li> <b>NOTE:</b> Enabling this option may negatively impact the overall system performance.</li> </ul>
<b>Virtualization Technology</b>	Enables or disables the additional hardware capabilities provided for virtualization. This option is set to <b>Enabled</b> by default.
<b>Address Translation Service (ATS)</b>	Defines the Address Translation Cache (ATC) for devices to cache the DMA transactions. This option provides an interface between CPU and DMA Memory Management to a chipset's Address Translation and Protection Table to translate DMA addresses to host addresses. This option is set to <b>Enabled</b> by default.
<b>Adjacent Cache Line Prefetch</b>	Optimizes the system for applications that need high utilization of sequential memory access. This option is set to <b>Enabled</b> by default. You can disable this option for applications that need high utilization of random memory access.
<b>Hardware Prefetcher</b>	Enables or disables the hardware prefetcher. This option is set to <b>Enabled</b> by default.
<b>DCU Streamer Prefetcher</b>	Enables or disables the Data Cache Unit (DCU) streamer prefetcher. This option is set to <b>Enabled</b> by default.

<b>DCU IP Prefetcher</b>	Enables or disables the Data Cache Unit (DCU) IP prefetcher. This option is set to <b>Enabled</b> by default.
<b>Execute Disable</b>	Enables you to run the disable memory protection technology. This option is set to <b>Enabled</b> by default.
<b>Logical Processor Idling</b>	Enables you to improve the energy efficiency of a system. It uses the operating system core parking algorithm and parks some of the logical processors in the system which in turn allows the corresponding processor cores to transition into a lower power idle state. This option can only be enabled if the operating system supports it. It is set to <b>Disabled</b> by default.
<b>Configurable TDP</b>	Enables you to reconfigure the processor Thermal Design Power (TDP) levels during POST based on the power and thermal delivery capabilities of the system. TDP verifies the maximum heat the cooling system is needed to dissipate. This option is set to <b>Nominal</b> by default.   <b>NOTE:</b> This option is only available on certain stock keeping units (SKUs) of the processors.
<b>X2Apic Mode</b>	Enables or disables the X2Apic mode.
<b>Dell Controlled Turbo</b>	Controls the turbo engagement. Enable this option only when <b>System Profile</b> is set to <b>Performance</b> .   <b>NOTE:</b> Depending on the number of installed CPUs, there may be up to four processor listings.
<b>Number of Cores per Processor</b>	Controls the number of enabled cores in each processor. This option is set to <b>All</b> by default.
<b>Processor 64-bit Support</b>	Specifies if the processor(s) support 64-bit extensions.
<b>Processor Core Speed</b>	Specifies the maximum core frequency of the processor.
<b>Processor 1</b>	 <b>NOTE:</b> Depending on the number of CPUs, there may be up to four processors listed.  The following settings are displayed for each processor installed in the system:
<b>Family-Model-Stepping</b>	Specifies the family, model, and stepping of the processor as defined by Intel.
<b>Brand</b>	Specifies the brand name.
<b>Level 2 Cache</b>	Specifies the total L2 cache.
<b>Level 3 Cache</b>	Specifies the total L3 cache.
<b>Number of Cores</b>	Specifies the number of cores per processor.

## SATA Settings details

The **SATA Settings** screen details are explained as follows:

<b>Embedded SATA</b>	Enables the embedded SATA option to be set to <b>Off</b> , <b>ATA</b> , <b>AHCI</b> , or <b>RAID</b> modes. This option is set to <b>AHCI</b> by default.
----------------------	---



<b>Security Freeze Lock</b>	Sends Security Freeze Lock command to the Embedded SATA drives during POST. This option is applicable only for ATA and AHCI modes.						
<b>Write Cache</b>	Enables or disables the command for Embedded SATA drives during POST.						
<b>Port A</b>	<p>Sets the drive type of the selected device. For <b>Embedded SATA settings</b> in <b>ATA</b> mode, set this field to <b>Auto</b> to enable BIOS support. Set it to <b>OFF</b> to turn off BIOS support.</p> <p>For <b>AHCI</b> or <b>RAID</b> mode, BIOS support is always enabled.</p> <table border="0" style="margin-left: 20px;"> <tr> <td style="vertical-align: top;"><b>Model</b></td> <td>Specifies the drive model of the selected device.</td> </tr> <tr> <td style="vertical-align: top;"><b>Drive Type</b></td> <td>Specifies the type of drive attached to the SATA port.</td> </tr> <tr> <td style="vertical-align: top;"><b>Capacity</b></td> <td>Specifies the total capacity of the hard drive. This field is undefined for removable media devices such as optical drives.</td> </tr> </table>	<b>Model</b>	Specifies the drive model of the selected device.	<b>Drive Type</b>	Specifies the type of drive attached to the SATA port.	<b>Capacity</b>	Specifies the total capacity of the hard drive. This field is undefined for removable media devices such as optical drives.
<b>Model</b>	Specifies the drive model of the selected device.						
<b>Drive Type</b>	Specifies the type of drive attached to the SATA port.						
<b>Capacity</b>	Specifies the total capacity of the hard drive. This field is undefined for removable media devices such as optical drives.						
<b>Port B</b>	<p>Sets the drive type of the selected device. For <b>Embedded SATA settings</b> in <b>ATA</b> mode, set this field to <b>Auto</b> to enable BIOS support. Set it to <b>OFF</b> to turn off BIOS support.</p> <p>For <b>AHCI</b> or <b>RAID</b> mode, BIOS support is always enabled.</p> <table border="0" style="margin-left: 20px;"> <tr> <td style="vertical-align: top;"><b>Model</b></td> <td>Specifies the drive model of the selected device.</td> </tr> <tr> <td style="vertical-align: top;"><b>Drive Type</b></td> <td>Specifies the type of drive attached to the SATA port.</td> </tr> <tr> <td style="vertical-align: top;"><b>Capacity</b></td> <td>Specifies the total capacity of the hard drive. This field is undefined for removable media devices such as optical drives.</td> </tr> </table>	<b>Model</b>	Specifies the drive model of the selected device.	<b>Drive Type</b>	Specifies the type of drive attached to the SATA port.	<b>Capacity</b>	Specifies the total capacity of the hard drive. This field is undefined for removable media devices such as optical drives.
<b>Model</b>	Specifies the drive model of the selected device.						
<b>Drive Type</b>	Specifies the type of drive attached to the SATA port.						
<b>Capacity</b>	Specifies the total capacity of the hard drive. This field is undefined for removable media devices such as optical drives.						
<b>Port C</b>	<p>Sets the drive type of the selected device. For <b>Embedded SATA settings</b> in <b>ATA</b> mode, set this field to <b>Auto</b> to enable BIOS support. Set it to <b>OFF</b> to turn off BIOS support.</p> <p>For <b>AHCI</b> or <b>RAID</b> mode, BIOS support is always enabled.</p> <table border="0" style="margin-left: 20px;"> <tr> <td style="vertical-align: top;"><b>Model</b></td> <td>Specifies the drive model of the selected device.</td> </tr> <tr> <td style="vertical-align: top;"><b>Drive Type</b></td> <td>Specifies the type of drive attached to the SATA port.</td> </tr> <tr> <td style="vertical-align: top;"><b>Capacity</b></td> <td>Specifies the total capacity of the hard drive. This field is undefined for removable media devices such as optical drives.</td> </tr> </table>	<b>Model</b>	Specifies the drive model of the selected device.	<b>Drive Type</b>	Specifies the type of drive attached to the SATA port.	<b>Capacity</b>	Specifies the total capacity of the hard drive. This field is undefined for removable media devices such as optical drives.
<b>Model</b>	Specifies the drive model of the selected device.						
<b>Drive Type</b>	Specifies the type of drive attached to the SATA port.						
<b>Capacity</b>	Specifies the total capacity of the hard drive. This field is undefined for removable media devices such as optical drives.						
<b>Port D</b>	<p>Sets the drive type of the selected device. For <b>Embedded SATA settings</b> in <b>ATA</b> mode, set this field to <b>Auto</b> to enable BIOS support. Set it to <b>OFF</b> to turn off BIOS support.</p> <p>For <b>AHCI</b> or <b>RAID</b> mode, BIOS support is always enabled.</p>						
<b>Port E</b>	<p>Sets the drive type of the selected device. For <b>Embedded SATA settings</b> in <b>ATA</b> mode, set this field to <b>Auto</b> to enable BIOS support. Set it to <b>OFF</b> to turn off BIOS support.</p> <p>For <b>AHCI</b> or <b>RAID</b> mode, BIOS support is always enabled.</p>						

**Port F** Sets the drive type of the selected device. For **Embedded SATA settings** in **ATA** mode, set this field to **Auto** to enable BIOS support. Set it to **OFF** to turn off BIOS support.  
For **AHCI** or **RAID** mode, BIOS support is always enabled.

**Port G** Sets the drive type of the selected device. For **Embedded SATA settings** in **ATA** mode, set this field to **Auto** to enable BIOS support. Set it to **OFF** to turn off BIOS support.  
For **AHCI** or **RAID** mode, BIOS support is always enabled.

<b>Model</b>	Specifies the drive model of the selected device.
<b>Drive Type</b>	Specifies the type of drive attached to the SATA port.
<b>Capacity</b>	Specifies the total capacity of the hard drive. This field is undefined for removable media devices such as optical drives.

**Port H** Sets the drive type of the selected device. For **Embedded SATA settings** in **ATA** mode, set this field to **Auto** to enable BIOS support. Set it to **OFF** to turn off BIOS support.  
For **AHCI** or **RAID** mode, BIOS support is always enabled.

<b>Model</b>	Specifies the drive model of the selected device.
<b>Drive Type</b>	Specifies the type of drive attached to the SATA port.
<b>Capacity</b>	Specifies the total capacity of the hard drive. This field is undefined for removable media devices such as optical drives.

**Port I** Sets the drive type of the selected device. For **Embedded SATA settings** in **ATA** mode, set this field to **Auto** to enable BIOS support. Set it to **OFF** to turn off BIOS support.  
For **AHCI** or **RAID** mode, BIOS support is always enabled.

<b>Model</b>	Specifies the drive model of the selected device.
<b>Drive Type</b>	Specifies the type of drive attached to the SATA port.
<b>Capacity</b>	Specifies the total capacity of the hard drive. This field is undefined for removable media devices such as optical drives.





**Port J** Sets the drive type of the selected device. For **Embedded SATA settings** in **ATA** mode, set this field to **Auto** to enable BIOS support. Set it to **OFF** to turn off BIOS support.  
For **AHCI** or **RAID** mode, BIOS support is always enabled.

<b>Model</b>	Specifies the drive model of the selected device.
<b>Drive Type</b>	Specifies the type of drive attached to the SATA port.

**Capacity** Specifies the total capacity of the hard drive. This field is undefined for removable media devices such as optical drives.

## Boot Settings details

The **Boot Settings** screen details are explained as follows:

- Boot Mode** Enables you to set the boot mode of the system.
-  **CAUTION: Switching the boot mode may prevent the system from booting if the operating system is not installed in the same boot mode.**
- If the operating system supports UEFI, you can set this option to **UEFI**. Setting this field to **BIOS** allows compatibility with non-UEFI operating systems. This option is set to **BIOS** by default.
-  **NOTE:** Setting this field to **UEFI** disables the **BIOS Boot Settings** menu. Setting this field to **BIOS** disables the **UEFI Boot Settings** menu.
- Boot Sequence Retry** Enables or disables the Boot Sequence Retry feature. If this option is set to **Enabled** and the system fails to boot, the system reattempts the boot sequence after 30 seconds. This option is set to **Enabled** by default.
- Hard-Disk Failover** Specifies the hard drive that is booted in the event of a hard drive failure. The devices are selected in the **Hard-Disk Drive Sequence** on the **Boot Option Setting** menu. When this option is set to **Disabled**, only the first hard drive in the list is attempted to boot. When this option is set to **Enabled**, all hard drives are attempted to boot in the order selected in the **Hard-Disk Drive Sequence**. This option is not enabled for UEFI Boot Mode.
- Boot Option Settings** Configures the boot sequence and the boot devices.
- BIOS Boot Settings** Enables or disables BIOS boot options.
-  **NOTE:** This option is enabled only if the boot mode is BIOS.
- UEFI Boot Settings** Enables or disables UEFI Boot options. The Boot options include **IPv4 PXE** and **IPv6 PXE**. This option is set to **IPv4** by default.
-  **NOTE:** This option is enabled only if the boot mode is UEFI.



## Network Settings screen details

The **Network Settings** screen details are explained as follows:

- PXE Device n (n = 1 to 4)** Enables or disables the device. When enabled, a UEFI boot option is created for the device.
- PXE Device n Settings (n = 1 to 4)** Enables you to control the configuration of the PXE device.





## Integrated Devices details

The **Integrated Devices** screen details are explained as follows:

<b>USB 3.0 Setting</b>	Enables or disables the USB 3.0 support. Enable this option only if your operating system supports USB 3.0. If you disable this option, devices operate at USB 2.0 speed. USB 3.0 is enabled by default.
<b>User Accessible USB Ports</b>	Enables or disables the USB ports. Selecting <b>Only Back Ports On</b> disables the front USB ports, selecting <b>All Ports Off</b> disables all USB ports. The USB keyboard and mouse operate during boot process in certain operating systems. After the boot process is complete, the USB keyboard and mouse do not work if the ports are disabled.   <b>NOTE:</b> Selecting <b>Only Back Ports On</b> and <b>All Ports Off</b> disables the USB management port and also restricts access to iDRAC features.
<b>Internal USB Port</b>	Enables or disables the internal USB port. This option is set to <b>Enabled</b> by default.
<b>Integrated RAID Controller</b>	Enables or disables the integrated RAID controller. This option is set to <b>Enabled</b> by default.
<b>Integrated Network Card 1</b>	Enables or disables the integrated network card.
<b>Embedded NIC1 and NIC2</b>	 <b>NOTE:</b> The Embedded NIC1 and NIC2 options are only available on systems that do not have <b>Integrated Network Card 1</b> .  Enables or disables the Embedded NIC1 and NIC2 options. If set to <b>Disabled</b> , the NIC may still be available for shared network access by the embedded management controller. The embedded NIC1 and NIC2 options are only available on systems that do not have Network Daughter Cards (NDCs). The Embedded NIC1 and NIC2 option is mutually exclusive with the Integrated Network Card 1 option. Configure the Embedded NIC1 and NIC2 option by using the NIC management utilities of the system.
<b>I/OAT DMA Engine</b>	Enables or disables the I/OAT option. Enable only if the hardware and software support the feature.
<b>Embedded Video Controller</b>	Enables or disables the <b>Embedded Video Controller</b> option. This option is set to <b>Enabled</b> by default.
<b>Current State of Embedded Video Controller</b>	Displays the current state of the embedded video controller. The <b>Current State of Embedded Video Controller</b> option is a read-only field. If the Embedded Video Controller is the only display capability in the system (that is, no add-in graphics card is installed), then the Embedded Video Controller is automatically used as the primary display even if the <b>Embedded Video Controller</b> setting is set to <b>Disabled</b> .
<b>SR-IOV Global Enable</b>	Enables or disables the BIOS configuration of Single Root I/O Virtualization (SR-IOV) devices. This option is set to <b>Enabled</b> by default.
<b>OS Watchdog Timer</b>	If your system stops responding, this watchdog timer aids in the recovery of your operating system. When this option is set to <b>Enabled</b> , the operating system initializes the timer. When this option is set to <b>Disabled</b> (the default), the timer does not have any effect on the system.
<b>Memory Mapped I/O above 4 GB</b>	Enables or disables the support for PCIe devices that need large amounts of memory. This option is set to <b>Enabled</b> by default.
<b>Slot Disablement</b>	Enables or disables the available PCIe slots on your system. The slot disablement feature controls the configuration of PCIe cards installed in the specified slot. Slots must be disabled only when the installed peripheral card prevents booting into the operating system or causes delays in system startup. If the slot is disabled, both the Option ROM and UEFI drivers are disabled.

## Serial Communication details



The **Serial Communication** screen details are explained as follows:

<b>Serial Communication</b>	Selects serial communication devices (Serial Device 1 and Serial Device 2) in BIOS. BIOS console redirection can also be enabled and the port address can be specified. This option is set to <b>Auto</b> by default.
<b>Serial Port Address</b>	<p>Enables you to set the port address for serial devices. This option is set to <b>Serial Device 1=COM2, Serial Device 2=COM1</b> by default.</p> <p> <b>NOTE:</b> You can use only Serial Device 2 for the Serial Over LAN (SOL) feature. To use console redirection by SOL, configure the same port address for console redirection and the serial device.</p> <p> <b>NOTE:</b> Every time the system boots, the BIOS syncs the serial MUX setting saved in iDRAC. The serial MUX setting can independently be changed in iDRAC. Loading the BIOS default settings from within the BIOS setup utility may not always revert the serial MUX setting to the default setting of Serial Device 1.</p>
<b>External Serial Connector</b>	<p>Enables you to associate the External Serial Connector to Serial Device 1, Serial Device 2, or the Remote Access Device by using this option.</p> <p> <b>NOTE:</b> Only Serial Device 2 can be used for Serial Over LAN (SOL). To use console redirection by SOL, configure the same port address for console redirection and the serial device.</p> <p> <b>NOTE:</b> Every time the system boots, the BIOS syncs the serial MUX setting saved in iDRAC. The serial MUX setting can independently be changed in iDRAC. Loading the BIOS default settings from within the BIOS setup utility may not always revert this setting to the default setting of Serial Device 1.</p>
<b>Failsafe Baud Rate</b>	Specifies the failsafe baud rate for console redirection. The BIOS attempts to determine the baud rate automatically. This failsafe baud rate is used only if the attempt fails, and the value must not be changed. This option is set to 115200 by default.
<b>Remote Terminal Type</b>	Sets the remote console terminal type. This option is set to <b>VT 100/VT 220</b> by default.
<b>Redirection After Boot</b>	Enables or disables the BIOS console redirection when the operating system is loaded. This option is set to <b>Enabled</b> by default.

## System Profile Settings details



The **System Profile Settings** screen details are explained as follows:

<b>System Profile</b>	<p>Sets the system profile. If you set the <b>System Profile</b> option to a mode other than <b>Custom</b>, the BIOS automatically sets the rest of the options. You can only change the rest of the options if the mode is set to <b>Custom</b>. This option is set to <b>Performance Per Watt Optimized (DAPC)</b> by default. DAPC is Dell Active Power Controller.</p> <p> <b>NOTE:</b> All the parameters on the system profile setting screen are available only when the <b>System Profile</b> option is set to <b>Custom</b>.</p>
-----------------------	--

<b>CPU Power Management</b>	Sets the CPU power management. This option is set to <b>System DBPM (DAPC)</b> by default. DBPM is Demand-Based Power Management.
<b>Memory Frequency</b>	Sets the speed of the system memory. You can select <b>Maximum Performance</b> , <b>Maximum Reliability</b> , or a specific speed.
<b>Turbo Boost</b>	Enables or disables the processor to operate in the turbo boost mode. This option is set to <b>Enabled</b> by default.
<b>Energy Efficient Turbo</b>	Enables or disables the <b>Energy Efficient Turbo</b> option. Energy Efficient Turbo (EET) is a mode of operation where a processor's core frequency is adjusted to be within the turbo range based on workload.
<b>C1E</b>	Enables or disables the processor to switch to a minimum performance state when it is idle. This option is set to <b>Enabled</b> by default.
<b>C States</b>	Enables or disables the processor to operate in all available power states. This option is set to <b>Enabled</b> by default.
<b>Collaborative CPU Performance Control</b>	Enables or disables the CPU power management option. When set to <b>Enabled</b> , the CPU power management is controlled by the OS DBPM and the System DBPM (DAPC). This option is set to <b>Disabled</b> by default.
<b>Memory Patrol Scrub</b>	Sets the memory patrol scrub frequency. This option is set to <b>Standard</b> by default.
<b>Memory Refresh Rate</b>	Sets the memory refresh rate to either 1x or 2x. This option is set to <b>1x</b> by default.
<b>Uncore Frequency</b>	Enables you to select the <b>Processor Uncore Frequency</b> option. Dynamic mode enables the processor to optimize power resources across the cores and uncore during runtime. The optimization of the uncore frequency to either save power or optimize performance is influenced by the setting of the <b>Energy Efficiency Policy</b> option.
<b>Energy Efficient Policy</b>	Enables you to select the <b>Energy Efficient Policy</b> option. The CPU uses the setting to manipulate the internal behavior of the processor and determines whether to target higher performance or better power savings.
<b>Number of Turbo Boot Enabled Cores for Processor 1</b>	 <b>NOTE:</b> If there are two processors installed in the system, you see an entry for <b>Number of Turbo Boost Enabled Cores for Processor 2</b> . Controls the number of turbo boost enabled cores for processor 1. The maximum number of cores is enabled by default.
<b>Monitor/Mwait</b>	Enables the Monitor/Mwait instructions in the processor. This option is set to <b>Enabled</b> for all system profiles, except <b>Custom</b> by default.  <b>NOTE:</b> This option can be disabled only if the <b>C States</b> option in the <b>Custom</b> mode is set to <b>disabled</b> .  <b>NOTE:</b> When <b>C States</b> is set to <b>Enabled</b> in the <b>Custom</b> mode, changing the Monitor/Mwait setting does not impact the system power or performance.

## System Security Settings details



The **System Security Settings** screen details are explained as follows:

<b>Intel AES-NI</b>	Improves the speed of applications by performing encryption and decryption by using the Advanced Encryption Standard Instruction Set (AES-NI). This option is set to <b>Enabled</b> by default.
<b>System Password</b>	Sets the system password. This option is set to <b>Enabled</b> by default and is read-only if the password jumper is not installed in the system.
<b>Setup Password</b>	Sets the setup password. This option is read-only if the password jumper is not installed in the system.
<b>Password Status</b>	Locks the system password. This option is set to <b>Unlocked</b> by default.
<b>TPM Security</b>	 <b>NOTE:</b> The TPM menu is available only when the TPM module is installed. Enables you to control the reporting mode of the TPM. The <b>TPM Security</b> option is set to <b>Off</b> by default. You can only modify the TPM Status, TPM Activation, and Intel TXT fields if the <b>TPM Status</b> field is set to either <b>On with Pre-boot Measurements</b> or <b>On without Pre-boot Measurements</b> .
<b>TPM Information</b>	Changes the operational state of the TPM. This option is set to <b>No Change</b> by default.
<b>TPM Status</b>	Specifies the TPM status.
<b>TPM Command</b>	 <b>CAUTION:</b> Clearing the TPM results in the loss of all keys in the TPM. The loss of TPM keys may affect booting to the operating system. Clears all the contents of the TPM. The <b>TPM Clear</b> option is set to <b>No</b> by default.
<b>Intel TXT</b>	Enables or disables the Intel Trusted Execution Technology (TXT) option. To enable the <b>Intel TXT</b> option, virtualization technology and TPM Security must be enabled with Pre-boot measurements. This option is set to <b>Off</b> by default.
<b>Power Button</b>	Enables or disables the power button on the front of the system. This option is set to <b>Enabled</b> by default.
<b>NMI Button</b>	Enables or disables the NMI button on the front of the system. This option is set to <b>Disabled</b> by default.
<b>AC Power Recovery</b>	Sets how the system behaves after AC power is restored to the system. This option is set to <b>Last</b> by default.
<b>AC Power Recovery Delay</b>	Sets the time delay for the system to power up after AC power is restored to the system. This option is set to <b>Immediate</b> by default.
<b>User Defined Delay (60s to 240s)</b>	Sets the <b>User Defined Delay</b> option when the <b>User Defined</b> option for <b>AC Power Recovery Delay</b> is selected.
<b>UEFI Variable Access</b>	Provides varying degrees of securing UEFI variables. When set to <b>Standard</b> (the default), UEFI variables are accessible in the operating system per the UEFI specification. When set to <b>Controlled</b> , selected UEFI variables are protected in the environment and new UEFI boot entries are forced to be at the end of the current boot order.
<b>Secure Boot</b>	Enables Secure Boot, where the BIOS authenticates each pre-boot image by using the certificates in the Secure Boot Policy. Secure Boot is disabled by default.
<b>Secure Boot Policy</b>	When Secure Boot policy is set to <b>Standard</b> , the BIOS uses the system manufacturer's key and certificates to authenticate pre-boot images. When Secure Boot policy is set to <b>Custom</b> , the BIOS uses the user-defined key and certificates. Secure Boot policy is set to <b>Standard</b> by default.

**Secure Boot Policy Summary** Specifies the list of certificates and hashes that secure boot uses to authenticate images.

## Miscellaneous Settings details

The **Miscellaneous Settings** screen details are explained as follows:

<b>System Time</b>	Enables you to set the time on the system.
<b>System Date</b>	Enables you to set the date on the system.
<b>Asset Tag</b>	Specifies the asset tag and enables you to modify it for security and tracking purposes.
<b>Keyboard NumLock</b>	Enables you to set whether the system boots with the NumLock enabled or disabled. This option is set to <b>On</b> by default.  <b>NOTE:</b> This option does not apply to 84-key keyboards.
<b>F1/F2 Prompt on Error</b>	Enables or disables the F1/F2 prompt on error. This option is set to <b>Enabled</b> by default. The F1/F2 prompt also includes keyboard errors.
<b>Load Legacy Video Option ROM</b>	Enables you to determine whether the system BIOS loads the legacy video (INT 10H) option ROM from the video controller. Selecting <b>Enabled</b> in the operating system does not support UEFI video output standards. This field is available only for UEFI boot mode. You cannot set the option to <b>Enabled</b> if <b>UEFI Secure Boot</b> mode is enabled.
<b>In-System Characterization</b>	Enables or disables <b>In-System Characterization</b> . This option is set to <b>Disabled</b> by default. The two other options are <b>Enabled</b> and <b>Enabled - No Reboot</b> .  <b>NOTE:</b> The default setting for <b>In-System Characterization</b> is subject to change in future BIOS releases.  When enabled, In-System Characterization (ISC) executes during POST upon detecting relevant change(s) in system configuration to optimize system power and performance. ISC takes about 20 seconds to execute, and system reset is needed for ISC results to be applied. The <b>Enabled - No Reboot</b> option executes ISC and continues without applying ISC results until the next time system reset occurs. The <b>Enabled</b> option executes ISC and forces an immediate system reset so that ISC results can be applied. It takes the system longer to be ready due to the forced system reset. When disabled, ISC does not execute.

## System setup options at boot

F2	Initiate Setup during POST
Alt+F	Load optimal default properties in Setup menu.



# About Boot Manager

Boot manager enables you to add, delete, and arrange boot options. You can also access System Setup and boot options without restarting the system.

## Viewing Boot Manager

To enter **Boot Manager**:

1. Turn on, or restart your system.
2. Press F11 when you see the following message:

F11 = Boot Manager

If your operating system begins to load before you press F11, allow the system to complete the booting, and then restart your system and try again.

## Boot Manager main menu

<b>Continue Normal Boot</b>	The system attempts to boot to devices starting with the first item in the boot order. If the boot attempt fails, the system continues with the next item in the boot order until the boot is successful or no more boot options are found.
<b>One Shot Boot Menu</b>	Displays the boot menu where you can select a one time boot device to boot from.
<b>Launch System Setup</b>	Allows you to access the System Setup.
<b>Launch Lifecycle Controller</b>	Closes the Boot Manager and invokes the Dell Lifecycle Controller program.
<b>System Utilities</b>	Opens system utilities menu such as system diagnostics and UEFI shell.

## Changing the boot order

You may have to change the boot order if you want to boot from a USB key or an optical drive. The following instructions may vary if you have selected **BIOS** for **Boot Mode**.

1. On the **System Setup Main Menu** screen, click **System BIOS** → **Boot Settings**.
2. Click **Boot Option Settings** → **Boot Sequence**.
3. Use the arrow keys to select a boot device, and use the plus (+) and minus (-) sign keys to move the device down or up in the order.
4. Click **Exit**, and then click **Yes** to save the settings on exit.

## Choosing the system boot mode

System Setup enables you to specify one of the following boot modes for installing your operating system:

- BIOS boot mode (the default) is the standard BIOS-level boot interface.
- Unified Extensible Firmware Interface (UEFI) boot mode is an enhanced 64-bit boot interface. If you have configured your system to boot to UEFI mode, it replaces the system BIOS.

1. From the **System Setup Main Menu**, click **Boot Settings**, and select **Boot Mode**.
2. Select the boot mode you want the system to boot into.

 **CAUTION: Switching the boot mode may prevent the system from booting if the operating system is not installed in the same boot mode.**

3. After the system boots in the specified boot mode, proceed to install your operating system from that mode.

 **NOTE:** Operating systems must be UEFI-compatible to be installed from the UEFI boot mode. DOS and 32-bit operating systems do not support UEFI and can only be installed from the BIOS boot mode.

 **NOTE:** For the latest information about supported operating systems, go to [Dell.com/ossupport](http://Dell.com/ossupport).

## Assigning a system and setup password

 **NOTE:** The password jumper enables or disables the System Password and Setup Password features. For more information about the password jumper settings, see [Dell XC6320 system board connectors](#).

You can assign a new **System Password** and **Setup Password** or change an existing **System Password** and **Setup Password** only when the password jumper setting is **Enabled** and **Password Status** is **Unlocked**. If the password jumper setting is disabled, the existing **System Password** and **Setup Password** are deleted and you need not provide the system password to boot the system.

1. To enter System Setup, press F2 immediately after a power-on or reboot.
2. From the **System Setup Main Menu**, select **System BIOS** and press Enter.
3. On the **System BIOS** screen, select **System Security** and press Enter.
4. On the **System Security** screen, ensure that password status is unlocked.
5. Select **System Password**, enter your system password, and press Enter or Tab.

Use the following guidelines to assign the system password:

- A password can have up to 32 characters.
- The password can contain the numbers 0 through 9.
- Only the following special characters are allowed: space, ("), (+), (.), (-), (.), (/), (:), (I), (\), (l), (').

A message prompts you to re-enter the system password.

6. Re-enter the system password, and then click **OK**.
7. Select **Setup Password**, enter your system password and press Enter or Tab.

A message prompts you to re-enter the setup password.

8. Re-enter the setup password, and click **OK**.
9. Press Esc to return to the System BIOS screen. Press Esc.

A message prompts you to save the changes.

 **NOTE:** Password protection does not take effect until the system reboots.

## Deleting or changing system and setup password







**NOTE:** You cannot delete or change an existing system or setup password if the **Password Status** is set to **Locked**.

1. To enter System Setup, press F2 immediately after turning on or restarting your system.
2. On the **System Setup Main Menu** screen, click **System BIOS** → **System Security**.
3. On the **System Security** screen, ensure that **Password Status** is set to **Unlocked**.
4. In the **System Password** field, alter or delete the existing system password, and then press Enter or Tab.
5. In the **Setup Password** field, alter or delete the existing setup password, and then press Enter or Tab.  
If you change the system and setup password, a message prompts you to reenter the new password.  
If you delete the system and setup password, a message prompts you to confirm the deletion.
6. Press Esc to return to the **System BIOS** screen. Press Esc again, and a message prompts you to save the changes.

# Installing and removing system components

## Safety instructions

-  **WARNING:** Whenever you lift the system, get others to assist you. To avoid injury, do not attempt to lift the system by yourself.
-  **WARNING:** Working on systems that are still connected to a PSU can be dangerous.
-  **CAUTION:** This system must be operated with the system cover installed to ensure proper cooling.
-  **CAUTION:** System components and electronic circuit boards can be damaged by discharge of static electricity.
-  **CAUTION:** Many repairs may only be done by a certified service technician. You should only perform troubleshooting and simple repairs as authorized in your product documentation, or as directed by the online or telephone service and support team. Damage due to servicing that is not authorized by Dell is not covered by your warranty. Read and follow the safety instructions that are shipped with your product.

To avoid injury to yourself or damage to the system, follow these guidelines:

- Always disconnect the system from the power outlet whenever you are working inside the system.
- If possible, wear a grounded wrist strap as you work inside the system. Or discharge any static electricity by touching the bare metal chassis of system case, or the bare metal body of any other grounded appliance.
- Hold electronic circuit boards by the edges only. Do not touch the components on the board unless it is necessary to do so. Do not flex or stress the circuit board.
- Leave all components inside the static-proof packaging until you are ready to use the component for the installation.

## Recommended tools

- #1 Phillips screwdriver
- #2 Phillips screwdriver
- Torx #T20 screwdriver

## Opening and closing the system

**△ CAUTION:** Many repairs may only be done by a certified service technician. You should only perform troubleshooting and simple repairs as authorized in your product documentation, or as directed by the online or telephone service and support team. Damage due to servicing that is not authorized by Dell is not covered by your warranty. Read and follow the safety instructions that are shipped with your product.

### Removing the system cover

**△ CAUTION:** Many repairs may only be done by a certified service technician. You should only perform troubleshooting and simple repairs as authorized in your product documentation, or as directed by the online or telephone service and support team. Damage due to servicing that is not authorized by Dell is not covered by your warranty. Read and follow the safety instructions that are shipped with your product.

1. Follow the safety guidelines listed in the Safety instructions section.
  2. Turn off the system, including any attached peripherals.
  3. Disconnect the system from the electrical outlet and disconnect the peripherals.
- 
1. Remove the securing screw from the system cover.
  2. Press the cover release latch lock.
  3. Hold the system cover on both the sides with your palm on the traction pad, and slide out the system cover.
  4. Lift the cover away from the system.

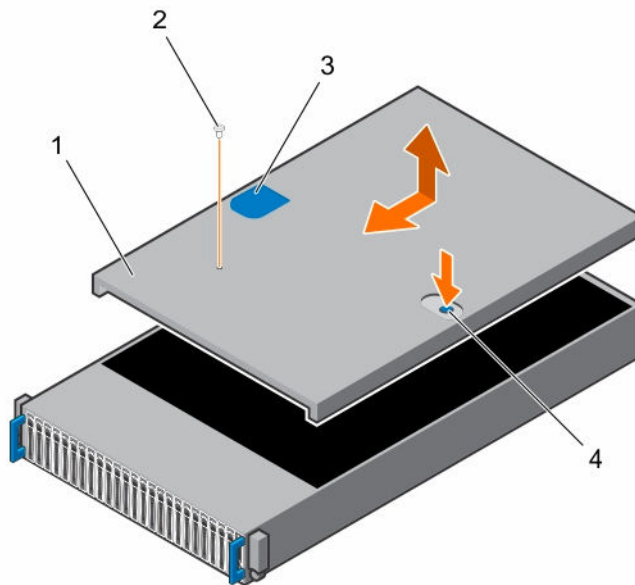

**Figure 9. Opening and closing the system**

- |                 |                             |
|-----------------|-----------------------------|
| 1. system cover | 2. securing screw           |
| 3. traction pad | 4. cover release latch lock |

Install the system cover.

## Installing the system cover

-  **CAUTION:** Many repairs may only be done by a certified service technician. You should only perform troubleshooting and simple repairs as authorized in your product documentation, or as directed by the online or telephone service and support team. Damage due to servicing that is not authorized by Dell is not covered by your warranty. Read and follow the safety instructions that are shipped with your product.

Follow the safety guidelines listed in the Safety instructions section.

1. Place the system cover on the chassis and slide it to the front of the chassis until it snaps into place.
2. Secure the cover with the securing screw.
1. Reconnect the system to the electrical outlet.
2. Turn on the system, including any attached peripherals.

## Inside the system

-  **CAUTION:** Many repairs may only be done by a certified service technician. You should only perform troubleshooting and simple repairs as authorized in your product documentation, or as directed by the online or telephone service and support team. Damage due to servicing that is not authorized by Dell is not covered by your warranty. Read and follow the safety instructions that are shipped with your product.

-  **CAUTION:** This system must be operated with the system cover installed to ensure proper cooling.

## Cooling fans

Servers use a lot of power to function, and that in turn generates a lot of heat. That heat, without a system in place to dissipate it, can destroy the mechanical parts and damage the server. In most cases, the simplest and most efficient way to dissipate this heat is through the use of fans.

### Removing a cooling fan

-  **WARNING:** Do not attempt to operate the system without the cooling fans.

-  **WARNING:** The cooling fan can continue to spin for some time after the system has been powered down. Allow time for the fan to stop spinning before removing it from the system.

-  **CAUTION:** Many repairs may only be done by a certified service technician. You should only perform troubleshooting and simple repairs as authorized in your product documentation, or as directed by the online or telephone service and support team. Damage due to servicing that is not authorized by Dell is not covered by your warranty. Read and follow the safety instructions that are shipped with your product.

-  **NOTE:** Observe the routing of the cable through the cable tie as you remove them from the system. You must route these cables properly when you replace them to prevent the cables from being pinched or crimped.

1. Follow the safety guidelines listed in the Safety instructions section.

2. Follow the procedure listed in the Before working inside your system section.
1. Disconnect the fan's power cable from the power distribution board 1.
2. Lift the cooling fan cage out of the chassis.

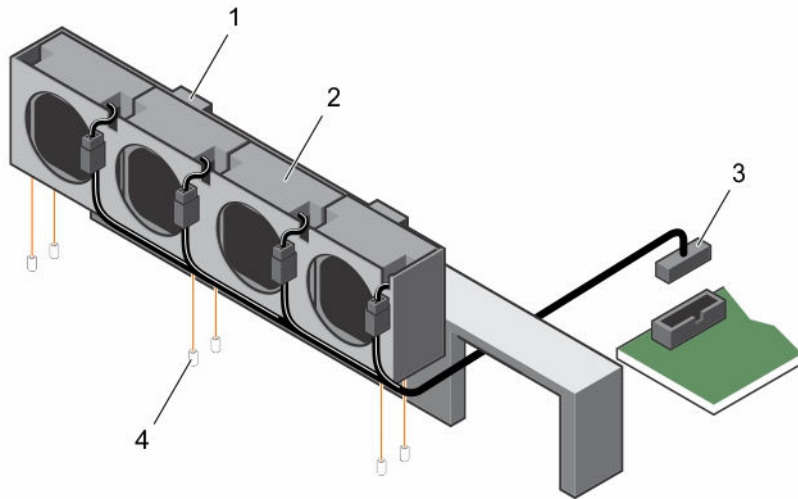

**Figure 10. Removing and installing a cooling fan cage**

- |                      |                     |
|----------------------|---------------------|
| 1. locking clips (2) | 2. cooling fan cage |
| 3. power connector   | 4. locating pin (6) |
3. Disconnect the fan cable from the fan connector on the cooling fan cage.
  4. Lift the cooling fan with the sponge out of the cooling fan cage.

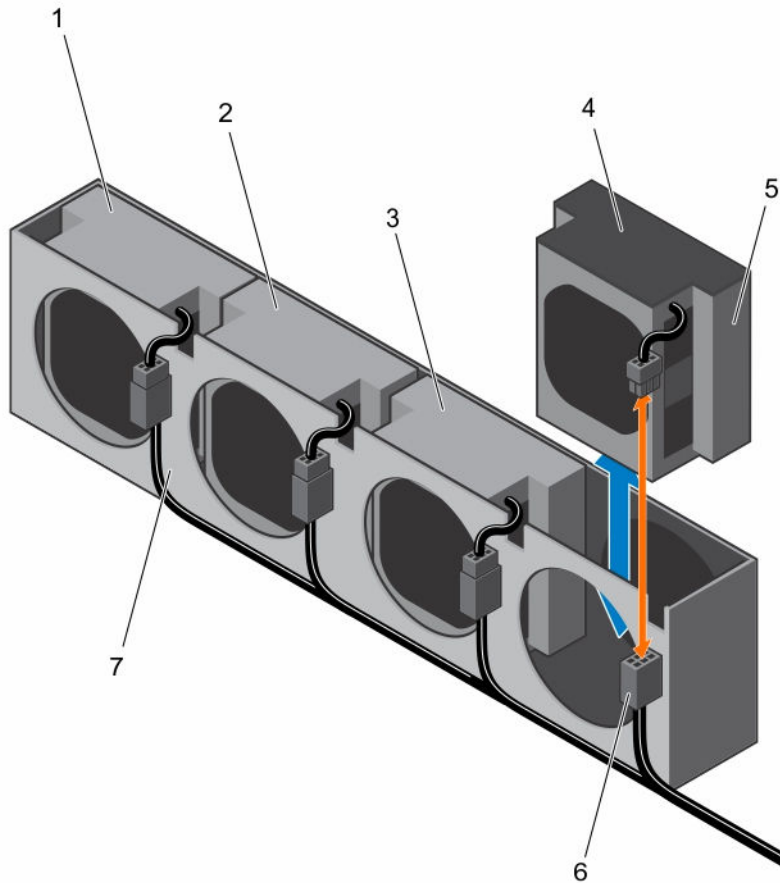

**Figure 11. Removing and installing a cooling fan**

- |                     |                  |
|---------------------|------------------|
| 1. cooling fan 1    | 2. cooling fan 2 |
| 3. cooling fan 3    | 4. sponge        |
| 5. cooling fan 4    | 6. fan cable     |
| 7. cooling fan cage |                  |

#### Related Links

[Removing the system cover](#)

### Installing a cooling fan

**⚠ CAUTION:** Many repairs may only be done by a certified service technician. You should only perform troubleshooting and simple repairs as authorized in your product documentation, or as directed by the online or telephone service and support team. Damage due to servicing that is not authorized by Dell is not covered by your warranty. Read and follow the safety instructions that are shipped with your product.

Follow the safety guidelines listed in the Safety instructions section.

1. Align the cooling fan with the sponge and slide it in the cooling-fan cage until the cooling fan is firmly seated.



 **NOTE:** The fan blades should face the control panel of the system.

2. Connect the fan cable to the connector on the cooling-fan cage.
  3. Align the cooling-fan cage with the locating pins on the chassis and place it into the chassis until it is firmly seated in place.
  4. Connect the fan's power cable to the connector on the power distribution board 1.  
You must route these cables properly through the ties to prevent them from being pinched or crimped.
1. Follow the procedure listed in the After working inside your system section.
  2. Check the management software to see if the fan is rotating at the optimal speed.

#### Related Links

[Installing the system cover](#)

## Hard drives

A hard drive is a data storage device used for storing and retrieving digital information by using one or more rigid rapidly rotating disks (platters) coated with magnetic material.

 **CAUTION:** Use only hard drives that have been tested and approved for use with the SAS/SATA backplane.

The following are the recommended guidelines for installing a mix of SAS hard drives, SATA hard drives, and SSDs:

- Only two drive types can be mixed per node.
- Drives 0 and 1 must be of same type.
- The remaining drives must all be the same type.
- SAS hard drive support is based on the add-on card and the onboard configuration supports SATA hard drive only.

### Removing a 2.5-inch hard drive blank

 **CAUTION:** Many repairs may only be done by a certified service technician. You should only perform troubleshooting and simple repairs as authorized in your product documentation, or as directed by the online or telephone service and support team. Damage due to servicing that is not authorized by Dell is not covered by your warranty. Read and follow the safety instructions that are shipped with your product.

 **CAUTION:** To maintain proper system cooling, all empty hard drive bays must have drive blanks installed.

 **NOTE:** This section is applicable to systems with hot swappable hard drives only.

Follow the safety guidelines listed in the Safety instructions section.

Pull the handle to remove the 2.5-inch hard drive blank out of the hard drive bay.

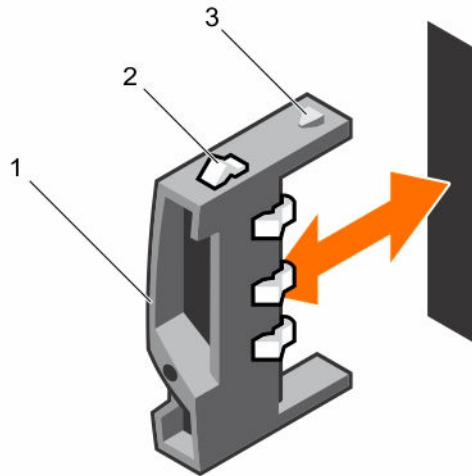

Figure 12. Removing or installing a 2.5-inch hard drive blank

1. handle
2. latch
3. 2.5-inch hard drive blank

## Installing a 2.5-inch hard drive blank

**△ CAUTION:** Many repairs may only be done by a certified service technician. You should only perform troubleshooting and simple repairs as authorized in your product documentation, or as directed by the online or telephone service and support team. Damage due to servicing that is not authorized by Dell is not covered by your warranty. Read and follow the safety instructions that are shipped with your product.

Follow the safety guidelines listed in the Safety instructions section.

1. With the latch facing up, slide the latch into the hard drive bay.
2. Push the 2.5-inch hard drive with a slight inclination into the hard drive bay until the hard drive blank is seated in place.

## Removing a hard drive

**△ CAUTION:** Many repairs may only be done by a certified service technician. You should only perform troubleshooting and simple repairs as authorized in your product documentation, or as directed by the online or telephone service and support team. Damage due to servicing that is not authorized by Dell is not covered by your warranty. Read and follow the safety instructions that are shipped with your product.

**△ CAUTION:** To maintain proper system cooling, all empty hard drive bays must have drive blanks installed.

Follow the safety guidelines listed in the Safety instructions section.

1. Turn the lock lever counterclockwise until it points to the unlock symbol.
2. Slide the release button to open the release handle.
3. Using the release handle, pull the hard drive carrier out of the hard drive bay.

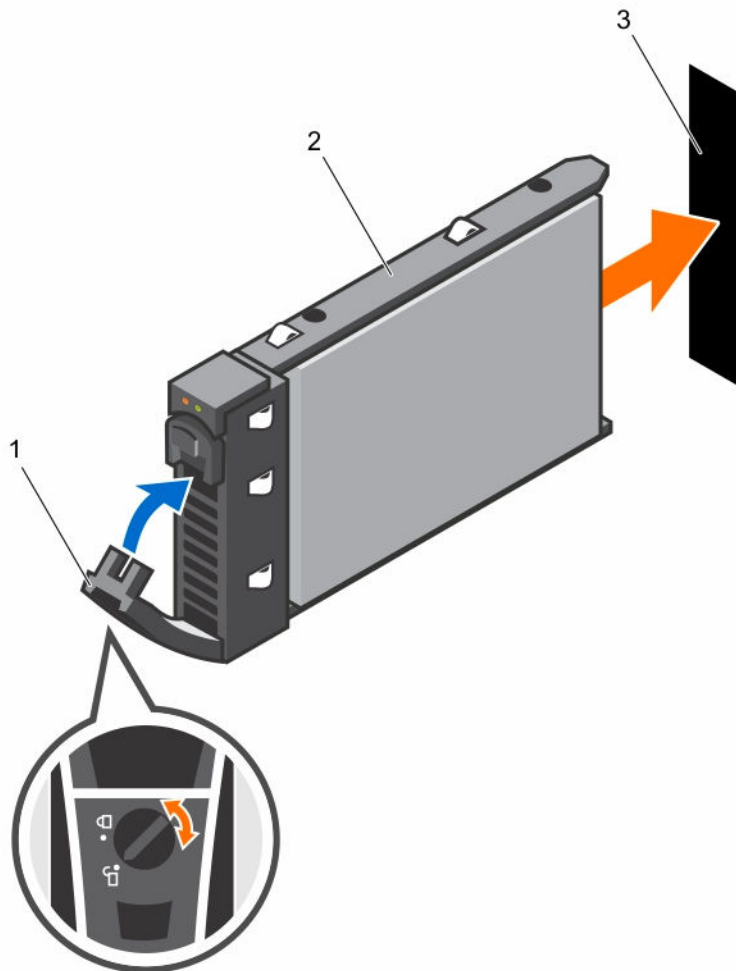

Figure 13. Removing and installing a hard drive

1. lock lever
2. hard driver carrier
3. hard drive slot

### Installing a hard drive

- ⚠ **CAUTION:** Many repairs may only be done by a certified service technician. You should only perform troubleshooting and simple repairs as authorized in your product documentation, or as directed by the online or telephone service and support team. Damage due to servicing that is not authorized by Dell is not covered by your warranty. Read and follow the safety instructions that are shipped with your product.
- ⚠ **CAUTION:** To maintain proper system cooling, all empty hard drive bays must have drive blanks installed.

Follow the safety guidelines listed in the Safety instructions section.

1. With the lever on the hard drive carrier open, slide the hard drive carrier into the drive bay until the hard drive connector engages with the backplane.
  2. Close the release handle to lock the hard drive in place.
  3. Turn the lock lever clockwise to the lock symbol.
1. To check the status of the hard drive, see the hard drive activity and status indicators. For more information, see the Hard drive indicator patterns section.
  2. Check the management software to verify the status of the installed hard drive.

## Removing a hard drive from a hard drive carrier

 **CAUTION:** Many repairs may only be done by a certified service technician. You should only perform troubleshooting and simple repairs as authorized in your product documentation, or as directed by the online or telephone service and support team. Damage due to servicing that is not authorized by Dell is not covered by your warranty. Read and follow the safety instructions that are shipped with your product.

 **CAUTION:** When installing a hard drive carrier, ensure that the adjacent drives are fully installed. Inserting a hard drive carrier and attempting to lock its handle next to a partially installed carrier can damage the partially installed carrier's shield spring and make it unusable.

 **CAUTION:** To prevent data loss, ensure that your operating system supports hot-swappable drive installation. See the documentation supplied with the operating system.

Follow the safety guidelines listed in the Safety instructions section.

1. Remove the screws.
2. Lift the hard drive out of the hard drive carrier.

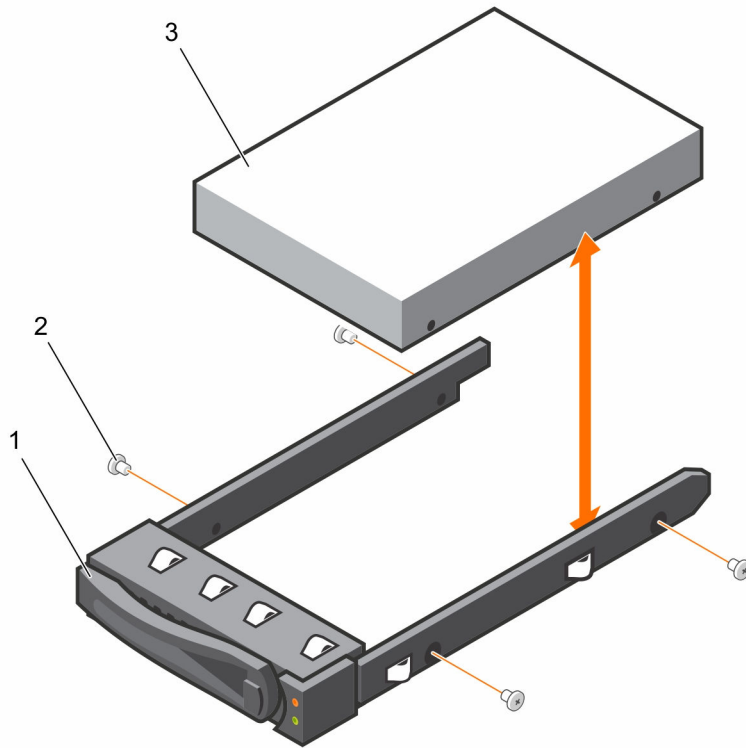

**Figure 14. Removing and installing a hard drive from the hard drive carrier**

1. hard drive carrier
2. screw (4)
3. hard drive

## Installing a hard drive into a hard drive carrier

**⚠ CAUTION:** Many repairs may only be done by a certified service technician. You should only perform troubleshooting and simple repairs as authorized in your product documentation, or as directed by the online or telephone service and support team. Damage due to servicing that is not authorized by Dell is not covered by your warranty. Read and follow the safety instructions that are shipped with your product.

Follow the safety guidelines listed in the Safety instructions section.

1. Place the hard drive into the hard drive carrier.
2. Secure the hard drive to the hard drive carrier with screws.

## SATADOM

### Important information about SATADOM

The SATA Disk-On-Motherboard (SATADOM) shipped with XC Series appliances is intended as an appliance boot device.

 **NOTE:** Write intensive activities and processes leveraged by XC appliances, are intended to take place on the SSDs and HDDs and not the boot device.

The hypervisor boot device is not intended for application use.

 **WARNING:** Adding additional write intensive software to the SATADOM boot disk results in heavy wear on the device beyond design specifications resulting in premature hardware failure.

You should not run applications on the hypervisor operating system.

### Examples of write intensive applications

Following are the examples of write intensive applications:

- System Center Agents.
  - System Center Configuration Manager (CCMExec.exe).
  - System Center Operations Manager (MonitoringHost.exe).
- Write-intensive Agents.
- Databases.
- Disk management utilities (third-party disk defragmentation or partitioning tools).
- Additional roles outside of the appliance's intended use (web server, domain controller, RDS, and so on.).
- Client-based Antivirus.
- Run Virtual Machines directly on the SATADOM. Ensure that the Virtual Machines run on Solid State Drives (SSDs) and Hard Disk Drives (HDDs).

### Removing the SATADOM

 **CAUTION:** Many repairs may only be done by a certified service technician. You should only perform troubleshooting and simple repairs as authorized in your product documentation, or as directed by the online or telephone service and support team. Damage due to servicing that is not authorized by Dell is not covered by your warranty. Read and follow the safety instructions that are shipped with your product.

1. Follow the safety guidelines listed in the Safety instructions section.
  2. Turn off the system, including any attached peripherals.
  3. Disconnect the system from the electrical outlet and disconnect the peripherals.
- 
1. Disconnect the power cable from the SATADOM and the system board.
  2. Using a screwdriver, press the metal latch to release the SATADOM.
  3. Holding the SATADOM by its edges, pull the SATADOM until the card edge connector disengages from the onboard SATA connector 5 on the system board.

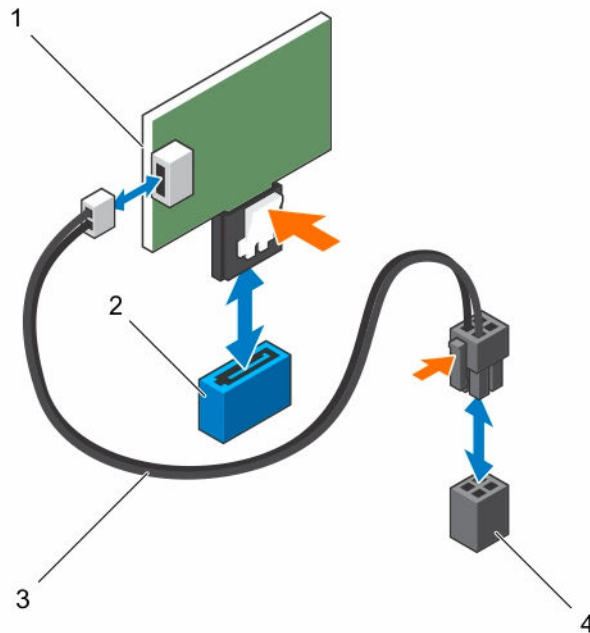

**Figure 15. Removing the SATADOM**

- |                |                                 |
|----------------|---------------------------------|
| 1. SATADOM     | 2. SATA connector SATA5         |
| 3. power cable | 4. system board power connector |

## Installing the SATADOM

**⚠ CAUTION:** Many repairs may only be done by a certified service technician. You should only perform troubleshooting and simple repairs as authorized in your product documentation, or as directed by the online or telephone service and support team. Damage due to servicing that is not authorized by Dell is not covered by your warranty. Read and follow the safety instructions that are shipped with your product.

Follow the safety guidelines listed in the Safety instructions section.

1. Holding the SATADOM by its edges, position it so that the card edge connector aligns with the onboard SATA connector 5 on the system board.
2. Press the SATADOM with your thumbs until it is fully seated.
3. Reconnect all the cables.
  1. Reconnect the peripherals and connect the system to the electrical outlet.
  2. Turn on the system, including any attached peripherals.

## Cable routing for SATADOM and LSI 2008

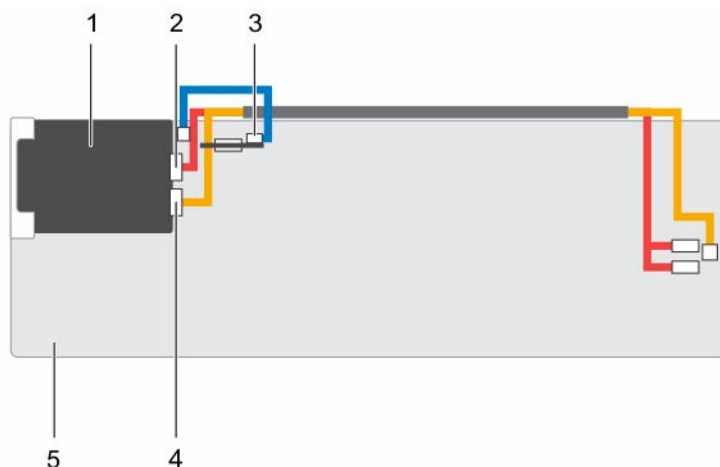

Figure 16. Cable Routing for SATADOM and LSI 2008

Table 8. Cable Routing for SATADOM and LSI 2008

Item	Cable	From (LSI 2008 SAS Mezzanine Card)	To (System Board)
1	LSI 2008 SAS Mezzanine card		
2	Mini-SAS cable	Mini-SAS connector 4-7 (J4) On LSI 2008 SAS Mezzanine Card	SAS/SATA connectors 4 and 5
3	SATADOM power cable	SATADOM	HDD Power Connector on the system board
4	Mini-SAS connector 0-3 (J3)	On LSI 2008 SAS Mezzanine Card	Mini-SAS HD Connector 0-3
5	System board		

## Power supply units

**NOTE:** Configurations higher than indicated in the table may change the PSU mode to non-redundant. In non-redundant mode if the power requirement exceeds the installed system power capacity, the BIOS will throttle the processors. Also, since **Processor Power Capping** is enabled, processor throttling occurs on configurations that exceed the cap value.

**NOTE:** Both the PSUs are hot swappable, and they can support hot swap in any condition if the system has power throttling feature.

The following table lists the maximum supported configuration where power supply unit (PSU) redundancy is guaranteed:



Table 9. PSUs configuration

PSU	System boards
1600 W	Up to two 120 W processor per system board, six hard drives per system board, and 16 memory modules per system board

## Removing a power supply unit

**△ CAUTION:** Many repairs may only be done by a certified service technician. You should only perform troubleshooting and simple repairs as authorized in your product documentation, or as directed by the online or telephone service and support team. Damage due to servicing that is not authorized by Dell is not covered by your warranty. Read and follow the safety instructions that are shipped with your product.

**△ CAUTION:** The system requires at least one power supply unit (PSU) to operate normally.

1. Follow the safety guidelines listed in the Safety instructions section.
2. Turn off the system, including any attached peripherals.
3. Disconnect the power cable from the power source and the PSU, and disconnect the peripherals.

Press the release lever and by using the handle, slide the PSU out of the system.

**🔧 NOTE:** Removing the PSU may require considerable force.

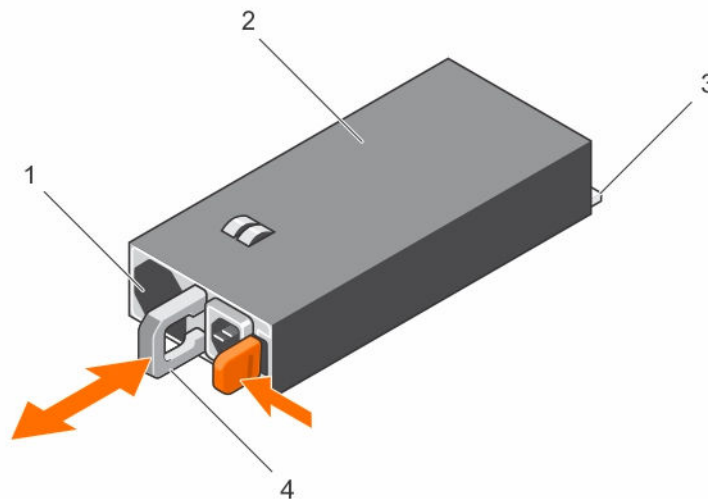

Figure 17. Removing and installing a PSU

1. fan

2. PSU

3. PSU connector

4. handle

## Installing a power supply unit

 **CAUTION:** Many repairs may only be done by a certified service technician. You should only perform troubleshooting and simple repairs as authorized in your product documentation, or as directed by the online or telephone service and support team. Damage due to servicing that is not authorized by Dell is not covered by your warranty. Read and follow the safety instructions that are shipped with your product.

 **CAUTION:** The system requires at least one power supply unit (PSU) to operate normally.

Verify that both PSUs are of the same type and have the same maximum output power.

 **NOTE:** The maximum output power is printed on the PSU label.

Follow the safety guidelines listed in the Safety instructions section.

Slide the new PSU into the chassis until the PSU until is fully seated and the release lever snaps into place.

Connect the power cable to the PSU and plug the cable into a power outlet.

 **NOTE:** When installing a new PSU in a system with two PSUs, allow several seconds for the system to recognize the PSU and determine its status.

## System board assembly

### Removing the system board tray

 **CAUTION:** Many repairs may only be done by a certified service technician. You should only perform troubleshooting and simple repairs as authorized in your product documentation, or as directed by the online or telephone service and support team. Damage due to servicing that is not authorized by Dell is not covered by your warranty. Read and follow the safety instructions that are shipped with your product.

Follow the safety guidelines listed in the Safety instructions section.

1. Remove the screw that secures the retaining latch.
2. Press the retaining latch and slide the system board tray out of the chassis.

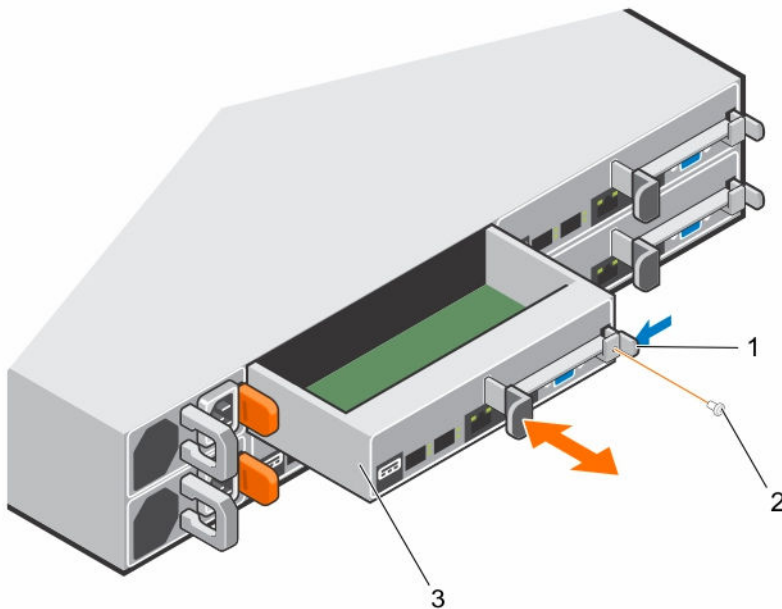

**Figure 18. Removing and installing a system board tray**

1. retaining latch
2. screw
3. system board tray

## Installing the system board tray

**CAUTION:** Many repairs may only be done by a certified service technician. You should only perform troubleshooting and simple repairs as authorized in your product documentation, or as directed by the online or telephone service and support team. Damage due to servicing that is not authorized by Dell is not covered by your warranty. Read and follow the safety instructions that are shipped with your product.

Follow the safety guidelines listed in the Safety instructions section.

1. Slide the system board tray into the chassis until it snaps into place.
2. Replace the screw that secures the retaining latch.

## Removing the system board assembly

**CAUTION:** Many repairs may only be done by a certified service technician. You should only perform troubleshooting and simple repairs as authorized in your product documentation, or as directed by the online or telephone service and support team. Damage due to servicing that is not authorized by Dell is not covered by your warranty. Read and follow the safety instructions that are shipped with your product.

1. Follow the safety guidelines listed in the Safety instructions section.
2. Turn off the system, including any attached peripherals.
3. Disconnect the system from the electrical outlet and disconnect the peripherals.

4. Disconnect all the external cables from the system board.
1. Remove the screw that secures the retaining latch.
2. Press the retaining latch and by using the handle, slide the system board assembly out of the chassis.

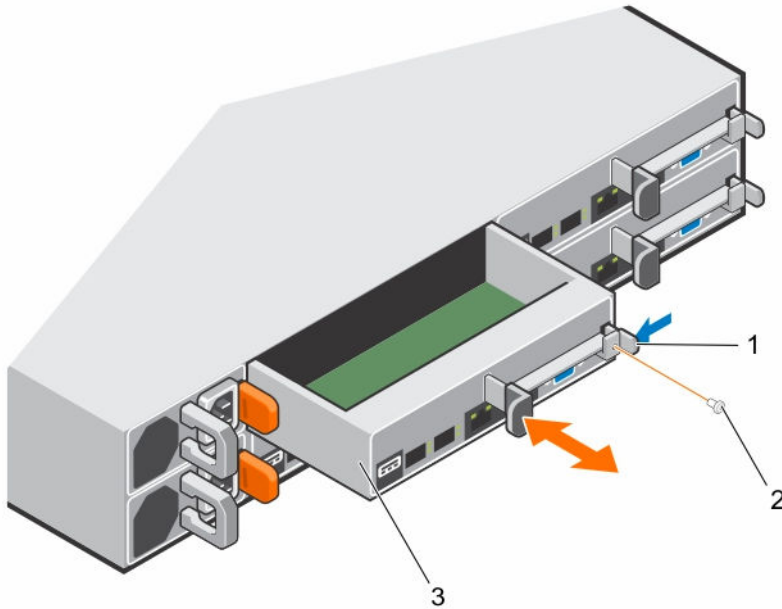

**Figure 19. Removing and installing a system board assembly**

- |                          |          |
|--------------------------|----------|
| 1. retaining latch       | 2. screw |
| 3. system board assembly |          |

## Installing the system board assembly

**⚠ CAUTION:** Many repairs may only be done by a certified service technician. You should only perform troubleshooting and simple repairs as authorized in your product documentation, or as directed by the online or telephone service and support team. Damage due to servicing that is not authorized by Dell is not covered by your warranty. Read and follow the safety instructions that are shipped with your product.

Follow the safety guidelines listed in the Safety instructions section.

1. Slide the system board assembly into the chassis until it snaps into place.
2. Replace the screw that secures the retaining latch.
1. Reconnect all the external cables to the system board.
2. Reconnect the peripherals and connect the system to the electrical outlet.
3. Turn on the system, including any attached peripherals.

**🔧 NOTE:** To add the service tag of the system board to match the service tag of the physical node, contact technical support.

# Air baffle

## Removing the cooling shroud

**△ CAUTION:** Many repairs may only be done by a certified service technician. You should only perform troubleshooting and simple repairs as authorized in your product documentation, or as directed by the online or telephone service and support team. Damage due to servicing that is not authorized by Dell is not covered by your warranty. Read and follow the safety instructions that are shipped with your product.

1. Follow the safety guidelines listed in the Safety instructions section.
2. Turn off the system, including any attached peripherals.
3. Disconnect the system from the electrical outlet and disconnect the peripherals.
4. Remove the system board assembly.

Press the four latches along the direction of the arrows, and then lift the cooling shroud out of the system board assembly.

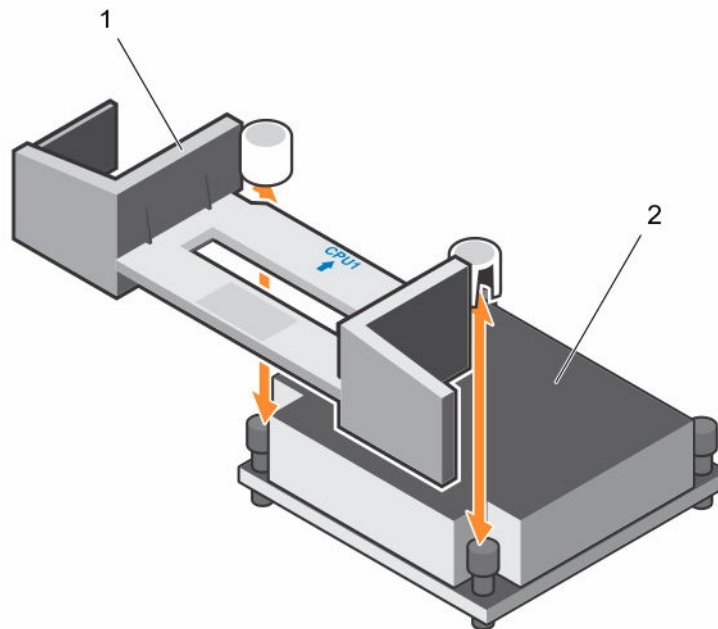

**Figure 20. Removing the cooling shroud**

1. cooling shroud

2. CPU 1 heatsink

### Related Links

[Removing the system board assembly](#)

## Installing the cooling shroud

**⚠ CAUTION:** Many repairs may only be done by a certified service technician. You should only perform troubleshooting and simple repairs as authorized in your product documentation, or as directed by the online or telephone service and support team. Damage due to servicing that is not authorized by Dell is not covered by your warranty. Read and follow the safety instructions that are shipped with your product.

Follow the safety guidelines listed in the Safety instructions section.

Replace the cooling shroud into the system board assembly. Make sure that the four latches are properly engaged with the heat sink bases and the latches click in place.

**🔪 NOTE:** When installing the cooling shroud, make sure the arrow of the mark on the cooling shroud points to processor 1, and keep the flat surface of the cooling shroud horizontal.

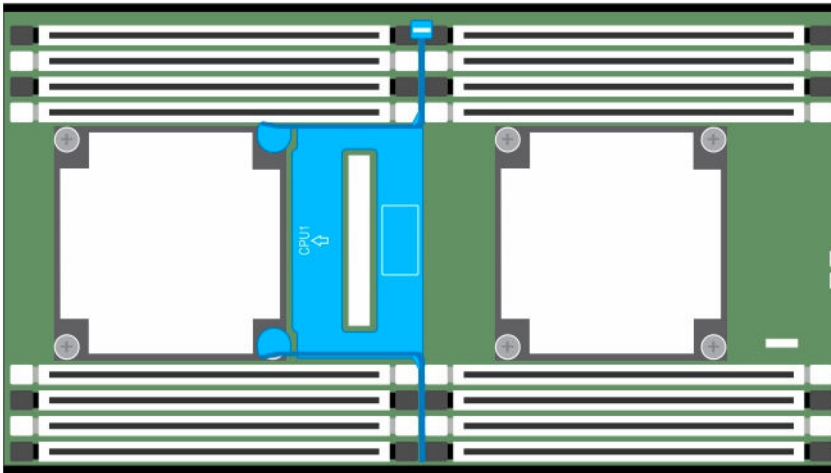

Figure 21. Top view of the installed cooling shroud

1. Install the system board assembly.
2. Reconnect the peripherals and connect the system to the electrical outlet.
3. Turn on the system, including any attached peripherals.

### Related Links

[Installing the system board assembly](#)

## Heat sinks

The heat sink transfers heat away from the processor as the processor is unable to dissipate sufficient heat to moderate this temperature. The heat sink is designed to maximize its surface area in contact with the cooling medium surrounding it, such as the air. Thermal grease improves the heat sink's performance by filling air gaps between the heat sink and the heat spreader on the processor.

## Removing the heat sink

**CAUTION:** Many repairs may only be done by a certified service technician. You should only perform troubleshooting and simple repairs as authorized in your product documentation, or as directed by the online or telephone service and support team. Damage due to servicing that is not authorized by Dell is not covered by your warranty. Read and follow the safety instructions that are shipped with your product.

**NOTE:** Place the foolproof pins of two processor heat sinks facing inside.

1. Follow the safety guidelines listed in the Safety instructions section.
2. Turn off the system, including any attached peripherals.
3. Disconnect the system from the electrical outlet and disconnect the peripherals.
4. Remove the system board assembly.

**WARNING:** The heat sink may be hot to touch for some time after the system has been powered down. Allow the heat sink to cool before removing it.

**CAUTION:** Never remove the heat sink from a processor unless you intend to remove the processor. The heat sink is necessary to maintain proper thermal conditions.

1. Using a Phillips screwdriver, loosen one of the heat sink retention screws. Wait for 30 seconds for the heat sink to loosen from the processor.
2. Remove the other heat sink retention screws.
3. Lift the heat sink off the processor and set the heat sink aside with thermal grease side facing up.

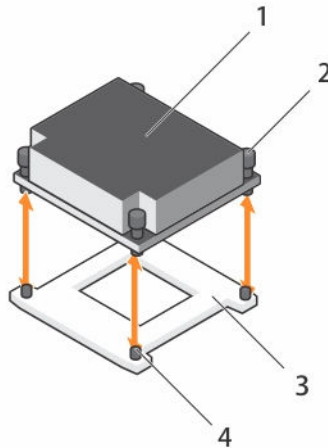

**Figure 22. Removing and installing the heat sink**

- |                     |                       |
|---------------------|-----------------------|
| 1. heat sink        | 2. captive screws (4) |
| 3. processor socket | 4. slot (4)           |

### Related Links

[Removing the system board assembly](#)

## Installing the heat sink

-  **CAUTION:** Many repairs may only be done by a certified service technician. You should only perform troubleshooting and simple repairs as authorized in your product documentation, or as directed by the online or telephone service and support team. Damage due to servicing that is not authorized by Dell is not covered by your warranty. Read and follow the safety instructions that are shipped with your product.

Follow the safety guidelines listed in the Safety instructions section.

1. Using a clean lint-free cloth, remove the thermal grease from the heat sink.
2. Apply new thermal grease evenly to the center of the top of the new processor.

-  **CAUTION:** Using excess thermal grease can cause grease to contact the processor shield, which can cause contamination of the processor socket.

3. Place the heat sink on the processor.
4. Using a Phillips screwdriver, tighten the heat sink retention screws.

Replace the system board assembly.

### Related Links

[Installing the system board assembly](#)

## Processors

This system board supports Intel E5-2600 v3 processor series, which is up to 145 W, 3.5 GHz, and 12 cores based on Intel Wellsburg PCH chipset.

### Removing a processor

-  **CAUTION:** Many repairs may only be done by a certified service technician. You should only perform troubleshooting and simple repairs as authorized in your product documentation, or as directed by the online or telephone service and support team. Damage due to servicing that is not authorized by Dell is not covered by your warranty. Read and follow the safety instructions that are shipped with your product.

1. Follow the safety guidelines listed in the Safety instructions section.
2. Remove the system board assembly.
3. Remove the heat sink.

-  **CAUTION:** The processor is held in its socket under strong pressure. The release lever can spring up suddenly if not firmly grasped.

1. Position your thumbs firmly over the processor socket release levers and release the levers from the locked position. Rotate the levers 90 degrees upward until the processor is released from the socket.
2. Rotate the processor shield upward and out of the way.
3. Lift the processor out of the socket and leave the socket release levers up so that the socket is ready for the new processor.

-  **CAUTION:** Be careful not to bend any of the pins on the CPU socket when removing the processor. Bending the pins can permanently damage the system board. Be sure to properly align the process or notch to the socket and insert straight down. Do not move from side to side.



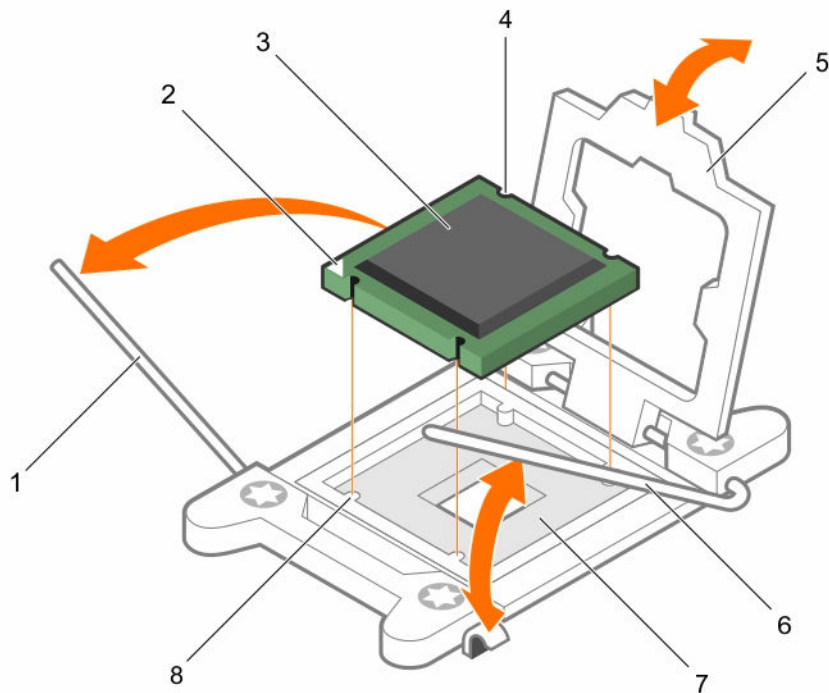

**Figure 23. Removing and installing a processor**

- |                         |                             |
|-------------------------|-----------------------------|
| 1. socket release lever | 2. orientation arrow        |
| 3. processor            | 4. notch in processor (4)   |
| 5. processor shield     | 6. socket release lever (2) |
| 7. socket pin array     | 8. notch                    |

#### Related Links

[Removing the system board assembly](#)





[Removing the heat sink](#)

### Installing a processor

**CAUTION:** Many repairs may only be done by a certified service technician. You should only perform troubleshooting and simple repairs as authorized in your product documentation, or as directed by the online or telephone service and support team. Damage due to servicing that is not authorized by Dell is not covered by your warranty. Read and follow the safety instructions that are shipped with your product.

**NOTE:** When installing only one processor, the processor must be installed in the processor 0 (for the socket location, see the System board connectors section).

**NOTE:** If you are upgrading your processors, prior to upgrading your system, download and install the latest system BIOS version from [Dell.com/support/home](http://Dell.com/support/home). Follow the instructions included in the file download to install the update on your system.

1. Follow the safety guidelines listed in the Safety instructions section.
2. Unpack the processor if it has not been used previously.
  -  **NOTE:** If the processor has already been used, remove any thermal grease from the top of the processor by using a lint-free cloth.
3. Remove the system board assembly.
1. Align the processor with the socket keys on the CPU socket.
  -  **CAUTION: Positioning the processor incorrectly can permanently damage the system board or the processor. Be careful not to bend the pins in the CPU socket.**
2. With the release lever on the processor socket in the open position, align the processor with the socket keys and set the processor lightly in the socket.
  -  **CAUTION: Do not use force to seat the processor. When the processor is positioned correctly, it engages easily into the socket.**
3. Close the processor shield.
4. Rotate the socket release lever down until it snaps into place.
5. Using a clean lint-free cloth, remove the thermal grease from the heat sink.
6. Apply thermal grease evenly to the center of the top of the new processor.
  -  **CAUTION: Using excess thermal grease can cause grease to contact the processor shield, which can cause contamination of the processor socket.**
7. Place the heat sink on the processor.
8. Using a Phillips screwdriver, tighten the heat sink retention screws.
1. Replace the system board assembly.
2. Reconnect the system to its electrical outlet and turn on the system, including any attached peripheral devices.
3. Press F2 to enter the System Setup program, and check that the processor information matches the new system configuration. See the System setup options at boot section.

#### Related Links

[Installing the system board assembly](#)

## Expansion card assembly and expansion card

The expansion card in computer is a printed circuit board that can be inserted into an expansion slot on the computer system board riser card to add functionality to the computer system through the expansion bus.

-  **NOTE:** A missing or an unsupported expansion card riser logs an SEL event. It does not prevent your system from powering on and no BIOS POST message or F1/F2 pause is displayed.

### Removing the expansion card

-  **CAUTION: Many repairs may only be done by a certified service technician. You should only perform troubleshooting and simple repairs as authorized in your product documentation, or as directed by the online or telephone service and support team. Damage due to servicing that is not authorized by Dell is not covered by your warranty. Read and follow the safety instructions that are shipped with your product.**

1. Follow the safety guidelines listed in the Safety instructions section.
2. Turn off the system, including any attached peripherals.

3. Disconnect the system from the electrical outlet and disconnect the peripherals.
4. Remove the system board assembly.
1. Remove the screws that secure the expansion card assembly.
2. Lift the expansion card assembly out of the system board assembly.

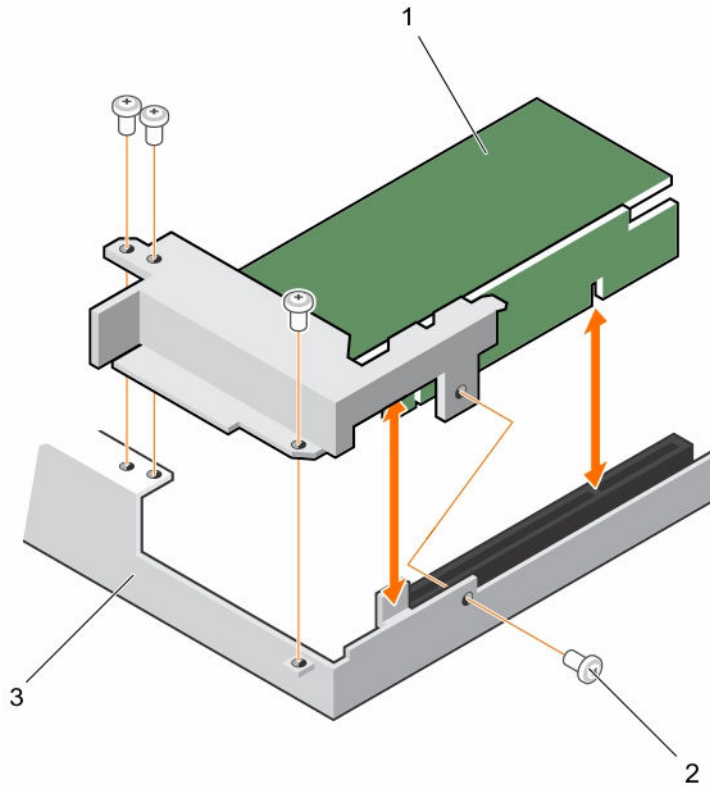

**Figure 24. Removing the expansion card assembly for 1U node**

- |                            |              |
|----------------------------|--------------|
| 1. expansion card assembly | 2. screw (4) |
| 3. system board assembly   |              |
3. Remove the screw that secures the expansion card.
  4. Hold the expansion card by its edges, and carefully remove it from the riser card.
- NOTE:** If you are removing the card permanently, install an expansion card slot cover over the empty expansion slot opening, and close the expansion card latch.
- NOTE:** You must install a filler bracket over an empty expansion slot to maintain Federal Communications Commission (FCC) certification of the system. The brackets also keep dust and dirt out of the system and aid in proper cooling and airflow inside the system.

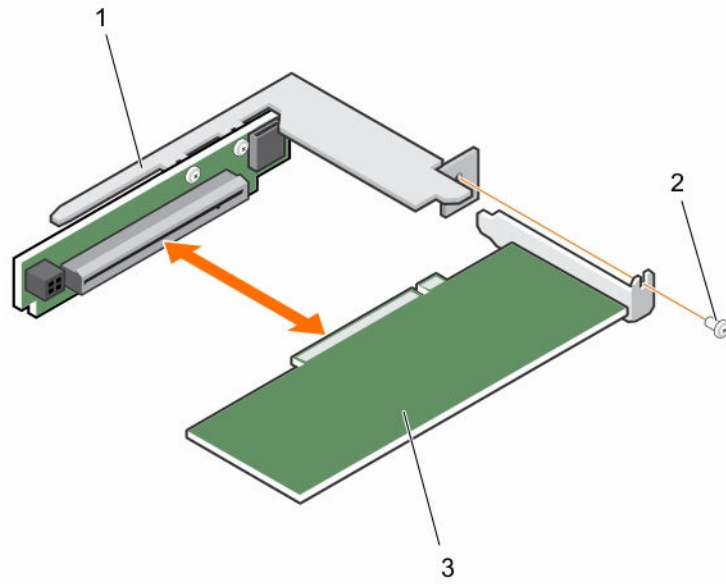

**Figure 25. Removing the expansion card for 1U node**

- |                              |          |
|------------------------------|----------|
| 1. expansion card slot cover | 2. screw |
| 3. expansion card            |          |

#### Related Links

[Installing the system board assembly](#)

### Installing the expansion card

**CAUTION:** Many repairs may only be done by a certified service technician. You should only perform troubleshooting and simple repairs as authorized in your product documentation, or as directed by the online or telephone service and support team. Damage due to servicing that is not authorized by Dell is not covered by your warranty. Read and follow the safety instructions that are shipped with your product.

**CAUTION:** Expansion cards can only be installed in the slots on the expansion card riser. Do not attempt to install expansion cards directly into the riser connector on the system board.

1. Follow the safety guidelines listed in the Safety instructions section.
2. Unpack the expansion card and prepare it for installation. For instructions, see the documentation accompanying the card.

1. Remove the screws that secure the expansion card assembly.
2. Lift the expansion card assembly away from the system board assembly.
3. Remove the screw that secures the filler bracket.
4. Hold the filler bracket by its edges, and carefully remove it from the riser card.

**NOTE:** Retain this bracket in case you need to remove the expansion card. Filler brackets must be installed over empty expansion cards slots to maintain FCC certification of the system. The brackets also keep dust and dirt out of the system and aid in proper cooling and airflow inside the system.

5. Holding the card by its edges, position the card so that the card edge connector aligns with the riser card on the riser card.

6. Insert the card edge connector firmly into the riser card until the card is fully seated.
7. Replace the screw that secures the expansion card.
8. Place the expansion card assembly into the system board assembly.
9. Install the screws that secure the expansion card assembly.
1. Install the system board assembly.
2. Reconnect the peripherals and connect the system to the electrical outlet.
3. Turn on the system, including any attached peripherals.

#### Related Links

[Removing the system board assembly](#)

[Installing the system board assembly](#)

## Riser card

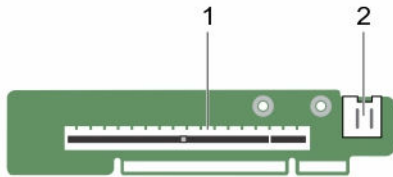

Figure 26. 1U riser card for 1U node

1. PCI-E Gen 3 x16
2. micro SD card socket

### Removing the riser card

**CAUTION:** Many repairs may only be done by a certified service technician. You should only perform troubleshooting and simple repairs as authorized in your product documentation, or as directed by the online or telephone service and support team. Damage due to servicing that is not authorized by Dell is not covered by your warranty. Read and follow the safety instructions that are shipped with your product.

1. Follow the safety guidelines listed in the Safety instructions section.
2. Turn off the system, including any attached peripherals.
3. Disconnect the system from the electrical outlet and disconnect the peripherals.
4. Remove the system board assembly.
5. Remove the expansion card.
1. Remove the screws that secure the riser card to the expansion card bracket.
2. Pull the riser card away from the expansion card bracket.

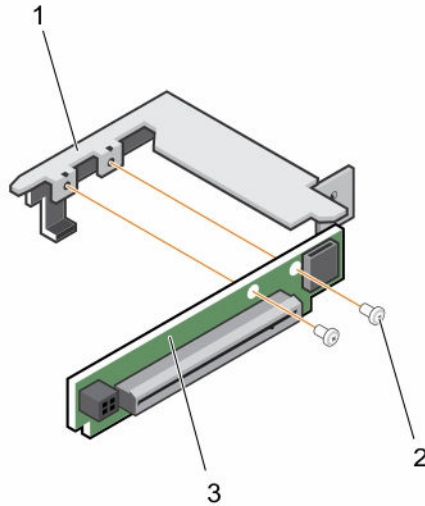

**Figure 27. Removing and installing the riser card**

1. expansion card bracket
2. screw (2)
3. riser card

#### Related Links

- [Removing the system board assembly](#)
- [Removing the expansion card](#)

### Installing the riser card

**⚠ CAUTION:** Many repairs may only be done by a certified service technician. You should only perform troubleshooting and simple repairs as authorized in your product documentation, or as directed by the online or telephone service and support team. Damage due to servicing that is not authorized by Dell is not covered by your warranty. Read and follow the safety instructions that are shipped with your product.

Follow the safety guidelines listed in the Safety instructions section.

1. Place the riser card into the expansion card bracket.
  2. Replace the screws that secure the riser card to the expansion card bracket.
1. Install the expansion card.
  2. Install the system board assembly.
  3. Reconnect the peripherals and connect the system to the electrical outlet.
  4. Turn on the system, including any attached peripherals.

#### Related Links

- [Installing the expansion card](#)
- [Installing the system board assembly](#)

## LSI 2008 Mezzanine Card

## Removing the LSI 2008 SAS mezzanine card

**CAUTION:** Many repairs may only be done by a certified service technician. You should only perform troubleshooting and simple repairs as authorized in your product documentation, or as directed by the online or telephone service and support team. Damage due to servicing that is not authorized by Dell is not covered by your warranty. Read and follow the safety instructions that are shipped with your product.

**NOTE:** The LSI 2008 SAS mezzanine card is seated in PCI-E Gen3 x8 mezzanine slot 3 on the system board, which is not active in 1-processor configuration.

1. Follow the safety guidelines listed in the Safety instructions section.
  2. Turn off the system, including any attached peripherals.
  3. Disconnect the system from the electrical outlet and disconnect the peripherals.
  4. Remove the system board assembly.
1. Disconnect all the cables from the mezzanine card.
  2. Remove the screws that secure the LSI 2008 SAS mezzanine card.
  3. Lift the mezzanine card out of the system-board assembly.

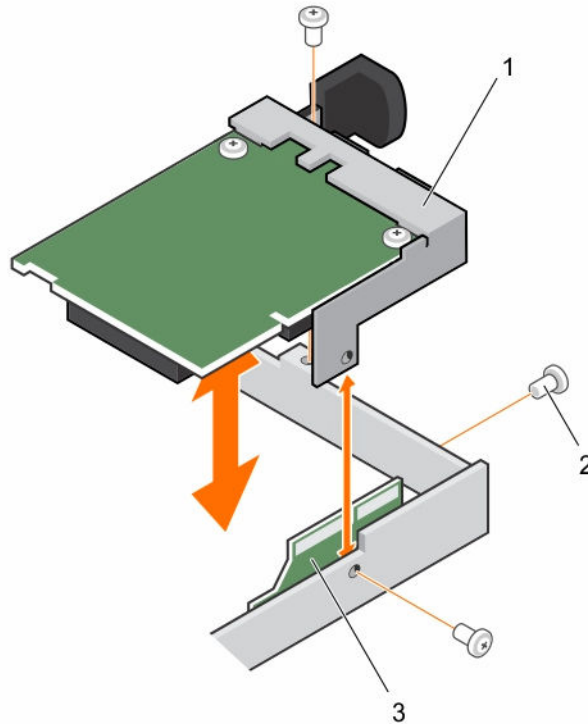

**Figure 28. Removing and installing the LSI 2008 SAS mezzanine card**

- |                                |              |
|--------------------------------|--------------|
| 1. LSI 2008 SAS mezzanine card | 2. screw (3) |
| 3. bridge card                 |              |

## Installing the LSI 2008 SAS mezzanine card

 **CAUTION:** Many repairs may only be done by a certified service technician. You should only perform troubleshooting and simple repairs as authorized in your product documentation, or as directed by the online or telephone service and support team. Damage due to servicing that is not authorized by Dell is not covered by your warranty. Read and follow the safety instructions that are shipped with your product.

Follow the safety guidelines listed in the Safety instructions section.

1. Place the LSI 2008 SAS mezzanine card on the system board assembly.
  2. Install the screws that secure the LSI 2008 SAS mezzanine card.
  3. Reconnect all the cables to the LSI 2008 SAS mezzanine card.
1. Install the system board assembly.
  2. Reconnect the peripherals and connect the system to the electrical outlet.
  3. Turn on the system, including any attached peripherals.

### Related Links

[Installing the system board assembly](#)

## Mezzanine card bridge board

### Removing the mezzanine card bridge board

 **CAUTION:** Many repairs may only be done by a certified service technician. You should only perform troubleshooting and simple repairs as authorized in your product documentation, or as directed by the online or telephone service and support team. Damage due to servicing that is not authorized by Dell is not covered by your warranty. Read and follow the safety instructions that are shipped with your product.

1. Follow the safety guidelines listed in the Safety instructions section.
2. Turn off the system, including any attached peripherals.
3. Disconnect the system from the electrical outlet and disconnect the peripherals.
4. Remove the system board assembly.
5. Remove the mezzanine card.

Pull the mezzanine card bridge board away from the mezzanine slot on the system board.



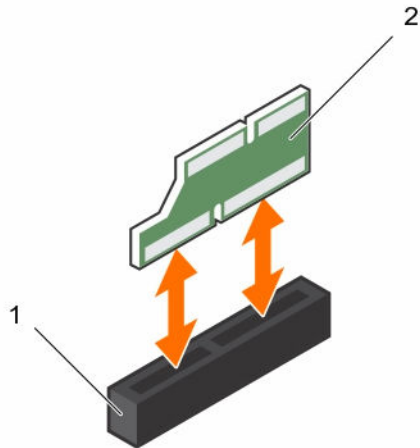

**Figure 29. Removing and installing the mezzanine card bridge board**

1. PCI slot
2. mezzanine card bridge

#### Related Links

- [Removing the system board assembly](#)
- [Removing the LSI 2008 SAS mezzanine card](#)

## Installing the mezzanine card bridge board

**⚠ CAUTION:** Many repairs may only be done by a certified service technician. You should only perform troubleshooting and simple repairs as authorized in your product documentation, or as directed by the online or telephone service and support team. Damage due to servicing that is not authorized by Dell is not covered by your warranty. Read and follow the safety instructions that are shipped with your product.

Follow the safety guidelines listed in the Safety instructions section.

Install the mezzanine card bridge board into the mezzanine slot on the system board.

1. Install the mezzanine card.
2. Install the system board assembly.
3. Reconnect the peripherals and connect the system to the electrical outlet.
4. Turn on the system, including any attached peripherals.

#### Related Links

- [Installing the LSI 2008 SAS mezzanine card](#)
- [Installing a system board](#)

## System memory

System memory holds the instructions that the processor executes. Each system board has sixteen DDR4 memory module sockets for the installation of up to sixteen registered DDR4-2400 MHz (2400 MHz at 2 memory modules per channel) memory modules to support processor 1 and processor 2. For the location of the memory modules, see the C6320 system board connectors section.

## Memory slot features

- Support 8 channels, 16 DDR4 registered DIMMs (RDIMMs)
- Speed up to 2400 MT/s
- Max. capacities:  
512 GB with 32 GB RDIMM
- Supports DDR4
- Supports Error Correction Code (ECC)

 **NOTE:** Linux operating system does not support the S4 (hibernation) mode.

## Supported memory module configuration

For the sequence of the 16 memory-module sockets, the system requires at least one memory module installed on processor 1's DIMM slot 1 in order to boot up. When you insert the memory modules, always start with CHA\_A1. The optimized memory module installation sequence is 1, 2, 3, 4, 5, 6, 7, and 8.

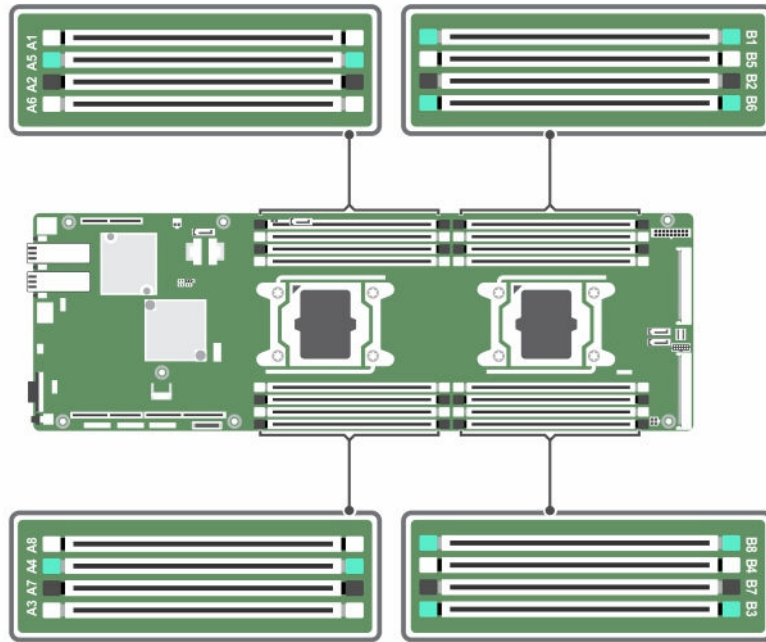

Figure 30. DIMM slot locations

Table 10. Memory module configurations for dual processors

Memory modules	Processor 1							
	CHA		CHB		CHC		CHD	
	A1	A5	A2	A6	A3	A7	A4	A8
2	√	–	–	–	–	–	–	–

Processor 1								
6	√	–	√	–	√	–	–	–
8	√	–	√	–	√	–	√	–
12	√	√	√	√	√	–	√	–
16	√	√	√	√	√	√	√	√

**Table 11. Memory module configurations for dual processors**

Processor 2								
Memory modules	CHA		CHB		CHC		CHD	
	B1	B5	B2	B6	B3	B7	B4	B8
2	√	–	–	–	–	–	–	–
6	√	–	√	–	√	–	–	–
8	√	–	√	–	√	–	√	–
12	√	√	√	√	√	–	√	–
16	√	√	√	√	√	√	√	√

## Removing the memory modules

 **WARNING:** The memory modules are hot to the touch for some time after the system has been powered down. Allow time for the memory modules to cool before handling them. Handle the memory modules by the card edges and avoid touching the components on the memory module.

 **CAUTION:** Many repairs may only be done by a certified service technician. You should only perform troubleshooting and simple repairs as authorized in your product documentation, or as directed by the online or telephone service and support team. Damage due to servicing that is not authorized by Dell is not covered by your warranty. Read and follow the safety instructions that are shipped with your product.

1. Follow the safety guidelines listed in the Safety instructions section.
2. Turn off the system, including any attached peripherals.
3. Disconnect the system from the electrical outlet and disconnect the peripherals.
4. Remove the system board assembly.
5. Remove the cooling shroud.

1. Locate the memory module sockets.

 **CAUTION:** Handle each memory module only on either card edge, ensuring not to touch the middle of the memory module. To avoid damaging components on the memory module, remove only one memory module at a time.

2. Simultaneously press down and out on the ejectors at both ends of the memory module socket until the memory module is released from the socket.
3. Lift the memory module out of the socket by holding the memory module only by its edges.

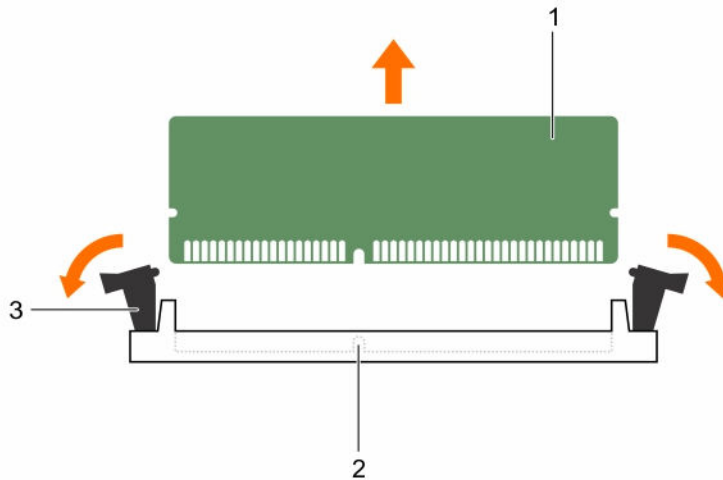

**Figure 31. Removing a memory module**

- |                                     |                  |
|-------------------------------------|------------------|
| 1. memory module                    | 2. alignment key |
| 3. memory module socket ejector (2) |                  |

#### Related Links

[Removing the system board assembly](#)

[Removing the cooling shroud](#)

## Installing the memory modules

**⚠ WARNING:** The memory modules are hot to the touch for some time after the system has been powered down. Allow time for the memory modules to cool before handling them. Handle the memory modules by the card edges and avoid touching the components on the memory module.

**⚠ CAUTION:** Many repairs may only be done by a certified service technician. You should only perform troubleshooting and simple repairs as authorized in your product documentation, or as directed by the online or telephone service and support team. Damage due to servicing that is not authorized by Dell is not covered by your warranty. Read and follow the safety instructions that are shipped with your product.

Follow the safety guidelines listed in the Safety instructions section.

1. Press down and out on the ejectors on each end of the memory module socket.
2. Align the memory module correctly with the alignment key of the memory module socket.
3. Press down firmly on the memory module with your thumbs until the module snaps into place.

**⚠ CAUTION:** Even pressure during insertion must be applied at both ends of the module simultaneously to prevent damage to the socket. No pressure should be applied to the center of the module.

4. Complete the latching of the module into the socket by applying inward pressure to the socket ejectors to ensure that the ejectors are in a locked position. When the memory module is properly seated in the socket, the ejectors on the memory module socket align with the ejectors on other identical sockets that have memory modules installed.

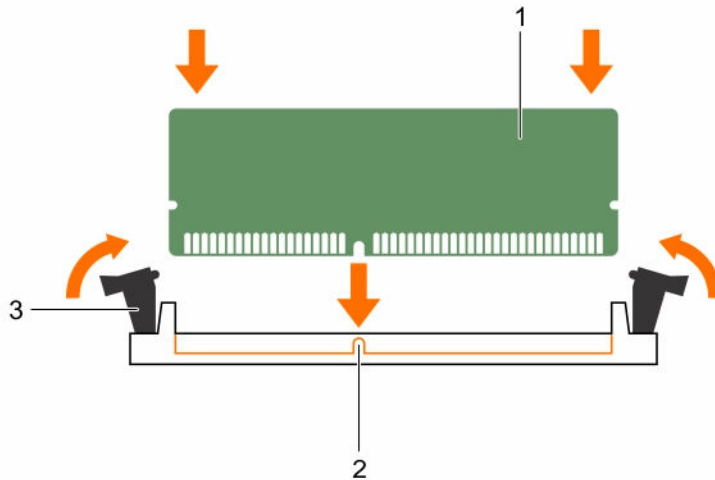

**Figure 32. Installing a memory module**

- |                                     |                  |
|-------------------------------------|------------------|
| 1. memory module                    | 2. alignment key |
| 3. memory module socket ejector (2) |                  |

1. Install the cooling shroud.
2. Install the system board assembly.
3. Press F2 to enter **System Setup**, and check the **System Memory** setting.
4. If the value is incorrect, one or more of the memory modules may not be installed properly. Ensure that the memory modules are firmly seated in the sockets.
5. Run the system memory test in the system diagnostics.

#### Related Links

[Installing the cooling shroud](#)

[Installing the system board assembly](#)

## System battery

### Replacing the system battery

**⚠ WARNING:** There is a danger of a new battery exploding if it is incorrectly installed. Replace the battery only with the same or equivalent type recommended by the manufacturer. See your safety information for additional information.

**⚠ CAUTION:** Many repairs may only be done by a certified service technician. You should only perform troubleshooting and simple repairs as authorized in your product documentation, or as directed by the online or telephone service and support team. Damage due to servicing that is not authorized by Dell is not covered by your warranty. Read and follow the safety instructions that are shipped with your product.

1. Follow the safety guidelines listed in the Safety instructions section.

2. Turn off the system, including any attached peripherals.
3. Disconnect the system from the electrical outlet and peripherals.
4. Remove the system board assembly.
5. Remove the cooling shroud.
6. Remove the expansion card assembly.

1. Push the battery latch and lift the battery out of the connector.

**⚠ CAUTION: To avoid damage to the battery connector, you must firmly support the connector while installing or removing a battery.**

2. Hold the new battery with the "+" facing the positive side of battery connector.
3. Insert the battery into the battery holder until it is seated in place.

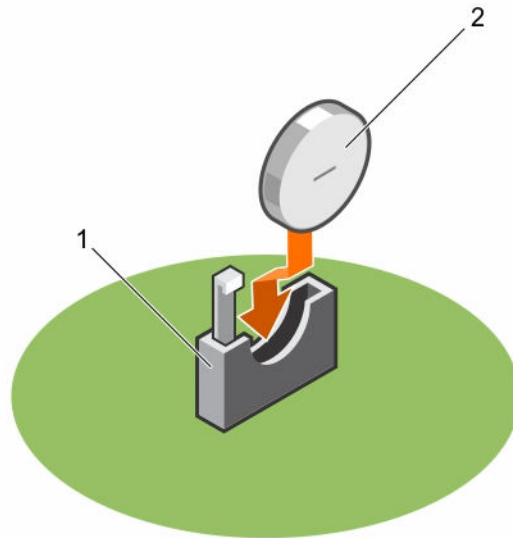

**Figure 33. Replacing the system battery**

1. battery socket

2. battery

1. Replace the system board assembly.
2. Reconnect the system to the electrical outlet.
3. Turn on the system, including any attached peripherals.
4. Enter **System Setup** to confirm that the battery is operating properly. See the System setup section.
5. In **System Setup**, enter correct time and date in the **Time** and **Date** fields.
6. Exit **System Setup**.

**Related Links**

- [Removing the system board assembly](#)
- [Removing the cooling shroud](#)
- [Removing the expansion card](#)
- [Installing the system board assembly](#)

# System board

## Removing a system board

 **CAUTION:** Many repairs may only be done by a certified service technician. You should only perform troubleshooting and simple repairs as authorized in your product documentation, or as directed by the online or telephone service and support team. Damage due to servicing that is not authorized by Dell is not covered by your warranty. Read and follow the safety instructions that are shipped with your product.

1. Follow the safety guidelines listed in the Safety instructions section.
  2. Turn off the system, including any attached peripherals.
  3. Disconnect the system from the electrical outlet and disconnect the peripherals.
  4. Remove the system board assembly.
  5. Remove the cooling shroud.
  6. Remove the expansion card assembly.
  7. Remove the heat sinks.
  8. Remove the memory modules.
  9. If installed, remove the SAS mezzanine card, 1 GbE mezzanine card, or 10 GbE mezzanine card.
  10. Disconnect all the cables from the system board.
1. Remove the screws that secure the system board to the system board assembly and then slide the system board.

 **CAUTION:** Do not lift the system board by holding a memory module, processor, or other components.

2. Hold the system board by the edges and lift the system board away from the system board assembly.

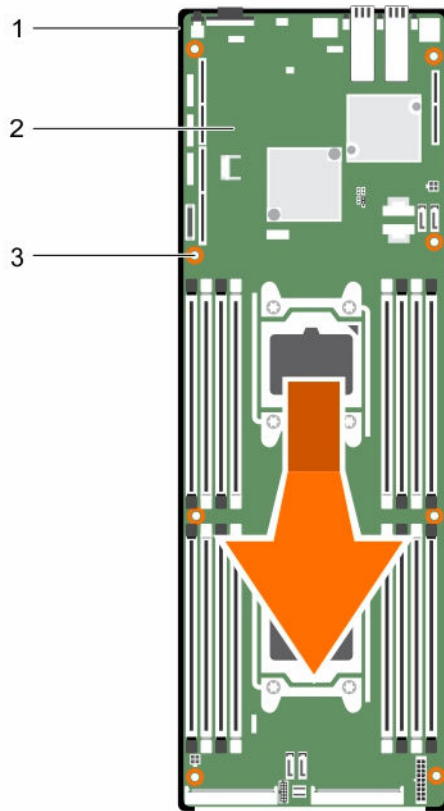

**Figure 34. Removing and installing the system board**

1. system board assembly
2. system board
3. screw (8)

#### Related Links

- [Removing the system board assembly](#)
- [Removing the cooling shroud](#)
- [Removing the expansion card](#)
- [Removing the heat sink](#)
- [Removing the memory modules](#)
- [Removing the LSI 2008 SAS mezzanine card](#)

#### Installing a system board

**⚠ CAUTION:** Many repairs may only be done by a certified service technician. You should only perform troubleshooting and simple repairs as authorized in your product documentation, or as directed by the online or telephone service and support team. Damage due to servicing that is not authorized by Dell is not covered by your warranty. Read and follow the safety instructions that are shipped with your product.



Follow the safety guidelines listed in the Safety instructions section.

1. Holding the system board by the edges, slide the system board into the system board assembly.
2. Install the screws to secure the system board to the system board assembly.
1. Install the Trusted Platform Module (TPM). For information how to install the TPM, see the Installing the Trusted Platform Module section. For more information on the TPM, see the Trusted Platform Module section.
  -  **NOTE:** The TPM plug-in module is attached to the system board and cannot be removed. A replacement TPM plug-in module will be provided for all system board replacements where a TPM plug-in module was installed.
2. Transfer the processors to the new system board.
3. Remove the memory modules and transfer them to the same locations on the new board.
4. Replace the heat sinks.
5. Install the expansion card assembly.
6. If applicable, install the SAS mezzanine card, 1 GbE mezzanine card, or 10 GbE mezzanine card.
7. Connect all the cables to the system board.
8. Install the cooling shroud.
9. Follow the procedure listed in the After working inside your system section.
10. Import your new or existing iDRAC Enterprise license. For more information, see Integrated Dell Remote Access Controller User's Guide, at [Dell.com/esmmanuals](http://Dell.com/esmmanuals).
11. Ensure that you:
  - a. Use the Easy Restore feature to restore the Service Tag. For more information, see the Easy restore section.
  - b. If the Service Tag is not backed up in the backup flash device, enter the system Service Tag manually. For more information, see the Entering the system Service Tag section.
  - c. Update the BIOS and iDRAC versions.
  - d. Re-enable the Trusted Platform Module (TPM). For more information, see the Re-enabling the Trusted Platform Module (TPM) section.

#### Related Links

- [Removing a processor](#)
- [Installing a processor](#)
- [Removing the memory modules](#)
- [Installing the memory modules](#)
- [Installing the heat sink](#)
- [Installing the expansion card](#)
- [Installing the LSI 2008 SAS mezzanine card](#)
- [Installing the cooling shroud](#)
- [Installing the system board assembly](#)

### Entering the system Service Tag using System Setup

1. If you know the system Service Tag, use the **System Setup** menu to enter the Service Tag.
2. Turn on the system.
3. To enter **System Setup**, press F2.
4. Click **Service Tag Settings**.
5. Enter the Service Tag.



**NOTE:** You can enter the Service Tag only when the **Service Tag** field is empty.

6. Ensure that you enter the correct Service Tag. After entering the Service Tag, it cannot be updated or changed.
7. Click **OK**.

# Troubleshooting your system

## Safety first—for you and your system

-  **CAUTION:** Many repairs may only be done by a certified service technician. You should only perform troubleshooting and simple repairs as authorized in your product documentation, or as directed by the online or telephone service and support team. Damage due to servicing that is not authorized by Dell is not covered by your warranty. Read and follow the safety instructions that are shipped with your product.



## Minimum configuration to POST

The three components mentioned below are the minimum configuration to POST:

- One power supply unit
- One Processor (CPU) in socket CPU1 (minimum for troubleshooting)
- One Memory Module (DIMM) installed in the socket A1

-  **NOTE:** When PCI-E slot 1 and Mezzanine slot are to be used, processor 1 must be installed; when PCI-E slot 3 is to be used, both processor 1 and processor 2 must be installed.

## Safety first – for you and your system

-  **WARNING:** Whenever you need to lift the system, get others to assist you. To avoid injury, do not attempt to lift the system by yourself.
-  **WARNING:** Before removing the system cover, disconnect all power, then unplug the AC power cord, and then disconnect all peripheral devices, and all LAN lines.
-  **CAUTION:** Many repairs may only be done by a certified service technician. You should only perform troubleshooting and simple repairs as authorized in your product documentation, or as directed by the online or telephone service and support team. Damage due to servicing that is not authorized by Dell is not covered by your warranty. Read and follow the safety instructions that are shipped with your product.

## Installation-related issues

Perform the following checks when you troubleshoot installation issues:

- Check all cable and power connections (including all rack cable connections).
- Unplug the power cord and wait for one minute. Then reconnect the power cord and try again.
- If the network is reporting an error, verify that the system has enough memory and disk space.

- Remove all added peripheral devices, one at a time, and try to turn on the system. If after removing a peripheral device, the system works, it may be an issue with the peripheral device or a configuration issue between the peripheral device and the system. Contact the peripheral device vendor for assistance.
- If the system does not turn on, check the LED display. If the power LED is not on, you may not be receiving AC power. Check the AC power cord to ensure that it is securely connected.

## Troubleshooting system startup failure

If your system halts during startup, especially after installing an OS or reconfiguring your system's hardware, check for invalid memory configurations. These could cause the system to halt at startup without any video output.

For all other startup issues, note any system messages that are displayed on the screen. For more information, see [Pre-operating system management applications](#).

## Troubleshooting external connections

Ensure that all external cables are securely attached to the external connectors on your system before troubleshooting any external devices. See [Front panel features and indicators](#) and [Back panel features and indicators](#).

## Troubleshooting the video subsystem

1. Check the system and power connections to the monitor.
2. Check the video interface cabling from the system to the monitor.

## Troubleshooting a USB device

To troubleshoot a USB keyboard and/or mouse for other USB devices, go to step 5. Use the following steps .

1. Disconnect the keyboard and mouse cables from the system briefly and reconnect them.
2. Connect the keyboard or mouse to the USB ports on the opposite side of the system.
3. If the issue is resolved, restart the system, enter the **System Setup** program, and check if the nonfunctioning USB ports are enabled.
4. Replace the keyboard or mouse with another working keyboard or mouse.  
If the issue is resolved, replace the faulty keyboard or mouse.

If the issue is not resolved, proceed to the next step to begin troubleshooting the other USB devices attached to the system.

5. Disable all the attached USB devices and disconnect them from the system.
6. Restart the system and, if your keyboard is functioning, enter the system setup program. Ensure that all USB ports are enabled.  
If your keyboard is not functioning, you can also use remote access. If the system is not accessible, see [Jumper settings](#) for instructions on setting the NVRAM\_CLR jumper inside your system and restoring the BIOS to the default settings.
7. Reconnect and enable each USB device one at a time.
8. If a device causes the same issue, turn off the device, replace the USB cable, and turn on the device.

If the issue persists, replace the device.

If all troubleshooting fails, see [Getting help](#).

## Troubleshooting a serial I/O device

1. Turn off the system and any peripheral devices connected to the serial port.
2. Swap the serial interface cable with another working cable, and turn on the system and the serial device.

If the issue is resolved, replace the interface cable.

3. Turn off the system and the serial device, and then swap the device with a comparable device.
4. Turn on the system and the serial device.

If the issue is resolved, replace the serial device.

If the issue persists, see [Getting help](#).

## Troubleshooting a NIC

1. Restart the system and check for any system messages pertaining to the NIC controller.
2. Check the appropriate indicator on the NIC connector. See [LAN indicator codes](#).
  - If the link indicator does not glow, check all cable connections.
  - If the activity indicator does not glow, the network driver files might be damaged or missing. Remove and reinstall the drivers if applicable. See the NIC's documentation.

• Change the auto-negotiation setting, if possible.

• Use another connector on the switch or hub.

If you are using a NIC card instead of an integrated NIC, see the documentation for the NIC card.

3. Ensure that the appropriate drivers are installed and the protocols are bound. See the NIC's documentation.
4. Enter the **System Setup** program and confirm that the NIC ports are enabled. For more information, see [Pre-operating system management applications](#).
5. Ensure that the NICs, hubs, and switches on the network are all set to the same data transmission speed. See the documentation for each network device.
6. Ensure that all network cables are of the proper type and do not exceed the maximum length.

If all troubleshooting fails, see [Getting help](#).

## Troubleshooting a wet system



**CAUTION: Many repairs may only be done by a certified service technician. You should only perform troubleshooting and simple repairs as authorized in your product documentation, or as directed by the online or telephone service and support team. Damage due to servicing that is not authorized by Dell is not covered by your warranty. Read and follow the safety instructions that are shipped with your product.**

1. Turn off the system and attached peripheral devices, and disconnect the system from the electrical outlet.
2. Open the system.
3. Disassemble components from the system.

- Hard drives
  - SAS backplane
  - Expansion-card
  - PSUs
  - Fans
  - Processors and heat sinks
  - Memory modules
4. Let the system dry thoroughly for minimum 24 hours.
  5. Reinstall the components you removed in step 3.
  6. Close the system.
  7. Reconnect the system to the electrical outlet, and turn on the system and attached peripheral devices.

If the system does not start properly, see [Getting help](#).

8. If the system starts properly, turn off the system and reinstall the expansion card that you removed, if any.
9. If the system fails to start, see [Getting help](#).

## Troubleshooting a damaged system



**CAUTION:** Many repairs may only be done by a certified service technician. You should only perform troubleshooting and simple repairs as authorized in your product documentation, or as directed by the online or telephone service and support team. Damage due to servicing that is not authorized by Dell is not covered by your warranty. Read and follow the safety instructions that are shipped with your product.

1. Turn off the system and attached peripheral devices, and disconnect the system from the electrical outlet.
2. Open the system.
3. Ensure that the following components are properly installed:
  - Expansion-card assembly
  - PSUs
  - Fans
  - Processors and heat sinks
  - Memory modules
  - hard drive carriers
4. Ensure that all cables are properly connected.
5. Close the system.
6. If the system fails to start, see [Getting help](#).

## Troubleshooting the system battery



**NOTE:** If the system is turned off for long periods of time (for weeks or months), the NVRAM may lose its system configuration information. This situation is caused by a defective battery.

1. Re-enter the time and date through the System Setup program. See [System setup options at boot](#).
2. Turn off the system and disconnect it from the electrical outlet for at least one hour.
3. Reconnect the system to the electrical outlet and turn on the system.

4. Enter the System Setup program.

If the date and time are not correct in the System Setup program, replace the battery.

 **CAUTION:** Many repairs may only be done by a certified service technician. You should only perform troubleshooting and simple repairs as authorized in your product documentation, or as directed by the online or telephone service and support team. Damage due to servicing that is not authorized by Dell is not covered by your warranty. Read and follow the safety instructions that are shipped with your product.

If the problem is not resolved by replacing the battery, see [Getting help](#).

 **NOTE:** Some software may cause the system time to speed up or slow down. If the system seems to operate normally except for the time kept in the System Setup program, the problem may be caused by software rather than by a defective battery.

## Troubleshooting PSUs

1. Identify the faulty PSU by the PSU's fault indicator. See [Power and system board indicator codes](#).

 **CAUTION:** At least one PSU must be installed for the system to operate. Operating the system with only one PSU installed for extended period can cause the system to overheat.

2. Reseat the PSU by removing and reinstalling it.

 **NOTE:** After installing a PSU, allow several seconds for the system to recognize the PSU and to determine if it is working properly. The power indicator glows green to signify that the PSU is functioning properly.

If the issue persists, replace the faulty PSU.

3. If all troubleshooting fails, see [Getting help](#).

## Troubleshooting system cooling issues

 **CAUTION:** Many repairs may only be done by a certified service technician. You should only perform troubleshooting and simple repairs as authorized in your product documentation, or as directed by the online or telephone service and support team. Damage due to servicing that is not authorized by Dell is not covered by your warranty. Read and follow the safety instructions that are shipped with your product.

Ensure that none of the following conditions exist:

- System cover, cooling shroud, drive blank, PSU blank, or front or back filler panel is removed.
- Ambient temperature is too high.
- External airflow is obstructed.
- Cables inside the system obstruct airflow.
- An individual cooling fan is removed or has failed.

## Troubleshooting a fan

 **CAUTION:** Many repairs may only be done by a certified service technician. You should only perform troubleshooting and simple repairs as authorized in your product documentation, or as directed by the online or telephone service and support team. Damage due to servicing that is not authorized by Dell is not covered by your warranty. Read and follow the safety instructions that are shipped with your product.

1. Locate the faulty fan indicated by the diagnostic software.
2. Turn off the system and all attached peripheral devices.
3. Open the system.
4. Reseat the fan's power cable.
5. Restart the system.  
If the fan functions properly, close the system.
6. If the fan does not function, turn off the system and install a new fan.
7. Restart the system.  
If the issue is resolved, close the system.
8. If the replacement fan does not operate, see [Getting help](#).

## Troubleshooting system memory

 **CAUTION:** Many repairs may only be done by a certified service technician. You should only perform troubleshooting and simple repairs as authorized in your product documentation, or as directed by the online or telephone service and support team. Damage due to servicing that is not authorized by Dell is not covered by your warranty. Read and follow the safety instructions that are shipped with your product.

 **NOTE:** Invalid memory configurations can cause your system to halt at startup without video output. See [System memory](#), and verify that your memory configuration complies with all applicable guidelines.

1. If the system is not operational, turn off the system and attached peripheral devices, and unplug the system from the power source. Wait at least 10 seconds and then reconnect the system to power.
2. Turn on the system and attached peripheral devices and note the messages on the screen.  
Go to step 10 if an error message appears indicating a fault with a specific memory module.
3. Enter the System Setup program and check the system memory settings. Make any changes to the memory settings, if needed.  
If the memory settings match the installed memory but a problem is still indicated, go to step 10.
4. Turn off the system and attached peripheral devices, and disconnect the system from the electrical outlet.
5. Remove the system-board assembly.
6. Reseat the memory modules in their sockets.
7. Install the system-board assembly.
8. Reconnect the system to its electrical outlet, and turn on the system and attached peripheral devices.  
Enter the System Setup program and check the system memory settings.

If the problem is not resolved, proceed with the next step.



9. Turn off the system and attached peripheral devices, and disconnect the system from the power source.
10. Remove the system-board assembly.
11. If a diagnostic test or error message indicates a specific memory module as faulty, swap or replace the module.
12. To troubleshoot an unspecified faulty memory module, replace the memory module in the first memory module socket with a module of the same type and capacity.
13. Install the system-board assembly.
14. Reconnect the system to its electrical outlet, and turn on the system and attached peripheral devices.
15. As the system boots, observe any error message that appears and the diagnostic indicators on the front of the system.
16. If the memory problem is still indicated, repeat step 10 through step 16 for each memory module installed.

If the problem persists after all memory modules have been checked, see [Getting help](#).

## Troubleshooting a hard drive

 **CAUTION:** Many repairs may only be done by a certified service technician. You should only perform troubleshooting and simple repairs as authorized in your product documentation, or as directed by the online or telephone service and support team. Damage due to servicing that is not authorized by Dell is not covered by your warranty. Read and follow the safety instructions that are shipped with your product.

1. If your system has a RAID controller and your hard drives are configured in a RAID array, perform the following steps:
  - a. Restart the system and enter the host adapter configuration utility program by pressing Ctrl+C for a LSI SAS 2008 mezzanine card.  
See the documentation supplied with the host adapter for information about the configuration utility.
  - b. Ensure that the hard drive(s) have been configured correctly for the RAID array.
  - c. Take the hard drive offline and reseal the drive.
  - d. Exit the configuration utility and allow the system to boot to the operating system.
2. Ensure that the required device drivers for your controller card are installed and are configured correctly. See the operating system documentation for more information.
3. Restart the system, enter the System Setup program, and verify that the controller is enabled and the drives appear in the System Setup program.

For more information, see [Pre-operating system management applications](#).

If the problem persists, see [Getting help](#).

## Troubleshooting a storage controller

 **NOTE:** When troubleshooting a SAS RAID controller, also see the documentation for your operating system and the controller.

1. Enter the System Setup program and ensure that the SAS controller is enabled. For more information, see [Pre-operating system management applications](#).
2. Restart the system and press the applicable key sequence to enter the configuration utility program.
  - Ctrl+C for a LSI SAS 2008 mezzanine card

See the controller's documentation for information about configuration settings.

3. Check the configuration settings, make any necessary corrections, and restart the system.

 **CAUTION: Many repairs may only be done by a certified service technician. You should only perform troubleshooting and simple repairs as authorized in your product documentation, or as directed by the online or telephone service and support team. Damage due to servicing that is not authorized by Dell is not covered by your warranty. Read and follow the safety instructions that are shipped with your product.**

4. Turn off the system and attached peripheral devices, and disconnect the system from its electrical outlet.
5. Remove the system-board assembly.
6. Ensure that the controller card is firmly seated into the system board connector.
7. If you have a battery-cached SAS RAID controller, ensure that the RAID battery is properly connected and, if applicable, the memory module on the RAID card is properly seated.
8. Ensure that the cables are firmly connected to the storage controller and the SAS backplane board.
9. Install the system-board assembly.
10. Reconnect the system to its electrical outlet, and turn on the system and attached peripheral devices. If the problem persists, see [Getting help](#).

## Troubleshooting expansion cards

 **NOTE:** When troubleshooting an expansion card, see the documentation for your operating system and the expansion card.

 **CAUTION: Many repairs may only be done by a certified service technician. You should only perform troubleshooting and simple repairs as authorized in your product documentation, or as directed by the online or telephone service and support team. Damage due to servicing that is not authorized by Dell is not covered by your warranty. Read and follow the safety instructions that are shipped with your product.**

1. Turn off the system and attached peripheral devices, and disconnect the system from the electrical outlet.
2. Remove the system-board assembly.
3. Ensure that each expansion card is firmly seated in its connector.
4. Install the system-board assembly.
5. Reconnect the system to the electrical outlet, and turn on the system and attached peripheral devices.
6. If the problem is not resolved, see [Getting help](#).

## Troubleshooting processors

 **CAUTION: Many repairs may only be done by a certified service technician. You should only perform troubleshooting and simple repairs as authorized in your product documentation, or as directed by the online or telephone service and support team. Damage due to servicing that is not authorized by Dell is not covered by your warranty. Read and follow the safety instructions that are shipped with your product.**

1. Turn off the system and attached peripheral devices, and disconnect the system from the electrical outlet.
2. Remove the system-board assembly.

3. Ensure that each processor and heat sink is properly installed.
4. Install the system-board assembly.
5. Reconnect the system to the electrical outlet, and turn on the system and attached peripheral devices.
6. If the problem persists, turn off the system and attached peripheral devices, and disconnect the system from the electrical outlet.
7. Remove the system-board assembly.
8. Remove processor 2.
9. Install the system-board assembly.
10. Reconnect the system to the electrical outlet, and turn on the system and attached peripheral devices.  
If the problem persists, the processor is faulty. See [Getting help](#).
11. Turn off the system and attached peripheral devices, and disconnect the system from the electrical outlet.
12. Remove the system-board assembly.
13. Replace processor 1 with processor 2.
14. Repeat step 9 through step 11.  
If you have tested both the processors and the problem persists, the system board is faulty. See [Getting help](#).

## IRQ assignment conflicts

Most PCI devices can share an IRQ with another device, but they cannot use an IRQ simultaneously. To avoid this type of conflict, see the documentation for each PCI device for specific IRQ requirements.

**Table 12. Assignment specific IRQ requirements**

IRQ Line	Assignment
IRQ0	8254 timer
IRQ1	Keyboard controller
IRQ2	Cascade for IRQ9
IRQ3	Serial port (COM2) or PCI_IRQ_POOL_DEFINITION
IRQ4	Serial port (COM1) or PCI_IRQ_POOL_DEFINITION
IRQ5	PCI_IRQ_POOL_DEFINITION
IRQ6	PCI_IRQ_POOL_DEFINITION
IRQ7	RESERVE
IRQ8	RTC
IRQ9	PCI_IRQ_POOL_DEFINITION

<b>IRQ Line</b>	<b>Assignment</b>
IRQ10	PCI_IRQ_POOL_DEFINITION
IRQ11	PCI_IRQ_POOL_DEFINITION
IRQ12	Mouse controller
IRQ13	Processor
IRQ14	Primary IDE controller
IRQ15	Secondary IDE controller

 **NOTE:** PCI\_IRQ\_POOL\_DEFINITION means BIOS code assigns at runtime.

## Jumpers and connectors

This topic provides specific information about the system jumpers. It also provides some basic information about jumpers and switches and describes the connectors on the various boards in the system. Jumpers on the system board help to disable system and setup passwords. You must know the connectors on the system board to install components and cables correctly.

### Dell XC6320 system board connectors

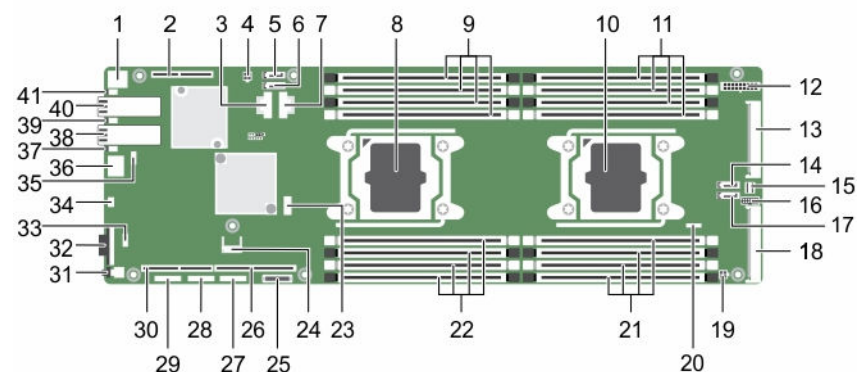

**Figure 35. Dell XC6320 system board connectors**

- |  |   |
|--|---|
| 1. rear USB Connector 1  | 2. PCI-E Gen3 x8 Mezzanine Slot 3 (Processor 1) |
| 3. mini-SAS Connector 0-3                                      | 4. HDD Power Connector                          |
| 5. onboard SATA Connector 4                                    | 6. onboard SATA Connector 5                     |
| 7. mini-SAS Connector 6-9                                      | 8. processor 1                                  |
| 9. DIMM sockets for processor 1                                | 10. processor 2                                 |
| 11. DIMM sockets for processor 2                               | 12. main power connector                        |
| 13. middle plane connector                                     | 14. SAS/SATA connector 5                        |
| 15. mini-SAS HD connector 0-3                                  | 16. control panel connector                     |
| 17. SAS/SATA connector 4                                       | 18. PCIE_G3_X16 Slot 4 (Processor 2)            |
| 19. high-power connector                                       | 20. SGPIO connector                             |
| 21. DIMM sockets for processor 2                               | 22. DIMM sockets for processor 1                |
| 23. internal USB connector 2 (Left) and USB connector 3(Right) | 24. TPM connector                               |
| 25. system battery   | 26. PCI-E Gen3 x16 slot 1 (processor 1)         |
| 27. CPLD debug connector                                       | 28. UART connector                              |

- |                                |   |
|--------------------------------|---|
| 29. CPLD JTAG connector        | 30. PCI-E Gen3 x16 Slot 2 (processor 1) |
| 31. Power button               | 32. VGA port                            |
| 33. Internal TTL COM Connector | 34. USB to Serial Port                  |
| 35. LAN Management Connector   | 36. Management Port                     |
| 37. LAN 2 LED                  | 38. LAN 2 Port                          |
| 39. LAN 1 LED                  | 40. LAN 1 Port                          |
| 41. UID LED                    |   |

**Table 13. System board connectors**

Item	Connector	Description
1	USB1	Rear USB connector 1
2	PCIE_G3_X8 (CPU1)	PCI-E Gen3 x8 mezzanine slot 3 (processor 1)
3	miniSAS0-3	Mini-SAS connector 0-3
4	HDD POWER CON	Hard drive power connector
5	SATA4	Onboard SATA connector 4
6	SATA5	Onboard SATA connector 5
7	miniSAS6-9	Mini-SAS connector 6-9
8	CPU1	Processor 1
9	DIMM_A1, DIMM_A5, DIMM_A2, DIMM_A6	DIMM sockets for processor 1
10	CPU2	Processor 2
11	DIMM_B1, DIMM_B5, DIMM_B2, DIMM_B6	DIMM sockets for processor 2
12	SATA5	SAS/SATA connector 5
13	SATA4	SAS/SATA connector 4
14	CONTROL_PANEL	Middle plane connector
15	miniSAS0-3	Mini-SAS HD connector 0-3
16	HI_PWR_CONN	High-power connector
17	SGPIO	Serial General Purpose Input/Output (SGPIO) connector
18	DIMM_B8, DIMM_B4, DIMM_B7, DIMM_B3	DIMM sockets for processor 2
19	DIMM_A8, DIMM_A4, DIMM_A7, DIMM_A3	DIMM sockets for processor 1
20	J106	Internal USB connector 2 (left) and USB connector 3 (right)
21	TPM	Trusted Platform Module (TPM) connector
22	BHI	System battery
23	PCIE_G3_X16 (CPU1)	PCI-e Gen3 x16 slot 1 (processor 1)
24	CPLD_DBG	CPLD debug connector

Item	Connector	Description
25	UART	Universal Asynchronous Receiver/Transmitter (UART) connector
26	CPLD_JTAG	Complex Programmable Logic Device (CPLD) JTAG connector
27	PCIE_G3_X16 (CPU1)	PCI-E Gen3 x16 Slot 2 (processor 1)
28	SW2	Power button
29	VGA1	VGA port
30	INT_TTL	Internal TTL COM connector
31	USB_DBG1	USB to serial port
32	MGMT	LAN management connector
33	LAN3(BMC)	Management port
34	CR21	LAN 2 LED
35	LAN2	LAN 2 port
36	CR20	LAN 1 LED
37	LAN1	LAN 1 port
38	CR3	UID LED

## LSI 2008 SAS mezzanine card connectors

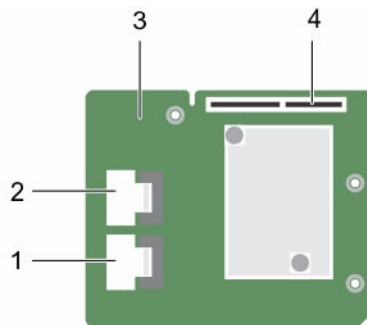

**Figure 36. LSI 2008 SAS mezzanine card connectors**

- |                                  |                                  |
|----------------------------------|----------------------------------|
| 1. mini-SAS connector (port 0-3) | 2. mini-SAS connector (port 4-7) |
| 3. LSI 2008 mezzanine card       | 4. mezzanine card connectors     |

## Jumper settings

## System configuration jumper settings on the Dell XC6320 system board

The function of system configuration jumper installed on each Dell XC6320 system board is shown below:

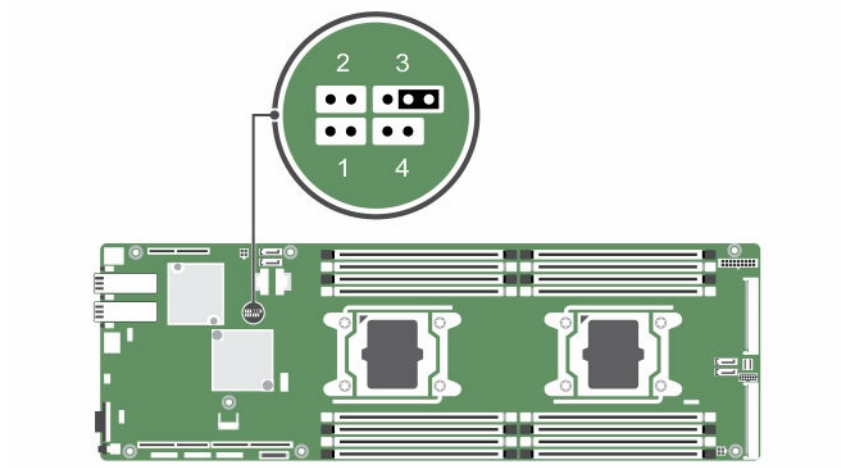

Figure 37. System configuration jumpers on the Dell XC6320 system board

Table 14. System configuration jumper on the Dell XC6320 system board

Jumpers	Function	Disabled (Default state)	Enabled
1	BIOS Recovery	No pin	Pin 1-2
2	NVRAM Clear	No pin	Pin 1-2
3	PWRD_EN	Pin 1-2	Pin 2-3
4	ME_FM Recovery	No pin	Pin 1-2



# Getting help

## Contacting Dell

Dell provides several online and telephone-based support and service options. If you do not have an active internet connection, you can find contact information on your purchase invoice, packing slip, bill, or Dell product catalog. Availability varies by country and product, and some services may not be available in your area. To contact Dell for sales, technical assistance, or customer-service issues:

1. Go to **Dell.com/support**.
2. Select your country from the drop-down menu on the bottom right corner of the page.
3. For customized support:
  - a. Enter your system Service Tag in the **Enter your Service Tag** field.
  - b. Click **Submit**.

The support page that lists the various support categories is displayed.
4. For general support:
  - a. Select your product category.
  - b. Select your product segment.
  - c. Select your product.

The support page that lists the various support categories is displayed.
5. For contact details of Dell Global Technical Support:
  - a. Click [Global Technical Support](#).
  - b. The **Technical Support** page is displayed with details to call, chat, or e-mail the Dell Global Technical Support team.

## Dell SupportAssist

For an enhanced Support Experience, Dell recommends installing and configuring Dell SupportAssist.

Dell SupportAssist is a software application that transparently collects information about your system and automatically creates support cases when issues are detected. Dell SupportAssist helps Dell to provide you an enhanced, personalized, and efficient support experience. Dell uses the data to solve common problem, designs and markets the products.

For more information about installing and configuring Dell SupportAssist, see: <http://www.dell.com/en-us/work/learn/supportassist-servers-storage-networking>.

## Locating your system Service Tag

Your system is identified by a unique Express Service Code and Service Tag number. The Express Service Code is found on the front of the system and Service Tag is found on the front of the system. Alternatively, the information may be on a sticker on the chassis of the system. This information is used

by Dell to route support calls to the appropriate personnel. The Service Tag locations on the chassis are as follows:

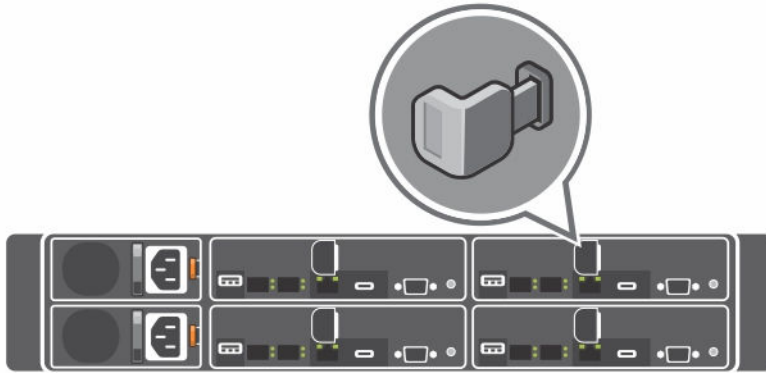

**Figure 38. Service Tag location**



**Figure 39. Service Tag location on the left front panel**



**Figure 40. Service Tag location on the chassis**

The linkage of 24 hard drives for four system boards is shown here. For information about other configurations, see the [Front panel features and indicators](#) Front panel features and indicators section of the Dell XC6320 Web-Scaled Converged Appliance Owner's Manual.

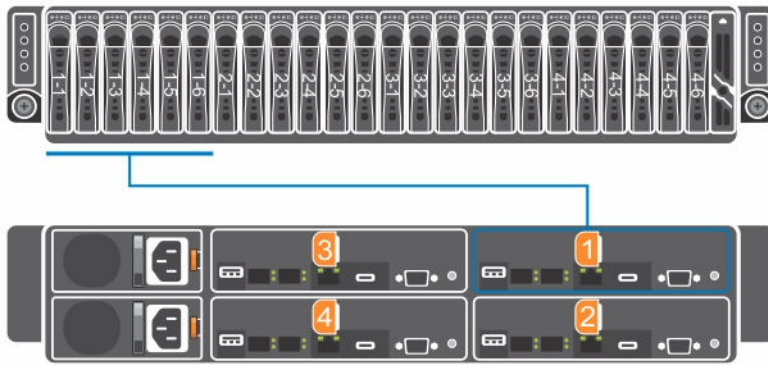



Figure 41. Service Tag linkage

 **NOTE:** Hard drives that are under warranty are linked to the appropriate Service Tag of the node.

## Quick Resource Locator

Use the Quick Resource Locator (QRL) to get immediate access to system information and how-to videos. This can be done by visiting [Dell.com/QRL](http://Dell.com/QRL) or by using your smartphone and a model specific Quick Resource (QR) code located on your Dell PowerEdge system. To try out the QR code, scan the following image.



Figure 42. Quick Resource Locator

## Free Manuals Download Website

<http://myh66.com>

<http://usermanuals.us>

<http://www.somanuals.com>

<http://www.4manuals.cc>

<http://www.manual-lib.com>

<http://www.404manual.com>

<http://www.luxmanual.com>

<http://aubethermostatmanual.com>

Golf course search by state

<http://golfingnear.com>

Email search by domain

<http://emailbydomain.com>

Auto manuals search

<http://auto.somanuals.com>

TV manuals search

<http://tv.somanuals.com>