

IMPORTANT INSTRUCTIONS

When using electrical appliances, basic precautions should always be followed to reduce the risk of fire, electric shock and injury to person, including the following:

1. Read all instructions before using this heater.
2. Heater and controls should be installed by a qualified contractor. Wiring procedures and connections should be in accordance with the National Electric Code (CEC & NEC) and local codes.
3. A heater has hot and arcing or sparking parts inside. Do not use it in areas where gasoline, paint or flammable liquids are used or stored.
4. This heater is hot when in use. To avoid burns, do not let bare skin touch hot surfaces. Keep combustible materials such as: furniture, pillows, bedding, papers, clothes and curtains away from heater.
5. To prevent a possible fire, do not block air intakes or exhaust in any manner. Do not use on soft surfaces like a bed where openings may become blocked.
6. Do not insert or allow foreign objects to enter any ventilation or exhaust opening as this may cause an electric shock or fire, or damage the heater.
7. Do not install these heaters against combustible, low density cellulose fibre surfaces or vinyl wall paper.
8. Do not locate these heaters below any electrical convenience receptacles.
9. Check nameplate ratings to be sure the heater voltage is the same as the service supply. (The nameplate is located below the right side of the heating element.)
10. **HIGH TEMPERATURES:** Keep electrical cords, furniture, draperies or any other blocking material away from the heater. See Installation Section for specific distances.

SAVE THESE INSTRUCTIONS

This equipment has been tested and found to comply with the limits for a Class B digital device, pursuant to Part 15 of the FCC Rules. These limits are designed to provide reasonable protection against harmful interference in a residential installation. This equipment generates uses and can radiate radio frequency energy and, if not installed and used in accordance with the instructions, may cause harmful interference to radio communications. However, there is no guarantee that interference will not occur in a particular installation. If this equipment does cause harmful interference to radio or television reception, which can be determined by turning the equipment off and on, the user is encouraged to try to correct the interference by one of the following measures:

- Reorient or relocate the receiving antenna.
- Increase the separation between the equipment and receiver.
- Connect the equipment into an outlet on a circuit different from that to which the receiver is connected.
- Consult the dealer or an experienced radio/TV technician for help.

This device complies with Part 15 of the FCC Rules. Operation is subject to the following two conditions: (1) This device may not cause harmful interference, and (2) this device must accept any interference received, including interference that may cause undesired operation.

 FCC CAUTION: Any changes or modifications not expressly approved by the party responsible for compliance could void the user's authority to operate this equipment.

This device complies with Industry Canada licence-exempt RSS standard(s). Operation is subject to the following two conditions: (1) this device may not cause interference, and (2) this device must accept any interference, including interference that may cause undesired operation of the device.

Installation Instructions

Placement of the Smart Baseboard

Smart Baseboards are high performance heaters designed to operate at higher outlet temperatures than conventional baseboard heaters. They can be directly mounted onto dry-wall, plaster, wood or concrete walls. Due to the higher outlet temperature, the wall surface can reach temperatures of 160° F (71° C) or above and some materials may discolor or deform at these temperatures, e.g. vinyl or plastic. In these cases the heater can be mounted with an offset from the wall and floor to reduce the temperature being applied to those materials. By installing the heater with the provided Installation Optimizer kit, the temperature of the wall above the heater can be reduced to 129° F (54° C).

! NOTE: If the unit is being installed on a newly constructed wall, ensure that all products that have been applied are fully cured according to manufacturer's instructions, before operating the unit.

Recommendations for Locating Drapes and Furniture near Heater (Figure 1)

! NOTE: Any objects or materials that are located within the distances outlined below should not discolor, nor distort dimensionally (stretch or shrink) upon extended exposure (up to 1000 hrs.) to temperatures of 200° F (93° C).

For most satisfactory operation of the heaters and minimum effect on drapes, furniture and objects in close proximity, the following recommendations should be observed:

1. **Full Length Drapes:** Hang drapes so there is at least 1.5" (3.8 cm) between the top of the drapes and the ceiling, at least 1.5" (3.8cm) between the bottom of the drapes and the finished floor covering (such as carpet, if used) AND at least 3" (7.6 cm) between the front vertical surface of the heater and the nearest fold of the drapes (opened drape). (Figure 1A)
2. **Shorter Length Drapes:** Hang drapes so there is at least 1.5" (3.8 cm) between the top of the drapes and the ceiling, and at least 6" (15.2 cm), preferably more, between the bottom of the drapes and the top horizontal surface of the heater. (Figure 1B)

3. Furniture: Place furniture no closer than 3" (7.62 cm) from the front of the Smart Baseboard. (Figure 1D)

4. Overhanging Solid Objects (Except Plastic): Position Smart baseboard so there is at least 14" (35.6 cm) between the top of the heater and any solid object that obstructs or redirects the vertical air flow out of the top of the unit. (Figure 1C)

5. Overhanging Plastic Objects: All Plastic items that cannot withstand extended exposure to temperatures 60° C or higher should be kept a minimum of 20" (50.8cm) above the unit. (Figure 1C)

! NOTE: Ensure that when 2 Smart Baseboards are installed near the same corner they are both a minimum of 6" from the corner.

Installation

All Smart Baseboards must be connected from the right side of the heater.

! NOTE: The left hand end of the enclosure can be used as a junction box and the space under the heater can be used as a wireway.

⚠ CAUTION: Disconnect power supply before installation to prevent electric shock.

1. Unpack and place Smart Baseboard on floor face up, use packaging to protect floor if required. Remove front covers.

! NOTE: Remove the center cover, by releasing the top first.

! NOTE: Heater fins can be easily bent. For optimal performance ensure that they remain vertical.

2. Orient unit in desired location and mark pilot holes - top and bottom at both ends and at least one set in middle.

3. Wire unit as per diagrams (below) and National and Local Electrical Codes.

⚠ CAUTION: Connect heaters to a branch circuit used only for permanently installed heater and protected by over current devices rated or set at no more than 30 amperes. The total connected load should not be more than 80% of the rating of the over current devices. It may cause a fire hazard if not installed and maintained in accordance with these instructions.

4. Position LPC, pushing cable back into wall (or conduit), run screws through pre-selected mounting holes and spacers (if applicable), using appropriate wall anchors, if necessary.

! NOTE: Screw should be backed off 1/2 turn from snug

position to allow free expansion and contraction of housing and to ensure quiet operation.

5. Replace covers on unit.

! NOTE: Install the center cover first, by installing the top first, then the bottom.

Usage of Multiple Smart Baseboards

Multiple Smart Baseboards can be wired in parallel on a single circuit. To use/control multiple Smart Baseboards from a single source, a CONNEX™ controller can be used. By synchronizing one CONNEX™ controller to multiple LPC's, the controller can control all of the heaters from one location. Each component must be within 15m (45ft) of any other component in the system for the entire system to operate.

Operation

1. This smart baseboard must be properly installed before it is used.

2. Prior to energizing, remove all construction dirt (plaster, sawdust, etc.) from interior and exterior of smart baseboard.

Dimplex smart baseboards are designed and tested for safe and trouble-free operation. All Dimplex smart baseboards are protected against overheating by a built-in thermal cutout. Free airflow throughout the smart baseboard is very important for the most efficient operation of the smart baseboard. Restricted airflow may cause the thermal overload protector to cycle the smart baseboard "ON and OFF". A cycling smart baseboard will not supply sufficient heat to the room.

⚠ CAUTION: Avoid direct contact of paper, fabric, or furniture with smart baseboard, to prevent a possible fire.

When power is first supplied to the LPC the Setpoint Temperature will flash in the temperature display area. At any time either the + or - button can be pressed to have the temperature setpoint displayed again.

A. Setting/Temperature Display 88.5°

The LPC is designed to control the temperature of a room anywhere from 32-86°F (0-30°C). Pressing the + or - will increase or decrease the desired temperature for the room to be heated by 0.5° (in either °C or °F).

After 5 seconds the Setpoint Temperature will switch to display the intake temperature of the room.

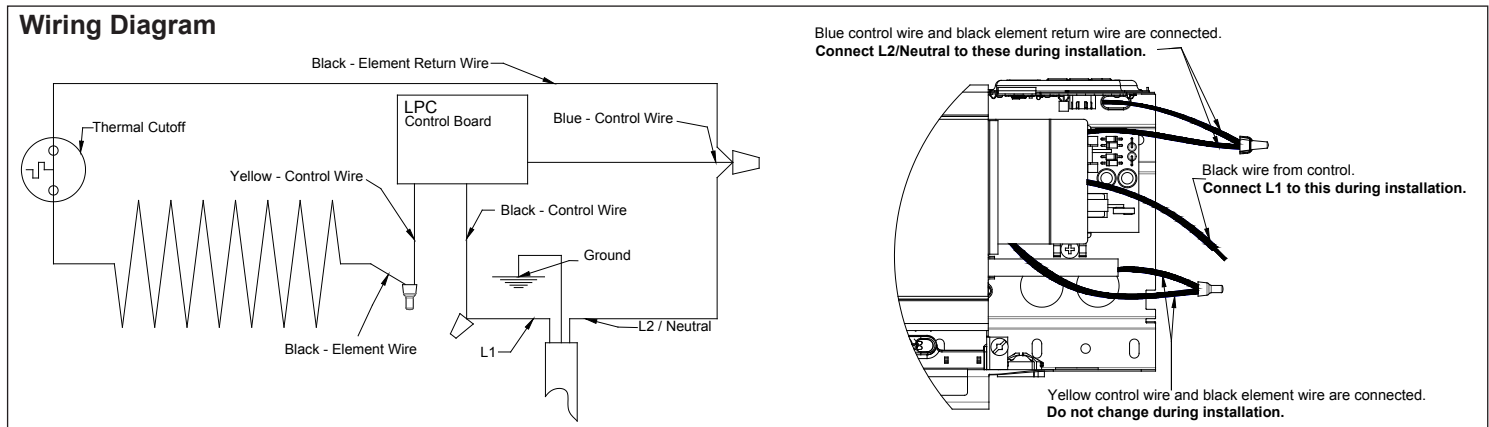

! NOTE: Pressing the + and - at the same time will toggle between °C and °F.

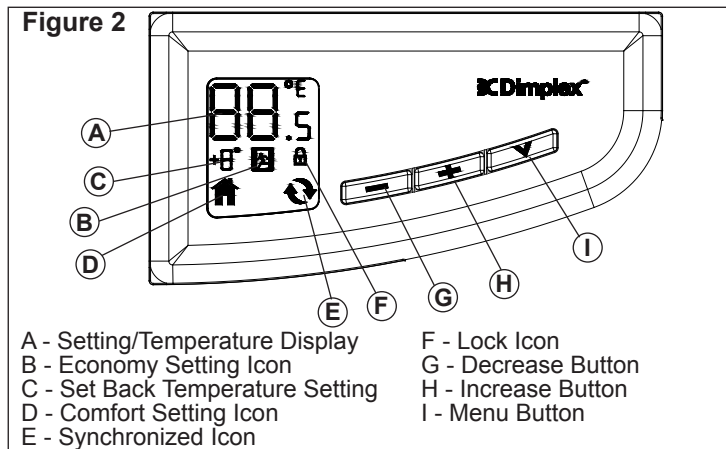
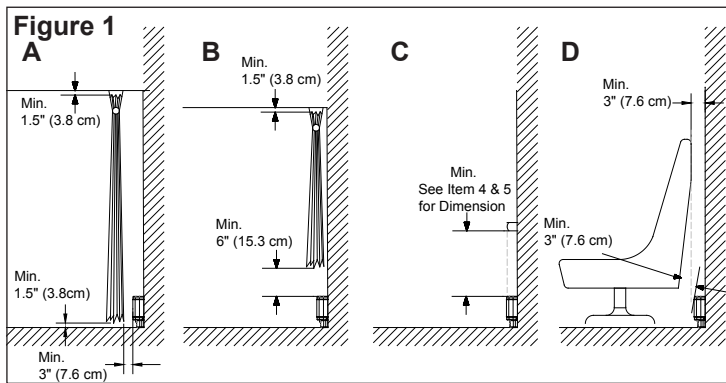



B. Economy Setting

The Economy Setting can be used to change the Setpoint Temperature for a variable period of time. By pressing the **V** the Economy Setting will be enabled - signified by the icon flashing. After the Set Back Temperature has been set, the icon will become solid after three seconds and the Set Back Temperature will be enabled.



To return back to the Comfort Setting press the **V** button and the  icon will disappear and the  icon will appear.

C. Set Back Temperature Setting

The Set Back Temperature Setting is used during periods when the Economy setting feature is active. This temperature adjustment can be set by pressing the **V** followed by the **+** or **-**.

D. Comfort Setting

The Comfort Setting icon will be displayed when the heater is in normal operation based on the Setpoint Temperature for the room.

! NOTE: Either the  or  icon will always be visible, dependent on the setting being used.

E. Synchronized Icon

The LPC features CONNEX™, a wireless technology that works with Dimplex single and multi-zone CONNEX™ controllers to provide simple whole home connectivity and comfort. CONNEX™ controllers are available to control one or multiple LPC's or PCH's within a 50' (15 m) radius. In order for the controller to have this function the LPC and the controller will need to be synchronized. To do this:

1. On the LPC heater press and hold the **V** button for 3 seconds,

both the  and  icons will begin to flash.

2. Press the **-**, **+** and then **V**, on the LPC heater.
3. Within 10 seconds press any button once on the CONNEX™ controller.

! NOTE: There is a 3 second delay between pressing the last button on the CONNEX™ controller and the LPC heater.

! NOTE: To desynchronize a LPC heater from the synchronized CONNEX™ controller, on the LPC heater:

1. Press and hold the **V** for 3 seconds.
2. Press the **V**, **+** and then **-**.



Nothing needs to be done to the CONNEX™ controller.

Dimplex single and multi-zone CONNEX™ controllers are sold separately and are available for purchase from your authorized Dimplex dealer.

To find your local Dimplex dealer, visit www.dimplex.com.

F. Lock Icon

The Smart Baseboard has a Button Lock feature, to prevent settings from accidentally being changed.

1. Press and hold the **V** for 3 seconds. Both the  and  icons will begin to flash.
2. **To Enable:** Within 5 seconds press **+**, then **-**, then **+**, then **-**. The  icon will now be visible.

To Disable: Within 5 seconds press **-**, then **+**, then **-**, then **+**. The  icon will not be visible.

! NOTE: The LPC can be locked in either the Comfort or Economy Setting. Ensure that the desired icons are present when locking is complete.

Maintenance

! CAUTION: Before removing the front cover for cleaning, make certain the power has been turned off at the circuit breaker panel, to prevent electric shock.

! CAUTION: To avoid burns, allow adequate time for the element and body casing to cool before attempting to work on the smart baseboard.

The LPC series contain no moving parts. Since the appliance contains no moving parts, little maintenance is required beyond vacuum cleaning. It is however essential that the smart baseboard is not operated with an accumulation of dust or dirt on the element, as this can cause a build up of heat and eventual damage. For this reason the smart baseboard must be inspected regularly, depending upon conditions and at least at yearly intervals. Once cleaning is complete replace the front cover and restore power.

! NOTE: The user can perform cleaning ONLY. All other servicing should be performed by qualified service personnel.

Warranty

The Manufacturer warrants the Smart Baseboard and components of the enclosed product against any defect in material or workmanship for a period of one year from the date of purchase, with the exception of the elements which are warranted to be free from defect in material and workmanship for ten years. In full satisfaction of any claims under this Warranty the Manufacturer will repair or replace without charge, in its factory or in the field as it alone may decide, any parts which

in its opinion are defective.

The Manufacturer shall not be responsible for any transportation or shipping costs in relation to such repair or replacement except as specifically assumed by it. Misuse of this product or repairs by persons other than the Manufacturer's authorized personnel without the Manufacturer's written approval will void this Warranty.

This Warranty is in lieu of all other warranties or conditions whether expressed or implied including but not limited to those of merchantability or fitness for purpose and shall constitute the sole remedy of the Purchaser and the sole liability of the Manufacturer in respect of the sale of the product, whether in the nature of breach or breach of fundamental term, or of negligence or otherwise.

The Manufacturer shall not be liable for any special, indirect or consequential damages or for any damages resulting from removal or replacement of a Smart Baseboard subject to warranty claim without the Manufacturer's authorization.

This Warranty is transferable by the original consumer purchaser of the product. Any claims under this Warranty must be submitted in writing to the Service Manager, Dimplex North America Ltd., 1367 Industrial Rd., Cambridge, Ontario N3H 4W3, Canada.



1367 Industrial Road • Cambridge ON Canada N3H 4W3
1-888-346-7539 • www.dimplex.com

In keeping with our policy of continuous product improvement, we reserve the right to make changes without notice.
© 2016 Dimplex North America Limited



Free Manuals Download Website

<http://myh66.com>

<http://usermanuals.us>

<http://www.somanuals.com>

<http://www.4manuals.cc>

<http://www.manual-lib.com>

<http://www.404manual.com>

<http://www.luxmanual.com>

<http://aubethermostatmanual.com>

Golf course search by state

<http://golfingnear.com>

Email search by domain

<http://emailbydomain.com>

Auto manuals search

<http://auto.somanuals.com>

TV manuals search

<http://tv.somanuals.com>