

⚠ IMPORTANT INSTRUCTIONS

When using electrical appliances, basic precautions should always be followed to reduce the risk of fire, electric shock and injury to person, including the following:

1. Read all instructions before using this heater.
2. The heater is hot when in use. To avoid burns, do not let bare skin touch hot surfaces. Keep combustible materials, such as furniture, pillows, bedding, papers, clothes, and curtains at least a 3 ft. (1 m) from the front of the heater and keep them away from the sides.
3. Wiring procedures and connections should be in accordance with the National Electric Code (NEC & CEC) and local codes.
4. Extreme caution is necessary when any heater is used by or near children or invalids and whenever the unit is left operating and unattended.
5. Do not operate any heater after it malfunctions. Disconnect power at service panel and have heater inspected by a certified electrician before reusing.
6. To disconnect heater, turn off power to heater circuit at main disconnect panel.
7. Do not use outdoors.
8. Use this heater only as described in this manual. Any other use not recommended by the manufacturer may cause fire, electric shock, or injury to persons.
9. A heater has hot and arcing or sparking parts inside. Do not use it in areas where gasoline, paint or flammable liquids are used or stored.
10. This heater is hot when in use. To avoid burns, do not let bare skin touch hot surfaces. Keep combustible materials such as: furniture, pillows, bedding, papers, clothes and curtains away from heater.
11. Do not insert or allow foreign objects to enter any ventilation or exhaust opening as this may cause an electric shock or fire, or damage the heater.
12. To prevent a possible fire, do not block air intake or exhaust in any manner.

! NOTE: This equipment has been tested and found to comply with the limits for a Class B digital device, pursuant to Part 15 of the FCC Rules. These limits are designed to provide reasonable protection against harmful interference in a residential installation. This equipment generates, uses and can radiate radio frequency energy and, if not installed and used in accordance with the instructions, may cause harmful interference to radio communications. However, there is no guarantee that interference will not occur in a particular installation. If this equipment does cause harmful interference to radio or television reception, which can be determined by turning the equipment off and on, the user is encouraged to try to correct the interference by one of the following measures:

- Reorient or relocate the receiving antenna.
- Increase the separation between the equipment and receiver.
- Connect the equipment on a circuit different from that to which the receiver is connected.
- Consult the dealer or an experienced radio/TV technician for help.

This device complies with Part 15 of the FCC Rules. Operation is subject to the following two conditions: (1) This device may not cause harmful interference, and (2) this device must accept any interference received, including interference that may cause undesired operation.

⚠ FCC CAUTION: Any changes or modifications not expressly approved by the party responsible for compliance could void the user's authority to operate this equipment.

This device complies with Industry Canada licence-exempt RSS standard(s). Operation is subject to the following two conditions: (1) this device may not cause interference, and (2) this device must accept any interference, including interference that may cause undesired operation of the device.

SAVE THESE INSTRUCTIONS

✂ Installation Instructions

Figure 1

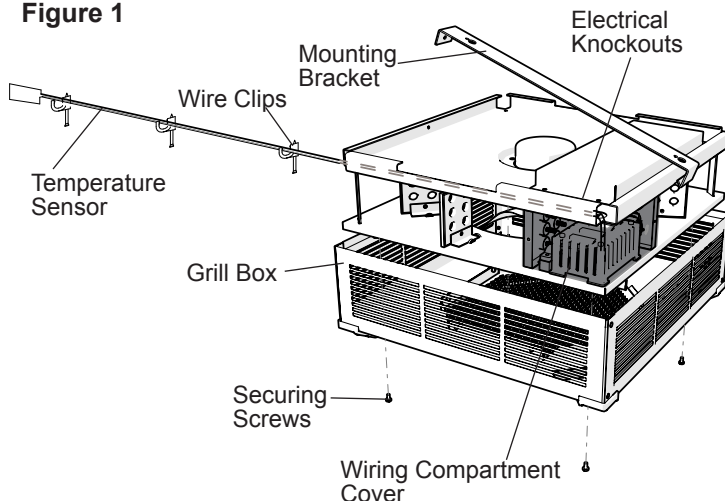

⚠ WARNING: Wiring procedures and connections should be in accordance with the National Electric code (NEC) and local codes.

⚠ WARNING: To reduce the risk of fire, do not store or use gasoline or other flammable vapors and liquids in the vicinity of the heater.

⚠ CAUTION: The heater should be mounted for DOWNWARD discharge only.

⚠ CAUTION: High temperature, risk of fire, keep electrical cords, drapery, furnishings, and other combustibles at least 3 feet (0.9m) from the front of the heater and away from the side and rear.

1. Unpack the heater from the carton.
2. With the unit outlet pointing up, using the provided allen key, remove the 4 screws to remove the grill box off of the unit.
3. Flip the unit over and loosen 1 screw to remove the mounting bracket.
4. Determine the desired location, keeping in mind the **minimum** clearances indicated in Figure 2.
5. Secure the mounting bracket to the ceiling.

⚠ CAUTION: The ceiling and mounting hardware must have adequate strength to support the heater. Attachment to a firm support is a necessity.

6. Loosen 2 screws to remove the wiring compartment cover. (Figure 1)
7. Remove the desired knockout from the terminal box.

! NOTE: It is only necessary to remove the knockout(s) that will feed the power supply wiring, keeping in mind the heater mounting location and supply wire location.

Figure 2

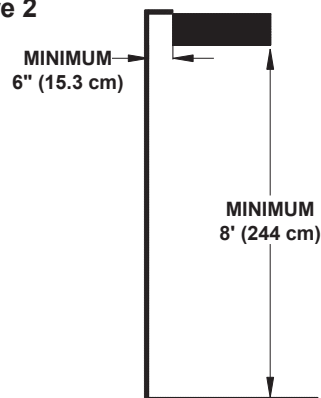

- Hang the heater from the hooked edge of the mounting bracket.
- Connect the power supply wires to the wires in the unit - black (L1) and white (L2). Ground wire should be secured to the green wire provided inside of the heater.

⚠ WARNING: All wiring must be installed by a certified electrician according to the electrical safety. The ceiling heater must be grounded in accordance with all national and local building codes.

- Replace the wiring compartment cover and replace with the 2 screws.
- Locate and secure the external temperature sensor to the ceiling with the provided wire clips. It is recommended that the sensor wire be fully extended for optimal control of the room temperature. (Figure 1)
- Swing the heater upwards to secure the opposite side of the heater to the bracket and secure with previously removed screws.
- Replace the grill box.



⚠ WARNING: TO PREVENT THE RISK OF FIRE OR INJURY, DO NOT OPERATE THE HEATER UNLESS IT IS FULLY ASSEMBLED.

Initial Set Up

After the unit has been installed, calibration of the unit to the area will be required. This can be done by closing all doors and windows to the room and turning the unit ON. When the unit is initially turned on there is a 28 minute period of calibration of the unit where the software runs at full power for 20 minutes, then runs for 8 minutes to cool the heater down.

If the unit is relocated or the size of the area that it is installed in changes, it is recommended that the unit be reset to the factory default to allow the unit to recalibrate.

Factory Default

- Press and hold the **V** for 3 seconds. Both the  and  icons will begin to flash.
- Within 5 seconds press **+**, then **+**, then **-**, then **-**, then **V**, then **-**.

Wiring Diagram

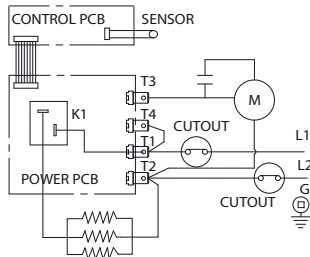
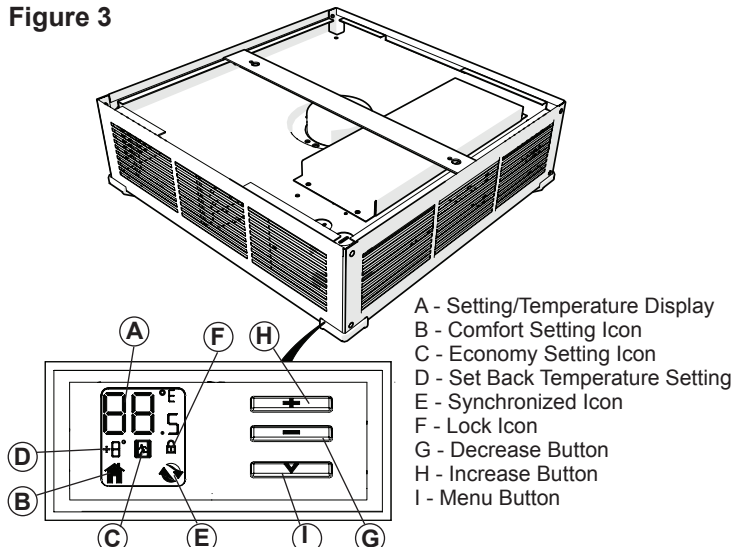

Figure 3



Operation Instructions

⚠ WARNING: This heater is factory pre-wired for operation with the built-in thermostat. THIS HEATER IS NOT TO BE USED WITH A REGULAR WALL THERMOSTAT.

⚠ CAUTION: This heater must be properly installed before it is used. The RCH is designed with heating elements that will turn on and off based on the built-in temperature sensor to maintain a constant room temperature.

! NOTE: The element retains heat after shutdown, there is a built in cool down period of 5 minutes before the fan shuts off completely.

Manual Controls

(See Figure 3 for display reference)

When power is first supplied to the RCH the Set point Temperature will flash in the temperature display area. At any time either the **+** or **-** button can be pressed to have the temperature set point displayed again.

A. Setting/Temperature Display

The RCH is designed to control the temperature of a room from 41-86°F (5-30 °C). By pressing the **+** or **-** will increase or decrease the desired temperature for the room to be heated by 0.5° (in either °C or °F).



When adjusting the Set point Temperature the display will switch back to display the ambient temperature after 5 seconds.

! NOTE: The unit can be set to run continuously as a fan by setting the temperature at 41 °F (5 °C). At this temperature the heater will not turn on.

! NOTE: Pressing the **+** and **-** at the same time will toggle between °C and °F.



B. Comfort Setting

The Comfort Setting icon will be displayed when the heater is in normal operation based on the Set point Temperature for the room.

! NOTE: Either the  or  icon will always be visible, dependent on the setting being used.

C. Economy Setting

The Economy Setting can be used to change the Set point Temperature for a user determined period of time. By pressing the **V** the Economy Setting will be enabled - signified by the icon flashing. After the Set Back Temperature has been set, the icon will become solid after three seconds and the Set Back Temperature will be enabled.



To return back to the Comfort Setting press the **V** button. The  icon will disappear and the  icon will appear.

D. Set Back Temperature Setting

The Set Back Temperature Setting is used during periods when the Economy setting feature is active. This temperature adjustment can be set by pressing the **V** followed by the **+** or **-**.

E. Synchronized Icon

The RCH features CONNEX™, a wireless technology that works with Dimplex CONNEX™ controllers to provide simple whole home connectivity and comfort (a single zone controller is included). CONNEX™ controllers are available to control one or multiple CONNEX™ series heaters within a 50' (15 m) radius. In order for the controller to have this function the RCH and the controller will need to be synchronized. To do this:

- On the RCH press and hold the **V** button for 3 seconds, both the  and  icons will begin to flash.
- Press the **-**, **+** and then **V**, on the RCH.
- Within 10 seconds press any button once on the CONNEX™ Controller.

! NOTE: There is a 3 second delay between pressing the last button on the controller and the RCH.

! NOTE: To desynchronize a RCH from the synchronized CONNEX™ Controller; on either the RCH or the controller:

1. Press and hold the **V** for 3 seconds.
2. Press the **V**, **+** and then **-**.





Nothing will need to be done to the other component.

The Dimplex multi-zone CONNEX™ controller is sold separately and is available for purchase from your authorized Dimplex dealer.

To find your local Dimplex dealer, visit www.dimplex.com.

F. Lock Icon

The RCH has a Lock feature to prevent settings from accidentally being changed.

1. Press and hold the **V** for 3 seconds. Both the  and  icons will begin to flash.
2. **To Enable:** Within 5 seconds press **+**, then **-**, then **+**, then **-**.
The  icon will appear
To Disable: Within 5 seconds press **-**, then **+**, then **-**, then **+**.
The  icon will disappear.

! NOTE: The RCH can be locked in either the Comfort or Economy Setting. Ensure that the desired icons are present when locking is complete.

Maintenance Instructions

! WARNING: Always disconnect power at the circuit breaker to the unit prior to performing any maintenance or service operation.

! CAUTION: Allow adequate time for the element and body casing to cool before attempting to work on the heater.

It is suggested that the heater be inspected regularly, for cleanliness of the fan intake and exhaust grilles, to ensure optimal performance is maintained. The grilles can be cleaned either by vacuuming off all dust and dirt or, washing the grille box in warm, soapy water and allowing to dry thoroughly before reinstalling. Once cleaning is complete replace the grille and restore power.

! WARNING: TO PREVENT THE RISK OF FIRE OR INJURY, DO NOT OPERATE THE HEATER UNLESS IT IS FULLY ASSEMBLED.

At least at yearly intervals the wire connection condition should be inspected to ensure full electrical continuity and optimal performance is maintained.

! WARNING: The user can perform cleaning ONLY. All other servicing should be performed by qualified service personnel.

Warranty

The Manufacturer warrants the RCH series ceiling heaters and components of the enclosed product against any defect in material or workmanship for a period of one year from the date of purchase. In full satisfaction of any claims under this Warranty the Manufacturer will repair or replace without charge, in its factory or in the field as it alone may decide, any parts which in its opinion are defective.

The Manufacturer shall not be responsible for any transportation or shipping costs in relation to such repair or replacement except as specifically assumed by it. Misuse of this product or repairs by persons other than the Manufacturer's authorized personnel without the Manufacturer's written approval, will void this Warranty.

This Warranty is in lieu of all other warranties or conditions whether express or implied including but not limited to those of merchantability or fitness for purpose and shall constitute the sole remedy of the Purchaser and the sole liability of the Manufacturer in respect of the sale of the product, whether in the nature of breach or breach of fundamental term, or of negligence or otherwise.

The Manufacturer shall not be liable for any special, indirect or consequential damages or for any damages resulting from removal or replacement of a heater subject to warranty claim without the Manufacturer's authorization.

This Warranty is transferable by the original consumer purchaser of the product. Any claims under this Warranty must be submitted in writing to the Service Manager, Dimplex North America Ltd., 1367 Industrial Rd., Cambridge, Ontario N4H 4W3, Canada.

Replacement Parts

Cutout	RCH-CUTOUT-RP
Fan Blade	RCH-FAN-RP
Motor	RCH-MOTOR-RP
Housing Cover	RCH-COVER-CX-RP
Display Board	CMH-DISPLAYPCB-RP
Power Board	RCH-POWERPCB-RP
Control Sensor	RCH-3FNTCRP

CONNEX™ Controllers

Single Controller	DPCRWS
Multi-zone Controller	CX-MPC



1367 Industrial Road • Cambridge ON Canada N4H 4W3

1-888-346-7539 • www.dimplex.com

In keeping with our policy of continuous product improvement, we reserve the right to make changes without notice.

© 2016 Dimplex North America Limited



Free Manuals Download Website

<http://myh66.com>

<http://usermanuals.us>

<http://www.somanuals.com>

<http://www.4manuals.cc>

<http://www.manual-lib.com>

<http://www.404manual.com>

<http://www.luxmanual.com>

<http://aubethermostatmanual.com>

Golf course search by state

<http://golfingnear.com>

Email search by domain

<http://emailbydomain.com>

Auto manuals search

<http://auto.somanuals.com>

TV manuals search

<http://tv.somanuals.com>