

DJI GOGGLES

User Guide V1.0

2017.05

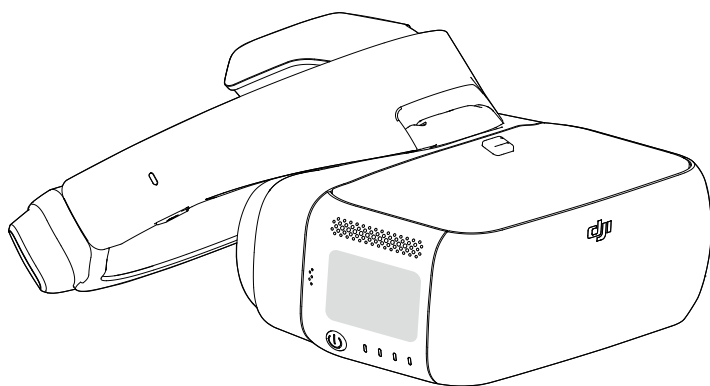

Searching for Keywords

Search for keywords such as “battery” and “install” to find a topic. If you are using Adobe Acrobat Reader to read this document, press Ctrl+F on Windows or Command+F on Mac to begin a search.

Navigating to a Topic

View a complete list of topics in the table of contents. Click on a topic to navigate to that section.

Printing this Document

This document supports high resolution printing.

Using This Manual

Legends

 Warning

 Important

 Hints and Tips

 Reference

Read Before First Usage

Please read the following documents before using the DJI™ Goggles:

1. DJI Goggles In the Box
2. DJI Goggles Disclaimer and Safety Guidelines
3. DJI Goggles Quick Start Guide
4. DJI Goggles User Manual

We recommend you check that you have all of the included parts listed in In the Box. Please watch all the tutorial videos on the official DJI website and read the disclaimer to understand your legal rights and responsibilities. Prepare for your first usage by reviewing the Quick Start Guide and refer to the User Manual for more details. If you have any questions or problems during the installation, maintenance or use of this product, please contact DJI or a DJI authorized dealer.

Video Tutorials

Please watch the tutorial videos in the link below, which demonstrate how to use the DJI Goggles safely:

<http://www.dji.com/dji-goggles/info#video>

Download the DJI Assistant 2

Download DJI ASSISTANT™ 2 at

<http://www.dji.com/dji-goggles/info#downloads>

DJI Assistant 2 supports Windows 7 (or later) or OS X 10.11 (or later).

Contents

Using This Manual	2
Legends	2
Read Before First Usage	2
Video Tutorials	2
Download the DJI Assistant 2	2
Contents	3
Product Profile	4
Introduction	4
At a Glance	4
Installation and Wearing	5
Usage	6
Operating Control	6
Connection	7
Main Screen	11
Controlling the Aircraft	13
Video Play	14
Charging the Goggles	15
Upgrading Firmware	16
DJI Assistant 2	16
DJI GO 4 App	16
Cleaning and Maintenance	16
Cleaning the Goggles	16
Maintenance of Lenses	17
Specifications	17

Product Profile

Introduction

DJI Goggles are equipped with high-performance displays and an ultra-low latency video downlink for use with DJI aircraft, giving you a real-time aerial FPV (First Person View) experience. Goggles can also be used to play HD videos, bringing you an immersive high-definition viewing experience.

Their intuitive and functional design makes them easy to operate using only your right hand. Goggles support head tracking, allowing aircraft and gimbal to be controlled using head movements. With DJI Intelligent Flight Modes, a whole new way of flying is introduced.

At a Glance

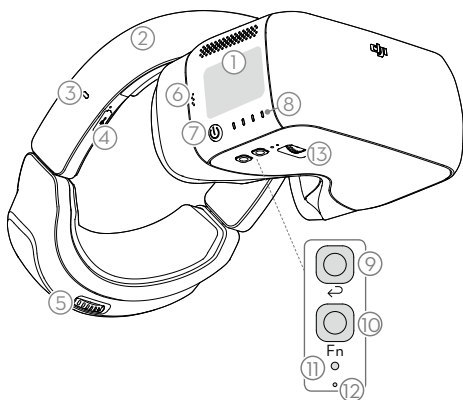

1. Touch Panel
2. Headband
3. Charging Status Indicator
4. Micro USB Port
5. Headband Knob
6. Speaker
7. Power Button
8. Battery Level Indicators
9. Back Button
10. Function Button
11. Link Button
12. Linking Status Indicator
13. IPD (Interpupillary Distance) Knob

14. Lens
15. Proximity Sensor
16. Headband Buckle
17. Heat Vent
18. Micro SD Card Slot
19. 3.5 mm Audio Port
20. HDMI Type-D Port
21. Speaker

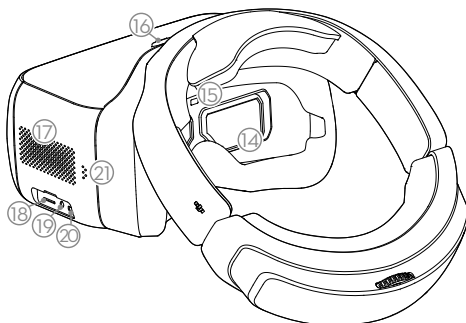

Installation and Wearing

1. Insert the Headband into the slot above the Goggles body until you hear a click. Now check that it has been securely fastened.

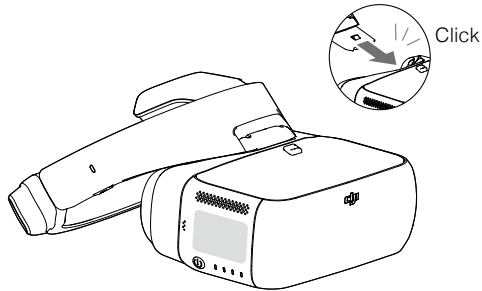

Press the Headband Buckle and move it in the opposite direction to release the Headband.

2. Align the lenses over your eyes and pull the Headband down. Adjust the Headband Knob until the Goggles fit snugly and comfortably on your face and head.

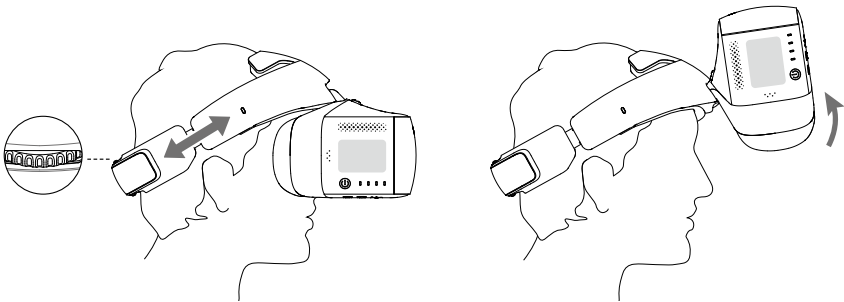

- Goggles can be worn over glasses.
- When putting the Goggles on, you can flip the Goggles body to see the world outside.

3. Turn the IPD Knob to adjust the distance between the lenses until the images are properly aligned.

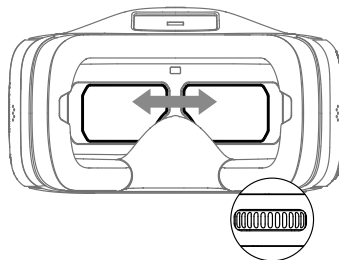

Usage

Operating Control

[1] Power Button

Press the power button once, then press it again and hold to turn the Goggles on/off. Battery level indicators will display the current battery level.



[2] Battery Level Indicators

When the battery is powered off, press the power button once to light up the battery level indicators to display the current battery level.

 The battery level indicators will also show the current battery level during charging and discharging. The indicators are defined below:

- LED on
- LED flashing
- LED off

Battery Level Indicators

LED1	LED2	LED3	LED4	Battery Level
<input type="radio"/>	<input type="radio"/>	<input type="radio"/>	<input type="radio"/>	87.5%~100%
<input type="radio"/>	<input type="radio"/>	<input type="radio"/>	<input checked="" type="radio"/>	75%~87.5%
<input type="radio"/>	<input type="radio"/>	<input type="radio"/>	<input type="radio"/>	62.5%~75%
<input type="radio"/>	<input type="radio"/>	<input checked="" type="radio"/>	<input type="radio"/>	50%~62.5%
<input type="radio"/>	<input type="radio"/>	<input type="radio"/>	<input type="radio"/>	37.5%~50%
<input type="radio"/>	<input checked="" type="radio"/>	<input type="radio"/>	<input type="radio"/>	25%~37.5%
<input type="radio"/>	<input type="radio"/>	<input type="radio"/>	<input type="radio"/>	12.5%~25%
<input checked="" type="radio"/>	<input type="radio"/>	<input type="radio"/>	<input type="radio"/>	0%~12.5%
<input type="radio"/>	<input type="radio"/>	<input type="radio"/>	<input type="radio"/>	=0%

[3] Touch Panel

Use the touch panel with your right hand to control on-screen operations.

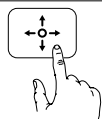

↔ Browse the menu and swipe right/left

↑↓ Browse the menu and swipe up/down

○ Tap to confirm

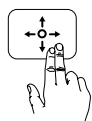

← Lock the touch panel to make it non-functional

→ Unlock the touch panel

↓ Enter shortcut menu

↑ Exit shortcut menu

○ Tap and hold to screenshot, and the image will be saved in the Micro SD card of the Goggles.*

* Please ensure the Micro SD card is inserted into the Goggles.

[4] Charging Status Indicator

This indicates the current charging status. The LED will be solid red, yellow or green to reflect low, medium, and high power levels respectively.

Blinking Red	Solid Red	Solid Yellow	Solid Green
Headband abnormal	0~29%	30~89%	90~100%

[5] Back Button

Press this to return to the previous menu, or exit the current Intelligent Flight Mode.

[6] Function Button

For aircraft that support focus (e.g. MAVIC™ Pro, PHANTOM™ 4 Pro), press this to show the focus cursor on the display screen and swipe forward and backward on the touch panel with one finger to zoom in or out. Move your head then tap the touch panel to define the focus point.

 The Goggles support up to 4x zoom on the Mavic Pro.

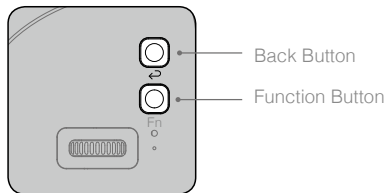
**[7] Link Button**

When connected with the aircraft by OCUSYNC™, press the link button with an appropriate tool to start linking.

[8] Linking Status Indicator

Indicates the linking status of the Goggles and the aircraft. The indicator will be solid red while linking and will go solid green when linked.

Connection

Goggles support a wide range of DJI aircraft and different uses. Please follow the steps below to connect.

Mavic Pro

With OCUSYNC, the Goggles can be connected to the Mavic Pro wirelessly.



- Toggle the control mode switch of the Mavic Pro to RC mode before linking.
- Ensure that the DJI GO™ 4 app is updated to the latest version.

Standard Mode

Standard Mode is suitable for both single and dual operator aircraft control. In this mode, the pilot using the remote controller can focus on flight, while the Goggles operator can view the environment in real-time FPV for more intuitive control. By moving their head, the Goggles wearer can control aircraft orientation or gimbal movement.

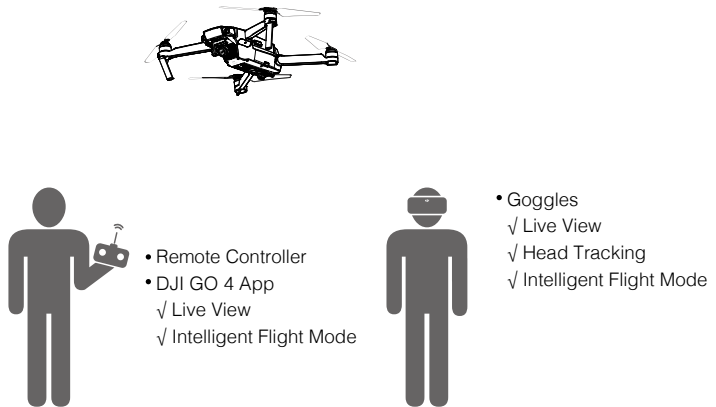

-
-  • If the remote controller and Goggles are operated by the same user, a spotter who is able to give instructions and warnings is required to ensure safe flying.
- In Head Tracking Flight, aircraft yaw can be controlled by both the Goggles and the remote controller. With Head Tracking Gimbal, the gimbal will only move with the movement of the Goggles.
-

Linking Method

1. Ensure both the aircraft and the remote controller are powered on and linked.
2. Put on the Goggles and power on.
3. Press the link button on Goggles or use the touch panel to enter "Tools > Settings > Linking Settings", select "Quick Linking" and confirm. The Goggles linking status indicator will go solid red on standby for linking.
4. Press the link button on the Mavic Pro. Once linked, the Goggles linking status indicator will turn solid green.

Coach Mode

Coach Mode is suitable for dual operator aircraft control. In this mode, the pilot using the remote controller can focus on flight, while the Goggles operator with a slave remote controller can view the environment in real-time FPV for more intuitive control.

By moving their head, the Goggles wearer can control aircraft orientation or gimbal movement. They can also control the aircraft with the secondary slave remote controller that is inferior to the priority control of the primary remote controller. Please note that only the DJI GO 4 app connected with the primary remote controller and the Goggles can display the live view.



- Remote Controller (primary)
- DJI GO 4 App
- √ Live View
- √ Intelligent Flight Mode



- Goggles (secondary)
- √ Live View
- √ Head Tracking
- √ Intelligent Flight Mode
- Remote Controller (secondary slave)
- ⌚ +2 s
- ⚠ Can't switch flight modes.
- No live view, only support settings.



- Only the primary remote controller can switch flight modes.
- If two operators control the aircraft simultaneously, the commands from the primary remote controller takes priority of aircraft movements (control sticks and gimbal dial). The secondary slave remote controller only works if the primary remote controller is not being operated for more than two seconds, whereas the primary remote controller can always override it to regain control. The two remote controllers follow the same priority for other commands.

Linking Method

1. Please ensure that both the aircraft and the primary remote controller are powered on and linked together.
2. Put on the Goggles and power on.
3. Use the touch panel to enter "Tools > Settings > Linking Settings".
4. Select "Advanced Linking > Connect one set of Goggles" and confirm. The Goggles linking status indicator will go solid red to wait for linking.
5. Press the Link button on the Mavic Pro. Once linked, the linking status indicator will turn solid green.
6. Select "Connect Remote Controller" and confirm in Goggles.
7. Power on the secondary slave remote controller and connect it with the mobile device.
8. Launch the DJI GO 4 app and enter the camera view. Press , then select "Remote Controller Linking > Secondary Remote Controller," for successful linking in a few seconds.

Multisuser Mode

Multisuser Mode is suitable for dual (or more) aircraft operator control. In this mode, the Goggles operators with a slave remote controller can view the environment in real-time FPV for more intuitive control. Please note that only the Goggles will display live view and that the primary Goggles only support head tracking.

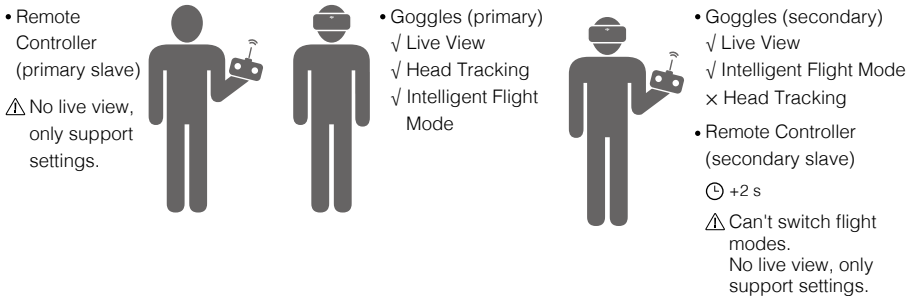

- ⚠ If the remote controller and Goggles are operated by one person but for two users, a spotter who is able to instruct and give warning is required for safe flying.
- Only the primary remote controller can switch flight modes.
- Secondary Goggles do not support head tracking.
- If two operators control the aircraft simultaneously, the commands from the primary slave remote controller takes priority of aircraft movements (control sticks and gimbal dial). The secondary slave remote controller only works if the primary slave remote controller is not being operated for more than two seconds, whereas the primary slave remote controller can always override it to regain control. The two remote controllers follow the same priority for other commands.

Linking Method

1. Put on the Primary Goggles and power on.
2. Use the touch panel to enter "Tools > Settings > Linking Settings".
3. Select "Advanced Linking > Connect two sets of Goggles > Primary/Remote Controller" and confirm. The linking status indicator will go solid red to wait for linking.
4. Press the Link button on the Mavic Pro. Once linked, the linking status indicator will turn solid green.
5. Select whether to connect with the remote controller in the Goggles. Next, power on the primary slave remote controller and connect it with a mobile device, if required.
6. Launch the DJI GO 4 app and enter the camera view. Press , then select "Remote Controller Linking > Primary Remote Controller". They will link after a few seconds.
7. Repeat the above steps for the secondary pair of Goggles and the slave remote controller. Please note that you must select "Advanced Linking > Connect two sets of Goggles > Secondary/Remote Controller" in the Goggles, and then select "Remote Controller Linking > Secondary Remote Controller" on the mobile device.

Other DJI Aircraft

The Goggles can also support other DJI aircraft. Ensure that the aircraft is linked with the remote controller and then connect the Goggles to the Micro USB port or the HDMI port of the remote controller.

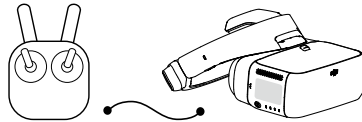

INSPIRE™ 2*
PHANTOM 4 Series**

Micro USB cable

Support Head Tracking, Intelligent Flight Modes, and Live view.

INSPIRE Series
PHANTOM 4 PRO+
PHANTOM 4 ADVANCED+

HDMI cable

Support only Live view. Aircraft operation is not supported.

* For the Inspire 2, if the Goggles are connected with the remote controller via the USB cable, only live view and somatic control of the focus is supported.

** Please note that the Phantom 4 Pro+/Advanced+ remote controller must have the latest firmware update.

When using an HDMI cable, you can secure the wire clip to the left side of the Goggles headband, which allows the HDMI cable to pass through the clip recess down your back.

Main Screen

The main screen of the Goggles and functions are described as follows:

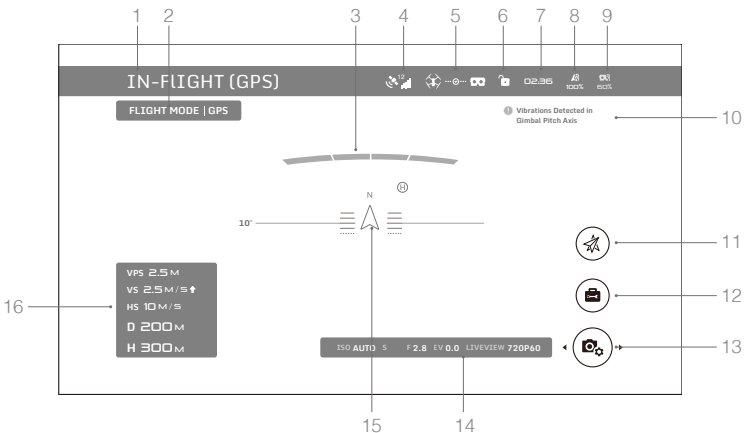

1. Aircraft Status

Indicates aircraft flight status.

2. Flight Mode

Indicates current flight mode.

3. Obstacle Detection Status

Red bars are displayed when obstacles are close to the aircraft. Orange bars are displayed when obstacles are in detection range.

4. GPS Status

Indicates GPS signal strength.

5. Connection Status

Indicates the connection status of the aircraft and Goggles. Green indicates a healthy signal connection, yellow indicates a weak or unstable signal connection, and red indicates a disconnection. The Goggles will automatically attempt to reconnect if disconnected.

6. Touch Panel Lock Status

Indicates the lock status of the touch panel. A locked touch panel will be unresponsive to touch to avoid accidental control. Swipe forward with two fingers to unlock it.

7. Flight Time

Shows the flight time of the aircraft.

8. Aircraft Battery Level

Shows the current battery level of the Intelligent Flight Battery.

9. Goggles Battery Level

Shows the current battery level of the Goggles.

10. Prompt Message

Shows warning messages. Swipe up or down to select and tap to delete prompts.

11. Intelligent Flight Modes

Tap to select TapFly, ActiveTrack, Terrain Follow, Tripod, and other intelligent flight modes.

12. Tools

Tap to set the settings of the Goggles and select Auto Takeoff/Landing, HDMI video playback, or flight photos/videos playback.

13. Camera Settings/Shoot/Record Button

Tap to set the ISO, shutter, aperture, and auto exposure values of the camera.

Swipe left or right to switch between Shoot and Record mode. Tap to shoot photos or start/stop recording video.

14. Camera Parameters and Live View Mode*

Shows the setting parameters of the camera and Live View Mode.

15. Flight Attitude

The triangle indicates the direction the aircraft is facing.

The horizontal level indicates aircraft roll angle.

The scale indicates the tilt angle of the gimbal.

The arc beside the triangle indicates the yaw angle of the gimbal when Head Tracking Gimbal is enabled.

* Live View Mode of the Goggles interacts with the aircraft's video recording.

When Live View Mode is in HD mode, video recording automatically switches to 1080p30. When in smooth mode, video recording automatically switches to 1080p60.

If you change the video recording mode of the aircraft, the live view of Goggles will preferentially synchronize with the matching format (1080p30 HD or 720p60 smooth mode). Otherwise, it will adjust Live View Mode to 720p30.

16. Flight Telemetry

Flight Telemetry is the horizontal/vertical distance between the aircraft and the Home Point as well as the movement speed across the horizontal/vertical distance of the aircraft. When the aircraft is close to the ground, the altitude will be displayed.

Controlling the Aircraft

The functional support list of the Goggles when connected with different aircraft is shown below.*

	Mavic Pro	Phantom 4 Pro/ Advanced Series	Phantom 4	Inspire 2	Inspire 1 Series
Head Tracking Flight	√	√	×	×	×
Head Tracking Gimbal	√	√	×	×	×
Focus	√	√	×	√	×
Auto Takeoff / Return-to-Home	√	√	√	×	×
TapFly	√	√	√	×	×
ActiveTrack	√	√	√	×	×
Terrain Follow	√	√	√	×	×
Tripod	√	√	×	×	×
Cinematic	√	×	×	×	×
Fixed Wing	√	×	×	×	×

* Some functions will be supported later, please pay attention to future updates.



When linked to the Mavic Pro, the remote controller can be used to control the Goggles. 5D button = Touch Panel; C1 button = Function button; C2 button = Back button. Press the C1 and C2 buttons together to enter the shortcut menu, and press the C2 button to exit. These remote controller buttons will be used to control the Goggles and their original function will be disabled. Please fly with caution.

Intelligent Flight Modes

Goggles support DJI Intelligent Flight Modes such as TapFly, ActiveTrack, Terrain Follow, Tripod, Fixed Wing and more. Please refer to the aircraft user manual for further details.

Use the touch panel to enter "Intelligent Flight Mode" and select the corresponding button to enable the desired mode. Enable TapFly, ActiveTrack or Fixed Wing in the Goggles as follows:

1. TapFly

- Use the touch panel to enter "Intelligent Flight Mode > TapFly".
- Move your head to control the cursor in the Goggles and then tap the touch panel to confirm the target direction and wait for the  icon to appear.
- Tap again to confirm the selection and the aircraft will fly in that direction.
- Press the back button on the Goggles to exit the current target direction or TapFly.

2. ActiveTrack

- Use the touch panel to enter "Intelligent Flight Mode > ActiveTrack".
- Move your head to control the cursor in the Goggles and then tap the touch panel to select the target subject. If the subject is not automatically recognized, move your head from the upper left corner to the lower right corner to drag a box around it.
The box will turn green when tracking is in progress. If the box turns red, the object could not be identified and you should try again.
- Tap again to confirm the selection and the aircraft will track the target subject.
- Press the back button on the Goggles to exit the current target subject or ActiveTrack.

3. Fixed Wing

- a) Use the touch panel to enter "Intelligent Flight Mode > Fixed Wing".
- b) When the forward speed of the aircraft is more than 3 m/s, you can select to enter a fixed wing cruise option. Press the function button or tap the touch panel on the Goggles to enter Fixed Wing Mode.
- c) Press the back button on the Goggles to exit Fixed Wing Mode.

Shortcut Menu

Swipe downward with two fingers on the touch panel to enter the shortcut menu. Move the cursor and tap the touch panel to turn functions on/off.

The Goggles support head tracking, which allows the aircraft to follow head movements:

1. Head Tracking Flight

Move your head to control the aircraft and the gimbal. Turn left and right to control the yaw of the aircraft, and turn up and down to control the pitch of the gimbal (-90° to 30°).

2. Head Tracking Gimbal

Move your head to control the gimbal. Turn left and right to control the yaw of the gimbal (-30° to 30°), and turn up and down to control the pitch of the gimbal (-90° to 30°).

3. Reset Motion Control

Set the gimbal to the center position or simulate the yaw stick in the mid-point of the remote controller. Head tracking will center on this point.



You can set the head tracking sensitivity in Tools setting.



- When Head Tracking is enabled (especially Head Tracking Flight), the aircraft yaw or gimbal movement will be affected. Please fly with caution and pay attention to control with the remote controller.
- It is recommended you use a 720p60 high frame rate format to ensure a smooth live view during fast movements.
- The functions in the shortcut menu are disabled when using TapFly and ActiveTrack.
- Only Head Tracking Flight can be enabled when using Fixed Wing Mode. This head tracking function should be enabled before entering the fixed wing cruise option and your head is best kept stable at that time.

Video Play

Watch flight videos or HD video content through the Goggles for an immersive viewing experience.

Flight Photos and Videos

Select "Tools > Playback" to enter the playback page for flight photos and videos, or demo videos.

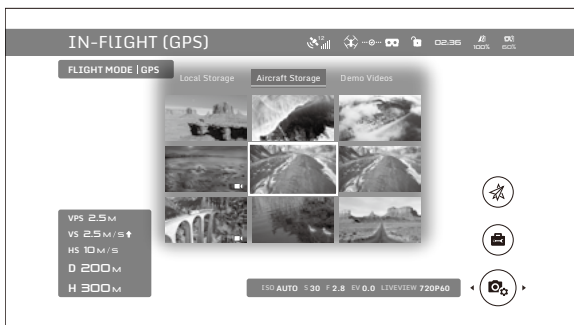

Local Storage

Remove the Micro SD card from the aircraft and insert it into the Micro SD Card slot on the Goggles and then select "Local Storage".

Aircraft Storage

Select "Aircraft Storage" to preview images stored on the aircraft. When you are browsing photos/videos, you can swipe up/down to download or delete them.



Playback is only supported by Mavic Pro and Phantom 4 Pro/Advanced series aircraft. Please ensure the Micro SD card is inserted into the Goggles when downloading photos/videos. After that, you can browse them in "Local Storage".



When using the Goggles with the Mavic Pro, if a user plays the video from aircraft storage instead of having a live view, then this video will be displayed on all devices synchronously. DO NOT play aircraft storage videos during flight to ensure safety.

Video Play

Connect a video source to the Goggles with an HDMI cable and select "Tools > HDMI Input" to view in HD. You can set the brightness, volume, and zoom.

Charging the Goggles

1. Connect the battery charger to a power outlet (100-240 V, 50/60 Hz).
2. With the Goggles powered off, connect the charging port on the headband to the charger with the Micro USB cable included.

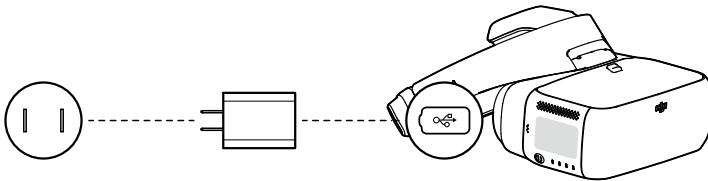

3. The charging status indicator will go solid red, yellow, and green in that order when charging. The battery level indicators will blink green, indicating current battery levels.
4. The battery is fully charged when the charging status indicator or battery level indicators turn off. Disconnect the Goggles from the charger.

Battery Level Indicators While Charging

LED1	LED2	LED3	LED4	Battery Level
				0%~25%
				25%~50%
				50%~75%
				75%~100%
				Fully Charged



- DO NOT charge the Goggles when it is powered on to ensure safety.
- When using a non-standard charger, the maximum output voltage must not exceed 12 V.



- The Goggles battery is located in the headband. You can connect the headband individually to the charger for charging. The battery is fully charged when the charging status indicator turns off.
 - A standard charger is recommended for charging. It takes approximately four hours to fully charge the battery. Other chargers may take longer.
-

Upgrading Firmware

DJI Assistant 2

Use DJI Assistant 2 to upgrade the Goggles.

1. Power on the Goggles and connect them to a computer with a Micro USB cable.
2. Launch DJI Assistant 2 and login with a registered DJI account.
3. Select "Goggles" and click "Firmware Upgrade" on the left-hand side.
4. Select the firmware version required.
5. DJI Assistant 2 will download and upgrade the firmware automatically.
6. Restart the Goggles after the firmware upgrade is complete.

Use DJI Assistant 2 to upgrade the aircraft and remote controller of the Mavic Pro and the Goggles simultaneously (only supports connection topology for Standard Mode).

1. Ensure all devices are powered on and that the aircraft is linked with the remote controller.
2. Connect the remote controller to a computer with a Micro USB cable.
3. Launch DJI Assistant 2 and login with a registered DJI account.
4. Select "RC for Mavic Pro" and click "Firmware Upgrade" on the left-hand side.
5. Select the required firmware version.
6. DJI Assistant 2 will download and upgrade the firmware automatically.
7. Restart all devices when the firmware upgrade is complete.

DJI GO 4 App

Use the DJI GO 4 app to upgrade the aircraft and remote controller of the Mavic Pro and the Goggles simultaneously (only supports connection topology for Standard Mode).

1. Ensure all devices are powered on and that the aircraft is linked with the remote controller.
2. Connect the remote controller with the DJI GO 4 app. A prompt will appear if a new firmware upgrade is available. To start upgrading, connect a mobile device to the Internet and follow the on-screen instructions.
3. Restart all devices when the firmware upgrade is complete.

Cleaning and Maintenance

Be sure to unplug the charger from the power outlet before cleaning and ensure that there are no cables connected.

Cleaning the Goggles

Wipe and clean the surface of the Goggles with a soft clean cloth.

To clean the facial pad, first drag it from the left or right side to the inside, then detach the other

parts. Run water over the facial pad, then wipe it with a soft, dry cloth until it is completely dry. Align the protruding part of the facial pad with the holes on the Goggles body, then press them together so they are securely attached.

Maintenance of Lenses

Use the cleaning cloth included to wipe the lenses gently.

1. Moisten the cleaning cloth with alcohol or a lens cleaner.
2. Wipe in a circular motion from the center to the outer edges of the lenses.



- The lenses are delicate, please clean them gently. DO NOT scratch them as this will damage the overall viewing experience.
- Store the Goggles in a dry room at room temperature to avoid damage to the lenses from high temperature and humid environments.

Specifications

Weight (Typical)	Goggles Body: 495 g Headband: 500 g
Dimensions	Goggles Body: 195×155×110 mm Headband (folded): 255×205×92 mm
Screen Size	5 inch×2
Screen Resolution	3840×1080 (single screen: 1920×1080)
Refresh Rate	60 Hz
FOV	85° (single screen)
Interpupillary Distance Range	58 – 70 mm
Communication Frequency	2.4 GHz
Max. Transmission Distance	Same as the aircraft connected
Live View Modes	1080p30, 720p60, 720p30
Min. Video Downlink Latency (near field, free of interference)	110 ms (Mavic Pro, 720p60, video format: 720p120) 150 ms (Phantom 4 Pro/Advanced Series, 720p60, video format: 720p60/720p120) 167 ms (Phantom 4, 720p30, video format: 720p60) 140 ms (Inspire 2+X5S, 720p60, video format: 1080p120) 190 ms (Inspire 2+X4S, 720p60, video format: 1080p60)
I/O Interface	Micro USB port, 3.5 mm Audio port, HDMI Type-D port, Micro SD Card slot
HDMI Supported	HDMI 1.4b, HDCP 1.4
Sensors	Gyroscope, Accelerometer, Proximity Sensor
Operating Temperature Range	32° to 104° F (0° to 40° C)
Battery Capacity	9440 mAh
Battery Energy	35.44 Wh
Max. Operating Time	6 hrs
Charger	Input: 100-240 VAC, 50/60 Hz, 0.5 A Output: 5 V = 3 A / 9V = 2A / 12 V = 1.5 A

DJI Support

<http://www.dji.com/support>

This content is subject to change.

Download the latest version from
www.dji.com/dji-goggles

If you have any questions about this document, please contact
DJI by sending an email to DocSupport@dji.com.

DJI is a trademark of DJI.
Copyright © 2017 DJI All Rights Reserved.

Free Manuals Download Website

<http://myh66.com>

<http://usermanuals.us>

<http://www.somanuals.com>

<http://www.4manuals.cc>

<http://www.manual-lib.com>

<http://www.404manual.com>

<http://www.luxmanual.com>

<http://aubethermostatmanual.com>

Golf course search by state

<http://golfingnear.com>

Email search by domain

<http://emailbydomain.com>

Auto manuals search

<http://auto.somanuals.com>

TV manuals search

<http://tv.somanuals.com>