

TGX 4-Channel Power Amplifier

TGX10 | TGX20



Table of contents

1	Safety	4
1.1	Safety messages explained	4
1.2	Important safety instructions	4
1.3	Safety precautions	6
1.4	High frequency interference – FCC/EN55032	6
1.5	Notices	7
2	About this manual	8
2.1	Manual purpose and intended audience	8
2.2	Digital document	8
3	System overview	9
3.1	Application area	9
3.2	Features	9
3.3	Unpacking and inspection	9
3.4	Scope of delivery	9
4	Planning information	11
5	Installation	12
5.1	Mounting	12
5.2	Mains power connection	12
5.3	Power	12
5.4	Ventilation	12
6	Controls, indicators, and connections	14
6.1	Front panel	14
6.2	Rear panel	14
6.3	Power outputs	15
6.4	Audio inputs	15
6.5	Fan cooling	16
7	Power amplifier menu navigation	17
7.1	LCD display and control menu	17
7.1.1	Home screen	17
7.1.2	Main menu	17
7.1.3	Channel page	18
7.2	Remote control via software	20
8	Technical data	21
8.1	TGX10	21
8.2	TGX20	24
8.3	Mains operation & resulting temperature	27
8.4	Block diagram	28
8.5	Dimensions	29
9	Accessories	30

1 Safety

1.1 Safety messages explained

Four types of signs can be used in this manual. The type is closely related to the effect that may be caused if it is not observed. These signs - from least severe effect to most severe effect - are:



Notice!

Containing additional information. Usually, not observing a 'notice' does not result in damage to the equipment or personal injuries.



Caution!

The equipment or the property can be damaged, or persons can be lightly injured if the alert is not observed.



Warning!



The equipment or the property can be seriously damaged, or persons can be severely injured if the alert is not observed.



Danger!

Not observing the alert can lead to severe injuries or death.

1.2 Important safety instructions

	CAUTION RISK OF ELECTRIC SHOCK DO NOT OPEN	
<p>WARNING: TO REDUCE THE RISK OF FIRE OR ELECTRIC SHOCK, DO NOT EXPOSE THIS APPLIANCE TO RAIN OR MOISTURE.</p> <p>AVIS: RISQUÉ DE CHOC ELECTRIQUE - NE PAS OUVRIR</p>		
<p>CAUTION: TO REDUCE THE RISK OF ELECTRIC SHOCK, GROUNDING OF THE CENTRE PIN OF THIS PLUG MUST BE MAINTAINED.</p> <p>ATTENTION: POUR RÉDUIRE LE RISQUE DE CHOC ÉLECTRIQUE LA FICHE CENTRALE DE LA PRISE DOIT ÊTRE BRANCHÉE POUR MAINTENIR LA MISE À LA TERRE.</p>		



Danger!

The lightning symbol inside a triangle notifies the user of high-voltage, uninsulated lines and contacts inside the devices that could result in fatal electrocution if touched.



Warning!

An exclamation mark inside a triangle refers the user to important operating and service instructions in the documentation for the equipment.

1. Read these safety notes.
2. Keep these safety notes in a safe place.
3. Heed all warnings.
4. Observe all instructions.
5. Do not operate the device in close proximity to water.

6. Use only a dry cloth to clean the unit.
7. Do not cover any ventilation slots. Always refer to the manufacturer's instructions when installing the device.
8. Do not install the device close to heaters, ovens, or other heat sources.
9. Note: The device must only be operated via the mains power supply with a safety ground connector. Do not disable the safety ground connection function of the supplied power cable. If the plug of the supplied cable does not fit your mains socket, please contact your electrician.
10. Ensure that it is not possible to stand on the mains cable. Take precautions to ensure the mains cable cannot become crushed, particularly near the device connector and mains plug.
11. Only use accessories/extensions for the device that have been approved by the manufacturer.
12. Unplug the device if there is risk of lightning strike or in the event of long periods of inactivity. However, this does not apply if the device is to be used as part of an evacuation system!
13. Have all service work and repairs performed by a trained customer service technician only. Service work must be carried out immediately following any damage such as damage to the mains cable or plug, if fluid or any object enters the device, if the device has been used in rain or become wet, or if the device has been dropped or no longer works correctly.
14. Please ensure that no dripping water or spray can penetrate the inside of the device. Do not place any objects filled with fluids, such as vases or drinking vessels, on top of the device.
15. To ensure the device is completely free of voltage, unplug the device from the power supply.
16. When installing the device, ensure the plug is freely accessible.
17. Do not place any sources of open flame, such as lit candles, on top of the device.
18. This PROTECTION CLASS I device must be connected to a MAINS socket with a safety ground connection.

**Caution!**

Use only manufacturer-approved carts, stands, brackets, or tables that you acquired together with the device. When using carts to move the device, make sure the transported equipment and the cart itself cannot tip over or cause injury or material damage.

IMPORTANT SERVICE INFORMATION**Caution!**

This service information is for use by qualified service personnel only. To avoid the risk of electric shock, do not perform any maintenance work that is not described in the operating instructions unless you are qualified to do so. Have all service work and repairs performed by a trained customer service technician.

1. Repair work on the device must comply with the safety standards specified in EN 60065 (VDE 0860).
2. A mains isolating transformer must be used during any work for which the opened device is connected to and operated with mains voltage.
3. The device must be free of any voltage before performing any alterations with upgrade sets, switching the mains voltage, or performing any other modifications.

4. The minimum distance between voltage-carrying parts and metal parts that can be touched (such as the metal housing) or between mains poles is 3 mm, and must be observed at all times.
5. The minimum distance between voltage-carrying parts and circuit parts that are not connected to the mains (secondary) is 6 mm, and must be observed at all times.
6. Special components that are marked with the safety symbol in the circuit diagram (note) must only be replaced with original parts.
7. Unauthorized changes to the circuitry are prohibited.
8. The protective measures issued by the relevant trade organizations and applicable at the place of repair must be observed. This includes the properties and configuration of the workplace.
9. Observe the guidelines with respect to handling MOS components.

**Danger!**

SAFETY COMPONENT (MUST BE REPLACED BY ORIGINAL PART)

1.3**Safety precautions****Speaker system damage and protection of human beings**

Power amps provide extremely high power output that might be dangerous for human beings as well as for the connected speaker systems. High output voltages can damage or even destroy the connected speaker systems, especially, when the amplifier is operated in bridge mode. Prior to connecting any loudspeakers, make sure to check the speaker system's specifications for continuous and peak power handling capacities. Even if amplification has been reduced through lowering the input level controls on the amplifier's front panel, it is still possible to achieve full power output with a sufficiently high input signal.

**Danger!**

Danger at the loudspeaker/power outputs

Power amplifiers are capable of producing dangerously high voltage output that is present at the output connectors.

To protect yourself from electric shock, do not touch any blank speaker cables during operation of the power amp.

**Danger!**

The terminals marked with a lightning bolt are hazardous live and the external wiring connected to these terminals requires installation by an instructed person or the use of ready-made leads of cords.

**Danger!**

In case of using the amplifier with speakers including a primary tapped transformer, it is possible that during operation shock hazard voltages may be present at the taps of the transformer.

Therefore, the taps have to be insulated sufficiently in accordance with applicable safety regulations.

1.4**High frequency interference – FCC/EN55032**

IMPORTANT: Do not modify this unit! Changes or modifications not expressly approved by the manufacturer could void the user's authority, granted by the FCC, to operate the equipment.

**Notice!**

This equipment has been tested and found to comply with the limits for a Class A digital device, pursuant to part 15 of the FCC Rules and EN55032. These limits are designed to provide reasonable protection against harmful interference when the equipment is operated in a commercial environment. This equipment generates, uses, and can radiate radio frequency energy and, if not installed and used in accordance with the instruction manual, may cause harmful interference to radio communications. Operation of this equipment in a residential area is likely to cause harmful interference in which case the user will be required to correct the interference at his own expense.

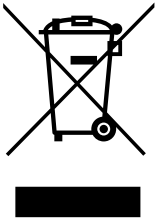
1.5**Notices****Old electrical and electronic appliances**

Electrical or electronic devices that are no longer serviceable must be collected separately and sent for environmentally compatible recycling (in accordance with the European Waste Electrical and Electronic Equipment Directive).

To dispose of old electrical or electronic devices, you should use the return and collection systems put in place in the country concerned.

Copyright and disclaimer

All rights reserved. No part of this document may be reproduced or transmitted in any form by any means, electronic, mechanical, photocopying, recording, or otherwise, without the prior written permission of the publisher. For information on getting permission for reprints and excerpts, contact Dynacord.

All content including specifications, data, and illustrations in this manual are subject to change without prior notice.

Dante is a registered trademark of Audinate Pty Ltd.

NEUTRIK, speakON, powerCON, and etherCON are registered trademarks of Neutrik AG.

IT security disclaimer

In order to offer maximum compatibility with all networked audio devices and to allow for fast and easy setup and maintenance, our OMNEO-enabled amplifier products do not support encrypted communications for audio or control data and do not verify the authenticity of any Dante or OCA controllers (or any other node) on the network.

This means that these devices do not take any special precautions against malicious or accidental attacks via their network interfaces. Such attacks happen every day on the public internet. It is strongly recommended to set up the system in a safe, isolated network, meaning a network where all hardware components are known and physically owned and none of them is connected to the public internet.

Network cabling

The OMNEO network comprises audio transport using the Dante protocol as well as OCA control commands. In order to guarantee the product performance according to specifications, network cabling has to be shielded, fulfilling the requirements of CAT 5e as a minimum.

For integration in networks, the network switches require a dedicated configuration. Further details will be explained in the documentation of the related network control software.

2 About this manual

2.1 Manual purpose and intended audience

The purpose of this manual is to provide information required for installing, configuring, operating, and maintaining the TGX 4-channel power amplifier. This manual is intended for installers and operators of TGX 4-channel powered amplifiers.

Read through this manual to familiarize yourself with the safety information, features, and applications before you use these products.

2.2 Digital document

This manual is available as a digital document in the Adobe Portable Document Format (PDF). You can find information about Dynacord products on the product related information at www.dynacord.com.

3 System overview

3.1 Application area

The TGX 4-channel power amplifiers are designed to power professional loudspeaker systems in mobile audio applications such as cultural, corporate or sports events, and other audio use cases that require very high-power multichannel amplifier with sophisticated speaker processing and audio/control networking.

3.2 Features

TGX10

- Multichannel DSP amplifier for live applications
- Power density of 10kW in 2RU
- Fully integrated DSP with native 96 kHz and FIR Drive technology
- OMNEO integration for seamless compatibility with Dante and OCA
- Full color touch screen for control without software

TGX20

- Multichannel DSP amplifier for live applications
- Market leading power density with 20kW in 2RU
- Fully integrated DSP with native 96 kHz and FIR Drive technology
- OMNEO integration for seamless compatibility with Dante and OCA
- Full color touch screen for control without software

3.3 Unpacking and inspection

Carefully open the packaging and take out the power amplifier. Inspect the power amp’s enclosure for damages that might have happened during transportation. Each amplifier is examined and tested in detail before leaving the manufacturing site to ensure that it arrives in perfect condition at your place. Please inform the transport company immediately, if the power amplifier shows any damage. Being the addressee, you are the only person who can claim damages in transit. Keep the cardboard box and all packaging materials for inspection by the transport company.

Keeping the cardboard box including all packing materials is also recommended, if the power amplifier shows no external damages.



Caution!

Do not ship the power amp in any other but its original packaging.

When shipping the power amp, make sure to always use its original box and packaging materials. Packing the power amplifier like it was packed by the manufacturer guarantees optimum protection from transport damage.

3.4 Scope of delivery

Quantity	Component
1	TGX 4-channel power amplifier
4	M6x20 screw for rack mounting
1	Installation manual

Quantity	Component
1	Mains power connector, 32 A with safety & assembly instruction
1	Safety instruction booklet

Keep the original invoice that states the purchase/delivery date in a safe place.

4 Planning information

Ensure the following:

- You make use of manufacturer specified installation materials.
- No liquids can spill into or on the products.
- Installation is in a clean environment free of dust.
- The ventilation airflow of the 19" units is not obstructed.
- There is a mains power outlet of sufficient rating close to the intended location of the products.
- Sufficient free space and access at the rear of the 19" units for connectors and wiring.

To find current user documentation, firmware, or software visit our product related information at www.dynacord.com.

5 Installation

5.1 Mounting

TGX amplifiers are designed for installation in a conventional 19-inch rack case. Attach the power amp with its frontal rack mount ears using four 20 mm screws and washers. If the rack will be transported secure the amplifier at the rear. Failure to do so may result in damage to the power amplifier as well as to the rack case. Attach the power amp using four case nuts and screws. Brackets for securing the power amplifier in the rear are available as accessories (RMK-15).

5.2 Mains power connection

Mains power connection (all countries except the USA)

The power amplifier receives its power supply via the MAINS connector. It is recommended to use either the listed power cords or power distributions. Custom power cords using the supplied connector have to be built from qualified personal following the safety and assembly instructions. During installation, always separate the power amplifier from the mains. Connect the power amplifier only to a mains network, which corresponds to the requirements indicated on the type plate.

Mains power connection (USA only)

The power amplifier receives its power supply via the MAINS connector. Only the listed power cords or power distributions shall be used. During installation, always separate the power amplifier from the mains. Connect the power amplifier only to a mains network, which corresponds to the requirements indicated on the type plate.

See also

– *Accessories, page 30*

5.3 Power

The TGX power switch is located on the rear panel of the power amplifier. Press the switch towards the label *ON* powers on the amplifier. Press the switch to the other side powers the amplifier down. A soft start circuit compensates mains inrush current peaks and thus prevents triggering AC mains fuse when switching on the amplifier.

Speaker system switch-on is delayed by approximately 15 seconds while the amplifier is booting. During that time the speakers are decoupled by relays. The amplifier is ready for operation when the display is showing the home screen and the amp icon is green.

5.4 Ventilation

As with all Dynacord fan cooled power amps, the airflow direction is front-to-rear. When installing the power amp in a case or rack system, attention should be paid to provide sufficient ventilation. Allow for an air duct of at least 100 mm x 330 mm between the rear panel of the power amplifier and the inner wall of the cabinet/rack case. Ensure the duct reaches up to the cabinets or the rack case's top ventilation louvers. Leave room of at least 100 mm above the cabinet/rack case for ventilation. Temperatures inside of the cabinet/rack case can easily rise up to 40 °C (104 °F) during operation of the power amp, it is mandatory to bear in mind the maximum allowable ambient temperature for all other appliances installed in the same cabinet/rack case.

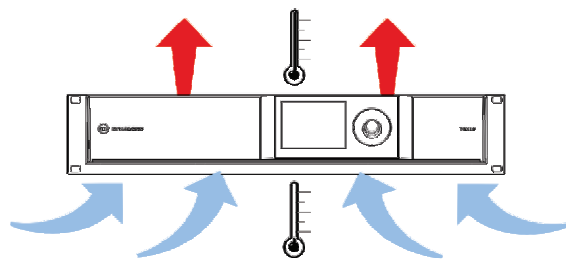

Figure 5.1: Power amplifier ventilation



Caution!

Blocking/closing the power amp's ventilation louvers is not permissible. Without sufficient cooling/ventilation, the power amplifier may enter protect mode. Keep ventilation louvers free from dust to ensure unhindered airflow.



Notice!

Do not use the power amplifier in direct sunlight or near heat sources, like heater blowers, stoves, or any other heat radiating devices.



Notice!

Do not use the power amplifiers in an environment where temperatures are below 5 °C (41 °F) or exceed +40 °C (104 °F).

For fixed amplifier installations in a device control room that incorporate a central air-cooling system or air conditioners, calculating the maximum heat emission may be necessary.

See also

- *Mains operation & resulting temperature, page 27*

6 Controls, indicators, and connections

6.1 Front panel

Amplifier set up, configuration, and monitoring via the touch screen, encoder or the dedicated remote control software.

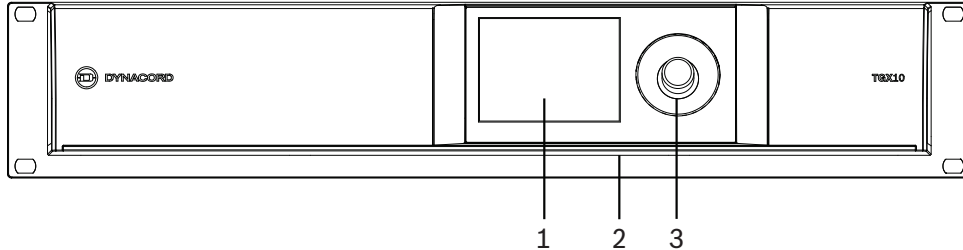

Figure 6.1: TGX front panel

1. Full color 3.5" capacitive touch screen.
2. USB service port.
3. Encoder with multi-color light ring.

6.2 Rear panel

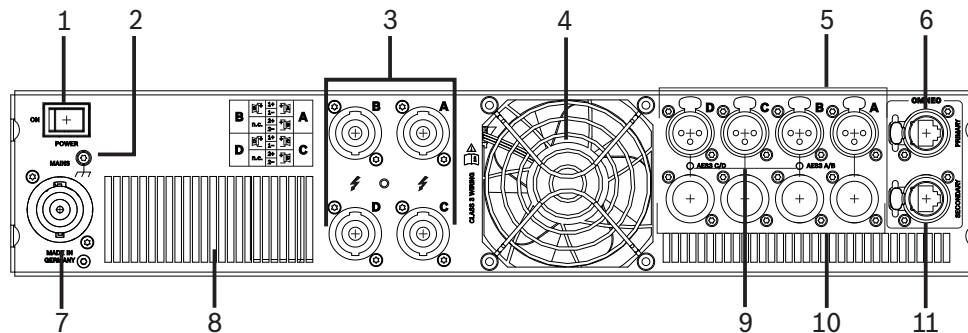

Figure 6.2: TGX rear panel

1. Power ON switch.
2. Ground contact.
3. NL4 audio outputs for channels A, B, C, D.
4. FAN - Exhaust air vent for amplifier cooling. Do not obstruct!
5. XLR for analogue inputs and AES3 (switchable) channels A, B, C, D.
6. PRIMARY OMNEO/Dante network connector (etherCON/RJ45).
7. Mains power connector (for powerCON32).
8. Exhaust air vent for power supply cooling. Do not obstruct!
9. LEDs for AES input active and amplifier find function.
10. XLR thru for analogue inputs and AES3, channels A, B, C, D.
11. SECONDARY OMNEO/Dante network connector (etherCON/RJ45).

AES3 inputs/outputs for audio channels A/B [5 & 10] on connector B, for channels C/D on connector D.

6.3 Power outputs

The output connectors on TGX amplifiers are NL4 type. Outputs A and C carry the signal from the adjacent channel to allow for system cabling.

Connector	Pins 1+/-	Pins 2+/-
Output A	Ch A	Ch B
Output B	Ch B	
Output C	Ch C	Ch D
Output D	Ch D	



Caution!

Ensure you use proper cabling. TGX amplifiers are extremely powerful, bad cabling, such as shortages can lead to equipment damages. Also, ensure to observe the power handling specification for your loudspeaker system and adjust if required the DSP limiters accordingly.

6.4 Audio inputs

Audio input connectors on TGX amplifiers are four XLR-F connectors with dual function. They handle analogue line level signals and can be switched to AES3. The four XLR-M connectors (see illustration item 10) are used to daisy chain the input signal. They carry the same signal as fed to the XLR-F (see illustration item 5). The AES3 inputs/outputs for channels A/B are on XLR B, for channels C/D on XLR D. The AES3 outputs are active buffered if the device is powered and directly bypassed unpowered.

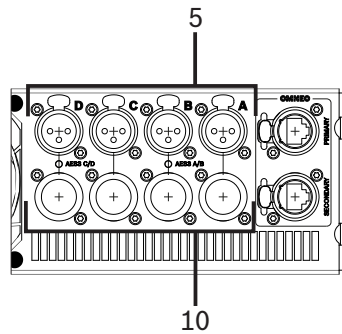

Figure 6.3: TGX audio connectors



Notice!

It is mandatory to use balanced input wiring for the AES3 and/or analogue inputs. Unbalanced cabling will not work and leads to bad audio signal. For AES3 only cables specified for digital signals with an impedance of 110 Ohms are recommended.

In addition to the analogue and AES3 inputs, TGX amplifiers can also receive their input signals from an OMNEO or a Dante network. The input source for each amplifier channel can be changed via the front panel or using remote control software.

See also

- Rear panel, page 14

6.5 Fan cooling

The power amplifier has four fans. The fans are fully controlled and supervised by the amplifiers management system and adjust their speed depending on the temperature. The temperatures of the power amplifier's channels are registered and monitored individually.

7 Power amplifier menu navigation

7.1 LCD display and control menu

The TGX amplifiers feature a 3.5" full color capacitive touch display. The touch functionality provides the ability to select control menu items faster. The control menu navigation is designed to have all available functions accessible via the rotary encoder. Editing the control menu parameter values is only available using the rotary encoder in the given increments.

The front panel control content and menu structure is subject to change with firmware version updates. For current information, see the product's support section on our website: www.dynacord.com.

7.1.1 Home screen

The Home screen has all of the basic information about the amplifier usually found as hardware, such as power status, amp status, level indication, and input/output metering.



Figure 7.1: Home screen

The home screen menu contains:

- Main menu
- Amp
- Remote
- Channels A through D, including editable level and mute per channel

7.1.2 Main menu

The Main menu contains:

- Power Off
- Amplifier menu
- Remote menu
- Source Configuration
- Display & Lock
- Logging

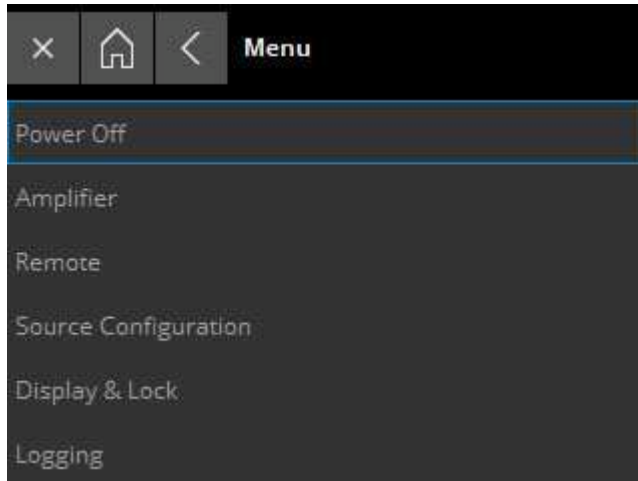



Figure 7.2: Main menu

Turning on Standby mode

To **turn on standby mode**, do the following:

1. Tap the **main menu** button .
2. Tap **Power Off**.
The Standby confirmation prompt appears, "Switch Power to Standby. Are you sure?"
3. Select **Yes**.
The amplifier is now in Standby mode.

Turning off Standby mode

To **turn off from Standby mode**, do the following:

- Press the **encoder**.
The amplifier powers up and is no longer in standby mode.

 Recalls the last active page

 Navigates to the home page

 Closes the page

7.1.3

Channel page

The Channel page allows the individual configuration and editing for each amplifier channel.

The channel page contains:

- Input Source selection
- User EQ
- User Delay
- Array Control
- Speaker
- Load
-

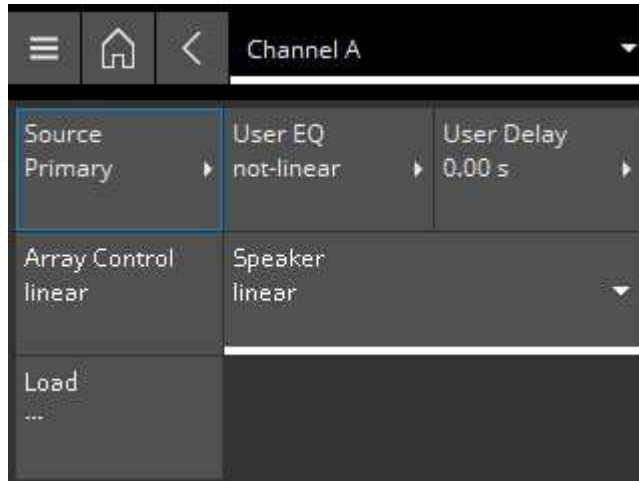

Figure 7.3: Channel page with sub menus

The array control parameters, as well as speaker processing parameters, are not available via the front panel. Load shows the actual measured speaker impedance and indicates impedance errors.

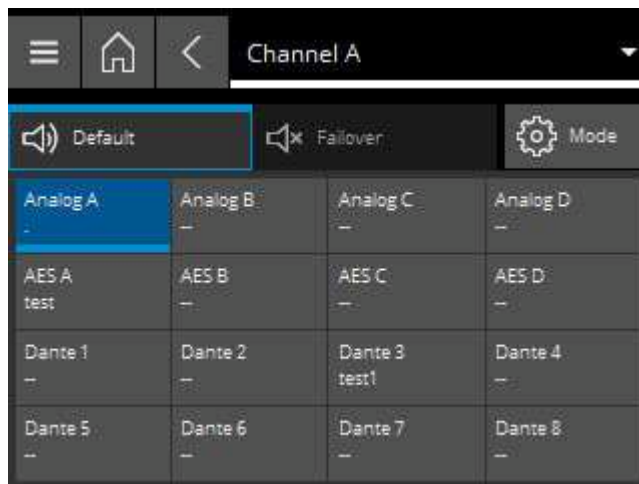

Figure 7.4: Input source selection

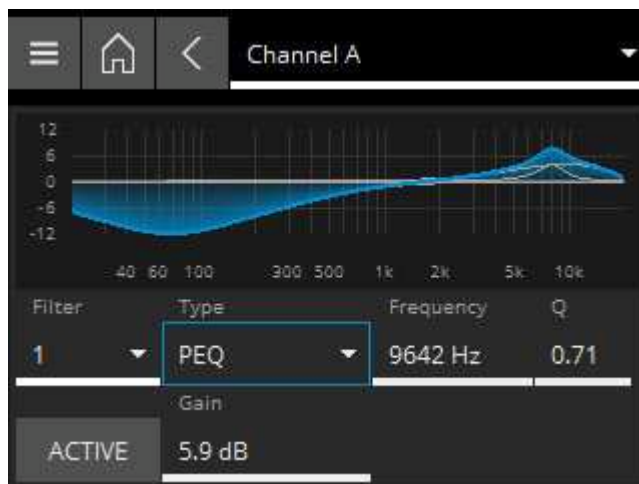

Figure 7.5: Channel user EQ

7.2 Remote control via software

TGX amplifiers feature an integrated OMNEO network interface. OMNEO is a media networking architecture for professional applications. Using standard IP Ethernet, media products that integrate OMNEO can be assembled into networks of 2 to 10,000 cooperating devices that exchange studio-quality synchronized multichannel audio and share common control systems. OMNEO's media transport technology for pro sound products is Audinate's Dante, a high-performance standards-based, routable IP media transport system. OMNEO's system control technology is OCA (AES70), Open Control Architecture, an open public standard for control and monitoring of professional media networks.

TGX amplifiers are compatible with current IRIS-Net software and will be also controlled from the next generation of sound system control software.

For further information on current software and firmware releases, visit our website: www.dynacord.com.

8 Technical data

8.1 TGX10

OUTPUT POWER				
Load impedance	2 Ω	2.7 Ω	4 Ω	8 Ω
Maximum Output Power¹ All channels driven	2600 W	3000 W	2500 W	1250 W
Number of amplifier channels	4			
Maximum Output Voltage	150 V _{peak}			
Maximum Output Current	53 A _{peak}			
AMPLIFIER				
Voltage Gain ref.1 kHz	32.0 dB, adjustable 24-40 dB			
Input Sensitivity ref. to Max. Output Voltage	10.7 dBu (2.66 V), adjustable 2.7-18.7 dBu			
THD 3 dB below Max., AES17, 1 kHz	< 0.05 %			
IMD-SMPTE , 60 Hz, 7 kHz	< 0.05 %			
DIM100 , 3.15 kHz, 15 kHz	< 0.15 %			
Crosstalk ref. 1 kHz, 12 dB below Max., 8 Ω	< -80 dB			
Frequency Response ref. 1 kHz, analog in to speaker out	20 Hz to 20 kHz (\pm 0.5 dB)			
Damping Factor , 20 Hz to 200 Hz, 8 Ω	> 400			
Output Stage Topology	Class D, fixed frequency			
Signal to Noise Ratio				
A-weighted, analog input	112 dB			
A-weighted, digital input	115 dB			
Output Noise				
A-weighted, analog input	< -70 dBu			
A-weighted, digital input	< -73 dBu			
DIGITAL SIGNAL PROCESSING				
Sampling rate	48 kHz/96 kHz, OMNEO/Dante synchronized			
Signal Delay/Latency				

Analog in to Speaker Out, 48 kHz/96 kHz	0.70 ms/0.53 ms
AES3 in to Speaker Out, 48 kHz/96 kHz	1.00 ms/0.66 ms
Dante Network Latency	typ. 1.00 ms
Signal Processing	32/40 bit, floating point
User EQ	12 filters per channel, selectable as PEQ, Lo-Shelv, Hi-Shelv, Lo-ShelvQ, Hi-ShelvQ, Hi-Pass, Lo-Pass and Notch; 2 filters of them with additional asymmetric filter type
User Delay	0 to 2000 ms per channel (units: μ s, ms, s, cm, m, inches, feet)
Array EQ	5 filters per channel, selectable as PEQ, Lo-Shelv, Hi-Shelv, Lo-ShelvQ, Hi-ShelvQ, Hi-Pass, Lo-Pass, and All-Pass
Array Delay	0 to 500 ms per channel (units: μ s, ms, s, cm, m, inches, feet)
Speaker EQ	10 filters per channel, selectable as PEQ, Lo-Shelv, Hi-Shelv, Hi-Pass, Lo-Pass, and All-Pass
Speaker X-Over	Hi-Pass and Lo-Pass per channel, 6/12/18/24/30/36/42/48 dB Bessel/Butterworth, 12/24/48 dB Linkwitz-Riley; Alignment Delay, 0 to 20 ms per channel
Speaker FIR	up to 1025 taps, Linear Phase Filter, Linear Phase Brickwall X-Over
Speaker Limiters	Peak Anticipation Limiter and RMS/TEMP Limiter per channel
Other functions	Source Selection and Mix, Level, Mute, Polarity, Sine and Noise Generator, Level Meters, Impedance Measurement, and Load Monitoring
Memory	
DSP Presets	1 Factory + 20 User
Speaker-Pool Presets	30 speaker settings
Source Supervision and Fallback	AES3 Lock and OMNEO/Dante network supervision, switchover to alternative Source Selection
CONNECTIVITY	
Analog Audio Input/Thru	
Type	4 x 3-pin XLR female/male
Maximum Input Level	+24 dBu
Input Impedance, active balanced	20 k Ω
Reference level equal to digital input	+21 dBu for 0 dBFS
Digital Audio Input/Thru	
Type	2 x 3-pin XLR (alternative use of Analog In/Thru)
Format	AES3 (AES/EBU)
Input Sample Rates	32 to 192 kHz, internal Sample-Rate-Converter

Thru Connector	active buffered, direct bypass if device is unpowered
Network	
Type	2 x Neutrik etherCON/RJ45, redundant PRIMARY/SECONDARY
Format	1000base-T/100base-TX, integrated switch
Network Audio Inputs	8 channels, 48/96 kHz, OMNEO/Dante format
Network Audio Outputs (Monitor)	2 channels, 48/96 kHz, OMNEO/Dante format
Front side Service Port	1 x USB Type A
Mains Input	1 x Neutrik powerCON-HC
Speaker Output	4 x NL4
GENERAL	
User Interface	
Display	320 x 240 pixel, 3.5" color TFT
Front panel indicators	Full color LED illuminated ring
Front panel operating elements	Rotary encoder, Capacitive Touch Screen
Rear panel indicators	2 x LED (AES3 Input mode active, Amp-Find)
Rear panel operating elements	Mains switch
Power Requirements	100 V to 240 V, 50 Hz to 60 Hz AC
Power Consumption	
Rated Power Consumption	1200 W
1/8 Maximum Output Power at 4 Ω	1765 W
Idle Mode (no input signal)	80 W
Standby Mode	< 18 W
Power Supply Topology	Switching Mode Power Supply with digital controlled Power Factor Correction
Protections	Audio Limiters, High Temperature, DC, HF, Short Circuit, Back-EMF, Peak Current Limiters, Inrush Current Limiters, Turn-on Delay, Mains Circuit Breaker Protection, Mains Over/Under voltage Protection
Cooling:	Front-to-rear, temperature controlled fans, supervised
Ambient Temperature Limits	+5 °C to +40 °C (+40 °F to +105 °F)
IEC Protection Class	Class I (grounded)
Electromagnetical Environment	E1, E2, E3
Color	Black
Dimensions (W x H x D), mm	483 x 88.1 x 514.2
Weight	15.0 kg (33.0 lb)

Shipping Weight	17.2 kg (37.8 lb)
------------------------	-------------------

Amplifier at rated conditions; all channels driven, 4 Ω loads, analog input, 32 dB gain, 48 kHz sample rate, unless otherwise specified.

¹Test signal for max. output power according IHF-A-202 (Dynamic-Headroom, burst 1 kHz/20 ms on/480 ms off/low level -20 dB).

8.2 TGX20

OUTPUT POWER				
Load impedance	2 Ω	2.7 Ω	4 Ω	8 Ω
Maximum Output Power¹ All channels driven	5200 W	6000 W	5000 W	2500 W
Number of amplifier channels	4			
Maximum Output Voltage	210 V _{peak}			
Maximum Output Current	84 A _{peak}			
AMPLIFIER				
Voltage Gain ref.1 kHz	32.0 dB, adjustable 24-40 dB			
Input Sensitivity ref. to Max. Output Voltage	13.7 dBu (3.73 V), adjustable 5.7-21.7 dBu			
THD 3 dB below Max., AES17, 1 kHz	< 0.05 %			
IMD-SMPTE, 60 Hz, 7 kHz	< 0.15 %			
DIM100, 3.15 kHz, 15 kHz	< 0.15 %			
Crosstalk ref. 1 kHz, 12 dB below Max., 8 Ω	< -80 dB			
Frequency Response ref. 1 kHz, analog in to speaker out	20 Hz to 20 kHz (± 1 dB)			
Damping Factor, 20 Hz to 200 Hz, 8 Ω	> 400			
Output Stage Topology	Class D, fixed frequency			
Signal to Noise Ratio				
A-weighted, analog input	115 dB			
A-weighted, digital input	118 dB			
Output Noise				
A-weighted, analog input	< -70 dBu			
A-weighted, digital input	< -73 dBu			
DIGITAL SIGNAL PROCESSING				

Sampling rate	48 kHz/96 kHz, OMNEO/Dante synchronized
Signal Delay/Latency	
Analog in to Speaker Out, 48 kHz/96 kHz	0.70 ms/0.53 ms
AES3 in to Speaker Out, 48 kHz/96 kHz	1.00 ms/0.66 ms
Dante Network Latency	typ. 1.00 ms
Signal Processing	32/40 bit, floating point
User EQ	12 filters per channel, selectable as PEQ, Lo-Shelv, Hi-Shelv, Lo-ShelvQ, Hi-ShelvQ, Hi-Pass, Lo-Pass and Notch; 2 filters of them with additional asymmetric filter type
User Delay	0 to 2000 ms per channel (units: μ s, ms, s, cm, m, inches, feet)
Array EQ	5 filters per channel, selectable as PEQ, Lo-Shelv, Hi-Shelv, Lo-ShelvQ, Hi-ShelvQ, Hi-Pass, Lo-Pass, and All-Pass
Array Delay	0 to 500 ms per channel (units: μ s, ms, s, cm, m, inches, feet)
Speaker EQ	10 filters per channel, selectable as PEQ, Lo-Shelv, Hi-Shelv, Hi-Pass, Lo-Pass, and All-Pass
Speaker X-Over	Hi-Pass and Lo-Pass per channel, 6/12/18/24/30/36/42/48 dB Bessel/Butterworth, 12/24/48 dB Linkwitz-Riley; Alignment Delay, 0 to 20 ms per channel
Speaker FIR	up to 1025 taps, Linear Phase Filter, Linear Phase Brickwall X-Over
Speaker Limiters	Peak Anticipation Limiter and RMS/TEMP Limiter per channel
Other functions	Source Selection and Mix, Level, Mute, Polarity, Sine and Noise Generator, Level Meters, Impedance Measurement, and Load Monitoring
Memory	
DSP Presets	1 Factory + 20 User
Speaker-Pool Presets	30 speaker settings
Source Supervision and Fallback	AES3 Lock and OMNEO/Dante network supervision, switchover to alternative Source Selection
CONNECTIVITY	
Analog Audio Input/Thru	
Type	4 x 3-pin XLR female/male
Maximum Input Level	+24 dBu
Input Impedance, active balanced	20 k Ω
Reference level equal to digital input	+21 dBu for 0 dBFS
Digital Audio Input/Thru	
Type	2 x 3-pin XLR (alternative use of Analog In/Thru)

Format	AES3 (AES/EBU)
Input Sample Rates	32 to 192 kHz, internal Sample-Rate-Converter
Thru Connector	active buffered, direct bypass if device is unpowered
Network	
Type	2 x Neutrik etherCON/RJ45, redundant PRIMARY/SECONDARY
Format	1000base-T/100base-TX, integrated switch
Network Audio Inputs	8 channels, 48/96 kHz, OMNEO/Dante format
Network Audio Outputs (Monitor)	2 channels, 48/96 kHz, OMNEO/Dante format
Front side Service Port	1 x USB Type A
Mains Input	1 x Neutrik powerCON-HC
Speaker Output	4 x NL4
GENERAL	
User Interface	
Display	320 x 240 pixel, 3.5" color TFT
Front panel indicators	Full color LED illuminated ring
Front panel operating elements	Rotary encoder, Capacitive Touch Screen
Rear panel indicators	2 x LED (AES3 Input mode active, Amp-Find)
Rear panel operating elements	Mains switch
Power Requirements	100 V to 240 V, 50 Hz to 60 Hz AC
Power Consumption	
Rated Power Consumption	2250 W
1/8 Maximum Output Power at 4 Ω	2850 W
Idle Mode (no input signal)	110 W
Standby Mode	< 19 W
Power Supply Topology	Switching Mode Power Supply with digital controlled Power Factor Correction
Protections	Audio Limiters, High Temperature, DC, HF, Short Circuit, Back-EMF, Peak Current Limiters, Inrush Current Limiters, Turn-on Delay, Mains Circuit Breaker Protection, Mains Over/Under voltage Protection
Cooling:	Front-to-rear, temperature controlled fans, supervised
Ambient Temperature Limits	+5 °C to +40 °C (+40 °F to +105 °F)
IEC Protection Class	Class I (grounded)
Electromagnetical Environment	E1, E2, E3
Color	Black

Dimensions (W x H x D), mm	483 x 88.1 x 514.2
Weight	18.3 kg (40.4 lb)
Shipping Weight	20.5 kg (45.2 lb)

Amplifier at rated conditions; all channels driven, 4 Ω loads, analog input, 32 dB gain, 48 kHz sample rate, unless otherwise specified.

¹Test signal for max. output power according IHF-A-202 (Dynamic-Headroom, burst 1 kHz/20 ms on/480 ms off/low level -20 dB).

8.3 Mains operation & resulting temperature

The power drawn from the mains network is converted into output power to feed the connected loudspeaker systems and into heat. The difference between power consumption and dispensed power is called power dissipation (Pd). The amount of heat resulting from power dissipation might remain inside of a rack-shelf and needs to be diverted using appropriate measures.

For further details refer to the mains operation & resulting temperature tables available at www.dynacord.com.

8.4 Block diagram

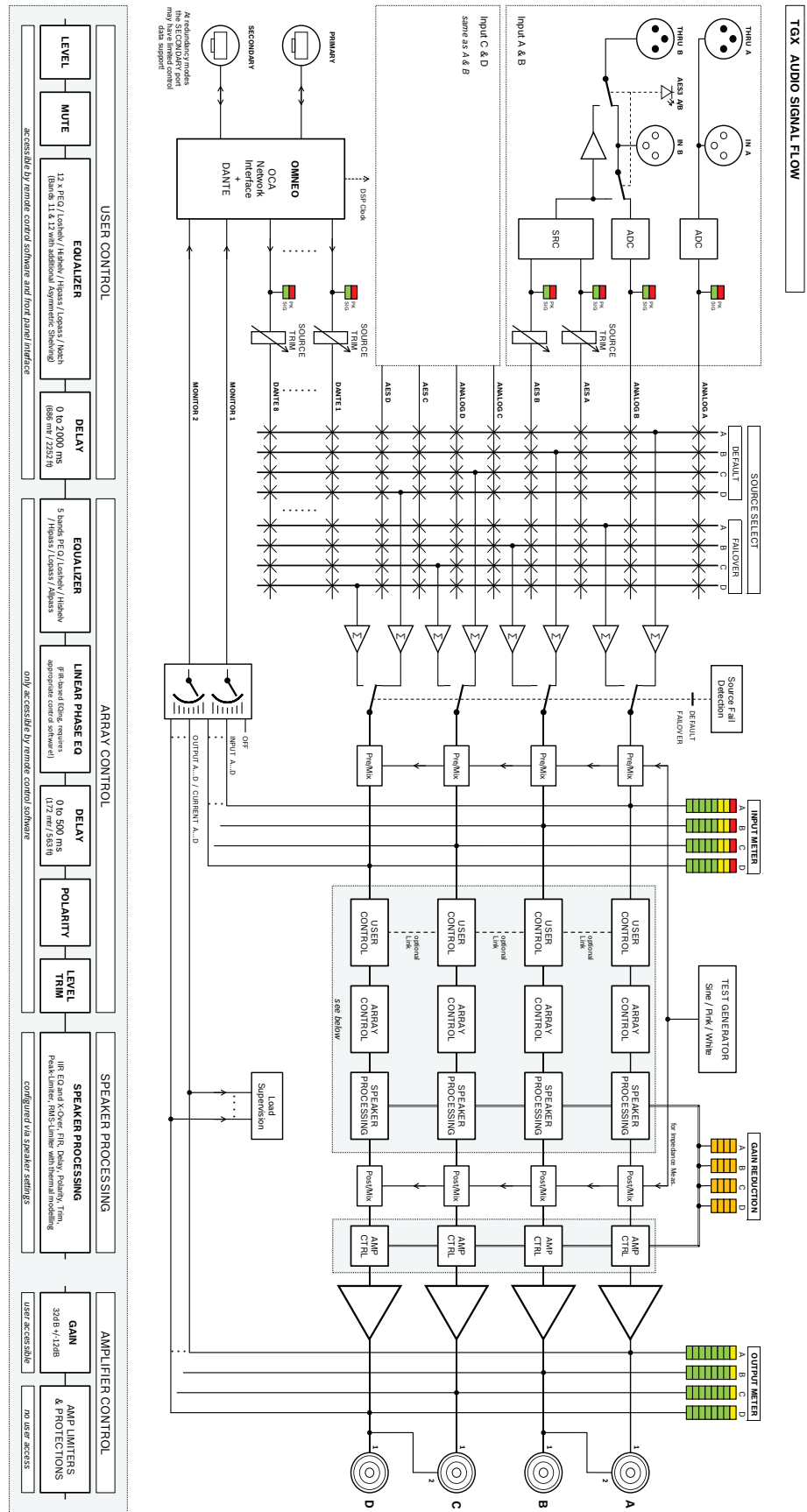

Figure 8.1: Block diagram: TGX

8.5 Dimensions

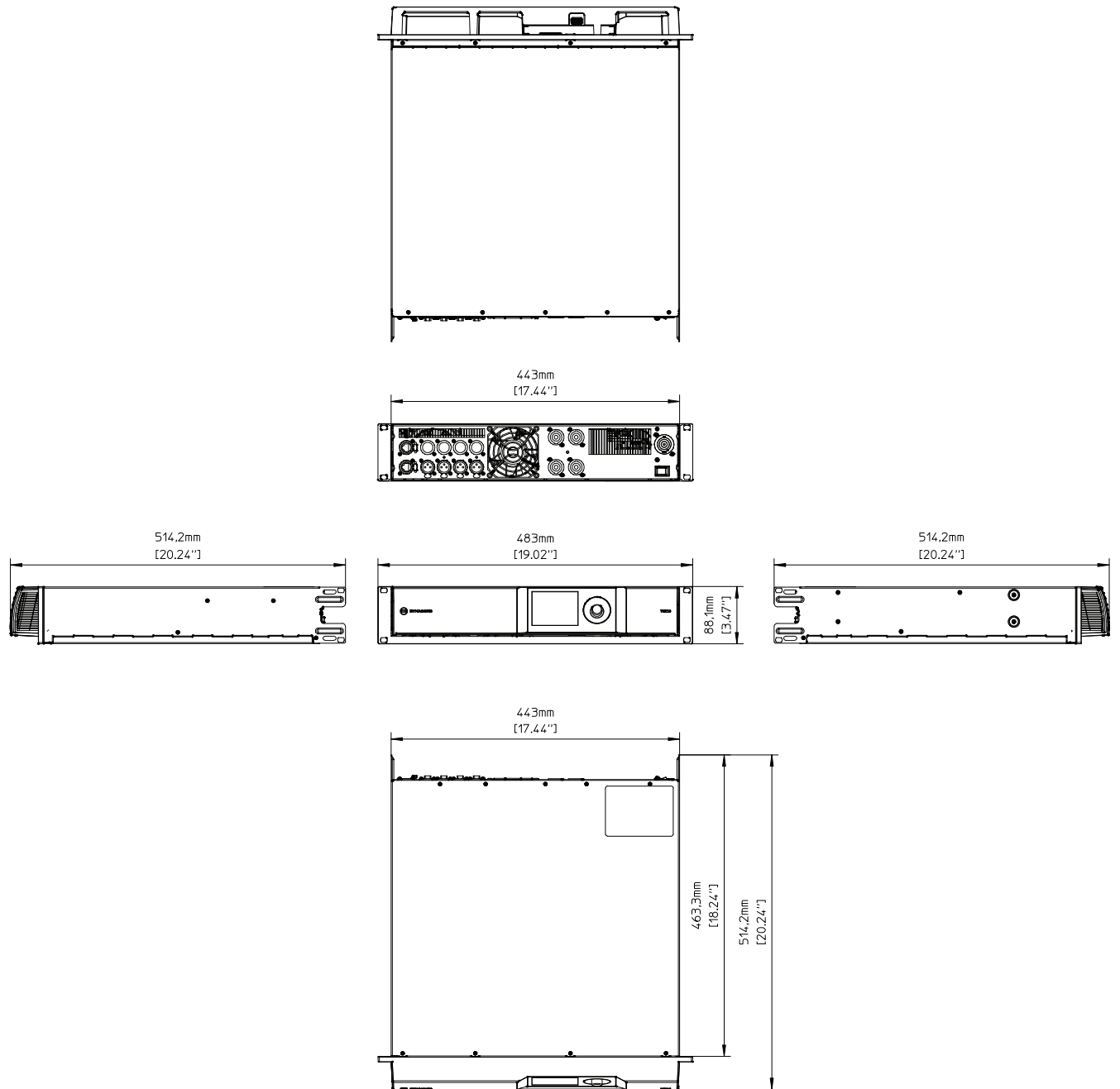
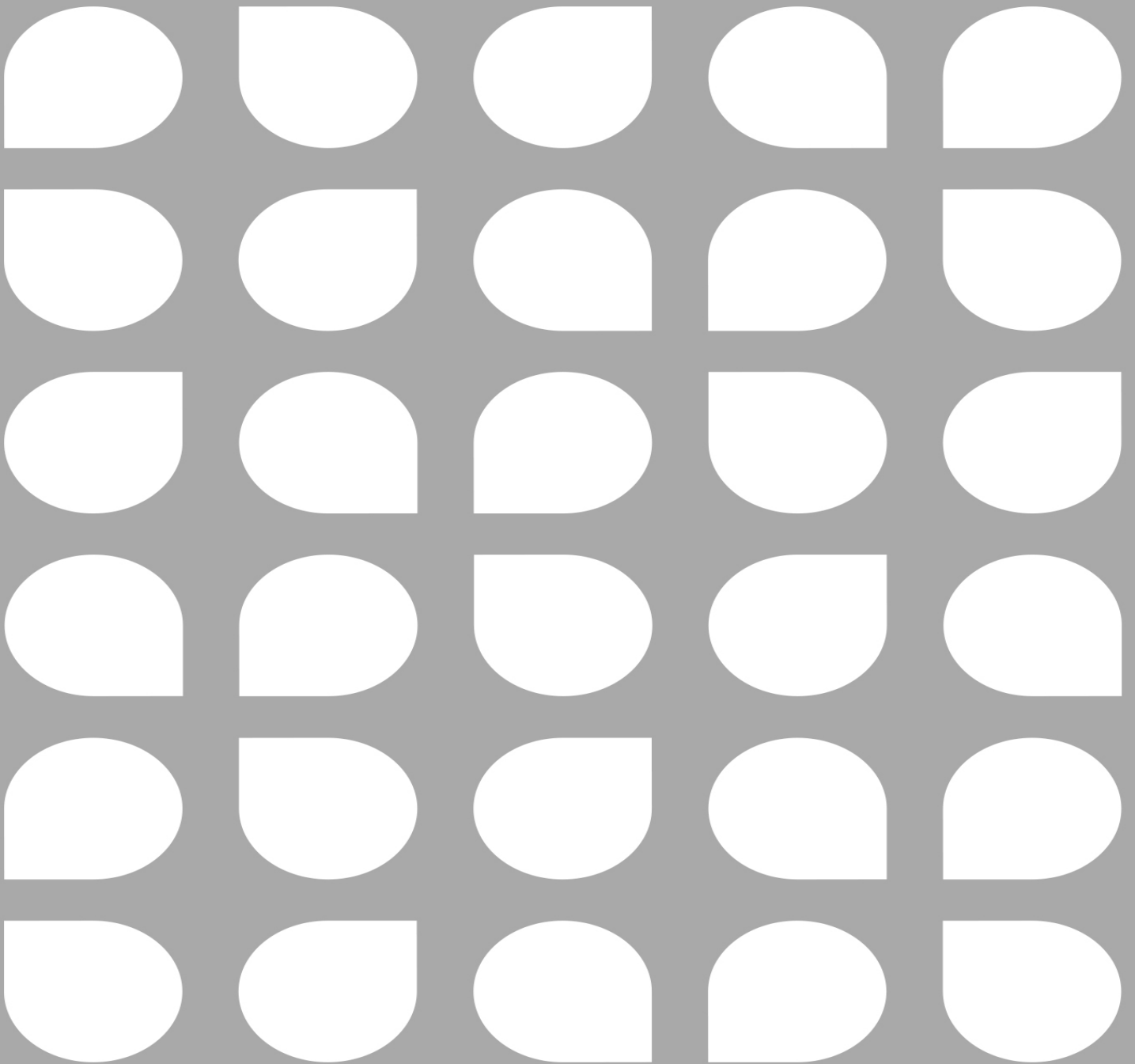

Figure 8.2: Dimensions: TGX

9 Accessories

The following accessories are available for the TGX amplifiers:

CTN	Description
PD32-EU	Power distro 3x32A, 230V, CEE 32A
PD30-US	Power distro 3x30A, 208V, NEMA L21-30
PCO32A30-US	Power cord, powerCon32/NEMA L6-30
PCO32A16-EU	Power cord, powerCon32/CEE7/7
PCO32A16-UK	Power cord, powerCon32/BS1363
PCO32A10-AU	Power cord, powerCon32/AU3-pin10A
RMK-15	Rear rack mount kit for amplifiers



Bosch Security Systems, Inc.

130 Perinton Parkway
Fairport, NY 14450
USA

www.dynacord.com

© Bosch Security Systems, Inc., 2018

Free Manuals Download Website

<http://myh66.com>

<http://usermanuals.us>

<http://www.somanuals.com>

<http://www.4manuals.cc>

<http://www.manual-lib.com>

<http://www.404manual.com>

<http://www.luxmanual.com>

<http://aubethermostatmanual.com>

Golf course search by state

<http://golfingnear.com>

Email search by domain

<http://emailbydomain.com>

Auto manuals search

<http://auto.somanuals.com>

TV manuals search

<http://tv.somanuals.com>