



Emerson®

TWIN SPEAKER AM / FM CLOCK RADIO

IMPORTANT

Call toll-free 1-800-210-2281 for exciting information
and special discounts on Extended Service Plans.

OWNER'S MANUAL

CK5030

Visit our web site at www.emersonradio.com



Thank you.....

For purchasing this Emerson AM/FM Clock Radio with Battery Back Up System. It has been designed and engineered to provide you with many years of reliable operation with a minimum of care. Listen to your favorite AM/FM radio stations; wake up to the radio or an electronic buzzer alarm; sleep to music with the auto shutoff timer; and use the Snooze Alarm when you need a few more minutes sleep before you can get up and face a new day.

The Battery Back Up System maintains the time and alarm settings in case of a power failure. Please read this instruction manual completely to make sure that you understand all the features of your new clock radio, and please save this manual for future reference.

The serial number of your radio is located on a label on the bottom of the cabinet. We suggest that you record the serial number in the space below for future reference.

Model No: CK5030

Serial Number: _____



IMPORTANT NOTES

	CAUTION RISK OF ELECTRIC SHOCK DO NOT OPEN	
CAUTION: TO REDUCE THE RISK OF ELECTRIC SHOCK, DO NOT REMOVE COVER (OR BACK). NO USER SERVICEABLE PARTS INSIDE. REFER SERVICING TO QUALIFIED SERVICE PERSONNEL.		

Avoid installing the unit in locations described below:

- Places exposed to direct sunlight or close heat radiating appliances such as electric heaters.
- Dusty places.
- Places subject to constant vibration.
- Humid or moist places.

WARNING: TO PREVENT FIRE OR SHOCK HAZARD, DO NOT EXPOSE THIS UNIT TO RAIN OR MOISTURE.



DANGEROUS VOLTAGE

Uninsulated Dangerous Voltage, that may be of sufficient magnitude to constitute a risk of electric shock to persons is present within this product's enclosure.



ATTENTION

The Owner's Manual contains important operating and maintenance instructions. For your safety, it is necessary to refer to the manual.

This device complies with part 15 of the FCC rules. Operation is subject to the condition that this device does not cause harmful interference.

PREPARATION FOR USE

UNPACKING AND SET UP

- Remove all packing materials from the unit. Also remove any descriptive labels from the front or top of the radio. Do not remove any labels from the back or bottom of the radio.
- Place the radio on a stable shelf, desk, nightstand, table, etc, convenient to a 120V 60Hz AC outlet, and away from direct sunlight or sources of heat, humidity, moisture, dust, or vibration.
- Unwind the AC power cord and the external lead wire FM antenna and extend them to their full length.

BACK UP BATTERY INSTALLATION

The Back Up battery compartment is located on the back of the radio. Open the battery door, as shown in the illustration, and connect a 9V battery (not included) to the battery terminals. The battery can only be connected one way. Push the battery back into the battery compartment and replace the battery door.

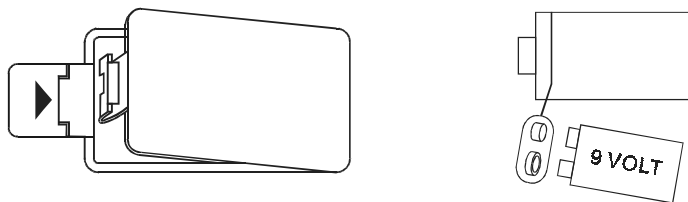

Note: Use only a well known brand of Alkaline battery for longest life and best performance.

In the event of a temporary power interruption the clock display will go off, but the back up battery will maintain the time and alarm settings. When power is restored the clock display will come on again and the time and alarm settings will be correct.

POWER FAILURE INDICATION

If you do not install a battery, or if the battery is exhausted and the power is interrupted, the time and alarm settings will be lost. When power is restored the display will begin flashing. This flashing display is your indication that the clock is incorrect and you must reset both the time and alarm settings.

LOCATION OF CONTROLS AND INDICATORS

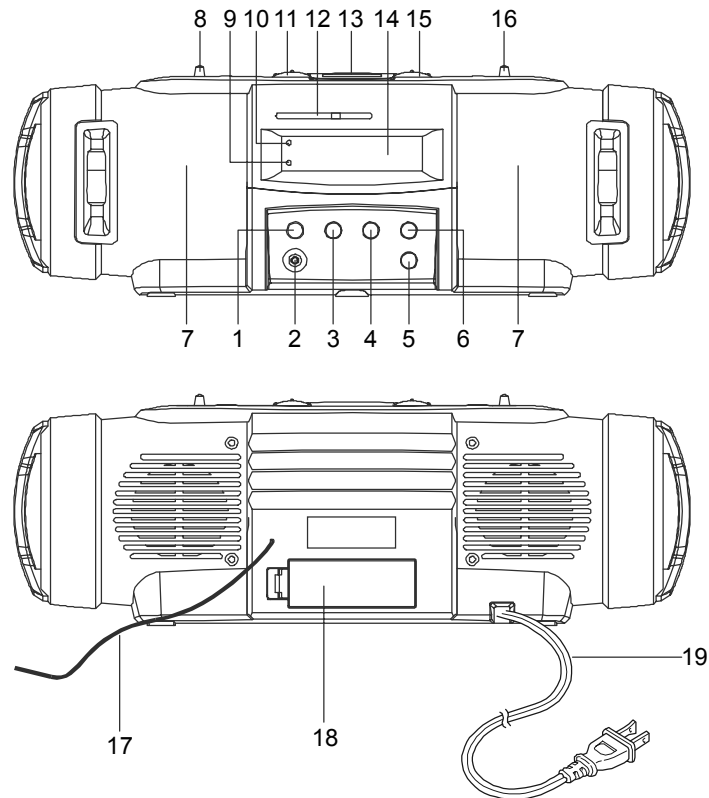

- | | |
|--------------------------------|-------------------------------|
| 1. SLEEP Button. | 10. AM Indicator. |
| 2. PHONES (Headphone) Jack. | 11. VOLUME Control. |
| 3. AL. (Alarm) SET/OFF Button. | 12. Tuning Dial. |
| 4. TIME Button. | 13. SNOOZE Button. |
| 5. MIN (Minute) Button. | 14. Clock Display. |
| 6. HOUR Button. | 15. TUNING Control. |
| 7. Speakers. | 16. BAND (AM/FM) Selector. |
| 8. FUNCTION Selector. | 17. External FM Wire Antenna. |
| 9. AL. (Alarm) Set Indicator. | 18. Battery Door. |
| | 19. AC Power Cord. |

OPERATING INSTRUCTIONS

POWER SOURCE

This radio is designed to operate on normal 120V 60Hz AC house current only. Operating the radio with any other power supply may cause damage to the unit which is not covered by your warranty.

Fully extend the AC power cord and insert the plug into a polarized AC outlet. Note that this unit has a polarized AC plug with one wide blade and one narrow blade. This is a safety feature designed to protect you from electric shock. If this plug will not fit into your outlet you may have an outdated, non-polarized outlet. Do not try to defeat this safety feature by using an adapter, or filing the wider blade on the plug to make it fit into your outlet. Contact a licensed electrician to replace your outdated outlet.

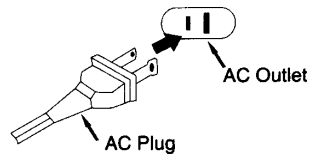

Note: Be sure to connect this radio to an outlet that is always 'live'. Do not connect this unit to an outlet that is controlled by a wall switch.

SETTING THE CLOCK

When the unit is plugged in for the first time the clock will show (AM) " 12:00" and the display will flash. The flashing will stop after the clock has been set.

1. Depress the TIME button and the HOUR button together to adjust the clock to the correct hour, then release the buttons.

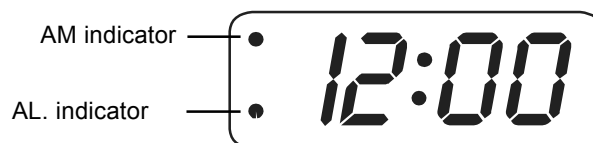

Note: Be sure to set the hour correctly for AM or PM. If the AM Indicator is 'On', the time displayed is AM. If the AM indicator is 'Off', the time displayed is PM.

2. Depress the TIME button and the MINUTE button together to adjust the clock to the correct minute, then release the buttons.



SETTING THE WAKE UP TIME

1. Depress the AL. SET/OFF button and the HOUR button together to adjust the clock display to the correct wake-up hour, then release the buttons. Be sure to set the wake-up hour correctly for either AM or PM.
2. Depress the AL. SET/OFF button and the MIN button together to adjust the clock display to the correct wake-up minute, then release the buttons.

LISTENING TO RADIO

1. Set the BAND switch to the desired band, AM or FM.
2. Set the VOLUME control to a low setting.
3. Slide the FUNCTION switch to the 'ON' position.
4. Use the TUNING control to select the desired station.
5. Adjust the VOLUME control to a comfortable level.
6. When you are finished listening, slide the FUNCTION switch to the 'OFF' position.

Hints For Better Reception

FM - If FM reception is noisy or weak try varying the position and direction of the external FM antenna wire to find the best reception.

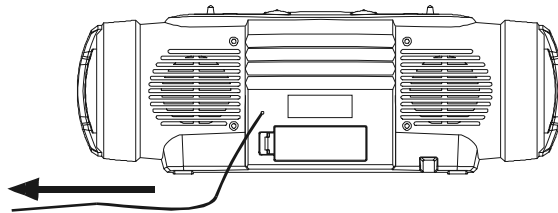

AM - The AM antenna is inside the radio cabinet. If AM reception is unsatisfactory, try rotating or repositioning the cabinet until you find the position that provides the best reception for that particular station.

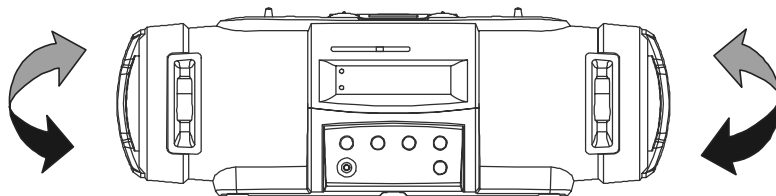



WAKE TO RADIO

1. Depress the AL. SET/OFF button. The display will change from the correct time to wake up time. Adjust the wake up time as described on page 6, if necessary.
2. Slide the FUNCTION switch to the ON position and select the station and the volume level that you want to hear when you wake up.
3. Slide the FUNCTION switch to the AUTO position. The radio will turn 'Off'.
4. At the selected wake up time the radio will turn 'On' automatically. It will play for 1 hour and 59 minutes and then shut off automatically and reset itself for the following day.
5. To stop the radio sooner, press the AL. SET/OFF button. The radio stops and the alarm resets for the following day.

WAKE TO BUZZER ALARM

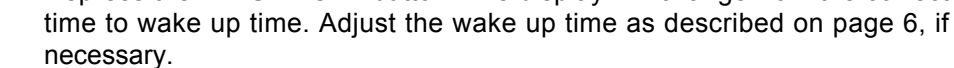
- 
1. Depress the AL. SET/OFF button. The display will change from the correct time to wake up time. Adjust the wake up time as described on page 6, if necessary.
 2. Slide the FUNCTION switch to the ALARM position.
 3. At the selected wake up time an electronic buzzer alarm will turn 'On' automatically. It will continue for 1 hour and 59 minutes and then shut off automatically and reset itself for the following day.
 4. To stop the buzzer alarm sooner, press the AL. SET/OFF button. The buzzer stops and the alarm resets for the following day.

SNOOZE (REPEAT ALARM)

If you need a few extra minutes sleep when the alarm comes on in the morning, press the SNOOZE button. The alarm will stop for approximately 9 minutes, and then turn on again. This operation can be repeated several times if necessary.



SLEEP TO MUSIC TIMER

The sleep to music timer allows you to fall asleep to music for up to 1 hour and 59 minutes, and then shuts the radio off automatically.

The sleep timer can be activated when the FUNCTION switch is set to the OFF, AUTO, or ALARM positions.

1. Depress the SLEEP button to start the sleep timer. The display indicates "0:59" and the radio turns on.
2. To adjust the amount of sleep timer operation, continue to hold the SLEEP button and depress the MIN button. The display starts counting down from 59 minutes. Release the MIN button when the display shows the desired minute. To add 1 hour, continue to hold the SLEEP button and press the HOUR button once.
3. When the desired amount of sleep time appears on the display, release all the buttons. The radio will continue to play until the sleep timer counts down to "0:00", and then the radio shuts off automatically.
4. To shut off the radio and cancel the sleep timer before it counts down to "0:00", press the SNOOZE button. The radio stops immediately.



IMPORTANT:

Remember that the station and volume setting that you select for sleep timer operation are the same settings you will hear the following morning if you have the alarm set for 'WAKE TO RADIO'.

HEADPHONE JACK

Connect a set of headphones (not included) to this jack for private listening. The speaker is shut off automatically when headphones are connected.

CARE AND MAINTENANCE

There are no user serviceable parts inside this radio. Please refer all service problems to a qualified service facility. See the Warranty page of this manual for further details.

If the cabinet becomes dusty, wipe the exterior with a soft dust cloth only. Never use dusting sprays or polishes on the cabinet.

If the cabinet becomes dirty or smudged with fingerprints it may be wiped with a soft cloth that has been slightly dampened with a mild soap and water solution. Always disconnect the power cord from the AC outlet before cleaning, and never allow any liquid to get inside the cabinet.

Note: If there is no battery in the back-up battery compartment, the Time and Alarm settings will be lost when the power cord is disconnected for cleaning. Reset the clock and wake up times after reconnecting the power cord.



TO FIND THE LOCATION AND PHONE NUMBER
OF YOUR NEAREST SERVICE CENTER
PERMITTED TO PERFORM WARRANTY...

CALL TOLL FREE: 1-800-695-0098

FOR CUSTOMER SERVICE, PLEASE WRITE TO:
Emerson Radio Corp.
Consumer Affairs Dept.
1901 Diplomat Drive,
Farmers Branch, TX 75234.

**EMERSON RADIO CORP.
LIMITED WARRANTY**

What does this warranty cover ? Any manufacturing defects in original material, including original parts and workmanship, under normal use and conditions.

For how long? For a period of ninety (90) days from the date of original purchase in the U.S.

What will we do ? If you need service under this Warranty, and you provide us with the dated proof of purchase, we will provide repair service at no charge for labor and parts at an authorized Depot Repair Facility, or replace the product in our discretion.

How do you make your warranty claim ? If it becomes necessary to repair your unit, you can obtain the name and mailing location of a Depot Repair Facility by dialing **1-800-695-0098**. You should pack your unit in a well-padded heavy corrugated box, enclose your check or money order payable to the Depot Repair Facility in the amount of **\$9.00** to cover the return shipping and handling costs, and enclose a copy of your proof of purchase (warranty service will not be provided without a dated proof of purchase). Finally, you should ship the unit prepaid via UPS or parcel post (insured).

What does your warranty not cover ? Your warranty does not cover the following :

- Damage from negligence, misuse, abuse, accident, or failure to follow operating instructions.
- Use of product in a commercial application or rentals.
- Changes or repairs by anyone other than an authorized Depot Repair Facility.
- Damage because your unit is improperly connected to the equipment of other manufacturers.
- Unit on which the serial number has been defaced, modified or removed.
- Damage to equipment not properly connected to the product.
- Cost incurred in shipping your unit to and from an authorized Depot Repair Facility.
- Ordinary adjustments which you can perform as outlined in the owner's manual.
- Signal reception problems caused by external antenna or cable systems.
- Products purchased, used, serviced, or damaged outside of the United States.
- Damage to compact discs or cassettes.

What other limitations apply to your warranty ?

THIS WARRANTY IS NON-TRANSFERABLE AND APPLIES ONLY TO THE ORIGINAL PURCHASER AND DOES NOT EXTEND TO SUBSEQUENT OWNERS OF THE PRODUCT. THIS WARRANTY IS VALID ONLY IN THE UNITED STATES OF AMERICA. ANY APPLICABLE IMPLIED WARRANTIES, INCLUDING THE WARRANTY OF MERCHANTABILITY, ARE LIMITED IN DURATION TO A PERIOD OF THE EXPRESSED WARRANTY AS PROVIDED ABOVE BEGINNING WITH THE DATE OF ORIGINAL PURCHASE AT RETAIL AND NO WARRANTIES, WHETHER EXPRESSED OR IMPLIED, SHALL APPLY TO THE PRODUCT THEREAFTER. WE MAKE NO WARRANTY AS TO THE FITNESS OF THE PRODUCT FOR ANY PARTICULAR PURPOSE OR USE.

THE EXTENT OF OUR LIABILITY UNDER THIS LIMITED WARRANTY IS THE REPAIR OR REPLACEMENT PROVIDED ABOVE AND IN NO EVENT WILL OUR LIABILITY EXCEED THE PURCHASE PRICE PAID BY THE PURCHASER OF THE PRODUCT. UNDER NO CIRCUMSTANCES WILL WE BE LIABLE FOR ANY LOSS, DIRECT, INDIRECT, INCIDENTAL, SPECIAL, OR CONSEQUENTIAL DAMAGE ARISING OUT OF OR IN CONNECTION WITH THE USE OF THIS PRODUCT.

How does state law apply to your warranty ?

THIS WARRANTY GIVES YOU SPECIFIC LEGAL RIGHTS, BUT YOU MAY ALSO HAVE OTHER RIGHTS WHICH VARY FROM STATE TO STATE. SOME STATES DO NOT ALLOW LIMITATIONS ON IMPLIED WARRANTIES OR EXCLUSION OR LIMITATION OF INCIDENTAL OR CONSEQUENTIAL DAMAGE, SO THESE RESTRICTIONS MAY NOT APPLY TO YOU.

AU898F



EMERSON RADIO CORP.



EMERSON
Part No. : 16-2820
105-01

Printed in China



Free Manuals Download Website

<http://myh66.com>

<http://usermanuals.us>

<http://www.somanuals.com>

<http://www.4manuals.cc>

<http://www.manual-lib.com>

<http://www.404manual.com>

<http://www.luxmanual.com>

<http://aubethermostatmanual.com>

Golf course search by state

<http://golfingnear.com>

Email search by domain

<http://emailbydomain.com>

Auto manuals search

<http://auto.somanuals.com>

TV manuals search

<http://tv.somanuals.com>