

Jumbo Display

Dual Alarm AM/FM Clock Radio

with ATOMIC CLOCK

Automatic Time Setting System

OWNER'S MANUAL



CKA1100

Visit our web site at www.emersonradio.com



WARNING

TO PREVENT FIRE OR SHOCK HAZARD, DO NOT USE THIS PLUG WITH AN EXTENSION CORD, RECEPTACLE OR OTHER OUTLET UNLESS THE BLADES CAN BE FULLY INSERTED TO PREVENT BLADE EXPOSURE. TO PREVENT FIRE OR SHOCK HAZARD, DO NOT EXPOSE THIS APPLIANCE TO RAIN OR MOISTURE.

 <p>The lightning flash with arrow-head symbol, within an equilateral triangle is intended to alert the user to the presence of uninsulated 'dangerous voltage' within the product's enclosure that may be of sufficient magnitude to constitute a risk of electric shock to persons.</p>	<p style="text-align: center;">WARNING</p> <p style="text-align: center;">RISK OF ELECTRIC SHOCK DO NOT OPEN</p> <p>CAUTION: TO REDUCE THE RISK OF ELECTRIC SHOCK DO NOT REMOVE COVER (OR BACK), NO USER SERVICEABLE PARTS INSIDE REFER SERVICING TO QUALIFIED SERVICE PERSONNEL.</p>	 <p>The exclamation point within an equilateral triangle is intended to alert the user to the presence of important operating and maintenance (servicing) instructions in the literature accompanying the appliance.</p>
--	--	---

IMPORTANT SAFETY INSTRUCTIONS

- 1.) Read these instructions.
- 2.) Keep these instructions.
- 3.) Heed all warnings.
- 4.) Follow all instructions.
- 5.) Do not use this apparatus near water.
- 6.) Clean only with dry cloth.
- 7.) Do not block any ventilation openings. Install in accordance with the manufacturer's instructions.
- 8.) Do not install near any heat sources such as radiators, heat registers, stoves, or other apparatus (including amplifiers) that produce heat.
- 9.) Do not defeat the safety purpose of the polarized or grounding-type plug. A polarized plug has two blades with one wider than the other. A grounding type plug has two blades and a third grounding prong. The wide blade or the third prong are provided for your safety. If the provided plug does not fit into your outlet, consult an electrician for replacement of the obsolete outlet.
- 10.) Protect the power cord from being walked on or pinched particularly at plugs, convenience receptacles, and the point where they exit from the apparatus.
- 11.) Only use attachments / accessories specified by the manufacturer.
- 12.) Unplug this apparatus during lightning storms or when unused for long periods of time.
- 13.) Refer all servicing to qualified service personnel. Servicing is required when the apparatus has been damaged in any way, such as power-supply cord or plug is damaged, liquid has been spilled or objects have fallen into the apparatus, the apparatus has been exposed to rain or moisture, does not operate normally, or has been dropped.
- 14.) This appliance shall not be exposed to dripping or splashing water and that no object filled with liquids such as vases shall be placed on the apparatus.
- 15.) Do not overload wall outlet. Use only power source as indicated.
- 16.) Use replacement parts as specified by the manufacturer.
- 17.) The product may be mounted to a wall only if recommended by the manufacturer.
- 18.) Upon completion of any service or repairs to this product, ask the service technician to perform safety checks.



Thank you

for purchasing the world's most accurate clock radio from Emerson Research. The CKA1100 is designed to receive and decode the time signals transmitted from the U.S. Atomic Clock, which is operated by the National Institute of Standards and Technology (NIST) at Fort Collins, Colorado. This is the same time signal that is used by the U.S. military, and agencies such as NASA, to time Shuttle launches, space walks, etc. Whenever split second accuracy is essential the U.S government relies on the Atomic Clock. And now you can too. The Atomic Clock is considered accurate to within **plus or minus one second per million years!** This is the clock that you will use to set every other clock in your home.

In addition to the absolute accuracy the CKA1100 also adjusts for Daylight Saving Time and Leap Years automatically. And the month/date calendar display also adjusts automatically for months of less than 31 days. There are dual alarms that can be programmed for weekdays only, weekends only, or all 7 days; a great sounding AM/FM radio; and an extra large display for both time and month/date that you can see from anywhere in your room.

We believe this may be the best clock radio available anywhere. We know it's the most accurate.

Please be sure to read this manual completely so you understand how the CKA1100 receives the Atomic Clock signal, and how to take advantage of all the other great features we have included in this model. If you have any problems with the set-up or operation of this model please call the Emerson Research Customer Service Hot-Line toll free at: 800-898-9020.

Once again, thanks for purchasing the CKA1100 from Emerson Research.

The serial number of your unit is located on a label on the bottom of the cabinet. We suggest you record the serial number in the space below in the event that it is needed again for any reason.

Model No. CKA1100
Serial No. _____



IMPORTANT NOTES

- Avoid installing this unit in places exposed to direct sunlight or close to heat radiating appliances such as electric heaters, on top of other stereo equipment that radiates too much heat, places lacking ventilation or dusty areas, places subject to constant vibration and/or humid or moist areas.
- Operate controls and switches as described in the manual.
- Before turning on the power, make certain that the power cord is properly installed.
- When moving the set, be sure to first disconnect the AC power cord.

FCC INFORMATION

This equipment has been tested and found to comply with the limits for a Class B digital device, pursuant to Part 15 of the FCC Rules. These limits are designed to provide reasonable protection against harmful interference in a residential installation. This equipment generates, uses, and can radiate radio frequency energy and, if not installed and used in accordance with the instructions, may cause harmful interference to radio communications. However, there is no guarantee that interference will not occur in a particular installation. If this equipment does cause harmful interference to radio or television reception, which can be determined by turning the equipment off and on, the user is encouraged to try to correct the interference by one or more of the following measures:

- Reorient or relocate the receiving antenna.
- Increase the separation between the equipment and receiver.
- Connect the equipment into an outlet on a circuit different from that to which the receiver is connected.
- Consult the dealer or an experienced radio/TV technician for help.

This device complies with Part 15 of the FCC Rules. Operation is subject to the following two conditions:

- (1) This device may not cause harmful interference, and
- (2) This device must accept any interference received, including interference that may cause undesired operation.



PREPARATION FOR USE

UNPACKING AND SET-UP

- Remove the radio and the external WWVB long wave antenna from the carton and remove all packing materials from the radio. Please save the carton and packing materials if possible in the unlikely event that the radio ever needs to be returned for service. Using the original carton and packing materials is the only way to pack the radio safely to avoid damage in transit.
- Remove any descriptive stickers or labels from the front or top of the cabinet. Do not remove any labels from the back or bottom of the cabinet.
- Extend the AC power cord to its full length.
Note: The FM Antenna is built into the AC power cord.
- Extend the wire of the external WWVB long wave antenna to its full length. Insert the plug from the antenna wire into the antenna jack on the back of the radio.

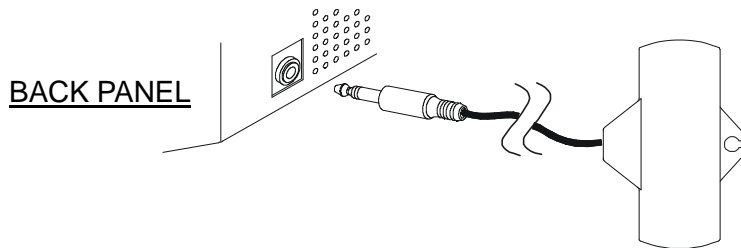

POWER SOURCE

This radio is designed to operate on normal 120V 60Hz AC power only. Do not attempt to operate the radio on any other power source. You could cause damage to the radio that is not covered by your warranty.

This radio should be connected to an AC outlet that is always 'live'. Do not connect it to an outlet that is controlled by a wall switch. When the power to the radio is interrupted, the back up battery take over to maintain the time and alarm settings. To maximize the life of the battery keep the radio connected to a 'live' AC outlet at all times.

You will note that this system is equipped with a polarized AC power plug having one blade wider than the other. This is a safety feature. If this plug does not fit into your existing AC outlet, do not try to defeat this safety feature by filing the wide blade to make it fit into your outlet. If this plug will not fit into your outlet, you probably have an out-dated non-polarized AC outlet. You should have your outlet changed by a qualified licensed electrician.

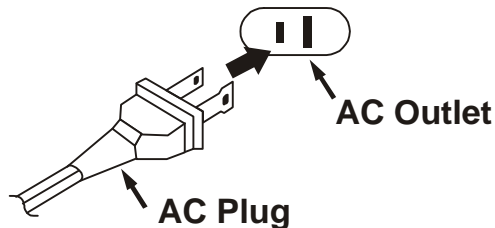

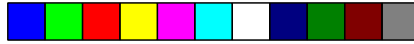

BATTERY BACK-UP SYSTEM

This model includes a battery back-up system that will maintain your time and alarm settings in the event of a temporary power interruption. If power is interrupted the display will go 'Off', but the batteries will continue to power the clock. When power is restored the display will come 'On' again and your time and alarm settings will be correct.

The battery back-up system requires 2 "AA" batteries, not included. We recommend that you use a well-known brand of alkaline batteries for longest life and best performance. The life of the batteries is affected by the frequency and length of the power interruptions that occur in your home. For best results we recommend changing the batteries every 12 months. There is also a "BATT. LOW" indicator on the front panel that will warn you when the batteries are getting weak and need to be replaced.

To install or replace the batteries:

1.) Place the radio face down. We suggest you place a towel or similar soft cloth under the radio to avoid scratching the front lens.

2.) Remove the battery door by pressing down on the tab as illustrated.

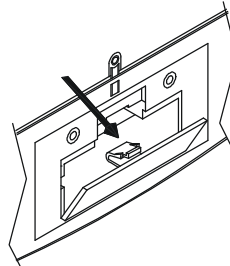

3.) Insert 2 "AA" alkaline batteries into the compartment as illustrated.

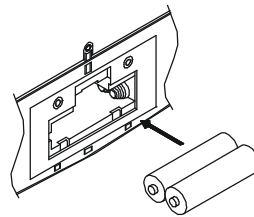

4.) Replace the battery door and place the radio right side up.

If there are no back-up batteries installed, or the back-up batteries are exhausted, and you experience a power interruption the time and alarm settings will be lost. Although the time will be reset automatically the next time the Atomic Clock signal is received, the alarm times must be reset manually. We recommend that you change the batteries as soon as you notice the BATT. LOW indicator is 'On', and after changing the batteries check and adjust the alarm time settings if necessary.



LOCATION OF CONTROLS AND INDICATORS

Top Panel

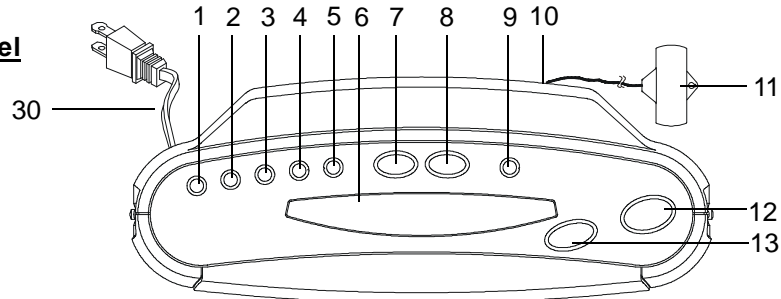

Front Panel

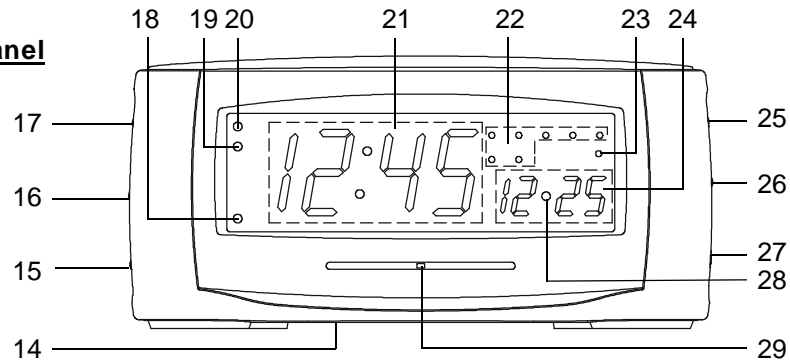

- | | |
|--|--|
| <p>1.) DATE/MONTH Setting Button.</p> <p>2.) TIME Setting/SECOND Button.</p> <p>3.) ALARM MODE Button.
(Weekdays/Weekends/Everyday Alarm)</p> <p>4.) ALM(Alarm) 1 Setting Button.</p> <p>5.) ALM(Alarm) 2 Setting Button.</p> <p>6.) SNOOZE/SLEEP OFF Button.</p> <p>7.) SET – Button.</p> <p>8.) SET + Button.</p> <p>9.) TIME ZONE Button.</p> <p>10.) WWVB Antenna Jack. (Back of Cabinet)</p> <p>11.) WWVB Antenna.</p> <p>12.) RADIO ON/OFF Button.</p> <p>13.) SLEEP Button.</p> <p>14.) Back Up Battery Compartment.
(Bottom of Cabinet)</p> <p>15.) Display DIMMER(HIGH/LOW) Switch.</p> | <p>16.) ALARM 2 Selector Switch.
(RADIO/BUZZER/OFF)</p> <p>17.) ALARM 1 Selector Switch.
(RADIO/BUZZER/OFF)</p> <p>18.) ALM(Alarm) 2 'On' Indicator.</p> <p>19.) ALM(Alarm) 1 'On' Indicator.</p> <p>20.) AM Indicator.</p> <p>21.) Time Display.</p> <p>22.) Day Indicators.</p> <p>23.) BATT. LOW Indicator.</p> <p>24.) Month/Date Display.</p> <p>25.) VOLUME Control.</p> <p>26.) BAND(AM/FM) Switch.</p> <p>27.) TUNING Control.</p> <p>28.) WWVB SIGNAL Indicator.</p> <p>29.) Lighted Dial Pointer.</p> <p>30.) AC Power Cord.</p> |
|--|--|

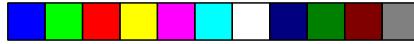

OPERATING INSTRUCTIONS

IMPORTANT INFORMATION ABOUT THE ATOMIC CLOCK TIME SIGNAL

- This clock radio is designed to receive and decode the U.S. Atomic Clock time signal transmitted from station WWVB. This station is operated by the National Institute of Standards and Technology (NIST) and is located near Fort Collins, Colorado at latitude 40° 40' 28.3"N and longitude 105° 02' 39.5" W. The time signal is broadcast continuously on the long wave band at a transmission frequency of 60kHz.
- Although the signal can be received anywhere in the continental United States, the southern portions of Canada and the northern portions of Mexico, the greater the distance from Fort Collins, the weaker the signal becomes. The most difficult area for reception is the northeastern coastal region of the USA. In addition to the distance from Fort Collins there is also a high level of interference in this area. This area is also in range of station MSF in Teddington, Middlesex, England. Station MSF is also transmitting at 60kHz and the signal from this station can interfere with signal from station WWVB, especially in the area from Maine to New York.
- Automatic time setting is never instantaneous, even if your home was located next door to the transmitter. The Atomic Clock time signal consists of a 'stream' of information that normally takes between two and three minutes to receive and be decoded before the clock in this radio can set itself. Also if the signal is subjected to interference during reception the clock will be unable to decode the information and set itself. In some cases if the signal was 'corrupted' during reception the clock might actually display an incorrect time. However when the signal is finally received correctly and the information decoded the clock will correct itself automatically.



- Under the best conditions, receiving a strong signal with no interference, the clock will take at least 5 minutes to receive and decode the signal and display the correct month, date, day, and time. If you live in an area of poor reception and high interference it could take several hours, or even overnight, for the clock to set itself correctly. This is completely normal and not an indication of any problems with your unit. If you live in one of the difficult reception areas, please read all of the instructions very carefully, and please be patient.
- The best time for reception of the WWVB signal is the period between midnight and dawn, because interference from other sources tends to be lower during these hours.
- Reception of the Atomic Clock time signal may also be difficult in buildings with steel frames, such as high rise apartment or office buildings, which usually also have windows with steel frames, and buildings with steel roofs. Large amounts of steel may block reception of the signal.



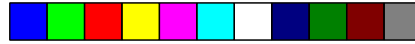

INFORMATION ABOUT THE WWVB SIGNAL RECEIVER IN CKA1100

- When the radio is connected to AC power for the first time the receiver turns 'On' automatically and tries to receive the WWVB time signal. If the signal is received successfully the clock display will scroll for a few moments and then show the correct month, date, day, and time in the Eastern Zone (ZONE 01), which is the default time zone.
- If the WWVB time signal is not received within 10 minutes the receiver switches 'Off' and the display shows 12:10 (AM), Monday 1 01 (January 1st). The clock starts running at this point. At the beginning of each hour the receiver again turns 'On' automatically and tries to receive the WWVB signal for 10 minutes. This 10 minute 'On' and 50 minute 'Off' cycle will continue indefinitely until the WWVB signal is received.
- You can turn the receiver 'On' at any time by pressing the "+" and "-" buttons together. If you do switch it on manually in this manner it will listen for the WWVB signal for 10 minutes and then shut 'Off' again.
- Since the WWVB receiver can generate Radio Frequency Interference (RFI) that can interfere with normal AM/FM reception we have designed this model so that the WWVB receiver automatically switches 'Off' whenever the AM/FM radio is turned 'On'. If you switch the radio 'On' before the WWVB signal is received the clock will not be able to set itself while that radio is 'On'. After switching the radio 'Off' press the "+" and "-" buttons together to switch the WWVB receiver 'On' again.
- The WWVB receiver is automatically programmed to switch 'On' every day for 10 minutes at the hours of 1 AM, 2 AM, 3 AM, 4 AM, and 5 AM when the WWVB signal is strongest. So even after the WWVB signal was received and the clock has set itself, it will continue to monitor the WWVB signal 5 times each day and resynchronize itself if necessary to maintain perfect accuracy.
- If you live in a difficult reception area and you do not wish to wait for the clock to set itself automatically you may set the clock manually by following the instructions below. However once the WWVB signal is finally received the clock will synchronize itself automatically with the U.S Atomic Clock. Some people like to set their clocks 5 or 10 minutes fast to make sure they are always "on time". That is not possible with this or any other "atomic clock". Once the WWVB signal is received the clock will ignore your setting and readjust itself to the correct time automatically.



SETTING THE CLOCK THE FIRST TIME

Location, Location, Location.

Since the WWVB signal can be blocked or shielded by large metal objects, and affected by interference from other electronic devices, please do not place the radio and the external antenna in a metal cabinet, on a metal table, metal stand, or metal shelf. And do not position it next to a computer, television set, cordless telephone, audio system, or other devices that either receive or transmit radio signals. If you live in a fringe reception area we recommend placing the radio near a window that faces in the general direction of Colorado.

Positioning The External WWVB Antenna

Make sure that the plug from the external WWVB antenna is fully inserted into the jack on the back of the radio cabinet. The antenna should be positioned as far away from the radio cabinet as the antenna wire will allow. If you have the radio on a night table or desk you may allow the antenna to hang down behind the table or desk. You may also hang the antenna on a wall using a small tack or nail and the “keyhole” provided on the antenna housing. If you live in a fringe reception area you may also tape the antenna to a window for better reception of the WWVB signal. Keep the antenna away from large metal objects or other electrical appliances.

Automatic Time Setting

- After you confirm that the WWVB antenna is firmly connected to the antenna jack, and you have installed the recommended back up batteries, connect the AC power cord to a convenient 120V 60Hz AC outlet. Confirm that the “BATT LOW” indicator is not ‘On’.

Note: Make sure that the outlet is always “live”. Do not connect this radio to an outlet that is controlled by a wall switch.

- All of the indicators in the display will illuminate momentarily and then the display will show “ZONE 01”. The SIGNAL indicator will flash 4 times to confirm that the WWVB receiver is ‘On’.



- If the receiver detects the WWVB signal the SIGNAL indicator will remain 'On'. When the receiver receives and decodes the complete information stream from WWVB the clock display will suddenly begin scrolling for a few seconds and then the display will show the correct Month, Date, Day, and Time in the Eastern Time Zone. If you live in the eastern Time Zone there is nothing else to do. Your unit is now synchronized with the U.S. Atomic Clock and the SIGNAL indicator will remain 'On'.
- If you live in a different time zone you should now adjust the display to your own time zone by holding the TIME ZONE button and pressing the "+" button to select your own zone as follows:

ZONE 02 — CENTRAL TIME
ZONE 03 — MOUNTAIN TIME
ZONE 04 — PACIFIC TIME

You only need to adjust the Time Zone setting once and the unit will remember your zone automatically.

Note: If AC power is interrupted and the back up batteries are exhausted the clock will again default to "ZONE 01" when the power is restored.

Failure To Receive The WWVB Signal

- If the internal receiver fails to receive the WWVB signal, the receiver shuts 'off' and the display changes from "ZONE 01" to "12:10 (AM) Monday 1 01" and the clock continues running at that point.
- After 50 minutes the receiver automatically switches 'On' again and listens for the WWVB signal for another ten minutes. This cycle will be repeated indefinitely until the WWVB signal is successfully received and the correct time is displayed.

Note: Remember that if the Radio is turned 'on' the WWVB receiver turns 'Off' automatically. So if you turn the radio 'On' before the WWVB signal is received you must manually turn 'On' the WWVB receiver again after you turn the Radio 'Off'. Turn 'On' the WWVB receiver by pressing the "+" and "-" buttons together. The SIGNAL indicator will flash 4 times to confirm that the receiver is 'On' again.

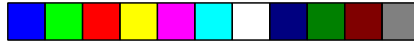

Manual Time Setting

If the receiver fails to detect the WWVB signal after several tries and you do not want to wait until the reception condition improves, you may also set the time manually as follows:

- 1.) Set the display to the correct year. Depress the DATE/MONTH and TIME buttons together. The Month/Date display will show the initial default year of 2001. Continue to press the DATE/MONTH and TIME buttons and press the “+” button to advance the year display to the correct year.
- 2.) Set the display to the correct month and date. Depress the DATE/MONTH button. The month/date display will show the initial default month and date of January 1st (1 01). Continue to press the DATE/MONTH button and press the “+” (or “-”) buttons to advance the month/date display to the correct setting. The Day indicator will change automatically to match the month/date display. You do not adjust the Day display separately.
- 3.) Set the display to the correct time. Depress the TIME/SECONDS button and the “+” or “-” buttons to move the display forward or backward to the correct time. The display changes slowly at first and then begins to change rapidly. If you pass the correct time simply press the “+” or “-” buttons to back up to the correct setting.

Notes:

- Be sure to observe the AM indicator to make sure you have set the time correctly. If the AM indicator is ‘On’ the time displayed is “AM”. If the AM indicator is ‘Off’ the time displayed is “PM”.
- After setting the time recheck the month/date display. If you advanced the time past midnight (12:00 AM) the month/date display will change. Re-adjust the month/date display if necessary.



Automatic Time Synchronization

Whether the clock set itself automatically or whether you set the clock manually the WWVB receiver will automatically switch 'On' for 10 minutes at 1 AM, 2 AM, 3 AM, 4 AM, and 5 AM every day and listen for the WWVB signal. During this time between midnight and dawn the interference level is reduced and the WWVB signal can be received clearly even in the fringe reception areas. The clock will automatically resynchronize itself with the U.S. Atomic Clock time signal.

Note: If the radio is 'On' during this time period the WWVB receiver will not turn 'On'.

Seconds Counter

If you need to momentarily view the seconds display depress the TIME/SECONDS button. The month/date display changes to a seconds counter for as long as the button is depressed.

SETTING THE WAKE UP TIMES

Your Atomic Clock Radio has two separate wake up alarms that can be set and used independently. In addition the Alarm Mode selector allows you to set either or both alarms for Week Days only, Week Ends only, or Every Day operation.

The procedure for setting the wake up times is the same for both alarms.

- 1.) Depress the ALM 1 or ALM 2 button. The display will change from the current time to the Alarm 1 or Alarm 2 wake up time. The Day indicators will show which mode is selected: Week Days only; Week Ends only; or Every Day.
- 2.) Continue pressing the ALM 1 or ALM 2 buttons and press the "+" or "-" buttons to adjust the display to the desired wake up time. Be sure to set correctly for AM or PM.
- 3.) To change the Alarm Mode setting depress either the ALM 1 or ALM 2 buttons and press the ALARM MODE button repeatedly until the day indicators show the desired mode: Monday through Friday only; Saturday and Sunday only; or All 7 days.

After adjusting the wake up times you may recheck the settings at any time by simply pressing the ALM 1 or ALM 2 button. The display will change from current time to wake up time and the day indicators will show which alarm mode has been selected.



LISTENING TO THE RADIO

- 1.) Set the BAND selector to either the AM or FM position.
- 2.) Press the RADIO ON/OFF button to turn the radio 'On'. The LED dial pointer comes 'On'.
- 3.) Turn the TUNING control to tune to the desired station.
- 4.) Adjust the VOLUME control to the desired level.
- 5.) When you are finished listening press the RADIO ON/OFF button to turn the radio 'Off'. The LED dial pointer goes 'Off'.

Antenna Information

FM

The FM antenna is built in to the AC power cord. Be sure the power cord is completely unwound and extended to its full length for best FM reception.

AM

The AM ferrite bar antenna is located inside the radio cabinet. If AM reception is unsatisfactory you may have to change the position of the cabinet until the internal AM antenna picks up the strongest signal.



ALARM OPERATION

You may set either or both alarms to wake you to the radio or an electronic buzzer tone. The procedure for both alarms is the same.

- 1.) First depress either the ALM 1 or ALM 2 buttons and verify that the wake up times and the Alarm Mode settings are correct. Adjust if necessary. See "SETTING THE WAKE UP TIMES".
- 2.) Slide either the ALARM 1 or ALARM 2 selector switches from the 'OFF' position to the 'BUZZER' or 'RADIO' positions. The ALM 1 and/or ALM 2 indicators on the front panel will turn 'On' to confirm that the alarms are activated.
- 3.) If you selected 'wake to radio' turn the radio 'On', select the station that you wish to hear and adjust the volume control to the desired wake up level, then turn the radio 'Off' again.
- 4.) At the selected wake up time the unit will turn on and either the radio or the buzzer will wake you up. The buzzer will continue for 5 minutes and then shut off automatically and reset itself for the following day. The radio will play for one hour and then stop and reset itself for the following day. To stop the radio or buzzer sooner, press the ALM 1 or ALM 2 button. The alarm stops immediately and resets for the following day.
- 5.) To cancel the alarm completely slide the ALARM 1 or ALARM 2 selector back to the 'OFF' position. The ALM 1 and ALM 2 indicators turn 'Off'.

SNOOZE / REPEAT ALARM

After the alarm comes on you may press the SNOOZE/SLEEP OFF bar to stop the alarm temporarily. The alarm stops for approximately 9 minutes and then comes 'On' again.

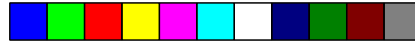

SLEEP TO MUSIC TIMER

This feature allows you to program the radio to play for as long as 90 minutes or as little as 2 minutes before shutting off automatically.

- 1.) Press the SLEEP button. The display will show “SL 10” and the radio will turn ‘On’. Select the station and adjust the volume as desired. After 10 minutes the radio will shut off automatically.
- 2.) To adjust the amount of time before the radio shuts ‘Off’, depress and hold the SLEEP button and press the “+” or “-” buttons to adjust the amount of time up to 90 minutes or down to 2 minutes. Release the buttons when the desired amount of time appears on the display. The radio will play for the amount of time you selected and then shut ‘Off’ automatically.

Notes:

- When you adjust the amount of sleep time from the initial default setting of 10 minutes, your new setting becomes the new default sleep time. For example, if you adjust the sleep time setting from 10 minutes to 60 minutes, each time you press the SLEEP button the display will show 60 minutes. This will continue as the default sleep time until you change the setting again.
- If you experience a power interruption and the back up batteries are exhausted the sleep timer setting will revert to the original 10 minute default setting when power is restored.
- Remember that the station and volume level you select for Sleep timer operation is the same station and volume level that you will hear when the radio turns on in the morning.

DISPLAY DIMMER CONTROL

To reduce the brightness of the display if desired, slide the DIMMER switch to the ‘LOW’ position.



CARE AND MAINTENANCE

If the cabinet becomes dusty, wipe it with a soft cloth. If the cabinet becomes smudged or dirty, clean it with a soft, slightly dampened cloth. Never allow water or any liquid to get inside the cabinet. Never use any abrasive cleaners or cleaning pads as these will damage the finish of your radio.



TO FIND THE LOCATION AND PHONE NUMBER OF YOUR NEAREST SERVICE CENTER PERMITTED TO PERFORM WARRANTY...

CALL TOLL FREE: 1-800-695-0098

FOR ADDITIONAL SET-UP OR OPERATING ASSISTANCE
PLEASE CALL:
1-800-898-9020

FOR CUSTOMER SERVICE, PLEASE WRITE TO:
Emerson Radio Corp.,
Consumer Affairs Dept.,
1901 Diplomat Drive,
Farmers Branch, TX 75234.

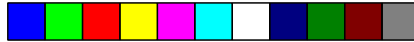

**EMERSON RADIO CORP.
LIMITED WARRANTY**

What does this warranty cover ? Any manufacturing defects in original material, including original parts and workmanship, under normal use and conditions.

For how long? For a period of ninety (90) days from the date of original purchase in the U.S.

What will we do ? If you need service under this Warranty, and you provide us with the dated proof of purchase, we will provide repair service at no charge for labor and parts at an authorized Depot Repair Facility, or replace the product in our discretion.

How do you make your warranty claim ? If it becomes necessary to repair your unit, you can obtain the name and mailing location of a Depot Repair Facility by dialing **1-800-695-0098**. You should pack your unit in a well-padded heavy corrugated box, enclose your check or money order payable to the Depot Repair Facility in the amount of **\$9.00** to cover the return shipping and handling costs, and enclose a copy of your proof of purchase (warranty service will not be provided without a dated proof of purchase). Finally, you should ship the unit prepaid via UPS or parcel post (insured).

What does your warranty not cover ? Your warranty does not cover the following :

- Damage from negligence, misuse, abuse, accident, or failure to follow operating instructions.
- Use of product in a commercial application or rentals.
- Changes or repairs by anyone other than an authorized Depot Repair Facility.
- Damage because your unit is improperly connected to the equipment of other manufacturers.
- Unit on which the serial number has been defaced, modified or removed.
- Damage to equipment not properly connected to the product.
- Cost incurred in shipping your unit to and from an authorized Depot Repair Facility.
- Ordinary adjustments which you can perform as outlined in the owner's manual.
- Signal reception problems caused by external antenna or cable systems.
- Products purchased, used, serviced, or damaged outside of the United States.
- Damage to compact discs or cassettes.

What other limitations apply to your warranty ?

THIS WARRANTY IS NON-TRANSFERABLE AND APPLIES ONLY TO THE ORIGINAL PURCHASER AND DOES NOT EXTEND TO SUBSEQUENT OWNERS OF THE PRODUCT. THIS WARRANTY IS VALID ONLY IN THE UNITED STATES OF AMERICA. ANY APPLICABLE IMPLIED WARRANTIES, INCLUDING THE WARRANTY OF MERCHANTABILITY, ARE LIMITED IN DURATION TO A PERIOD OF THE EXPRESSED WARRANTY AS PROVIDED ABOVE BEGINNING WITH THE DATE OF ORIGINAL PURCHASE AT RETAIL AND NO WARRANTIES, WHETHER EXPRESSED OR IMPLIED, SHALL APPLY TO THE PRODUCT THEREAFTER. WE MAKE NO WARRANTY AS TO THE FITNESS OF THE PRODUCT FOR ANY PARTICULAR PURPOSE OR USE.

THE EXTENT OF OUR LIABILITY UNDER THIS LIMITED WARRANTY IS THE REPAIR OR REPLACEMENT PROVIDED ABOVE AND IN NO EVENT WILL OUR LIABILITY EXCEED THE PURCHASE PRICE PAID BY THE PURCHASER OF THE PRODUCT. UNDER NO CIRCUMSTANCES WILL WE BE LIABLE FOR ANY LOSS, DIRECT, INDIRECT, INCIDENTAL, SPECIAL, OR CONSEQUENTIAL DAMAGE ARISING OUT OF OR IN CONNECTION WITH THE USE OF THIS PRODUCT.

How does state law apply to your warranty ?

THIS WARRANTY GIVES YOU SPECIFIC LEGAL RIGHTS, BUT YOU MAY ALSO HAVE OTHER RIGHTS WHICH VARY FROM STATE TO STATE. SOME STATES DO NOT ALLOW LIMITATIONS ON IMPLIED WARRANTIES OR EXCLUSION OR LIMITATION OF INCIDENTAL OR CONSEQUENTIAL DAMAGE, SO THESE RESTRICTIONS MAY NOT APPLY TO YOU.

AU898F



EMERSON
Part No.: 16-2867
205-01

Printed in China



Free Manuals Download Website

<http://myh66.com>

<http://usermanuals.us>

<http://www.somanuals.com>

<http://www.4manuals.cc>

<http://www.manual-lib.com>

<http://www.404manual.com>

<http://www.luxmanual.com>

<http://aubethermostatmanual.com>

Golf course search by state

<http://golfingnear.com>

Email search by domain

<http://emailbydomain.com>

Auto manuals search

<http://auto.somanuals.com>

TV manuals search

<http://tv.somanuals.com>