

13.50 mm

18.90 mm



Manufactured by: AIT Inc. Brooklyn NY. 11232
Emerson and the G-Clef logo are registered trademarks of Emerson Radio Corp.,
Parsippany, New Jersey USA.
© 2008 AIT Inc. All rights reserved.

Microsoft, the Windows logo, and Windows Media are either registered trademarks of Microsoft Corporation in the
United States and / or other countries.



MP3 Music Player User Guide



EMP312-1

27.00 mm

13.50 mm

Notice for USA

- "Warning: Changes or modifications to this unit not expressly approved by the party responsible for compliance could void the user's authority to operate the equipment."

- "NOTE: This equipment has been tested and found to comply with the limits for a class B digital device, pursuant to Part 15 of the FCC Rules. These limits are designed to provide reasonable protection against harmful interference in a residential installation. This equipment generates, uses, and can radiate radio frequency energy and, if not installed and used in accordance with the instructions, may cause harmful interference to radio communications.

However, there is no guarantee that interference will not occur in a particular installation. If this equipment does cause harmful interference to radio or television reception, which can be determined by turning the equipment off and on, the user is encouraged to try to correct the interference by one or more of the following measures:

- Relocate the receiving antenna.
- Increase the separation between the equipment and receiver.
- Connect the equipment into an outlet on a circuit different from that to which the receiver is connected.
- Consult the dealer or an experienced radio/TV technician for help."

Introduction

Congratulations on purchasing the Emerson MP3 Music Player.

Before using the player, read this manual thoroughly and keep it for future reference.

This manual contains important safety information and correct operation instructions. Read the manual carefully before you use the player in order to avoid any confusion.

Copyright Information

Trademarks and trade names used in this instruction manual are owned by their respective companies or organizations.

Unauthorized duplication of any recordings whether downloaded from the internet or made from audio CDs is a violation of copyright laws and international treaties.

The making of unauthorized copies of copy-protected material, may be an infringement of copyrights and constitute a criminal offence. This equipment should not be used for such purposes.

Important Safety Precautions

Always follow these basic safety precautions when using your player. This will reduce the risk of product damage and personal injury.

- Do not disassemble, repair or modify the player by yourself. Refer servicing to qualified personnel.
- Do not dispose of in fire.
- In the event that the battery is leaking, do not handle the device with your bare hands. Contact the service center for help since the liquid may remain in the player. If your body or clothes had contact with the battery liquid, wash it off thoroughly with water. Also, if some liquid gets into your eyes, do not rub your eyes but immediately wash them with clean water, and consult a doctor.
- Keep the player away from direct sunlight and any direct heat source.
- Do not expose the unit to rain or moisture.
- Do not use the player in dry environments to avoid static.
- Never apply heavy impact on the player, or place it on a magnet.
- Disconnect the player from the computer when you do not use the player for a long time.
- Clean only with a dry cloth. Make sure the player is turned off before cleaning. Do not use a liquid cleanser.
- Be sure to back up your files. We will not be liable for the loss of data due to improper operation, repair or other causes.

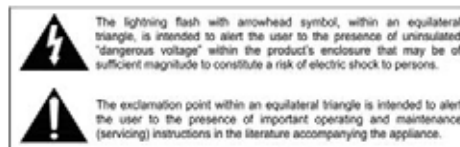
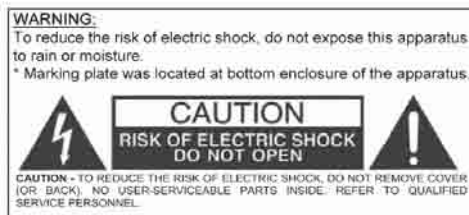

LIMITED WARRANTY

In the unlikely event that this product is defective, or does not perform properly, you may within ninety (90) days from your original date of purchase return it to the authorized service center for repair or exchange.

TO OBTAIN WARRANTY SERVICE:

- Provide proof of the date of purchase within the package (Dated bill of sale)
- Prepay all shipping costs to the authorized service center, and remember to insure your return.
- Include a return shipping address (no P.O. Boxes), a telephone contact number, and the defective unit within the package.
- Describe the defect or reason you are returning the product.

Your product will be repaired or replaced, at our option, for the same or similar model of equal value if examination by the service center determines this product is defective. Products received damaged, as a result of shipping will require you to file a claim with the carrier.

The shipping address of the authorized service center is:

Southern Telecom Inc.
ATTENTION: Returns Department
14-C 53rd Street
Brooklyn, NY 11232

Should you have any questions or problems concerning this product, please contact our customer service department at:

1-877-768-8483
Mon – Fri: 9AM – 5PM (EST)
or
via e-mail at cs@southern telecom.com

To obtain service after the warranty period, please e-mail: cs@southern telecom.com with product information, date of purchase and nature of the problem. Customer service will reply to the e-mail with service instructions.

Warranty service not provided:

This warranty does not cover damage resulting from accident, misuse, abuse, improper installation or operation, lack of reasonable care, and unauthorized modification. This warranty is voided in the event any unauthorized person opens, alters or repairs this product. All products being returned to the authorized service center for repair must be suitably packaged.

Limitation of Warranty:

• THE WARRANTY STATED ABOVE IS THE ONLY WARRANTY APPLICABLE TO THIS PRODUCT. ALL OTHER WARRANTIES, EXPRESS OR IMPLIED (INCLUDING ALL IMPLIED WARRANTIES OF MERCHANTABILITY OR FITNESS FOR A PARTICULAR PURPOSE) ARE HEREBY DISCLAIMED. NO VERBAL OR WRITTEN INFORMATION GIVEN BY SOUTHERN TELECOM INC. IT'S AGENTS, OR EMPLOYEES SHALL CREATE A WARRANTY OR IN ANY WAY INCREASE THE SCOPE OF THIS WARRANTY.

• REPAIR OR REPLACEMENT AS PROVIDED UNDER THIS WARRANTY IS THE EXCLUSIVE REMEDY OF THE CONSUMER, SOUTHERN TELECOM INC. SHALL NOT BE LIABLE FOR INCIDENTAL OR CONSEQUENTIAL DAMAGES RESULTING FROM THE USE OF THIS PRODUCT OR ARISING OUT OF ANY BREACH OF ANY EXPRESS OR IMPLIED WARRANTY ON THIS PRODUCT. THIS DISCLAIMER OF WARRANTIES AND LIMITED WARRANTY ARE GOVERNED BY THE LAWS OF THE STATE OF NEW YORK. EXCEPT TO THE EXTENT PROHIBITED BY APPLICABLE LAW, ANY IMPLIED WARRANTY OF MERCHANTABILITY OR FITNESS FOR A PARTICULAR PURPOSE ON THIS PRODUCT IS LIMITED TO THE APPLICABLE WARRANTY PERIOD SET FORTH ABOVE.

How state law relates to this warranty:

- Some states do not allow the exclusion nor limitation of incidental, consequential damages, or limitations on how long an implied warranty lasts so the above limitations or exclusion may not apply to you.
- This warranty gives you specific legal rights, and you also may have other rights that vary from state to state.

27.00 mm

18.90 mm

13.50 mm

To browse a folder, press [**MENU**]. Select a file and press [**MENU**] to enter the PLAY OR DELETE mode, press the [**◀◀**] or [**▶▶**] button to select play or delete, and press [**MENU**] to confirm. If you select play, it will play the current song. If you select delete, it will come into the delete mode. Press the [**◀◀**] or [**▶▶**] button to select YES OR NO. Press [**MENU**] button to confirm and press [**▶||**] to exit.

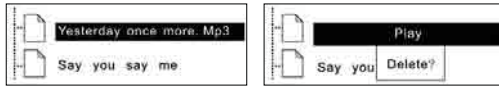

Hold function

The hold function can help you lock all buttons to avoid accidental player operation.

- To lock all buttons of the MP3 player, slide the [**HOLD**] switch in the direction of the arrow. All buttons are disabled.
- To deactivate the lock function, slide back the [**HOLD**] switch.



Troubleshooting

If you have problems while operating your player, please check the points below before sending it to the service center.

Can not power on

- Make sure the battery is properly installed, or replace the battery.

Files can not be downloaded

- Check if the driver is installed correctly in the computer.
- Check the connection between the player and PC.

No sound from the earphones

- Please ensure the volume is turned up, and the earphones are properly connected.
- Check if the format of music file is supported by the player.

Recording can not be done

- Check if there is enough memory and battery capacity.

Display is in the wrong language

- Please ensure you selected the correct language from the Settings menu.

The buttons do not work

- Check the [**HOLD**] switch, located on the side of the player. Make sure it is not in the lock position.
- Press the reset hole with a metal pin to re-initialize the system of the player.

Note: If you attempt to transfer music files, and you see the message "The disk is write-protected", you must check the [**HOLD**] button located on the left side of your player and make sure it is not in the Hold/Lock position.

13

Precautions in using the earphones

- Do not use the earphones while driving an automobile or riding a bicycle. It is dangerous, and against the law. To avoid an accident, do not turn up the volume of the earphones too high while walking.
- It is not recommended that you use the earphones at a high volume for an extended time, as this may cause hearing damage.

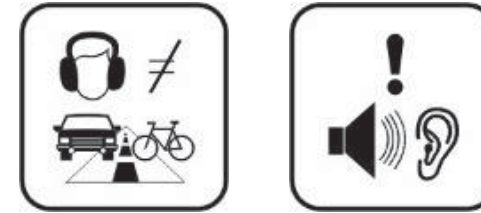

Location of Controls

1. **HOLD**
2. **MENU**
3. **REC/A-B**
4. Play/Pause/Stop [**▶||**]
5. Previous Track/Fast Backward [**◀◀**]
Next Track/Fast Forward [**▶▶**]
6. Volume up [**V+**]/down [**V-**]
7. Earphone Jack
8. Microphone

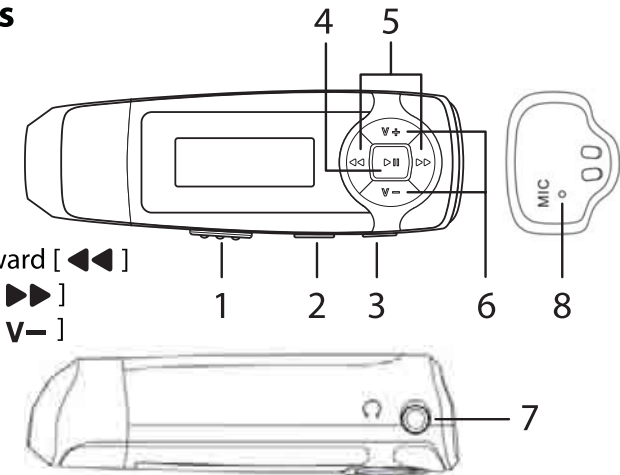

System requirements

Your computer system must meet the following specifications:

- Pentium 200MHz or above
- Microsoft Windows 98SE/2000/ME/XP/Vista
- 120MB of available hard disk space
- USB port supported
- CD-ROM drive

2

27.00 mm

18.90 mm

13.50 mm

Getting Started

1. Install the battery
2. Press and hold the [▶||] button to turn on the player. The display will light up and the player enters the MP3 Standby Mode.

Connecting to a Computer

1. Connect the player to the computer's USB port.
2. The computer system detects "New hardware" and starts to install the driver automatically. Wait for the system to finish the installation.



When it has finished, "Emerson MP3" will appear in "My Computer".

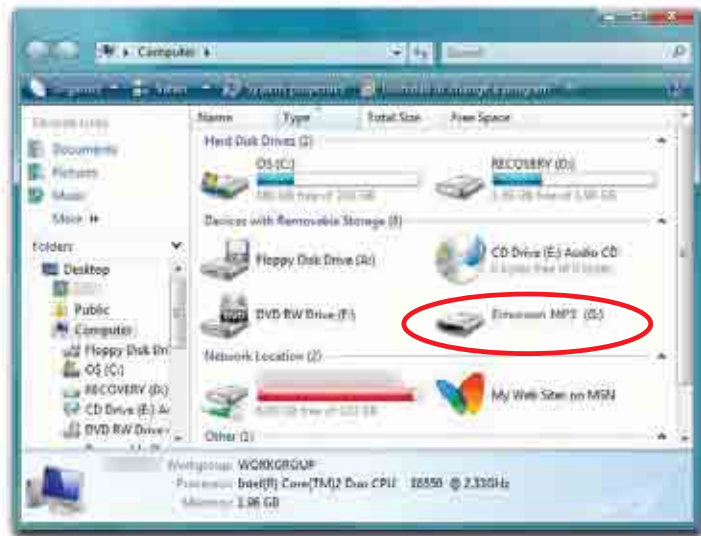

3

Setting Recording

Push [◀◀] or [▶▶] button to select the record set, including: 8000Hz, 11000Hz, 16000Hz, 22000Hz. Press the [MENU] button to save the select the recording setting.

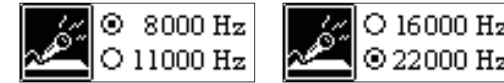

Setting language

Push [◀◀] or [▶▶] button to select a language: German, English, French, Spanish, Italian, Press the [MENU] button to save the selected language.



Exit

Return to the previous mode.

Music preview

From the MP3 mode or voice standby mode, press the [MENU] button to enter the main menu, and push the [◀◀] or [▶▶] button to select the music preview function setting, and press the [MENU] button to enter. During preview, 10 seconds of each music file will be played. You can press the [MENU] button to exit.

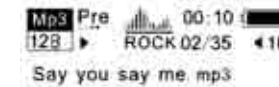

About

From the MP3 mode or voice standby mode, press the [MENU] button to enter the main menu, and push the [◀◀] or [▶▶] button to select the about function, and then press the [MENU] button to enter. You can view the total memory and available memory.



Folder function

From the mp3 or voice standby mode, press the [MENU] button to enter the main menu, and push the [◀◀] or [▶▶] button to select the folder function, and then press the [MENU] button to enter. Use the [◀◀] or [▶▶] to select the desired file or folder.



12

27.00 mm

18.90 mm

13.50 mm

Setting Play mode

Push the [◀◀] or [▶▶] button to select the playing mode, including: Normal, repeat one, repeat all and shuffle repeat. Press the [MENU] button to save the selected play mode.

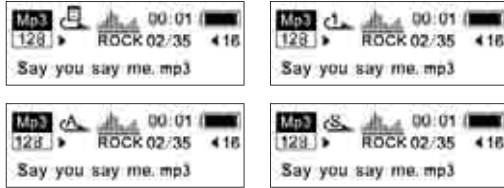

Setting Contrast

Push the [◀◀] or [▶▶] button to adjust the contrast of the LCD. Press [MENU] button to save the selected setting.



Adjusting Backlight

Push the [◀◀] or [▶▶] button to select the backlight setting, including: Always off, 5sec, 10sec, always on. Press [MENU] button to save the selected setting.

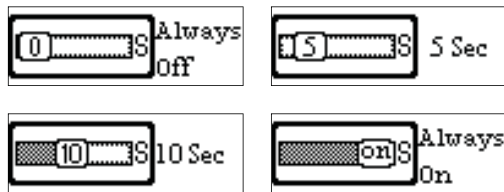

Setting Power set

Push [◀◀] or [▶▶] button to select the Power set, including: Disable, 2min, 10min, 30min. Press the [MENU] button to save the selected shutdown time.

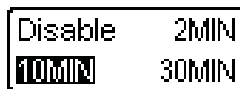

11

Downloading Files to the Player

1. Open the Windows Explorer on My Computer, and "Emerson MP3" is displayed.
2. Select the files on your computer and simply move it into "Emerson MP3" in the usual way (drag and drop, or copy and paste). After copying is completed, the data will be available on the player.



Note: Please do not disconnect the USB cable during loading. It may cause a malfunction of the player and the files.

If this window appears when transferring files, check that the "HOLD" button is not on the Hold/Lock position.



4

27.00 mm

18.90 mm

13.50 mm

Disconnecting the USB cable

After completing the file transfer, please disconnect the USB cable the following way:

1. Double click the green arrow "Safely Remove Hardware" in the taskbar on the bottom right of the window.
2. Select "USB Device" and click "Stop".
3. When the "Stop a Hardware device" appears, click "OK" to disconnect the USB mass storage device. Then you can unplug the player safely.

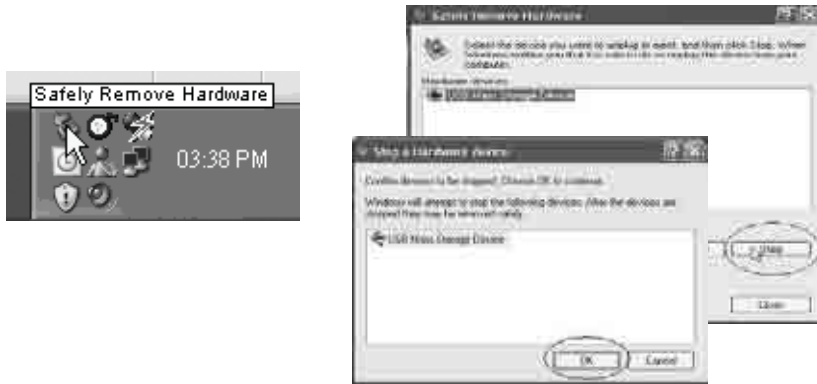

Windows Media Player

To organize and play your music, rip CD tracks to your hard drive, and transfer music to your player, we recommend using **Windows Media Player**. If Windows Media Player is not installed on your computer, you may download the latest version (Windows Media Player 11) of the player from:

www.microsoft.com/windows/windowsmedia/player/download/

If you are unsure of which version of Windows Media Player is compatible with your operating system, you may use the link below for more information regarding previous versions of the Windows Media Player.

www.microsoft.com/windows/windowsmedia/player/versions.aspx

5

Play

pause



- 2) From voice standby or play mode, you can press the [◀◀] or [▶▶] button to select previous or next track.
- 3) Press the [MENU] button to return to the Main Menu.

Recording

- 1) From the MP3 mode or voice standby mode, press and hold the [REC/A-B] button for 2 seconds, the player will enter the recording mode, press the [REC/A-B] button again to stop, and enter the playback mode.
- 2) Press [▶▶] to playback the recording.

Recording

Stop recording

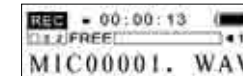

Settings

Press the [MENU] button to enter the main menu, and push the [◀◀] or [▶▶] button to select "setting" and press the [MENU] button to enter. Setting options include: Equalizer, play mode, contrast, backlight, power set, record set, language and exit. Press the [MENU] button to enter a settings option and to save the selected setting mode.

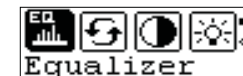

Setting equalizer mode

Push the [◀◀] or [▶▶] button to select the equalizer option: Normal, pop, rock, classical, jazz and bass. Press [MENU] button to save the selected equalizer option.



10

27.00 mm

18.90 mm

Skipping tracks

- Press the [◀◀] button to skip to the previous track.
- Press the [▶▶] button to skip to the next track.

Searching backward or forward within a track

- Press and hold the [◀◀] button to search backward within a track.
- Press and hold the [▶▶] button to search forward within a track.
- Once you release the pressed button, the file will be played back from the searched point.

A-B function

A desired section of a track can be played back repeatedly by using the A-B function.

- While a track is playing, press the [REC/A-B] button to set the beginning point of the section. The icon [A+] is displayed.
- Press the [REC/A-B] button again to set the ending point of the section. The icon [A+B] is displayed and the selected section starts playing back repeatedly.
- To cancel the A-B repeat playback and return to normal playback, press the [REC/A-B] button again.

Note: The A-B repeat function can only be used within the same track.

Main menu setup

From standby or playing mode, you can press the [MENU] button to enter the main menu function setting mode.

Push the [◀◀] or [▶▶] button to select: Play music, Voice mode, Setting, Preview, About, Folder and Exit; you can press the [MENU] button to enter the desired setting.



Setting the voice mode

Playing voice

- 1) From MP3 mode or voice standby mode, you can press the [MENU] button to enter the main menu. To enter the playing voice mode, please push the [◀◀] or [▶▶] button to select Voice, and press the [MENU] button. You can press the [▶||] button to play, and press this button again to pause.

Getting Music on your computer

- 1) Open Windows Media Player.
- 2) Click on the "Rip" tab.

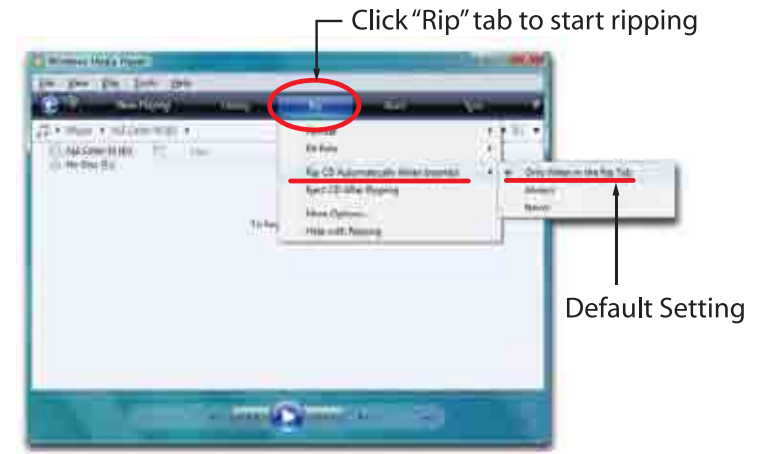

- 3) Insert a music CD into the CD-ROM drive of your computer.
- 4) Click the checkboxes to select which tracks to rip. If you would like to rip the entire album, click the checkbox next to "Album"
- 5) Click "Start Rip"

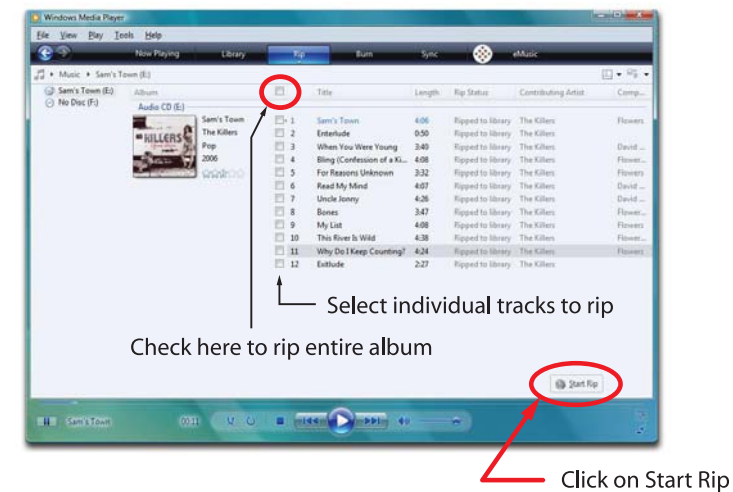

Getting music on your mp3 player

- 1) Open Windows Media Player.
- 2) Connect your mp3 player to the USB port of the computer.

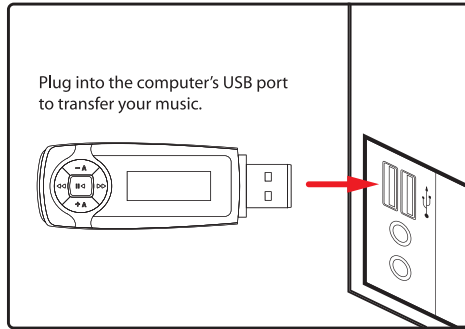

Device Setup Window

- 3) Click on the "Sync" tab.
- 4) To easily identify your player within Windows Media Player, name it in the "Device Setup" screen.

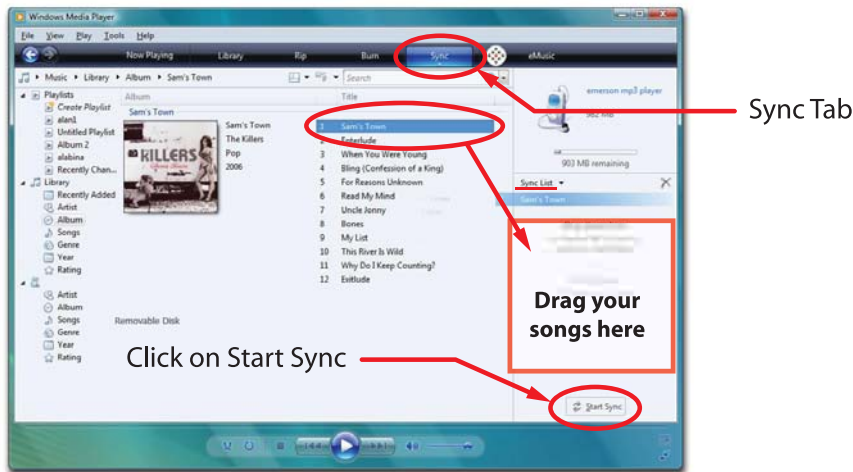

- 5) Drag the songs you would like to sync to your mp3 player, and click on the "Start Sync" button.
- 6) The selected songs will sync to your mp3 player.

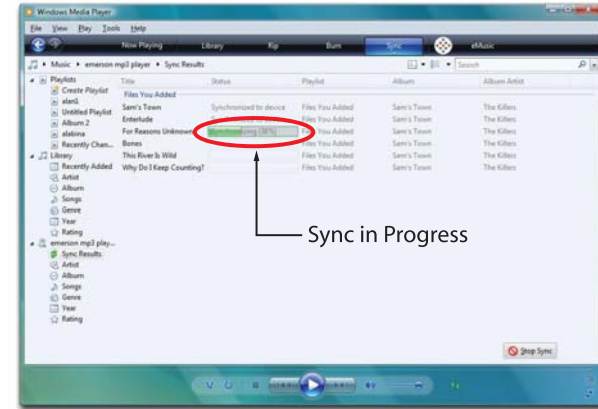

Basic Operation

Turning on/off

- To turn on the player, press and hold the [►||] button.
- To turn off the player, press and hold the [►||] button until the display closes.

Adjusting the volume

Press the [V+] button to increase the volume. Press the [V-] button to decrease the volume.

Selecting main menu or mode

To access the Main Menu, press the [MENU] button. Use the [◀◀] or [▶▶] button to select an item and press the [MENU] button to confirm your selection.

Listening to Music

Turning on and playing

1. Make sure that the battery is installed, and that your earphones are properly connected.
2. Press and hold the [►||] button to turn on the player.
3. Press the [MENU] button to enter the Main Menu and use [◀◀] or [▶▶] to select "Play Music" and press the [MENU] button to enter the music mode.
4. Press the [►||] button to start playing the music.
5. To turn off the player press and hold the [►||] button.

Pausing playback

While a song is playing, press the [►||] button to pause the playback. To resume the playback, press the [►||] button once again.

Free Manuals Download Website

<http://myh66.com>

<http://usermanuals.us>

<http://www.somanuals.com>

<http://www.4manuals.cc>

<http://www.manual-lib.com>

<http://www.404manual.com>

<http://www.luxmanual.com>

<http://aubethermostatmanual.com>

Golf course search by state

<http://golfingnear.com>

Email search by domain

<http://emailbydomain.com>

Auto manuals search

<http://auto.somanuals.com>

TV manuals search

<http://tv.somanuals.com>