

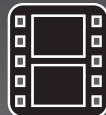

Music



Video



Pictures

MP3
Music & Video Player



2 GB

User Guide

EMP516-2

IN THE BOX

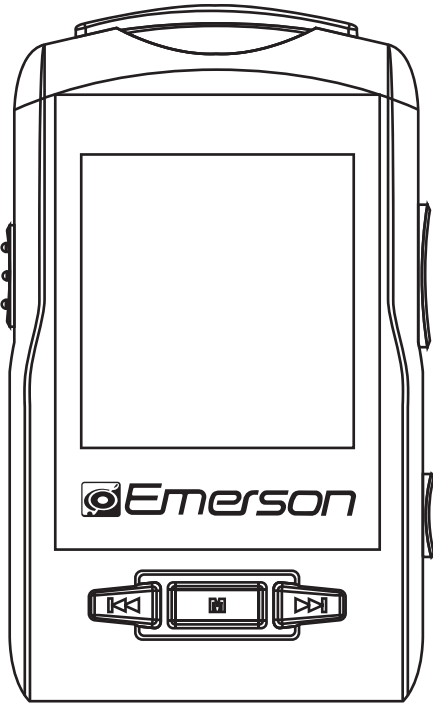

MP3 Music & Video Player

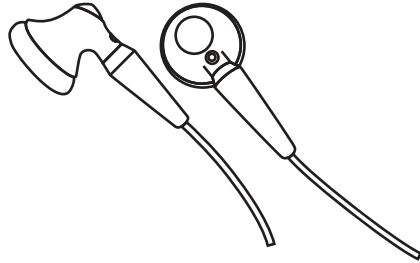

Stereo headphones



Portable speaker

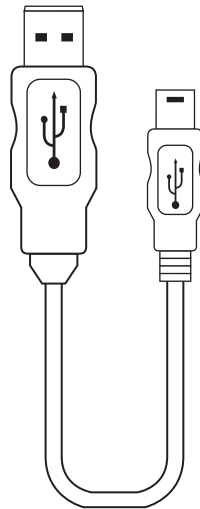

USB 2.0 Cable
(for battery charging
and high speed data transfer)



Installation CD

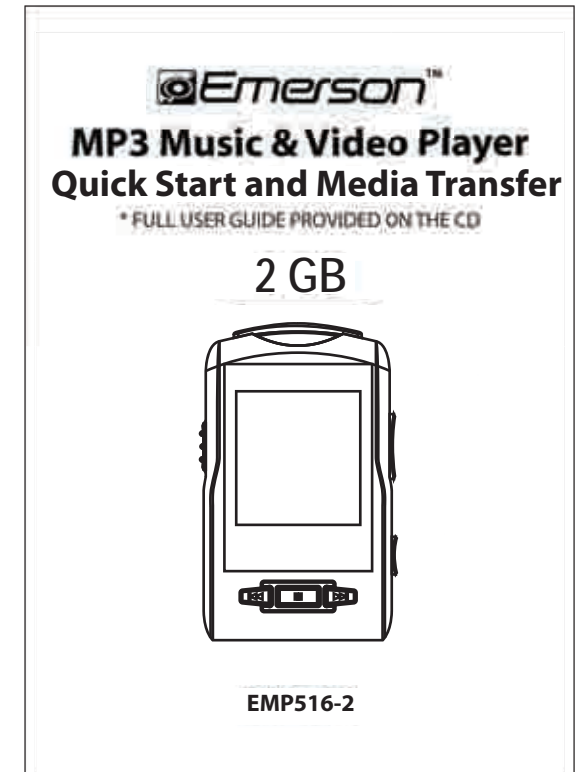

Quick Start Guide

 **FCC INFORMATION**

FCC Part 15

This device complies with Part 15 of the FCC Rules. Operation is subject to the following two conditions: (1) this device may not cause harmful interference, and (2) this device must accept any interference received, including interference that may cause undesired operation.

Warning: *Changes or modifications to this unit not expressly approved by the party responsible for compliance could void the user's authority to operate the equipment.*

NOTE: *This equipment has been tested and found to comply with the limits for a Class B digital device, pursuant to Part 15 of the FCC Rules. These limits are designed to provide reasonable protection against harmful interference in a residential installation. This equipment generates, uses and can radiate radio frequency energy and, if not installed and used in accordance with the instructions, may cause harmful interference to radio communications.*

However, there is no guarantee that interference will not occur in a particular installation. If this equipment does cause harmful interference to radio or television reception, which can be determined by turning the equipment off and on, the user is encouraged to try to correct the interference by one or more of the following measures:

- Reorient or relocate the receiving antenna.
- Increase the separation between the equipment and receiver.
- Connect the equipment into an outlet on a circuit different from that to which the receiver is connected.
- Consult the dealer or an experienced radio/TV technician for help.

Southern Telecom, Inc.
14-C 53rd Street
Brooklyn, NY 11232
Tel.: 718-567-7778

MP3 Music & Video Player
EMP516-2

 **INTRODUCTION**

Congratulations on purchasing the Emerson MP3 Music & Video Player.

This manual contains important safety information and correct operation instructions.

Before using the player, read this manual thoroughly and keep it for future reference.

Copyright Information

Trademarks and trade names used in this instruction manual are owned by their respective companies or organizations.

Unauthorized duplication of any recordings whether downloaded from the internet or made from audio CDs is a violation of copyright laws and international treaties.

The making of unauthorized copies of copy-protected material, may be an infringement of copyrights and constitute a criminal offence. This equipment should not be used for such purposes.

IMPORTANT SAFETY PRECAUTIONS

Always follow these basic safety precautions when using your player. This will reduce the risk of product damage and personal injury.

- Do not disassemble, repair or modify the player by yourself. Refer servicing to qualified personnel.
- The use of a Non-Recommended accessory may cause fire, electric shock, or injury. For approved accessories please contact customer support.
- This device contains a built-in battery, do not dispose of in fire.
- In the event that the battery is leaking, do not handle the device with your bare hands. Contact the service center for help since the liquid may remain in the player. If your body or clothes had contact with the battery liquid, wash it off thoroughly with water. Also, if some liquid gets into your eyes, do not rub your eyes but immediately wash them with clean water, and consult a doctor.
- Keep the player away from direct sunlight and any direct heat source.
- Do not expose the unit to rain or moisture.
- Do not use the player in dry environments to avoid static.
- Never apply heavy impact on the player, or place it on a magnet.
- Route the USB cable so that people and pets are not likely to trip over it.
- Disconnect the USB cable from the computer when you do not use the player for a long time.
- Clean only with a dry cloth. Make sure the player is turned off before cleaning. Do not use a liquid cleanser.
- Be sure to back up your files to avoid data loss.

Precautions in using the headphones

- Do not use the headphones while driving an automobile or riding a bicycle. It is dangerous, and against the law. To avoid an accident, do not turn up the volume of the headphones too high while walking.
- It is not recommended that you use the headphones at a high volume for an extended time, as this may cause hearing damage.

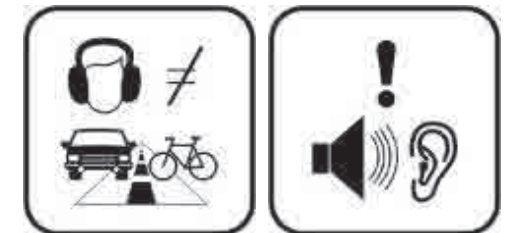
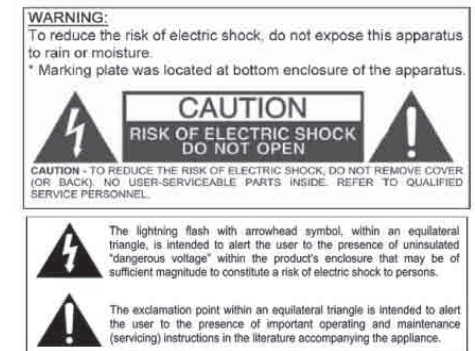

 **FEATURES**

- Vivid color display
- 2 GB internal memory
- Two headphone jacks (to share your music)
- USB 2.0 high speed connection
- Stores and plays music, video, and pictures
- Text reading (txt format)
- Digital voice recording (built-in microphone)
- Folder navigation
- Rechargeable battery
- Supports MP3 / WMA music formats
- Includes video converter software
- JPEG format picture browsing
- Includes external speaker

LOCATIONS OF CONTROLS

1. Neck strap hole
2. Headphone jacks (two)
3. [POWER] switch
4. [PREVIOUS] - Previous track / Fast backwards
5. [MENU] - Back to the previous menu
6. USB 2.0 Hi-Speed connector for battery charging and data transfer
7. [NEXT] - Next track / Fast forward
8. [PLAY] - Select / Start or stop play / On-Off button
9. [DOWN] - Volume - / Menu / Option
10. [UP] - Volume + / Menu / Option / A-B Loop

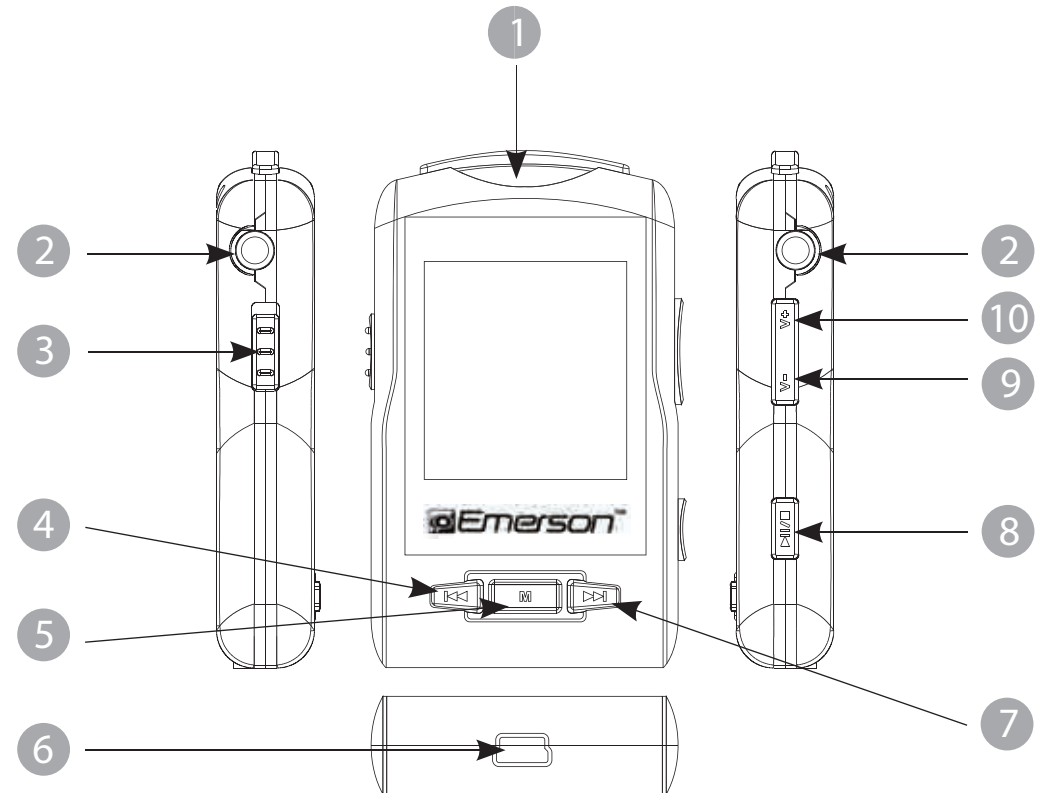

CONNECTING TO A COMPUTER

System requirements

Your computer system must meet the following specifications:

- Pentium 200MHz or above
- Microsoft Windows 2000/ME/XP/Vista
- USB port supported



PC

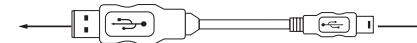

USB High Speed Connection Cable

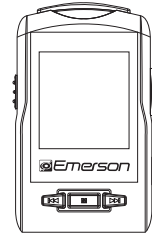

MP3 Player

PC connection

In order to enjoy the multimedia capabilities of your **MP3 Player**, you have to first copy your favorite files from your PC to its internal memory. Connect your **MP3 Player** to the computer using the included USB 2.0 cable. The device will be detected automatically without installing any driver. Once detected, you can read/write to the device's memory just as if you were using a regular disk drive.

Make sure your computer is powered on, and follow the steps below to connect the player to your computer.

1. Plug the larger USB connector of the USB cable into the USB port on the computer.
2. Plug the other end (small) of the USB cable to the player.
3. The computer system detects "New hardware" and starts to install the driver automatically. Wait for the system to finish the installation.

When it has finished, "**Emerson MP3**" will be created in "**My Computer**".

Important: To avoid any data loss, always perform a safe USB device extraction before disconnecting the USB cable from the PC. In Windows XP, for example, you can find the safe extraction icon in the task bar next to the system clock.

Disconnecting the USB cable

After completing the file transfer, please disconnect the USB cable the following way:

1. Double click the green arrow **"Safely Remove Hardware"** in the task bar on the bottom right of the window.
2. Select **"USB Device"** and click **"Stop"**.
3. When the **"Stop a Hardware device"** appears, click **"OK"** to disconnect the USB mass storage device, and unplug the player safely.

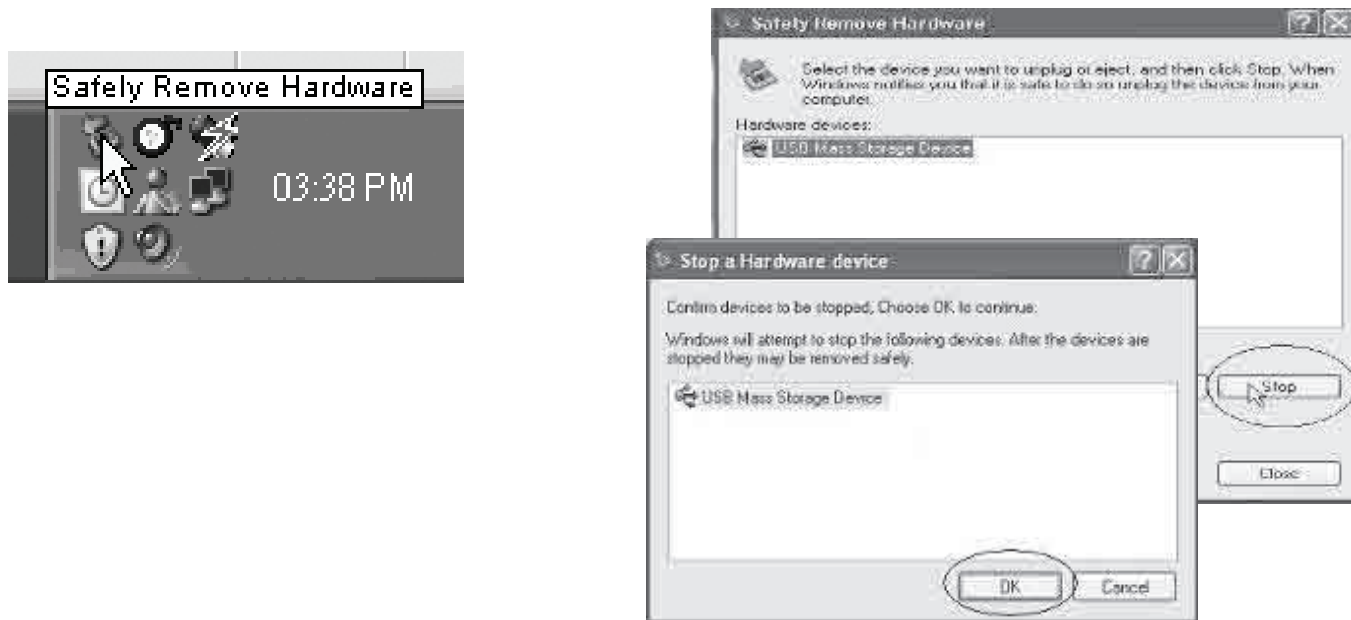

CHARGING THE BATTERY

Your MP3 Player has an integrated rechargeable Li-ion battery. It is recommended to fully charge the player before using it for the first time.

Recharge the battery by connecting the player to a computer using the included USB 2.0 cable.

Charging time is between 3-5 hours, depending if the player is powered off or working. To keep the battery in good condition, we recommend not charging it for more than 8 hours.

Important:

- Fully charge the player before you use it for the first time, or when you haven't used it for a long time.
- Charge the player immediately when the "Low battery" message is displayed.
- Do not over charge or discharge the player. Over charging or discharging will shorten the battery life.
- The battery could be over discharged if the player is not used for a long time (over three months). To avoid over discharge, fully charge the player every three months and always keep the voltage of the battery above 50 %.

Connecting the speaker

Use the provided stereo speaker to enjoy your music without headphones. Insert the speaker into one of the headphone jacks. Your music, videos, and recordings will be played through the speaker.

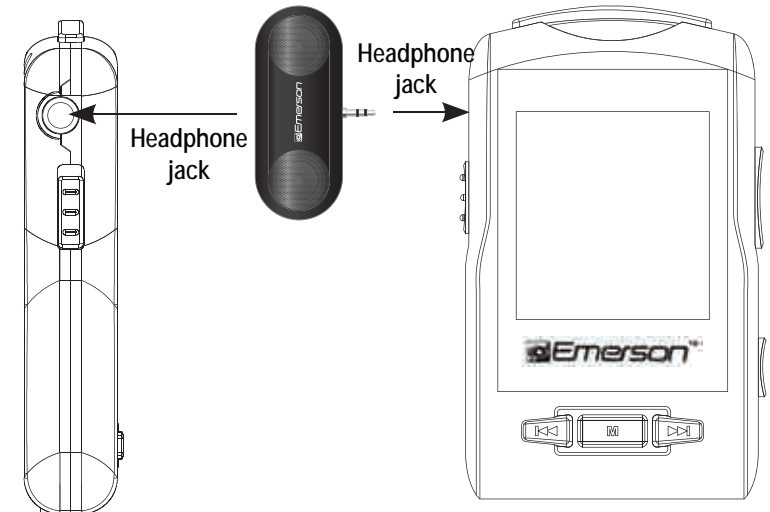

BASIC OPERATION

Turning on/off

- To turn on the player place the [POWER] switch in the “ON” position, and press and hold the [PLAY] button for 3 seconds until the LCD screen lights up.
- To turn the player off, press and hold the [PLAY] button until the LCD screen shuts off, or place the [POWER] switch in the “OFF” position.

NOTE: If you power off the device directly with the [POWER] switch, your last changes in the settings will be lost, and the player will not remember the last song played.

Adjusting the volume

Press and HOLD the [DOWN] button to decrease the volume, or the [UP] button to increase the volume.

Selecting main menu or mode

To access the Main Menu, press and hold the [MENU] button. Use the [UP] or [DOWN] buttons to select an item and press the [PLAY] button to confirm your selection.

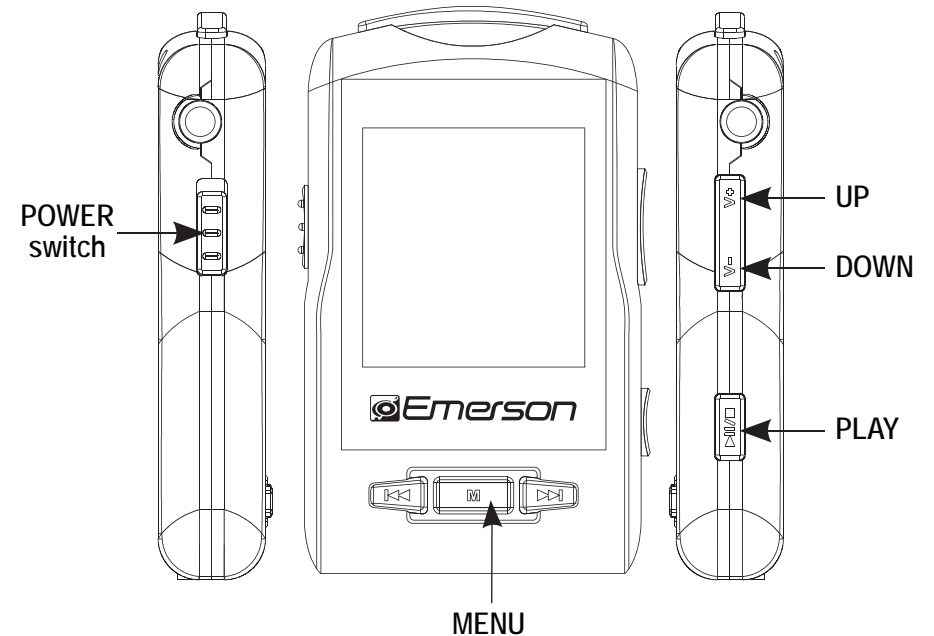

TRANSFERRING MEDIA FILES TO THE PLAYER

The MP3 Player is capable of storing, displaying, and playing your favorite music, pictures, and video.

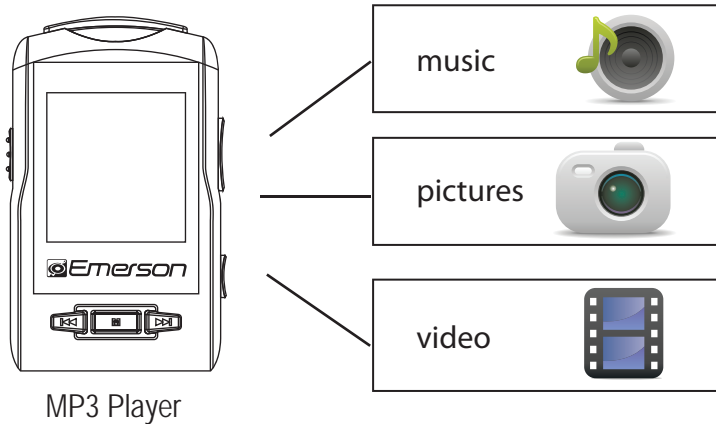

Transferring media to the player

To transfer media from your computer, perform the following steps:

1. Connect the MP3 player to the USB port of your computer.
2. Open "Windows Explorer" or "My Computer", and locate "Emerson MP3".
3. Select the files on your computer, and simply move it into "Emerson MP3" in the usual way (drag-and-drop, copy-and-paste). After copying is completed, the data will be available on the MP3 player.

We recommend using *Windows Media Player* to organize and transfer music, pictures, and videos to your player. For more information regarding *Windows Media Player*, please refer to the *Quick Start and Media Transfer Guide*, or the included CD.

Note: Please do not disconnect the USB cable during loading, it may cause malfunction of the player and the files.

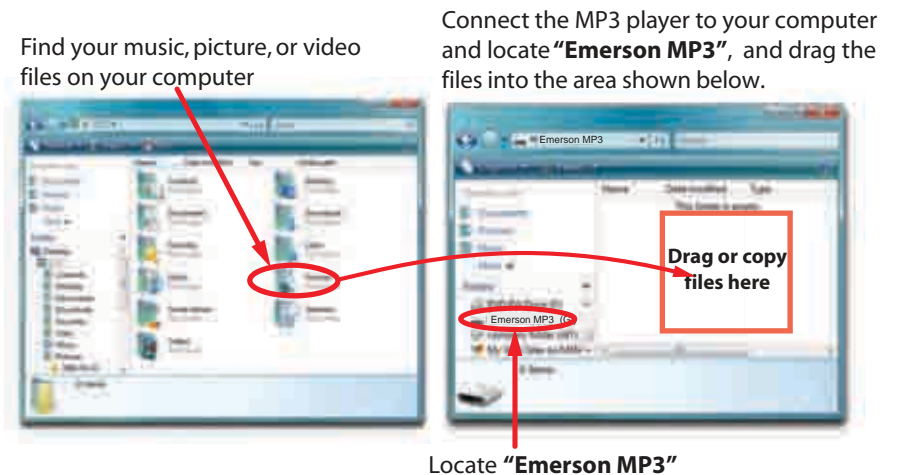

MUSIC

Store and playback your favorite songs and organize them by playlists, artist, and other options. See “**TRANSFERRING MEDIA FILES TO THE PLAYER**” (page 11) and follow the steps below to playback and organize your music.

1. Select “**MUSIC**” from the main menu, and press the [**PLAY**] button.
2. Use the [**UP**] or [**DOWN**] button to choose an option, and press the [**PLAY**] button to enter.
3. Use the [**UP**] or [**DOWN**] button to select, and press the [**PLAY**] button to confirm.

Listening to music

1. Select “**MUSIC**” from the main menu, and press the [**PLAY**] button.
2. Use the [**UP**] or [**DOWN**] button from the music file list to select the music file you wish to listen to, and press the [**PLAY**] button to begin playback.
3. While a song is playing, press the [**PLAY**] button to pause the playback. To resume playback, press the [**PLAY**] button once again. Press the [**MENU**] button to return to the music file list.
4. To return to the main menu, press and **HOLD** the [**MENU**] button.

Adjusting the volume

- To increase the volume press and **HOLD** the [**UP**] button.
- To decrease the volume press and **HOLD** the [**DOWN**] button.

NOTE: You must press and **HOLD** the [**UP**] or [**DOWN**] button to increase or decrease the volume.

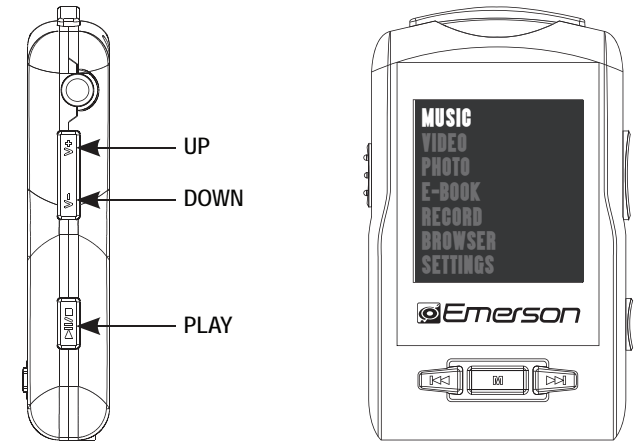

Skipping tracks

- Briefly press the [PREVIOUS] button to go to the previous track.
- Briefly press the [NEXT] button to go to the next track.

Searching backward or forward within a track

- Press and HOLD the [PREVIOUS] button to search backward within a track.
- Press and HOLD the [NEXT] button to search forward within a track.

A-B repeat function

You can loop play a segment of a song with this function.

1. Press the [UP] button to set the A point and press the [UP] button again to set the B point.
2. To cancel this function, press the [UP] button again.

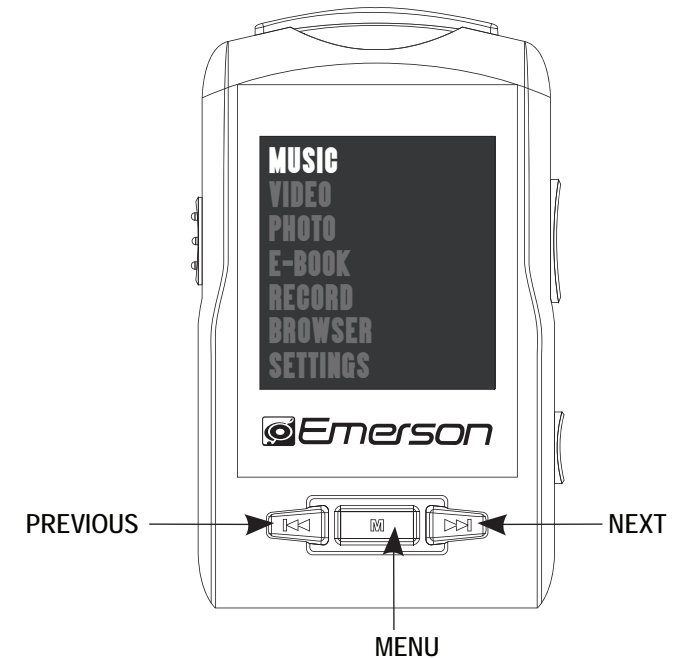
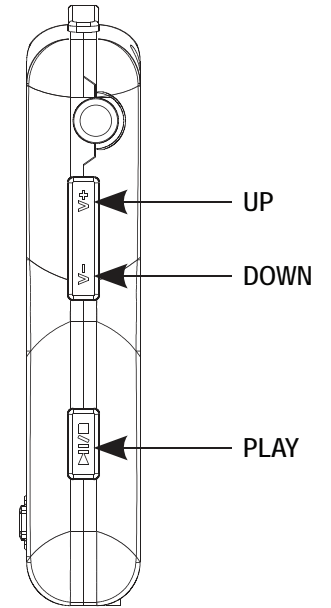

Music player settings

You can choose the equalization mode that fits your preferences. To do so, browse to **“SETTINGS”** → **“MUSIC”** → **“EQ select”** and choose one of the 6 available modes: **“Normal”**, **“MS PlayFX”**, **“Rock”**, **“Pop”**, and **“Classic”** or **“Jazz”**.

The playing order of the tracks depends on the selected mode. By default, the mode is set to **“Normal”**. You can change to a different mode browsing to **“SETTINGS”** → **“MUSIC”** → **“ Play Mode”**, and choosing **“Order”** (sequential order) or **“Shuffle”** (random).

You can also set the repeat mode by browsing to **“SETTINGS”** → **“MUSIC”** → **“Repeat Mode”** and selecting your preferred mode:

“Once” - Plays the current file and stops.

“Repeat 1” - Repeat current track.

“Folder Once” - Plays files inside the current folder and stops.

“Folder Repeat” - Repeats the files inside the current folder.

“All Once” - Plays all the files once.

“All Repeat” - Plays all the files continuously.

“Intro” - Plays the first 10 seconds and skips to the next file.

VIDEO

You can play AVI / WMV / MPG / VOB / ASF videos that you previously converted to the AVI format (XVID with MP2 audio and 128 x 128 resolution), using the easy software tool included inside the bundled CD.

NOTE: You must convert a video to the correct format before transferring to the player.

Playing videos

To play videos, select the “**VIDEO**” option from the main menu. You will access the files explorer (check the “**Browser: folder navigation**” section). Choose the video that you want with the [UP] or [DOWN] button and press the [PLAY] button to start playing it.

- Press the [PLAY] button to pause or resume the playback.
- Press the [PREVIOUS] or [NEXT] button to skip to the previous/next video.
- Press and **HOLD** the [PREVIOUS] or [NEXT] button to fast forward or rewind.
- To return to the video file list, press the [MENU] button.
- To return to the main menu, press and **HOLD** the [MENU] button.

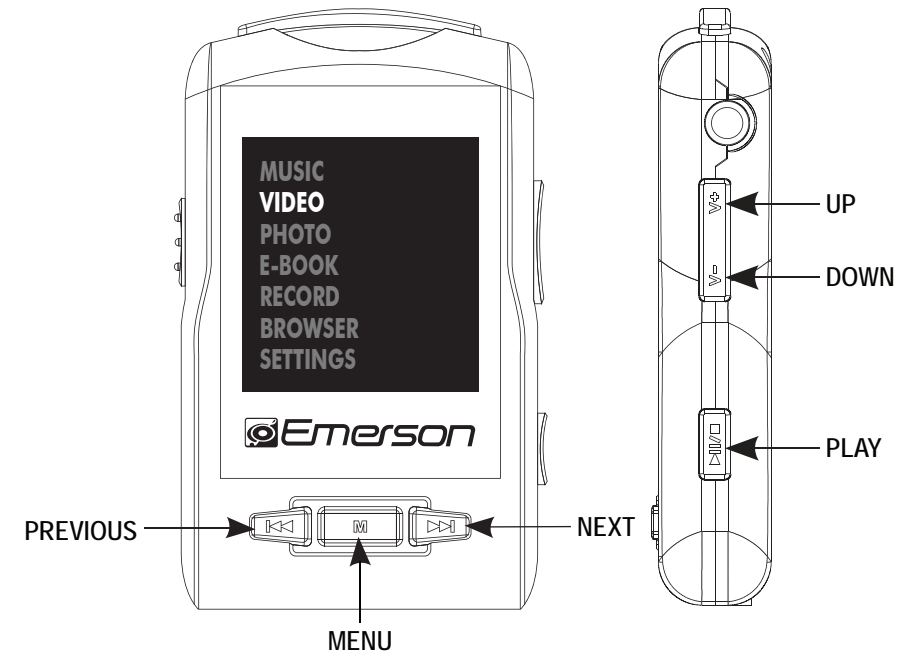

CREATING AVI VIDEOS

Before transferring video files to the **MP3 Player**, you must convert them to the correct format.

With the AVI Converter software tool you can easily convert your AVI / WMV / MPG / VOB / ASF videos to the AVI format (XVID with MP2 audio and 128 x 128 resolution) so you can enjoy them on your **MP3 Player**.

To install the AVI converter on your computer follow the steps below:

1. Insert the provided CD to the CD-ROM drive of your computer, and click on **"Video Converter"**.
2. Click **"Install"** and then **"Next"**.
3. Follow installation instructions to download the converter to your computer.



Click on **"Video Converter"**



Click **"Install"**



Click **"Next"**

4. Click **"Install"** when you see the screen below, and then click **"Finish"**.

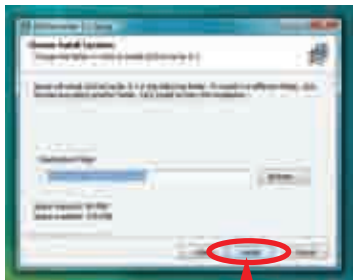

Click **"Install"**



Click **"Finish"**

5. Click the  icon on your **"Desktop"** to open the Video Converter.

AVIConverter

Converting videos

1. Connect the **MP3 Player** to the USB port of your computer (optional).
2. Click on **"AVI Converter"** from the **"Start "** menu, or the icon on your desktop.
3. Click on the **"Add"** button and select 128 x 128 resolution.

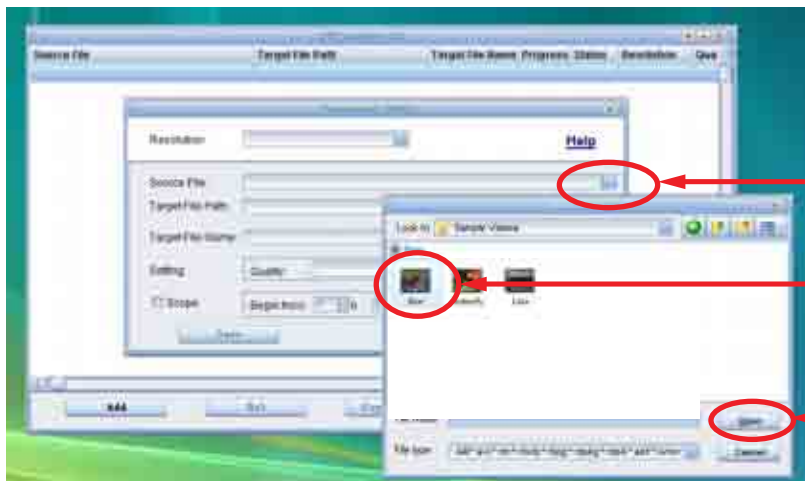
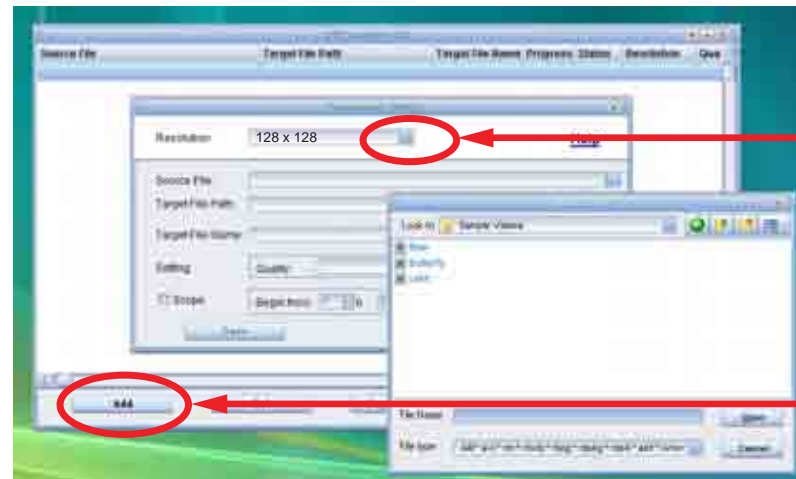

4. Select the video file that you want to convert by clicking on the **"Source File"** drop down window.

Converting videos

5. Click on the “**Target File Path**” drop down window to select the destination for the converted video. You can send it directly to your player by selecting “**Emerson MP3**”, and clicking “**OK**”, or if you would like to save the video to your computer, we recommend sending it to your “**Desktop**” where you can easily find the video, and transfer it to your player. (See “**TRANSFERRING MEDIA TO THE PLAYER**” on page 11)

NOTE: To send a converted video directly to your player, it must be connected to the computer's USB port at time of conversion.

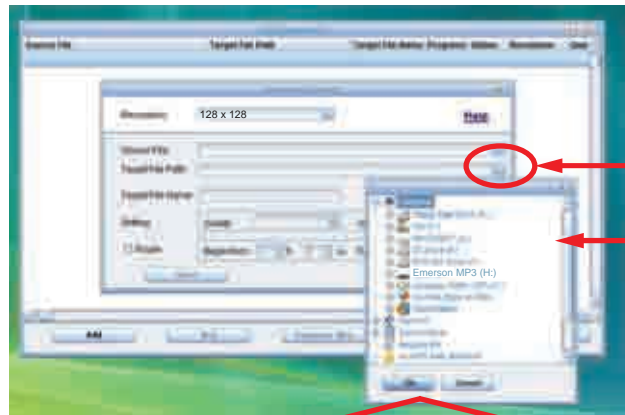

Click on the “**Target File Path**” drop down window

Select where you would like to send the converted video

Choose “**Desktop**” and save the converted video to the “**Desktop**” on your computer. After saving the converted video to your desktop, you can transfer it directly to your player (see “**TRANSFERRING MEDIA TO THE PLAYER**” on page 11).

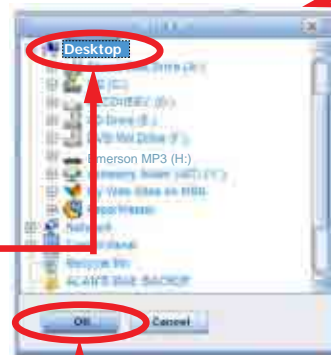

Click “**OK**”

OR

Choose “**Emerson MP3**” and save the converted video directly to your MP3 Player.

Note: Your MP3 Player must be connected to the USB port of your computer during the conversion for this option.



Click “**OK**”

Converting Videos

6. Write the name of the new AVI video file to be created ("**Target File Name**").
7. Choose the image quality of the new video. High quality will use more memory and the output file will be bigger.
8. Select the format of the output video ("**Aspect Ratio**"). Choose "Full" if you want the output video to include the whole original image. Black bands will be added if necessary. "4:3" will fill the whole screen, but some part of the image may be removed from the video. "16:9" for panoramic option.
9. The "**Scope**" section allows you to determine the start and end of the input video. By default, the input video will be converted from start to end.
10. Click "**Save**" to add the video recording to the list of pending jobs.
Note: You can add as many conversion jobs as you like in order to convert several videos automatically. When you are done adding jobs, press the "Close" button.
11. Click "**Convert Now**" to start the job queue. If more than one job is present they will be performed sequentially.
12. Once finished, press "**Close**" to exit the application.
13. Copy the new AVI file(s) to your player. See "**TRANSFERRING MEDIA TO THE PLAYER**" (page 11).

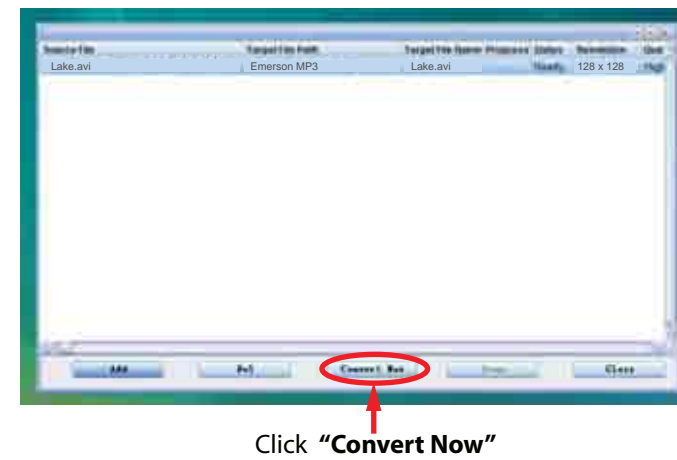
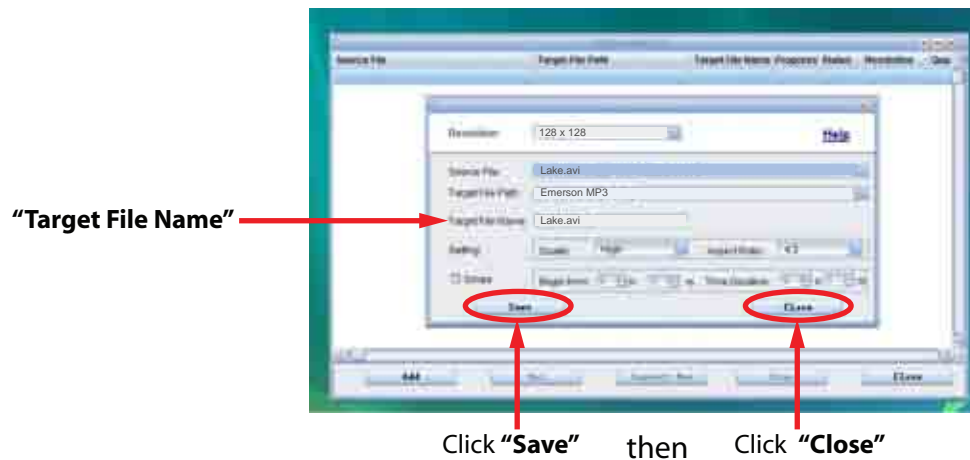

PHOTO

Viewing pictures

The MP3 Player is capable of storing and displaying your favorite pictures.

See “TRANSFERRING MEDIA FILES TO THE PLAYER” (page 11) and follow the steps below:

1. Select “PHOTO” from the main menu, and press the [PLAY] button..
2. Select the photo file you wish to view, and press the [PLAY] button.
3. Use the [PREVIOUS] or [NEXT] button to skip to the previous or next picture.
4. Press the [PLAY] button to enable or the disable the slideshow (timing can be set from the “SETTINGS” → “Auto Browse” → “Photo Browse” menu).
6. To return to the main menu, press the and HOLD the [MENU] button.

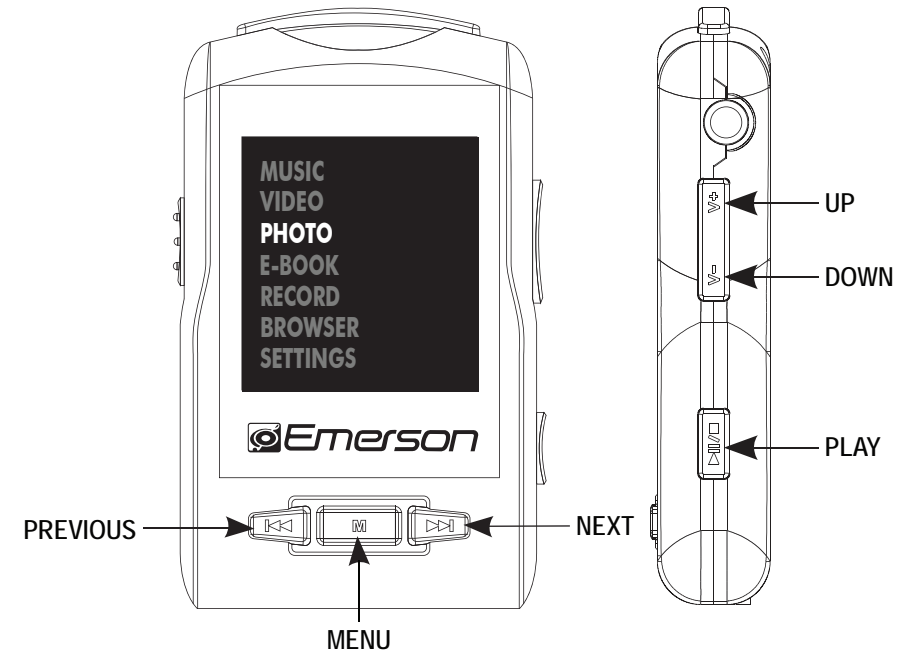

E-BOOK

View and enjoy your electronic books (e-book in TXT format) anywhere with the high resolution LCD screen of your **MP3 Player**.

Viewing TXT files

1. Select “E-BOOK” from the main menu, and press the [PLAY] button.
2. Select the file you wish to view, and press the [PLAY] button to open it.
3. Use the [UP] or [DOWN] button to skip to the next/previous page.
4. To return to the main menu, press and **HOLD** the [MENU] button.

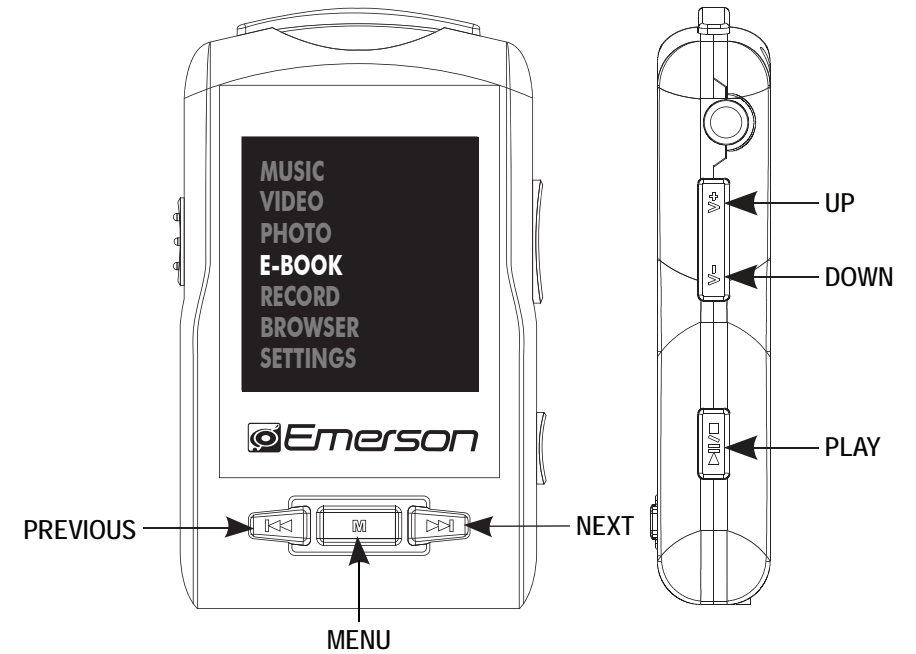

RECORD

Your **MP3 Player** is able to perform voice recordings with its integrated microphone.

The files are in **WAV** format. You can listen to these files while being at the **“BROWSER”** mode, and selecting the **“Voice”** folder.

Recording

1. Select **“RECORD”** from the main menu, and press the **[PLAY]** button.
2. Press the **[PLAY]** button once again to start recording.
3. Press the **[PLAY]** button to pause recording.
4. To finish recording and save, press and **HOLD** the **[MENU]** button.

Playing back recorded files

1. Select **“BROWSER”** from the main menu, and press the **[PLAY]** button.
2. Select the the **“Voice”** folder.
3. Select the file you wish to play, and press the **[PLAY]** button.
4. Press the **[PLAY]** button to pause the playback, to resume playback, press the **[PLAY]** button once again.
5. Press and **HOLD** the **[MENU]** button to return to the main menu.

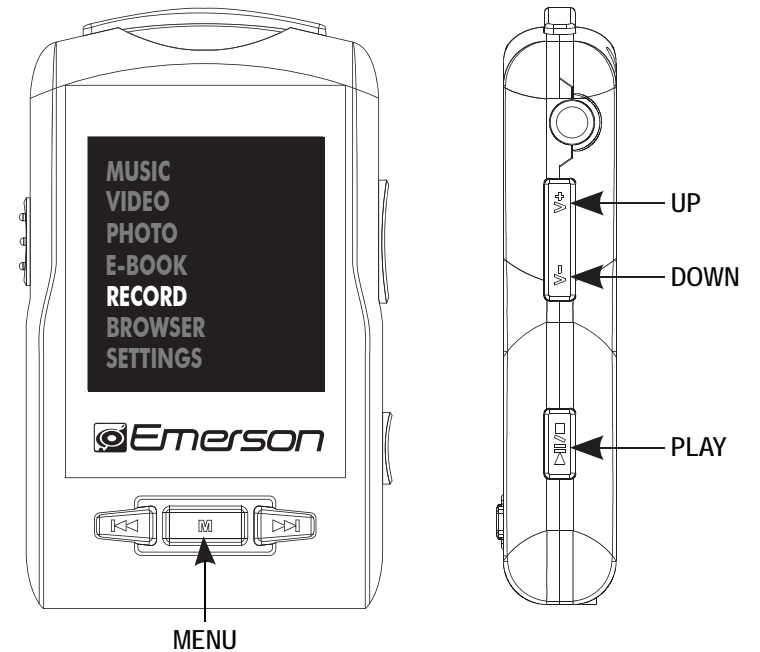

BROWSER

This handy function allows you to directly choose the music / video / image / e-book folder or file you want to play or view.

1. Select “**BROWSER**” from the main menu, and press the [**PLAY**] button.
2. Use the [**UP**] or [**DOWN**] button to select a folder or file.
3. Press the [**PLAY**] button to enter the selected folder, or play a file.

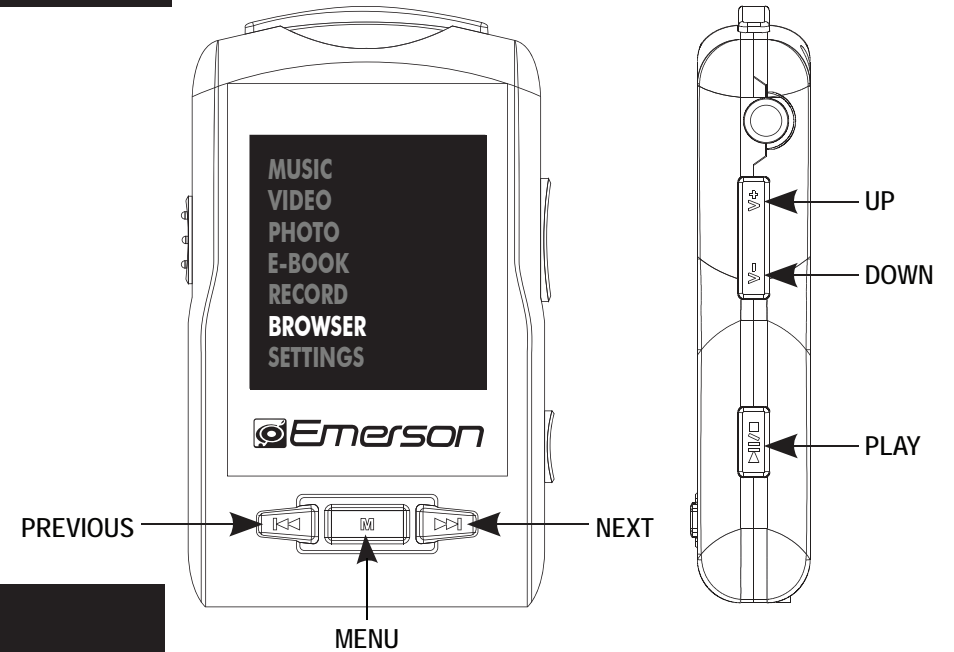

DELETE

- **Directly from the player**

If you want to delete a file, enter the “**BROWSER**” mode and select it. Press and **HOLD** the [**NEXT**] button, select “**Yes**” with the [**PREVIOUS**] or [**NEXT**] button and press the [**PLAY**] button. To cancel the deletion, simply select “**No**”.

OR

- **From your computer**

You can easily delete music, picture or video files by connecting your video player to the computer and selecting “**Emerson MP3**” from Windows Explorer or “**My Computer**”, or click on “**Open Folder**” to view files from the “**Auto play**” option window, simply select the file and delete it as you would delete any other file from your computer.

SETTINGS

The player's settings can be customized by accessing "SETTINGS" in the main menu. The settings menu consists of several items where various functions can be selected concerning music, power, language, display, recording, system, etc.

1. Select "SETTINGS" from the main menu, and press the [PLAY] button.
2. Use the [UP] or [DOWN] button to select a submenu.
3. To enter a submenu, press the [PLAY] button.
4. To save an option, press the [UP] or [DOWN] buttons to select the option, and press the [PLAY] button to confirm.
5. To return to the previous directory, press and **HOLD** the [MENU] button.

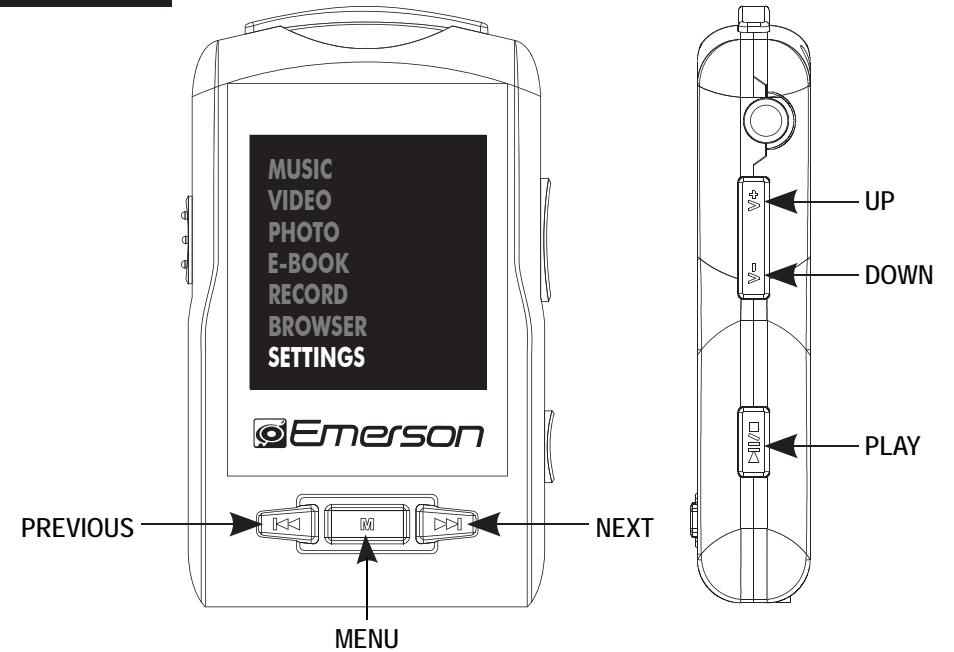

TROUBLESHOOTING

If you have problems while operating your player, please check the points below before sending it to the service center.

Can not power on

- The battery may be exhausted, please recharge the battery

Files can not be transferred to the player

- Check if the driver is installed correctly in the computer by disconnecting and then reconnecting the player to the computer
- Check the connection between the player and PC, and confirm the USB cable is properly connected

No sound from the headphones

- Please ensure the volume is turned up, and the headphones are properly connected
- Check if the format of music file is supported by the player

Can not record

- Check if there is enough memory and battery capacity

Display is in the wrong language

- Please ensure you selected the correct language from the “**Settings** ” menu

The buttons do not work

- Press the reset hole with a metal pin to re-initialize the system of the player

My computer is not detecting the MP3 Player with Windows Vista

- There is a USB mass storage devices recognition issue with Windows Vista acknowledged by Microsoft. A solution is available in the Service Pack 1 which may be downloaded from Microsoft's website

I cannot display my .jpg files

- Many digital cameras and image editing softwares add hidden data to the .jpg files. This data can prevent your MP3 from loading the images. Try to eliminate them by saving the file with another name.

The Video converter is not converting videos or is not functioning properly

- Right-click on the  converter icon and select “**Run as administrator**”.

AVIConverter



SPECIFICATIONS

Connect with PC	USB 2.0 (HIGH SPEED)	
Built-in memory	2GB	
Power source	Built-in Lithium battery	
Recording	Sampling rate	8 KHz/16KHz
	Recording format	WAV (32Kbps/64Kbps)
	Recording time	8 hours (128M Flash)
MP3, WMA	Earphone Max output	(L) 5mW+ (R) 5mW (32ohm)
	MP3 bit rate	8Kbps - 320Kbps
	WMA bit rate	32Kbps - 384Kbps
	Frequency response	20Hz to 20KHz
Music file format	MP3 / WMA	
Video file format	AVI	
Operating temperature	-5 - 40° C	
Language	English, Spanish, German, French, Italian, Portugese	
OS	Windows 2000/ME/XP/Vista	

LIMITED WARRANTY

In the unlikely event that this product is defective, or does not perform properly, you may within ninety (90) days from your original date of purchase return it to the authorized service center for repair or exchange.

TO OBTAIN WARRANTY SERVICE:

- Provide proof of the date of purchase within the package (Dated bill of sale)
- Prepay all shipping costs to the authorized service center, and remember to insure your return.
- Include a return shipping address (no P.O. Boxes), a telephone contact number, and the defective unit within the package.
- Describe the defect or reason you are returning the product.

Your product will be repaired or replaced, at our option, for the same or similar model of equal value if examination by the service center determines this product is defective. Products received damaged as a result of shipping, will require you to file a claim with the carrier.

**The shipping address of the authorized
service center is:**

 **Southern Telecom Inc.
ATTN: Returns Department
14-C 53rd Street
Brooklyn, NY 11232**

Should you have any questions or problems concerning this product, please contact our customer service department at:

 **1-877-768-8483 (Toll Free)**

Monday - Thursday: 9AM - 5PM (EST)

Friday: 9AM - 3PM (EST)

or

via e-mail at

 **cs@southerntelecom.com**

To obtain service after the warranty period, please e-mail cs@southerntelecom.com with product information, date of purchase and nature of the problem. Customer service will reply to the e-mail with service instructions.

Warranty service not provided:

This warranty does not cover damage resulting from accident, misuse, abuse, improper installation or operation, lack of reasonable care, and unauthorized modification. This warranty is voided in the event any unauthorized person opens, alters or repairs this product. All products being returned to the authorized service center for repair must be suitably packaged.

Limitation of Warranty:

- THE WARRANTY STATED ABOVE IS THE ONLY WARRANTY APPLICABLE TO THIS PRODUCT. ALL OTHER WARRANTIES, EXPRESS OR IMPLIED (INCLUDING ALL IMPLIED WARRANTIES OF MERCHANTABILITY OR FITNESS FOR A PARTICULAR PURPOSE) ARE HEREBY DISCLAIMED. NO VERBAL OR WRITTEN INFORMATION GIVEN BY SOUTHERN TELECOM INC. IT'S AGENTS, OR EMPLOYEES SHALL CREATE A GUARANTY OR IN ANY WAY INCREASE THE SCOPE OF THIS WARRANTY.
- REPAIR OR REPLACEMENT AS PROVIDED UNDER THIS WARRANTY IS THE EXCLUSIVE REMEDY OF THE CONSUMER, SOUTHERN TELECOM INC. SHALL NOT BE LIABLE FOR INCIDENTAL OR CONSEQUENTIAL DAMAGES RESULTING FROM THE USE OF THIS PRODUCT OR ARISING OUT OF ANY BREACH OF ANY EXPRESS OR IMPLIED WARRANTY ON THIS PRODUCT. THIS DISCLAIMER OF WARRANTIES AND LIMITED WARRANTY ARE GOVERNED BY THE LAWS OF THE STATE OF NEW YORK. EXCEPT TO THE EXTENT PROHIBITED BY APPLICABLE LAW, ANY IMPLIED WARRANTY OF MERCHANTABILITY OR FITNESS FOR A PARTICULAR PURPOSE ON THIS PRODUCT IS LIMITED TO THE APPLICABLE WARRANTY PERIOD SET FORTH ABOVE.

How state law relates to this warranty:

- Some states do not allow the exclusion nor limitation of incidental, consequential damages, or limitations on how long an implied warranty lasts so the above limitations or exclusion may not apply to you..
- This warranty gives you specific legal rights, and you also may have other rights that vary from state to state.



Manufactured by: AIT Inc. Brooklyn, NY 11232

Emerson and the G-Clef logo are registered trademarks of Emerson Radio Corp. Parsippany, New Jersey USA

© 2009 AIT Inc. All rights reserved

Microsoft, the Windows logo, and Windows Media are either registered trademarks or trademarks of Microsoft Corporation in the United States and / or other countries.

Free Manuals Download Website

<http://myh66.com>

<http://usermanuals.us>

<http://www.somanuals.com>

<http://www.4manuals.cc>

<http://www.manual-lib.com>

<http://www.404manual.com>

<http://www.luxmanual.com>

<http://aubethermostatmanual.com>

Golf course search by state

<http://golfingnear.com>

Email search by domain

<http://emailbydomain.com>

Auto manuals search

<http://auto.somanuals.com>

TV manuals search

<http://tv.somanuals.com>