

Quick Guide

DVD / Video Cassette Recorder with DVR (HDD)

EWH100F

1 Connection to a TV

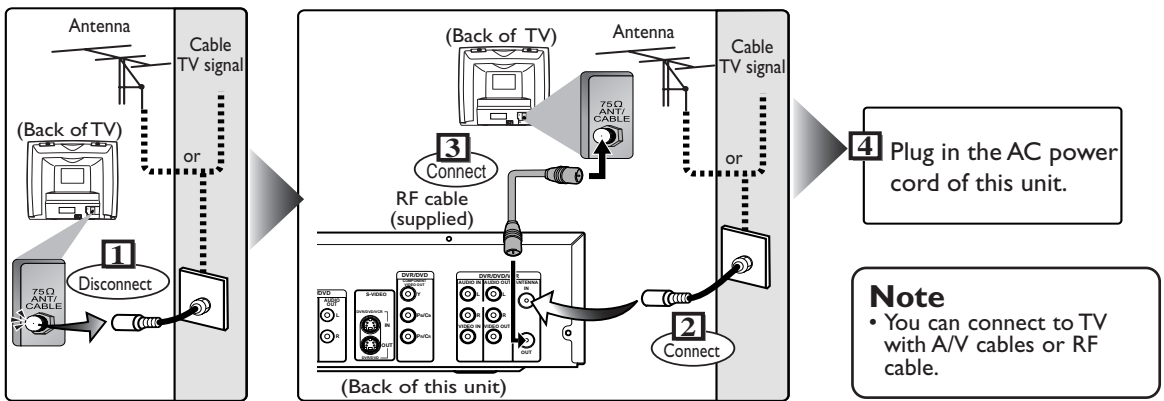

Choose one of the following connections, depending on the capabilities of the equipment you possess.

Basic Audio Connection

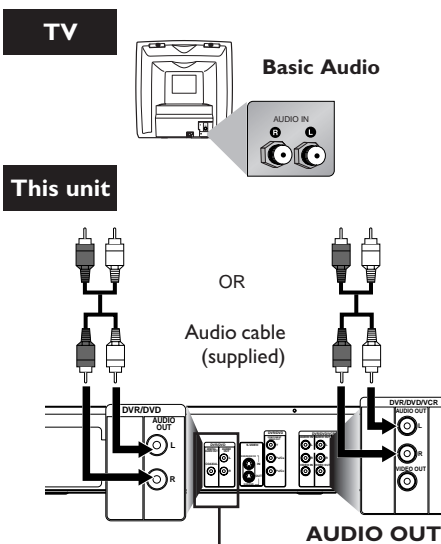

• These jacks are useful only in DVR / DVD mode.

Video Connections (○ = Available, — = Not Available)

Picture Quality	Basic	Good	Best
DVR/DVD	○ OR	○ OR	○
VCR	○ (required)	—	—

TV	VIDEO IN	S-VIDEO IN	COMPONENT VIDEO IN
This unit	VIDEO OUT	S-VIDEO OUT	COMPONENT VIDEO OUT
	VIDEO OUT	S-VIDEO OUT	COMPONENT VIDEO OUT
	VIDEO OUT	S-VIDEO OUT	COMPONENT VIDEO OUT

(Compatible with the Progressive Scan mode)

First Time You Turn on the Unit

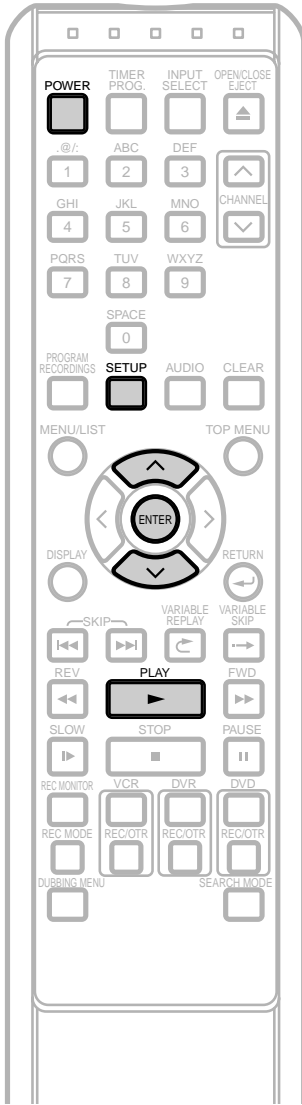

- 1 After making all the necessary connections, turn on the TV, select the appropriate external input channel.
- 2 Press **POWER**. The Display shown below will appear. This menu may not appear if you have already turned on the unit before. See page 21-24 of the Owner's Manual in such case.

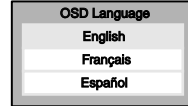

If you press **PLAY** ► at this point, “English” will be selected automatically and the steps 3 and 4 can be skipped.

- 3 Press **^ / v** to select “English”, “Français (French)” or “Español (Spanish)”. Then, press **ENTER**. After selecting the language, the Auto Channel Preset will start automatically.
- 4 After Auto Channel Preset is finished, the Auto Clock function will be activated automatically and the correct time will be set.

TV Audio Setting

- 1 Press **SETUP**.
- 2 Using **^ / v**, select “Initial Setup”. Press **ENTER**.
- 3 Using **^ / v**, select “Channel Setting”. Press **ENTER**. Channel Setting Menu will appear:

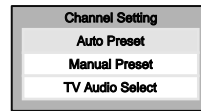

- 4 Using **^ / v**, select “TV Audio Select”. Press **ENTER**. Option window will appear.

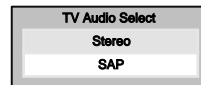

- 5 Using **^ / v**, select “Stereo” or “SAP”. Press **ENTER**.
Stereo:
 Outputs main-audio.
SAP (Secondary Audio Program):
 Outputs sub-audio.

- 6 Press **SETUP** to exit.

Notes on TV channel audio

• Refer to the following table to check the appropriate setting.

Broadcast audio		Selected audio	DVR/DVD/VCR recording
Main-audio channel	Sub-audio channel		
STEREO	SAP	Stereo	STEREO
STEREO	NONE		STEREO
MONO	SAP		MONO
MONO	NONE		MONO
STEREO	SAP	SAP	SAP
STEREO	NONE		STEREO
MONO	SAP		SAP
MONO	NONE		MONO

3 Recording and Playback Information





Recordable disc

Discs which can be used with this recorder:

- DVD-R disc: up to 16x (4x or 8x disc is recommended)
- DVD-RW disc: 2x and 4x (2x disc is recommended)

Discs tested and proven to be compatible with this recorder:

MAXELL DVD-R disc 4x
 TDK DVD-RW disc 2x
 JVC DVD-RW disc 4x
 VERBATIM DVD-R disc 8x

Disc type	Disc format	Functions
	Video mode 	Playback, limited recording, limited editing
DVD-RW	VR mode 	Playback, recording, Original List / Playlist editing
	Video mode 	Playback, limited recording, limited editing

DVD players with **RW** are capable of playing DVD-RW disc recorded in VR mode.

Rec Mode

You can select a Rec Mode among six options, and the recording time and the picture/audio quality of recorded material depends on the Rec Mode you select.

Disc Size	Rec Mode	Recording time	Video / Sound Quality
8 cm Disc	XP	18 min	☆☆☆☆☆☆ (good)
	SP	36 min	☆☆☆☆☆☆
	LP	72 min	☆☆☆☆
	EP	108 min	☆☆☆
	SLP	144 min	☆☆
	SEP	180 min	☆ (poor)
12 cm Disc	XP	60 min	☆☆☆☆☆☆ (good)
	SP	120 min	☆☆☆☆☆☆
	LP	240 min	☆☆☆☆
	EP	360 min	☆☆☆
	SLP	480 min	☆☆
	SEP	600 min	☆ (poor)
DVR	XP	17 H	☆☆☆☆☆☆ (good)
	SP	34 H	☆☆☆☆☆☆
	LP	68 H	☆☆☆☆
	EP	102 H	☆☆☆
	SLP	136 H	☆☆
	SEP	170 H	☆ (poor)

To select the Rec Mode you prefer, press **REC MODE** repeatedly.

Playable discs

This unit is compatible with the following discs.

Discs with the following logos can be played back on the unit. Playback of other disc types is not guaranteed.

Disc	Logo
DVD-VIDEO	
DVD-RW (VIDEO/VR mode)	
DVD-R (VIDEO mode)	
CD-DA (AUDIO CD)	
CD-RW (CD-DA FORMAT, MP3 / WMA files)	 
CD-R (CD-DA FORMAT, MP3 / WMA files)	 

DVD is a trademark of DVD Format/Logo Licensing Corporation.

Color systems

DVDs are recorded in different color systems throughout the world. The most common color system is NTSC (which is used primarily in the United States and Canada).

This unit uses NTSC, you must use DVDs recorded in the NTSC system. You cannot play back DVDs recorded in other color systems.

Region codes

DVDs must be labeled for ALL regions or for Region 1. Look for the symbols below on your DVDs.



To select the Rec Mode you prefer, press **REC MODE** repeatedly.

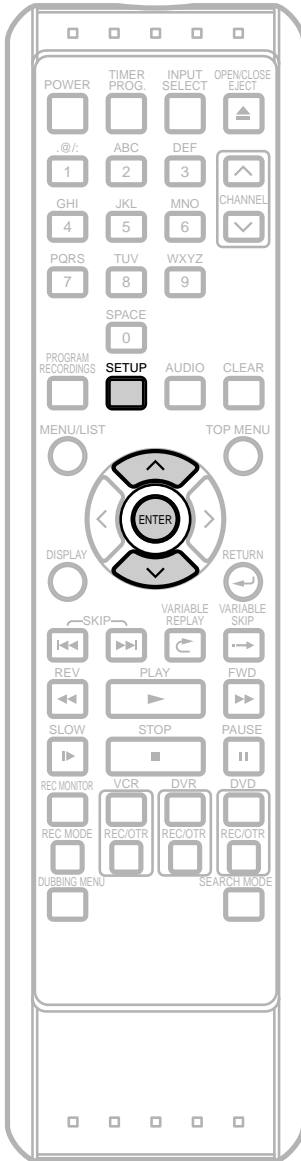

The recording format type you set here will be memorized and applied to the disc whenever you format DVD-RW discs.

- 1 Press **SETUP**.
- 2 Using \wedge / \vee , select “**DVD Menu**”. Press **ENTER**.
- 3 Using \wedge / \vee , select “**DVD Recording Format**”. Press **ENTER**.
Option window will appear.

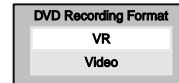

- 4 Using \wedge / \vee , select “**VR**” or “**Video**”. Press **ENTER**.

Auto Format

Whenever you load a brand new DVD-RW disc, the unit will automatically format the disc in the recording format type you set in this section.



The following will help you to understand easily how to record to the internal DVR or to DVDs.
Make sure batteries are in the remote control and you have connected this unit and the TV correctly.

Step 1: Choose a disc type & the Recording Format. (Only if you are recording to DVD.)

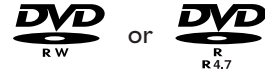

Step 2: Preparing the media

- 1 Turn on the unit.
- 2 Select the device you want to use. (If you are recording to the DVR, skip to step 3.)
- 3 Open the disc tray, and place a disc on the tray.
- 4 Close the disc tray.

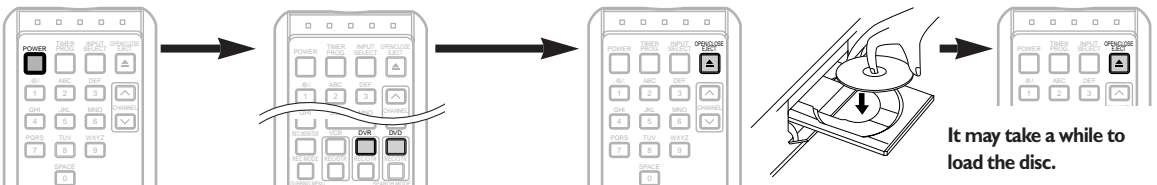

- If you load a brand new DVD-RW disc, Auto Format will start automatically.

Step 3: Select the Rec Mode.

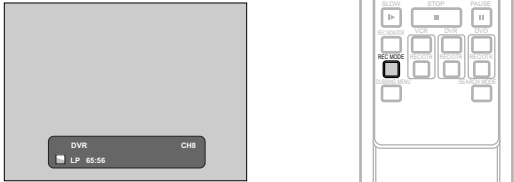

Step 5: Start Recording.

- When recording to the DVR:
Press **REC / OTR** (DVR).
- When recording to the DVD:
Press **REC / OTR** (DVD).



Step 4: Select the desired channel to record.

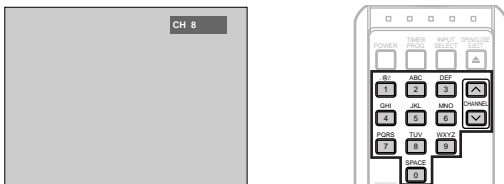

Step 6: Stop Recording.



This operation may take a while to be recognized.

Note

DVR is a temporary storage location.

- DVR is not a permanent storage location of the recorded contents. Be sure to use it as a temporary storage location until you watch the programs once, edit them, or dub them to a DVD disc or a videotape.

80GB Hard Disc

- This unit is equipped with an 80 GB hard disc which allows you to record up to 170 hours (with SEP mode).



We illustrated DVR to DVD dubbing here as an example. Refer to the Owner's Manual on how to perform other types of dubbing.

1 Press **DUBBING MENU**.

The Dubbing Direction and the Rec Mode menu will appear.

DUBBING	
Dubbing Direction	Rec Mode
DVR → DVD	High
DVD → DVD	XP
DVR → VCR	SP
VCR → DVR	LP
DVD → VCR	EP
VCR → DVD	SLP
	SEP
	Auto

2 Using \wedge / \vee , select the desired dubbing direction, then press **ENTER**.

Example: DVR → DVD

DUBBING	
Dubbing Direction	Rec Mode
DVR → DVD	High
DVD → DVD	XP
DVR → VCR	SP
VCR → DVR	LP
DVD → VCR	EP
VCR → DVD	SLP
	SEP
	Auto

3 Using \wedge / \vee , select a desired Rec Mode. Press **ENTER**.

Dubbing Top Menu will appear.

DUBBING	
Dubbing List	
Direction DVR→DVD	
Mode XP	
Select Program	
Dubbing Start	

4 Using \wedge / \vee , select “Select Program”. Press **ENTER**.

Program List will appear.

DUBBING	
Program List (Original)	Dubbing List
1 Title 1	
2 Title 2	
3 Title 3	
4 Title 4	
5 Title 5	
6 Title 6	
7 Title 7	
8 Title 8	

- 5 Using \wedge / \vee , select a desired program. Press **ENTER**.
Program List Menu will appear.

Add to Dubbing List.
Playlist
Decide

- 6 Using \wedge / \vee , select “Add to Dubbing List.”. Press **ENTER**.
The selected program is now added to the Dubbing List.

DUBBING	
Program List (Original)	Dubbing List
1 Title 1	2 Title 2
2 Title 2	
3 Title 3	
4 Title 4	
5 Title 5	
6 Title 6	
7 Title 7	
8 Title 8	

- 7 Repeat the steps 5 to 6 until you select all programs to be dubbed.

- 8 After selecting all the programs you want, press **RETURN** \leftarrow to go back to the Dubbing Top Menu.

DUBBING	
Dubbing List	
Direction DVR→DVD	2 Title 2
Mode XP	4 Title 4
Select Program	
Dubbing Start	

- 9 Using \wedge / \vee , select “Dubbing Start”. Press **ENTER**.

Confirmation window will appear.

Start Dubbing?
Yes No

- 10 Using \leftarrow / \rightarrow , select “Yes”. Press **ENTER**.
Dubbing will start.

• It may take a while to prepare for the dubbing.

To stop the dubbing while in the dubbing preparation mode:

- Press the **Device Select Button** of the recording media first, then press **STOP** \blacksquare . Or, press **STOP/EJECT** \blacksquare \blacktriangle on the front panel.

To stop the dubbing in progress:

- Press the **Device Select Button** of the recording media first, then press **STOP** \blacksquare and hold it for 2 seconds or press **STOP/EJECT** \blacksquare \blacktriangle on the front panel.

7

Finalize



You must first finalize the disc before playing it back on other unit.

- 1 Press **SETUP**.
- 2 Using **^ / v**, select **"DVD Menu"**, then press **ENTER**.
- 3 Using **^ / v**, select **"Finalize"**, then press **ENTER**. Confirmation window will appear.

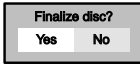

- If the disc has already been finalized, **"Undo Finalize"** will be listed in the menu instead of **"Finalize"** (DVD-RW only). To Undo the finalization of the disc, select **"Undo Finalize"** and press **ENTER**.

- 4 Using **< / >**, select **"Yes"**, then press **ENTER**. Final confirmation window will appear.

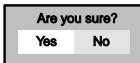

- 5 Using **< / >**, select **"Yes"**, then press **ENTER**. Finalizing will start.
 - If you want to stop the process, press **ENTER**.

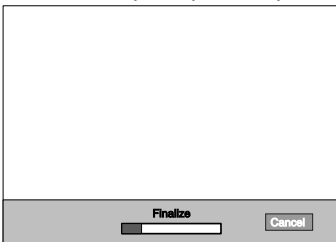

This operation may take a while to be completed.

8

DVR / DVD Playback



If you are playing the DVR, press **DVR** first.
If you are playing a disc, press **DVD** first.

- 1 If you are playing the DVR, skip to step 4.
- 2 Press **OPEN / CLOSE ▲** to open the disc tray.
- 3 Insert the disc with its label facing up. Align the Disc to the disc tray guide.

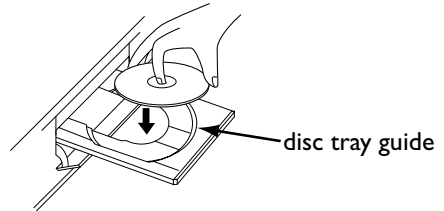

Press **OPEN / CLOSE ▲** again to close the disc tray.
Press **PLAY ►** to start playing back a CD.
For DVR / DVD Playback, proceed to step 4.
• It may take a while to load the disc.

- 4 Press **TOP MENU**. Title List will appear.

Example: DVR

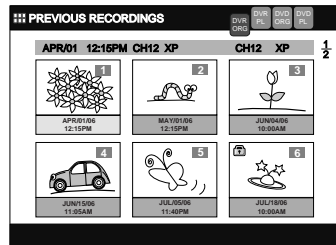

Press **MENU / LIST** to switch Original List / Playlist if necessary.

- 5 Using **^ / v / < / >**, select a desired title, then press **PLAY ►**. Playback will start.
- 6 Press **STOP ■** to stop playback.

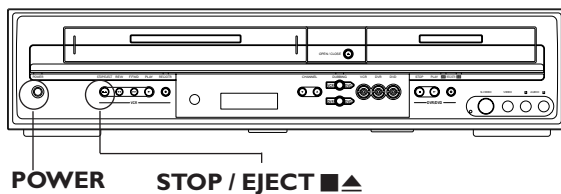
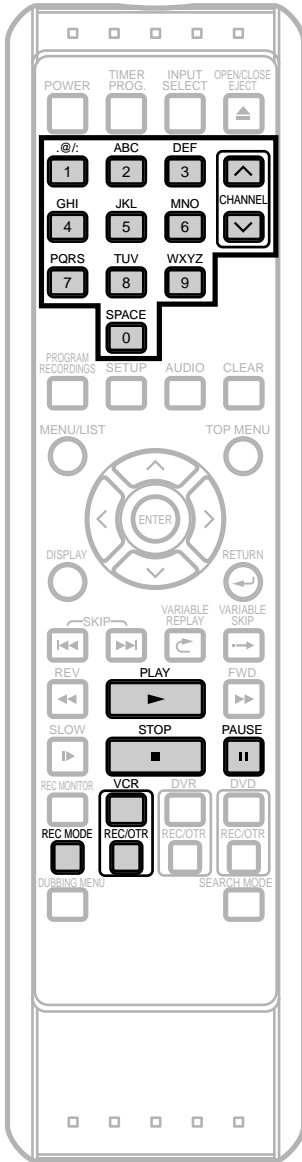

Basic Recording



Before recording, make sure:

- The desired channel is selected by pressing the **Number Buttons** or **CHANNEL** \wedge / \vee .
- There is a videotape with a record tab in the unit.
- The desired Rec Mode (SP: Standard Play or SLP: Super Long Play) is selected by pressing **REC MODE** on the remote control.

Rec Mode

Tape speed	Recording / Playback Time			
	Type of tape	T60	T120	T160
SP mode	1 hour	2 hours	2-2 / 3 hours	3-1 / 2 hours
SLP mode	3 hours	6 hours	8 hours	10-1 / 2 hours

- Stereo or SAP is selected.

Press **VCR** first.

- 1 Press **REC / OTR** (VCR) to begin the recording.
To temporarily stop recording or to resume it, press **PAUSE II**. After the unit has been in pause for five minutes, it will stop automatically to protect the videotape and the video head from damage.
- 2 Press **STOP** \blacksquare when the recording is completed.

Accidental erasure prevention

To prevent accidental recording on a recorded videotape, remove its record tab. To record on it later, cover the hole with cellophane tape.

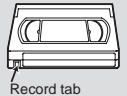

Basic Playback



Press **VCR** first.

- 1 Insert a prerecorded videotape. Press **PLAY** \blacktriangleright to begin playback.
 - If there is no record tab, playback starts automatically.
- 2 During playback, press **PAUSE II**.
Playback will pause and sound will be muted.
- 3 Press **PLAY** \blacktriangleright to resume playback.
- 4 Press **STOP** \blacksquare to stop playback.
- 5 Press **STOP / EJECT** $\blacksquare \blacktriangle$ on the front panel of the unit to eject the videotape.

Owner's Manual



EMERSON AND THE G-CLEF LOGO ARE REGISTERED TRADEMARKS OF EMERSON RADIO CORP., PARSIPPANY, NEW JERSEY, U.S.A.

Recordable disc

Discs which can be used with this recorder:

- DVD-R disc: up to 16x (4x or 8x disc is recommended)
- DVD-RW disc: 2x and 4x (2x disc is recommended)

Discs tested and proven to be compatible with this recorder:

- MAXELL DVD-R disc 4x TDK DVD-RW disc 2x
- JVC DVD-RW disc 4x VERBATIM DVD-R disc 8x

DVD / Video Cassette Recorder with DVR (HDD)

EWH100F

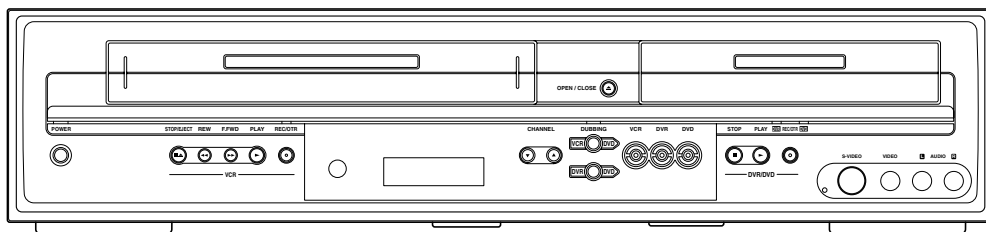

INSTRUCCIONES EN ESPAÑOL INCLUIDAS.

Supplied Accessories

- Remote control (NB308UD) with two AA batteries
- RF cable (WPZ0901TM002)
- Audio / Video cables (WPZ0102TM015 or WPZ0102LTE01)
- Owner's Manual (1VMN22052)
- Quick Use Guide (1VMN22053)
- Blank Media DVD-R disc x1 (KDDZZZZMB001)

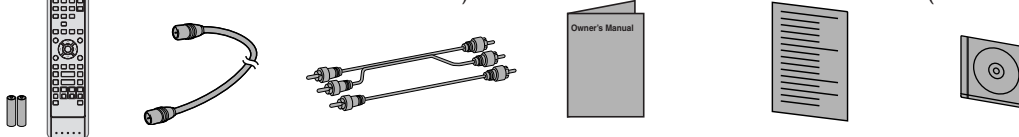

Please read before using this equipment.

If you need additional operating assistance after reading this owner's manual or to order replacement accessories, please call

TOLL FREE: 1-800-605-8453

or visit our web site at <http://www.EmersonAudioVideo.com>

Before you use this unit, you need to complete connections. Refer to 'Connections' on pages 17-19.

To record a program easily, refer to 'Easy DVR / DVD Recording' on pages 32-33 after connections are completed.

Before You Start

Connections

Initial Setup

Recording / Dubbing

Playback

Editing

Other Setup

VCR functions

Others

Español

Before You Start

Precautions

WARNING: TO REDUCE THE RISK OF FIRE OR ELECTRIC SHOCK, DO NOT EXPOSE THIS APPLIANCE TO RAIN OR MOISTURE.



CAUTION
RISK OF ELECTRIC SHOCK
DO NOT OPEN



CAUTION:

TO REDUCE THE RISK OF ELECTRIC SHOCK, DO NOT REMOVE COVER (OR BACK). NO USER SERVICEABLE PARTS INSIDE. REFER SERVICING TO QUALIFIED SERVICE PERSONNEL.



The lightning flash with arrowhead symbol, within an equilateral triangle, is intended to alert the user to the presence of uninsulated, "dangerous voltage" within the product's enclosure that may be of sufficient magnitude to constitute a risk of electric shock to persons.



The exclamation point within an equilateral triangle is intended to alert the user to the presence of important operating and maintenance (servicing) instructions in the literature accompanying the appliance.

Laser Safety

This unit employs a laser. Only a qualified service person should remove the cover or attempt to service this device, due to possible eye injury.

CAUTION: USE OF CONTROLS OR ADJUSTMENTS OR PERFORMANCE OF PROCEDURES OTHER THAN THOSE SPECIFIED HEREIN MAY RESULT IN HAZARDOUS RADIATION EXPOSURE.

CAUTION: VISIBLE AND INVISIBLE LASER RADIATION WHEN OPEN AND INTERLOCK DEFEATED. DO NOT STARE INTO BEAM.

LOCATION: INSIDE, NEAR THE DECK MECHANISM.

FCC WARNING- This equipment may generate or use radio frequency energy. Changes or modifications to this equipment may cause harmful interference unless the modifications are expressly approved in the manual. The user could lose the authority to operate this equipment if an unauthorized change or modification is made.

RADIO-TV INTERFERENCE

This equipment has been tested and found to comply with the limits for a Class B digital device, pursuant to Part 15 of the FCC Rules. These limits are designed to provide reasonable protection against harmful interference in a residential installation. This equipment generates, uses, and can radiate radio frequency energy and, if not installed and used in accordance with the instructions, may cause harmful interference to radio communications. However, there is no guarantee that interference will not occur in a particular installation. If this equipment does cause harmful interference to radio or television reception, which can be determined by turning the equipment off and on, the user is encouraged to try to correct the interference by one or more of the following measures:

- 1) Reorient or relocate the receiving antenna.
- 2) Increase the separation between the equipment and receiver.
- 3) Connect the equipment into an outlet on a circuit different from that to which the receiver is connected.
- 4) Consult the dealer or an experienced radio / TV technician for help.

This Class B digital apparatus complies with Canadian ICES-003.

Cet appareil numérique de la classe B est conforme à la norme NMB-003 du Canada.

CAUTION: TO PREVENT ELECTRIC SHOCK, MATCH WIDE BLADE OF PLUG TO WIDE SLOT, FULLY INSERT.

ATTENTION: POUR ÉVITER LES CHOC ÉLECTRIQUES, INTRODUIRE LA LAME LA PLUS LARGE DE LA FICHE DANS LA BORNE CORRESPONDANTE DE LA PRISE ET POUSSER JUSQU'AU FOND.

A NOTE ABOUT RECYCLING

This product's packaging materials are recyclable and can be reused. Please dispose of any materials in accordance with your local recycling regulations.

Batteries should never be thrown away or incinerated but disposed of in accordance with your local regulations concerning chemical wastes.

Make your contribution to the environment!!!

- Used up batteries do not belong in the dust bin.
- You can dispose of them at a collection point for used up batteries or special waste. Contact your council for details.



For Customer Use:

Read carefully the information located at the back of this unit and enter below the Serial No. Retain this information for future reference.

Model No. _____

Serial No. _____

Precautions (Cont'd)

IMPORTANT SAFEGUARDS

1. Read Instructions - All the safety and operating instructions should be read before the appliance is operated.
2. Retain Instructions- The safety and operating instructions should be retained for future reference.
3. Heed Warnings - All warnings on the appliance and in the operating instructions should be adhered to.
4. Follow Instructions - All operating and use instructions should be followed.
5. Cleaning - Unplug this product from the wall outlet before cleaning. Do not use liquid cleaners or aerosol cleaners. Use a damp cloth for cleaning.

EXCEPTION: A product that is meant for uninterrupted service and, that for some specific reason, such as the possibility of the loss of an authorization code for a CATV converter, is not intended to be unplugged by the user for cleaning or any other purpose, may exclude the reference to unplugging the appliance in the cleaning description otherwise required in item 5.

6. Attachments - Do not use attachments not recommended by the product manufacturer as they may cause hazards.
 7. Water and Moisture- Do not use this product near water, for example, near a bath tub, wash bowl, kitchen sink, or laundry tub, in a wet basement, or near a swimming pool, and the like.
 8. Accessories - Do not place this product on an unstable cart, stand, tripod, bracket, or table. The product may fall, causing serious injury to a child or adult, and serious damage to the appliance. Use only with a cart, stand, tripod, bracket, or table recommended by the manufacturer, or sold with the product. Any mounting of the appliance should follow the manufacturer's instructions and should use a mounting accessory recommended by the manufacturer. An appliance and cart combination should be moved with care. Quick stops, excessive force, and uneven surfaces may cause the appliance and cart combination to overturn.
- PORTABLE CART WARNING
(Symbol provided by RETAC)
- 
- S3125A
9. Ventilation - Slots and openings in the cabinet are provided for ventilation and to ensure reliable operation of the product and to protect it from overheating, and these openings must not be blocked or covered. The openings should never be blocked by placing the product on a bed, sofa, rug, or other similar surface. This product should not be placed in a built-in installation such as a bookcase or rack unless proper ventilation is provided or the manufacturer's instructions have been adhered to.
 10. Power Sources - This product should be operated only from the type of power source indicated on the marking label. If you are not sure of the type of power supply to your home, consult your appliance dealer or local power company. For products intended to operate from battery power, or other sources, refer to the operating instructions.
 11. Grounding or Polarization - This product is equipped with a polarized alternating-current line plug (a plug having one blade wider than the other). This plug will fit into the power outlet only one way. This is a safety feature. If you are unable to insert the plug fully into the outlet, try reversing the plug. If the plug should still fail to fit, contact your electrician to replace your obsolete outlet. Do not defeat the safety purpose of the polarized plug.
 12. Power Cord Protection - Power supply cords should be routed so that they are not likely to be walked on or pinched by items placed upon or against them, paying particular attention to cords at plugs, convenience receptacles, and the point where they exit from the appliance.
 13. Outdoor Antenna Grounding - If an outside antenna or cable system is connected to the product, be sure the antenna or cable system is grounded so as to provide some protection against voltage surges and built-up static charges. Article 810 of the National Electrical Code, ANSI / NFPA No. 70, provides information with regard

to proper grounding of the mast and supporting structure, grounding of the lead-in wire to an antenna discharge unit, size of grounding conductors, location of antenna-discharge unit, connection to grounding electrodes, and requirements for the grounding electrode. (Fig.A)

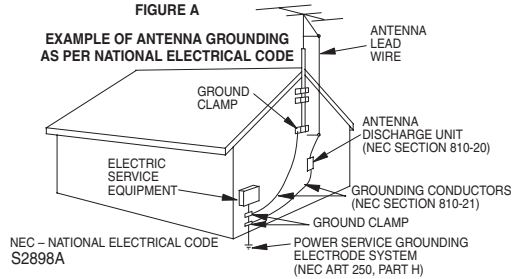

14. Lightning - For added protection for this product during a lightning storm, or when it is left unattended and unused for long periods of time, unplug it from the wall outlet and disconnect the antenna or cable system. This will prevent damage to the product due to lightning and power-line surges.
15. Power Lines - An outside antenna system should not be located in the vicinity of overhead power lines or other electric light or power circuits, or where it can fall into such power lines or circuits. When installing an outside antenna system, extreme care should be taken to keep from touching such power lines or circuits as contact with them might be fatal.
16. Overloading - Do not overload wall outlets and extension cords as this can result in a risk of fire or electric shock.
17. Object and Liquid Entry - Never push objects of any kind into this product through any openings as they may touch dangerous voltage points or short-out parts that could result in a fire or electric shock. Never spill liquid of any kind on the product.
18. Servicing - Do not attempt to service this product yourself as opening or removing covers may expose you to dangerous voltage or other hazards. Refer all servicing to qualified service personnel.
19. Damage Requiring Service - Unplug this product from the wall outlet and refer servicing to qualified service personnel under the following conditions:
 - a. When the power-supply cord or plug is damaged.
 - b. If liquid has been spilled, or objects have fallen into the product.
 - c. If the product has been exposed to rain or water.
 - d. If the product does not operate normally by following the operating instructions. Adjust only those controls that are covered by the operating instructions as an improper adjustment of other controls may result in damage and will often require extensive work by a qualified technician to restore the product to its normal operation.
 - e. If the product has been dropped or damaged in any way.
 - f. When the product exhibits a distinct change in performance this indicates a need for service.
20. Replacement Parts - When replacement parts are required, be sure the service technician has used replacement parts specified by the manufacturer or have the same characteristics as the original part. Unauthorized substitutions may result in fire, electric shock or other hazards.
21. Safety Check - Upon completion of any service or repairs to this product, ask the service technician to perform safety checks to determine that the product is in proper operating condition.
22. Heat - This product should be situated away from heat sources such as radiators, heat registers, stoves, or other products (including amplifiers) that produce heat.

Before You Start
 Connections
 Initial Setups
 Recording / Dubbing
 Playback
 Editing
 Other Setups
 VCR functions
 Others
 Español

Before You Start

Precautions (Cont'd)

Installation Location

For safety and optimum performance of this unit:

- Install the unit in a horizontal and stable position. Do not place anything directly on top of the unit. Do not place the unit directly on top of the TV.
- Shield it from direct sunlight and keep it away from sources of intense heat. Avoid dusty or humid places. Avoid places with insufficient ventilation for proper heat dissipation. Do not block the ventilation holes on the sides of the unit. Avoid locations subject to strong vibration or strong magnetic fields.

Avoid the Hazards of Electrical Shock and Fire

- Do not handle the power cord with wet hands.
- Do not pull on the power cord when disconnecting it from AC wall outlet. Grasp it by the plug.
- If, by accident, water is spilled on this unit, unplug the power cord immediately and take the unit to our Authorized Service Center for servicing.

Moisture Condensation Warning

Moisture condensation may occur inside the unit when it is moved from a cold place to a warm place or after heating a cold room or under conditions of high humidity. Do not use this unit at least for 2 hours until its inside gets dry.

About Copyright

Unauthorized copying, broadcasting, public performance and lending of discs are prohibited.

This product incorporates copyright protection technology that is protected by U.S. patents and other intellectual property rights. Use of this copyright protection technology must be authorized by Macrovision, and is intended for home and other limited viewing uses only unless otherwise authorized by Macrovision. Reverse engineering or disassembly is prohibited.

Notice for progressive scan outputs

Consumers should note that not all high definition television sets are fully compatible with this product and may cause artifacts to be displayed in the picture. In case of picture problems with 525p progressive scan outputs, it is recommended that the user switch the connection to the 'standard definition' output. If there are questions regarding your TV set compatibility with this model 525p DVD recorder, please contact our customer service center.

Precautions (Cont'd)

Manufactured under license from Dolby Laboratories. "Dolby" and the double-D symbol are trademarks of Dolby Laboratories.

Dolby Digital Recording

"Dolby® Digital Recording enables consumers to record high-quality video with stereo sound on recordable DVD discs. The technology, when utilized instead of PCM recording, also saves recordable disc space, allowing for higher video resolution or extended recording time on each DVD. DVDs created using Dolby Digital Recording will play back on all DVD-Video players."

Note: This is true when the players are compatible with actual recordable DVD discs.

Dolby Digital Stereo Creator

"Dolby® Digital Stereo Creator enables consumers to create stereo DVD-Videos with stunning Dolby Digital sound tracks at home. The technology, when utilized instead of PCM recording, also saves recordable disc space, allowing for higher video resolution or extended recording time on each DVD. DVDs mastered using Dolby Digital Stereo Creator will play back on all DVD-Video players."

Table of Contents

<p>Before You Start2</p> <p>Precautions2</p> <p style="padding-left: 20px;">Laser Safety2</p> <p style="padding-left: 20px;">IMPORTANT SAFEGUARDS3</p> <p>Table of Contents6</p> <p>Features8</p> <p>Functional Overview10</p> <p style="padding-left: 20px;">Front Panel10</p> <p style="padding-left: 20px;">Rear Panel11</p> <p style="padding-left: 20px;">Remote Control12</p> <p style="padding-left: 20px;">Front Panel Display14</p> <p style="padding-left: 20px;">Guide to Display information15</p> <p style="padding-left: 20px;">Guide to Setup Menu15</p> <p style="padding-left: 20px;">Other Overviews16</p> <hr/> <p>Connections17</p> <p style="padding-left: 20px;">Connection to a TV17</p> <p style="padding-left: 20px;">Connection to a Cable Box or Satellite Box18</p> <p style="padding-left: 20px;">Connection to an Audio System19</p> <hr/> <p>Initial Setups20</p> <p style="padding-left: 20px;">First Time You Turn on the Unit20</p> <p style="padding-left: 20px;">OSD Language Setting21</p> <p style="padding-left: 20px;">Channel Setting22</p> <p style="padding-left: 40px;">Getting Channels Automatically22</p> <p style="padding-left: 40px;">Adding / Deleting Channels23</p> <p style="padding-left: 20px;">Clock Setting24</p> <p style="padding-left: 40px;">Auto Clock Setting24</p> <p style="padding-left: 40px;">Manual Clock Setting25</p> <p style="padding-left: 40px;">Setting Daylight Saving Time26</p> <p style="padding-left: 20px;">TV Audio Setting27</p> <p style="padding-left: 20px;">TV Aspect Ratio Setting28</p> <hr/> <p>Recording / Dubbing29</p> <p style="padding-left: 20px;">Information on Supported Media29</p> <p style="padding-left: 20px;">Easy DVR / DVD Recording32</p> <p style="padding-left: 20px;">Formatting a Disc34</p> <p style="padding-left: 40px;">Selecting the Recording Format Type34</p> <p style="padding-left: 40px;">Formatting a Pre-Recorded Disc (Disc Format)35</p> <p style="padding-left: 20px;">Monitoring the Recording Quality36</p> <p style="padding-left: 20px;">Creating Chapter Marks Automatically37</p> <p style="padding-left: 20px;">Basic Recording38</p> <p style="padding-left: 20px;">One Touch Recording (OTR)39</p> <p style="padding-left: 20px;">Timer Recording40</p> <p style="padding-left: 40px;">Editing the Timer Programming Information42</p> <p style="padding-left: 40px;">Hints for Timer Recording43</p> <p style="padding-left: 20px;">Recording & Playback Navigator44</p> <p style="padding-left: 40px;">Guide to the Programmed Recordings Screen44</p> <p style="padding-left: 40px;">Programming a Recording with the Recording & Playback Navigator45</p> <p style="padding-left: 40px;">To Change or Cancel the Program45</p> <p style="padding-left: 40px;">Playback and Edit with Programmed Recordings46</p>	<p>Information on Dubbing47</p> <p style="padding-left: 20px;">One Touch Dubbing from DVR to DVD48</p> <p style="padding-left: 20px;">One Touch Dubbing from Videotape to DVD50</p> <p style="padding-left: 20px;">Dubbing from DVR / DVD to Videotape52</p> <p style="padding-left: 20px;">Bi-Directional Dubbing between DVR and DVD54</p> <p style="padding-left: 40px;">Deleting a Program from the Dubbing List57</p> <p style="padding-left: 40px;">Changing the Order of the Dubbing List57</p> <p style="padding-left: 20px;">Dubbing from Videotape to DVR / DVD58</p> <p style="padding-left: 20px;">Settings for the External Devices60</p> <p style="padding-left: 20px;">Dubbing from the External Devices61</p> <p style="padding-left: 20px;">Protecting a Disc62</p> <p style="padding-left: 20px;">Finalizing a Disc63</p> <p style="padding-left: 40px;">Finalize63</p> <p style="padding-left: 40px;">Auto Finalize64</p> <hr/> <p>Playback66</p> <p>Playback Information66</p> <p>Basic Playback67</p> <p style="padding-left: 20px;">Direct Playback67</p> <p style="padding-left: 20px;">Playback from the Title List68</p> <p style="padding-left: 20px;">Playback from the Title List Menu69</p> <p style="padding-left: 20px;">Playback from the DVD Menu69</p> <p style="padding-left: 20px;">Playback from the Disc Menu70</p> <p style="padding-left: 20px;">Playing back MP3 / WMA Discs71</p> <p>Special Playback72</p> <p style="padding-left: 20px;">Resume Playback72</p> <p style="padding-left: 20px;">Fast forward / Fast reverse73</p> <p style="padding-left: 20px;">Slow forward / Slow reverse Playback74</p> <p style="padding-left: 20px;">Time Shift Playback75</p> <p style="padding-left: 20px;">Simultaneous Playback and Recording75</p> <p style="padding-left: 20px;">Pause76</p> <p style="padding-left: 20px;">Step-by-Step Playback76</p> <p style="padding-left: 20px;">Variable Replay / Variable Skip76</p> <p style="padding-left: 20px;">Zoom77</p> <p style="padding-left: 20px;">Repeat Playback78</p> <p style="padding-left: 20px;">Random Playback79</p> <p style="padding-left: 20px;">Program Playback80</p> <p>Search81</p> <p style="padding-left: 20px;">Title / Chapter Search81</p> <p style="padding-left: 40px;">Using SKIP ◀◀ / ▶▶81</p> <p style="padding-left: 40px;">Using DISPLAY81</p> <p style="padding-left: 20px;">Track Search82</p> <p style="padding-left: 40px;">Using SKIP ◀◀ / ▶▶82</p> <p style="padding-left: 40px;">Using DISPLAY82</p> <p style="padding-left: 20px;">Time Search83</p> <p style="padding-left: 20px;">Series Search84</p> <p>Selecting a Format of Audio and Video86</p> <p style="padding-left: 20px;">Switching Subtitles86</p> <p style="padding-left: 20px;">Switching Audio Soundtrack87</p> <p style="padding-left: 20px;">Switching Camera Angles88</p> <p style="padding-left: 20px;">Visual Noise Reduction88</p>
---	---

Table of Contents (Cont'd)

<p>Editing89</p> <p>Information on Disc Editing89</p> <p style="padding-left: 20px;">Guide to the Title List89</p> <p style="padding-left: 20px;">What are Original List and Playlist?89</p> <p style="padding-left: 20px;">Available Menus89</p> <p>Deleting Titles90</p> <p style="padding-left: 20px;">Deleting Selected Titles90</p> <p style="padding-left: 20px;">Deleting all Titles in DVR92</p> <p>Protecting / Undo Protecting Titles93</p> <p>Editing Title Names94</p> <p style="padding-left: 20px;">Guide to Edit Title Name95</p> <p>Deleting a Part of a Title96</p> <p>Dividing a Title98</p> <p>Combining Titles100</p> <p>Moving Titles102</p> <p>Chapter Marker104</p> <p style="padding-left: 20px;">Adding Chapter Marks104</p> <p style="padding-left: 20px;">Deleting Chapter Marks106</p> <p>Adding Titles to a Playlist108</p> <hr/> <p>Other Setups110</p> <p>Tour of the Setup Menus110</p> <p>Playback Setting112</p> <p style="padding-left: 20px;">1. Parental Lock113</p> <p style="padding-left: 20px;">2. Disc Menu Language114</p> <p style="padding-left: 20px;">3. Audio Language114</p> <p style="padding-left: 20px;">4. Subtitle Language114</p> <p style="padding-left: 20px;">5. Audio Out115</p> <p style="padding-left: 20px;">6. Variable Replay / Skip Speed116</p> <p style="padding-left: 20px;">7. Angle Icon117</p> <p style="padding-left: 20px;">8. Progressive117</p> <p>Display Setting118</p> <p style="padding-left: 20px;">1. FL Dimmer119</p> <p style="padding-left: 20px;">2. Screen Saver119</p> <p>Reset to Factory Default120</p> <hr/> <p>VCR functions121</p> <p>Guide to Display Information (VCR)121</p> <p>Recording122</p> <p style="padding-left: 20px;">Basic Recording122</p> <p style="padding-left: 20px;">One Touch Recording123</p> <p>Playback124</p> <p>Search125</p> <p style="padding-left: 20px;">Index Search125</p> <p style="padding-left: 20px;">Time Search126</p> <p>Other Operations127</p>	<p>Others128</p> <p>Troubleshooting128</p> <p style="padding-left: 20px;">General Operation128</p> <p style="padding-left: 20px;">Discs128</p> <p style="padding-left: 20px;">Timer Recording / Recording & Navigator128</p> <p style="padding-left: 20px;">Playback / Editing129</p> <p style="padding-left: 20px;">Dubbing129</p> <p>Glossary134</p> <p>Language Code135</p> <p>Maintenance136</p> <p>Frequently Asked Questions137</p> <p>Specification137</p> <hr/> <p>Español138</p> <hr/> <p>WARRANTYBack Cover</p>
---	--

Features

The following features are available with this unit.

Recording

This unit allows you to record on the DVR, a DVD-RW disc (rewritable) and a DVD-R disc (one-time write) as well as a videotape. You can choose any one for your convenience.

DVR / DVD / VCR

One Touch Recording (OTR)

[➡ Page 39 (DVR / DVD) or ➡ Page 123 (VCR)]

This feature allows you to start the recording right away with just one-touch. And each press of **REC / OTR** increases the recording time by 30 minutes.

DVR / DVD

Timer programming up to 32 programs

[➡ Page 40~41]

You can program the unit to record up to 32 programs within a one-month period. Daily or weekly repeating programs can also be programmed.

Recording Monitor [➡ Page 36]

You can check how the actual recording picture and the sound will be in the selected Rec Mode before attempting to record.

Automatic Chapter Marker [➡ Page 37]

Each recorded title is automatically marked with chapter marks.

Automatic Playlist Making (VR mode discs and DVR only)

[➡ Page 89]

Playlists are automatically copied from the Original List, so that you can edit titles.

DVR

80GB Hard Disc (DVR) [➡ Pages 29~31]

This unit is equipped with a DVR with 80 GB hard disc which allows you to record up to 170 hours (with SEP mode). The DVR operates just like a VR mode DVD-RW disc. Most of the functions which are available with a VR mode DVD-RW disc can be performed on the DVR, too.

Recording and Playback Navigation

[➡ Pages 44~46]

You can easily program recording or call and replay a title which is recorded in the past on the calendar.

DVD

Automatic Finalize (Video mode only) [➡ Page 64]

You can set the disc to be finalized automatically at your desirable timing.

Automatic DVD Menu Making (Video mode only)

[➡ Page 65]

DVD Menus are made automatically when a Video mode disc is finalized.

Relay Recording [➡ Page 41]

During Timer Recording to a DVD, if the disc runs out of the space, or if there is no recordable disc in the unit, it automatically changes the recording media to the DVR.

VCR

Left Channel Stereo Recording [➡ Page 127]

Material that has been recorded to the left channel only can be automatically copied to the left and right channels when dubbing.

Dubbing

With this unit, you can enjoy bi-directional dubbing with DVR, DVD or VCR.

DVR / DVD

Maximum of x 20 DVR to VR mode DVD-RW disc dubbing speed (High Speed Dubbing)

[➡ Pages 54~56]

Up to 20 times high speed dubbing from DVR to VR mode DVD-RW disc is possible if you use the compatible disc.

Just Dubbing [➡ Page 54]

When dubbing from DVR to DVD, if you set the Rec Mode to **"Auto"**, this unit will automatically select the most suitable Rec Mode for the dubbing.

Features (Cont'd)

Playback

DVR / DVD / VCR

Simultaneous Playback and Recording [➔ Page 75]

You can play back a title while recording.

DVR / DVD

Theater-quality Sound at Home [➔ Page 19]

When connecting the unit to an amplifier or a decoder that is compatible with Dolby Digital, you can experience a theater-quality sound environment.

Variable Skip [➔ Page 76]

You can skip a certain time, which is specified in the Setup Menu in advance, with one-touch while playback.

Variable Replay [➔ Page 76]

You can skip back a certain time, which is specified in the Setup Menu in advance, with one-touch while playback.

Progressive Scan System [➔ Page 17]

Unlike the standard definition output system (interlace scanning), the progressive scan system provides less flickering and higher resolution images than the traditional scanning system does.

DVR

Time Shift Playback [➔ Page 75]

You can play back from the top of the recording title while recording without waiting for the recording to end.

Series Search [➔ Page 84]

You can search for the group of titles made with the same Periodical Timer Recordings.

Editing

DVR / DVD

Deleting Titles [➔ Pages 90~91]

You can delete titles you no longer need.

Making Playlists [➔ Pages 108~109]

While the Original List remains as it is, you can edit titles in the Playlist.









- Putting Names on Titles
- Setting / Clearing Chapter Marks
- Dividing / Combining Titles
- Deleting Parts of Titles
- Moving Titles

Protecting Titles [➔ Page 93]

You can prevent accidental editing or title erasing.

Symbols Used in this Manual

The available functions depend on the type of disc or the Recording Format. To specify disc type or Recording Format for each function, we put the following symbols at the beginning of each function description.

Symbol	Description
	Available to DVR (internal HDD)
	Available to VR mode DVD-RW discs
	Available to Video mode DVD-RW discs
	Available to DVD-R discs
	Available to DVD-Video discs
	Available to Audio CDs
	Available to CD-RW / R discs with MP3 files
	Available to CD-RW / R discs with WMA files
	Available to VHS tapes Use only VHS tapes marked with this unit.



Windows Media and the Windows logo are trademarks or registered trademarks of Microsoft Corporation in the United States and/or other countries.

This unit is not compatible with Multiple Bit Rate (MBR: a file that contains the same content encoded at several different bit rates).

“WMA” (Windows Media Audio) is a new audio developed by Microsoft® in the United States of America.

Functional Overview

Front Panel

*The unit can also be turned on by pressing these buttons.

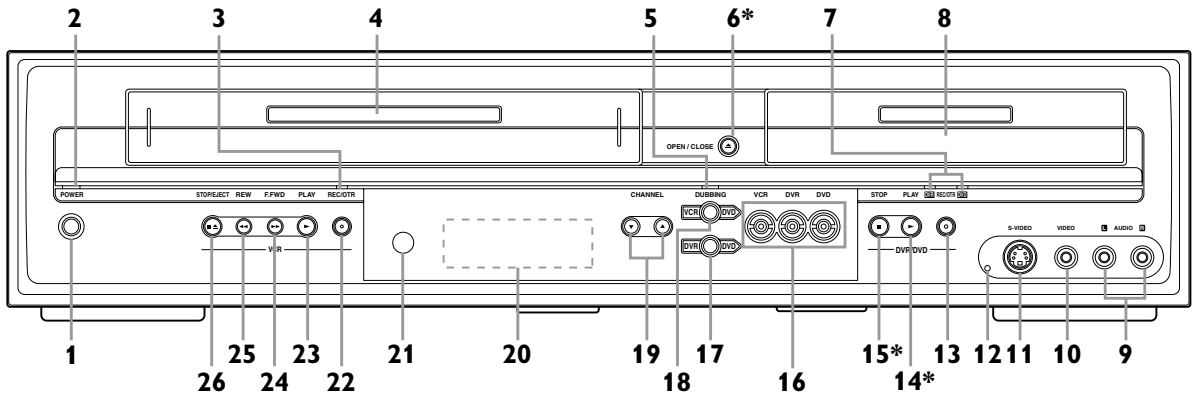

- 1 POWER:** Press to turn the unit on / off.
- 2 POWER Light:** Lights up when the power is on.
- 3 REC/OTR Light (VCR):** Lights up during VCR recording.
- 4 Cassette compartment:** Place a videotape here.
- 5 Dubbing Light:** Lights up during dubbing.
- 6 OPEN / CLOSE ▲* (DVD) :** Press to open / close the disc tray.
- 7 REC/OTR Light (DVR/DVD):** Lights up during DVR/DVD recording.
- 8 Disc tray:** Place a disc here.
- 9 AUDIO IN (LINE2):** Connect the audio output of an external device here using the supplied audio (L / R) cable.
- 10 VIDEO IN (LINE2):** Connect the video output of an external device here using the supplied video cable.
- 11 S-VIDEO IN (LINE2):** Connect the S-Video output of an external device here using a commercially available S-Video cable.
- 12 RESET:** Press with a sharp pointed object to restart the unit when it freezes. Also refer to the 'Note' below.
- 13 REC / OTR ● (DVR / DVD):** Press once to start a basic recording. Press repeatedly to start an OTR (One Touch Recording). Each press increases the recording time by 30 minutes up to 8 hours.
- 14 PLAY ►* (DVR / DVD):**
Press to start playback or resume playback.
- 15 STOP ■* (DVR / DVD):**
Press to stop playback, recording or dubbing.
- 16 Device Select Buttons / Indicators:**
VCR : Press to activate the VCR. Lights up when VCR is selected.
DVR: Press to activate the DVR. Lights up when DVR is selected.
DVD : Press to activate the DVD. Lights up when DVD is selected.
- 17 DUBBING DVR→DVD:** Press to start One Touch Dubbing from DVR to DVD.
- 18 DUBBING VCR→DVD:** Press to start One Touch Dubbing from VCR to DVD.
- 19 CHANNEL ▲ / ▼:** Press to change the channel.
- 20 Front Panel Display:** Shows information and messages.
- 21 Remote control sensor:** Receives signals from the remote control.
- 22 REC / OTR ● (VCR):** Press once to start a basic recording. Press repeatedly to start an OTR (One Touch Recording). Each press increases the recording time by 30 minutes up to 8 hours.
- 23 PLAY ► (VCR):** Press to start playback.
- 24 F.FWD ►► (VCR):** Press to fast forward or fast search.
- 25 REW ◀◀ (VCR):** Press to rewind or rewind search.
- 26 STOP / EJECT ■ ▲ (VCR):** Press to eject the videotape. Press to stop recording or playback.

Note

After pressing **RESET**,

- The settings for the items listed below will be lost;
 - Clock Setting
 - Timer Program Setting
 - Resume point
- The settings for the item listed below will not be lost, but need to be set again.
 - Channel Setting
- All other settings will remain memorized.

Functional Overview (Cont'd)

Rear Panel

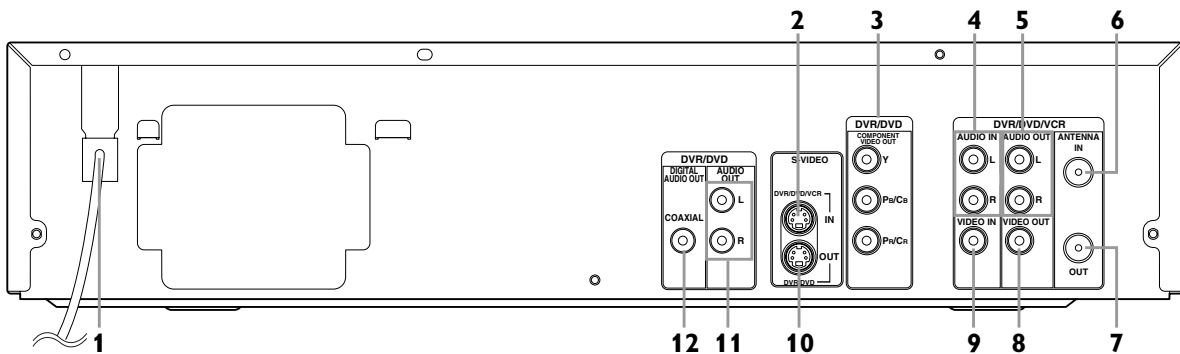

1 AC Power Cord: Connect to a standard AC outlet to supply power to this unit.

2 S-VIDEO IN (LINE 1): Connect the S-Video output of an external equipment here using a commercially available S-Video cable.

3 COMPONENT VIDEO OUT (DVR / DVD): Connect the component video input of a TV monitor, AV receiver, or other equipment here using a commercially available component video cable.

4 AUDIO IN (LINE 1): Connect an external equipment here using a supplied audio cable.

5 AUDIO OUT: Connect the audio input of a TV monitor, AV receiver, or other equipment here using the supplied audio (L / R) cable.

6 TV ANTENNA IN: Use to connect an antenna.

7 TV ANTENNA OUT: Use to connect an antenna cable to pass the signal from the TV ANTENNA IN to your TV monitor.

8 VIDEO OUT: Connect the video input of a TV monitor, AV receiver, or other equipment here using the supplied video cable.

9 VIDEO IN (LINE 1): Connect the video output of an external device here using the supplied video cable.

10 S-VIDEO OUT (DVR / DVD): Connect the S-Video input of a TV monitor, AV receiver, or other equipment here using a commercially available S-Video cable.

11 AUDIO OUT (DVR / DVD): Connect the audio input of a TV monitor, AV receiver, or other equipment here using the supplied audio (L / R) cable.

12 COAXIAL DIGITAL AUDIO OUT (DVR / DVD): Connect an AV receiver, Dolby Digital decoder or other equipment with a coaxial digital input jack with a digital coaxial cable.

Note: Do not touch the inner pins of the jacks on the rear panel. Electrostatic discharge may cause permanent damage to the unit.

Functional Overview (Cont'd)

Remote Control

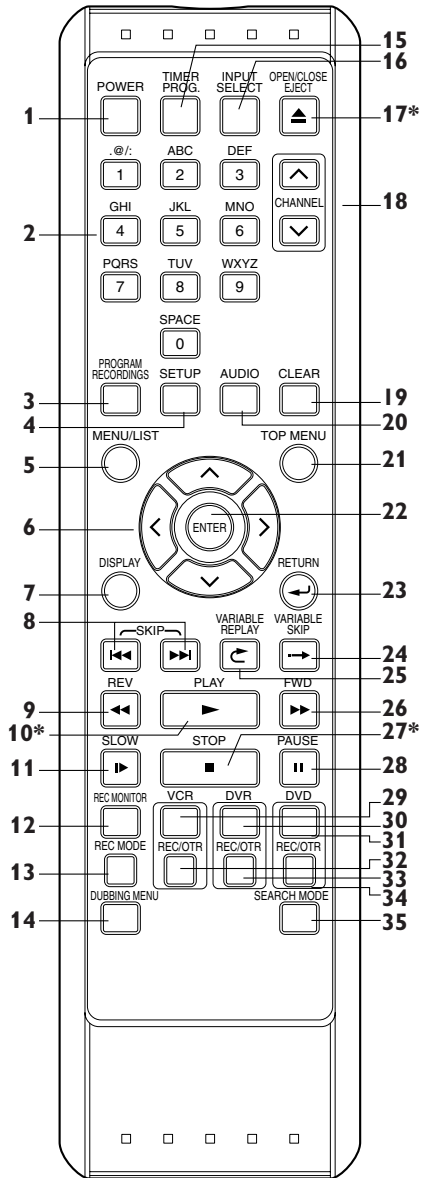

- 1 POWER:** Turns the unit on / off.
- 2 Number Buttons:**
Press to select channel numbers.
Press to select a title / chapter / track on display.
Press to enter setting values.
Press to enter the index number / desired time to search in VCR mode.
- 3 PROGRAM RECORDINGS:** Press to call up the Recording & Playback Navigation Screen.
- 4 SETUP:** Press to display the Setup Menu. The unit switches to the DVR / DVD mode when this button is pressed.
- 5 MENU / LIST (DVR / DVD):**
Displays the Disc Menu.
Switch the Original List and the Playlist.
- 6 Cursor $\wedge / \vee / \lt / \gt$:** Selects items or settings.
- 7 DISPLAY:** Displays the on-screen menu.
- 8 SKIP \ll / \gg (DVR / DVD):**
During playback, press to skip to the previous / next chapter or track. Or when playback is paused, press to play back in forward / reverse step by step.
- 9 REV \ll :**
(DVR / DVD) During playback, press to play back in fast reverse. Or when playback is paused, press to play back in slow reverse.
(VCR) Press to rewind the videotape or to view the picture rapidly in reverse during the playback mode.
- 10 PLAY \blacktriangleright *:** Press to start or resume playback.
If you press this button when the power is off, the unit will be turned on and the playback will start automatically.
If the resume point has been set, the playback will start from the resume point.
- 11 SLOW \blacktriangleright (VCR):** During playback, press to view the videotape in slow motion.
- 12 REC MONITOR (DVR / DVD):** Press to check the picture and the audio qualities for recording.
- 13 REC MODE:** Press to select the Rec Mode.
- 14 DUBBING MENU:** Press to display the Dubbing Menu. The unit switches to the DVR / DVD mode when this button is pressed.
- 15 TIMER PROG.:** Press to display the Timer Program List. The unit switches to the DVR / DVD mode when this button is pressed.

Functional Overview (Cont'd)

- 16 INPUT SELECT:** Press to select an input device.
- 17 OPEN / CLOSE EJECT \blacktriangle (DVD / VCR) *:** Press to open / close the disc tray or eject a videotape.
- 18 CHANNEL \wedge / \vee :**
Press to change the channel up / down.
(VCR) Press to adjust the tracking during playback or in slow motion of the videotape. Also while playback is in still mode, you can adjust the picture blurred vertically.
- 19 CLEAR:**
(DVR / DVD) Press to clear the information once entered, etc.
(DVD) Press to erase the track number entered in the program playlist for a CD.
(VCR) Press to reset the tape counter.
- 20 AUDIO:** During playback, press to change the AUDIO Setting.
- 21 TOP MENU (DVR / DVD):** Displays the Top Menu.
- 22 ENTER:** Press to confirm or select menu items.
- 23 RETURN \leftarrow :** Press to return to the previously displayed Menu Screen.
- 24 VARIABLE SKIP \rightarrow (DVR / DVD):**
Skips by the set in advance.
- 25 VARIABLE REPLAY \leftarrow (DVR / DVD):**
Replays by the set in advance.
- 26 FWD \blacktriangleright :**
(DVR / DVD) During playback, press to play back in fast forward. Or when playback is paused, press to play back in slow forward.
(VCR) Press to rapidly advance the videotape or view the picture rapidly in forward during playback.
- 27 STOP \blacksquare *:** Press to stop playback, recording, or dubbing.

- 28 PAUSE II :** Press to pause playback or recording.

Device Select Buttons:

- 29 VCR:** Press to activate the remote control in VCR mode. (See page 16.)
Press to activate the VCR.
- 30 DVR:** Press to activate the remote control in DVR mode. (See page 16.)
Press to activate the DVR.
- 31 DVD:** Press to activate the remote control in DVD mode. (See page 16.)
Press to activate the DVD.
- 32 REC / OTR (VCR):**
Press once to start a basic VCR recording. Press repeatedly to start a One Touch Recording in VCR mode.
- 33 REC / OTR (DVR):**
Press once to start a basic DVR recording. Press repeatedly to start a One Touch Recording in DVR mode.
- 34 REC / OTR (DVD):**
Press once to start a basic DVD recording. Press repeatedly to start a One Touch Recording in DVD mode.
- 35 SEARCH MODE (VCR):** Press to call up the index or Time Search Menu.

* In DVR / DVD mode the unit can also be turned on by pressing these buttons.

Functional Overview (Cont'd)

Front Panel Display

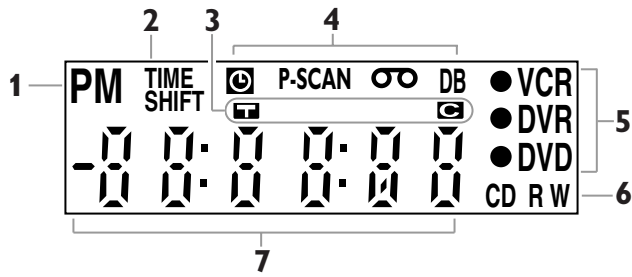

1 PM : Appears in the afternoon with the Clock Display.

2 TIME SHIFT :
Appears during the Time Shift Playback.

3 Title / Track and Chapter mark
T : Appears when indicating a title / track number.
C : Appears when indicating a chapter number.

4 Current status of the unit
⏸ : Appears when Timer Recording is in Standby, or is proceeding.
 Disappears when all the Timer Recordings are finished.

P-SCAN :
Appears when the picture output is progressive scan.

⏮ : Appears when a videotape is in the unit.

DB : Lights up during a dubbing process.

5 ●DVR : Lights up during recording with DVR.
●DVD : Lights up during recording with DVD.
●VCR : Lights up during recording with VCR.

6 Disc type and current status of the unit
CD : Appears when an audio CD or a disc with MP3 / WMA files is on the disc tray.
R : Appears when a DVD-R disc is loaded on the disc tray.
RW : Appears when a DVD-RW disc is loaded on the disc tray.

7 Displays the following

- Played-back time
- Current title / chapter / track number
- Recording time
- Clock
- Channel number
- VCR tape counter
- Remaining time for a One Touch Recording

Display message



Appears when the unit is turning on.



Appears when the unit is turning off.



Appears when the disc tray is opening.

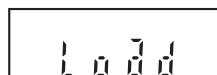

Appears when a disc is loaded on the disc tray.



Appears when the disc tray is closing.

Functional Overview (Cont'd)

Guide to Display Information

The Display Menu gives you information on the playback status of the DVR or DVD.

Display Example :

Press **DISPLAY** once to show the information on the current operation mode.

Press **DISPLAY** one more time to see more information, and to call up the icons for the available features.

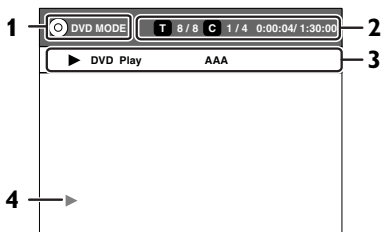

Press **DISPLAY**.

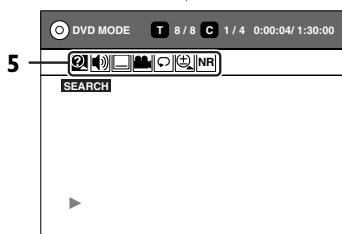

Each section includes the information as listed below:

- 1 Device mode
- 2 • Current title number / total number of the titles
• Current chapter number / total number of the chapters
• Elapsed playback time of the current title / total time of the title
- 3 • Playback status
• Name of the current title
- 4 Playback status icon
- 5 Icons for the available features:

: Search

: Audio

: Subtitle

: Angle

: Repeat

: Zoom

: Noise Reduction

Note

- This is an example screen only for explanation. Displayed items varies depending on the actual mode.
- The information will not appear under the following conditions;
 - When there is no title recorded in the DVR/DVD.
 - During recording (DVD only).
- Closed Caption will not be displayed while the Display Information is shown on the screen.

Guide to Setup Menu

This unit uses the following on-screen menu for most operations. It allows you to change the settings of the unit to match the environment, and to customise the settings as you prefer. “Easy Setting Menu” and “Advanced Menu” are available.

“Easy Setting Menu” consists of those frequently needed. You can make all required settings using “Advanced Menu”.

How to use Setup Menus :

Press **SETUP** to display “Easy Setting Menu” or “Advanced Menu”. Choose either menu using \wedge / \vee , then press **ENTER**.

- CD Menu is available only when a CD is loaded.

Example:Advanced Menu

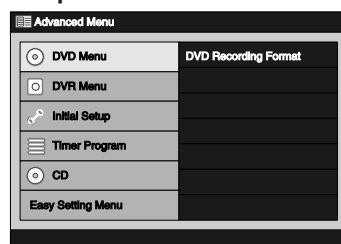

Using \wedge / \vee , select a menu, then press **ENTER**.

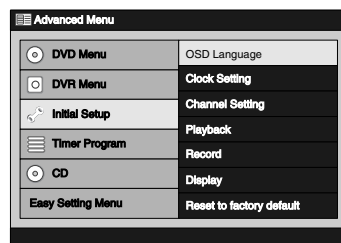

Using \wedge / \vee , select an Item to set, then press **ENTER**. Sub menu or option window will appear.

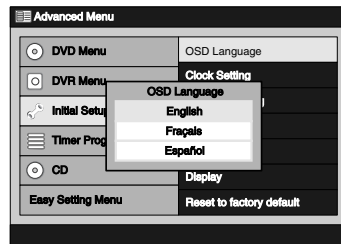

Using $\wedge / \vee / < / >$, make your desirable selection, then press **ENTER**.

Available menus vary among discs.

Functional Overview (Cont'd)

Other Overviews

Installing batteries in the remote control

Install two AA-size batteries (supplied), matching their polarity to those indicated inside the battery compartment of the remote control.

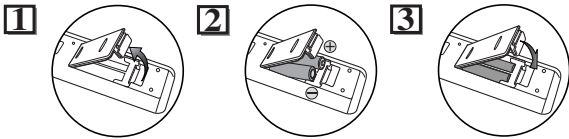

Battery use and care

Incorrect use of batteries can result in hazards such as leakage and bursting. Please follow the instruction below:

- Do not mix new and old batteries together.
- Do not use different kinds of batteries together. Although they may look similar, different batteries may have different voltages.
- Make sure that the plus and minus ends of each battery match the indications in the battery compartment.
- Remove batteries from equipment that is not going to be used for a month or more.
- When disposing of used batteries, please comply with governmental regulations or public rules for environmental protection that apply in your country or area.
- Do not recharge, short-circuit, heat, burn or disassemble batteries.

Using a remote control

Keep in mind the following when using the remote control:

- Make sure that there is no obstacle between the remote control and the remote sensor of the unit.
- Remote operation may become unreliable if strong sunlight or fluorescent light shines on the remote sensor of the unit.
- Remote control for different devices can interfere with each other. Avoid using remote controls for other equipment located close to the unit.
- Replace the batteries when you notice a fall-off of the operating range of the remote control.
- The maximum operable ranges (approximate) from the unit are as follows.
 - Straight line: 23 feet (7 m)
 - Either side of center: 16 feet (5 m) within 30°
 - Above: 16 feet (5 m) within 15°
 - Below: 10 feet (3 m) within 30°

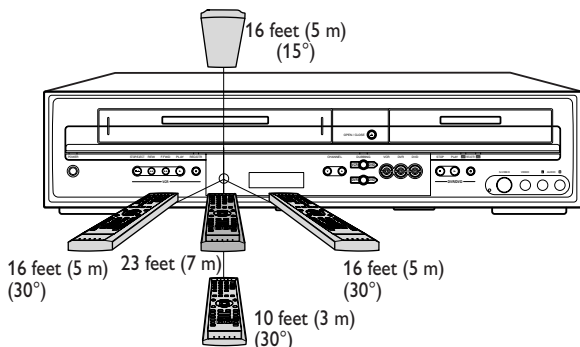

Switching DVR / DVD / VCR modes

Because this product is a combination of a DVR, DVD, and VCR recorder, you must select first which component you wish to operate.

DVR mode

Press **DVR** on the remote control.
(Verify that the DVR indicator is lit.)

DVD mode

Press **DVD** on the remote control.
(Verify that the DVD indicator is lit.)

VCR mode

Press **VCR** on the remote control.
(Verify that the VCR indicator is lit.)

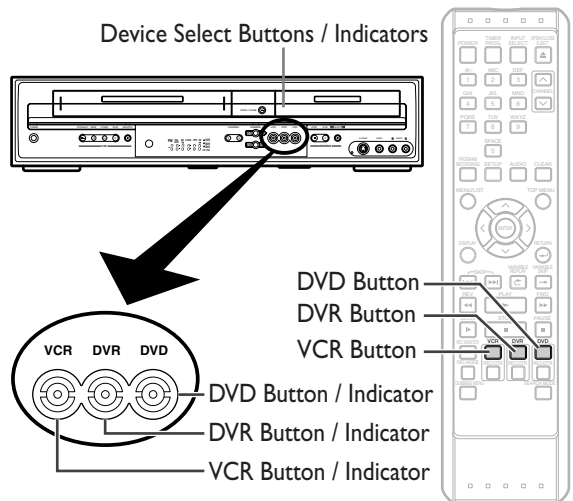

Note

- Pressing the device select button on the front panel **DOES NOT** switch the device mode of the remote control. You **MUST** select the correct device mode on the remote control.
- If you press **REC / OTR** of each device, recording starts in its device mode.
- When the buttons listed below are pressed, the unit switches to the DVR / DVD mode.
 - **TIMER PROG.**
 - **SETUP**
 - **DUBBING MENU**
- When the button listed below is pressed, the unit switches to the VCR mode.
 - **PROGRAM RECORDINGS**

Connections

Connection to a TV

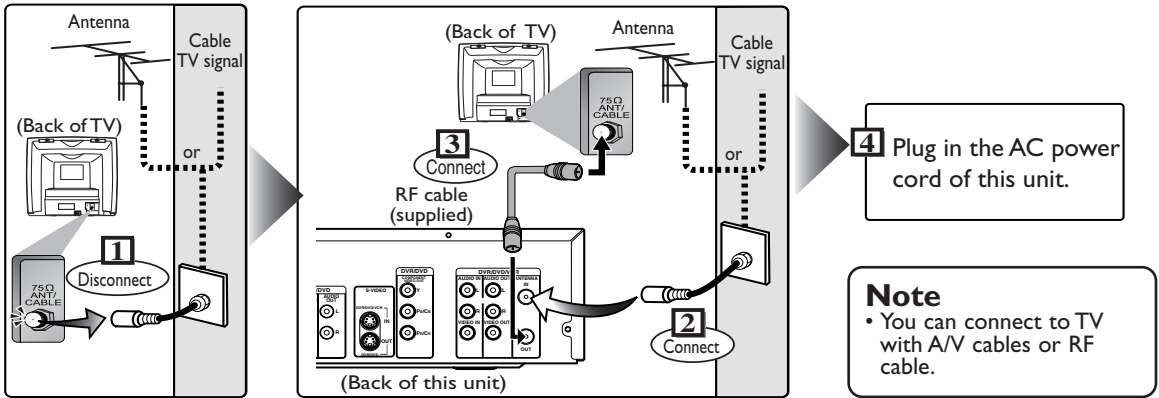

Choose one of the following connections, depending on the capabilities of the equipment you possess.

Basic Audio Connection

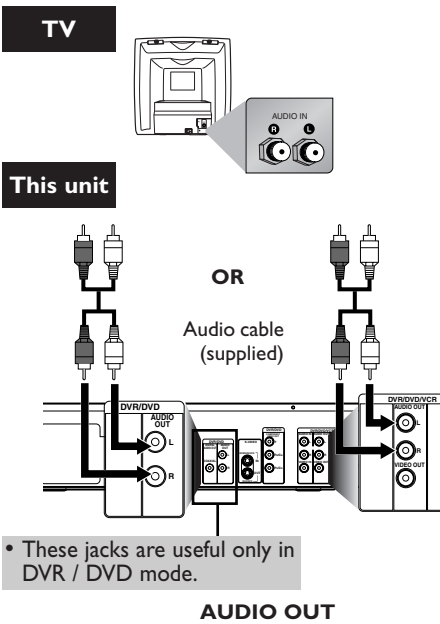

Video Connections (○ = Available, — = Not Available)

Picture Quality	Basic	Good	Best
DVR/DVD	○ OR	○ OR	○
VCR	○ (required)	—	—

TV	VIDEO IN	S-VIDEO IN	COMPONENT VIDEO IN
This unit	VIDEO OUT	S-VIDEO OUT	COMPONENT VIDEO OUT

Video cable (supplied)

S-Video cable (commercially available)

(Compatible with the Progressive Scan mode)

Component video cable (commercially available)

Note

- Connect this unit directly to the TV.
- The DVR/DVD and VCR is sending each video signals simultaneously.
- You will not be able to hear all of the sound being output by this unit if you use the video/audio cables (supplied) to a monaural TV that has only one audio input jack.
- Be sure that the colours of the jacks and plugs match up when connecting the cable.
- The S-VIDEO OUT and COMPONENT VIDEO OUT jacks are only useful for DVR/DVD playback.
- If your TV is compatible with the Progressive Scan System, and you want to utilize its feature, use COMPONENT VIDEO OUT connection. If you use any other connection such as VIDEO OUT or S-VIDEO OUT, the picture will not be output in the Progressive Scan mode but in the standard output mode (Interlace).

If your TV is compatible with 525 or 625 progressive scanning and you want to enjoy the high quality picture;

Use COMPONENT VIDEO OUT connection, set the “Progressive” to “On” in the Setup Menu (see page 117), and make sure “P.SCAN” indication is on the Front Panel Display.

If your TV is not compatible with Progressive Scan;

If your TV is not compatible with progressive scanning, set “Progressive” to “Off” in the Setup Menu, and make sure no “P.SCAN” indication is on the Front Panel Display.

Connections

Connection to a TV (Cont'd)

After you have completed connections

Turn your TV to the appropriate external input channel (usually near channel 0) in order to view the pictures output from this unit on the TV. To find the external input channel press the channel button on your TV's remote repeatedly until the DVD recorder's picture appears. External input channels may vary depending on the connection you made. Check your TV owner's manual for details.

Input Mode Names for Common TV Brands (Example)

Admiral	AUX	Panasonic	TV/VIDEO
Curtis Mathis	LINE1, LINE2, 00, 90, 91, 92, 93	RCA	INPUT, TV / VCR, 00, 90, 91, 92, 93
GE	INPUT, TV / VCR, 00, 90, 91, 92, 93	Samsung	TV/VIDEO
Hitachi	INPUT, AUX	Sanyo	VIDEO
JVC	VIDEO, VIDEO1, VIDEO2, VIDEO3	Sharp	00
Kenwood	AUX	Sony	VIDEO1, VIDEO2, VIDEO3
LXI-Series	00	Toshiba	TV / GAME
Magnavox	AUX CHANNEL	Zenith	00

Connection to a Cable Box or Satellite Box

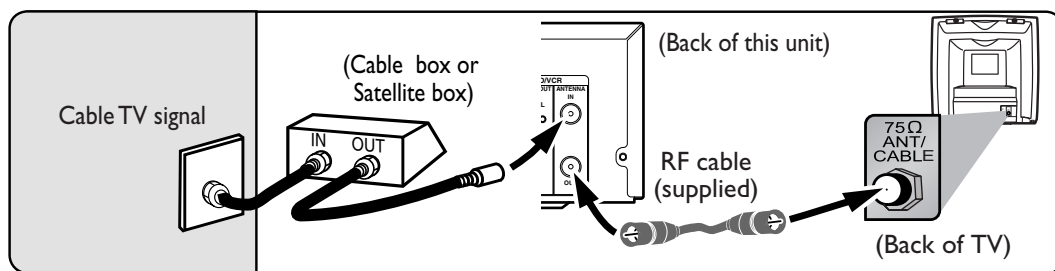

This connection allows you to view or record a scrambled channel. With this connection, channels cannot be changed on this unit. You can view or record **ONLY** the channels you have selected on the cable box or the satellite box.

- Read the instruction manual of the cable box or the satellite box also.

Note to the Cable TV System Installer:

This reminder is provided to call the Cable TV system installer's attention to Article 820-40 of the National Electrical Code, which provides guidelines for proper grounding—in particular, specifying that the cable ground shall be connected to the grounding system of the building, as close to the point of cable entry as possible.

Connection to an Audio System

- When you change the connections, all devices should be turned off.
- Refer to the operation manual accompanying external devices for more information.

Method 1

Stereo system

Analog audio input jacks

AUDIO

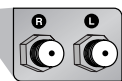
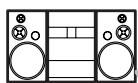

Audio cable (supplied)

This unit

AUDIO OUT

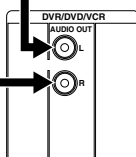

or

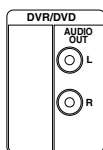

Method 2

Dolby Digital decoder, MD deck or DAT deck

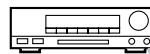

COAXIAL

Digital audio input jack

Digital Coaxial cable (commercially available)

DIGITAL AUDIO OUT

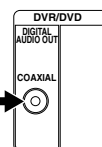

Connection	Setting	Initial Setup > Playback > Audio Out >	
		PCM	Dolby Digital
If output is Dolby Digital encoded audio, connect to a Dolby Digital decoder.		-	Stream
Unless connected to a Dolby Digital decoder.		-	PCM
Connecting to an MD deck or DAT deck.		-	PCM

*To complete these settings. (See pages 115–116.)

Note

- By connecting this unit to a Multi-channel Dolby Digital decoder, you can enjoy high-quality Dolby Digital 5.1 channel surround sound as heard in the movie theaters.
- The audio source on a disc in a Dolby Digital 5.1 channel surround format cannot be recorded as digital sound by an MD or DAT deck.
- Playing back a DVD using incorrect settings may generate noise distortion and may also damage the speakers.

First Time You Turn on the Unit

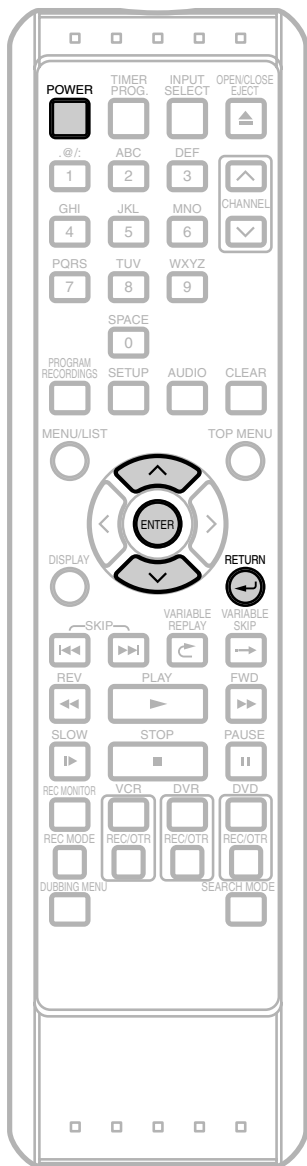

Right after the purchase of the unit, do the Initialize Setting by taking the following procedures. This menu may not appear if you have already turned on the unit.

1 After making all the necessary connections, turn on the TV. Select the appropriate external input channel. (See page 18.)

2 Press **POWER**. The Display shown below will appear.

These menus may not appear if you have already turned on the unit. If you have already turned on the unit before, refer to 'OSD Language Setting' on page 21 to select a language for the on-screen displays and the menus, 'Channel Setting' on page 22 to setup the channels, and 'Clock Setting' on page 24 to set the clock.

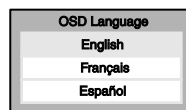

If you press **PLAY** at this point, "English" will be selected automatically and the steps 3 and 4 can be skipped.

3 Press **^** / **v** to select "English", "Français (French)" or "Español (Spanish)". Then, press **ENTER**. The following screen will automatically appear and the Auto Channel Preset will start.

If you like to skip this step, press **RETURN** as soon as the search begins.

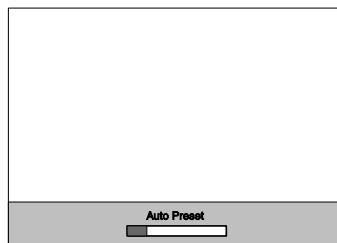

4 After Auto Channel Preset is finished, the Auto Clock function will be activated automatically and the correct time will be set.

OSD Language Setting

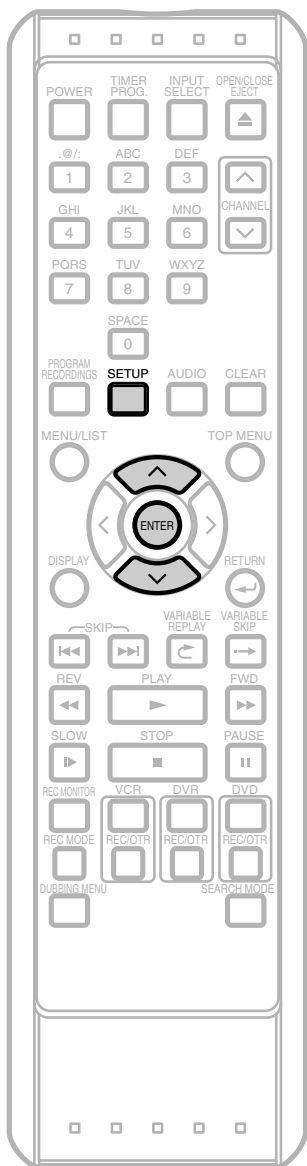

If you have already set the OSD Language when you first turned on the unit, you can skip this section.

- 1 Press **SETUP**.
“Easy Setting Menu” or “Advanced Menu” will appear.

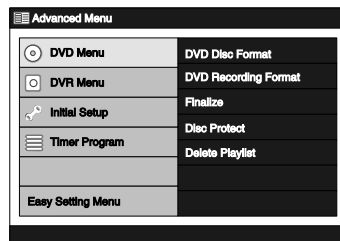

- 2 Using \wedge / \vee , select “Initial Setup”. Press **ENTER**.

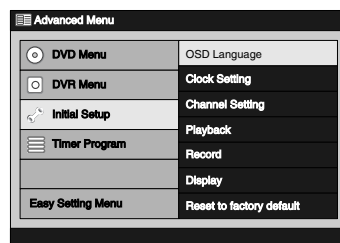

- 3 Using \wedge / \vee , select “OSD Language”. Press **ENTER**.

OSD Language Menu will appear.

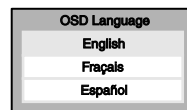

- 4 Using \wedge / \vee , select a language. Press **ENTER**.
Your setting is now activated.

- The default setting is “English”.

- 5 Press **SETUP** to exit.

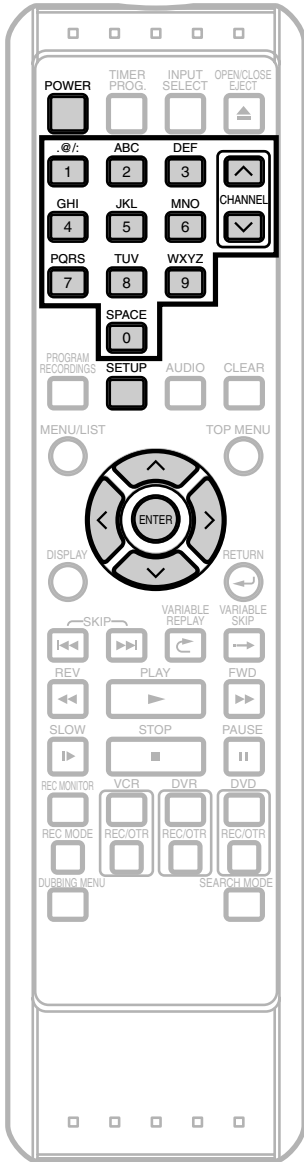

Getting Channels Automatically

If you have already set the channels when you first turned on the unit, you can skip this section.

After resetting the settings or whenever you move to a new area, we recommend you to program available channels in your area with the following procedures.

- 1 Press **POWER**.
- 2 Turn on the TV. Select the appropriate external input channel. (See page 18.)

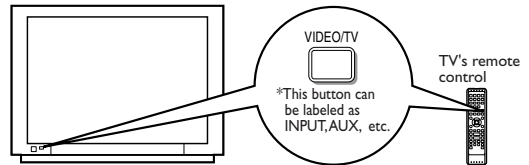

- 3 Press **SETUP**.
“Easy Setting Menu” or “Advanced Menu” will appear.

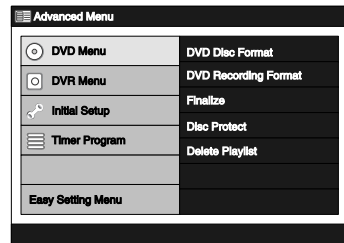

- 4 Using \wedge / \vee , select “Initial Setup”. Press **ENTER**.

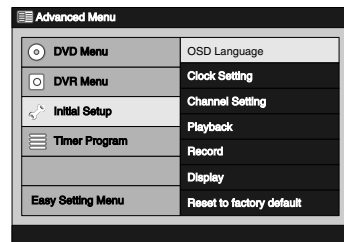

- 5 Using \wedge / \vee , select “Channel Setting”. Press **ENTER**.

Channel Setting Menu will appear.

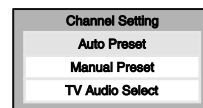

Channel Setting (Cont'd)

- 6** Using \wedge / \vee , select **“Auto Preset”**. Press **ENTER**.
The unit will start getting channels available in your area.

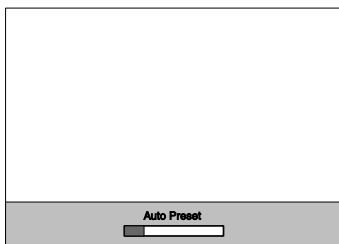

Wait for several minutes for channel scanning to finish.

After Auto Preset has stopped:

- Use **CHANNEL** \wedge / \vee or the **Number Buttons** to change the channel.
- When you use **the Number Buttons**, press **0** first for a single digit number.
- Use **INPUT SELECT** to select an external input channel (“L1” or “L2”) of this unit.

- 3** Using \wedge / \vee , select **“Channel Setting”**. Press **ENTER**.

Channel Setting Menu will appear.

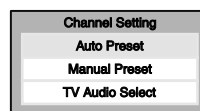

- 4** Using \wedge / \vee , select **“Manual Preset”**. Press **ENTER**.

Option window will appear.

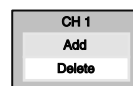

- 5** Using \lt / \gt , select the channel number to add or delete.

- Use \lt / \gt or **CHANNEL** \wedge / \vee to change the channels one by one, or use **the Number Buttons** to select the channel directly.

- 6** Using \wedge / \vee , select **“Add”** or **“Delete”**. Press **ENTER**.

The channel number will be added or deleted from the channel memory. Then, the next channel number will appear so that you can continue adding or deleting channels.

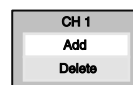

- 7** Press **SETUP** to exit.

Adding / Deleting Channels

The channels you no longer receive or seldom watch can be deleted from the memory. You can also add channels manually into memory.

- 1** Press **SETUP**.
“Easy Setting Menu” or “Advanced Menu” will appear.

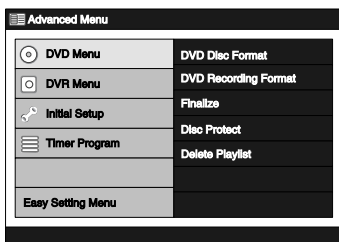

- 2** Using \wedge / \vee , select **“Initial Setup”**. Press **ENTER**.

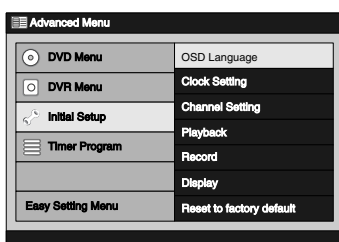

Note

- External Input Channels (“L1” or “L2”) cannot be skipped.
- You cannot change the channel while the unit (DVR, VCR or DVD) is in the recording, OTR or Timer Recording mode.
- If the auto presetting is cancelled during presetting, some of the channels not yet preset may not be received.
- The selection will depend on how you receive the TV channels.
- To cancel the Auto Preset during scanning: Press **RETURN** \leftarrow .

Initial Setups

Clock Setting

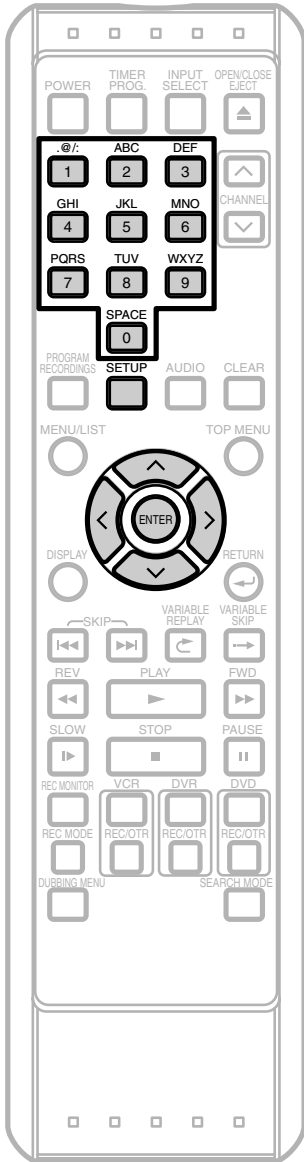

If you have already set the Clock when you first turned on the unit, you can skip this section.

Set the clock before you try Timer Recording. If Public Broadcasting Service (PBS) is available in your area, follow the Auto Clock Setting below. If not, refer to 'Manual Clock Setting' on page 25.

Make sure the antenna / cable TV connections are correct.

- You cannot set the clock while the unit is in the recording, OTR or Timer Recording mode.

Auto Clock Setting

If this unit is connected to a Cable Box or Satellite Box, select the local PBS station to set the clock automatically.

- 1 Press **SETUP**.
"Easy Setting Menu" or "Advanced Menu" will appear.

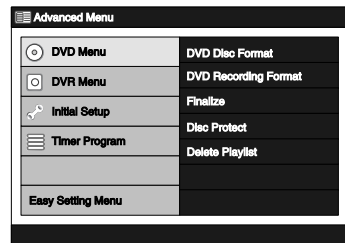

- 2 Using \wedge / \vee , select "**Initial Setup**". Press **ENTER**.

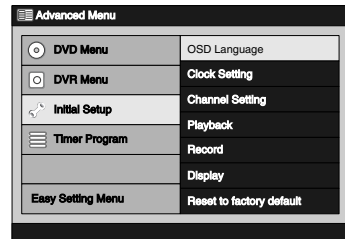

- 3 Using \wedge / \vee , select "**Clock Setting**". Press **ENTER**.

Clock Setting Menu will appear.

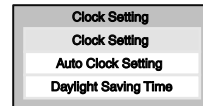

- 4 Using \wedge / \vee , select "**Auto Clock Setting**". Press **ENTER**.

Option window will appear.

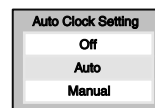

Clock Setting (Cont'd)

5 If you do not know the PBS channel number in your area :

Using \wedge / \vee , select **"Auto"**. Press **ENTER**.
Your setting is now activated.

If you know the PBS channel number in your area :

Using \wedge / \vee , select **"Manual"**. Press **ENTER**.
Input window will appear.



Using the **Number Buttons** or \wedge / \vee , enter the PBS channel number. Press **ENTER**.
Your setting is now activated.

If you want to set the clock manually and to cancel the Auto Clock Setting :

Using \wedge / \vee , select **"Off"**. Press **ENTER**.
The Auto Clock Setting will be canceled.

- The default setting is **"Auto"**.

6 Press **SETUP** to exit.

7 Press **POWER** to turn off the unit.

This unit will search for the clock time only when the power is off. Leave it off for several minutes to give the unit a time to set the clock.

Note

- The clock may set itself automatically after you connect the antenna / cable signal to this unit and plug in the power cord. In this case, the current time will appear on the Front Panel Display.
- If the current time is not displayed or the displayed clock time is not correct, set the clock manually.

Manual Clock Setting

- 1 Press **SETUP**.
"Easy Setting Menu" or "Advanced Menu" will appear.

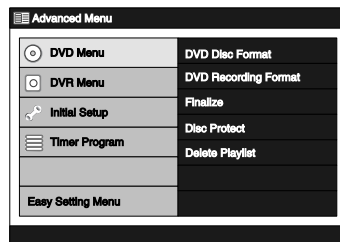

- 2 Using \wedge / \vee , select **"Initial Setup"**. Press **ENTER**.

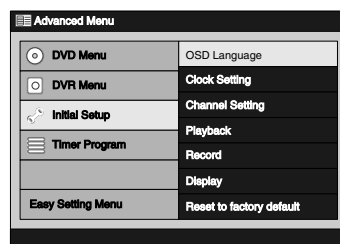

- 3 Using \wedge / \vee , select **"Clock Setting"**. Press **ENTER**.

Clock Setting Menu will appear.

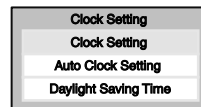

- 4 Using \wedge / \vee , select **"Clock Setting"**. Press **ENTER**.

Clock Setting Window will appear.

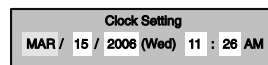

- 5 Using \lt / \gt , move to the item you want to set, and using \wedge / \vee , change the setting to suite your preference.

- 6 When all the information is entered, press **ENTER**.
Your setting is now activated.

Although seconds are not displayed, they will be counted from zero.

- 7 Press **SETUP** to exit.

Note

- Your clock setting will be lost if either there is a power failure or this unit has been unplugged for more than 30 seconds.

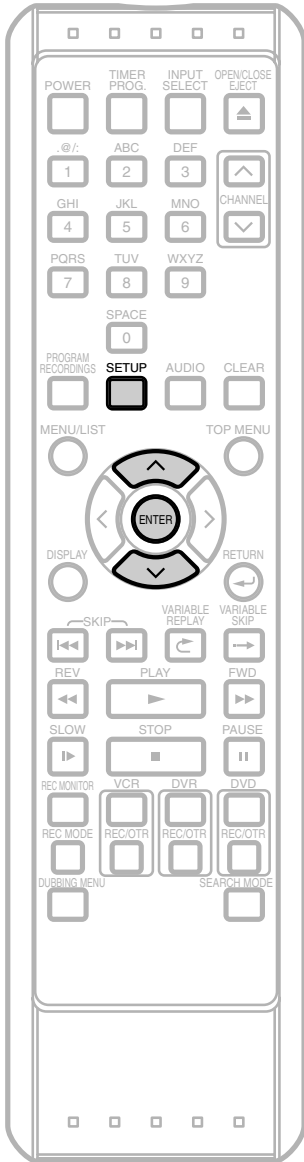

Setting Daylight Saving Time

When Daylight Saving Time is on, the clock will automatically move forward one hour at 2:00 a.m. on the first Sunday in April and move back one hour at 2:00 a.m. on the last Sunday in October.

- 1 Press **SETUP**.
“Easy Setting Menu” or “Advanced Menu” will appear.

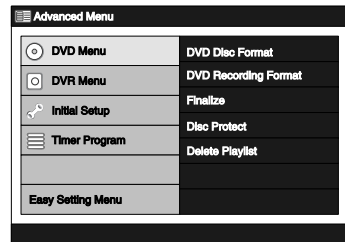

- 2 Using \wedge / \vee , select “Initial Setup”. Press **ENTER**.

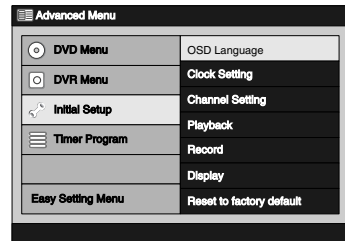

- 3 Using \wedge / \vee , select “Clock Setting”. Press **ENTER**.

Clock Setting Menu will appear.

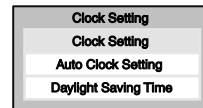

- 4 Using \wedge / \vee , select “Daylight Saving Time”. Press **ENTER**.

Option window will appear.

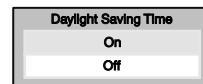

- 5 Using \wedge / \vee , select “On” to activate the Daylight Saving Time. Press **ENTER**.

If you do not want to use the Daylight Saving Time feature select “Off”.

- The default setting is “On”.

- 6 Press **SETUP** to exit.

TV Audio Setting

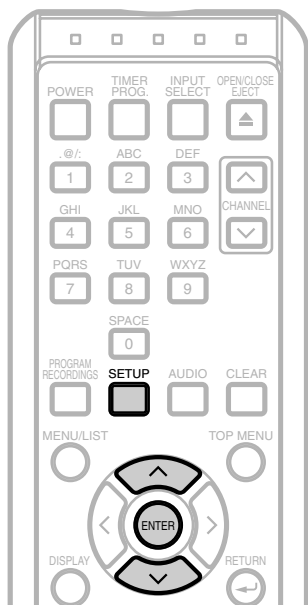

Note

- This unit CANNOT record in both stereo and SAP (Secondary Audio Program) at the same time.

SAP (Secondary Audio Program);

- SAP is the Secondary Audio Program which is usually used as an alternate in bilingual broadcasting, such as a broadcasting in Spanish. The SAP signal is delivered using the sub-audio channel. While the main-audio channel has 2 channels for L & R, the sub-audio channel has only 1 channel. Therefore, the SAP will always be broadcasted in monaural sound (outputting the same sound from the left and the right speakers).

Notes on TV channel audio

- If you want to record a TV program available in second audio or stereo on DVR, DVD-RW/R discs or videotape, you have to select either “Stereo” or “SAP” beforehand. Refer to the following table to check the appropriate setting.

Broadcast audio		Selected audio	DVR/DVD/VCR recording
Main-audio channel	Sub-audio channel		
STEREO	SAP	Stereo	STEREO
STEREO	NONE		STEREO
MONO	SAP		MONO
MONO	NONE		MONO
STEREO	SAP	SAP	SAP
STEREO	NONE		STEREO
MONO	SAP		SAP
MONO	NONE		MONO

- You can only play back the disc in second audio if a TV program is available in second audio and you set TV Audio Select to SAP.

You can select an audio channel to output from TV.

- 1 Press **SETUP**.

“Easy Setting Menu” or “Advanced Menu” will appear.

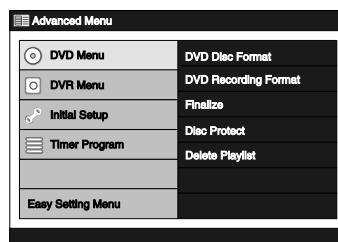

- 2 Using \wedge / \vee , select “Initial Setup”. Press **ENTER**.

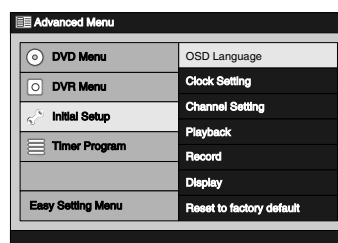

- 3 Using \wedge / \vee , select “Channel Setting”. Press **ENTER**.

Channel Setting Menu will appear.

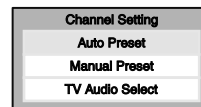

- 4 Using \wedge / \vee , select “TV Audio Select”. Press **ENTER**.

Option window will appear.

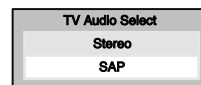

- 5 Using \wedge / \vee , select “Stereo” or “SAP”. Press **ENTER**.

Stereo:

Outputs main-audio.

SAP (Secondary Audio Program):

Outputs sub-audio.

Refer to the item in ‘Glossary’ on page 134 for more information.

- The default setting is “Stereo”.

- 6 Press **SETUP** to exit.

TV Aspect Ratio Setting

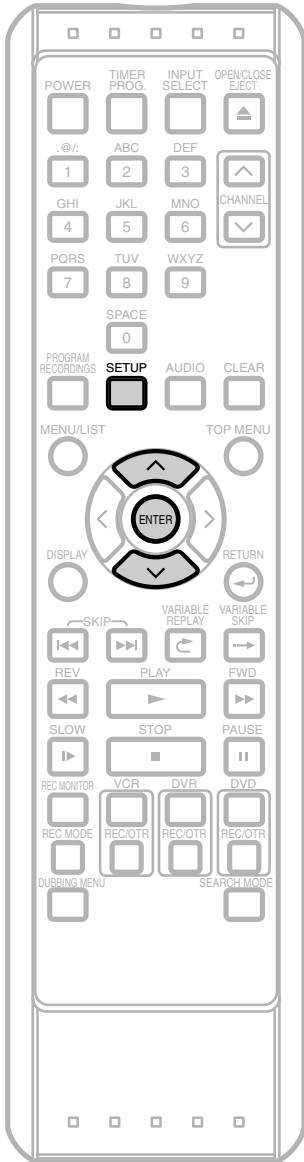

You can select the TV aspect ratio to match the formats of what you are playing back on the unit and your TV screen (4:3 standard or 16:9 widescreen TV).

1 Press **SETUP**.

“Easy Setting Menu” or “Advanced Menu” will appear. If “Advanced Menu” is displayed, proceed to step 3.

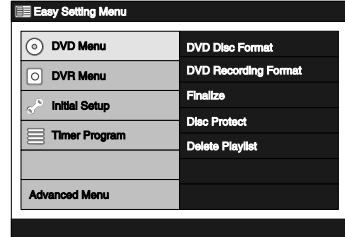

2 Using \wedge / \vee , select “Advanced Menu”. Press **ENTER**.

3 Using \wedge / \vee , select “Initial Setup”. Press **ENTER**.

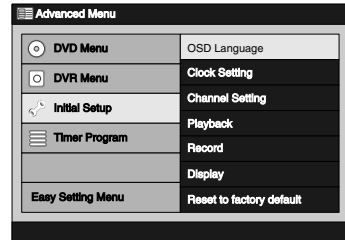

4 Using \wedge / \vee , select “Playback”. Press **ENTER**. Playback Menu will appear.

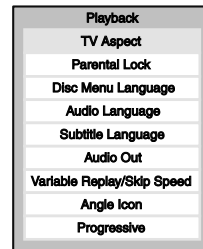

5 Using \wedge / \vee , select “TV Aspect”. Press **ENTER**. Option window will appear.

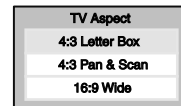

6 Using \wedge / \vee , select a desired option. Press **ENTER**. Your setting is now activated.

- The default setting is “4:3 Letter Box”.

7 Press **SETUP** to exit.

Note

- If you have a standard TV:
Select “**4:3 Letter Box**” for full-length picture with black bars on the top and bottom of the screen.
Select “**4:3 Pan & Scan**” for a full-height picture with both sides trimmed.
- If you have a widescreen TV:
Select “**16:9 Wide**”.

Information on Supported Media

Media types

☆☆☆ : Most suitable. ☆☆ : Can be used. ☆ : Some functions are limited. — : Cannot be used.

You want to	DVR	DVD-RW VR	DVD-RW Video	DVD-R	VCR
Record TV programs	☆☆☆	☆☆☆	☆☆☆	☆☆	☆☆☆
Reuse by deleting unwanted contents	☆☆☆	☆☆☆	☆☆	—	☆☆
Edit recorded contents	☆☆☆	☆☆☆	☆	☆	—
Edit/Record from connected equipment	☆☆☆	☆☆☆	☆☆☆	☆☆☆	☆ ^{*2}
Copy discs for distribution	—	☆☆ ^{*1}	☆☆☆	☆☆☆	—
Play on other DVR(HDD)/DVD/VCR equipment	—	☆☆ ^{*1}	☆☆☆	☆☆☆	☆☆☆

*1 VR mode DVD-RW can only be played on DVD equipment that is VR compatible.

*2 Programs can be recorded from other equipment, but they cannot be edited.

Features	DVR	DVD-RW VR	DVD-RW Video	DVD-R	VCR
Recording					
Rewritable	Yes	Yes	Yes	No	Yes
Can create chapters at fixed intervals (auto.)	Yes	Yes	Yes	Yes	No
Can create chapters wherever you like (manual)	Yes	Yes	No	No	No
Can record 16:9 size pictures	Yes	Yes	Yes	Yes	No
Can record copy-once programs	Yes	Yes ^{*1}	No	No	Yes
Editing					
Can perform basic edit functions	Yes	Yes	Yes	Yes	No
Can perform advanced edit functions (Playlist edit)	Yes	Yes	No	No	No

*1 CPRM compatible disc only.

Note: For details of the above functions and implied restrictions, see the explanations inside the manual.

Information

This unit can record on DVD-RW discs and DVD-R discs.

DVD-R discs allow you to record programs only once, and the recorded contents cannot be erased.

DVD-RW discs allow you to record programs repeatedly, and the recorded contents can be erased.

There are 2 recording format, VR mode and Video mode, for DVD-RW discs while there is only one recording format, Video mode, for DVD-R discs.

VR mode is the basic recording format for the DVD-RW disc. It is suited for editing the recorded contents, and playable only on the DVD-RW compatible unit. VR mode disc has both Original List and Playlist, and creates the Playlist automatically when programs (titles) are recorded.

Video mode is the same recording format as those DVD-Video discs purchased locally.

Video mode disc can be played back on most DVD players. Although the available editing menus are limited compare to the VR mode disc, you still can add or delete the recordings, or edit the contents before finalizing. Video mode disc has only Original List, and creates the DVD Menu automatically when it is finalized.

Logo

Attributes



DVD-RW

8 cm / 12 cm, single-sided, single layer disc
Approx. max. recording time (SEP mode):

600 minutes (4.7 GB) (for 12 cm)

180 minutes (1.4 GB) (for 8 cm)



DVD-R

Recordable disc

Discs which can be used with this recorder:

- **DVD-R disc: up to 16x (4x or 8x disc is recommended)**
- **DVD-RW disc: 2x and 4x (2x disc is recommended)**

Discs tested and proven to be compatible with this recorder:

MAXELL DVD-R disc 4x TDK DVD-RW disc 2x
JVC DVD-RW disc 4x VERBATIM DVD-R disc 8x

Disc type	Disc format	Functions
	Video mode 	Playback, limited recording, limited editing
DVD-RW	VR mode 	Playback, recording, Original List / Playlist editing
	Video mode 	Playback, limited recording, limited editing
DVD-R		

DVD players with **RW** are capable of playing DVD-RW disc recorded in VR mode.

Before you start

Connections

Initial Setups

Recording / Dubbing

Playback

Editing

Other Setups

VCR functions

Others

Español

Information on Supported Media (Cont'd)

Rec Mode

You can select a Rec Mode among 6 options, and the recording time and the picture/audio quality of recorded material depends on the Rec Mode you select.

Disc Size	Rec Mode	Recording time	Video / Sound Quality
8 cm Disc	XP	18 min	☆☆☆☆☆☆ (good)
	SP	36 min	☆☆☆☆☆
	LP	72 min	☆☆☆☆
	EP	108 min	☆☆☆
	SLP	144 min	☆☆
	SEP	180 min	☆ (poor)
12 cm Disc	XP	60 min	☆☆☆☆☆☆ (good)
	SP	120 min	☆☆☆☆☆
	LP	240 min	☆☆☆☆
	EP	360 min	☆☆☆
	SLP	480 min	☆☆
	SEP	600 min	☆ (poor)
DVR	XP	17 H	☆☆☆☆☆☆ (good)
	SP	34 H	☆☆☆☆☆
	LP	68 H	☆☆☆☆
	EP	102 H	☆☆☆
	SLP	136 H	☆☆
	SEP	170 H	☆ (poor)

To select the Rec Mode you prefer, press **REC MODE**. The information of the selected media (DVR or DVD) will be displayed.

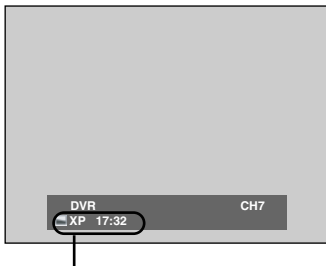

Indicates the remaining time of the disc when recorded with the selected Rec Mode.

Press **REC MODE** repeatedly to change the Rec Mode. The speed will be changed each time you press it with the following order:

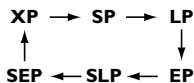

The information will disappear in a few seconds, or press **DISPLAY** to exit.

- * The recording time is an estimate and actual recording time may differ.
- * Audio and video quality decreases as the recording time becomes longer.
- * Each time you press **REC MODE**, remaining recording time is displayed.

Note

- This recorder cannot record on CD-RW or CD-R discs.
- DVD-RW/R discs and CD-RW/R discs recorded on a personal computer or a DVD or CD recorder may not be played back if the disc is damaged or dirty or if there is dirt or condensation on the player's lens.
- If you record on a disc using a personal computer, there are cases in which it may not be played back because of the settings of the application software used to create the disc, even if it is recorded in a compatible format. (Check with the software publisher for more detailed information.)
- Discs recorded in Video mode on this unit cannot record additionally using other DVD recorders.
- Since the recording is made by the variable bit rate (VBR) method, the actual remaining time for recording may be a little bit shorter than the remaining time displayed on the OSD, depending on the picture you are recording.
- Playlist will be created automatically when recording to VR mode DVD-RW disc and DVR.

About DVD+RW/R discs

- You cannot use DVD+RW/R disc for recording.
- Only the finalized Video mode DVD+RW/R discs can be played back on this unit.
- If you insert a blank DVD+RW/R disc, an error message will appear.
- The performance of DVD+RW/R discs on this unit is not guaranteed.

Restrictions on recording

You cannot record copy protected discs or tapes using this unit. Copy protected material includes DVD-Video and some satellite broadcasts.

If copy protected material is encountered during a recording, recording will be paused or stop automatically and an error message will be displayed on-screen.

Copy-once programs can only be recorded on the DVR or on a CPRM compatible VR mode DVD-RW disc (see below).

Maximum Recordable numbers of title / chapters

- DVR:** 300 titles per each Playlist and Original List
999 chapters per title
- VR mode DVD:** 99 titles per each Playlist and Original List
999 chapters per each Playlist and Original List
- Video mode DVD:** 99 titles per disc
99 chapters per title

Information on Supported Media (Cont'd)

What is CPRM?

This is a format used to record copy-once programs. By recording coded data on the area of discs that ordinary writing software cannot write, it prevents copy-once programs from being recorded repeatedly on different media.

This unit is CPRM compatible, which means that you can record copy-once broadcast programs, but then you cannot make a copy of those recordings. CPRM recordings can only be made on the DVR or VR mode DVD-RW disc, and CPRM recordings can only be played back on DVD players that are compatible with CPRM.

Information on copy control

Some satellite broadcasts include copy protected information. For their recording, refer to the following.

Disc type / format	Copy-free	Copy-once	Copy-prohibited
DVR	☆	☆	—
VR DVD-RW ver.1.1,1.2	☆	—	—
ver.1.1,1.2 CPRM compatible	☆	☆	—
Video DVD-RW ver.1.1,1.2	☆	—	—
ver.1.1,1.2 CPRM compatible	☆	—	—
DVD-R ver.2.0	☆	—	—
VCR	☆	☆	☆

☆ Recordable

— Not Recordable

Making discs playable on other DVD player (Finalize)

After recording, you must finalize the disc in order to play on other units. (See page 63.)

- * For Video mode discs, the finalization is required.
- * For VR mode discs, the finalization is recommended.
- * For the information on videotapes, refer to 'VCR functions' on pages 121-127.

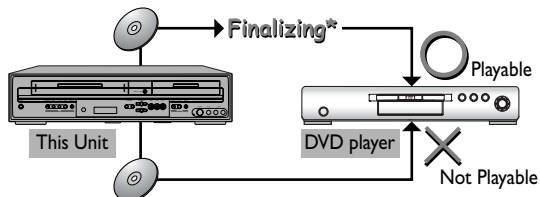

* You cannot finalize discs in other DVD recorders.

About DVR (HDD)

DVR is a special component which has high recording density and is suited for long-time recording or high-speed cueing but by contrast, has many factors which can cause breakage. Use DVR on the premise that you should dub the recorded programs to a DVD disc or a videotape to protect your precious videos.

DVR is a temporary storage location.

DVR is not a permanent storage location of the recorded contents. Be sure to use it as a temporary storage location until you watch the programs once, edit them, or dub them to a DVD disc or a videotape.

Be sure to dub (back up) data promptly if you find abnormalities in DVR.

If there is mechanical trouble with the DVR, grinding or other sounds may be heard or blocky noise may appear on the image. If you continue to use as it is, deterioration may continue and eventually the DVR may not be used at all. If you notice these symptoms of a failing DVR, promptly dub the data to a DVD disc or a videotape.

When an DVR fails, recovery of recorded content (data) may be impossible.

About the remaining capacity of DVR recording time:

In recording to DVR, the Remaining Capacity Display may differ from the actual recordable time as this unit adopts Variable Bit Rate encoding, which varies the recording (storage) amount of data in conformity with the information amount of video. Before recording to the DVR, ensure there is sufficient space on the DVR by deleting unnecessary titles in advance. (Remaining capacity will not increase if you only delete Playlists.)

Easy DVR / DVD Recording

The following will help you to understand easily how to record to the internal DVR or to DVDs.

Note: Make sure batteries are in the remote control and you have connected this unit and the TV correctly.

Step 1: Choose a disc type & the Recording Format. (Only if you are recording to DVD.)

There are several types of recordable DVDs to choose from. Choose a recordable disc type based on your playback / recording / editing needs. Refer to 'Information on Supported Media' on pages 29-31 to determine which disc type is most suited for your needs. Also, refer to page 34 to set the Recording Format for your disc.

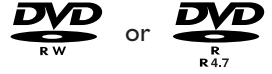

This unit can record on the type of discs on the right.

Step 2: Preparing the media

1 Turn on the unit.

2 Select the device you want to use. (If you are recording to the DVR, skip to step 3 on the next page.)

3 Open the disc tray, and place a disc on the tray.

4 Close the disc tray.

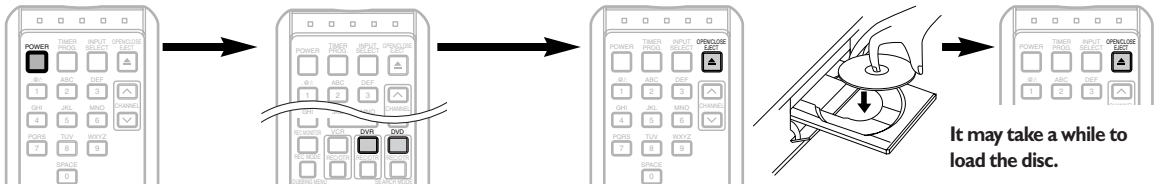

• If you load a brand new DVD-RW disc, Auto Format will start automatically.

Continue on the next page.

Note

DVR is a temporary storage location.

• DVR is not a permanent storage location of the recorded contents. Be sure to use it as a temporary storage location until you watch the programs once, edit them, or dub them to a DVD disc or a videotape.

Step 3: Select the Rec Mode.

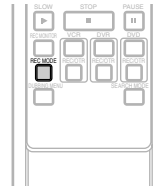

Step 4: Select the desired channel to record.

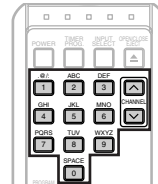

Step 5: Start Recording.

- When recording to the DVR:
Press **REC / OTR** (DVR).
- When recording to the DVD:
Press **REC / OTR** (DVD).

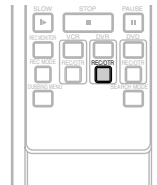
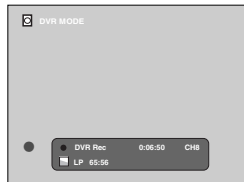

or

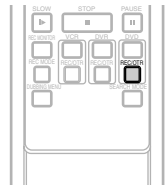

Step 6: Stop Recording.

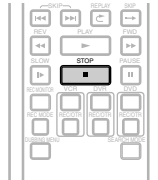
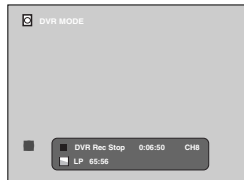

This operation may take a while to be recognized.

Formatting a Disc

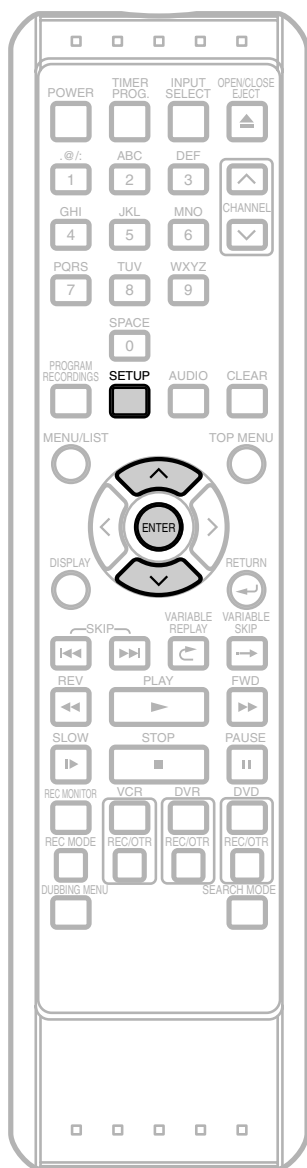

Selecting the Recording Format Type



Selecting the recording format type

The recording format type you set here will be memorized and applied to the disc whenever you format DVD-RW discs.

- 1 Press **SETUP**.
“Easy Setting Menu” or “Advanced Menu” will appear.

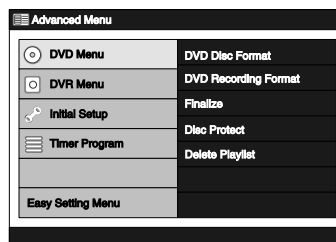

- 2 Using \wedge / \vee , select “DVD Menu”.
Press **ENTER**.
- 3 Using \wedge / \vee , select “DVD Recording Format”.
Press **ENTER**.
Option window will appear.

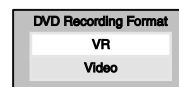

- 4 Using \wedge / \vee , select “VR” or “Video”.
Press **ENTER**.
Your setting is now activated.
• The default setting is “Video”.

Auto Format

Whenever you load a brand new DVD-RW disc, the unit will automatically format the disc in the recording format type you set in this section.

The following message will appear if a Timer Recording is programmed to start in 15 minutes:
“In the middle of programming timer. Format disc?”

If you select “Yes”, the formatting process will continue. If you select “No”, or do not replay in 1 minute, the formatting will not be performed.

Auto Format will not be performed under the conditions listed below;

- During DVR Playback or recording.

Note

- The Recording Format Setting is effective only for DVD-RW discs. You cannot change the recording format for a DVD-R disc. DVD-R discs will always be in Video mode.
- **You cannot mix two formats on one DVD-RW disc. When you load a disc once recorded before, the recording format cannot be changed even if you change it in the Setup Menu.**

Formatting a Disc (Cont'd)

Formatting a Pre-Recorded Disc (Disc Format)



If you format a pre-recorded disc, all the data contained in it will be erased and the disc will return to the blank media status. **This feature is only available with the DVD-RW disc.**

- 1 Press **SETUP**.
“Easy Setting Menu” or “Advanced Menu” will appear.

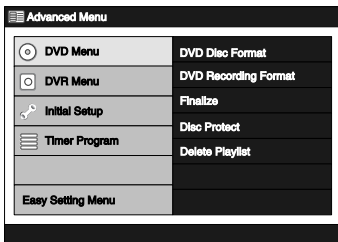

- 2 Using \wedge / \vee , select “DVD Menu”. Press **ENTER**.

- 3 Using \wedge / \vee , select “DVD Disc Format”. Press **ENTER**.
Confirmation window will appear.

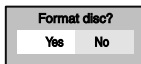

- 4 Using \langle / \rangle , select “Yes”. Press **ENTER**.
Final confirmation window will appear.

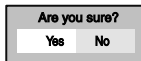

- 5 Using \langle / \rangle , select “Yes”. Press **ENTER**.
Formatting will start.
The progress bar extends depending on the progress status of formatting.

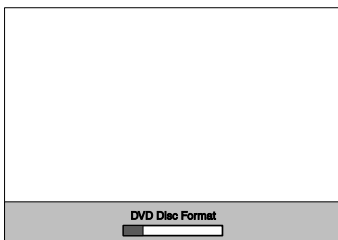

- 6 Formatting is complete when the progress bar reaches to the right end.

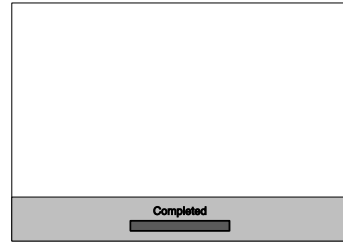

The screen returns to normal after formatting is completed.

This operation may take a while to be completed.

Note

- When you reformat the disc, all contents of the disc will be erased.
- A disc once formatted with this unit cannot be used on other DVD recorders unless finalized.

Monitoring the Recording Quality

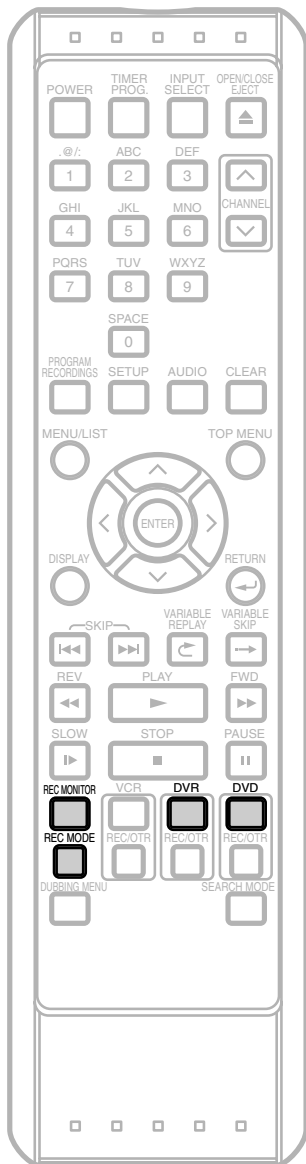

With **REC MONITOR**, you can check how the actual recording picture and the sound quality will be in the selected Rec Mode before attempting to record.

If you are recording to the DVR, press **DVR** first.
If you are recording to a disc, press **DVD** first.

- 1 While in the stop mode, press **REC MONITOR**.

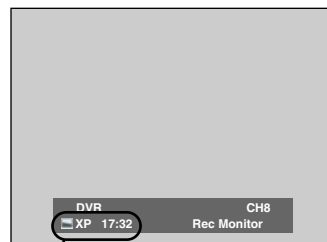

Indicates the remaining time of the disc when recorded with the selected Rec Mode.

- 2 Press **REC MODE** repeatedly to change the Rec Mode.

The Rec Mode will be changed as you press the button as shown below. Refer to 'Rec Mode' on page 30.

- You cannot change the Rec Mode during recording.

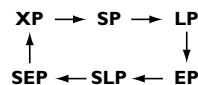

- 3 Press **REC MONITOR** again to exit.

Creating Chapter Marks Automatically

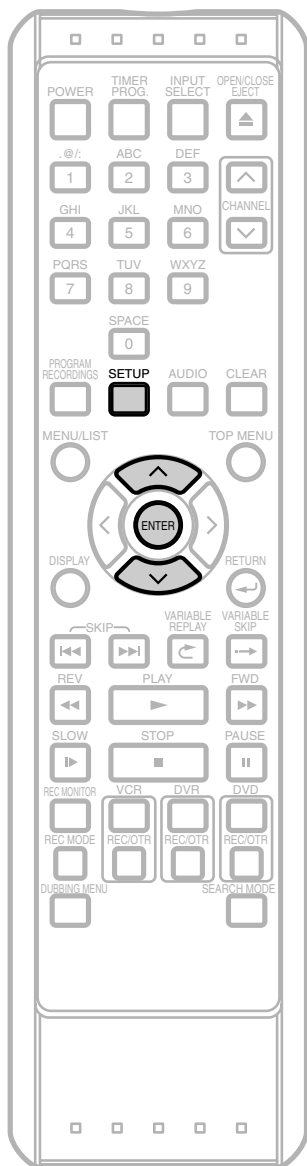

Notes for "Auto chapter"

- The actual setting time for chapter marks may differ from the time you selected in Video mode.
- Depending the recording time, a chapter with no image may be created at the end.
- Chapter marks will automatically be inserted at the set interval with "Auto Chapter". (Chapter marks will not be inserted while recording is paused.) For inserting chapter marks at other spots, refer to 'Chapter Marker' on pages 104-107.
- With Video mode DVDs discs, you cannot add / delete chapter marks.



You can sort out the recording by inserting chapter marks every set time interval.

- 1 Press **SETUP**.
"Easy Setting Menu" or "Advanced Menu" will appear.
If "Advanced Menu" is displayed, proceed to step 3.

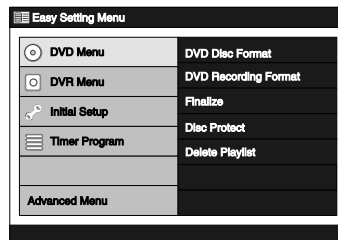

- 2 Using \wedge / \vee , select "Advanced Menu". Press **ENTER**.
- 3 Using \wedge / \vee , select "Initial Setup". Press **ENTER**.

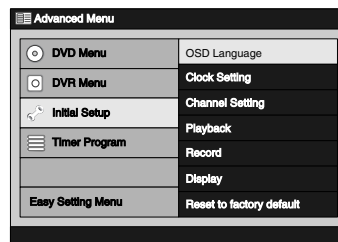

- 4 Using \wedge / \vee , select "Record". Press **ENTER**.
Record Menu will appear.

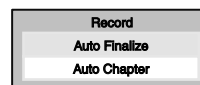

- 5 Using \wedge / \vee , select "Auto Chapter". Press **ENTER**.
Option window will appear.

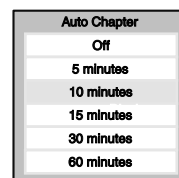

- 6 Using \wedge / \vee , select desired time option. Press **ENTER**.

Your setting is now activated.

- The default setting is "10 minutes".

- 7 Press **SETUP** to exit.

Basic Recording

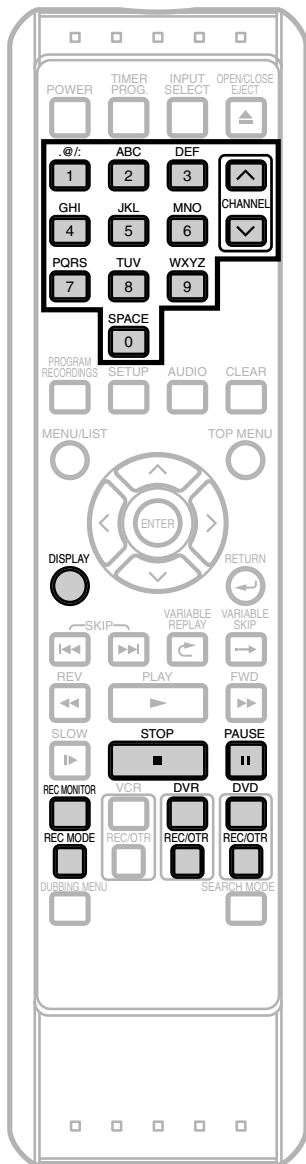

Follow steps below to record TV programs.

Use only the DVR or CPRM-compatible VR mode DVD-RW discs for recording copy-once programs. (See page 31.)

If you are recording to the DVR, press **DVR** first.

If you are recording to a disc, press **DVD** first.

Insert a recordable disc if you are recording to a DVD.

- 1** Turn on the TV. Select the appropriate external input channel. (See page 18.)
- 2** Using **REC MODE**, select a Rec Mode. Refer to 'Rec Mode' on page 30.
- 3** Using **CHANNEL** \wedge / \vee , or the **Number Buttons**, select a desired channel to record.



- 4** Press **REC / OTR** (DVR / DVD) to start recording. The information will be displayed for 5 seconds.

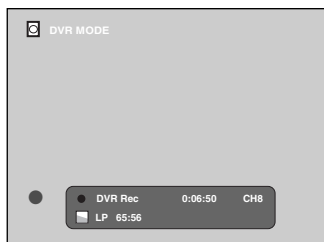

Press **PAUSE** \parallel to pause recording.

Press **REC / OTR** (DVR / DVD) or **PAUSE** \parallel to resume recording.

- 5** Press **STOP** \blacksquare to stop recording.

Note

- Recording starts immediately after you press **REC / OTR** (DVD) and continues until the disc is full or you stop recording.
- When the Clock Setting has not been made, the space for a date and time of title names in the Original List or Playlist will be blank.
- **When you record a TV program broadcasted in both Stereo and SAP-audio on a DVD-RW/R discs, you have to select the TV channel audio (Stereo or SAP) beforehand. Only the selected channel audio will be recorded. Refer to 'TV Audio Setting' on page 27 for more details.**
- Up to 300 titles can be recorded on the DVR.
- Up to 99 titles can be recorded on the DVD-RW/R discs.

One Touch Recording (OTR)



This is a simple way to set the recording time in blocks of 30 minutes.

If you are recording to the DVR, press **DVR** first.

If you are recording to a disc, press **DVD** first.

Preparing for OTR:

- Check that the recording media has enough recordable space for the time you set.
- If you are recording to a DVD, insert a recordable disc.
- Use only the DVR or CPRM-compatible VR mode DVD-RW discs for recording copy-once programs. (See page 31.)

1 Turn on the TV. Select the appropriate external input channel. (See page 18.)

2 Using **REC MODE**, select a Rec Mode.

Refer to 'Rec Mode' on page 30.

- You can check the current Rec Mode by pressing **REC MONITOR**.

3 Using **CHANNEL** \wedge / \vee or **the Number Buttons**, select a desired channel to record.

4 Press **REC / OTR** (DVR / DVD).
Recording will start.



5 Press **REC / OTR** (DVR / DVD) repeatedly to change the recording time.

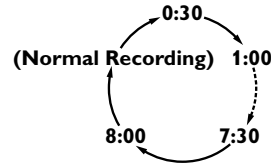
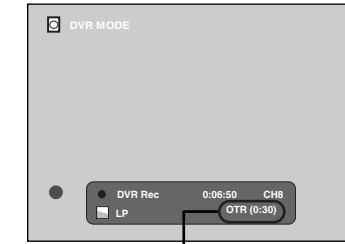

The recording time will be extended by 30 minutes every time you press **REC / OTR** (DVR / DVD).

- The maximum recording time is 8 hours.
- With DVR / DVD OTR, the recording time that exceeds the remaining time of the recording media will not be displayed.
- To change the recording time during the One Touch Recording, Press **REC / OTR** (DVR / DVD) repeatedly.

6 When OTR ends, the unit will turn off automatically except under conditions listed below.

- If a Timer Recording is programmed to start in 5 minutes.
- During playback of DVR / DVD / VCR.
- During recording of DVR / DVD / VCR.
- While displaying menus or information on the screen.
- To cancel the OTR in progress, press **STOP** ■.

Note

- The remaining recording time will be displayed on the Front Panel Display during a One Touch Recording. Press **DISPLAY** to see it on the TV screen.
- You cannot pause a One Touch Recording.
- The unit will turn off automatically under the following conditions.
 - When a power failure occurs.

Timer Recording

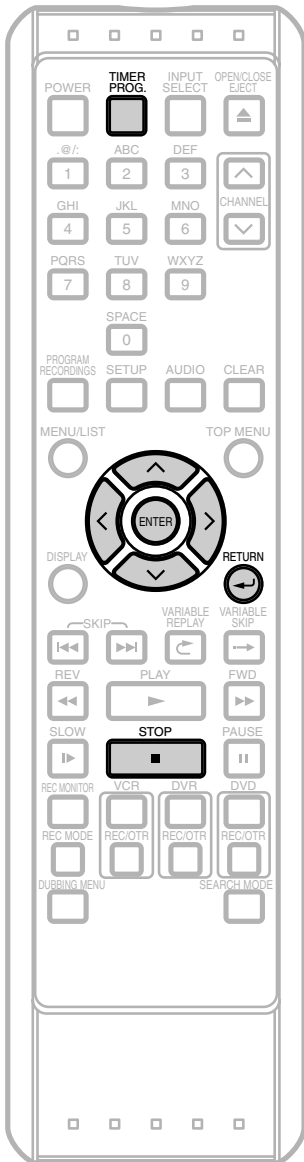

You can program the unit to record up to 32 programs within a month in advance. Daily or weekly recordings are available.

Preparing for Timer recording:

- Be sure to set the clock before programming a Timer Recording. Refer to 'Clock Setting' on pages 24-26.
- Check that the recording media (internal DVR or DVD) has enough recordable space for the time you set.
- Insert a recordable disc if you are recording to a DVD.

Use only the DVR or CPRM-compatible VR mode DVD-RW discs for recording copy-once programs.

1 Press **TIMER PROG.**

Timer Program List will appear.



- You can access this screen from the Setup Menu also.

2 Using \wedge / \vee , select a line indicated "New Program". Press **ENTER**.

Timer Programming Window will appear.

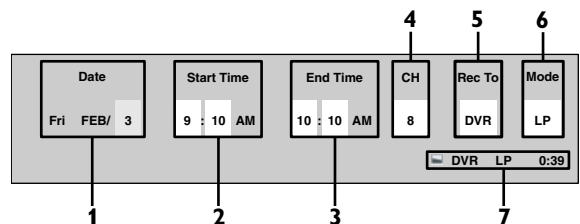

Timer Recording (Cont'd)

1 Recording Date:

When pressing ∇ at the current date, the setting will change as follows.

e.g.: January 1st

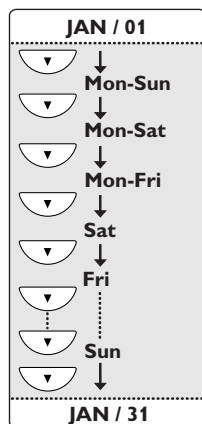

2 Start Time:

3 End Time:

4 Recording Channel:

To record from the external input, select “L1” or “L2”. (Using camcorder, or other source.)

5 Recording Media (DVR or DVD):

To record onto the DVR, select “DVR”.

To record onto a disc, select “DVD”.

VCR is not compatible with Timer Recording.

6 Rec Mode:

Refer to ‘Rec Mode’ on page 30.

7 Available recording time left on the DVR / DVD under the programmed Rec Mode.

- If there are more than one program, the recording time of the programs other than the one being edited currently will not be counted in the calculation of the total remaining time on the disc.

3 Using \leftarrow / \rightarrow , select an item to set and using \wedge / ∇ , set the contents to suit your preference.

- Pressing **RETURN** \leftarrow will resets all the information entered.

4 Press **ENTER** when all the information is entered.

\odot will appear in the Front Panel Display indicating one or more Timer Recordings are in standby.

- To set another program, repeat steps 2 to 4.
- When programs are overlapped, a warning message will appear. For details on overlapped Timer Programmings, refer to ‘Hints for Timer Recording’ on page 43.

5 To exit, press **TIMER PROG.**

- If you turn the unit off, it automatically turns on and starts recording 3 minutes before the Timer Recording begins, and when the recording is completed, you will be asked whether to turn off the unit. The unit will be turned off automatically if you select “Yes” or if you do not reply in 1 minute.
- To stop recording in progress, press **STOP** \blacksquare and hold it for 2 seconds, or press **STOP** \blacksquare on the front panel.

Relay Recording

If the disc runs out of the space during Timer Recording to a DVD, or if there is no recordable disc in the unit, it automatically detects it and change the recording media to the DVR. This feature is available only for Timer Recording. Not available for OTR.

Note

- If you have not set the clock yet:
The Clock Setting Window will appear at step 1 in stead of Timer Program List. Continue with step 4 in ‘Auto Clock Setting’ on page 24 or ‘Manual Clock Setting’ on page 25 before setting a Timer Recording.
- After step 5, you can use other devices as usual.
- If a basic recording or One Touch Recording is in progress on the VCR and the Timer Recording set for DVR or DVD is about to begin, the unit will automatically switch to the programmed channel 15 seconds before the programmed time, and the recording in progress on the VCR will be cancelled UNLESS their recording channel is the same. If their recording channel is the same, the Timer Recording for DVR or DVD will start without cancelling the recording currently in progress on the VCR. In this case, the recording of the same channel will be made on both VCR and the DVR or DVD.
- If the starting time and the end time are the same, it will be recognized as 24 hours recording.
- If the starting time you entered is already in the past, the recording will start as soon as you activate the Timer Recording by pressing **ENTER** at step 4.
- If the Timer Recording you want to make starts at 11:00 P.M., for example, and ends at 1:00 A.M. next day, enter the date of the starting time, then enter the starting time as 11:00 P.M. and end time as 1:00 A.M.

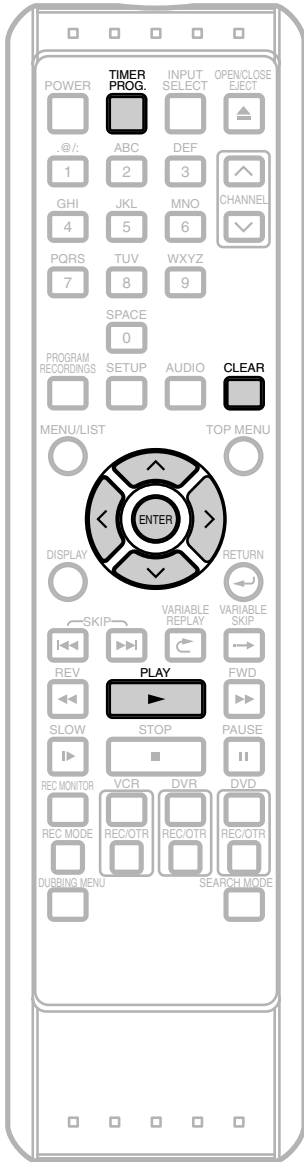

Editing the Timer Programming Information

- 1 Press **TIMER PROG.**

Timer Program List will appear.

TIMER PROGRAMMING 1/1						
Date	Start Time	End Time	CH	Rec To	Mode	
Fri FEB/3	9:10AM		DVR	LP	62:38	
Fri FEB/3	9:00AM	10:00AM	8	DVR	LP	
Fri FEB/3	9:30AM	10:30AM	6	DVR	LP	
Fri FEB/3	10:30AM	11:00AM	4	DVR	LP	

- 2 Using \wedge / \vee , select the program you want to edit. Press **ENTER**.

Editing Menu will appear.

Program Change
Edit Title Name
Delete

- 3 To change the setting of a program:

1. Using \wedge / \vee , select “Program Change”, then press **ENTER**.

Timer Programming Window will appear.

Date	Start Time	End Time	CH	Rec To	Mode
Fri FEB/ 3	9 : 30 AM	10 : 30 AM	6	DVR	LP

DVR LP 0:39

2. Using \lt / \gt , move to the item you want to change, then press \wedge / \vee to change the setting.

To edit a title name:

1. Using \wedge / \vee , select “Edit Title Name”, then press **ENTER**.

Editing Window will appear.

TIMER PROGRAMMING	
Space	A B C D E a b c d e
Right	F G H I J f g h i j
Left	K L M N O k l m n o
BS	P Q R S T p q r s t
Clear	U V W X Y u v w x y
	Z z
	1 2 3 4 5 6 7 8 9 0
	! " # \$ % & ' () * + , - . / : ; < = > ? [\] ^ _ { } ~
	Decide Return

2. By following the steps in ‘Guide to Edit Title Name’ on page 95, edit the title name. When you finish entering the title name, press **PLAY**. Or using $\wedge / \vee / \lt / \gt$, select “Decide”, then press **ENTER**.

Timer Recording (Cont'd)

To delete a program from the list:

- Using \wedge / \vee , select “Delete”, then press **ENTER**.

Confirmation window will appear:



You can access this screen by pressing **CLEAR** instead of **ENTER** at step 2.

- Using \lt / \gt , select “Yes” if you want to delete the title.

4 Press **TIMER PROG.** to exit.

Note

- As to the timer program in progress (which is shown in red in the Timer Program List), you only can edit the end time. The changes made during recording will be recognized as only specific to that recording in progress and it will not affect the daily or the Weekly Recording Setting.

Hints for Timer Recording

The priority of overlapped settings

When the timer programmings are overlapped, you will receive a warning message.

If this happens, check the timer programming and change the programming as necessary. Otherwise, the unit will prioritize recording as described below.

Same start time and different end time:

The program set first has the priority.

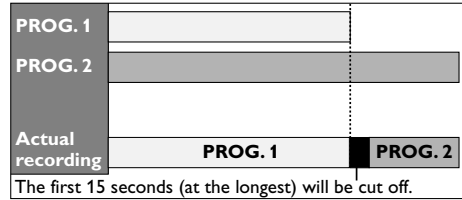

Different start time and different end time:

A program with the earlier start time has the priority.

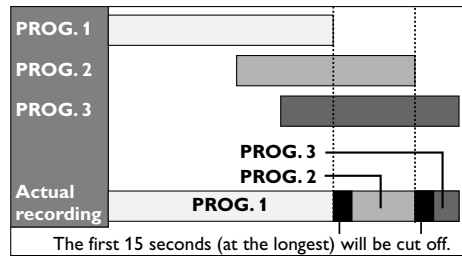

Recording time is entirely overlapped:

PROG. 2 will not be recorded.

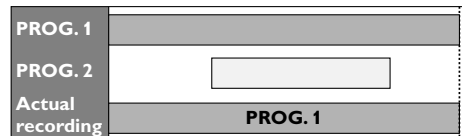

End time of Program 1 is the same as the start time of Program 2:

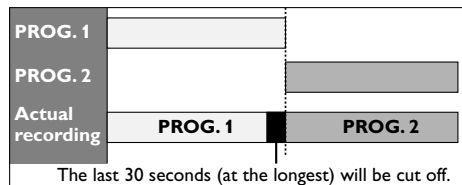

The amount of time cut off differs depending on the recording media.

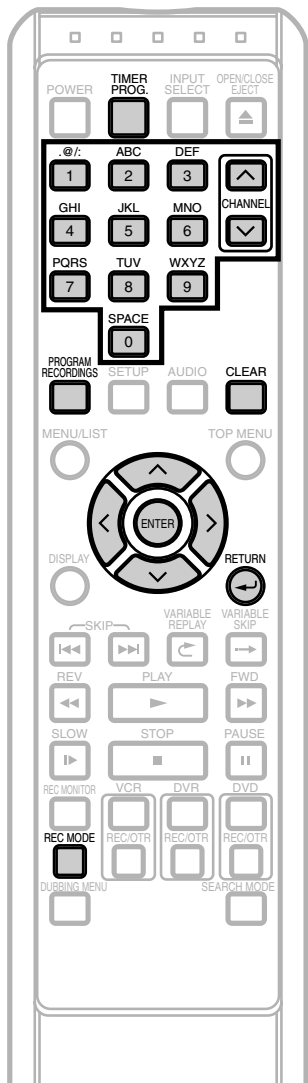

Guide to the Programmed Recordings Screen



With the Recording & Playback Navigator, you can easily program the Timer Recordings for the DVR by using the calendar displayed on the screen. Also the recorded titles (programs) can be played back or edited just by selecting the titles on the display.

- The Recording & Playback Navigator is only available for the DVR Original List.
- When you press **PROGRAM RECORDINGS**, the Programmed Recordings Screen will be displayed on the TV screen.

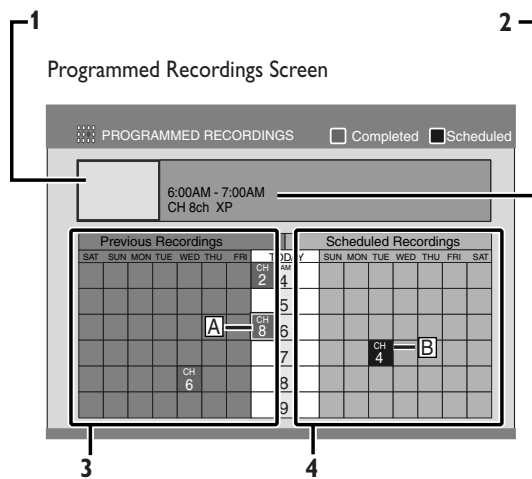

1 Preview window:

Playback the preview of recorded programs.

2 Information:

Shows the information on the selected program.

3 Previous recordings:

When the normal recording / Timer Recording has started, the cell turns blue and the channel number will be displayed. (e.g. [A])

4 Scheduled Recordings:

When a programming is completed, the cell turns pink and the channel number will be displayed. (e.g. [B])

Programmed Recordings Screen shows a two-week calendar. (One week prior to and one week after the current day.)

- Programmed Recordings can be programmed in this screen for programs broadcasted during next week.
- If more than one week has passed since recording, the recorded programs cannot be replayed or edited with Programmed Recordings.
- The screen describes each day as a day of the week, other than TODAY.

Note

- With the Recording & Playback Navigator, you can program Timer Recordings up to one week ahead. The recordings programmed for the days more than one week ahead will not be displayed in the Programmed Recordings Screen.
- You can program more than 1 Timer Recordings in one cell, but only the timer program that has the earlier starting time will be displayed in the Programmed Recordings Screen.
- To see all the programs entered in a cell, press **REV** ◀◀ or **FWD** ▶▶.
- If power is failed or unplugged from the outlet, some information in the Programmed Recordings Screen may be lost.
- Only the titles in the DVR Original List can be played back using the Recording & Playback Navigator.

Recording & Playback Navigator (Cont'd)

Programming a Recording with the Recording & Playback Navigator



Before programming, be sure to select the desired Rec Mode. (See page 36 on how to select the Rec Mode.)

- 1 Press **PROGRAM RECORDINGS**.
Switches to the DVR mode, and the Programmed Recordings Screen will appear.

- 2 Using $\wedge / \vee / \lt / \gt$, select the desired cell.
• For example, to record from 4:00 pm two days from the present day, choose the cell as follows.

ordings			Scheduled Recordings						
THU	FRI	TODAY	SUN	MON	TUE	WED	THU	FRI	SAT
		PM 3							
		4							
		5							

Present day Tomorrow Day after tomorrow

There are two ways to program a recording.

- 1) Direct Program---Press **CHANNEL** \wedge / \vee or **the Number Buttons** to select a channel. Press **ENTER**. The cell turns pink indicating that the timer programming is now set in that cell. Press **PROGRAM RECORDINGS** to exit.
- 2) Detailed Program---Press **ENTER** "New Program" will appear. With "New Program" selected, press **ENTER** again. Timer Programming Window will appear.

Date	Start Time	End Time	CH	Rec To	Mode
Fri FEB/ 3	9 : 00 AM	10 : 00 AM	8	DVR	LP
DVR LP 0:39					

Enter the necessary information by following the instructions described in 'Timer Recording' on pages 40-43.

To Change or Cancel the Program



- 1 Repeat steps 1-2 above.
- 2 Press **ENTER** to call up the menu window.

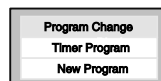

- 3 **To change the program**
Using \wedge / \vee , select "Program Change", then press **ENTER**.
Timer Programming Window will appear. Correct the information, then press **ENTER**.

To cancel the program

Using \wedge / \vee , select "Timer Program", then press **ENTER**.
Timer Programming List will appear.
Press **CLEAR**.

Confirmation window will appear. Select "Yes", and press **ENTER**.

To program a new Timer Recording

Using \wedge / \vee , select "New Program", then press **ENTER**.

- 4 Press **TIMER PROG.** to exit.

Before you start

Connections

Initial Setups

Recording / Dubbing

Playback

Editing

Other Setups

VCR functions

Others

Español

Recording & Playback Navigator (Cont'd)

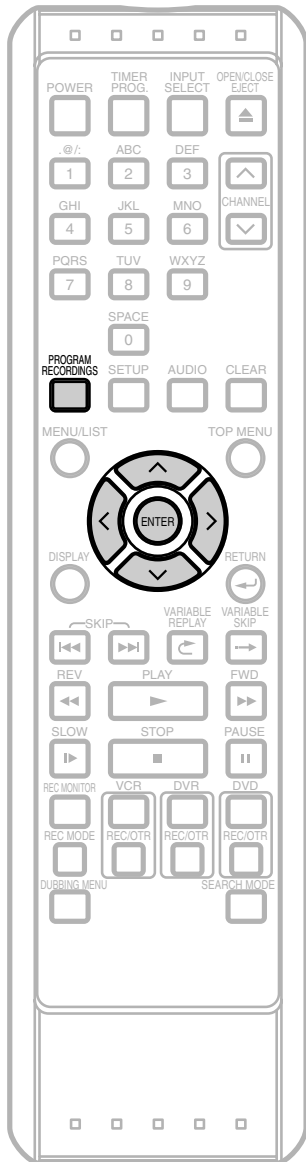

Playback and Edit with Programmed Recordings



1 Press **PROGRAM RECORDINGS**.
The unit switches to the DVR mode, and the Programmed Recordings Screen will appear.

2 Using $\wedge / \vee / \lt / \gt$, select the recorded program.
The recorded program plays back in the preview window.

3 Press **ENTER** to call up the menu window.

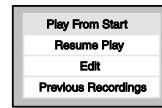

4 Using \wedge / \vee , select **“Play From Start”**.
Press **ENTER**.

The recorded program is played back.

If you want to resume playback from the last viewed point:

Select **“Resume Play”** in step 3.
Refer to ‘Resume Playback’ on page 72.

To edit a title:

Select **“Edit”** in step 3.
Refer to ‘Guide to Edit Title Name’ on page 95.

To display a Title List:

Select **“Previous Recordings”** in step 3.
Refer to ‘Playback from the Title List’ on page 68.

Information on Dubbing



You can copy a DVR/DVD disc to a videotape or copy a videotape to a DVR/DVD disc. This function will be possible only if the DVD disc or the videotape is not copy protected. Before starting this function, prepare for the recording on the DVD-RW/R disc or the videotape. Refer to page 32 (DVR/DVD) or page 122 (VCR).

Difference between (dubbing) Copy and Move

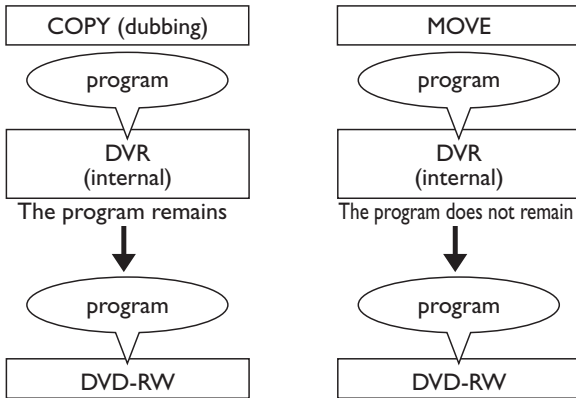

Available Dubbing Direction for Copy-Once Program

(O=Available X=Not Available)

From	To	
DVR (Internal)	DVD-RW(VR) (CPRM-compatible)	O ^{*1,*2}
	DVD-RW (Video)	X
	DVD-R	X
	Videotape	O ^{*2}
DVD-RW(VR)	DVR (Internal)	X
	Videotape	O ^{*2}
Videotape	DVR (Internal)	O
	DVD-RW(VR) (CPRM-compatible)	O ^{*2}
	DVD-RW(VR) (Not CPRM-compatible)	X
	DVD-R	X

*1: The program (recorded) moves. (It will be deleted from DVR.)

*2: You cannot dub the recorded program to DVR or DVD-RW again. (Copy control signal will be recorded to the videotape.)

Note for dubbing

- When you dub using **DUBBING MENU**, be aware that all the programs in the Dubbing List will be erased when you switch Original List and Playlist, if you want to dub programs from the both lists, (Original List and Playlist), finish up the dubbing of one list first and then make dubbing of the other list.

One Touch Dubbing from DVR to DVD

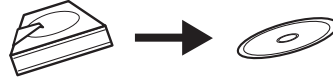
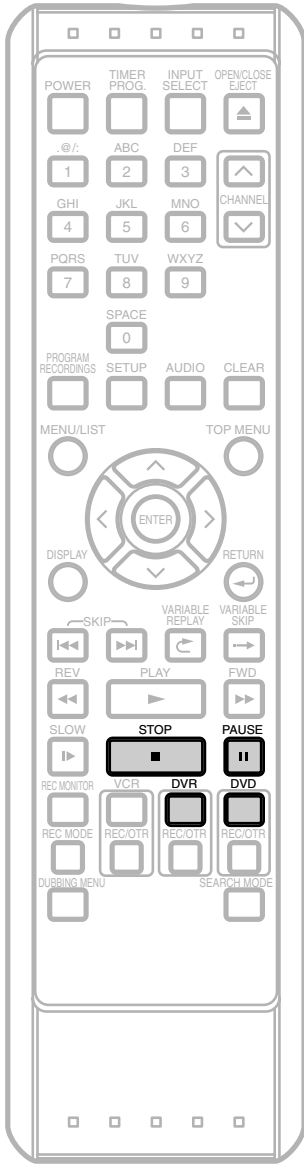

With One Touch Dubbing, you can start dubbing right away with just one touch.

- Recordable DVD must be in the unit. (See pages 29-31.)
- There should be enough space on the recording DVD.
- Make sure to press the corresponding Device Select Button before using the device of your choice.

Limitations:

- You cannot dub to the finalized Video mode DVDs.
- You cannot dub to the protected VR mode DVDs.
- If the unit detects that the dubbing will not finish by 3 minutes before the Timer Recording, the dubbing cannot be started. Be noted that with DVR to DVD dubbing, the duration of the dubbing is the duration of the dubbing title (except for the High Speed Dubbing).
- If a copy control signal is detected, the dubbing cannot be started.
- You cannot dub to the DVD if the number of the titles or the chapters of the disc is at its limit.
- Dubbing cannot be executed during DVR or DVD recording.
- Dubbing cannot be executed while the Menu Screen is showing (except for the Title List).

1 There are three ways to start One Touch Dubbing.

Method 1: Play the title you want to dub. When it comes to the point where you want to start dubbing from, press **STOP ■** or **PAUSE II**. Then, press **DUBBING DVR → DVD** on the front panel. The dubbing will start from there to the end.

- If there is not enough space left on the disc, the prohibited icon will appear and the dubbing will not be started.

Method 2: Select the title you want to dub in the Original List or Playlist. With the title selected (highlighted), press **DUBBING DVR → DVD** on the front panel. Or, with the title selected (highlighted), press **ENTER** to call up the Title List Menu. And using **^ / v**, select **“Dubbing”**. Then press **ENTER**.

- The dubbing will start from the beginning of the title to the end of the title.
- When the disc runs out of the space, dubbing stops automatically.

Method 3: If you press **DUBBING DVR → DVD** on the front panel in the stop mode without selecting anything, the unit will start dubbing the last title in the Original List or the Playlist. It will start dubbing the title in the Original List if the Original List was the last selected list. It will start dubbing the title in the Playlist if the Playlist was the last selected list.

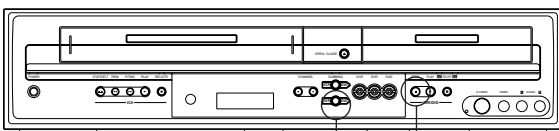

DUBBING DVR → DVD STOP ■

One Touch Dubbing from DVR to DVD (Cont'd)

- If the title was in the resume stop mode, the dubbing will start from the resume point to the end.
- If the title was in the regular stop mode, the dubbing will start from the beginning of the title to the end.
- If there is not enough space left on the disc, the prohibited icon will appear and the dubbing will not be started.

Note for dubbing from DVR to DVD

- You cannot switch the device mode except between DVD and VCR during DVR to DVD dubbing.
- High speed dubbing is not available for the One Touch Dubbing.

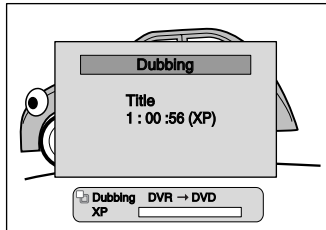

2 The dubbing will stop automatically when it reaches the end of the title. If you want to stop the dubbing manually, follow the following instructions below.

To stop the dubbing in preparation mode:

- Press **DVD**, then press **STOP** ■.

To stop the dubbing in progress:

- Press **DVD**, then press **STOP** ■ and hold it for 2 seconds. Or press **STOP** ■ on the front panel.

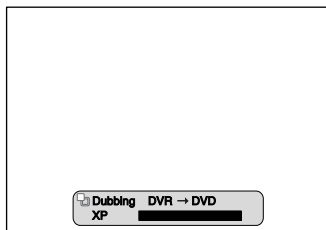
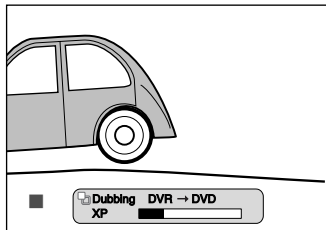

This operation may take a while to be completed.

One Touch Dubbing from Videotape to DVD

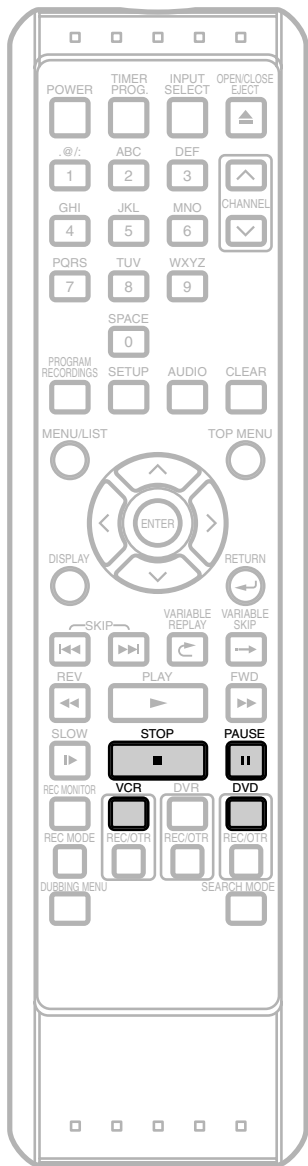

With One Touch Dubbing feature, you can start dubbing right away with just one touch.

- Recordable DVD must be in the unit. (See pages 29-31.)
- There should be enough space on the recording DVD.
- A videotape to be dubbed must be in the unit.
- Make sure to press the corresponding Device Select Button before using the device of your choice.

Limitations:

- You cannot dub to the finalized Video mode DVDs.
- You cannot dub to the protected VR mode DVDs.
- If a copy control signal is detected during dubbing, the dubbing will be stopped.
- Copy-once programs which are recorded directly from the TV can be dubbed to the DVR/DVD.
- Copy-once programs which are copied from the DVR/DVD to a videotape cannot be dubbed further from the videotape to the DVR/DVD.
- If the unit detects that the dubbing will not finish by 3 minutes before the Timer Recording, the dubbing cannot be started. Be noted that with VCR to DVD dubbing, the unit recognize DVD's remaining time as the dubbing duration although the actual dubbing will end when the videotape ends.
- You cannot dub to the DVD if the number of the titles or the chapters of the disc is at its limit.
- Dubbing cannot be executed during recording of any device.
- Dubbing cannot be executed while the Menu Screen is showing (except for the Title List).

1 Play the contents you want to dub. When it comes to the point where you want to start dubbing from, press **STOP ■** or **PAUSE II**.

2 Press **DUBBING VCR → DVD** on the front panel. The dubbing will start.

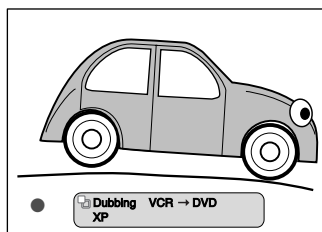
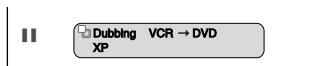
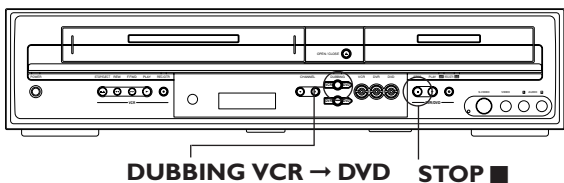

One Touch Dubbing from Videotape to DVD (Cont'd)

To stop the dubbing in preparation mode:

- Press **DVD**, then press **STOP** ■.

To stop the dubbing in progress:

- Press **DVD**, then press **STOP** ■ and hold it for 2 seconds. Or press **STOP** ■ on the front panel.

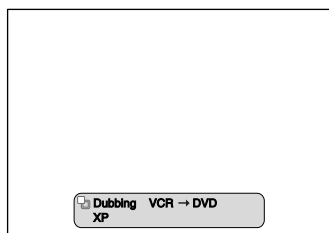
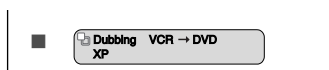

This operation may take a while to be completed.

Note for Dubbing from VCR to DVD

- When dubbing starts, the video image may be distorted because of the Digital Tracking function. This is not a malfunction. Play the videotape until the image clears up and then, start the dubbing.
- Playback audio is determined by the setting you make in 'Setting the Playback audio' section on page 127.
- Dubbing takes as much time as the playback does.
- You can not switch the device mode except between DVR and DVD.

Dubbing from DVR / DVD to Videotape

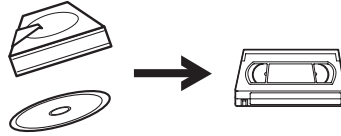
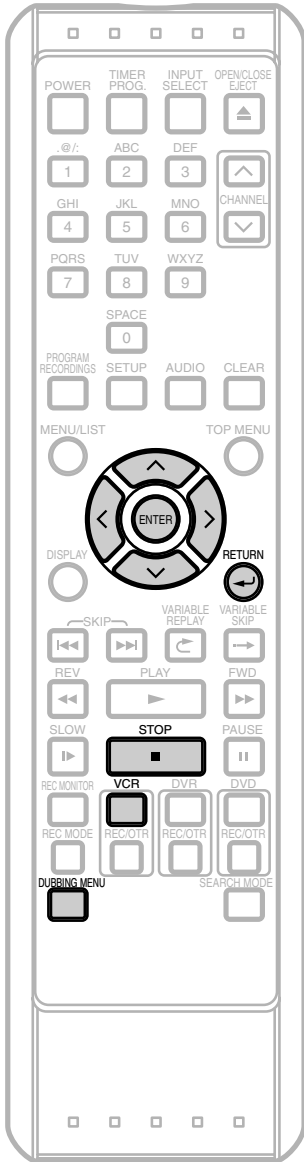

You can copy the contents of the DVR / DVD to a videotape.

Limitations:

- If a copy control signal is detected during dubbing, the dubbing will be stopped.
- If the unit detects that the dubbing will not finish by 3 minutes before the Timer Recording, it will display a confirmation message asking if you really want to continue with the dubbing. If you select "Yes", you can continue with the dubbing, and the Timer Recording will start after the dubbing ends.

Be noted that with DVR / DVD to VCR dubbing, the duration of the dubbing is the duration of the dubbing title.

- An error message will appear if you try to add a program to the Dubbing List when the total playback time of all the programs in the Dubbing List exceeds 10 hours and 30 minutes.

Limitation (DVD to VCR):

- Only the contents of the VR mode DVDs or the Video mode DVDs made on this unit can be dubbed. Any other discs cannot be dubbed.

Preparing for dubbing:

- Insert a recordable videotape with a record tab intact.
- Make sure that the videotape has enough space to record the contents.
- Make sure the desired Rec Mode (SP/SLP) is selected on the VCR in advance. (See page 122.) (You can change the Rec Mode during dubbing also.)

Preparing for dubbing (DVD to VCR):

- If you are dubbing from a disc, insert a disc to be dubbed.

1 Press **DUBBING MENU**.

The Dubbing Direction and the Rec Mode Menu will appear.

Dubbing Direction	Rec Mode
DVR → DVD	High
DVD → DVR	XP
DVR → VCR	SP
VCR → DVR	LP
DVD → VCR	EP
VCR → DVD	SLP
	SEP
	Auto

2 Using \wedge / \vee , select "**DVR → VCR**" for DVR to VCR dubbing. Press **ENTER**.

Using \wedge / \vee , select "**DVD → VCR**" for DVD to VCR dubbing. Press **ENTER**.

Dubbing Top Menu will appear.

Example: DVR → VCR

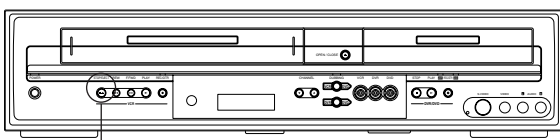

STOP/EJECT ■ ▲

Dubbing from DVR / DVD to Videotape (Cont'd)

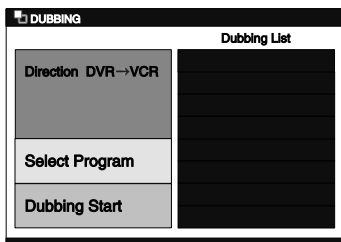

- 3 Using \wedge / \vee , select “Select Program”. Press **ENTER**. Program List will appear.

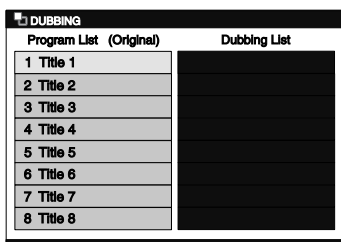

- 4 Using \wedge / \vee , select a desired program. Press **ENTER**. Program List Menu will appear.

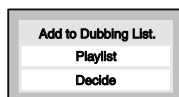

- 5 Using \wedge / \vee , select “Add to Dubbing List.”. Press **ENTER**. The selected program is now added to the Dubbing List.

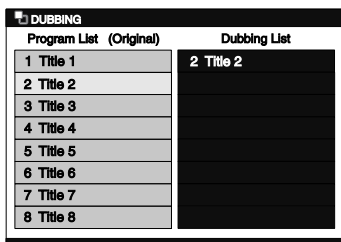

- If you want to select programs from the Playlist, select “Playlist” and press **ENTER** to call up the Playlist. Then follow the steps 4 to 5. (Be noted that Original List programs and the Playlist programs can not be entered together in one Dubbing List.)
- If more than one program is already in the Dubbing List, a green line will appear in the Dubbing List. Using \wedge / \vee move the line to the position you want to insert the program, then press **ENTER**. The program is now inserted in the selected position.

- 6 Repeat the steps 4 to 5 until you select all programs to be dubbed.
- 7 After selecting all the programs you want, press **RETURN** \leftarrow to go back to the Dubbing Top Menu. Or press **ENTER** to call up the option window and select “Decide”. Then press **ENTER** to go back to the Dubbing Top Menu.

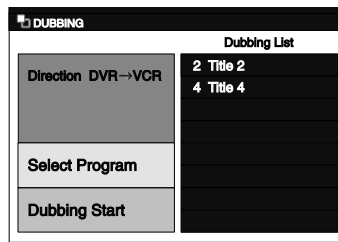

- 8 Using \wedge / \vee , select “Dubbing Start”. Press **ENTER**. Confirmation window will appear.

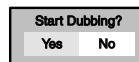

- 9 Using \leftarrow / \rightarrow , select “Yes”. Press **ENTER**. Dubbing will start.

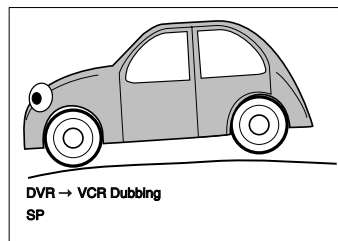

- It may take a while to prepare for the dubbing.

To stop the dubbing while in the dubbing preparation mode:

- Press **VCR** first, then press **STOP** \blacksquare . Or, press **STOP/EJECT** \blacksquare \blacktriangle on the front panel.

To stop the dubbing in progress:

- Press **VCR** first, then press **STOP** \blacksquare and hold it for 2 seconds. Or, press **STOP/EJECT** \blacksquare \blacktriangle on the front panel.

Note for Dubbing from DVR / DVD to Videotape

- You can not change the device mode between VCR and DVR / DVD during the DVR / DVD to VCR dubbing.

Bi-Directional Dubbing between DVR and DVD

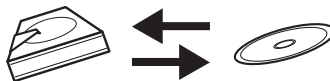
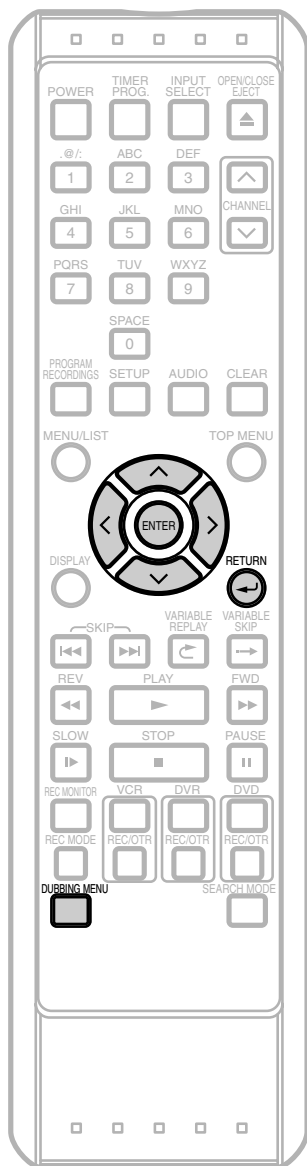

You can copy the contents of the DVR to a DVD, or vice versa.

Limitations:

- If the unit detects that the dubbing will not finish by 3 minutes before the Timer Recording, the dubbing cannot be started. Be noted that with DVR to DVD dubbing (or vice versa), the duration of the dubbing is the duration of the dubbing title (except for the High Speed Dubbing).

Limitations (DVR to DVD):

- You cannot dub to the finalized Video mode DVDs.
- You cannot dub to the protected VR mode DVDs.
- If you try to dub copy-once programs, you will be warned that the copy-once programs cannot be copied but only be moved. If you still want to continue with the dubbing (moving), select “Yes” and continue with the steps. Moving of the copy-once programs is only available with VR mode DVD-RW (CPRM compatible) discs.
- An error message will appear if you try to add a program to the Dubbing List under the following conditions;
 - When the number of programs in the “Dubbing List” exceeds 32 programs.
 - When the total number of titles in the DVD will exceed 99 titles.
 - When the total number of chapters in the DVD will exceed 999 chapters for VR mode DVDs.

Limitations (DVD to DVR):

- If a copy control signal is detected during dubbing, the dubbing will be stopped.
- The contents of the Video mode DVDs recorded on other unit cannot be dubbed using this unit.
- An error message will appear if you try to add a program to the Dubbing List under the following conditions;
 - When the total number of titles will exceed 300 titles.

Preparing for dubbing (DVR to DVD):

- Insert a recordable DVD. (See page 29.)
- Make sure there is enough space on the DVD.

Preparing for dubbing (DVD to DVR):

- Insert a disc to be dubbed.
- Make sure there is enough space on the DVR.

High Speed Dubbing

When dubbing from the DVR Original List to the VR mode DVD-RW, High Speed Dubbing will be available. High Speed Dubbing offers you the dubbing speed of 20 times the SEP mode dubbing. To perform the High Speed Dubbing, select “High” at step 3.

Just Dubbing

When dubbing from DVR to DVD if you select “Auto” in the Rec Mode Menu, the unit will calculate the duration of the dubbing material and the remaining time in the disc and automatically select the most suitable Rec Mode for the dubbing.

Bi-Directional Dubbing between DVR and DVD (Cont'd)

1 Press **DUBBING MENU**.

The Dubbing Direction and the Rec Mode Menu will appear.

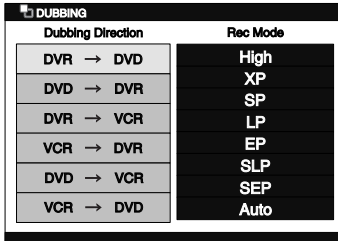

- 2 Using \wedge / \vee , select “**DVR → DVD**” for DVR to DVD dubbing. Press **ENTER**.
Using \wedge / \vee , select “**DVD → DVR**” for DVD to DVR dubbing. Press **ENTER**.

Example: DVR → DVD

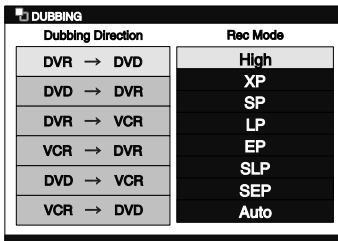

- 3 Using \wedge / \vee , select a desired Rec Mode. Press **ENTER**.
Dubbing Top Menu will appear.

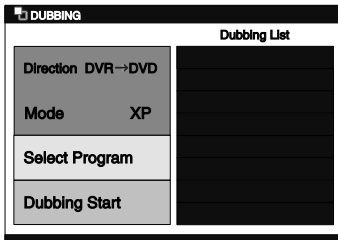

- If you select “**Auto**” for the Rec Mode, the unit will automatically calculate the remaining time and select the most suitable Rec Mode (DVR to DVD dubbing only).
- High Speed Dubbing is available only when dubbing the titles in the DVR Original List to the VR mode DVD.

- 4 Using \wedge / \vee , select “**Select Program**”. Press **ENTER**.
Program List will appear.

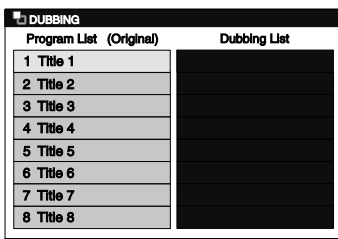

- 5 Using \wedge / \vee , select a desired program. Press **ENTER**.
Program List Menu will appear.

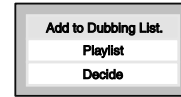

- 6 Using \wedge / \vee , select “**Add to Dubbing List.**”. Press **ENTER**.
The selected program is now added to the Dubbing List.

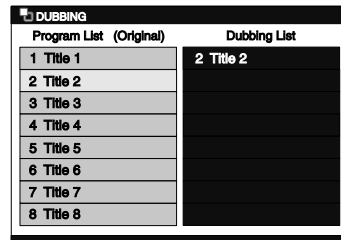

- If you want to select programs from the Playlist, select “**Playlist**” and press **ENTER** to call up the Playlist. Then follow the steps 5 and 6. (Be noted that Original List programs and the Playlist programs can not be entered together in one Dubbing List.)
- If more than one program is already in the Dubbing List, a green line will appear in the Dubbing List. Using \wedge / \vee move the line to the position you want to insert the program, then press **ENTER**. The program is now inserted in the selected position.

- 7 Repeat the steps 5 to 6 until you select all programs to be dubbed.

- 8 After selecting all the programs you want, press **RETURN** \leftarrow to go back to the Dubbing Top Menu. Or press **ENTER** to call up the option window and select “**Decide**”. Then press **ENTER** to go back to the Dubbing Top Menu.

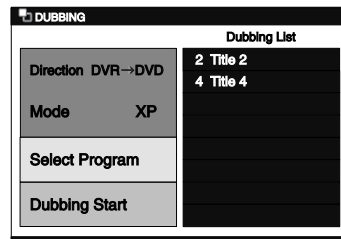

Before you start

Connections

Initial Setups

Recording / Dubbing

Playback

Editing

Other Setups

VCR functions

Others

Español

Bi-Directional Dubbing between DVR and DVD (Cont'd)

- 9 Using \wedge / \vee , select “Dubbing Start”. Press **ENTER**. Confirmation window will appear.

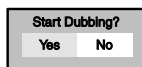

- 10 Using \lt / \gt , select “Yes”. Press **ENTER**. Dubbing will start.

Preparing for the dubbing

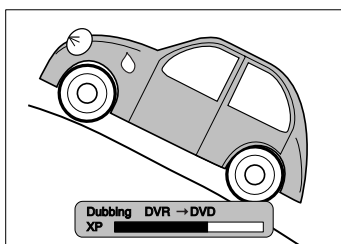
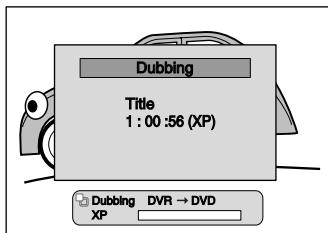

- It may take a while to prepare for the dubbing.
- During High Speed Dubbing, the playback picture will not appear.

Note

- When dubbing from DVR to DVD (or vice versa), even if the selected Rec Mode is set to the higher quality than that of the material to be dubbed, the program will not be recorded in the higher quality. It only protects the current picture quality.
- You cannot switch the device mode between DVR and DVD during the bi-directional dubbing between DVR and DVD.
- When you dub a copy-once program from DVR to DVD, it will be **MOVED** to the disc (not copied) and the original data will be erased from the DVR.

Note on the High Speed Dubbing

- Duration of the High Speed Dubbing will depend on the Rec Mode, the length, the disc type of the material to be dubbed.
- High speed Dubbing is available only when dubbing the titles in the DVR Original List to the VR mode DVD.

To stop the dubbing while in the dubbing preparation mode:

- Press the Device Select Button of the recording device first (for example, if you are dubbing to DVD, press **DVD** first), then press **STOP** ■.

To stop the dubbing in progress:

- Press the Device Select Button of the recording device first (for example, if you are dubbing to DVD, press **DVD** first). Then press **STOP** ■ and hold it for 2 seconds. Or, press **STOP** ■ on the front panel.

Bi-Directional Dubbing between DVR and DVD (Cont'd)

Deleting a Program from the Dubbing List

- 1 If you are in the Dubbing Top Menu, select **"Select Program"**, and press **ENTER**. Program / Dubbing List will appear. If you are already in the Program / Dubbing List, proceed to step 2.

- 2 Press **>** to move to the Dubbing List.

- 3 Using **^ / v**, select a program you want to delete, then press **ENTER**. Dubbing List Menu will appear.

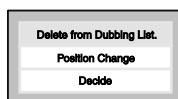

- 4 Using **^ / v**, select **"Delete from Dubbing List."**. Press **ENTER**. The program is now deleted.

- 5 Press **RETURN** **↵** to go back to the Dubbing Top Menu.

Changing the Order of the Dubbing List

- 1 If you are in the Dubbing Top Menu, select **"Select Program"**, and press **ENTER**. Program / Dubbing List will appear. If you are already in the Program / Dubbing List Screen, proceed to step 2.

- 2 Press **>** to move to the Dubbing List.

- 3 Using **^ / v**, select a program you want to move, then press **ENTER**. Dubbing List Menu will appear.

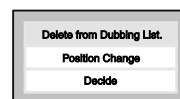

- 4 Using **^ / v**, select **"Position Change"**. Press **ENTER**. The selected program will be replaced by a single line.

- 5 Using **^ / v**, move the line to the desired position, then press **ENTER**. The program is now inserted in the selected position.

Dubbing from Videotape to DVR / DVD

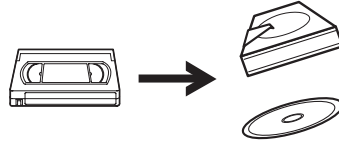
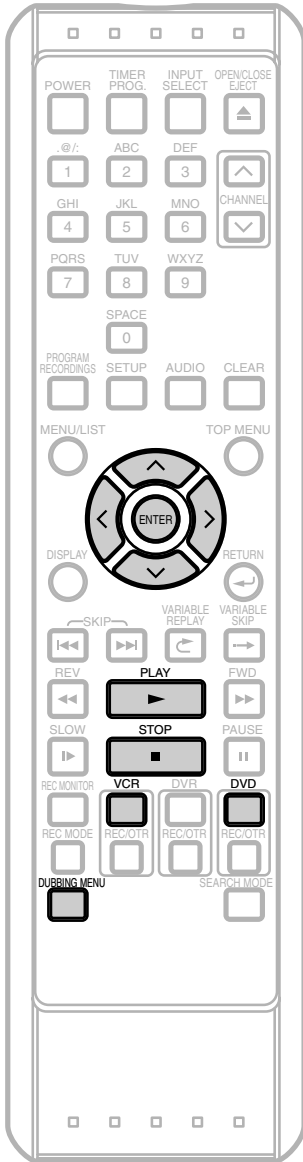

You can copy the contents of a videotape to DVR or DVD disc.

Limitation:

- If a copy control signal is detected during dubbing, the dubbing will be stopped.

Limitations (VCR to DVR):

- If the unit detects that the dubbing will not finish by 3 minutes before the Timer Recording, it will display a confirmation message asking if you really want to continue with the dubbing. If you select "Yes", you can continue with the dubbing, and the Timer Recording will start after the dubbing ends. Be noted that with VCR to DVR dubbing, the unit recognize the DVR's remaining time as the dubbing duration. The maximum possible duration is 10 hours and 30 minutes.

Limitations (VCR to DVD):

- You cannot dub to the finalized Video mode DVDs.
- You cannot dub to the protected VR mode DVDs.
- Copy-once programs which are recorded directly from the TV can be dubbed to the DVR and CPRM compatible VR mode DVD-RW.
- Copy-once programs which are copied from the DVR/DVD to a videotape cannot be dubbed further from the videotape to the DVR/DVD.
- If the unit detects that the dubbing will not finish by 3 minutes before the Timer Recording, it will display a confirmation message asking if you really want to continue with the dubbing. If you select "Yes", you can continue with the dubbing, and the Timer Recording will start after the dubbing ends. Be noted that with VCR to DVD dubbing, the unit recognize DVD's remaining time as the dubbing duration although the actual dubbing will end when the videotape ends.

Preparing for dubbing :

- Insert a videotape to be dubbed.

Preparing for dubbing (VCR to DVR):

- Make sure there is enough space on the DVR.

Preparing for dubbing (VCR to DVD):

- Insert a recordable DVD. (See page 29.)
- Make sure there is enough space on the DVD.

Dubbing from Videotape to DVR / DVD (Cont'd)

Press **VCR** first.

1 Press **PLAY** ► to start playback of the videotape, and press **STOP** ■ when it reaches the point you want to start dubbing.

2 Press **DUBBING MENU**.
The Dubbing Direction and the Rec Mode Menu will appear.

DUBBING	
Dubbing Direction	Rec Mode
DVR → DVD	High
DVD → DVR	XP
DVR → VCR	SP
VCR → DVR	LP
DVD → VCR	EP
VCR → DVD	SLP
	SEP
	Auto

3 Using **^** / **v**, select **“VCR → DVR”** for DVR dubbing. Press **ENTER**.
Using **^** / **v**, select **“VCR → DVD”** for DVD dubbing. Press **ENTER**.

Example: VCR → DVR

DUBBING	
Dubbing Direction	Rec Mode
DVR → DVD	XP
DVD → DVR	SP
DVR → VCR	LP
VCR → DVR	EP
DVD → VCR	SLP
VCR → DVD	SEP

4 Using **^** / **v**, select a desired Rec Mode.
Press **ENTER**.
Dubbing Top Menu will appear.

DUBBING	
Dubbing List	
Direction VCR→DVR	
Mode XP	
Dubbing Start	

5 With **“Dubbing Start”** selected, press **ENTER**.
Confirmation window will appear.

Start Dubbing?	
Yes	No

6 Using **<** / **>**, select **“Yes”**. Press **ENTER**.
Dubbing will start.

To stop the dubbing while in the dubbing preparation mode:

- Press the Device Select Button of the recording device first (for example, if you are dubbing to DVD, press **DVD** first), then press **STOP** ■.

To stop the dubbing in progress:

- Press the Device Select Button of the recording device first (for example, if you are dubbing to DVD, press **DVD** first). Then press **STOP** ■ and hold it for 2 seconds. Or press **STOP** ■ on the front panel.

Note

- The device mode change is available only between DVR and DVD during the videotape to the DVR / DVD dubbing.
- After starting dubbing, the picture may be distorted because of the digital tracking function. This is not a malfunction. Be advised to playback the videotape until the picture is stabilized, then set the starting point at which you wish to start recording, and start dubbing.
- Playback audio is determined by the setting you make in the ‘Setting the Playback audio’ section on page 127.

Settings for the External Devices



Connect the external source properly to the unit by using input jacks either LINE2 (Front) or LINE1 (Rear). When connecting an external equipment of monaural output to this unit, use AUDIO L jack of LINE 1 (Rear) or LINE2 (Front). Use commercially available S-Video or Video cable and an Audio cable for this type of connection.

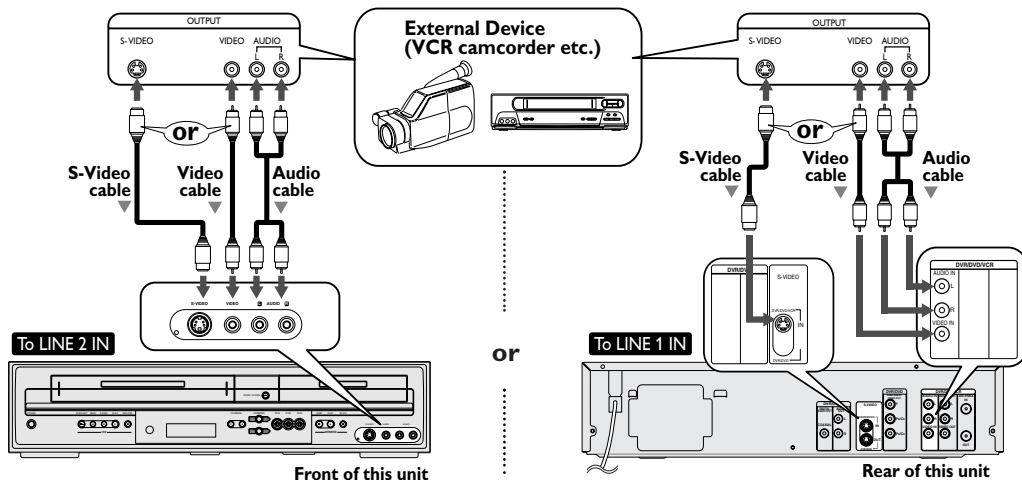

- Press **SETUP**.
“Easy Setting Menu” or “Advanced Menu” will appear.
If “Advanced Menu” is displayed, proceed to step 3.

Example: VR mode DVD-RW disc

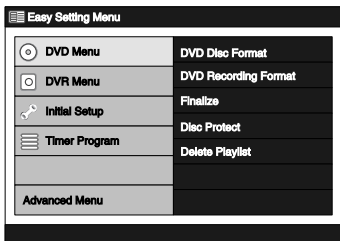

- Using \wedge / \vee , select “Advanced Menu”. Press **ENTER**.
- Using \wedge / \vee , select “Initial Setup”. Press **ENTER**.

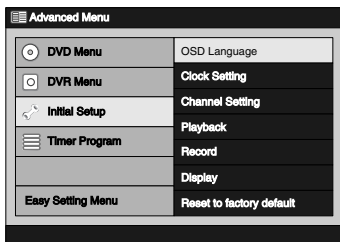

- Using \wedge / \vee , select “Display”. Press **ENTER**.
Display Menu will appear.

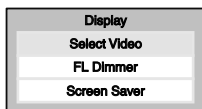

- Using \wedge / \vee , select “Select Video”. Press **ENTER**.
Option window will appear.

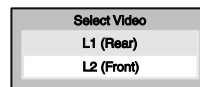

- Using \wedge / \vee , select the external input ; “L1” (Rear) or “L2” (Front).
 - If you are using the jacks on the rear, select “L1”.
 - If you are using the jacks on the front, select “L2”.
 Press **ENTER**.
Option window will appear.

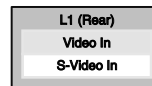

- Using \wedge / \vee , select the video input type you use, Video or S-Video, then press **ENTER**.
Your setting is now activated.
 - The default setting is “Video In”.
- Press **SETUP** to exit.

Dubbing from the External Devices

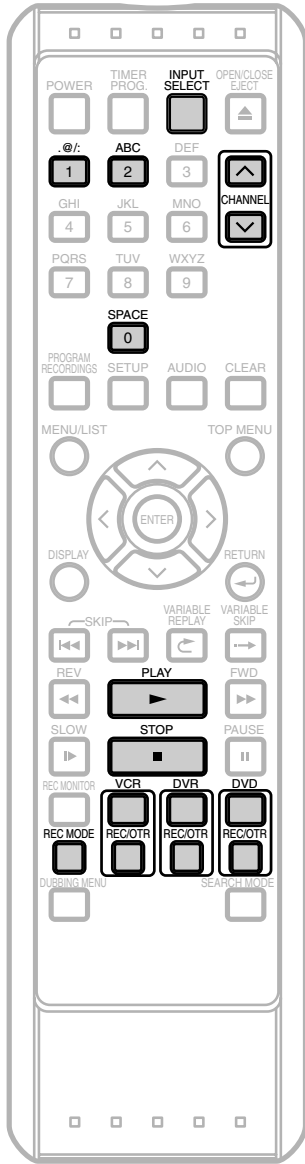

Before recording from the external device, connect the external device correctly by following the direction on page 60, and turn the power of the unit and the external device on.

- 1** Turn on the TV. Select the appropriate external input channel. (See page 18.)
- 2** Select the recording media.
Recording to DVR: Press **DVR** first.
Recording to DVD: Press **DVD** first and insert a disc. (It may take a while to load the disc.)
Recording to a videotape: Press **VCR** and insert a videotape.
- 3** Select the appropriate external input channel of this unit by pressing **INPUT SELECT**. You also can use **CHANNEL** \wedge / \vee .
 - If you are using the jacks on the front set the channel to L2.
 - If you are using the jacks on the rear set the channel to L1.
- 4** Select a Rec Mode by pressing **REC MODE**. Refer to 'Rec Mode' on page 30 for DVR/DVD or page 122 for VCR.
- 5** Press **REC/OTR** (of the recording device,) on the unit to start recording.
- 6** Press **PLAY** button on the external device to record from.
- 7** For DVR or DVD:
Press **STOP** \blacksquare on the recording unit (this unit) first to stop recording.

This operation may take a while to be completed.

Then, stop the external device.
For VCR:

Press **STOP / EJECT** \blacksquare \blacktriangle on the recording unit (this unit) first to stop recording.
Then, stop the external device.

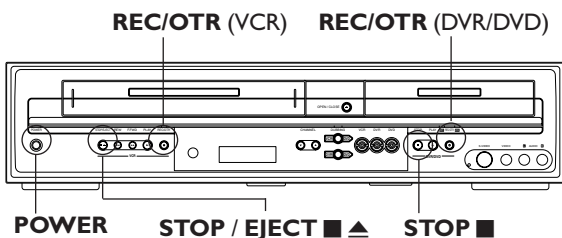

Note

- To avoid mistakes, it is recommended to use the buttons on the front panel to operate.
- Read also the instructions for the external device thoroughly.

Protecting a Disc

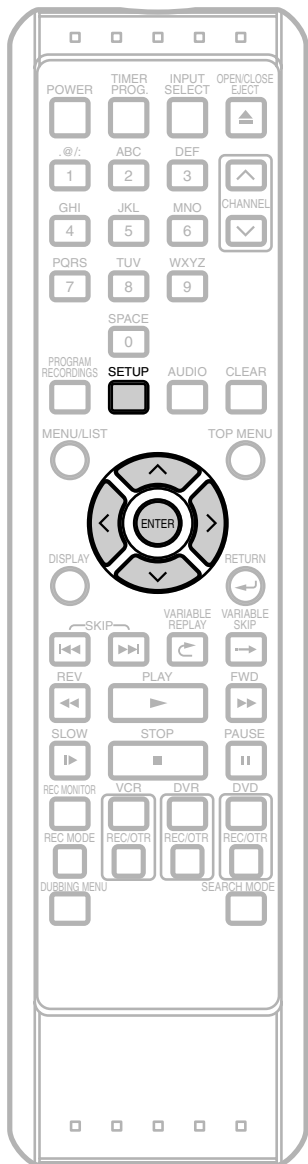

To prevent accidental recording, editing or erasing of the titles, you can protect the whole disc.

- 1 Press **SETUP**.
“Easy Setting Menu” or “Advanced Menu” will appear.

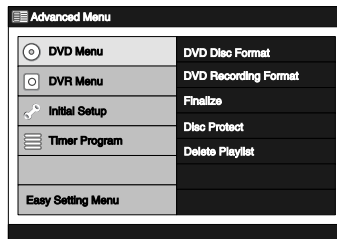

- 2 Using \wedge / \vee , select “DVD Menu”. Press **ENTER**.
- 3 Using \wedge / \vee , select “Disc Protect”. Press **ENTER**.
Confirmation window will appear.

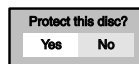

- If the disc has already been protected, “Disc Undo Protect” will be listed in the menu instead of “Disc Protect”. To undo the disc protection, select “Disc Undo Protect” and press **ENTER**.

- 4 Using \lt / \gt select “Yes”. Then press **ENTER**.
Final confirmation window will appear.

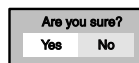

- 5 Using \lt / \gt , select “YES”. Press **ENTER**.
The disc will be protected.

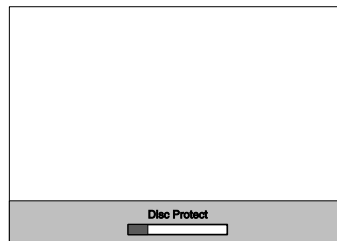



This operation may take a while to be completed.

Note

- Disc Protect is available only with VR mode DVDs.

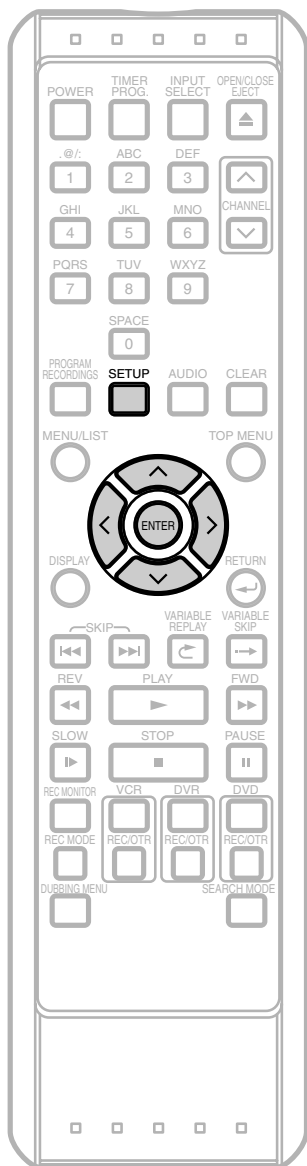
Finalizing a Disc

**Note**

- If  appears when pressing **ENTER**, that means the finalizing process has reached the critical point, and cannot be stopped.
- You cannot cancel finalizing the DVD-R disc once it has started.

Finalize

You must first finalize the disc before playing it back on other unit.

1 Press **SETUP**.

“Easy Setting Menu” or “Advanced Menu” will appear.

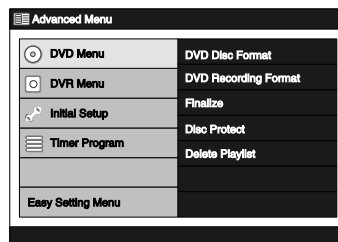
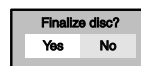
**2** Using \wedge / \vee , select “DVD Menu”, then press **ENTER**.**3** Using \wedge / \vee , select “Finalize”, then press **ENTER**.
Confirmation window will appear.

- If the disc has already been finalized, “**Undo Finalize**” will be listed in the menu instead of “**Finalize**” (DVD-RW only). To Undo the finalization of the disc, select “**Undo Finalize**” and press **ENTER**.

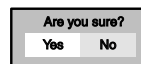
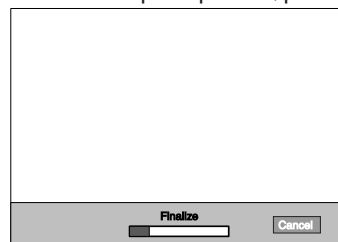
4 Using \lt / \gt , select “Yes”, then press **ENTER**.
Final confirmation window will appear.**5** Using \lt / \gt , select “Yes”, then press **ENTER**.
A progress bar will appear, and finalizing will start.
• If you want to stop the process, press **ENTER**.

This operation may take a while to be completed.

Finalizing ends when the progress bar reaches the right end.

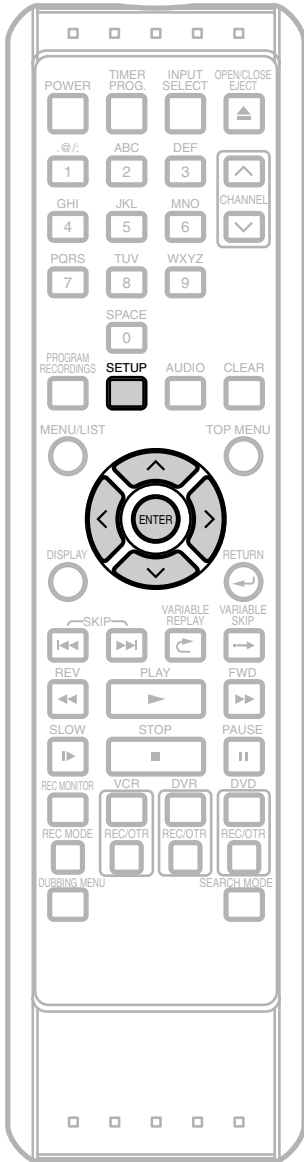

Auto Finalize



This feature allows you to set the unit to automatically finalize the disc at the specified timing when dubbing to the Video mode DVDs. This feature is available only with the Video mode DVDs.

- 1 Press **SETUP**.
 “Easy Setting Menu” or “Advanced Menu” will appear.
 Example: DVD-R (Advanced Menu)

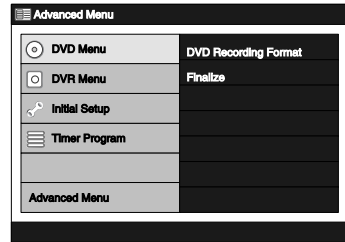

- 2 Using \wedge / \vee , select “Initial Setup”. Press **ENTER**.

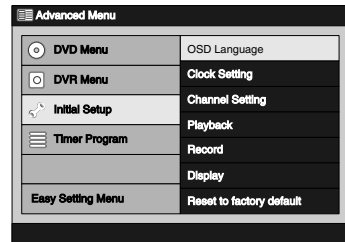

- If you are using the “Easy Setting Menu”, skip to step 4.

- 3 Using \wedge / \vee , select “Record”. Press **ENTER**.
 Record Menu will appear.

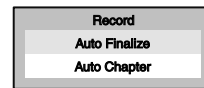

- 4 Using \wedge / \vee , select “Auto Finalize”. Press **ENTER**.

Option window will appear.

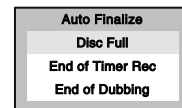

Disc Full : The unit automatically finalizes the disc when it becomes full during recording.

End of Timer Rec : The unit automatically finalizes the disc when all the Timer Recordings to a DVD are completed.

End of Dubbing : The unit automatically finalizes the disc when a dubbing or One Touch Dubbing to a DVD is completed and when there is no Timer Recording in standby.

Finalizing a disc (Cont'd)

- 5** Using \wedge / \vee , select the desired timing to finalize the disc. Press **ENTER**.

Option window will appear.

Example: Disc Full

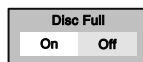

- 6** Using \lt / \gt , select **“On”**. Press **ENTER**.

Your setting is now activated.

- 7** Press **SETUP** to exit.

Note









- Although finalization is recommended, you may be able to play the VR mode discs on other unit without finalizing. With regard to the Video mode discs, you **MUST** finalize them before playing them back on other unit.
- **After DVD-R discs are finalized:**
 - A DVD Menu is created automatically.
 - Undoing the finalization is not possible.
 - Additional recording or editing is not possible.
- **After Video mode DVD-RW discs are finalized:**
 - A DVD Menu is created automatically.
 - Undoing the finalization is possible.
 - Additional recording or editing is possible if you undo finalize.
- **After VR mode DVD-RW discs are finalized:**
 - A DVD Menu is not created.
 - Undoing the finalization is possible.
 - Additional recording or editing is possible even without undoing the finalization.
- When DVD Menu is created Title List will no longer be available.

Playback Information

Before you play back DVD discs, read the following information.

Playable discs

This unit is compatible with the following discs. To play back a DVD, make sure that it meets the requirements for region codes and color systems described in this section. Discs with the following logos can be played back on the unit. Playback of other disc types is not guaranteed.

Disc	Logo
DVD-VIDEO	
DVD-RW (VIDEO/R mode)	
DVD-R (VIDEO mode)	
CD-DA (AUDIO CD)	
CD-RW (CD-DA FORMAT, MP3 / WMA files)	 
CD-R (CD-DA FORMAT, MP3 / WMA files)	 

 is a trademark of DVD Format/Logo Licensing Corporation.

Color systems

DVDs are recorded in different color systems throughout the world. The most common color system is NTSC (which is used primarily in the United States and Canada).

This unit uses NTSC, you must use DVDs recorded in the NTSC system. You cannot play back DVDs recorded in other color systems.

Region codes

This unit has been designed to play back DVD discs with Region One (1). DVDs must be labeled for ALL regions or for Region 1. You cannot play back DVDs labeled for other regions. Look for the symbols below on your DVDs. If these region symbols are not on your DVD, you cannot play back the DVD on this unit.



The number inside the globe refers to region of the world. A DVD labeled for a specific region can only be played back on the unit with the same region code.

Playback of discs recorded in Video mode on a regular DVD player (Video mode)

Discs recorded in Video mode can be played back on regular DVD players, including computer DVD drives compatible with DVD-Video Playback*. You will need to finalize the discs recorded in Video mode to play them back on other DVD players.

* DVD-Video format (Video mode) is a new format for recording on DVD-RW/R discs that was approved by the DVD Forum in 2000. Adoption of this format is optional for manufacturers of DVD playback devices, and there are DVD-Video players, DVD-ROM drives or other DVD playback devices that do not play back DVD-RW/R discs recorded in the DVD-Video format.

Play the recorded contents

You can select the title you want to play from the Title List. The Title List can easily be accessed by pressing **TOP MENU**. The recorded titles can also be called up by pressing **PROGRAM RECORDINGS** (DVR Original List only).

What are titles and chapters?

The contents on the DVR / DVD are generally divided into titles. Titles may be further divided into chapters.

What are Original List and Playlist?

Throughout this manual, you will find Original List and Playlist to refer to the Original content and the edited version. (See page 89.)

- Original List refers to what's originally recorded on the disc.
- Playlist refers to the edited version of the Original List content.

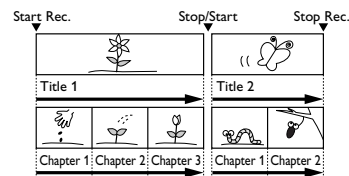

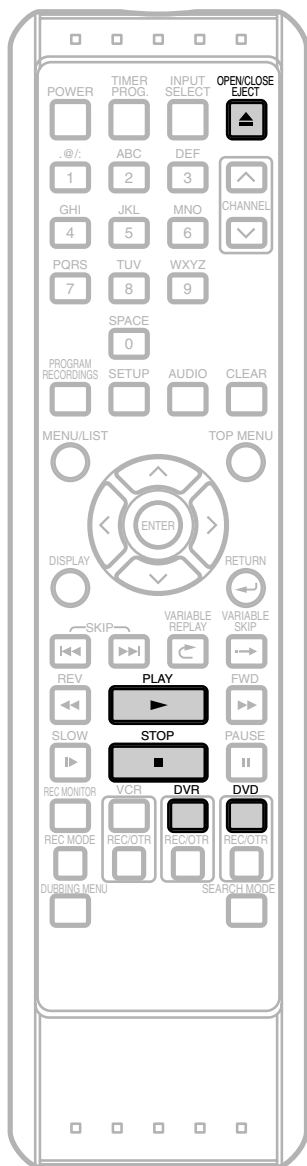

Direct Playback



If you are playing the DVR, press **DVR** first.

If you are playing a disc, press **DVD** first.

- 1** Turn on the TV. Select the appropriate external input channel. (See page 18.)
 - If you are playing the DVR, skip to step 4.
- 2** Press **OPEN / CLOSE** ▲ to open the disc tray. The disc tray will open.
- 3** Insert your disc with its label facing up. Align the Disc to the disc tray guide.

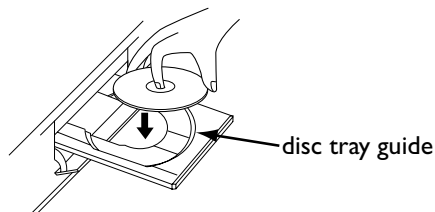

Press **OPEN / CLOSE** ▲ again to close the disc tray.

- It may take a while to load the disc.

- 4** Press **PLAY** ► to start playback. Playback will start.
 - Depending on the media, the playback may start from a resume point. (See page 72.)
 - If you are playing back a DVD-Video, a Disc Menu may appear. Refer to page 70 for more details about the Disc Menu.
- 5** Press **STOP** ■ to stop playback.

Note

- Some discs may start playback automatically.

Basic Playback (Cont'd)

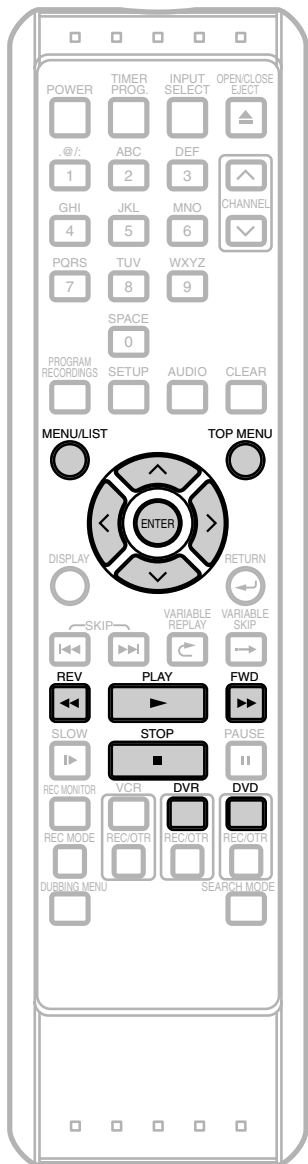

Playback from the Title List



If you are playing the DVR, press **DVR** first.

If you are playing a disc, press **DVD** first.

1 Follow steps 1-3 in 'Direct Playback' on page 67.

2 Press **TOP MENU**.
Title List will appear.

Example: DVR

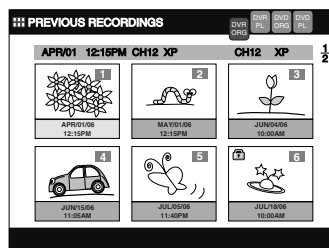

Press **MENU / LIST** to switch Original List / Playlist if necessary.

- To exit the Title List, press **TOP MENU**.

3 Using **^ / v / < / >**, select a desired title, then press **PLAY**.

Playback will start.

- Use **^ / v / < / >** to move among the titles one by one, and use **FWD** / **REV** to jump to the next / previous Title List page.
- For DVR, playback will start from the resume point. If you want to start it from the beginning, use the Title List Menu.

4 Press **STOP** to stop playback.

Basic Playback (Cont'd)

Playback from the Title List Menu



(Not available for the DVD-Videos, the finalized Video mode DVDs, or the Video mode discs made on other unit)

If you are playing the DVR, press **DVR** first.

If you are playing a disc, press **DVD** first.

1 Follow steps 1-3 in 'Direct Playback' on page 67.

2 Press **TOP MENU**.

Title List will appear.

Example: DVR

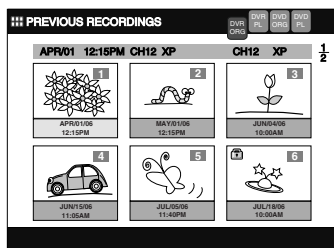

Press **MENU / LIST** to switch Original List / Playlist if necessary.

- To exit the Title List, press **TOP MENU**.

3 Using **^ / v / < / >**, select a desired title, then press **ENTER**.

Title List Menu will appear.

Example: DVR

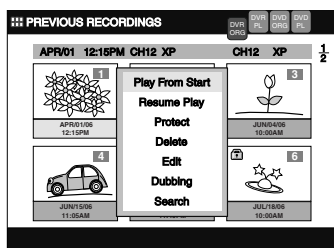

- Use **^ / v / < / >** to move among the titles one by one, and use **FWD ►► / REV ◀◀** to jump to the next / previous Title List Page.

4 Using **^ / v**, select **"Play From Start"** if you want to play the title from the beginning.

Select **"Resume Play"** (DVR only) if you want to play the title from the point where it is stopped last time.

Press **ENTER**.

Playback will start.

5 Press **STOP ■** to stop the playback.

Playback from the DVD Menu



With finalized Video mode DVDs or the Video mode DVDs made on other units, a DVD Menu may be contained instead of the Title List. DVD Menus are created automatically when you finalize a Video mode disc. With such discs, Title List is no longer available.

Follow the steps below to play back a disc using the DVD Menu.

Press **DVD** first.

1 Insert a disc.

DVD Menu may appear automatically. Otherwise press **TOP MENU** to call up the DVD Menu.

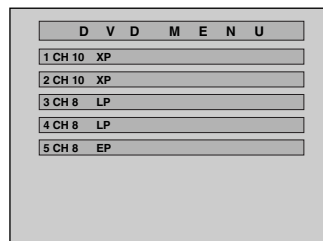

Press **STOP ■** if you want to exit from the menu.

2 Using **^ / v**, select a desired title. Press **PLAY ►** or **ENTER**. Playback will start.

3 Press **STOP ■** to stop playback.

Note

- Operation may vary depending on the discs.

Basic Playback (Cont'd)

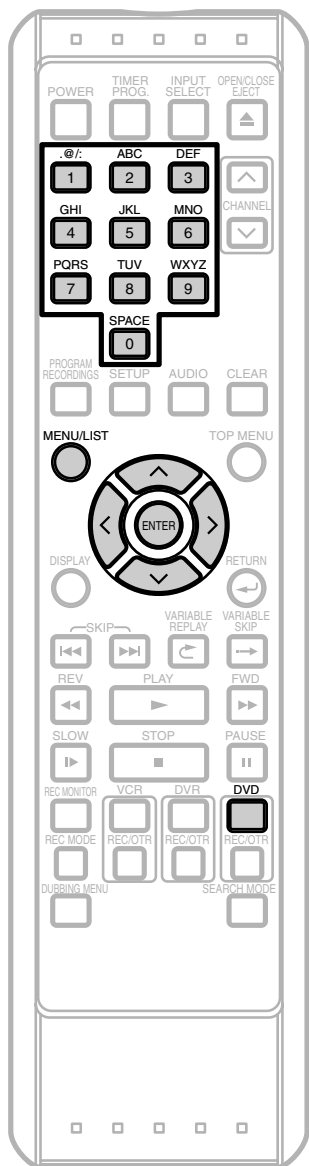

Playback from the Disc Menu



Some DVD discs contain disc menus that describe the contents or allows you to customize the playback. For example, the menu may offer choices for subtitle languages, special features, or chapter selection. Some discs display them automatically when you insert the disc. For others, follow the steps below.

Press **DVD** first.

- 1** Press **MENU / LIST**.
The Disc Menu will appear.
If the feature is not available,  may appear on the TV screen.
- 2** Using **^ / v / < / >**, select an item. Press **ENTER** to confirm.
Continue this step to setup all the features you want or to start playing back the disc from the menu.

MENU / LIST:

Displays a DVD disc menu. It may be the same with the Title List.

Cursor ^ / v / < / >:

Moves the cursor on the screen.

ENTER:

Selects the currently highlighted menu option.

Number Buttons:

Selects a numbered menu option (some discs only). You may have to press **ENTER** after.

- 3** Press **MENU / LIST** to exit the Disc Menu.

Note

- Menu vary among discs. Refer to the information accompanying the disc for details.

Basic Playback (Cont'd)

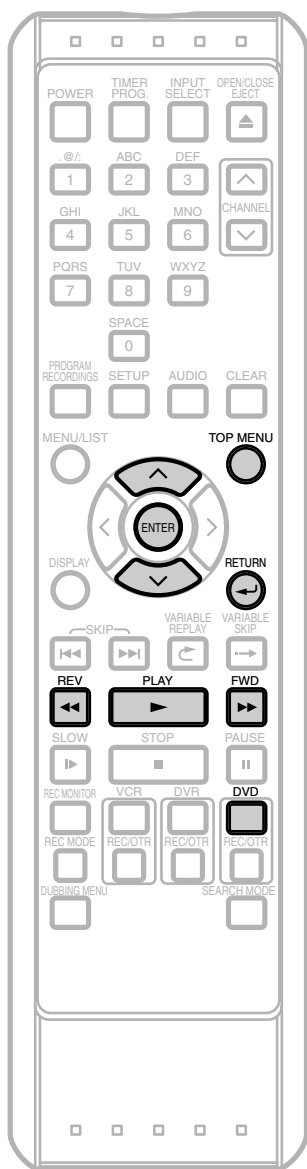

Playing back MP3 / WMA Discs



Press **DVD** first.

- 1 The MP3 / WMA Menu will appear automatically when you insert a disc. Or in stop mode, press **TOP MENU** to call up the MP3 / WMA List.

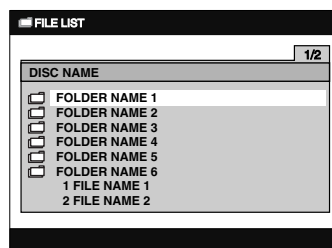

- To exit the menu, press **TOP MENU** again.

- 2 Press **^** / **v** to select a desired folder (group) or track. Press **ENTER**.

When a track is selected:

Playback will start.

When a folder is selected:

The files and the folders will appear.

Press **^** / **v** to select a track or a folder you want, then press **ENTER**.

- Press **ENTER** or **FWD** **▶▶** to move to the lower level folders.
- Press **REV** **◀◀** or **RETURN** **↵** to move back to the upper level folders.

Hints for MP3 / WMA files:

- Folders are known as Groups, files are known as Tracks.
- Folders are accompanied by  icon.
- The system can recognize up to 999 groups (or folders) per disc, and up to 999 tracks per disc.
- The maximum displayable number of letters for the group or the track name varies depending on their names. Unrecognizable characters will be replaced with asterisks (*).
- If there are not any playable files in the folder, the folder will not be displayed in the list.

This unit recommends the files recorded under the following circumstances:

- Sampling frequency: 44.1kHz or 48kHz.
- Constant bit rate: 112kbps – 320kbps.

Note

- The audio source of MP3 / WMA files cannot be recorded as digital sound by an MD or DAT deck.
- Files that bear an extension other than .mp3 or .wma (MP3 / WMA) will not appear in the MP3 / WMA Menu.
- Some unplayable folders or tracks may appear in the MP3 / WMA Menu depending on their recording status.

Special Playback



Resume Playback



You can resume playback from where you stopped last time.

If you are playing the DVR, press **DVR** first.

If you are playing a disc, press **DVD** first.

- 1** During playback, press **STOP** ■.
Pressing **STOP** ■ twice will cancel the Resume function.
- 2** Press **PLAY** ►.
Within a few seconds, playback will resume from the point at which it stopped last. Resume function stays in effect even if you turn off the power.

For DVR: You can set a resume point per every title.

- If you play back from the Title List Menu, you can choose “Play From Start” or “Resume Play”. Otherwise the playback will start from the resume point of the last played title.
- Press **STOP** ■ twice at step 1 if you do not want to set a resume point. In this case, next time you press **PLAY** ►, the playback will start from the beginning of the last title in the Title List.

For DVDs: You can set only one resume point per disc.

- If a resume point is set, the playback will start from the resume point next time you press **PLAY** ►.
- Press **STOP** ■ twice at step 1 if you do not want to set a resume point. In this case, next time you press **PLAY** ►, the playback will start from the beginning of the first title in the Title List.

For CD, or MP3/WMA: You can set only one resume point per disc.

- If a resume point is set, the playback will start from the resume point next time you press **PLAY** ► if you are playing a CD. As to the MP3/WMA files, the resume playback will start from the beginning of the track last played.
- Press **STOP** ■ twice at step 1 if you do not want to set a resume point. In this case, next time you press **PLAY** ►, the playback will start from the beginning of the disc.

Note

- Resume point will be lost when you;
 - Open/Close the disc tray.
 - Switch Original List and Playlist.

Special Playback (Cont'd)

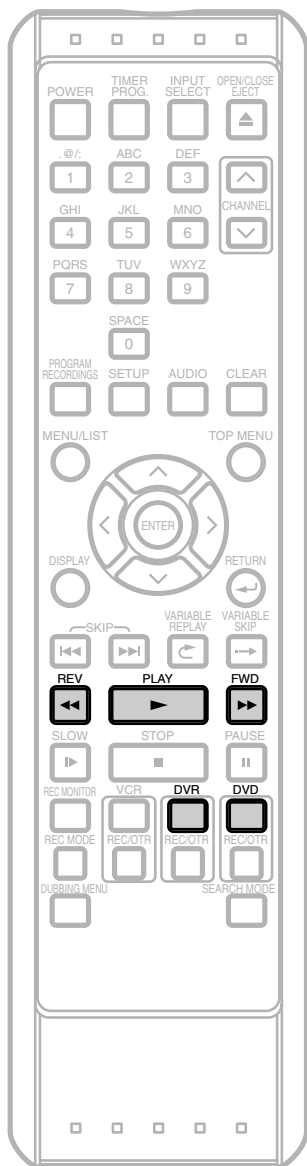

Fast forward / Fast reverse



If you are playing the DVR, press **DVR** first.
If you are playing a disc, press **DVD** first.

- During playback, press **FWD** ►► or **REV** ◄◄. Every time you press **FWD** ►► or **REV** ◄◄, approximate speed will change as follows.

press button	-3	-2	-1	0	+1	+2	+3
►►: +1 ◄◄: -1							
speed (DVR/DVD)	x40	x20	x1	Normal speed	x1.5	x20	x40
speed (CD)	-	-	x8	Normal speed	x8	-	-
speed (MP3)	-	-	x16	Normal speed	x16	-	-
OSD indication	◄◄◄	◄◄	◄		►	►►	►►►

For DVR / DVD discs :

Sound will be output only during x1.5 fast forward if you set **“Fast Forward with Audio”** to **“On”** in the Setup Menu, otherwise the sound will be muted.

For Audio CDs :

approximate speed is fixed at x8 with sound.

For MP3 files :

approximate speed is fixed at x16.

- To return to the normal playback, press **PLAY** ►.
- Fast forward or fast reverse playback across titles (for DVD discs) or tracks (for MP3) is not possible.
- Fast forward or fast reverse is not available for WMA files.

Special Playback (Cont'd)

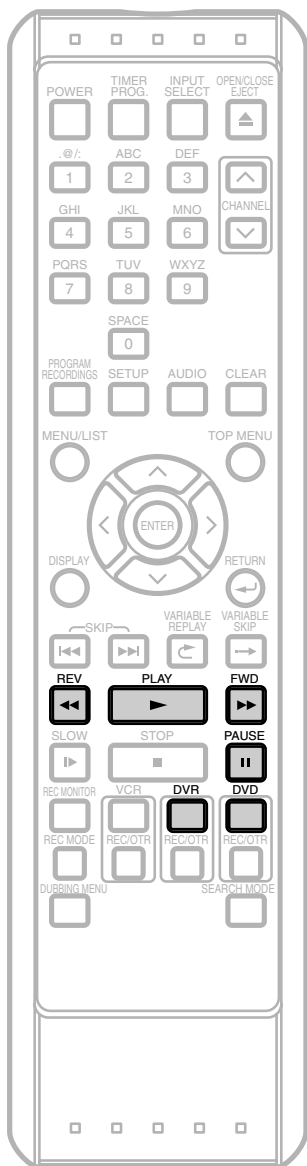

Slow forward / Slow reverse Playback



If you are playing the DVR, press **DVR** first.

If you are playing a disc, press **DVD** first.

1 During playback, press **PAUSE** **II**.

2 Press **FWD** **▶▶** or **REV** **◀◀**.

Every time you press **FWD** **▶▶** or **REV** **◀◀**, approximate speed will change as follows.

The sound will remain muted.

press button	-3	-2	-1	0	+1	+2	+3
▶▶: +1 ◀◀: -1							
speed (DVR/DVD)	x1/4	x1/8	x1/16	Normal speed	x1/16	x1/8	x1/2
OSD indication	▶▶▶▶	▶▶▶	▶▶		▶▶	▶▶▶	▶▶▶▶

• To return to the normal playback, press **PLAY** **▶**.

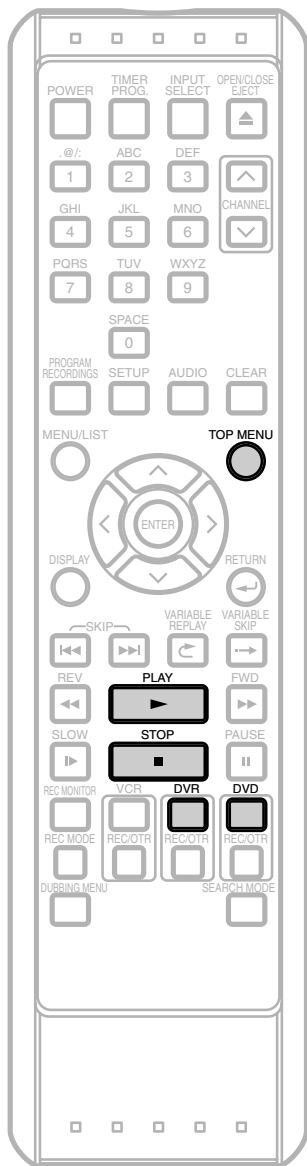

Time Shift Playback



You can playback a title being recorded from the beginning while recording continues.

Press **DVR** first.

- 1** Press **PLAY ►** during recording.
Playback of the title you are recording will start from the beginning.
 - Elapsed playback time will be displayed in the Front Panel Display.
- 2** To stop the playback, press **STOP ■ ONCE**.
 - The Front Panel Display will switch back to show the elapsed recording time.

IMPORTANT: If you press **STOP ■** twice, it will stop the recording.

Simultaneous Playback and Recording



You can playback a title on one device while making a recording on other device.
To do so, simply select the device you like to use for the playback by pressing the device select button (DVR, DVD, or VCR) during recording, then follow the normal procedure of playback.

Only in regard to the DVR, you can playback a title in the same device (DVR).
To do so, press **TOP MENU** during recording and select a title you like to play, and then press **PLAY ►**.
To playback a title being recorded while continuing to record, refer to 'Time Shift Playback' on this page.

Special Playback (Cont'd)

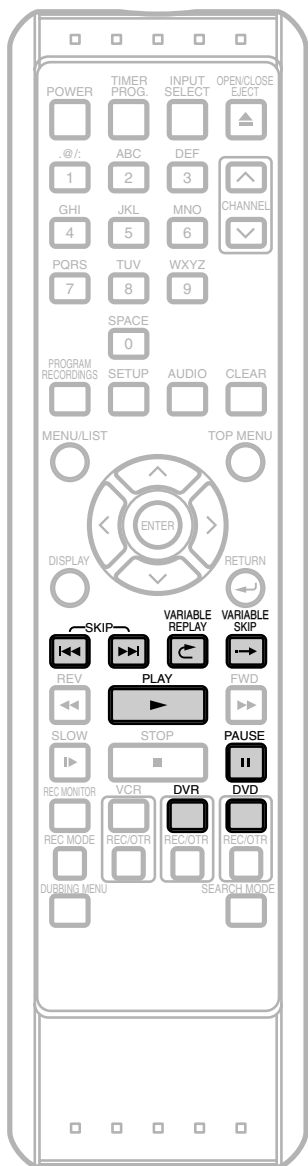

Pause



If you are playing the DVR, press **DVR** first.
If you are playing a disc, press **DVD** first.

- 1 During playback, press **PAUSE II**.
Playback will pause and sound will be muted.



- 2 Press **PLAY ►** to resume play.

Step-by-Step Playback



- 1 During playback, press **PAUSE II**.
Playback will pause and the sound will be muted.



- 2 Press **SKIP ◀◀** or **▶▶** repeatedly.
Every time you press **SKIP ◀◀** or **▶▶**, the playback will go backward or forward one frame at a time.
- 3 Press **PLAY ►** to resume normal playback.

Variable Replay / Variable Skip



During playback, you can skip forward or backward by the amount of time you set in the Setup Menu with just one touch.

To set the time amount, refer to '6. Variable Replay / Skip Speed' on page 116.

If you are playing the DVR, press **DVR** first.
If you are playing a disc, press **DVD** first.

Press **VARIABLE SKIP ►** if you want to skip forward.
Press **VARIABLE REPLAY ◀** if you want to skip backward.

Special Playback (Cont'd)

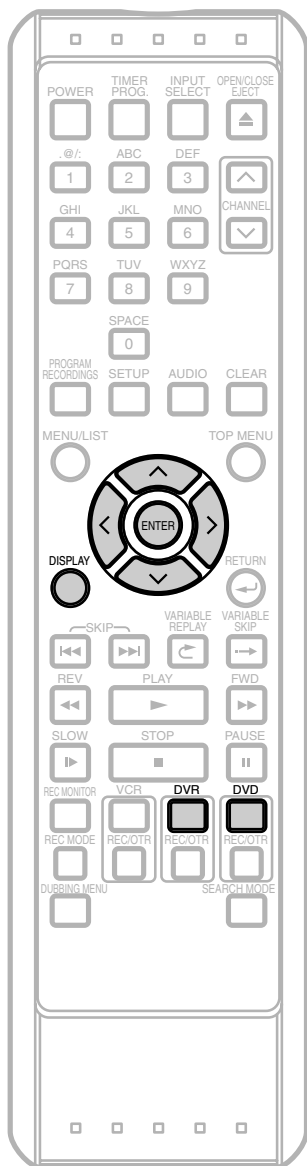

Zoom



If you are playing the DVR, press **DVR** first.
If you are playing a disc, press **DVD** first.

- 1 During playback, press **DISPLAY** twice.
Icons for the available features will appear.

Example: DVD-Video

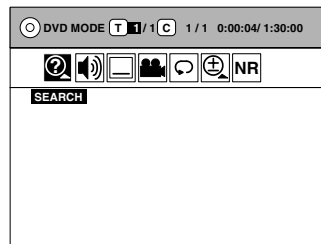

- 2 Using **< / >**, select  icon. Press **ENTER**.
Option window will appear.

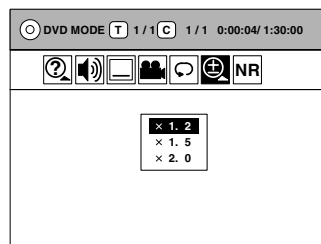

There are four options (x1.0, x1.2, x1.5 and x2.0), which will be displayed excluding the current zoom rate.

- 3 Using **^ / v**, select a desired zoom factor to zoom.
Press **ENTER**.

The zoom box will be displayed.

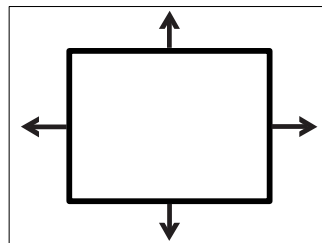

- If you want to go back to the previous screen and reselect the zoom factor, press **RETURN** .

- 4 Using **^ / v / < / >**, move the zoom box to the area you want to zoom. Press **ENTER**.

The selected area is zoomed.

Note

- When selecting a smaller factor than the current one, the zoom box will not be displayed.
- To cancel the zoom, select "**x1.0**" using **^ / v**, then press **ENTER**.

Special Playback (Cont'd)

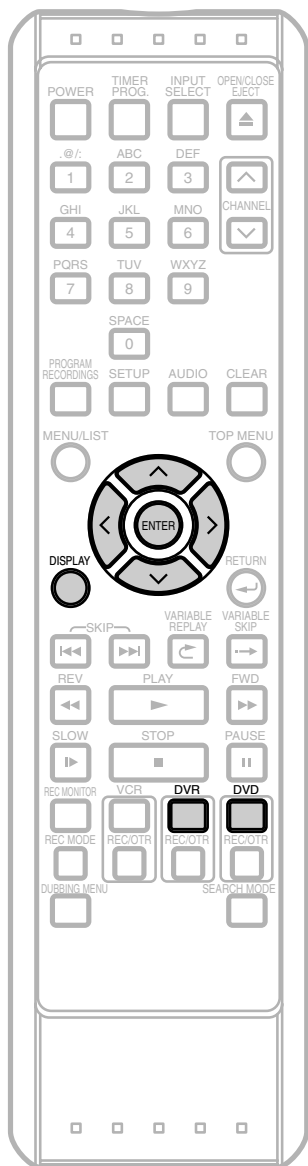

Repeat Playback



If you are playing the DVR, press **DVR** first.

If you are playing a disc, press **DVD** first.

- 1 During playback, press **DISPLAY** twice.
Icons for the available features will appear.
Example: VR mode DVD-RW disc

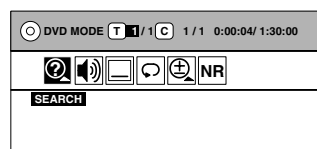

- 2 Using **< / >**, select icon. Press **ENTER**.
Option window will appear.

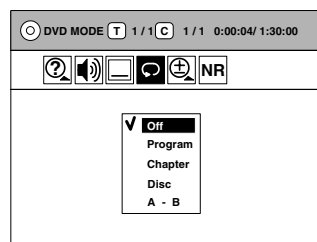

- 3 Using **^ / v**, select a desired option for repeat playback. Press **ENTER**.

The selected repeat playback will start.

Program: (DVR/DVD only) (Not available during Time Shift Playback)

The current title will be played back repeatedly.

Chapter: (DVR/DVD only) (Not available during Time Shift Playback)

The current chapter will be played back repeatedly.

Disc: (CD, MP3 / WMA, VR mode DVD-RW disc only)

The current disc will be played back repeatedly.

A-B: (DVR/DVD/CD only)

The part between the point A and B will be played back repeatedly.

1. Using **^ / v**, select **"A-B"**, then press **ENTER**.

2. Play back the title up to the point where you want to set point **"A"**. Then, press **ENTER**.

3. Play back the title up to the point where you want to set point **"B"**. Then, press **ENTER**.

The A-B Repeat Setting is now activated.

Track: (CD, MP3 / WMA only)

The current track will be played back repeatedly.

Group: (MP3 / WMA only)

The current group will be played back repeatedly.

Note

- The A-B Repeat Playback can only be set within the current title (for DVDs), or current track (for Audio CDs).
- To cancel the repeat playback, select **"Off"** at step 3. The Repeat Setting will be also cleared when you stop playback.
- Group Repeat is not available during the Random Playback.

Special Playback (Cont'd)

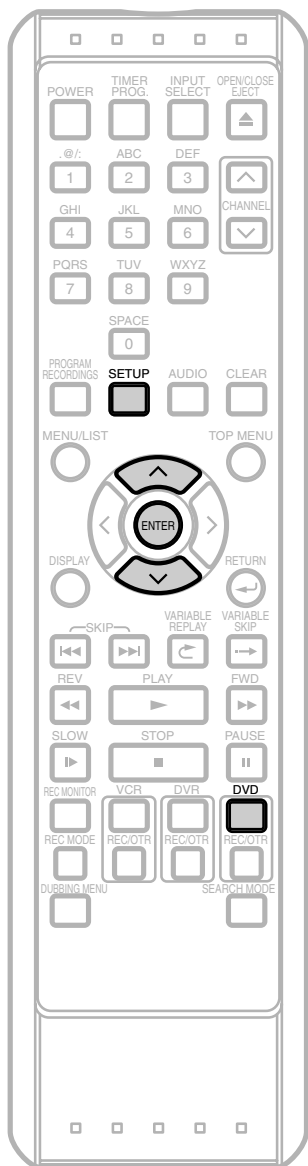

Random Playback



You can play back a disc randomly instead of playing back in the original order.

- 1 Press **SETUP**.
“Easy Setting Menu” or “Advanced Menu” will appear.

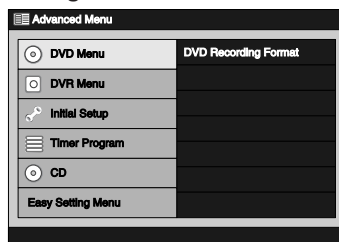

- 2 Using \wedge / \vee , select “CD”. Press **ENTER**.
Example: CD

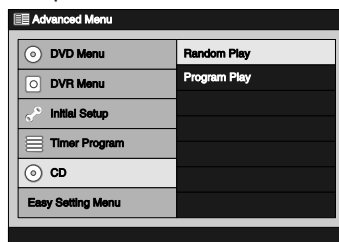

- 3 Using \wedge / \vee , select “Random Play”. Press **ENTER**.
Random Playback will start.

Note

- To cancel Random Playback, press **STOP** ■ twice during Random Playback.

Special Playback (Cont'd)

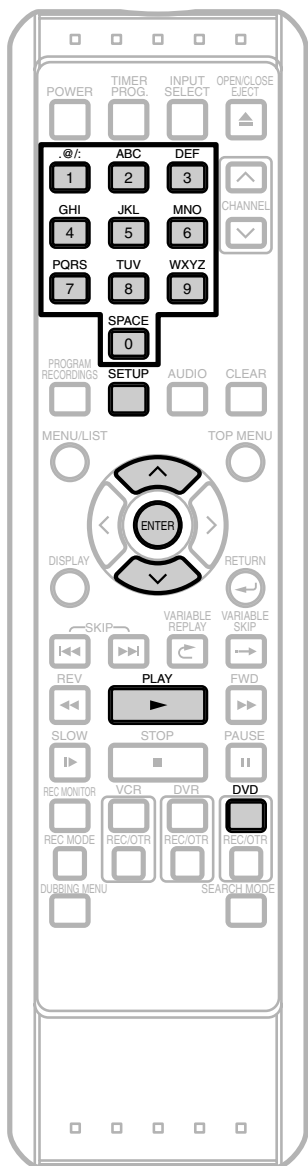

Program Playback



You can program a playback sequence in your desired order.

- 1 Press **SETUP**.
“Easy Setting Menu” or “Advanced Menu” will appear.

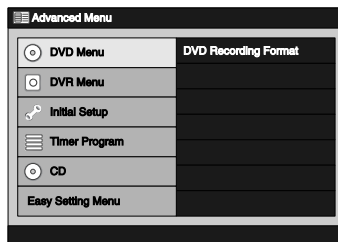

- 2 Using \wedge / \vee , select “CD”. Press **ENTER**.

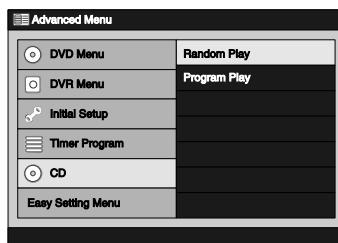

- 3 Using \wedge / \vee select “Program Play”. Press **ENTER**.

Program Play Screen will appear.

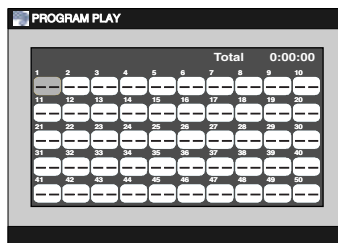

- 4 Using \wedge / \vee or the **Number Buttons**, enter a desired track. Press **ENTER** or $\>$.

A cursor will move to the next.

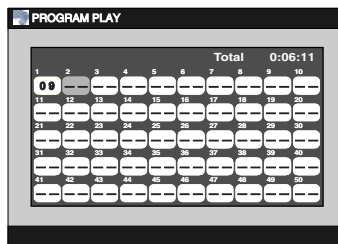

- 5 Press **PLAY** \blacktriangleright to start Program Playback.
Program Playback will start.

- When you enter a single digit number using the **Number Buttons**, press the number directly without pressing **0** first.

Note

- To erase tracks you entered, select the track and then press **CLEAR**.
- You can make up to 50 program settings.
- To cancel Program Playback, press **STOP** \blacksquare twice during Program Playback.
- The program will remain memorized unless you open / close the disc tray or turn off the power.

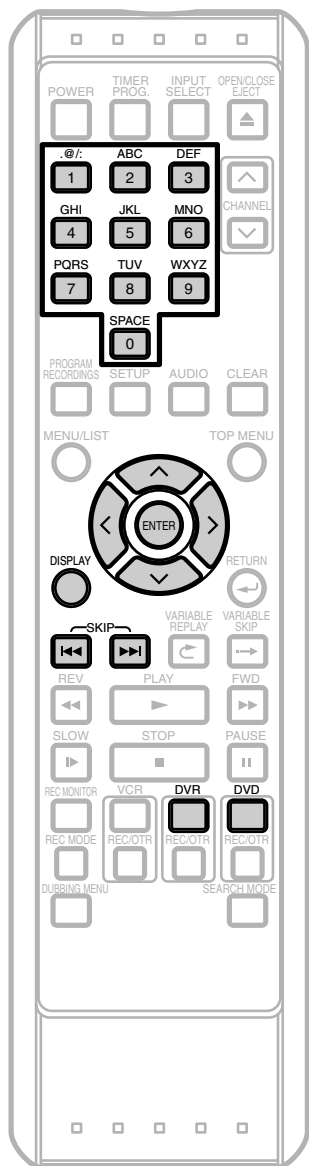

Title / Chapter Search



If you are playing the DVR, press **DVR** first.
If you are playing a disc, press **DVD** first.

Using SKIP ◀◀ / ▶▶

- 1 During playback, press **SKIP ▶▶** to skip to the next title or chapter.
Press **SKIP ◀◀** once to skip back to the beginning of the current title or chapter. Press **SKIP ◀◀** twice to skip back to the previous title or chapter.

Using DISPLAY

- 1 During playback, press **DISPLAY** twice.
Icons for the available features will appear.
- 2 Using < / >, select icon. Press **ENTER**.
The title number next to will be highlighted.

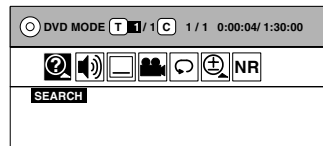

Title:

Using **^ / v** or **the Number Buttons**, enter a desired title number to search. Then, press **ENTER**.
Title Search will start.

Chapter:

Using **>**, move to the number next to for chapter.
Using **^ / v** or **the Number Buttons**, enter a desired chapter number to search. Then, press **ENTER**.
Chapter Search will start.

Note

- In Search Mode Display, total numbers of each search contents (title / chapter / time) are shown as a denominator.

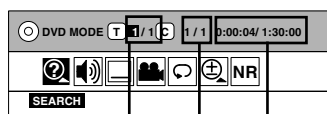

Current title number / Total number of titles
Current chapter number / Total number of chapters
Elapsed time of the current title / Total time of the current title

Search (Cont'd)

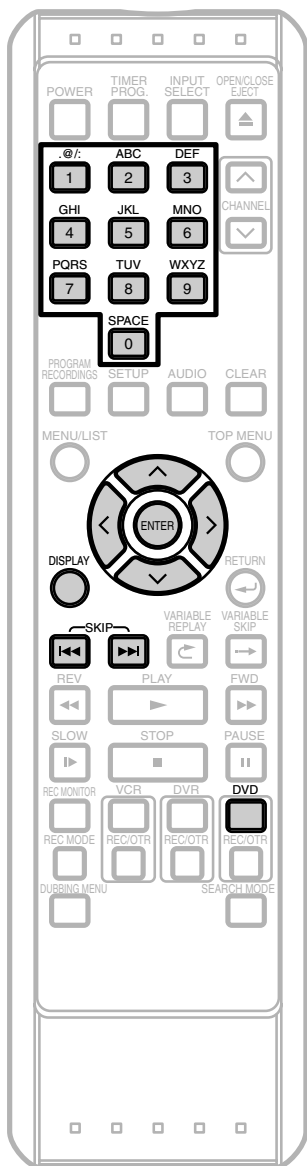

Track Search



Press **DVD** first.

Using **SKIP** ◀◀ / ▶▶

- 1 During playback, press **SKIP** ▶▶ to skip to the next track.
Press **SKIP** ◀◀ once to skip back to the beginning of the current track.
Press **SKIP** ◀◀ twice to skip back to the previous track.

Using **DISPLAY**

- 1 During playback, press **DISPLAY** twice.
Icons for the available features will appear.
- 2 Using < / >, select  icon. Press **ENTER**.
The track number next to **T** will be highlighted.

Example: CD

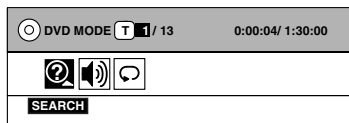

- 3 Using ^ / v or the **Number Buttons**, enter a desired track number to search. Press **ENTER**.
Track Search will start.

Search (Cont'd)

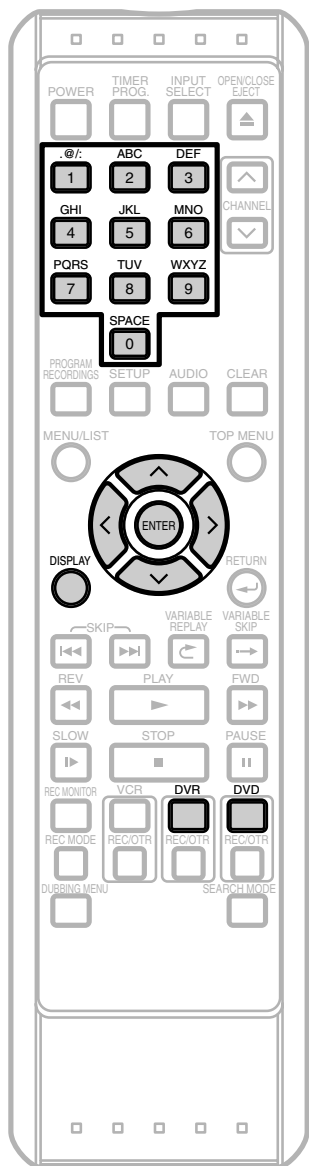

Time Search



If you are playing the DVR, press **DVR** first.
If you are playing a disc, press **DVD** first.

- 1 During playback, press **DISPLAY** twice.
Icons for the available features will appear.
- 2 Using **< / >**, select  icon. Press **ENTER**.
The number next to **T** will be highlighted.
Example: DVD

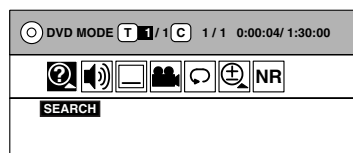

- 3 Move the cursor to the elapsed time counter using **>**.
When Time Search is not available, "--:--:-- / --:--:--"
("0:00:00 / 0:00:00" for CD) is displayed instead
of time count.

Elapsed time counter

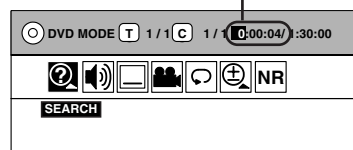

- 4 Using **^ / v** or the **Number Buttons**, enter a
desired time to search. Press **ENTER**.
Time Search will start.

Note

- Time Search is available only within the same track or title.

Search (Cont'd)

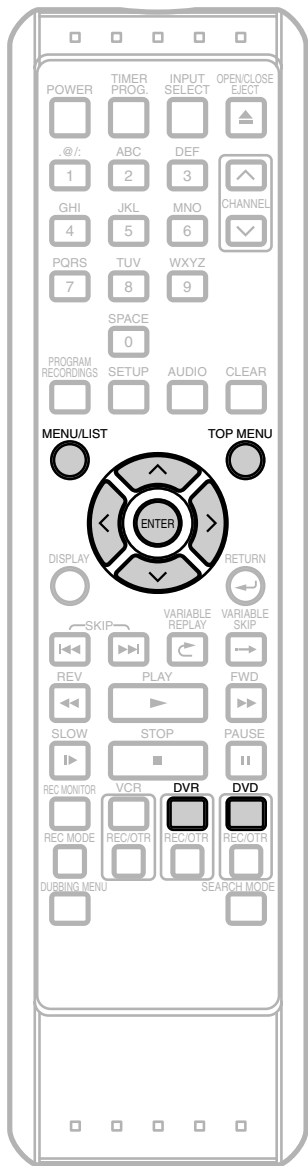

Series Search



You can search for the group of titles made with the same Periodical Timer Recordings. We refer to such a group of titles as “series”. This feature is available only with the DVR. Press **DVR** first.

- 1 Press **TOP MENU**.
Title List will appear.

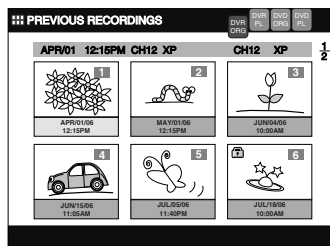

Press **MENU / LIST** to switch Original List / Playlist if necessary.

- 2 Using **^ / v**, select any title that belongs to the series you want to search and press **ENTER**.
Title List Menu will appear.

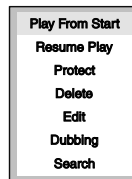

- 3 Using **^ / v**, select “**Search**”. Press **ENTER**.
Series List will appear.

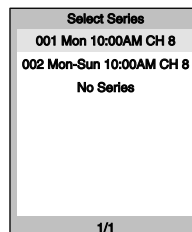

Highlight will be on the series that contains the selected title.

Search (Cont'd)

- 4** Using \wedge / \vee , select the desired series. Press **ENTER**.

Title List of the selected series will appear.

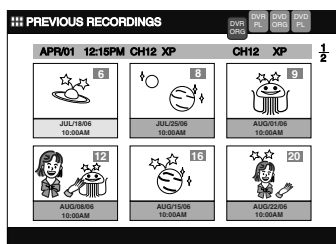

- 5** Using $\wedge / \vee / \leftarrow / \rightarrow$, select a desired title to play, then press **PLAY** \blacktriangleright . Or press **ENTER** to call up the Title List Menu and select your desired playback style. To show the regular Title List, select **“Display All Program”** from the Title List Menu. Then press **ENTER**.

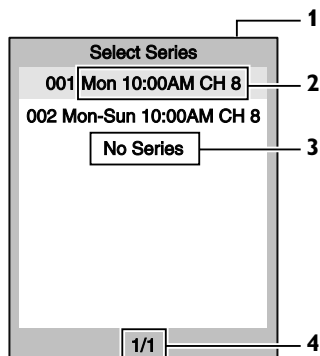

- Series List**
 - Up to 8 series can be displayed on 1 page.
 - The series that contains the oldest title comes first on the list.
- Information on the series.**
 - Type of the Periodical Recording (ex. every Monday), start time, and the recording channel. (In the example here, the information tells you this series is recorded on every Monday, starting at 10:00 AM on channel 8.)
- No Series**
 - All recordings which are not periodical fall into this category.
 - “No Series”** will always be at the last on the list.
- Current page / Total number of pages.**
 - Up to 38 pages (300 series) are available.

Note

- The unit exits the Series Search mode when you switch the list type or the device mode.

Selecting a Format of Audio and Video

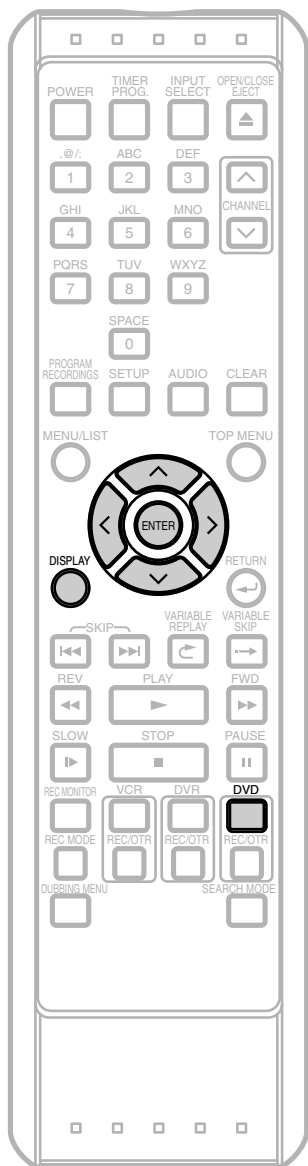

Switching Subtitles



Many DVD-Video discs have subtitles in one or more languages. Available languages are usually written on their packages. You can switch subtitle languages anytime during playback. Available language vary among discs.

Press **DVD** first.

- 1 During playback, press **DISPLAY** twice. Icons for the available features will appear.

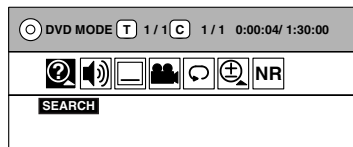

- 2 Using **< / >**, select  icon. Press **ENTER**. Subtitle Menu will appear.

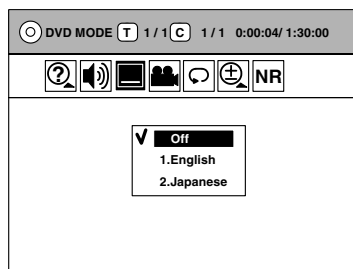

- If you are playing a VR mode DVD-RW disc, “**Off**” or “**On**” will be the only option.

- 3 Using **^ / v**, select a desired subtitle language. Press **ENTER**.

Subtitles will be displayed in the selected language. When selecting “**Off**”, subtitles will disappear.

Note

- Some discs will only allow you to change subtitles from the Disc Menu. Press **MENU / LIST** to display the Disc Menu.
- If a 4-digit language code appears in the Subtitle Menu at step 2, refer to ‘Language Code’ on page 135.

Selecting a Format of Audio and Video (Cont'd)

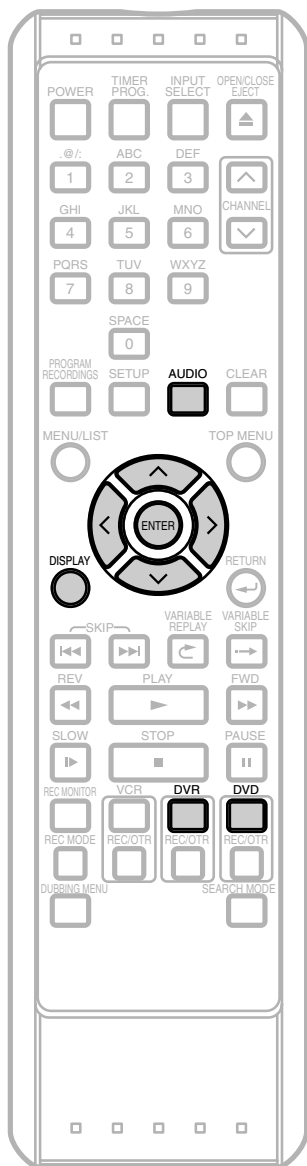

Note

- Some discs will only allow you to change the soundtrack from the Disc Menu. Press **TOP MENU** to display the Disc Menu.
- Although this unit cannot record both Stereo (main) and SAP(sub) at the same time, some VR mode DVD-RW discs may contain both audio. With such discs, you can select either Main (L), Sub(R) or both (L+R) as your playback audio.

Switching Audio Soundtrack



When playing back a title recorded with two or more soundtracks (these are often in different languages), you can switch between them during playback.

When playing back Audio CDs or MP3 /WMA files, you can switch among stereo, the left channel only and the right channel only.

If you are playing the DVR, press **DVR** first.

If you are playing a disc, press **DVD** first.

- 1 During playback, press **AUDIO** to call up the available audio settings on the TV screen (see examples below).

Example: DVD-Video

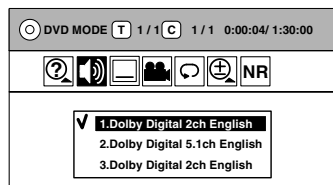

Example: CD/ MP3/WMA

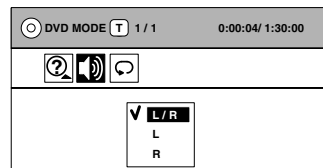

- 2 Using \wedge / \vee , select the desired setting, then press **ENTER** to activate the setting.

As in the example below, if the title contains both main and sub audio, you can further select “L” (main), “R” (sub), or “L/R” (mixed of main and sub).

Example:VR mode DVD-RW disc

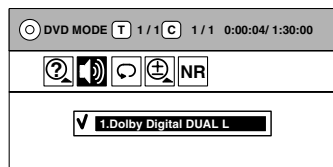

Press **ENTER**.

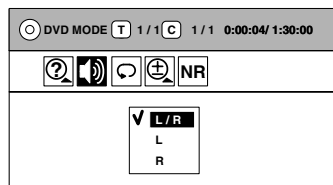

Using \wedge / \vee , select the desired setting, then press **ENTER** to activate the setting.

- 3 **DISPLAY** button can also lead you to the **AUDIO** Menu. Simply press **DISPLAY** twice during playback to show the icons for the available features, then using \langle / \rangle , select and press **ENTER**.

Selecting a Format of Audio and Video (Cont'd)

Switching Camera Angles



Some DVD-Videos contain the scenes shot from multiple angles. In those scenes you can change the camera angles by following the steps below. Changing angles is available only where scenes are shot from different angles.

Press **DVD** first.

- 1 During playback, press **DISPLAY** twice.
Icons for the available features will appear.

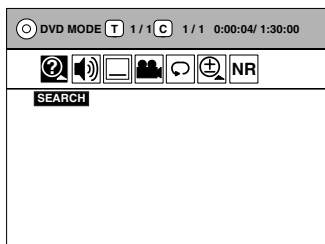

If you set the Angle Icon Setting to “**On**” in the Setup Menu (see page 117), an angle icon will appear at the bottom right corner of the TV screen in scenes where different camera angles are available.

- 2 Using **< / >**, select icon. Press **ENTER**.
Angle will change each time you press **ENTER**.

Note

- will appear when Angle feature is not available.

Visual Noise Reduction



This feature allows you to reduce visual noise during playback.

If you are playing the DVR, press **DVR** first.
If you are playing a disc, press **DVD** first.

- 1 During playback, press **DISPLAY** twice.
Icons for the available features will appear.

Example: DVD-Video

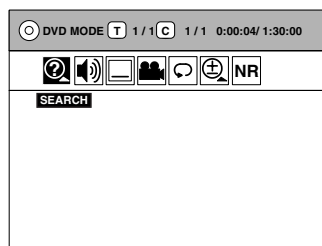

- 2 Using **< / >**, select icon. Press **ENTER**.
Option window will appear.

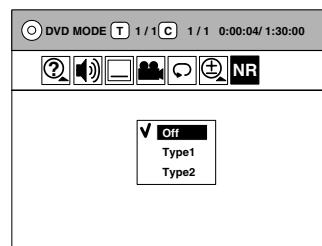

Off: When playing back titles with a few noises such as DVD-Video discs.

Type 1: For the titles recorded in long time mode such as SLP or SEP mode.

Type 2: Same as type 1, only more effective.

- 3 Using **^ / v**, select a desired option. Press **ENTER**.
Your setting is now activated.

Information on Disc Editing

Guide to the Title List

When you record programs to the DVR / DVD, a title list will be created. Title list is the thumbnails of the recorded programs (titles). You can call up the Title List by pressing **TOP MENU** and select the title of your choice from the list and can play or edit it from the Title List Menu.

- Selected device (DVR or DVD) and selected list type (Original List or Playlist)
- The number of the current Title List page / the total number of the Title List pages
Use **FWD** ►► to jump to the next page. Use **REV** ◀◀ to jump to the previous page. Use < / > to move among titles one by one.
- Title name, recorded channel and Rec Mode (if the title name has not been assigned yet, the date and the time the recording was made, the recorded channel (Original List/Titles in the DVR or VR mode DVD-RW only), the Rec Mode (Original List only) will be assigned as the title name automatically)
- Thumbnails of the titles
Only the highlighted thumbnail can be seen in motion.
- Date and time the title was recorded.
- Protected icon
This icon appears only when the title is protected (Original List only).
- Status bar
- Preview window
- Progress bar
- Command bar

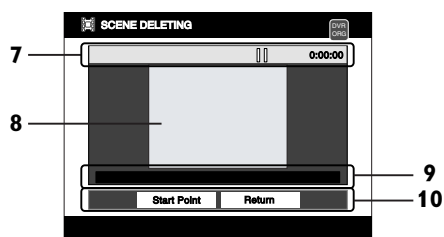
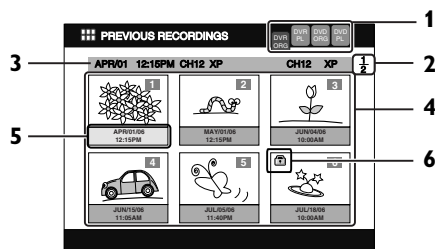

What are Original List and Playlist?

There are 2 types for the title list: Original List and Playlist.

Original List:

Original List is the list of the recorded programs (titles) which are created automatically when they are recorded. Original List is available for DVR, DVD-RW, and DVD-R. Please note that editing the titles in the Original List is like editing the original data. For example, if you erase a title in the Original List, the title cannot be recovered. So, please be careful when you work in the Original List.

Playlist:

Playlist is the copy of the Original List. You can edit the titles in the Playlist as you like without affecting the Original data in the Original List. It works like a back up for the Playlist. Deleting a title from the Playlist does not delete the corresponding title in the Original List, but deleting a title from the Original List also deletes the corresponding title in the Playlist. With DVR and VR mode DVD-RW, the Playlist is created automatically. Playlist is available only for the DVR and the VR mode DVDs. **There is no Playlist for the Video mode DVDs.**

Available Menus (o = Available, x = Not Available)

	Item	Media					Page	Description
		DVR		Video Mode DVDs	VR mode DVDs			
		Original	Playlist	Original	Original	Playlist		
Title List Menu	Play from Start	o	o	o	o	o	69	To play from the beginning of the title.
	Resume Play	o	o	x	x	x	72	To resume playback from the point where it is stopped last time.
	Protect/Undo Protect	o	x	x	o	x	93	To protect/undo protect the title.
	Delete	o	o	o	o	o	90-91	To delete a title.
	Edit	o	o	o	o	o	-	
	Dubbing	o	o	x	x	x	48	To make copies.
Edit Menu	Search	o	o	x	x	x	84-85	To search for the group of titles made with the same Periodical Timer Recordings.
	Protect/Undo Protect	o	x	x	o	x	93	To protect/undo protect the title.
	Delete	o	o	o	o	o	90-91	To delete a title.
	Edit Title Name	o	o	o	o	o	94-95	
	Scene Delete	o	o	x	o	o	96-97	To delete a part of the title.
	Divide	x	o	x	x	o	98-99	To divide a title into two titles.
	Combine	x	o	x	x	o	100-101	To combine two titles into one.
	Move	x	o	x	x	o	102-103	To rearrange the order of the Title List.
	Chapter Marker	o	o	x	o	o	104-107	To add/delete the chapter marks.
	Add To Playlist	o	o	x	o	o	108-109	To add a title to the Playlist.

Deleting Titles

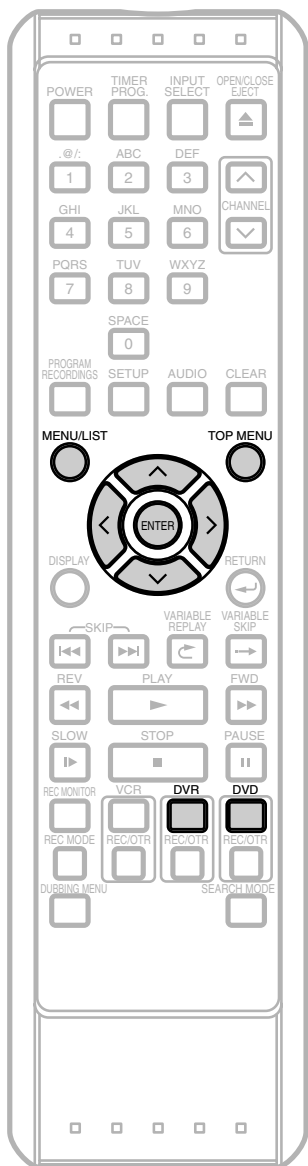

Deleting Selected Titles



[VIDEO] [VR] [ORIGINAL] [PLAYLIST]

You can delete titles which you do not need anymore. Be advised that the titles once deleted cannot be recovered.

With DVD-R discs, deleting titles will not affect the recordable disc space.

With Video mode DVD-RW discs, the disc space will increase only when the last title in the Original List is deleted.

With VR mode DVD-RW discs, the disc space will increase when any title in the Original List is deleted. Deleting a title in the Playlist will not delete the corresponding title in the Original List.

If you are playing the DVR, press **DVR** first.
If you are playing a disc, press **DVD** first.

1 Press **TOP MENU**.

Title List will appear.

Example: DVR Original List

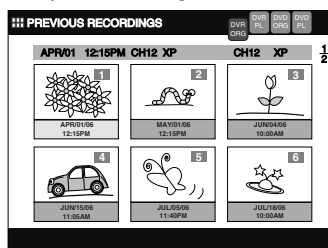

Press **MENU / LIST** to switch Original List / Playlist if necessary.

2 Using **^ / v / < / >**, select a desired title to delete. Press **ENTER**.

Title List Menu will appear.

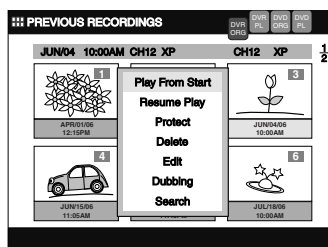

Deleting Titles (Cont'd)

- 3** Using \wedge / \vee , select **“Delete”**. Press **ENTER**.
Confirmation window will appear.

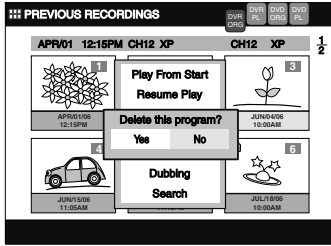

- 4** Using \langle / \rangle , select **“Yes”**. Press **ENTER**.
Final confirmation window will appear.

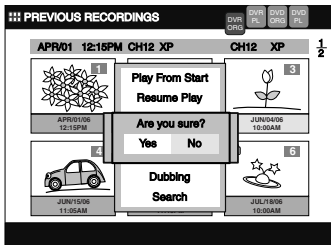

- 5** Using \langle / \rangle , select **“Yes”**. Press **ENTER**.
The selected title is now deleted.

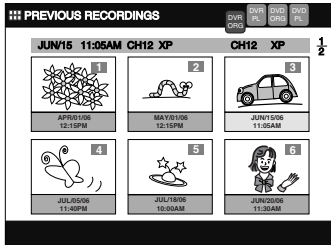

- 6** Press **TOP MENU** to exit.

Note

- When a title is deleted from an Original List, corresponding title on the Playlist(s) will be also deleted.
- Deleting a Playlist will not increase the recordable disc space.

Deleting Titles (Cont'd)

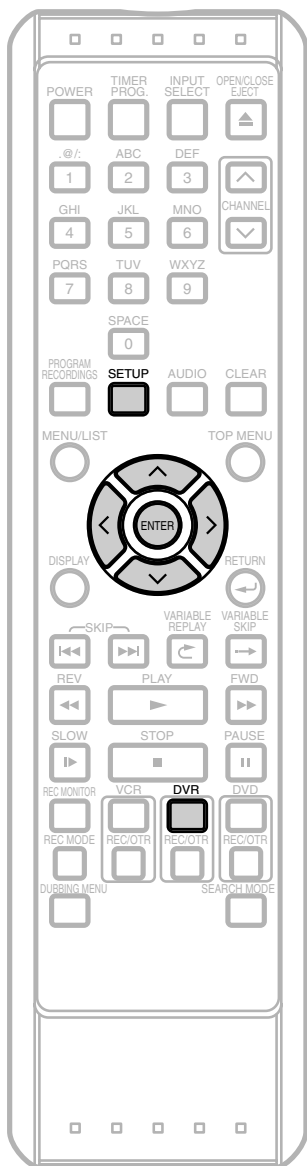

Deleting all Titles in DVR



[ORIGINAL] [PLAYLIST]

Press **DVR** first.

- 1 Press **SETUP**.
“Easy Setting Menu” or “Advanced Menu” will appear.

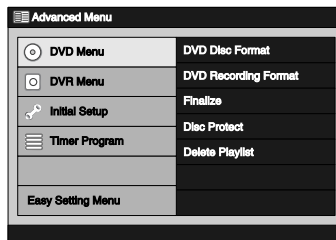

- 2 Using \wedge / \vee , select “DVR Menu”.
Press **ENTER**.

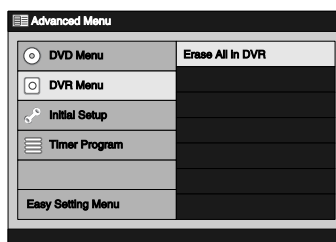

- 3 With “Erase All in DVR” selected, press **ENTER**.
Option window will appear.



- 4 Using \wedge / \vee , select desired option. Press **ENTER**.
Confirmation window will appear.

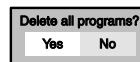

- 5 Using \lt / \gt , select “Yes”. Press **ENTER**.
Final confirmation window will appear.

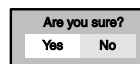

- 6 Using \lt / \gt , select “Yes”. Press **ENTER**.
All titles in the selected list are erased.

Protecting / Undo Protecting Titles

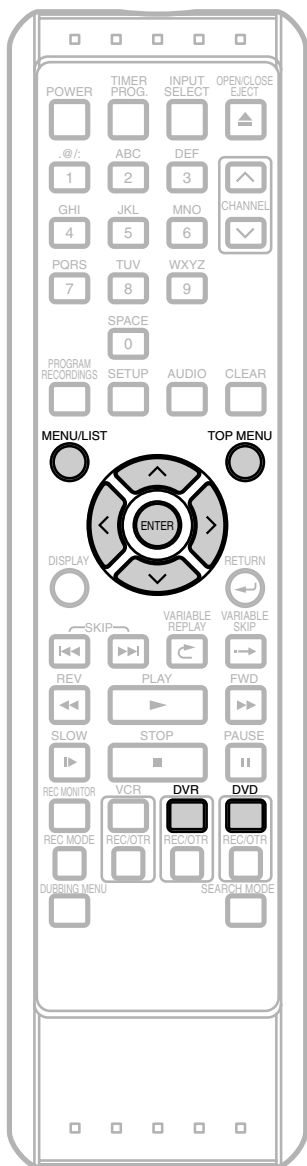

[VR] [ORIGINAL]

To prevent accidental editing or title erasing, you can protect the contents in the Original List.

If you are playing the DVR, press **DVR** first.

If you are playing a disc, press **DVD** first.

1 Press **TOP MENU**.

Title List will appear.

Example: DVR Original List

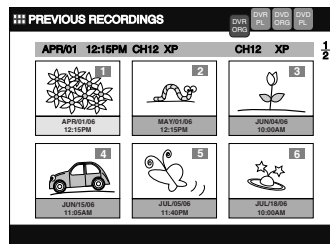

Press **MENU / LIST** to switch to Original List if necessary.

2 Using $\wedge / \vee / < / >$, select a desired title to protect. Press **ENTER**.

Title List Menu will appear.

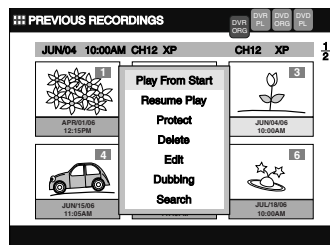

3 Using \wedge / \vee , select "**Protect**". Press **ENTER**.

The key icon will appear at the upper left corner of the thumbnail.

If the title has already been protected "**Undo Protect**" will be listed in the Title List Menu instead of "**Protect**". To cancel the protection, select "**Undo Protect**" and press **ENTER**. The key icon will disappear.

4 Press **TOP MENU** to exit.

To protect the disc itself, refer to 'Protecting a Disc' on page 62.

Editing Title Names

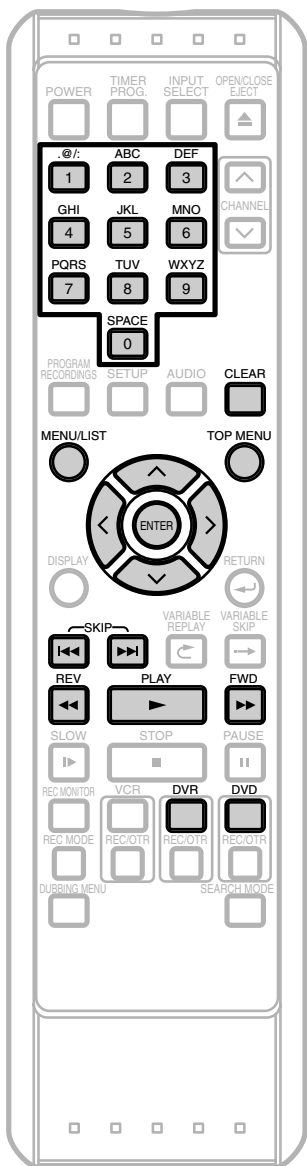

[VIDEO] [VR] [ORIGINAL] [PLAYLIST]

You can name titles and change the names from this menu. The names you put on the titles will be displayed on a Title List.

If you are playing the DVR, press **DVR** first.

If you are playing a disc, press **DVD** first.

- 1 Press **TOP MENU**.
Title List will appear.

Example: DVR Original List

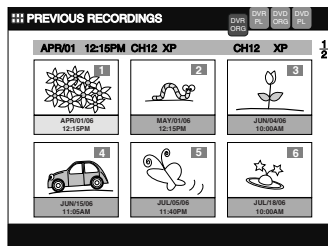

Press **MENU / LIST** to switch Original List / Playlist if necessary.

- 2 Using **^ / v / < / >**, select a desired title to edit. Press **ENTER**.
Title List Menu will appear.

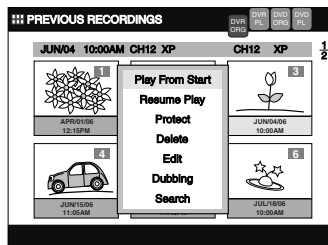

- 3 Using **^ / v**, select **“Edit”**, then press **ENTER**.
Edit Menu will appear.

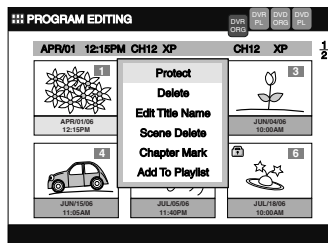

Editing Title Names (Cont'd)

- 4** Using \wedge / \vee , select “Edit Title Name”, then press **ENTER**.
Editing Screen will appear.

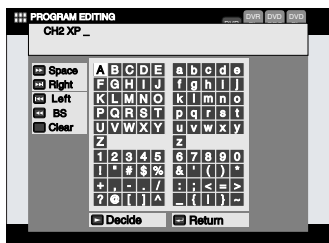

- 5** To enter a title name, refer to ‘Guide to Edit Title Name’ below.

- 6** When you finish entering the title name, press **PLAY ▶**. Or using $\wedge / \vee / < / >$, select “Decide”, then press **ENTER**.
Your setting is now activated.

- 7** Press **TOP MENU** to exit.

Guide to Edit Title Name

Method 1: By selecting the letters on the screen:

Using $\wedge / \vee / < / >$, move to a desired letter or a command key, then press **ENTER**.
The selected letter will be entered in the field at the top of the screen.

Method 2: By entering the letters directly using the Number Buttons:

Following the list below, press the **Number Buttons** repeatedly until the desired letter appears.

Press			
0	space	, 0	
1	.	@ / : 1	
2	ABC	abc	2
3	DEF	def	3
4	GHI	ghi	4
5	JKL	jkl	5
6	MNO	mno	6
7	PQRS	pqrs	7
8	TUV	tuv	8
9	WXYZ	wxyz	9

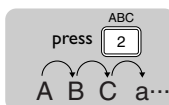

Note:

Unidentified letters in a title name are shown by *. If you delete them, adjoining letters may change to * or other.

- If you want to enter the same letters successively, for example if you want to enter **AA**, press **ENTER** after you enter the first **A** ($\boxed{2}$), then enter the other **A** by pressing ($\boxed{2}$) one more time.
- Press **FWD ▶▶** for a space.
- Press **SKIP ◀◀ / ▶▶** to move the cursor to the left or right.
- Press **REW ◀◀** for a back space.
- Press **CLEAR** to erase all letters entered.
- You can enter up to 64 letters, for the titles in the DVR and the VR mode DVDs.
- You can enter up to 30 letters, for the titles in the Video mode DVDs.

Deleting a Part of a Title

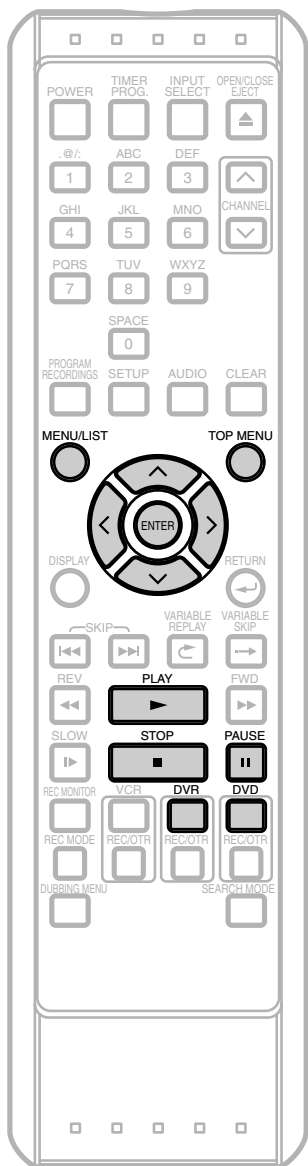

[VR] [ORIGINAL] [PLAYLIST]

You can delete a specific part of a title.

Even if a part of a title is deleted from the Playlist, the title in the Original List will remain as it was, and recordable disc space will not increase.

If you are playing the DVR, press **DVR** first.

If you are playing a disc, press **DVD** first.

- 1 Press **TOP MENU**.
Title List will appear.

Example: DVR Original List

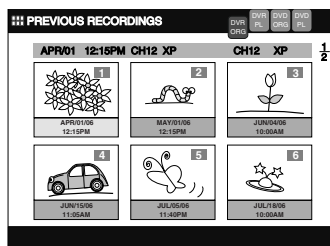

Press **MENU / LIST** to switch Original List / Playlist if necessary.

- 2 Using **^ / v / < / >**, select a desired title to edit. Press **ENTER**.
Title List Menu will appear.

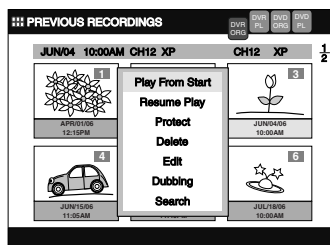

- 3 Using **^ / v**, select **"Edit"**, then press **ENTER**.
Edit Menu will appear.

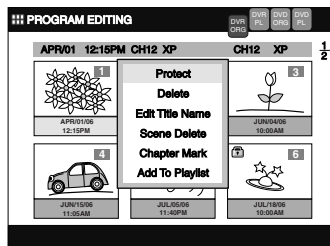

Note

- If a certain scene is deleted from the title in the Original List, the title in the Playlist that contains the corresponding scene will be deleted also.
- When you search for the start/end point, you can use **SKIP** **◀◀ / ▶▶**, **FWD** **◀◀ / REV** **▶▶**, **VARIABLE REPLAY** **↶** / **VARIABLE SKIP** **→→**, **PAUSE** **⏸** or **PLAY** **▶** as usual.

Deleting a Part of a Title (Cont'd)

- 4** Using \wedge / \vee , select **“Scene Delete”**, then press **ENTER**.
Editing Screen will appear.

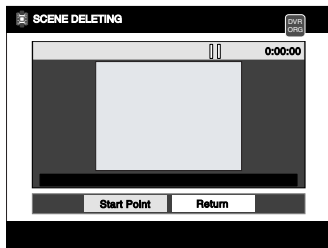

- 5** Press **PLAY** \blacktriangleright to start playback.
Play the title up to the point where you want to set a start point for the scene to be deleted.

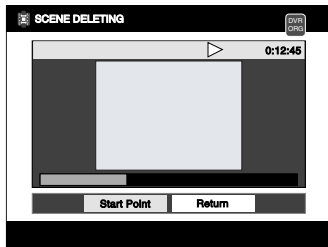

- If you want to quit the process, select **“Return”** with \langle / \rangle . Then press **ENTER**.

- 6** When it reaches the desired start point, press **ENTER**, or press **PAUSE** II or **STOP** \blacksquare and then **ENTER**.
A start point is marked, and the display shown below will appear.

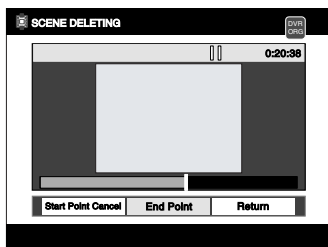

- If you want to reset the start point, select **“Start Point Cancel”** with \langle / \rangle , then press **ENTER**.
- If you want to quit the entire process, select **“Return”** with \langle / \rangle , then press **ENTER**.

- 7** Press **PLAY** \blacktriangleright to start play back again.
Play the title up to the point where you want to set an end point for the scene to be deleted.

- 8** When it reaches the desired end point, press **ENTER**, or press **PAUSE** II or **STOP** \blacksquare and then **ENTER**.
An end point is marked, and the display shown below will appear.

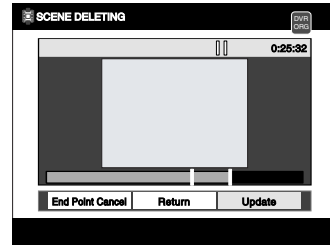

- If you want to reset the end point, select **“End Point Cancel”** with \langle / \rangle , then press **ENTER**.
- If you want to quit the entire process, select **“Return”** with \langle / \rangle , then press **ENTER**.

- 9** With **“Update”** selected, press **ENTER**.
Confirmation window will appear.

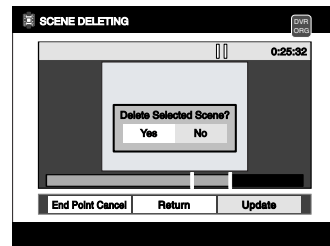

- 10** Using \langle / \rangle , select **“Yes”**, then press **ENTER**.
Final confirmation window will appear.

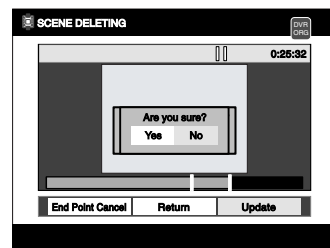

- 11** Using \langle / \rangle , select **“Yes”**, then press **ENTER**.
The scene is now deleted.

- 12** If you want to delete other parts, repeat steps 5-11. Otherwise, select **“RETURN”** and press **ENTER**.
Final confirmation window will appear.
Using \langle / \rangle , select **“Yes”**, then press **ENTER** to finish the editing.

- 13** Press **TOP MENU** to exit.

Dividing a Title

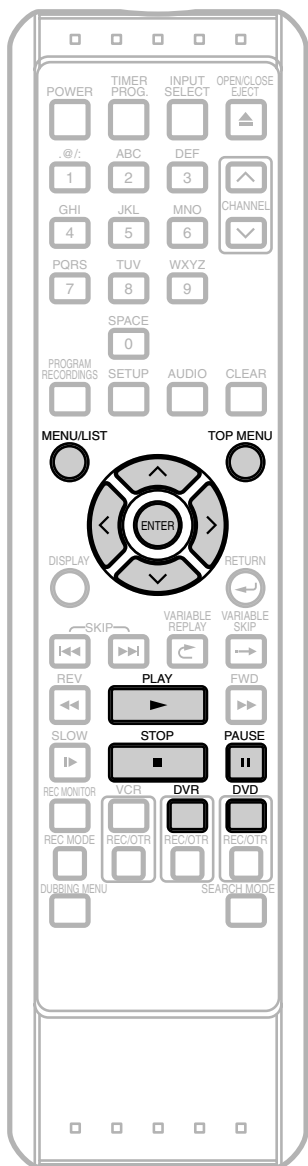

[VR] [PLAYLIST]

You can divide a title into two new titles.

If you are playing the DVR, press **DVR** first.

If you are playing a disc, press **DVD** first.

- 1 Press **TOP MENU**
Title List will appear.

Example: DVR Playlist

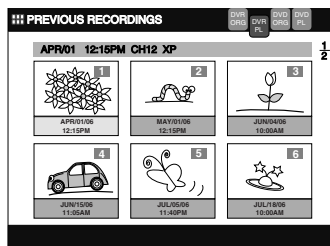

Press **MENU / LIST** to switch to Playlist if necessary.

- 2 Using **^ / v / < / >**, select a desired title to edit. Press **ENTER**.
Title List Menu will appear.

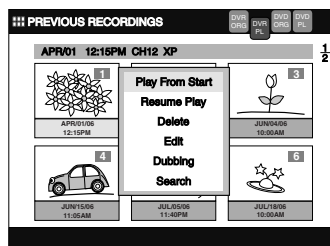

- 3 Using **^ / v**, select **"Edit"**, then press **ENTER**.
Edit Menu will appear.

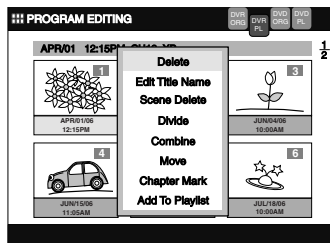

Dividing a Title (Cont'd)

- 4** Using \wedge / \vee , select **"Divide"**, then press **ENTER**.
Editing Screen will appear.

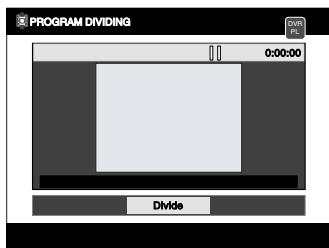

- 5** Press **PLAY** \blacktriangleright to start playback. Play the title up to the point where you want to divide the title.

- 6** When it reaches the desired dividing point, press **ENTER**, or press **PAUSE** II or **STOP** \blacksquare and then **ENTER**.

Confirmation window will appear.

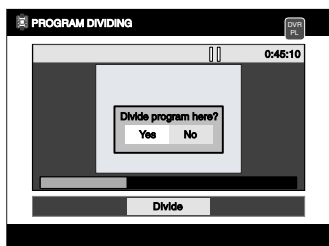

- 7** Using \lt / \gt , select **"Yes"**, then press **ENTER**.
The title is now divided.

- 8** Press **TOP MENU** to exit.

Note

- If a disc contains the maximum number of recordings (DVR:300, DVD-RW disc:99), you cannot divide any titles.
- With DVD-RW disc, you cannot divide the titles if the total number of chapters has already reached 999.
- When you search for the dividing point, you can use **SKIP** \lll / \ggg , **FWD** \lll / REV \ggg , **VARIABLE REPLAY** \curvearrowleft / **VARIABLE SKIP** \curvearrowright , **PAUSE** II or **PLAY** \blacktriangleright as usual.

Combining Titles

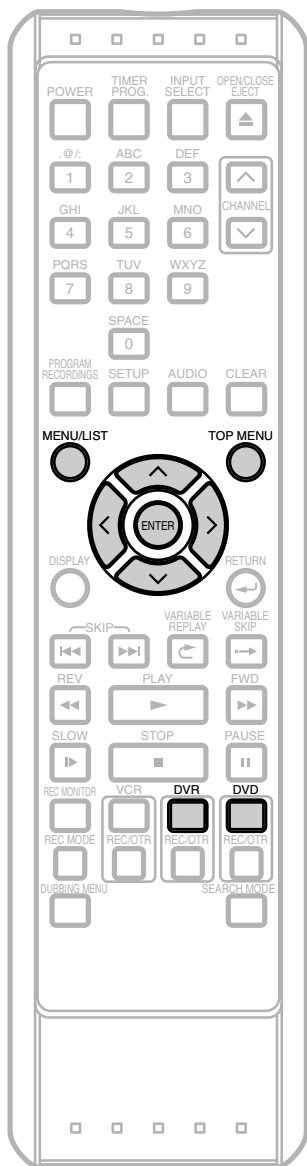

[VR] [PLAYLIST]

You can combine two titles into a single title.

Steps on how to combine title 1 and 2 are shown here as an example.

If you are playing the DVR, press **DVR** first.

If you are playing a disc, press **DVD** first.

1 Press **TOP MENU**.

Title List will appear.

Example: DVR Playlist

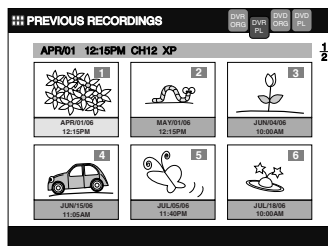

Press **MENU / LIST** to switch to Playlist if necessary.

2 Using **^ / v / < / >**, select a desired title (title 1). Press **ENTER**.

Title List Menu will appear.

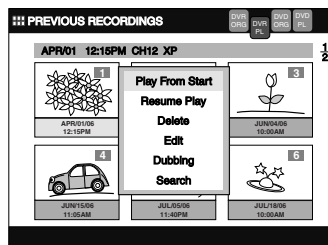

3 Using **^ / v**, select **"Edit"**, then press **ENTER**.

Edit Menu will appear.

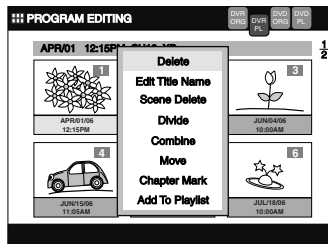

Combining Titles (Cont'd)

- 4** Using \wedge / \vee , select “**Combine**”, then press **ENTER**.

The selected title will disappear temporarily and the frame of the next title will be highlighted.

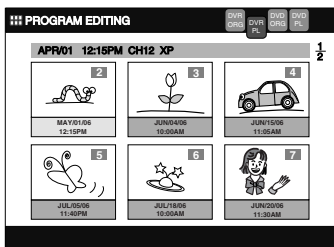

- 5** Using $\wedge / \vee / < / >$, select a title to combine (title 2). Press **ENTER**.

Confirmation window will appear.

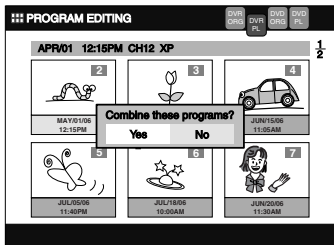

- 6** Using $< / >$, select “**Yes**”. Press **ENTER**.
Two titles will be combined into a single title.

- 7** Press **TOP MENU** to exit.

Note

- If the number of chapter marks in the combined title exceeds 999, the combination will be rejected.
- If one of two titles in the Original List is deleted, the combined new title will be deleted.
- The name of the title selected first will become the name of the combined title.
- The title selected first will be the first half of the combined title.

Moving Titles

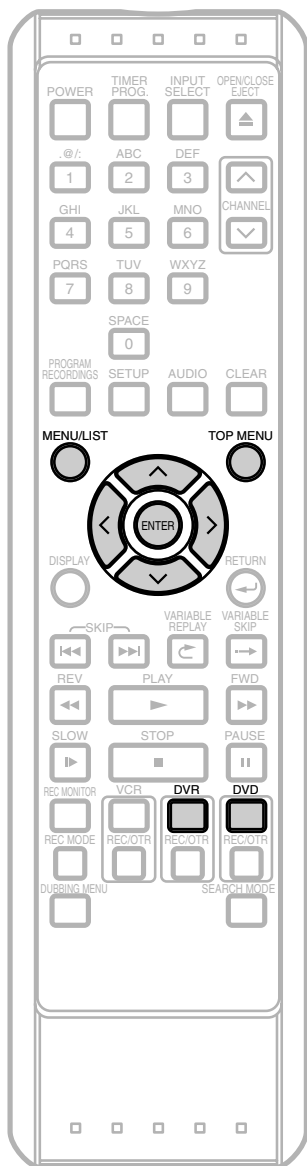

[VR] [PLAYLIST]

You can move the title position.

If you are playing the DVR, press **DVR** first.

If you are playing a disc, press **DVD** first.

1 Press **TOP MENU**.

Title List will appear.

Example: DVR Playlist

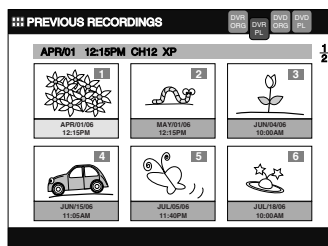

Press **MENU / LIST** to switch to Playlist if necessary.

2 Using $\wedge / \vee / \langle / \rangle$, select a desired title to move. Press **ENTER**.

Title List Menu will appear.

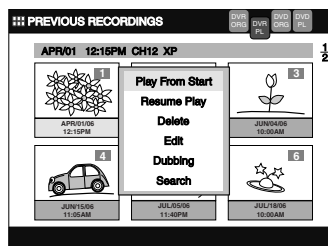

3 Using \wedge / \vee , select "**Edit**", then press **ENTER**. Edit Menu will appear.

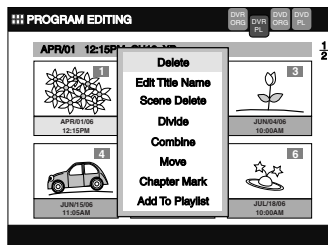

Moving Titles (Cont'd)

- 4** Using \wedge / \vee , select **“Move”**, then press **ENTER**.
The selected title will become a single line.

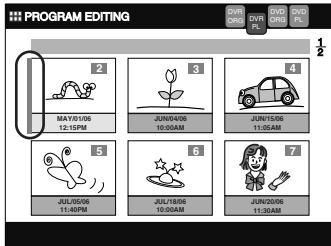

- 5** Using \wedge / \vee / \leftarrow / \rightarrow , move the line to the desired position, then press **ENTER**.
Confirmation window will appear.

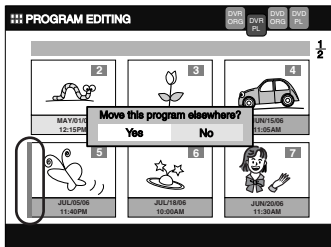

- 6** Using \leftarrow / \rightarrow , select **“YES”**. Press **ENTER**.
The title is now moved to the new position.

- 7** Press **TOP MENU** to exit.

Note

- When the total number of the titles exceeds 6, press **FWD** $\blacktriangleright\blacktriangleright$ to move to the first title of the next page, and press **REV** $\blacktriangleleft\blacktriangleleft$ to move to the last title of the previous page.

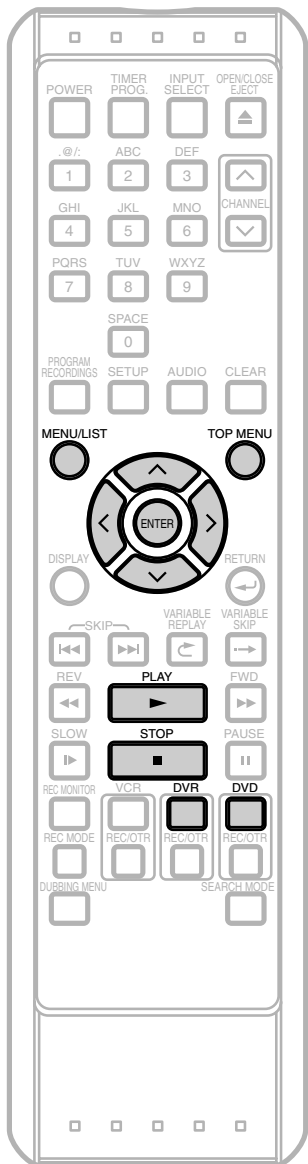

Adding Chapter Marks



[VR] [ORIGINAL] [PLAYLIST]

You can add or delete chapter marks on each title and can use them for the Chapter Search.

You can add up to 999 chapter marks anywhere you want.

If you are playing the DVR, press **DVR** first.

If you are playing a disc, press **DVD** first.

- 1 Press **TOP MENU**.
Title List will appear.

Example: DVR Original List

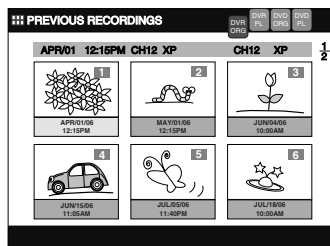

Press **MENU / LIST** to switch Original List / Playlist if necessary.

- 2 Using **^ / v / < / >**, select a desired title to edit. Press **ENTER**.
Title List Menu will appear.

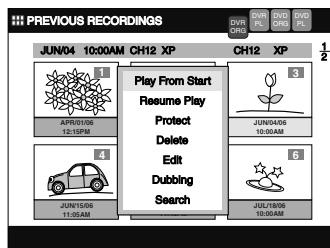

- 3 Using **^ / v**, select **"Edit"**, then press **ENTER**.
Edit Menu will appear.

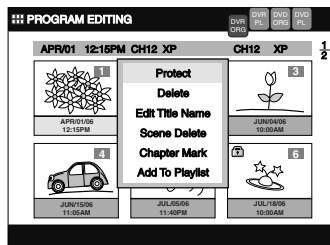

Chapter Marker (Cont'd)

- 4** Using \wedge / \vee , select **“Chapter Mark”**, then press **ENTER**.
Editing Screen will appear.

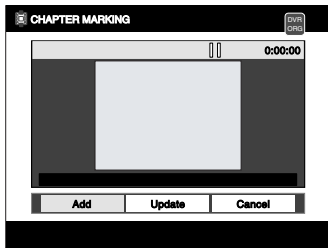

- If there are chapter marks already set for the title, they are indicated on the progress bar.

- 5** Press **PLAY** \blacktriangleright to start playback.
Play the title up to the point where you want to set a chapter marks.

- 6** When it reaches the desired point, press **ENTER**, or press **PAUSE II** or **STOP** \blacksquare and then **ENTER**.
Confirmation window will appear.

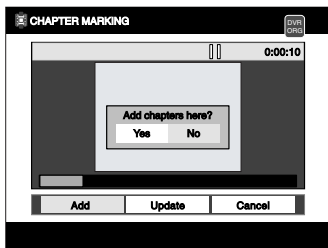

- 7** Using \lt / \gt , select **“Yes”**, then press **ENTER**. The point will be marked with a single line.

- 8** Repeat steps **5** to **7** until you set as many chapter marks as you want.

- 9** When you finish setting all the marks you want, select **“Update”** using \lt / \gt , then press **ENTER**.
Final confirmation window will appear.

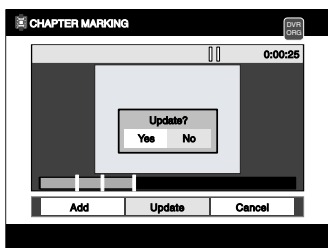

- If you want to quit the entire process, select **“Cancel”** using \lt / \gt , then press **ENTER**.

- 10** Using \lt / \gt , select **“Yes”**, then press **ENTER**.
Chapter marks are now added.

- 11** Press **TOP MENU** to exit.

Note

- When you search for the point to add a chapter mark, you can use **SKIP** \lll / \ggg , **FWD** \lll / **REV** \ggg , **VARIABLE REPLAY** \curvearrowright / **VARIABLE SKIP** \curvearrowleft , **PAUSE II** or **PLAY** \blacktriangleright as usual.

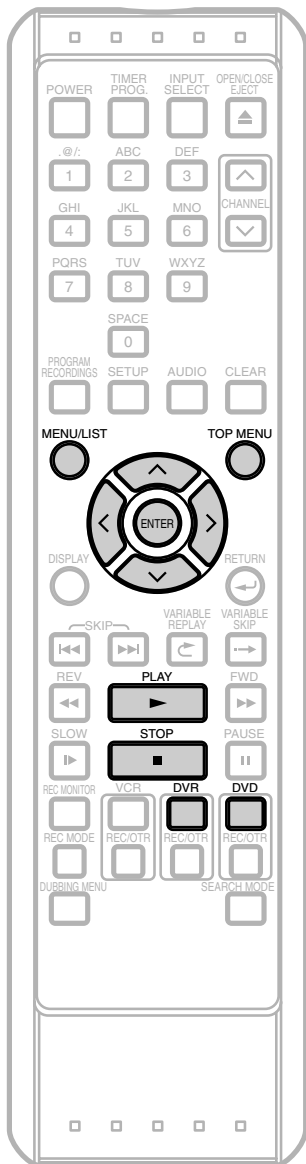

Deleting Chapter Marks



[VR] [ORIGINAL] [PLAYLIST]

If you are playing the DVR, press **DVR** first.
If you are playing a disc, press **DVD** first.

- 1 Press **TOP MENU**.
Title List will appear.

Example: DVR Original List

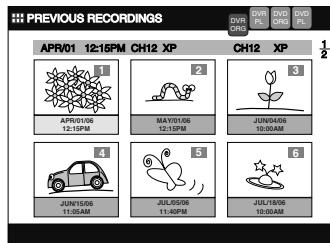

Press **MENU / LIST** to switch Original List / Playlist if necessary.

- 2 Using **^ / v / < / >**, select a desired title to edit. Press **ENTER**.
Title List Menu will appear.

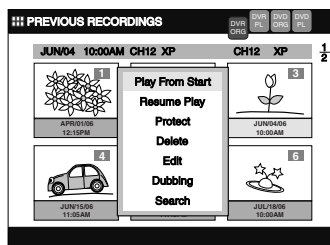

- 3 Using **^ / v**, select "Edit", then press **ENTER**.
Edit Menu will appear.

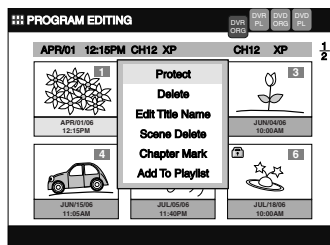

Chapter Marker (Cont'd)

- 4** Using \wedge / \vee , select “**Chapter Mark**”, then press **ENTER**.

Editing Screen will appear.

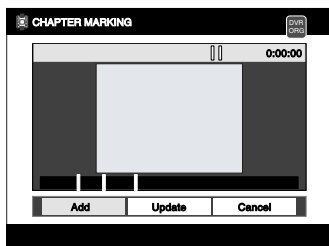

- 5** Press \wedge to move to the progress bar, and then select a chapter mark you want to delete using \lt / \gt , then press **ENTER**.

Confirmation window will appear.

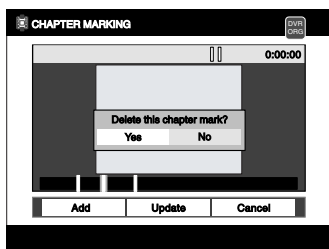

- 6** Using \lt / \gt , select “**Yes**”, then press **ENTER**.
The chapter mark disappears.

- 7** Repeat steps **5** to **6** until you erase as many chapter marks you want.

- 8** When you finish deleting all the unnecessary marks, press \vee to move back to the command bar. Then using \lt / \gt , select “**Update**”. Press **ENTER**.
Confirmation window will appear.

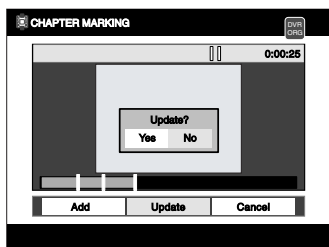

- 9** Using \lt / \gt , select “**Yes**”, then press **ENTER**.
The chapters marks are now deleted from the title.

- 10** Press **TOP MENU** to exit.

Adding Titles to a Playlist

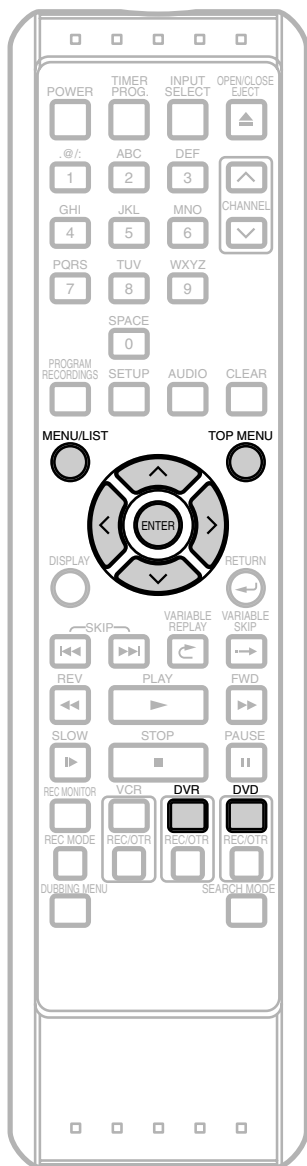

[VR] [ORIGINAL] [PLAYLIST]

You can add a title to the Playlist as you prefer.
You can add up to 99 titles for DVDs and 300 titles for DVR.

If you are playing the DVR, press **DVR** first.

If you are playing a disc, press **DVD** first.

- 1 Press **TOP MENU**.
Title List will appear.

Example: DVR Original List

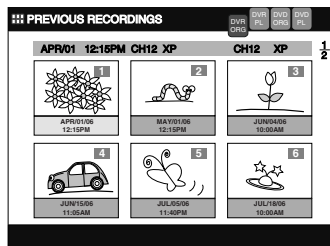

Press **MENU / LIST** to switch Original List / Playlist if necessary.

- 2 Using **^ / v / < / >**, select a desired title to add to the Playlist. Press **ENTER**.
Title List Menu will appear.

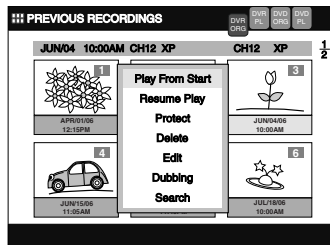

- 3 Using **^ / v**, select "Edit", then press **ENTER**.
Edit Menu will appear.

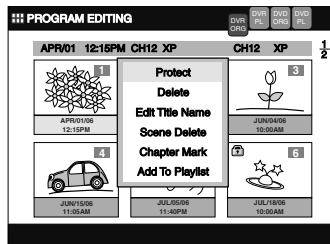

Adding Titles to a Playlist (Cont'd)

- 4** Using \wedge / \vee , select **“Add To Playlist”**, then press **ENTER**.

Confirmation window will appear.

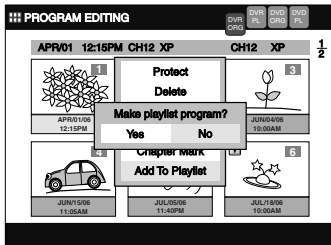

- 5** Using \lt / \gt , select **“Yes”**, then press **ENTER**.

The selected title is now added to the Playlist, and the Playlist will be displayed automatically.

- 6** Press **TOP MENU** to exit.

Note

- For VR mode DVD-RW disc, if the Playlist contains more than 99 titles or 999 chapters, **“Add To Playlist”** cannot be selected.
- For the DVR, if the Playlist contains more than 300 titles, **“Add to Playlist”** cannot be selected.
- To delete titles from Playlist, refer to 'Deleting Titles' on pages 90-91.

Other Setups

Tour of the Setup Menus

The following table shows the items which you can change the setting and their default settings. Refer to the following table for your convenience.

Setup Menu	Items	Selection (highlight is the default)	Contents	
OSD Language	➡ Page 21	English Français Español	Set the language for OSD (on-screen display).	
Clock Setting	Clock Setting	➡ Page 25		
	Auto Clock Setting ➡ Pages 24-25	Off Auto Manual		
	Daylight Saving Time ➡ Page 26	On Off		
Channel Setting	Auto Preset	➡ Pages 22-23		
	Manual Preset	➡ Page 23		
	TV Audio Select ➡ Page 27	Stereo SAP		
Playback	TV Aspect ➡ Pages 28	4 : 3 Letter Box 4 : 3 Pan & Scan 16 : 9 Wide		
	Parental Lock ➡ Page 113	All level 8 to 1	Set the parental level for DVD Disc Playback.	
	Disc Menu Language ➡ Page 114	English French Spanish Other	Set the language for Disc Menu.	
	Audio Language ➡ Page 114	Original English French Spanish Other	Set the language for audio.	
	Subtitle Language ➡ Page 114	Off English French Spanish Other	Set the language for subtitles.	
	Audio Out ➡ Page 115	PCM 48kHz 96kHz		Set whether the sound recorded in 96 kHz will be down sampled in 48 kHz.
		Dolby Digital PCM Stream		Set the type of sound signal output from the digital audio output jack.
		Dynamic Range Control On Off		Compressing the range of sound volume.
		Fast Forward with Audio On Off		Set whether or not to output sound during fast forward playback.
	Variable Replay/Skip Speed ➡ Page 116	Variable Skip 5 seconds 15seconds 30seconds 1 minute 5 minutes		Set the amount of skip time when you press VARIABLE SKIP → .
Variable Replay 5 seconds 15seconds 30seconds 1 minute 5 minutes			Set the amount of rewind time when you press VARIABLE REPLAY ⏮ .	
Angle Icon ➡ Page 117	On Off		Set whether or not to display the angle icon.	
Progressive ➡ Page 117	On Off		Set progressive scan on/off.	

Tour of the Setup Menus (Cont'd)

Setup Menu	Items	Selection (highlight is the default)	Contents
Record	Auto Finalize ➡ Pages 64-65	Disc Full On Off End of Timer Rec On Off End of Dubbing On Off	
	Auto Chapter ➡ Page 37	Off 5 minutes 10 minutes 15 minutes 30 minutes 60 minutes	
Display	Select Video ➡ Page 60	L1 (Rear) Video In S-Video In L2 (Front) Video In S-Video In	Set the video input type for the external input.
	FL Dimmer ➡ Page 119	Auto Bright Dark	Set the brightness of the Front Panel Display.
	Screen Saver ➡ Page 119	On Off	Set the idling time before the screen saver starts.
Reset to factory default	➡ Page 120		

Note

- If you change the settings in the Setup Menus, the information of the contents remain memorized even after the power is turned off or the disc tray is opened or closed.

Playback Setting

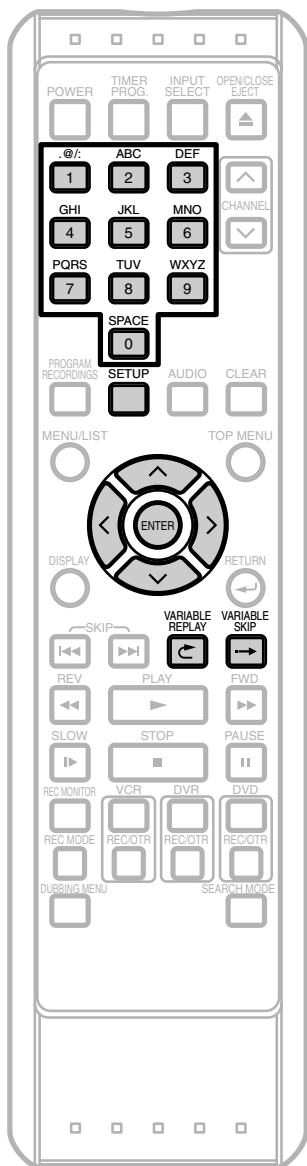

- 1 Press **SETUP**.
“Easy Setting Menu” or “Advanced Menu” will appear.
If “Advanced Menu” is displayed, proceed to step 3.

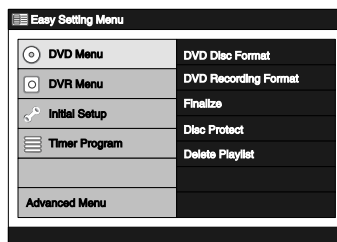

- 2 Using \wedge / \vee , select “Advanced Menu”. Press **ENTER**.

- 3 Using \wedge / \vee , select “Initial Setup”. Press **ENTER**.

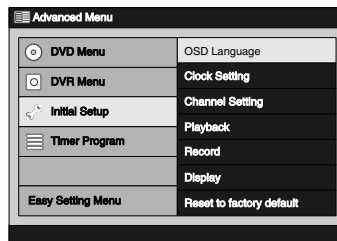

- 4 Using \wedge / \vee , select “Playback”. Press **ENTER**.
Playback Menu will appear.

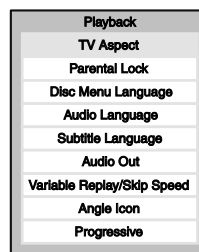

- 5 Using \wedge / \vee , select a desired item to set.
Press **ENTER**.
Menu or option window will appear.

- 6 Referring to 1 to 8 on pages 113-117, set the selected item.

- 7 When you finish with the setting, press **SETUP** to exit.

Playback Setting (Cont'd)

1. Parental Lock (Default: All)

You can set the Parental Lock Level to keep your children from viewing the inappropriate materials. (Follow the steps 1 to 4 on page 112.)

Using \wedge / \vee , select “**Parental Lock**”.

Press **ENTER**.

Option window will appear.

- If you haven't set a password, proceed to **A**.
- If you have already set a password, proceed to **B**.

A:When a password has not been set yet.

Parental Level List will appear.

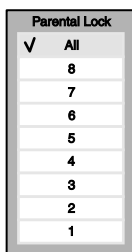

- 1** Using \wedge / \vee , select a desired level, then press **ENTER**. Confirmation window will appear.

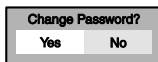

- 2** Using \lt / \gt , select “**Yes**”, then press **ENTER**. Password input field will appear.



- 3** Using the **Number Buttons**, enter the 4-digit password. Press **ENTER**. Your setting is now activated.

B:When a password has been set already.

Password input field will appear.



- 1** Using the **Number Buttons**, enter the 4-digit password (The password will be displayed as “*” for your security.)

Press **ENTER**.

Parental Level List will appear.

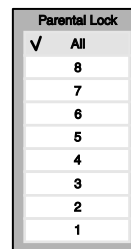

- 2** Using \wedge / \vee , select a desired level, then press **ENTER**. “**Change Password?**” will appear.

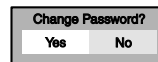

- If you want to change the password, select “**Yes**” and press **ENTER**.

The password input field will appear. Input the new password, then press **ENTER**.

The setting is now activated.

- If you only want to change the setting and not want to change the password, select “**No**”, then press **ENTER**.

Your setting is now activated.

Note

- Some DVD-Video discs feature the Parental Lock level. Playback will stop if the disc's general rating exceeds the level you set. It will require you to enter a password before the disc will be played back. This function prevents your children from viewing inappropriate materials.
- Parental Lock may not be available on some discs.
- Some DVDs may not completely support Parental Lock. Be sure to check if the Parental Lock operates in the way that you have set.
- Record the password in case you forget it.
- If you enter incorrect number, use \lt to move back to the number you want to correct and re-enter the correct number.
- When you forget the password or you want to clear all settings in Parental Lock, enter **4, 7, 3, 7** using the **Number Buttons** in input window at step **B**. Password will be cleared and Parental Lock Levels will be set to “**All**”.

RATING EXPLANATION

- ALL-Parental Control is inactive; all discs can play.
- 8 - Adult material
- 7 - NC - 17 - Not appropriate for children under 17
- 6 - R - Restricted; parental approval required for viewers under 18
- 4 - PG13 - Unsuitable for children under 13
- 3 - PG - Parental Guidance suggested
- 1 - G - General Audience; recommended for all ages

Playback Setting (Cont'd)

2. Disc Menu Language (Default: English)

You can set the language for Disc Menu.
(Follow steps 1 to 4 on page 112.)

Using \wedge / \vee , select **“Disc Menu Language”**.
Press **ENTER**.
Option window will appear.

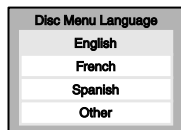

- Using \wedge / \vee , select a desired language. Press **ENTER**.
Your setting is now activated.

3. Audio Language (Default: Original)

You can set the Audio Language.
(Follow steps 1 to 4 on page 112.)

Using \wedge / \vee , select **“Audio Language”**.
Press **ENTER**.
Option window will appear.

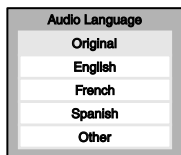

- Using \wedge / \vee , select a desired language. Press **ENTER**.
Your setting is now activated.
- When **“Original”** is selected, the audio language will be the disc's default language.

4. Subtitle Language (Default: Off)

You can set the subtitle language.
(Follow steps 1 to 4 on page 112.)

Using \wedge / \vee , select **“Subtitle Language”**.
Press **ENTER**.
Option window will appear.

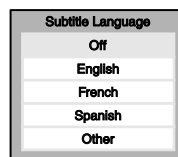

- Using \wedge / \vee , select a desired language. Press **ENTER**.
Your setting is now activated.

If **“Other”** is selected, enter 4-digit code using the **Number buttons**.



When you finish entering the code, press **ENTER**. Refer to 'Language Code' on page 135.

Playback Setting (Cont'd)

5. Audio Out

You can set the digital audio output.
(Follow steps 1 to 4 on page 112.)

Using \wedge / \vee , select **“Audio Out”**.
Press **ENTER**.
Menu window will appear.

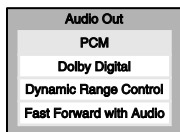

- Using \wedge / \vee , select a desired item to set.
Press **ENTER**.
Menu or Option window will appear.
Referring to the explanations below, set the selected item.

PCM (Default: 48kHz)

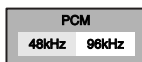

- Using \wedge / \vee , select a desired setting. Press **ENTER**.
Your setting is now activated.
- 48kHz** : If your amplifier / decoder is NOT compatible with 96kHz PCM, select **“48kHz”**. 96kHz sound will be output in 48kHz.
- 96kHz** : If your amplifier / decoder is compatible with 96kHz PCM, select **“96kHz”**. 96kHz sound will be output.

Note

When playing back disc with copyright protection

- Even if you select **“96kHz”**, the sound will be down sampled at 48kHz.

Dolby Digital (Default: Stream)

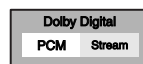

- Using \wedge / \vee , select a desired setting.
Press **ENTER**.
Your setting is now activated.
- PCM**: Convert the Dolby Digital into **“PCM”** (2 channel).
When your amplifier / decoder is NOT compatible with Dolby Digital, set to PCM.
- Stream**: Outputs Dolby Digital signals.
When your amplifier / decoder is compatible with Dolby Digital, set to **“Stream”**.

Note

When playing back a DVD-RW disc recorded in VR mode

- If the audio on a disc is recorded in Dolby Digital format, set Dolby Digital to PCM so that you can switch to main audio (L), sub audio (R), or a mix of both (L / R) with your amplifier / decoder.

Playback Setting (Cont'd)

Dynamic Range Control (Default: On)

You can set to “On” to compress the range between soft and loud sounds.

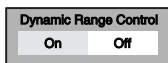

- Using < / >, select a desired setting. Press **ENTER**. Your setting is now activated.

Fast Forward with Audio (Default: On)

You can set to “On” to output the sound during playback in x1.5 fast forward.

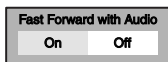

- Using < / >, select a desired setting. Press **ENTER**. Your setting is now activated.

6. Variable Replay / Skip Speed

Assign the **VARIABLE REPLAY** ↶ /

VARIABLE SKIP → button an amount of time to rewind or skip.

(Follow steps 1 to 4 on page 112. See page 76 also.)

Using ^ / v, select “**Variable Replay / Skip Speed**”.

Press **ENTER**.

Menu window will appear.

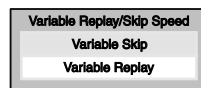

- Using ^ / v, select a desired item to set. Press **ENTER**. Option window will appear. Referring to the explanations below, set the selected item.

Variable Skip (Default: 30 seconds)

Sets the amount of skip time for **VARIABLE SKIP** →.



Variable Replay (Default: 30 seconds)

Sets the amount of rewind time for **VARIABLE REPLAY** ↶.

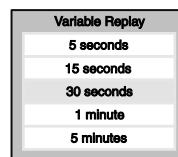

7. Angle Icon (Default: Off)

You can set to “**On**” to show the Angle icon on the screen whenever the feature is available.

(Follow steps 1 to 4 on page 112. See page 88 also.)

Using \wedge / \vee , select “**Angle Icon**”.

Press **ENTER**.

Option window will appear.

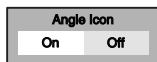

- Using \lt / \gt , select a desired setting.
Press **ENTER**.
Your setting is now activated.

8. Progressive (Default: Off)

You can set to “**On**” to activate progressive scan.

(Follow steps 1 to 4 on page 112.)

Using \wedge / \vee , select “**Progressive**”.

Press **ENTER**.

Option window will appear.

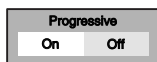

- Using \lt / \gt , select a desired setting.
Press **ENTER**.
Your setting is now activated.

Display Setting

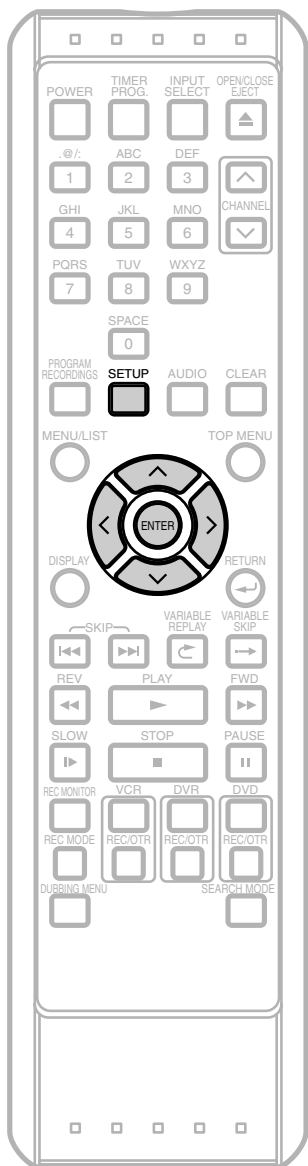

- 1 Press **SETUP**.
“Easy Setting Menu” or “Advanced Menu” will appear.
If “Advanced Menu” is displayed, proceed to step 3.

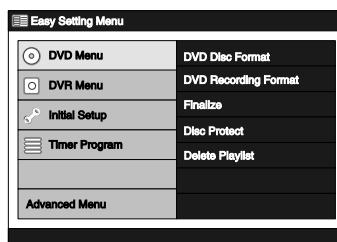

- 2 Using \wedge / \vee , select “Advanced Menu”.
Press **ENTER**.

- 3 Using \wedge / \vee , select “Initial Setup”. Press **ENTER**.

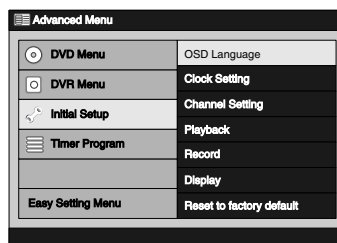

- 4 Using \wedge / \vee , select “Display”. Press **ENTER**.
Display Menu will appear.

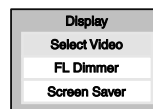

- 5 Using \wedge / \vee , select a desired item to set.
Press **ENTER**.
Menu or option window will appear.

- 6 Referring to 1 and 2 on page 119, set the selected item.

- 7 When you finish with the setting, press **SETUP** to exit.

Display Setting (Cont'd)

1. FL Dimmer (Default:Auto)

You can set the brightness of the Front Panel Display. You can select a setting from “**Auto**”, “**Bright**”, or “**Dark**”. When “**Auto**” is selected, the display turns brighter when the power is on and darker when the power is off.

(Follow steps 1 to 4 on page 118.)

Using \wedge / \vee , select “**FL Dimmer**”.

Press **ENTER**.

Option window will appear:

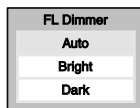

- Using \wedge / \vee select a desired setting. Press **ENTER**. Your setting is now activated.

2. Screen Saver (Default: On)

You can set to “**On**” to activate the Screen Saver after 10 minutes of no activity.

(Follow steps 1 to 4 on page 118.)

Using \wedge / \vee , select “**Screen Saver**”.

Press **ENTER**.

Option window will appear:

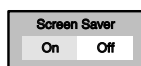

- Using \lt / \gt , select a desired setting. Press **ENTER**. Your setting is now activated.

Reset to Factory Default

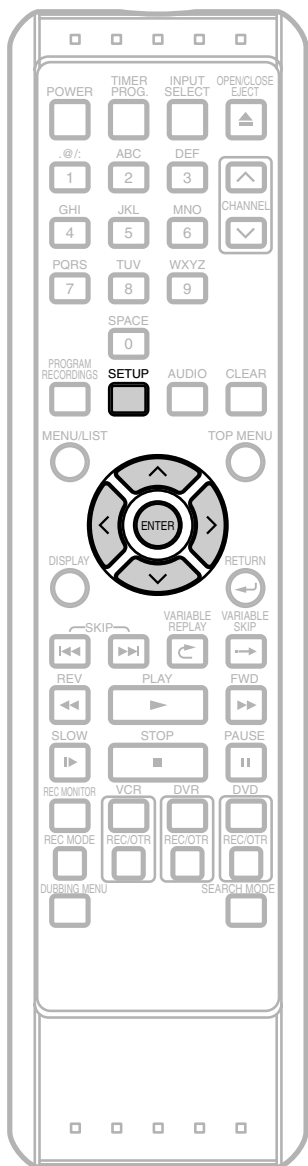

Resets the settings to the factory default (refer to the 'Note' on this page for the exceptions).

1 Press **SETUP**.

"Easy Setting Menu" or "Advanced Menu" will appear. If "Advanced Menu" is displayed, proceed to step 3.

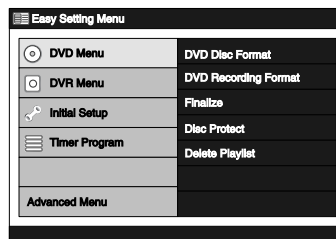

2 Using \wedge / \vee , select "**Advanced Menu**". Press **ENTER**.

3 Using \wedge / \vee , select "**Initial Setup**". Press **ENTER**.

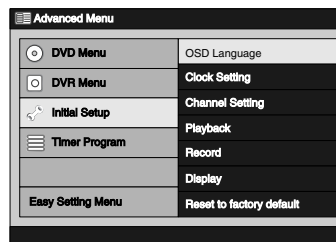

4 Using \wedge / \vee , select "**Reset to factory default**". Press **ENTER**.

Confirmation window will appear.

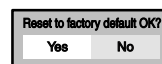

5 Using \lt / \gt , select "**Yes**". Press **ENTER**. Final confirmation window will appear.

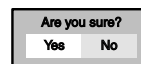

6 Using \lt / \gt , select "**Yes**". Press **ENTER**. All settings are now reset to the factory default.

7 Press **SETUP** to exit.

Note

- The settings listed below will remain unchanged even after resetting to the factory default.
 - OSD Language Setting
 - Clock Setting
 - Parental Lock Setting
 - Progressive Scan Setting
 - DVR/DVD Timer Programs
 - DVR Original List / Playlist

Guide to Display Information (VCR)

VCR

Press **VCR** first.

Press **DISPLAY** to show the information on the display.

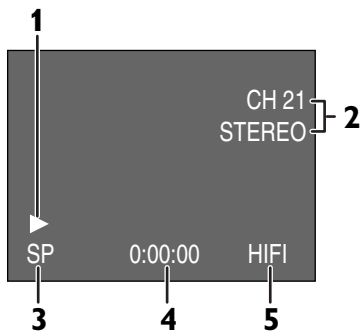

- 1 Playback status
- 2 Current channel number and an audio status of the program. This information appears only in the stop mode.
- 3 Rec Mode
- 4 Tape Counter
- 5 Audio status of the current videotape

Note

- This is an example screen only for explanation. Displayed items will change depending on the actual mode.

Recording

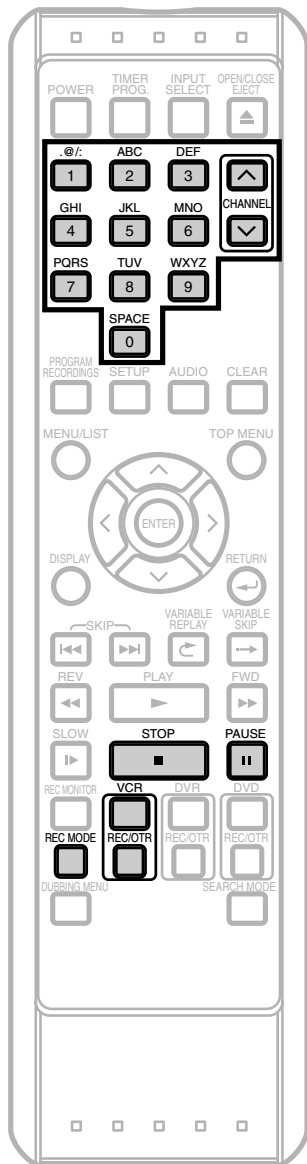

Basic Recording



Before recording, make sure:

- The desired channel is selected by pressing the **Number Buttons** or **CHANNEL** ^ / v.
- There is a videotape with a record tab in the unit.
- The desired Rec Mode (SP: Standard Play or SLP: Super Long Play) is selected by pressing **REC MODE** on the remote control.

Rec Mode

Tape speed	Recording / Playback Time			
Type of tape	T60	T120	T160	T210
SP mode	1 hour	2 hours	2-2 / 3 hours	3-1 / 2 hours
SLP mode	3 hours	6 hours	8 hours	10-1 / 2 hours

- Stereo or SAP is selected. (See page 27.)

Press **VCR** first.

- 1 Press **REC / OTR** (VCR) to begin the recording.
To temporarily stop recording or to resume it, press **PAUSE II**. After the unit has been in pause for five minutes, it will stop automatically to protect the videotape and the video head from damage.

- 2 Press **STOP** ■ when the recording is completed.

Note

- Although you can playback a videotape recorded in the SP, LP, or SLP mode on this unit, LP mode recording is not available.
- Timer Recording is not available with VCR.
- If a basic recording or One Touch Recording is in progress on the VCR and the Timer Recording set for DVR or DVD is about to begin, the unit will automatically switch to the programmed channel 15 seconds before the programmed time and the recording in progress on the VCR will be cancelled UNLESS their recording channel is the same. If their recording channel is the same, the Timer Recording for DVR or DVD will start without cancelling the recording currently in progress on the VCR. In this case, the recording of the same channel will be made on both VCR and the DVR or DVD.

To view one channel while recording another:

- 1 If you want to watch the TV programs, simply select the channel you want to watch with the TV's remote.
- 2 If you want to watch the cable TV or the satellite TV programs, select the channel you want to watch at the cable box or the satellite box.

Accidental erasure prevention

To prevent accidental recording on a recorded videotape, remove its record tab. To record on it later, cover the hole with cellophane tape.

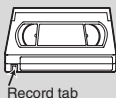

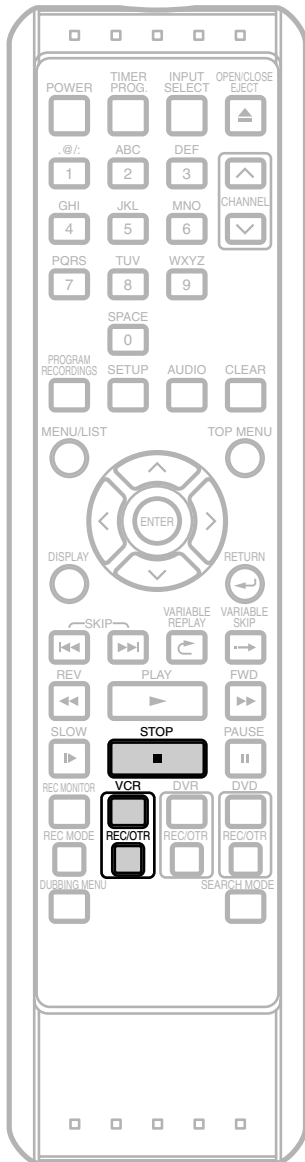

One Touch Recording



This function allows you to set the recording length simply by pressing **REC / OTR (VCR)**.

Press **VCR** first.

- 1 During normal recording, press **REC / OTR (VCR)** to begin One Touch Recording.

You can select a fixed recording time by pressing **REC / OTR (VCR)** repeatedly.

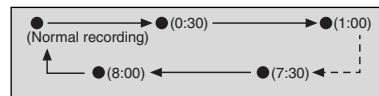

When One Touch Recording is finished, the unit will turn off automatically.

To change the recording length during the One Touch Recording, press **REC / OTR (VCR)** repeatedly until the desired length appear.

To cancel the One Touch Recording within the specified time, press **STOP**.

Note

- The remaining recording time will appear on the display panel during a One Touch Recording. Press **DISPLAY** to see it on the TV screen.
- You cannot pause a One Touch Recording.
- If a basic recording or One Touch Recording is in progress on the VCR and the Timer Recording set for DVR or DVD is about to begin, the unit will automatically switch to the programmed channel 15 seconds before the programmed time and the recording in progress on the VCR will be cancelled UNLESS their recording channel is the same. If their recording channel is the same, the Timer Recording for DVR or DVD will start without cancelling the recording currently in progress on the VCR. In this case, the recording of the same channel will be made on both VCR and the DVR or DVD.

Playback

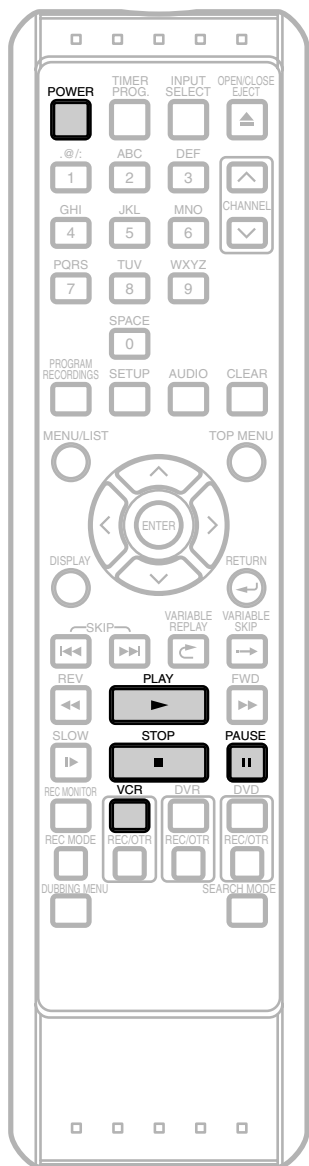

Turn on the TV. Select the appropriate external input Channel. (See page 18.)

- 1 Press **POWER** on the remote control or the front panel of the unit.
Turn on the TV. Select the appropriate external input Channel.

Press **VCR** first.

- 2 Insert a prerecorded videotape. Press **PLAY** ► to begin playback.
 - If there is no record tab, playback starts automatically.

- 3 During playback, press **PAUSE** II.
Playback will pause and sound will be muted.

- 4 Press **PLAY** ► to resume playback.

- 5 Press **STOP** ■ to stop playback.

- 6 Press **STOP / EJECT** ■▲ on the front panel of the unit to eject the videotape.

Note

- Tracking will be automatically adjusted upon playback. To adjust the tracking manually, press **CHANNEL** ^/∨.

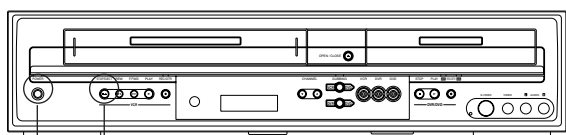

POWER **STOP / EJECT** ■▲

Search

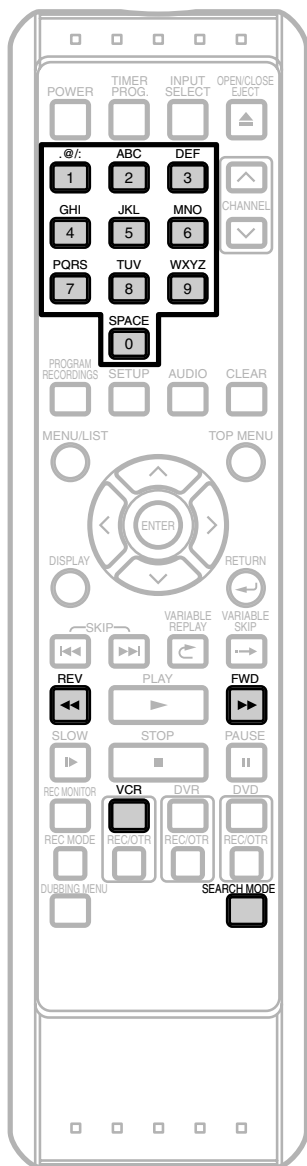

Index Search



An index mark will be assigned at the beginning of each recording you make. You may skip to a specific marked point by following the steps below.

Press **VCR** first.

- 1** Press **SEARCH MODE** so that the Index Input Screen will appear.
- 2** Using the **Number Buttons**, enter the number of recordings you wish to skip within 30 seconds.

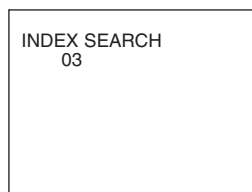

• To exit the Index Input Screen, press **STOP** ■.

- 3** Press **FWD** ►► / **REV** ◀◀ to start the Index Search.

If you want to go in the forward direction, press **FWD** ►►.

If you want to go in the reverse direction, press **REV** ◀◀.

After index search, the VCR will play the videotape automatically.

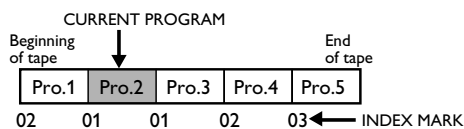

Note

- Every time a videotape is recorded, an index mark is written on the videotape.
- Index Search and Time Search are not available during recording.

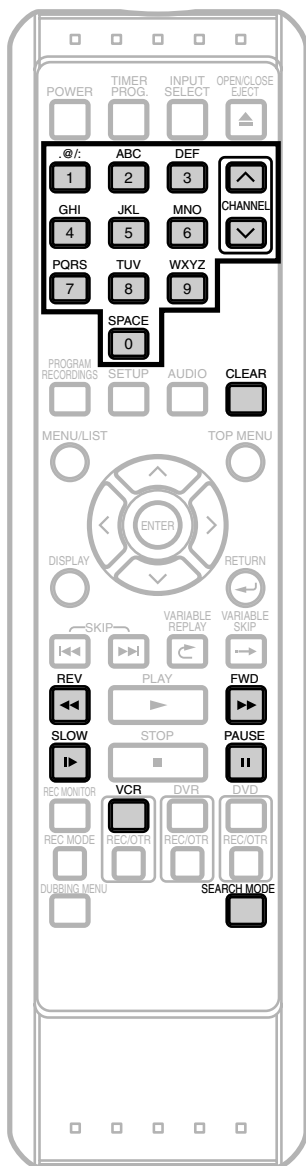

Time Search



This function allows you to go to a specific point on a videotape by entering the exact amount of time you wish to skip in order to reach the point.

Press **VCR** first.

- 1 Press **SEARCH MODE** repeatedly so that the Time Input Screen will appear.
- 2 Using **the Number Buttons**, enter your desired time to skip with in 30 seconds.

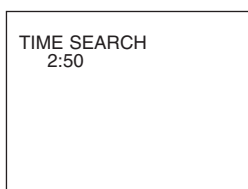

• To exit the Index Input Screen, press **STOP** ■.

- 3 Press **FWD** ►► or **REV** ◀◀ to start Time Search. If you want to go in the forward direction, press **FWD** ►►. If you want to go in the reverse direction, press **REV** ◀◀. After Time Search, the unit will play the videotape automatically.

Note

- Index Search and Time Search are not available during recording.
- Press **STOP** ■ to stop the search.
- If the end of the videotape is reached during a search, this unit will cancel the search and rewind the videotape.

Other Operations



Press **VCR** first.

Fast forward:

When the unit is in stop mode, press **FWD** ►► to fast forward the videotape.

Rewind:

When the unit is in stop mode, press **REV** ◀◀ to rewind the videotape.

To cue or review picture during playback (Picture Search):

Press **FWD** ►► or **REV** ◀◀ during playback. Press it again and the unit will search in super high speed. (in the SLP mode only)

To freeze the picture on the TV screen during playback (Still mode):

Press **PAUSE** II. Each time you press the button, the picture will be forwarded by one frame. If the picture begins to vibrate vertically during the still mode, stabilize the picture by pressing **CHANNEL** ^ / v. If the picture is distorted or rolling vertically, adjust the vertical hold control on your TV, if equipped.

Counter Reset:

Press **CLEAR**.

To playback in slow motion:

Press **SLOW** I► during playback or the still mode. If the noise bars appear on the TV screen, you can reduce it by pressing **CHANNEL** ^ / v.

Automatic rewind

When a videotape is played or fast forwarded to its end, the videotape will rewind to the beginning, stop and eject itself.

Setting the Playback audio:

Press **AUDIO** on the remote control to select “**Hi-Fi**” or “**MONO**” as your playback audio.

- If the unit is connected to a stereo TV, select “**HIFI**”.
- If the unit is connected to a monaural TV, select “**MONO**”.
- If the videotape is recorded in monaural, the audio mode is fixed to the monaural and cannot be changed.

Note

- Still / slow / pause mode will be automatically cancelled after 5 minutes to prevent damage to the videotape and the video head.
- To return to playback from the Picture Search / Still / Slow mode, press **PLAY** ►.

Your Selection Type of recorded tape	HIFI		MONO
	L-channel	R-channel	
non Hi-Fi tapes	Monaural	Monaural	Monaural
Hi-Fi tapes recorded in Hi-Fi stereo	L	R	L+R
Hi-Fi tapes recorded main audio program	Main audio program	Main audio program	Main audio program
Hi-Fi tapes recorded second audio program	Second audio program	Second audio program	Second audio program

Troubleshooting

Before requesting service for this unit, check the table below for a possible cause of the problem you are experiencing. Some simple checks or a minor adjustment on your part may eliminate the problem and restore proper performance.

General Operation

Error message	Cause & Solution
	<ul style="list-style-type: none"> The operation is not available.
<div style="border: 1px solid black; padding: 2px; width: fit-content;">Error</div> <p>Now Recording.</p>	<ul style="list-style-type: none"> The operation is not available during recording.
<div style="border: 1px solid black; padding: 2px; width: fit-content;">Error</div> <p>Now Dubbing.</p>	<ul style="list-style-type: none"> The operation is not available during dubbing.
<div style="border: 1px solid black; padding: 2px; width: fit-content;">Error</div> <p>Timer program starts soon.</p>	<ul style="list-style-type: none"> The operation is not available since a Timer Recording will start soon.

Discs

Error message	Cause & Solution
<div style="border: 1px solid black; padding: 2px; width: fit-content;">Disc Error</div>	<ul style="list-style-type: none"> Invalid disc is inserted. Please insert a disc supported by this unit. (See pages 29 and 66.)
<div style="border: 1px solid black; padding: 2px; width: fit-content;">Region Error</div> <p>Please eject the disc. Playback is not authorized in your region.</p>	<ul style="list-style-type: none"> A disc with the invalid region code is inserted. This unit only supports the discs with region code 1 or ALL.
<div style="border: 1px solid black; padding: 2px; width: fit-content;">Error</div> <p>Please insert a valid disc.</p>	<ul style="list-style-type: none"> No disc or an invalid disc is inserted. Please insert a disc supported by this unit. (See pages 29 and 66.)
<div style="border: 1px solid black; padding: 2px; width: fit-content;">Error</div> <p>Cannot format.</p>	<ul style="list-style-type: none"> The discs not supported by this unit cannot be formatted. Please use the discs supported by this unit. (See page 29.) During DVR playback or recording, formatting will not be executed. Stop the playback or recording.
<div style="border: 1px solid black; padding: 2px; width: fit-content;">Error</div> <p>Cannot finalize.</p>	<ul style="list-style-type: none"> The discs not supported by this unit cannot be finalized. Please use the discs supported by this unit. (See page 29.)
<div style="border: 1px solid black; padding: 2px; width: fit-content;">Error</div> <p>Un-finalize cannot be performed.</p>	<ul style="list-style-type: none"> The finalization of the Video mode DVD discs made on other unit cannot be undone.
<div style="border: 1px solid black; padding: 2px; width: fit-content;">Error</div> <p>Disc protect cannot be performed.</p>	<ul style="list-style-type: none"> Disc Protect is only available with the VR mode DVD-RW discs. Other discs cannot be protected. (See page 62.)

Timer Recording / Recording & Navigator

Error message	Cause & Solution
<div style="border: 1px solid black; padding: 2px; width: fit-content;">Error</div> <p>Prohibited timer program.</p>	<ul style="list-style-type: none"> The entry for the Timer Recording is invalid. The recording duration must be in 24 hour period. The end time must be later than the present time, and the start time must be before 1-1-2055. Re-program the Timer Recording correctly. (See pages 42-43.)
<div style="border: 1px solid black; padding: 2px; width: fit-content;">Error</div> <p>Cannot register timer program.</p>	<ul style="list-style-type: none"> The maximum number of timer programs is exceeded. Delete unnecessary timer programs. (See pages 42-43.)

Troubleshooting (Cont'd)

Playback / Editing

Error message	Cause & Solution
<div style="border: 1px solid black; padding: 2px; width: fit-content;">Parental Lock On</div> <p>The current selected parental level prohibits playback.</p>	<ul style="list-style-type: none"> The current Parental Lock setting prohibits the playback. Change the Parental Level. (See page 113.)
<div style="border: 1px solid black; padding: 2px; width: fit-content;">Error</div> <p>Program Edit Error. The number of titles is maximum.</p>	<ul style="list-style-type: none"> The maximum number of titles is exceeded. Delete unnecessary titles. (See pages 90-91.)
<div style="border: 1px solid black; padding: 2px; width: fit-content;">Error</div> <p>The number of chapters is maximum.</p>	<ul style="list-style-type: none"> The maximum number of chapters is exceeded. Delete unnecessary chapter marks. (See pages 106-107.)
<div style="border: 1px solid black; padding: 2px; width: fit-content;">Error</div> <p>Program Edit Error. The number of programs in playlist is maximum.</p>	<ul style="list-style-type: none"> The maximum number of titles in the Playlist is exceeded. Delete unnecessary titles in the Playlist. (See pages 92, 98-99.)

Dubbing

Error message	Cause & Solution
<div style="border: 1px solid black; padding: 2px; width: fit-content;">Error</div> <p>Cannot dubbing now.</p>	<ul style="list-style-type: none"> No recording media is inside the unit. Insert the recordable media. Recordable space is not enough. Make sure the recording media has enough space. The device is in use for playback or recording. Stop the playback or recording. The dubbing material is copy protected. You cannot dub the copy protected material. You are trying to dub to the finalized Video mode DVD. You cannot dub to the finalized Video mode DVDs.
<div style="border: 1px solid black; padding: 2px; width: fit-content;">Error</div> <p>Timer programmed. No dubbing now.</p>	<ul style="list-style-type: none"> The dubbing you are trying to make does not finish by 3 minutes before the Timer Recording. Re-arrange the timer programs, or try dubbing when there is no Timer Recording in standby.
<div style="border: 1px solid black; padding: 2px; width: fit-content;">Error</div> <p>Cannot select program.</p>	<ul style="list-style-type: none"> You are trying to add more than 32 titles to the Dubbing List. Or the number of the titles or the chapters of the recording media exceeds the max. Delete unnecessary titles or the chapters from the list.
<div style="border: 1px solid black; padding: 2px; width: fit-content;">Error</div> <p>Copy guard detected. Dubbing is stopped.</p>	<ul style="list-style-type: none"> The recording function encountered a copy control signal. You cannot dub copy protected programs.
<div style="border: 1px solid black; padding: 2px; width: fit-content;">Error</div> <p>DVR remaining space error Dubbing cannot be performed.</p>	<ul style="list-style-type: none"> There is not enough space left on the DVR to finish the dubbing. Delete the unnecessary titles in the Original List, or change the Rec Mode.
<div style="border: 1px solid black; padding: 2px; width: fit-content;">Error</div> <p>DVD remaining space error Dubbing cannot be performed.</p>	<ul style="list-style-type: none"> There is not enough space left on the DVD to finish the dubbing. Insert a recordable DVD, delete the unnecessary titles in the Original List, or change the Rec Mode.

Troubleshooting (Cont'd)

	Symptom	Solution
P O W E R	The power does not turn on.	<ul style="list-style-type: none"> • Check that the AC power cord is connected securely. • Batteries of the remote control are weak. • If above solutions do not work, press RESET on the front panel with a sharp pointed object to re-start the unit. (See page 10.)
	The unit turns on automatically without any operation.	<ul style="list-style-type: none"> • During Auto Clock Setting, the POWER Light lights up. • The unit turns on automatically 3 minutes before the Timer Recording.
	The OSD Language Setting Menu appears every time the power turns on.	<ul style="list-style-type: none"> • Finish up the Language Setting procedure by selecting a language in the OSD Language Setting Menu. Press ENTER to activate the setting.
	The power turns off automatically .	<ul style="list-style-type: none"> • The power turns off automatically when abnormality is detected on the disc. Press POWER or OPEN / CLOSE ▲ to open the disc tray, and before it is opened completely, press the button again. Then take out the disc. • The power turns off automatically when an OTR is completed. • There is a possibility that the safety device is working. Try pressing RESET on the front panel with a sharp pointed object to re-start the unit. (See page 10.)

	Symptom	Solution
G E N E R A L	The unit does not function.	<ul style="list-style-type: none"> •  or error message appears if the operation is prohibited. • Batteries of the remote control are weak or exhausted • There is a possibility that the safety device is working. Try pressing RESET on the front panel with a sharp pointed object to re-start the unit. (See page 10.)
	No picture, sound or menu appears on the screen.	<ul style="list-style-type: none"> • Check if the connections are made securely and correctly. • Check if the cables are not damaged. • Check if a correct external input channel is selected on your TV. (See page 18.) • Check if you have completed the Channel Setting.
	Clock Setting and Channel Setting cannot be performed.	<ul style="list-style-type: none"> • If a Timer Recording is in standby or if a recording is in progress, these operations cannot be performed. Delete timer programs or stop the recording.
	The unit does not operate properly.	<ul style="list-style-type: none"> • Moisture has condensed inside the unit. Remove the disc and leave the unit turned on for about two hours until the moisture evaporates. (See page 4.)
	The abnormal display appears in the Front Panel Display.	<ul style="list-style-type: none"> • There is a possibility that the safety device is working. Try pressing RESET on the front panel with a sharp pointed object to re-start the unit. (See page 10.)

Troubleshooting (Cont'd)

CHANNEL	Symptom	Solution
	TV channels cannot be changed.	<ul style="list-style-type: none"> • Check if the connections are made securely and correctly. • Check if the cables are not damaged. • Try Channel Setting by following the steps on pages 22-23.
	Only specific channels do not appear.	<ul style="list-style-type: none"> • The channels may be set to be skipped.
	The external input channels (such as L1 or L2) cannot be skipped.	<ul style="list-style-type: none"> • This unit does not skip the external input channels. This is not a malfunction.

RECORDING	Symptom	Solution
	Recording is impossible.	<ul style="list-style-type: none"> • This unit cannot record a program that contains copy protection signal. This is not a malfunction. • The space of the recording media may be used up. Try deleting unnecessary titles from the Original List, or exchange it with the recordable media. • The maximum number of titles or chapters has exceeded. Delete the unnecessary titles to make enough space or insert a new recordable media. • Check if the connections are made securely and correctly.
	Recording on the DVD disc is impossible.	<ul style="list-style-type: none"> • Copy-once programs can only be recorded on a CPRM compatible VR mode DVD-RW. • Check if the disc is not protected or finalized. Undo the protection or the finalization. • DVD-RW once formatted with other DVD recorders cannot be recorded on this unit. This is not malfunction. • Video mode DVDs recorded by other DVD recorders cannot be used on this unit unless finalized. • Check if the connections are made securely and correctly.
	The image from the external device cannot be displayed or recorded.	<ul style="list-style-type: none"> • Try pressing INPUT SELECT repeatedly. • Turn on the all connected devices. • Check if the connections are made securely and correctly.
	Timer Recording cannot be performed.	<ul style="list-style-type: none"> • The internal clock of the unit may have been stopped due to a power failure that lasted for more than 30 seconds. Reset the clock. (See pages 24-26.)
	Recording to a videotape is impossible.	<ul style="list-style-type: none"> • Check if a videotape is inserted. • Check if a videotape has a record tab intact.

Troubleshooting (Cont'd)

Symptom	Solution
Disc Playback cannot be performed.	<ul style="list-style-type: none"> • Check if the playable disc is inserted. • Check if the disc is loaded correctly with the labeled side facing up. • Discs made on other devices or on personal computers cannot be played back on this unit unless it is finalized on the device. Even if it is finalized, the performance of those discs are not guaranteed on this unit. • The disc may be dirty or flawed. Clean the disc. • Check if all the connections are made correctly. • Check if the setting for the Progressive Scan is correct. (See page 117.) • Check the Parental Lock Setting. (See page 113.)
Playback does not start from the beginning.	<ul style="list-style-type: none"> • Resume function may be activated. See page 72 to cancel the resume point.
TV aspect ratio does not match for your TV screen.	<ul style="list-style-type: none"> • Check the TV Aspect Ratio. (See page 28) • A different aspect ratio will be used when the aspect ratio specified by the disc is not supported by this unit.
Playback picture is distorted. Color of the picture is abnormal.	<ul style="list-style-type: none"> • During fast forward or fast reverse, playback picture may be distorted. This is not a malfunction. • Connect to TV directly. When you connect this unit with the television via VCR or other devices, the picture may be distorted due to the copy-protection signal. • Check if the cables are damaged. • Keep the equipment which may cause electrical disturbances, such as a cellular phone, away.
There is no sound, or no subtitle.	<ul style="list-style-type: none"> • Turn on all connected devices. • Check if the external input channel is set correctly. • Check if the connections are made securely and correctly. • Check if the Audio Out Setting is set correctly. (See page 115) • There is a possibility that the selected subtitle language is not supported by the disc.
Audio Out Setting can not be changed.	<ul style="list-style-type: none"> • If the audio source is in the Dolby Digital format, set the Dolby Digital Setting to "PCM" in the Setup Menu. (See page 115)
Audio Language or the Subtitle Language of the DVD can not be changed.	<ul style="list-style-type: none"> • Multilingual subtitles are not supported by the disc. • Some audio languages or the subtitle languages can be changed only from the Disc Menu. Please refer to the disc's manual.
Camera angles can not be changed.	<ul style="list-style-type: none"> • Even though the multi-angle feature is supported by the disc, that does not mean all the scenes are shot from multi-angles. Changing angles are available only for those scenes shot from the multi-angle.
VCR picture is noisy.	<ul style="list-style-type: none"> • Adjust the tracking by pressing CHANNEL ▲ / ▼ while you are playing a videotape.
During VCR playback, pictures do not come out even though sound does.	<ul style="list-style-type: none"> • VCR Head cleaning may be necessary. Refer to 'AUTO HEAD CLEANING' on page 136.

PLAYBACK

* If you are still having trouble with this unit after checking 'Troubleshooting', write down the error code and the error description, and call our helpline mentioned on the front page to locate an Authorized Service Center.

Troubleshooting (Cont'd)

EDITING	Symptom	Solution
	Titles can not be edited or deleted.	<ul style="list-style-type: none"> The titles or the disc itself may be protected. Cancel the protection by following the steps on page 93 for title protection, and page 62 for disc protection. The titles in the Video mode discs cannot be edited or deleted if they are finalized. Undo the finalization by following the steps on page 63.
	The capacity of the disc doesn't increase even if the recorded program is deleted.	<ul style="list-style-type: none"> With Video mode DVD-RW discs, the disc space will increase only when the last title in the Original List is deleted. With DVD-R discs, deleting a title will not increase the disc space. Deleting a title in the Playlist will not increase the capacity, try deleting a title in the Original List.
	The disc cannot be played back on other player even though it is finalized properly.	<ul style="list-style-type: none"> Some DVD players do not play back the disc made on other recorder. Refer to the manual of the player.
	Dubbing cannot be executed.	<ul style="list-style-type: none"> Video mode discs made on other recorder cannot be dubbed using this unit. When the number of the titles or the chapters exceeds the maximum recordable number, the dubbing will not be executed. Copy-once programs or the copy protected programs may not be dubbed depending on the recording media. Regarding the limitations on dubbing, refer to the page 47.

REMOTE CONTROL	Symptom	Solution
	The remote control does not function.	<ul style="list-style-type: none"> No batteries in the remote or the batteries may be weak. Replace the batteries. Make sure there is no obstacle between the remote and the unit. Try getting closer to the unit. (See page 15.) Make sure to press the Device Select Button before operating on the device of your choice. If above solutions do not solve the problem, please call our helpline mentioned on the front page to locate an Authorized Service Center for help.
Pressing SETUP does not do anything.	<ul style="list-style-type: none"> While the Programmed Recordings Screen, the Dubbing Menu Screen, or the Title List is displayed or while the disc is loading, the SETUP button does not respond. 	

OTHERS	Symptom	Solution
	The Clock display does not appear in the Front Panel Display.	<ul style="list-style-type: none"> Check that the AC power cord is connected securely. (In case of power failure) Check the breaker and Clock Setting.
When you forget the password for Parental Lock.	<ul style="list-style-type: none"> Please cancel the password and the set level. (See page 113.) 	

Analog audio

An electrical signal that directly represents sound. In contrast, digital audio which can be an electrical signal, but is an indirect representation of sound. See also Digital audio.

Aspect ratio

The width of a TV screen relative to its height. Conventional TVs are 4:3 (in other words, the screen is almost square); widescreen models are 16:9 (the screen is almost twice as wide as it is high).

Chapter

Just as a book is split up into several chapters, a title on a DVD disc is usually divided into chapters. See also Title.

Component video output

This is a video signal format that conveys each of three principal colors of light (red, blue and green) through different signal lines. This allows the viewers to experience picture colors as original as it is. There are several signal formats, including Y / P_B / P_R and Y / C_B / C_R.

CPRM (Content Protection for Recordable Media)

This is a format used to record copy-once programs. By recording coded data on the area of DVD discs that ordinary writing software cannot write on, it prevents copy-once programs from being recorded repeatedly on different media.

Digital audio

An indirect representation of sound by numbers. During recording, the sound is measured at discrete intervals (44, 100 times a second for CD audio) by an analog-to-digital converter, generating a stream of numbers. On playback, a digital-to-analog converter generates an analog signal based on these numbers. See also Sampling frequency and Analog audio.

Dolby Digital

The system developed by Dolby Laboratories to compress digital sound. It offers you sound of stereo (2ch) or multi-channel audio.

Finalize

To make recorded contents on DVD discs possible to be played back on DVD players. With this unit, it is possible to finalize DVD-RW/R discs.

MP3 (MPEG Audio Layer 3)

MP3 is a method of compressing files. You can copy MP3 files on CD-RW / R discs from the computer and play back the files on this unit.

PCM (Pulse Code Modulation)

PCM is a format that converts audio into digital data. It is mainly used for Audio CDs and DAT. This unit can play back sounds as realistic as possible by converting even compressed Dolby Digital and MPEG audio to PCM.

Playlist

From this list you can play back contents of a disc in your desired order or sequence. Also it allows to search a specific scene directly.

Progressive scan (480p)

A type of display that does not split each frame into fields, and instead scans directly through all the scanlines of each frame in order. Progressive scan provides less flickering and higher image resolution than traditional (480i) TV signals.

See page 17 for instructions on selective progressive scan mode.

Regions code

Regions associate discs and players with particular areas of the world. This unit will only play back discs that have compatible region codes. You can find the region code of your unit by looking at the rear panel. Some discs are compatible with more than one region (or all regions).

Sampling frequency

The rate which sound is measured by a specified interval to turn it into digital audio data. The numbers of sampling in one second defines as sampling frequency. The higher the rate, the better the sound quality is.

SAP (Secondary Audio Program)

Sub-audio channel which is delivered separately from main-audio channel. This audio channel is used as an alternate in bilingual broadcasting.

S-Video output

It delivers independently each signal of color(C) and luminance(Y) to TV as video signals, so that higher-quality picture will be materialised.

Title (DVD only)

A collection of chapters on DVD disc. See also chapter.

Track

Audio CDs use tracks to divide the content of a disc. The DVD equivalent is called a chapter. See also Chapter.

WMA

WMA is the audio file compressing technology developed by Microsoft. You can copy WMA files on CD-RW / R discs from a computer and play them back on this unit.

Language Code

Language	Code	Language	Code	Language	Code	Language	Code
Abkhazian	4748	French	5264	Lithuanian	5866	Sindhi	6550
Afar	4747	Frisian	5271	Macedonian	5957	Singhalese	6555
Afrikaans	4752	Galician	5358	Malagasy	5953	Siswat	6565
Albanian	6563	Georgian	5747	Malay	5965	Slovak	6557
Amharic	4759	German	5051	Malayalam	5958	Slovenian	6558
Arabic	4764	Greek	5158	Maltese	5966	Somali	6561
Armenian	5471	Greenlandic	5758	Maori	5955	Spanish	5165
Assamese	4765	Guarani	5360	Marathi	5964	Sundanese	6567
Aymara	4771	Gujarati	5367	Moldavian	5961	Swahili	6569
Azerbaijani	4772	Hausa	5447	Mongolian	5960	Swedish	6568
Bashkir	4847	Hebrew	5569	Nauru	6047	Tagalog	6658
Basque	5167	Hindi	5455	Nepali	6051	Tajik	6653
Bengali;Bangla	4860	Hungarian	5467	Norwegian	6061	Tamil	6647
Bhutani	5072	Icelandic	5565	Occitan	6149	Tatar	6666
Bihari	4854	Indonesian	5560	Oromo (Afan)	6159	Telugu	6651
Bislama	4855	Interlingua	5547	Oriya	6164	Thai	6654
Breton	4864	Interlingue	5551	Panjabi	6247	Tibetan	4861
Bulgarian	4853	Inupiak	5557	Pashto; Pushto	6265	Tigrinya	6655
Burmese	5971	Irish	5347	Persian	5247	Tonga	6661
Byelorussian	4851	Italian	5566	Polish	6258	Tsonga	6665
Cambodian	5759	Japanese	5647	Portuguese	6266	Turkish	6664
Catalan	4947	Javanese	5669	Quechua	6367	Turkmen	6657
Chinese	7254	Kannada	5760	Rhaeto-Romance	6459	Twi	6669
Corsican	4961	Kashmiri	5765	Romanian	6461	Ukrainian	6757
Croatian	5464	Kazakh	5757	Russian	6467	Urdu	6764
Czech	4965	Kinyarwanda	6469	Samoan	6559	Uzbek	6772
Danish	5047	Kirghiz	5771	Sangho	6553	Vietnamese	6855
Dutch	6058	Kirundi	6460	Sanskrit	6547	Volapuk	6861
English	5160	Korean	5761	Scots Gaelic	5350	Welsh	4971
Esperanto	5161	Kurdish	5767	Serbian	6564	Wolof	6961
Estonian	5166	Laothian	5861	Serbo-Croatian	6554	Xhosa	7054
Faroese	5261	Latin	5847	Sesotho	6566	Yiddish	5655
Fiji	5256	Latvian; Lettish	5868	Setswana	6660	Yoruba	7161
Finnish	5255	Lingala	5860	Shona	6560	Zulu	7267

Maintenance

SERVICING

- Please refer to relevant topics on the 'Troubleshooting' on pages 128–133 before returning the product.
- If this unit becomes inoperative, do not try to correct the problem by yourself. There are no user-serviceable parts inside. Turn off, unplug the power plug and please call our help line mentioned on the front page to locate an Authorized Service Center.

CLEANING THE CABINET

- Use a soft cloth slightly moistened with a mild detergent solution. Do not use a solution containing alcohol, spirits, ammonia or abrasive.

DVR DVR HANDLING

- DVR is a precision apparatus that is susceptible to vibration, strong impact or dirt. Depending on the installation environment or handling, the unit may become partially damaged or in the worst case, recording or replaying may not be available. Especially while the DVR is in motion, do not subject it to vibration or strong impact or pull out the power plug. And if a power failure occurs the content of the recording/replaying program may be lost.

DVR MOVING THE UNIT

- DVR rotates at high speed when in operation. Be sure that rotation has stopped and then move the unit without subjecting it to strong impact or vibration.

DVD CLEANING DISCS

- When a disc becomes dirty, clean it with a cleaning cloth. Wipe the disc from the center out. Do not wipe in a circular motion.
- Do not use solvents such as benzene, thinner, commercially available cleaners, detergent, abrasive cleaning agents or antistatic spray intended for analogue records.

DVD CLEANING THE DISC LENS

- If this unit still does not perform properly although you refer to the relevant sections and to 'Troubleshooting' in this Owner's Manual, the laser optical pickup unit may be dirty. Consult your dealer or an Authorized Service Center for inspection and cleaning of the laser optical pickup unit.

DVD DISC HANDLING

- Handle the discs so that fingerprints and dust do not adhere to the surfaces of the discs.
- Always store the disc in its protective case when it is not used.

VCR AUTO HEAD CLEANING

- Automatically cleans video heads as you insert or remove a videotape, so you can see a clear picture.
 - Playback picture may become blurred or interrupted while the TV program reception is clear. Dirt accumulated on the video heads after a long period of use, or the usage of rental or worn tapes can cause this problem. If a streaky or snowy picture appears during playback, the video heads in the unit may need to be cleaned.
1. Please visit your local Audio /Video store and purchase a good quality VHS Video Head Cleaner.
 2. If a Video Head Cleaner does not solve the problem, please call our help line mentioned on the front page to locate an Authorized Service Center.

NOTES:

- Remember to read the instructions along with the video head cleaner before use.
- Clean video heads only when problems occur.

Frequently Asked Questions

- Can I record on CD-R / RW?
No, this unit records only DVDs.
- Can I play back DVD-Video that is bought in another country?
Possible only if the region code of the disc is 1 or ALL.
- Is this unit JPEG compatible?
No.
- Can I connect the unit to my PC?
No, you cannot control the unit by PCs.

Specification

General

System	DVR, DVD-Video, DVD-RW/R, CD-DA, CD-RW/R, VCR	Dimensions (width x height x depth)	17 1/8" x 3 15/16" x 14 15/16" (435 x 99.5 x 380 mm)
VCR video heads	Four heads	Operating temperature	41°F to 104°F (5°C to 40°C)
DVR	Internal 3.5 inch HDD 80 GB	Operating humidity	less than 80% (non condensing)
Power requirements	AC120 V, 60 Hz	TV format	NTSC
Power consumption	44 W (standby: 4.6 W)		
Weight	12.2 lbs (5.53 kg)		

Recording

Recording format	Video Recording Format (DVD-RW only), Video Format (DVD-RW, DVD-R)	Video recording format Sampling frequency	13.5MHz
		Compression format	MPEG
Recordable discs	DVD-ReWritable, DVD-Recordable	Audio recording format Sampling frequency	48kHz
		Compression format	Dolby Digital

Tuner

Receivable channels

VHF	2-13ch
UHF	14-69ch
CATV	C1-C125ch

Input/Output

Video input Input level Jacks	Input 1 (rear), 2 (front) 1 Vp-p (75Ω) RCA jack	Video output Output level Jacks	1 Vp-p (75Ω) RCA jack
S-Video input Y (luminance) - Input level C (color) - Input level Jacks	Input 1 (rear), 2 (front) 1 Vp-p (75Ω) 286 mVp-p (75Ω) 4 pin mini DIN	S-Video output Y (luminance) - Output level C (color) - Output level Jack	1 Vp-p (75Ω) 286 mVp-p (75Ω) 4 pin mini DIN
Audio input During audio input Jacks	Input 1 (rear), 2 (front) L/R 2V rms (47kΩ) RCA jacks	Audio output During audio output Jacks	Output 1,2 L/R 2V rms (47kΩ) RCA jacks
Component video output Output level Jacks	Y: 1.0 Vp-p (75Ω), Pb/Cb, Pr/Cr: 0.7 Vp-p (75Ω) RCA jacks	Digital audio output Output level Jack	500 mVp-p (75Ω) RCA jack
		VHF/UHF antenna input/output terminal	VHF/UHF set 75Ω

Note

The specifications and design of this product are subject to change without notice.

Descripción Funcional

Panel Delantero

* La unidad también puede encenderse presionando estos botones.

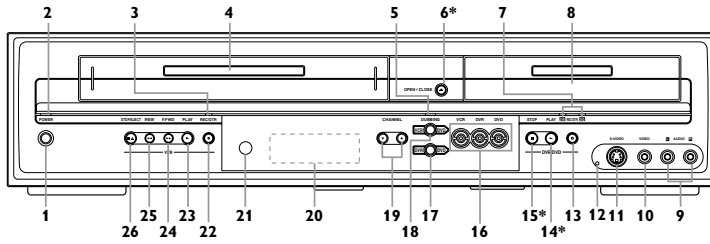

- | | | |
|----------------------------|---|---------------------------------|
| 1 POWER | 10 VIDEO IN (LINEA 2) | 18 DUBBING VCR→DVD |
| 2 Luz de POWER | 11 S-VIDEO IN (LINEA 2) | 19 CHANNEL ▲ / ▼ |
| 3 Luz de REC/OTR (VCR) | 12 REINICIALIZADO | 20 Pantalla del Panel Delantero |
| 4 Compartimiento de casete | 13 REC / OTR ● (DVR / DVD) | 21 Sensor de control remoto |
| 5 Luz de Doblaje | 14 PLAY ►* (DVR / DVD) | 22 REC / OTR ● (VCR) |
| 6 OPEN / CLOSE ▲* (DVD) | 15 STOP ■* (DVR / DVD) | 23 PLAY ► (VCR) |
| 7 Luz de REC/OTR (DVR/DVD) | 16 Botones Selección de Dispositivo / Indicadores (VCR/DVR/DVD) | 24 F.FWD ►► (VCR) |
| 8 Bandeja de disco | 17 DUBBING DVR→DVD | 25 REW ◀◀ (VCR) |
| 9 AUDIO IN (LINEA 2) | | 26 STOP / EJECT ■ ▲ (VCR) |

Panel trasero

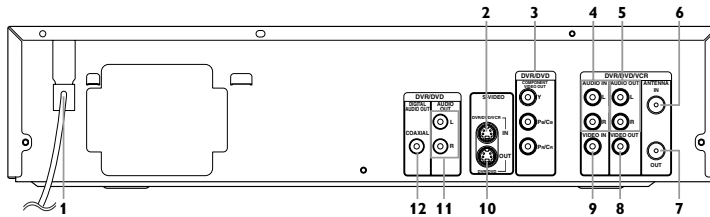

- | | | |
|-----------------------------------|------------------|--|
| 1 Cable eléctrico de CA | 5 AUDIO OUT | 9 VIDEO IN (LINEA 1) |
| 2 S-VIDEO IN (LINEA 1) | 6 TV ANTENNA IN | 10 S-VIDEO OUT (DVR / DVD) |
| 3 COMPONENT VIDEO OUT (DVR / DVD) | 7 TV ANTENNA OUT | 11 AUDIO OUT (DVR / DVD) |
| 4 AUDIO IN (LINEA 1) | 8 VIDEO OUT | 12 COAXIAL DIGITAL AUDIO OUT (DVR / DVD) |

Control remoto

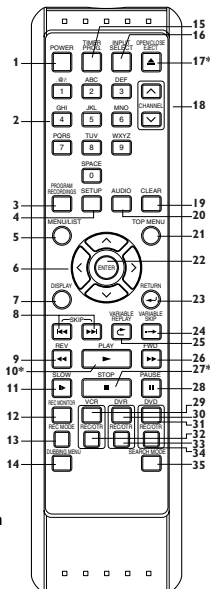

- | | |
|--------------------------------------|-----------------------------------|
| 1 POWER | 19 CLEAR |
| 2 Botones Numéricos | 20 AUDIO |
| 3 PROGRAM RECORDINGS | 21 TOP MENU (DVR / DVD) |
| 4 SETUP | 22 ENTER |
| 5 MENU / LIST (DVR / DVD) | 23 RETURN ← |
| 6 Cursor ▲ / ▼ / < / > | 24 VARIABLE SKIP → (DVR / DVD) |
| 7 DISPLAY | 25 VARIABLE REPLAY ↶ (DVR / DVD) |
| 8 SKIP ◀◀ / ▶▶ (DVR / DVD) | 26 FWD ►► |
| 9 REV ◀◀ | 27 STOP ■* |
| 10 PLAY ►* | 28 PAUSE II |
| 11 SLOW ► (VCR) | Botones Selección de Dispositivo: |
| 12 REC MONITOR (DVR / DVD) | 29 VCR |
| 13 REC MODE | 30 DVR |
| 14 DUBBING MENU | 31 DVD |
| 15 TIMER PROG. | 32 REC / OTR (VCR) |
| 16 INPUT SELECT | 33 REC / OTR (DVR) |
| 17 OPEN / CLOSE EJECT ▲ (DVD / VCR)* | 34 REC / OTR (DVD) |
| 18 CHANNEL ▲ / ▼ | 35 SEARCH MODE (VCR) |

* En DVR / DVD La unidad también puede encenderse presionando estos botones.

Conexión a un TV

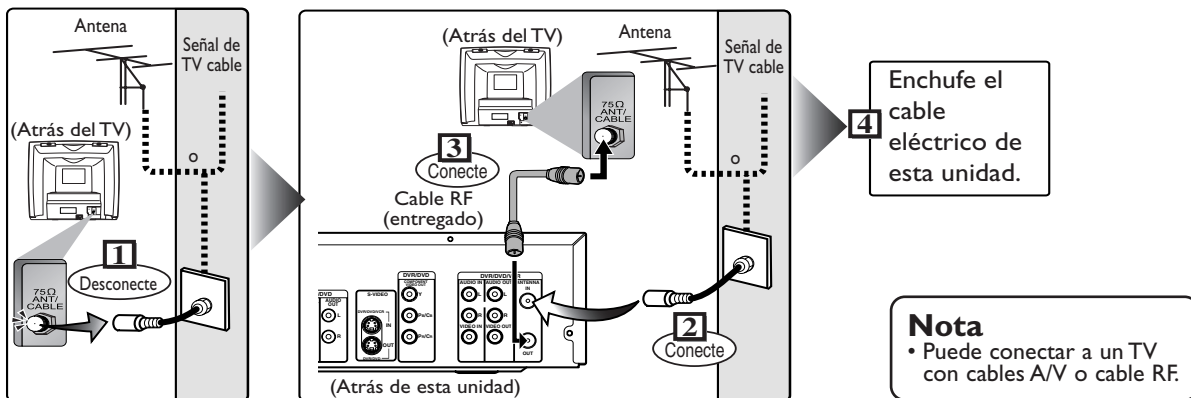

Haga una de las siguientes conexiones, según la capacidad de su equipo existente.

Conexión de Audio Básico

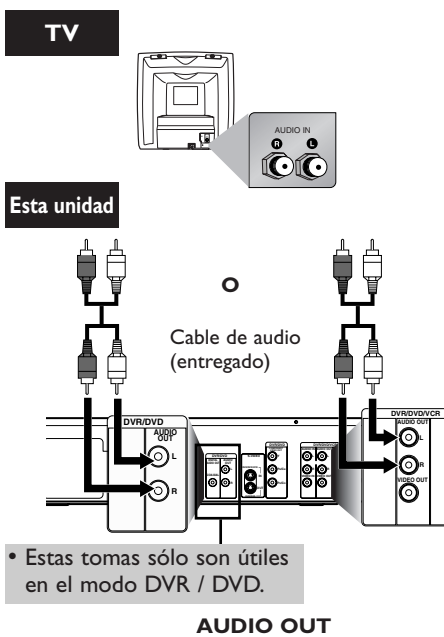

Conexiones de video (○ = Hay, – = No hay)

Calidad de la imagen	Básico	Bueno	Mejor
DVR/DVD	○ ○	○ ○	○ ○
VCR	○ (necesario)	–	–

TV	Básico	Bueno	Mejor
Esta unidad	<p>VIDEO IN</p> <p>Cable Video (entregado)</p> <p>VIDEO OUT</p>	<p>S-VIDEO IN</p> <p>Cable S-Video (en venta en los comercios)</p> <p>S-VIDEO OUT</p>	<p>(Compatible con el modo de escaneo progresivo)</p> <p>COMPONENT VIDEO IN</p> <p>Cable de video componente (en venta en los comercios)</p> <p>COMPONENT VIDEO OUT</p>

Si su TV es compatible con el escaneo progresivo 525 ó 625 y desea disfrutar de la imagen de alta calidad;

Utilice la conexión COMPONENT VIDEO OUT, ajuste el **"Progresivo"** a **"On"** en el Menú de Preparación (vea la página 117) y asegúrese que la indicación **"P.SCAN"** está activada en la Pantalla del Panel Delantero.

Si su TV no es compatible con el escaneo progresivo;

Si su TV no es compatible con el escaneo progresivo ajuste **"Progresivo"** a **"Off"** en el Menú de Preparación y asegúrese que la indicación **"P.SCAN"** está activada en la Pantalla del Panel Delantero.

Después de terminar las conexiones

Encienda su TV al canal de entrada externo adecuado (normalmente cerca del canal 0) para ver la salida de imágenes de esta unidad en el TV. Para encontrar el canal de entrada externo, presione repetidamente el botón de canal en el remoto de su TV hasta que aparezca la imagen de la grabadora de DVD.

Before You Start
Connections
Initial Setups
Recording / Dubbing
Playback
Editing
Other Setups
VCR functions
Others
Español

Configuraciones iniciales

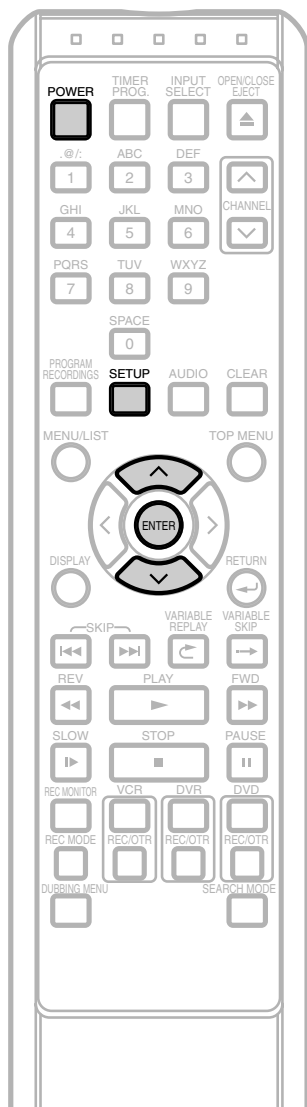

Primera vez que encienda la unidad

- 1 Después de hacer todas las conexiones necesarias encienda el TV y seleccione el canal de entrada externo adecuado. (vea la página 139.)
- 2 Presione **POWER**. Aparecerá la pantalla de abajo. Este menú puede no aparecer si ya activó la unidad antes. Vea las páginas 21-24 del Manual de Instrucciones en este caso.

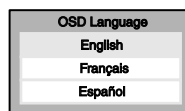

Si presiona **PLAY** ► en este punto, se seleccionará automáticamente **“English”** y puede saltar los pasos 3 y 4.

- 3 Presione **^ / v** para seleccionar **“English”**, **“Français”** o **“Español”**. Presione **ENTER**. Después de seleccionar el idioma, la Configuración Automática de Canales empezará automáticamente.
- 4 Después de terminar la Configuración Automática de Canales de Canales, se activará automáticamente la Función Automática de Reloj y se ajustará a la hora correcta.

Ajuste de audio del TV

- 1 Presione **SETUP**.
- 2 Utilice **^ / v** para seleccionar **“Config. Inic.”**. Presione **ENTER**.
- 3 Utilice **^ / v** para seleccionar **“Configur. Canal”**. Presione **ENTER**. Aparecerá el Menú de Configuración de Canal.



- 4 Utilice **^ / v** para seleccionar **“Selec. de Audio de TV”**. Presione **ENTER**. Aparecerá la ventana de Opciones.

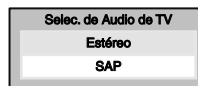

- 5 Utilice **^ / v** para seleccionar **“Estéreo”** o **“SAP”**. Presione **ENTER**.
Estéreo:
 Sale audio principal.
SAP (Programa de Audio Secundario):
 Sale el audio secundario.
- 6 Presione **SETUP** para salir.

Notas para el audio del canal de TV

• Consulte el siguiente cuadro para comprobar una configuración adecuada.

Audio transmitido		Audio seleccionado	Grabación de DVR/DVD/VCR
Canal audio principal	Canal audio secundario		
ESTÉREO	SAP	Estéreo	ESTÉREO
ESTÉREO	NONE		ESTÉREO
MONO	SAP		MONO
MONO	NONE		MONO
ESTÉREO	SAP	SAP	SAP
ESTÉREO	NONE		ESTÉREO
MONO	SAP		SAP
MONO	NONE		MONO

Grabación en DVR / DVD

Recordable disc

Discos que pueden utilizarse con esta grabadora:

- Disco DVD-R: hasta 16x (se recomienda un disco de 4x u 8x)
- Disco DVD-RW: 2x y 4x (se recomienda un disco de 2x)

Discos inspeccionados y prueban que son compatibles con esta grabadora:

MAXELL discos DVD-R 4x
 TDK discos DVD-RW 2x
 JVC discos DVD-RW 4x
 VERBATIM discos DVD-R 8x

Tipo de disco	Formato de disco	Funciones
	Modo de Video 	Reproducción, grabación, edición limitada
DVD-RW	Modo de VR 	Reproducción, grabación, edición de Lista Original / Playlist
	Modo de Video 	Reproducción, grabación limitada, edición limitada
DVD-R		

Los reproductores de DVD con **RW** son capaces de reproducir discos DVD-RW grabados en el modo de VR.

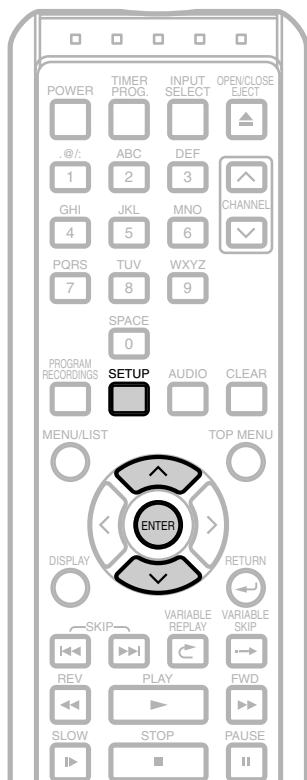

Modo gra

Puede seleccionar un Modo gra entre las seis opciones y el tiempo de grabación y la calidad de imagen/audio del material grabado depende del Modo gra seleccionado.

Tamaño de disco	Modo gra	Tiempo de grabación	Calidad de video/Sonido
Disco de 8 cm	XP	18 min	☆☆☆☆☆☆ (bueno)
	SP	36 min	☆☆☆☆☆
	LP	72 min	☆☆☆☆
	EP	108 min	☆☆☆
	SLP	144 min	☆☆
	SEP	180 min	☆ (malo)
Disco de 12cm	XP	60 min	☆☆☆☆☆☆ (bueno)
	SP	120 min	☆☆☆☆☆
	LP	240 min	☆☆☆☆
	EP	360 min	☆☆☆
	SLP	480 min	☆☆
	SEP	600 min	☆ (malo)
DVR	XP	17 H	☆☆☆☆☆☆ (bueno)
	SP	34 H	☆☆☆☆☆
	LP	68 H	☆☆☆☆
	EP	102 H	☆☆☆
	SLP	136 H	☆☆
	SEP	170 H	☆ (malo)

Para seleccionar el Modo gra preferido, presione repetidamente **REC MODE**.

Formateado de un disco



El tipo de formato de grabación seleccionado aquí se memorizará y aplicará al disco siempre que formatee los discos DVD-RW.

- 1 Presione **SETUP**.
- 2 Utilice \wedge / \vee para seleccionar “Menú DVD”. Presione **ENTER**.
- 3 Utilice \wedge / \vee para seleccionar “Formato grabac. DVD”. Presione **ENTER**. Aparecerá la ventana de Opciones.

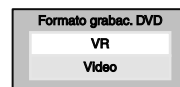

- 4 Utilice \wedge / \vee para seleccionar “VR” o “Video”. Presione **ENTER**.

Format Auto

Cuando coloque un disco DVD-RW completamente nuevo, la unidad formateará automáticamente el disco en el tipo de formato de grabación seleccionado en esta sección.

Grabación en DVR / DVD (Cont.)

Grabación básica



Lo siguiente le ayudará a entender fácilmente cómo grabar en DVR interno o en DVD.

Asegúrese que hay pilas en el control remoto y que ha conectado correctamente esta unidad y el TV.

Paso 1: Elija el tipo de disco y el Formato de grabac.
 (Sólo si está grabando a un DVD.)

Paso 2: Preparación del medio

- 1 Para encender.
- 2 Seleccione el equipo que desea utilizar. (Si está grabando en DVR, salte desde el paso 3.)
- 3 Abra la bandeja del disco y coloque un disco en la bandeja.
- 4 Cierre la bandeja del disco.

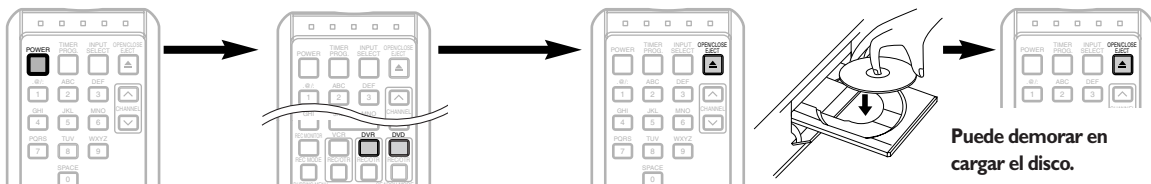

- Si carga un disco DVD-RW completamente nuevo, el Formato Auto empezará automáticamente.

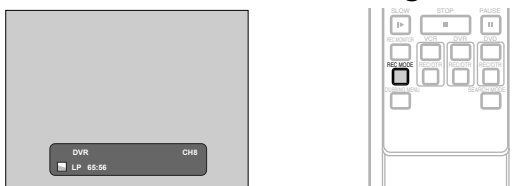
Paso 3: Seleccione el modo de grabación.

Paso 5: Empiece a grabar.

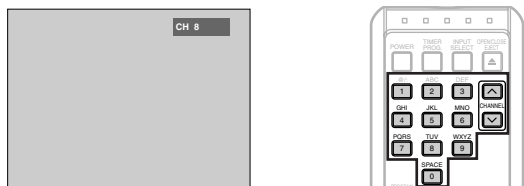
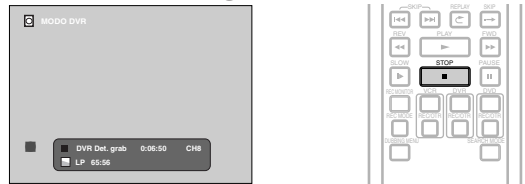
- Cuando graba en DVR: Presione **REC / OTR** (DVR).
- Cuando graba en DVD: Presione **REC / OTR** (DVD).

Paso 4: Seleccione el canal que desea grabar.

Paso 6: Pare la grabación.

Esta operación puede demorar en reconocerse.

Nota
El DVR es un lugar de memorización temporal.

- El DVR no es un lugar de memoria permanente del contenido grabado. Asegúrese de utilizar como lugar de memoria temporal hasta que mire los programas una vez, edite o copie en un disco DVD o videocinta.

Disco duro de 80 GB

- Esta unidad tiene un disco duro de 80 GB que permite grabar hasta 170 horas (en el modo SEP).

Grabación en DVR / DVD (Cont.)

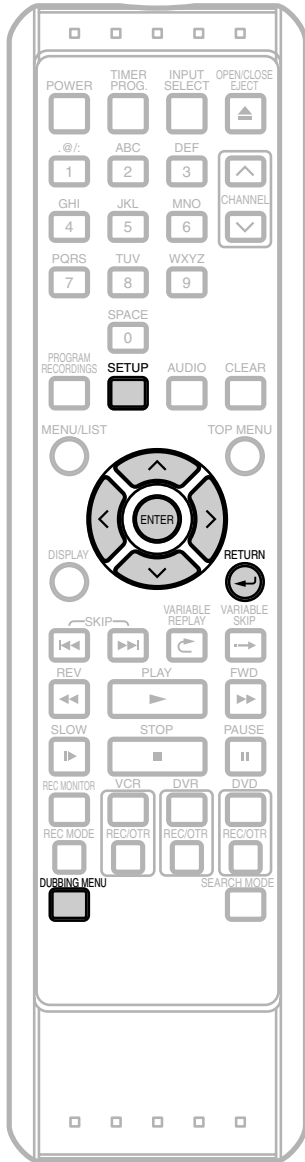

Doblaje básico



Se mostró como ejemplo en la figura el doblaje de DVR a DVD. Consulte el Manual de instrucciones sobre la forma de hacer otros tipos de doblaje.

1 Presione **DOUBLING MENU**.

Aparecerán el Sentido doblaje y el Menú de Modo gra.

DOBLAJE	
Sentido doblaje	Modo gra
DVR → DVD	Alto
DVD → DVR	XP
DVR → VCR	SP
VCR → DVR	LP
DVD → VCR	EP
VCR → VCR	SLP
	SEP
	Auto

2 Utilice \wedge / \vee y seleccione el sentido de doblaje deseado y presione **ENTER**.

Ejemplo: DVR → DVD

DOBLAJE	
Sentido doblaje	Modo gra
DVR → DVD	Alto
DVD → DVR	XP
DVR → VCR	SP
VCR → DVR	LP
DVD → VCR	EP
VCR → VCR	SLP
	SEP
	Auto

3 Utilice \wedge / \vee y seleccione el Modo gra deseado. Presione **ENTER**.

Aparecerá el Menú Superior de Doblaje.

DOBLAJE	
Lista doblaje	
Sentido DVR → DVD	
Modo XP	
Selec programa	
Inic doblaje	

4 Utilice \wedge / \vee para seleccionar “Selec programa”. Presione **ENTER**.

Aparecerá la Lista de programa.

DOBLAJE	
Lista progr. (Original)	Lista doblaje
1 Título 1	
2 Título 2	
3 Título 3	
4 Título 4	
5 Título 5	
6 Título 6	
7 Título 7	
8 Título 8	

Grabación en DVR / DVD (Cont.)

- 5** Utilice \wedge / \vee y seleccione un programa deseado. Presione **ENTER**. Aparecerá el Menú de Lista progr.



- 6** Utilice \wedge / \vee para seleccionar "Añadir a lista doblaje". Presione **ENTER**. El programa seleccionado se agregará a la Lista doblaje.

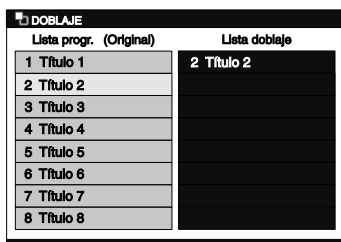

- 7** Repita los pasos 5 y 6 hasta que seleccione todos los programas a doblar.

- 8** Después de seleccionar todos los programas deseados, presione **RETURN** \leftarrow para volver al Menú Superior de Doblaje.

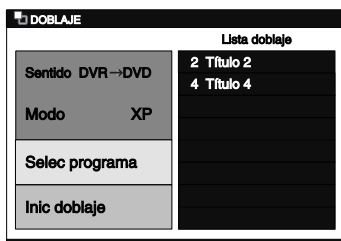

- 9** Utilice \wedge / \vee para seleccionar "Inic doblaje". Presione **ENTER**. Aparecerá la ventana de confirmación.

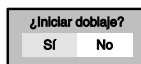

- 10** Utilice \leftarrow / \rightarrow para seleccionar "SÍ". Presione **ENTER**. Empezará el doblaje.
- Puede demorar en prepararse para el doblaje.

Para parar el doblaje durante el modo de preparación de doblaje:

- Presione primero el **Botón de Selección de Equipo** del medio de grabación y presione **STOP** \blacksquare . O presione **STOP/EJECT** \blacksquare \blacktriangle en el panel delantero.

Para parar el doblaje en progreso:

- Presione primero el **Botón de Selección de Equipo** del medio de grabación y mantenga presionado **STOP** \blacksquare durante 2 segundos, o presione **STOP/EJECT** \blacksquare \blacktriangle en el panel delantero.

Finalización



Debe finalizar primero el disco antes de reproducirlo en otra unidad.

- 1** Presione **SETUP**.
- 2** Utilice \wedge / \vee para seleccionar "Menú DVD". Presione **ENTER**.
- 3** Utilice \wedge / \vee para seleccionar "Finalizar". Presione **ENTER**. Aparecerá la ventana de confirmación.

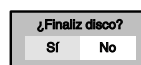

- Si ya finalizó el disco, "Anular Finalizar" aparecerá en la lista en el menú en lugar de "Finalizar" (sólo DVD-RW). Para anular la finalización del disco, seleccione "Anular Finalizar" y presione **ENTER**.

- 4** Utilice \leftarrow / \rightarrow para seleccionar "SÍ". Presione **ENTER**. Aparecerá la ventana de confirmación final.

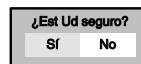

- 5** Utilice \leftarrow / \rightarrow para seleccionar "SÍ". Presione **ENTER**. Empezará la finalización.
- Si desea parar el proceso, presione **ENTER**.

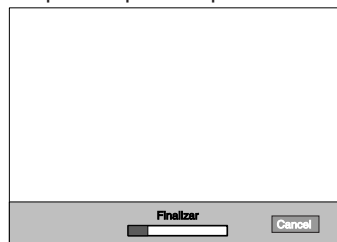

Esta operación puede demorar en reconocerse.

Reproducción de DVR / DVD

Antes de reproducir discos DVD, lea la siguiente información.

Discos que puede reproducir

Esta unidad es compatible para reproducir los siguientes discos.

Los discos con los siguientes símbolos pueden reproducirse en la unidad. No se garantiza la reproducción de otros tipos de discos.

Discos	Símbolo
DVD-VIDEO	
DVD-RW (Modo de VIDEO/VR)	
DVD-R (Modo de VIDEO)	
CD-DA (AUDIO CD)	
CD-RW (Formato CD-DA, archivos MP3 / WMA)	 
CD-R (Formato CD-DA, archivos MP3 / WMA)	 

 es una marca registrada de DVD Format/Logo Licensing Corporation.

Sistemas de color

Los DVD se graban en diferentes sistemas de color en diferentes regiones del mundo. El sistema de color más común es NTSC (que se utiliza primariamente en los Estados Unidos y Canadá). Esta unidad utiliza NTSC y los DVD que reproduce deben grabarse en el sistema NTSC. No puede reproducir DVD grabados en otro sistema de color.

Códigos de región

Los DVD deben tener la etiqueta para todas las regiones o para la Región 1.

Busque los siguientes símbolos en su DVD.



Reproduzca el contenido grabado

Puede seleccionar el título que desea reproducir de la Lista de Títulos. Puede acceder fácilmente a la Lista de Títulos presionando **TOP MENU**. Puede llamar también los títulos grabados presionando **PROGRAM RECORDINGS** (sólo la Lista Original del DVR).

¿Qué son títulos y capítulos?

El contenido del DVR / DVD se divide normalmente en títulos. Los títulos pueden dividirse a su vez en capítulos.

¿Qué es una Lista Original y una Lista de reproducción?

A lo largo de este manual encontrará Lista Original y Lista de reproducción para referirse al contenido Original y a la versión editada. (Vea la página 89.)

- Lista Original se refiere a lo que se grabó originalmente en el disco.
- Lista de reproducción se refiere a la versión editada del contenido Lista Original.

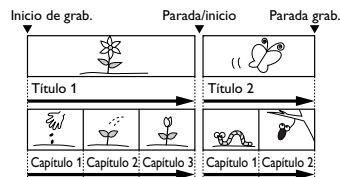

Reproducción de DVR / DVD (Cont.)

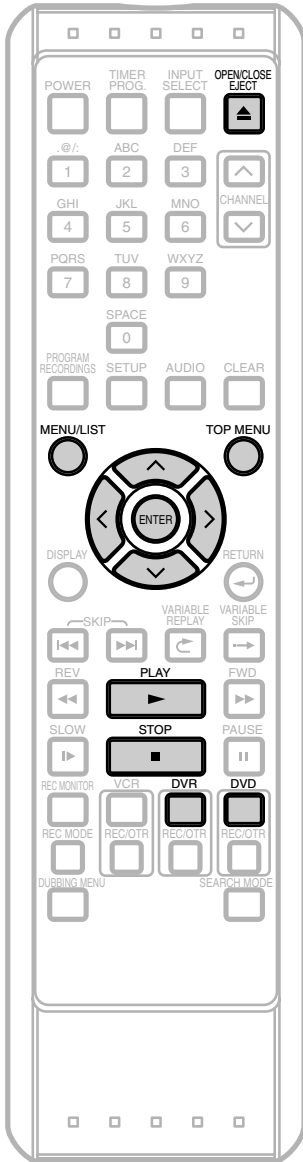

Reproducción básica



Si está reproduciendo DVR, presione primero **DVR**.
Si está reproduciendo un disco, presione primero **DVD**.

- 1 Si está reproduciendo DVR, salte al paso 4.
- 2 Presione **OPEN / CLOSE** ▲ para abrir la bandeja del disco.
- 3 Coloque el disco con su etiqueta hacia arriba. Alinee el Disco con la guía de la bandeja del disco.

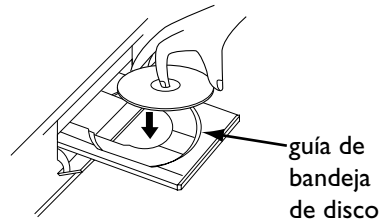

Presione otra vez **OPEN / CLOSE** ▲ para cerrar la bandeja del disco.
Presione **PLAY** ► para empezar a reproducir un CD.
Para la Reproducción DVR/DVD vaya al paso 4.
• Puede demorar en cargar el disco.

- 4 Presione **TOP MENU**.
Aparecerá la lista de título.

Ejemplo: DVR

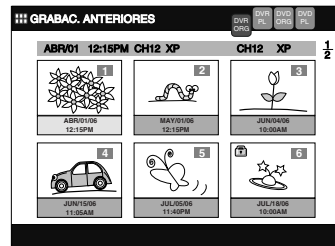

Presione **MENU / LIST** para cambiar entre Lista Original / Playlist si fuera necesario.

- 5 Utilice ▲ / ▼ / < / > para seleccionar un título deseado y presione **PLAY** ►.
Empezará la reproducción.
- 6 Presione **STOP** ■ para parar la reproducción.

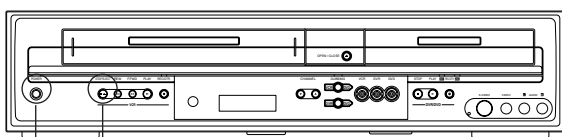

POWER STOP / EJECT ■▲

Grabación básica



Antes de grabar, asegúrese de que:

- Se seleccionó el canal deseado presionando los botones numéricos o **CHANNEL** ^ / v.
- Hay una cinta con la lengüeta para grabación intacta en la unidad.
- Se selecciona el Modo gra deseado (SP: reproducción normal o SLP: reproducción de larga duración) presionando **REC MODE** en el control remoto.

Modo gra

Velocidad de la cinta	Tiempo de grabación/reproducción			
	T60	T120	T160	T210
Tipo de cinta				
Modo SP	1 hora	2 horas	2-2/3 horas	3-1/2 horas
Modo SLP	3 horas	6 horas	8 horas	10-1/2 horas

- Se selecciona Estéreo o SAP.

Presione primero **VCR**.

- 1 Presione **REC / OTR** (VCR) para empezar la grabación.

Para parar temporalmente o seguir con la grabación, presione **PAUSE II**. Después de que la unidad ha estado en pausa durante cinco minutos, se parará automáticamente para proteger la videocinta y la cabeza de video contra daños.

- 2 Presione **STOP ■** cuando se complete la grabación.

Prevención contra borrado accidental

Para evitar una grabación por accidente en un casete grabado, rompa la lengüeta de grabación. Para volver a grabar posteriormente, cubra el orificio con cinta adhesiva.



Lengüeta de grabación

Reproducción básica



Presione primero **VCR**.

- 1 Coloque una cinta pregrabada y presione **PLAY ►** para empezar la reproducción.
 - Si no tiene lengüeta para grabación, la reproducción empieza automáticamente.
- 2 Durante la reproducción, presione **PAUSE II**. Se hará una pausa de reproducción y se silenciará el sonido.
- 3 Presione **PLAY ►** para continuar la reproducción.
- 4 Presione **STOP ■** para detener la reproducción.
- 5 Presione **STOP / EJECT ■▲** en el panel delantero de la unidad para expulsar la cinta.

 **Emerson**
LIMITED WARRANTY

FUNAI CORP. will repair this product, free of charge in the USA in the event of defect in materials or workmanship as follows:

DURATION:

PARTS: FUNAI CORP. will provide parts to replace defective parts without charge for one (1) year from the date of original retail purchase. Certain parts are excluded from this warranty.

LABOR: FUNAI CORP. will provide the labor without charge for a period of ninety (90) days from the date of original retail purchase.

LIMITS AND EXCLUSIONS:

This warranty is extended only to the original retail purchaser. A purchase receipt or other proof of original retail purchase will be required together with the product to obtain service under this warranty.

This warranty shall not be extended to any other person or transferee.

This warranty is void and of no effect if any serial numbers on the product are altered, replaced, defaced, missing or if service was attempted by an unauthorized service center. This limited warranty does not apply to any product not purchased and used in the United States.

This product is produced for home use and this warranty only covers failures due to defects in material or workmanship which occurs during normal use. It does not cover damage which occurs in shipment, or failures which are caused by repairs, alterations or product not supplied by FUNAI CORP., or damage which results from accident, misuse, abuse, mishandling, misapplication, alteration, faulty installation, improper maintenance, commercial use such as hotel, rental or office use of this product or damage which results from fire, flood, lightning or other acts of God.

THIS WARRANTY DOES NOT COVER PACKING MATERIALS, ANY ACCESSORIES (EXCEPT REMOTE CONTROL), ANY COSMETIC PARTS, COMPLETE ASSEMBLY PARTS, DEMO OR FLOOR MODELS.

FUNAI CORP. AND ITS REPRESENTATIVES OR AGENTS SHALL IN NO EVENT BE LIABLE FOR ANY GENERAL, INDIRECT OR CONSEQUENTIAL DAMAGES ARISING OUT OF OR OCCASIONED BY THE USE OF OR THE INABILITY TO USE THIS PRODUCT. THIS WARRANTY IS MADE IN LIEU OF ALL OTHER WARRANTIES, EXPRESS OR IMPLIED, AND OF ALL OTHER LIABILITIES ON THE PART OF FUNAI, ALL OTHER WARRANTIES INCLUDING THE WARRANTY OF MERCHANTABILITY AND FITNESS FOR A PARTICULAR PURPOSE, ARE HEREBY DISCLAIMED BY FUNAI AND ITS REPRESENTATIVES IN THE UNITED STATES. ALL WARRANTY INSPECTIONS AND REPAIRS MUST BE PERFORMED BY AN AUTHORIZED SERVICE CENTER. THIS WARRANTY IS ONLY VALID WHEN THE UNIT IS CARRIED-IN TO AN AUTHORIZED SERVICE CENTER.

IMPORTANT:

THIS LIMITED WARRANTY GIVES YOU SPECIFIC LEGAL RIGHTS. YOU MAY HAVE OTHER RIGHTS THAT VARY FROM STATE TO STATE. IF, AT ANY TIME DURING THE WARRANTY PERIOD, YOU ARE UNABLE TO OBTAIN SATISFACTION WITH THE REPAIR OF THIS PRODUCT, PLEASE CONTACT FUNAI CORP.

ATTENTION:

FUNAI CORP. RESERVES THE RIGHT TO MODIFY ANY DESIGN OF THIS PRODUCT WITHOUT PRIOR NOTICE.

To locate your nearest AUTHORIZED SERVICE CENTER or for general service inquiries, please contact us at:

FUNAI CORPORATION
Customer Service

Tel :1-800-605-8453

<http://www.EmersonAudioVideo.com>

19900 Van Ness Avenue, Torrance, CA 90501

Free Manuals Download Website

<http://myh66.com>

<http://usermanuals.us>

<http://www.somanuals.com>

<http://www.4manuals.cc>

<http://www.manual-lib.com>

<http://www.404manual.com>

<http://www.luxmanual.com>

<http://aubethermostatmanual.com>

Golf course search by state

<http://golfingnear.com>

Email search by domain

<http://emailbydomain.com>

Auto manuals search

<http://auto.somanuals.com>

TV manuals search

<http://tv.somanuals.com>