



## **BOTTLE COOLER/WARMER**



Fan stays on all the  
time as long as power  
is on.

**OWNER'S MANUAL**

**FR11SL**



EMERSON  
PART NO.: FR11SL-01312007-01

Printed in China

Visit our web site at [www.emersonradio.com](http://www.emersonradio.com)

UNAUTHORIZED MODIFICATIONS TO THIS DEVICE COULD VOID  
THE USER'S AUTHORITY TO OPERATE IT.

# SAFETY INSTRUCTIONS

	<b>CAUTION</b> RISK OF ELECTRIC SHOCK DO NOT OPEN	
CAUTION: TO REDUCE THE RISK OF ELECTRIC SHOCK, DO NOT REMOVE COVER (OR BACK). NO USER-SERVICEABLE PARTS INSIDE. REFER SERVICING TO QUALIFIED SERVICE PERSONNEL.		



## DANGEROUS VOLTAGE:

The lightning flash with arrowhead symbol within an equilateral triangle is intended to alert the user to the presence of uninsulated dangerous voltage within the product's enclosure that may be of sufficient magnitude to constitute a risk of electric shock to persons.



## ATTENTION:

The exclamation point within an equilateral triangle is intended to alert the user to the presence of important operating and maintenance (servicing) instructions in the literature accompanying the appliance.

**WARNING: TO REDUCE THE RISK OF ELECTRIC SHOCK, DO NOT EXPOSE THIS APPLIANCE TO RAIN OR MOISTURE.**

1

# IMPORTANT SAFEGUARDS

When using this electrical appliance, safety precautions should Always be observed, including the following:

- Before using the appliance, read the instructions carefully.
- To protect against electrical shock, do not immerse plug, cord or the appliance itself in water or any other liquid.
- Do not let the cord hang over the edge of the work space or touch any hot surfaces.
- Do not place near hot gas or electric burner.
- Do not use the appliance if the plug or the electrical cable is damaged or if the appliance does not work properly. Please see a qualified electrician for replacement or repair.
- Do not pull or carry appliance by its cord, use the cord as a handle and/or pull cord around sharp edges or corners. Do not use appliance over cord. (Keep cord away from heated surface.)
- Do not unplug by pulling on cord. To unplug, grasp the plug, not the cord.
- Do not handle plug or appliance with wet hands. Always unplug before cleaning and removing parts. Clean with damp cloth only.
- Do not clean with metal scrubbing pads.
- The appliance has a polarized plug (one blade is wider than the other). This plug will fit into a polarized electrical outlet only one way, as a safety feature. Reverse the plug if the plug does not fully fit in the outlet. Contact a qualified electrician if it still does not fit. Do not attempt to defeat this safety feature.
- The speed at which the unit cools/heats the liquid will depend on the size of the bottle or container and the starting temperature.
- Always check temperature before consuming.
- This is not a toy. Please keep out of reach of children.
- Use only as described in this manual.
- Do not touch the hot surfaces.
- Close supervision is necessary when any appliance is used by or near children.

2

## IMPORTANT SAFEGUARDS

- \* Extreme caution must be used when moving an appliance containing hot liquids.
- \* Do not use appliance for uses other than intended use.
- \* Before serving, unplug cord from wall outlet and unit. Do not leave cord within child's reach.
- \* This unit is not intended to store unpacked beverages. It is recommended to load the unit with a beverage in its original container.
- \* Beverages stored using the warm setting must be consumed within one hour.

## SAVE THESE INSTRUCTIONS

- The extension cords are available and may be used if care is exercised in their use.
- If a longer extension cord is used:
  - The marked electrical rating of the detachable power-supply cord or extension cord should be at least as great as the electrical rating of the appliance.
  - The longer cord should be arranged so that it will not drape over the counter top or table top where it can be pulled on by children or tipped over.

## LOCATION OF CONTROLS

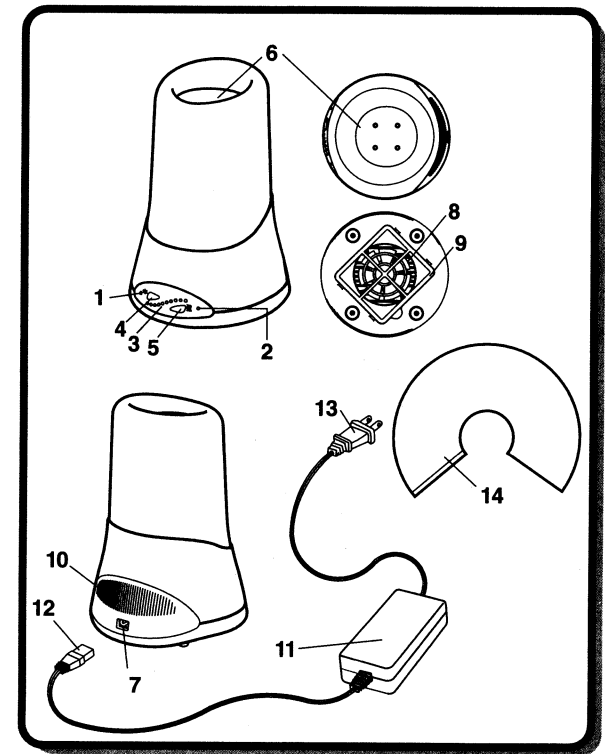

## 1. FEATURES

Wine Bottle Cooler /Warmer, using Peltier and CPU technology To control 10 temperature settings (min, 37, 44, 47, 51, 59, 63, 68, 75, 122°F) designed for cooling, warming and keeping constant temperature for various kind of wines (such as white wines, red wines, Japanese Sake...etc). It is very easy for the users to control the wine at optimum temperature constantly and enjoy the drink.

- (1) Green "Cooling" LED light
- (2) Red "Warming" LED light
- (3) 10 green LED lights to indicate temperatures at (min, 37, 44, 47, 51, 59, 63, 68, 75 and 122°F)
- (4) "Down" button to move temperature setting downward.
- (5) "UP" button to move temperature setting upward.
- (6) Aluminium container with 90mm diameter
- (7) DC power inlet socket
- (8) Air inlet of fan
- (9) Removable air filter
- (10) Air outlet
- (11) AC/DC switching mode power supply
- (12) DC jack
- (13) AC plug with power cord
- (14) Insulation sleeve

\* To avoid electric shock. Do not open.

\* Any repair work must be done by qualified technician appointed by our distributors.

\* Specifications are subject to change for improvement without prior notice.

## 2. SPECIFICATIONS

- Aluminium container : 90mm diameter
- Temperature settings : 10 settings (min, 37, 44, 47, 51, 59, 63, 68, 75 and 122°F)
- Fan : 90 x 90 mm Brushless motor
- High temperature protection : 70°C
- Switching mode power supply : 12 V d.c. 5 Amp
- Power consumption : 60W
- Dimension : 183 mm (base diameter) x 282 mm (height)

## 3. CONNECTION

1. After removing the packaging materials, there should be 3 items :
  - a. Wine Bottle Cooler/Warmer unit.
  - b. AC/DC switching mode power supply.
  - c. Insulation Sleeve.
2. Plug the DC power jack (12) of the switching mode power Supply to the DC socket (7) of the unit, then connect the AC plug (13) of the switching mode power supply to the appropriate mains socket. The default temperature is set at minimum ("min") and the green "LED" (1) at the left hand side of the control panel that indicates "cooling" will be ON after 5 seconds.

## 4. OPERATION

You may press the front "UP" Button (5) [as Fig.1] or "Down" Button (4) [as Fig.2] to select your required temperature and the 10 green LED indicators (3) will show your temperature selection. The sensors inside the unit detects the temperature of the aluminium container and the CPU will compare it with your temperature setting to decide whether it should be "Cooling" or "Warming".

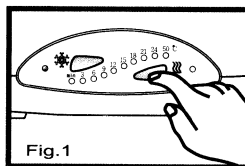

Fig.1

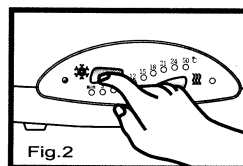

Fig.2

"Cooling" - If the temperature of the aluminium container is higher than the temperature set, the green "Cooling" LED (1) at the left of the control panel will be on. [as Fig.3]

"MIN" - The unit will continuously run when it is set at "min" position.

"Warming" - If the temperature of the aluminium container is lower than the temperature set, the red "Warming" LED (2) at the right of the control panel will be on. [as Fig.4]

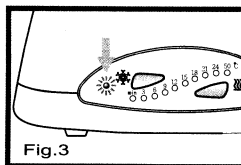

Fig.3

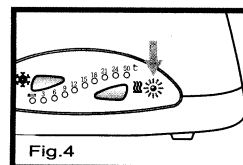

Fig.4

7

When the temperature of the aluminium container has reached the temperature set, the green & red LED at the two sides of the control panel will both be off, leaving only the green LED that indicates the set temperature on.

It takes the sensor 5 seconds to switch from heating to cooling and vice versa.

The main function of this unit is not just for "cooling" or "warming" the wine bottle but also maintaining the wine temperature at a set point so that the user can enjoy wine drinking at leisure. However, the user should note that the white wine bottle should be pre-cooled in a refrigerator before putting it in the Wine Bottle Cooler/Warmer to maintain temperature or it will take more than one hour to cool the bottle.

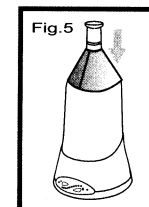

Fig.5

For faster cooling or warming effect, the insulation sleeve (14) provided may be used to cover the top part of the bottle. [as Fig.5]

For wine bottle which is smaller than 90mm diameter, we recommend the bottle be placed off center so that the bottle can be in contact with the wall of aluminium container for more effective cooling/warming. In this case, the shape of the insulation sleeve can be altered.

## 5. FILTER CLEANING

The user may take the removable air filter (9) from the bottom of the unit for cleaning or washing. as Fig.6 Before taking out this air filter, make sure to disconnect the AC plug of switching mode power supply from the mains socket.

8

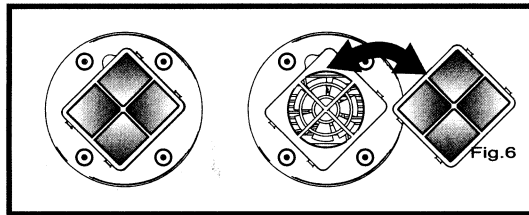

## 6. CAUTIONS

- The user do not need to put ice or water inside the container (6) for cooling purpose.
- After having finished using the Wine Bottle Cooler/Warmer, the user should Disconnect the AC plug (13) of switching power supply from the mains socket.
- Avoid using the AC/DC switching mode power supply in wet or damp place.
- Avoid putting any paper, plastic bag or cloth underneath the Wine Bottle Cooler/Warmer unit that may block the air inlet.
- In the case, when there are more than one green "temperature" LED (3) on at the same time, please unplug the DC socket and plug it again.
- If there is no power coming from the switching mode power supply unit, it should be checked by a electrical technician to see if the fuses inside the unit is faulty.

## EMERSON RADIO CORP. LIMITED WARRANTY

Emerson Radio Corp. warrants manufacturing defects in original material, including original parts and workmanship, under normal use and conditions, for a period of ninety (90) days from the date of original purchase in the U.S. With your dated proof of purchase, we will provide repair service at no charge for labor and parts at an authorized Depot Repair Facility, or replace the product in our discretion. For repair or replacement, pack your unit in a padded box, enclose your check or money order payable to Emerson Radio Corp. in the amount of \$9.00 (not required by California residents) to cover shipping and handling cost, and enclose a copy of your proof of purchase. Send your unit to :

Emerson Radio Corp.  
5101 Statesman Drive  
Irving, TX 75063

This warranty does not cover damage from negligence, misuse, abuse, accident, failure to follow operation instructions, commercial use, rental, repairs by an unauthorized facility, or products purchased, used, serviced or damaged outside of the United States.

THIS WARRANTY GIVES YOU SPECIFIC LEGAL RIGHTS, AND YOU MAY ALSO HAVE OTHER RIGHTS WHICH VARY FROM STATE TO STATE.

AU898M

The serial number of your system is located on a label on the bottom cabinet. Please Take a moment now to locate the serial number and write the number in the space provided below. You may be asked to provide this number when calling for product service.

Model Number : FR11SL  
Serial Number : \_\_\_\_\_

 **Emerson.**  
SERVICE

TO FIND THE LOCATION AND PHONE NUMBER OF YOUR NEAREST SERVICE CENTER PERMITTED TO PERFORM WARRANTY...

CALL TOLL FREE: 1-800-695-0098

FOR ADDITIONAL SET-UP OPERATING ASSISTANCE  
PLEASE CALL:  
1-800-898-9020

FOR CUSTOMER SERVICE, PLEASE WRITE TO:  
Emerson Radio Corp.,  
Consumer Affairs Dept.,  
5101 Statesman Drive,  
Irving, TX 75063.

## Free Manuals Download Website

<http://myh66.com>

<http://usermanuals.us>

<http://www.somanuals.com>

<http://www.4manuals.cc>

<http://www.manual-lib.com>

<http://www.404manual.com>

<http://www.luxmanual.com>

<http://aubethermostatmanual.com>

Golf course search by state

<http://golfingnear.com>

Email search by domain

<http://emailbydomain.com>

Auto manuals search

<http://auto.somanuals.com>

TV manuals search

<http://tv.somanuals.com>