



Emerson®

PORTABLE ICE MAKER

OWNER'S MANUAL
IM90/IM90W

Visit our web site at www.emersonradio.com

IMPORTANT SAFETY INSTRUCTIONS



CAUTION
RISK OF ELECTRIC SHOCK
DO NOT OPEN



CAUTION: TO REDUCE THE RISK OF ELECTRIC SHOCK, DO NOT REMOVE COVER (OR BACK). NO USER-SERVICEABLE PARTS INSIDE. REFER SERVICING TO QUALIFIED SERVICE PERSONNEL.



DANGEROUS VOLTAGE:

The lightning flash with arrowhead symbol within an equilateral triangle is intended to alert the user to the presence of uninsulated dangerous voltage within the product's enclosure that may be of sufficient magnitude to constitute a risk of electric shock to persons.



ATTENTION:

The exclamation point within an equilateral triangle is intended to alert the user to the presence of important operating and maintenance (servicing) instructions in the literature accompanying the appliance.

Emerson Radio Corp. has taken great care to make sure your unit was in perfect working order when it left our factory.

This unit has been designed to give you many years of enjoyment and trouble-free operation. Read this manual before operating this unit to become familiar with its features. In the event you require technical assistance, please contact the Emerson Radio Customer Service hotline at 1-800-898-9020. Retain this manual for future reference.

Please follow the precautions below for your new ice maker:

1. This ice maker must be properly installed and located in accordance with the Installation Instructions before it is used.
2. Unplug the ice maker before cleaning and/or making repairs.
3. We strongly recommend that any servicing be performed by a qualified individual.
4. Do not leave ice maker in extreme cold or warm temperatures.
5. Do not place ice maker near heat sources or open flames.
6. Clean the outside of the ice maker with a soft, damp cloth. Remove stains with a mild soap. Do not clean the unit with industrial grade solvents or abrasive chemicals.
7. Do not place heavy items on top of the ice maker.
8. Never install the ice maker where there is a lot of moisture and water can splash.
9. Exercise caution and use reasonable supervision when appliance is used near children.
10. Do not tip over.
11. Do not operate with side or back panels removed.
12. If the ice maker is brought in from outside in wintertime, give it a few hours to warm up to room temperature before plugging it in.

SAVE THESE INSTRUCTIONS

GROUNDING INSTRUCTIONS

This appliance must be grounded. In the event of an electrical short circuit, grounding reduces the risk of electric shock by providing an escape wire for the electric current. This appliance is equipped with a cord having a grounding wire with a grounding plug. The plug must be inserted into an outlet that is properly installed and grounded.

WARNING: Improper use of the grounding plug can result in a risk of electric shock. Consult a qualified electrician or service person if the grounding instructions are not completely understood, or if doubt exists as to whether the appliance is properly grounded.

If it is necessary to use an extension cord, use only a three-wire extension cord that has a three-blade grounding plug and a three-slot receptacle that will accept the plug on the appliance. The marked rating of the extension cord should be equal to or greater than the electrical rating of the appliance.

INSTALLATION

- Ventilation:** Do not block air vents.
- Cleaning:** It is highly recommended to thoroughly clean the ice maker before first use as shown on page 5.
- Wait One Hour:** Before plugging in, allow one hour for the refrigerant fluid to settle. After plugging in power cord wait one hour before adding water to the tank.
- Power supply:**
 - Check your local power source. This ice maker requires a 120V, 60Hz power supply.
 - Use a receptacle that will accept the ground prong. The power cord of this appliance is equipped with a 3-prong (grounding) plug which mates with a standard 3-prong (grounding) wall outlet to minimize the possibility of electric shock hazard from this appliance.

A. Longer cord sets or extension cords are available and may be used if care is exercised in their use.

B. If a long cord or extension cord is used, (1) the marked electrical rating of the cord set or extension cord should be at least as great as the electrical rating of the appliance, (2) the extension cord must be a grounding-type 3-wire cord, and (3) the longer cord should be arranged so that it will not drape over the countertop or tabletop where it can be pulled on by children or tripped over unintentionally.

NOTES:

- The ice maker should always be plugged into its own individual electrical outlet which has a voltage rating that matches the rating plate.
- If you have only a standard 2-prong wall outlet, it is your personal responsibility and obligation to have it replaced with a properly grounded 3-prong wall outlet.
- Never unplug your ice maker by pulling on the power cord. Always grip plug firmly and pull straight out from the outlet.

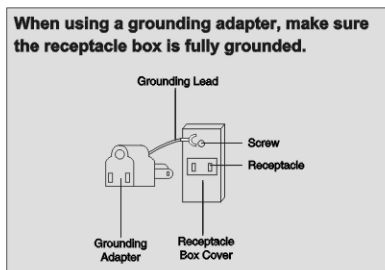
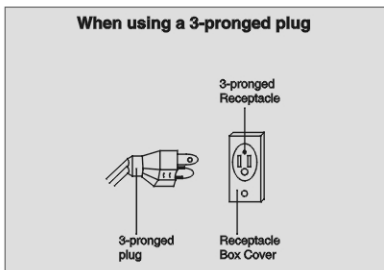

LOCATION OF CONTROLS

OPEN

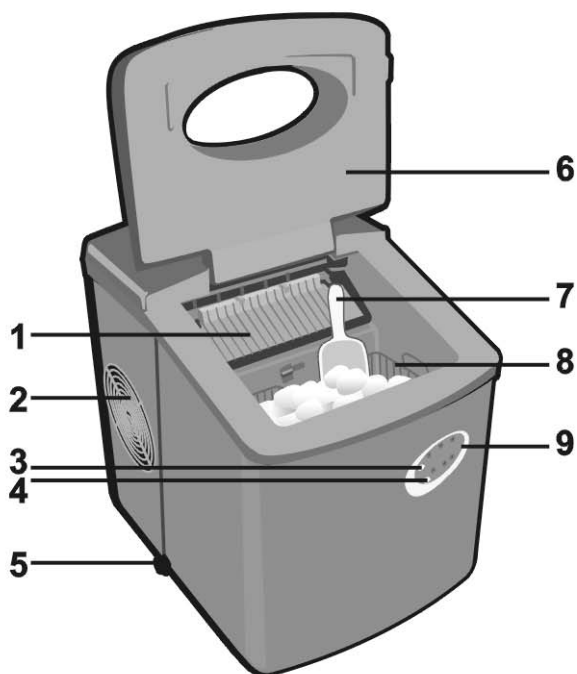

1. Ice Scoop
2. Air Outlet
3. SELECT Button
4. POWER Button
5. Water Drain Cap
6. Cover
7. Ice Shovel
8. Ice Basket
9. Control Panel Indicators (Clockwise from Top Left):
 - A. Small (S) ICE Indicator
 - B. Medium (M) ICE Indicator
 - C. Large (L) ICE Indicator
 - D. Add Water Indicator
 - E. ICE/ICE FULL Indicator
 - F. Power (On/Off) Indicator*

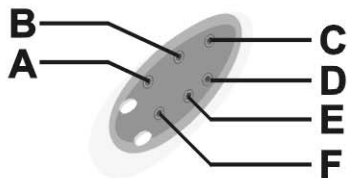

* When this unit is connected to an AC power supply but is turned OFF, the Power indicator will blink. When the unit is turned on (by pressing the POWER button), the Power indicator will be lit.

OPERATION

1





Lift open the cover, remove the ice basket and pour water into tank. **KEEP WATER LEVEL BELOW THE LEVEL MARK.*** Close the cover.

Press the POWER button on the control panel to begin the ice making process. The ice making process will last 7 to 13 minutes, depending on the size of the ice cube selection and the water's and room's temperature.

NOTE: Warmer water and/or room temperature will increase the ice making time. Use cool water to shorten the ice making process.

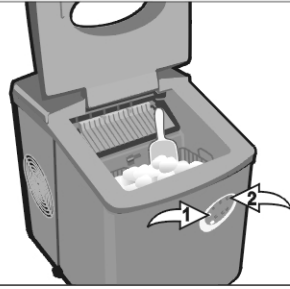
2



Select the size of the ice cube by pressing the SELECT button  repeatedly until the corresponding LED indicator (Small (S), Medium (M) or Large (L) ICE indicator ) lights up.

If the room temperature is lower than 60° F, it is recommended to select Small or Medium to avoid ice sticking together.

3



While the ice maker is on, check the Add Water indicator periodically. If the Add Water indicator is on, the ice maker will stop automatically. In this case, press the POWER button (to turn the unit off) and fill water up to the level mark. Wait three minutes for the refrigerant liquid to settle, then press the POWER button again (to turn on the unit again).

4



The ice maker automatically stops working when the ice basket is full in which case the ICE /ICE FULL indicator will light.

CHANGING THE WATER: Change the water in the water reservoir every 24 hours to ensure a reasonable hygiene level. If unit is not in use, drain all water left in the tank. For best results, the use of distilled water is recommended.

* Water container holds 3Qt. 14FL OZ of water.

DRAINING THE WATER: To drain the water, simply remove the cap from the drain. Replace after draining the water.

CLEANING AND MAINTAINING YOUR ICE MAKER

Before using your ice maker, you are strongly recommended to clean it thoroughly.

1. Remove the ice basket.
2. Clean the interior with warm water and a soft cloth.
3. The outside of the ice maker should be cleaned regularly with a mild detergent solution and warm water.
4. Dry the interior and exterior with a soft cloth.
5. When the machine is not in use, open the water drain cap to completely drain the water reservoir.

SPECIFICATIONS

| | |
|------------------------------|--|
| Ice Making Capacity | Up to 26.4 lbs |
| Speed | Approx. 9 pieces per 10 minutes |
| Ice Shape | Small/Medium/Large Bullet type |
| Ice Storage Capacity | 2.2 lbs |
| Water Storage Capacity | 3 QT. 14 FL OZ. (3.2 L) |
| Compressor..... | High efficient compressor with Low noise operation |
| Refrigeration Code | R134A |
| Power | AC120V, 60Hz |

Specifications and design subject to change without notice.

TROUBLESHOOTING GUIDE

The ice maker will not operate:

- The power supply cord is unplugged.
- A household fuse or circuit breaker has been tripped.

The Add Water Indicator is lit:

- Press the POWER button, fill water up to the level mark . Wait three minutes for the refrigerant liquid to settle, then press the POWER button again to turn on the unit again.

The ICE/ICE FULL indicator is lit:

- There is too much ice; remove ice from ice basket.

Ice cubes are sticking together:

- The ice cycle is too long. Press the POWER button and when the ice block melts, wait three minutes for the refrigerant liquid to settle, then press the POWER button again to turn on the unit again. Select the Small size ice cube selection.
- Water temperature in inner tank is too low. Remove water and insert fresh water with a temperature of between 45° F and 90° F.

Ice making cycle is normal but no ice is made:

- Ambient temperature or water temperature in inner tank is too high; make sure the room temperature in the room is below 90° F and/or remove water and insert fresh water with a temperature of between 45° F and 90° F.
- Refrigerant liquid leakage; call an authorized technician to repair.
- Pipe in the cooling system is blocked; call an authorized technician to repair.

LIMITED WARRANTY

Emerson Radio Corp. warrants manufacturing defects in original material, including original parts and workmanship, under normal use and conditions, for a period of one year from the date of original purchase in the U.S. With your dated proof of purchase, we will provide repair service at no charge for labor and parts at an authorized Depot Repair Facility, or replace the product in our discretion. For repair or replacement, pack your unit in a padded box, enclose your check or money order payable to Emerson Radio Corp. in the amount of \$10.00 (not required by California residents) to cover shipping and handling costs, and enclose a copy of your proof of purchase. Send your unit to:

Emerson Radio Corp.,
5101 Statesman Drive,
Irving, TX 75063

This warranty does not cover damage from negligence, misuse, abuse, accident, failure to follow operating instructions, commercial use, rental, repairs by an unauthorized facility, or products purchased, used, serviced or damaged outside of the United States.

THIS WARRANTY GIVES YOU SPECIFIC LEGAL RIGHTS, AND YOU MAY ALSO HAVE OTHER RIGHTS WHICH VARY FROM STATE TO STATE.

AU898N

The serial number can be found on the rear of the unit. We suggest that you record the serial number of your unit in the space below for future reference.

Model Number: IM90/IM90W

Serial Number: _____

| | |
|---|---|
|  | TO FIND THE LOCATION AND PHONE NUMBER OF YOUR NEAREST SERVICE CENTER PERMITTED TO PERFORM WARRANTY... |
| CALL TOLL FREE: 1-800-695-0098 | |
| FOR ADDITIONAL SET-UP OR OPERATING ASSISTANCE PLEASE CALL: 1-800-898-9020 | |
| FOR CUSTOMER SERVICE, PLEASE WRITE TO: Emerson Radio Corp., Consumer Affairs Dept., 5101 Statesman Drive, Irving, TX 75063. | |



Free Manuals Download Website

<http://myh66.com>

<http://usermanuals.us>

<http://www.somanuals.com>

<http://www.4manuals.cc>

<http://www.manual-lib.com>

<http://www.404manual.com>

<http://www.luxmanual.com>

<http://aubethermostatmanual.com>

Golf course search by state

<http://golfingnear.com>

Email search by domain

<http://emailbydomain.com>

Auto manuals search

<http://auto.somanuals.com>

TV manuals search

<http://tv.somanuals.com>