



EMERSON AND THE G-CLEF LOGO ARE REGISTERED TRADEMARKS
OF EMERSON RADIO CORP., PARSIPPANY, NEW JERSEY, U.S.A.

LC407EM1



EN Owner's Manual

Need help?

Please call toll free or visit our web site below

FR Manuel du Propriétaire **Besoin d'aide?**

Appelez notre numéro gratuit ou visitez notre site web à l'adresse

ES Manual del Propietario

¿Necesita ayuda?

Llame por favor sin costo ó visite nuestro sitio web en

 **1-866-309-8819**







www.emersonaudiovideo.com

MODEL NUMBER

SERIAL NUMBER

WARNING: TO REDUCE THE RISK OF FIRE OR ELECTRIC SHOCK, DO NOT EXPOSE THIS APPARATUS TO RAIN OR MOISTURE. APPARATUS SHALL NOT BE EXPOSED TO DRIPPING OR SPLASHING AND NO OBJECTS FILLED WITH LIQUIDS, SUCH AS VASES, SHALL BE PLACED ON THE APPARATUS.

	CAUTION RISK OF ELECTRIC SHOCK DO NOT OPEN	
CAUTION: TO REDUCE THE RISK OF ELECTRIC SHOCK, DO NOT REMOVE COVER (OR BACK). NO USER SERVICEABLE PARTS INSIDE. REFER SERVICING TO QUALIFIED SERVICE PERSONNEL.		

	The lightning flash with arrowhead symbol, within an equilateral triangle, is intended to alert the user to the presence of uninsulated "dangerous voltage" within the apparatus's enclosure that may be of sufficient magnitude to constitute a risk of electric shock to persons.
	The exclamation point within an equilateral triangle is intended to alert the user to the presence of important operating and maintenance (servicing) instructions in the literature accompanying the apparatus.

The caution marking is located on the rear or bottom of the cabinet.

Important Safety Instructions

1. Read these instructions.
2. Keep these instructions.
3. Heed all warnings.
4. Follow all instructions.
5. Do not use this apparatus near water.
6. Clean only with dry cloth.
7. Do not block any ventilation openings. Install in accordance with the manufacturer's instructions.
8. Do not install near any heat sources such as radiators, heat registers, stoves, or other apparatus (including amplifiers) that produce heat.
9. Do not defeat the safety purpose of the polarized or grounding-type plug. A polarized plug has two blades with one wider than the other. A grounding type plug has two blades and a third grounding prong. The wide blade or the third prong are provided for your safety. If the provided plug does not fit into your outlet, consult an electrician for replacement of the obsolete outlet.
10. Protect the power cord from being walked on or pinched particularly at plugs, convenience receptacles, and the point where they exit from the apparatus.
11. Only use attachments/accessories specified by the manufacturer.
12. Use only with the cart, stand, tripod, bracket, or table specified by the manufacturer; or sold with the apparatus. When a cart is used,  use caution when moving the cart/apparatus combination to avoid injury from tip-over.
13. Unplug this apparatus during lightning storms or when unused for long periods of time.
14. Refer all servicing to qualified service personnel. Servicing is required when the apparatus has been damaged in any way, such as power-supply cord or plug is damaged, liquid has been spilled or objects have fallen into the apparatus, the apparatus has been exposed to rain or moisture, does not operate normally, or has been dropped.

FCC WARNING

This apparatus may generate or use radio frequency energy. Changes or modifications to this apparatus may cause harmful interference unless the modifications are expressly approved in the manual. The user could lose the authority to operate this apparatus if an unauthorized change or modification is made.

RADIO-TV INTERFERENCE

This apparatus has been tested and found to comply with the limits for a Class B digital device, pursuant to Part 15 of the FCC Rules. These limits are designed to provide reasonable protection against harmful interference in a residential installation. This apparatus generates, uses, and can radiate radio frequency energy and, if not installed and used in accordance with the instructions, may cause harmful interference to radio communications. However, there is no guarantee that interference will not occur in a particular installation. If this apparatus does cause harmful interference to radio or television reception, which can be determined by turning the apparatus off and on, the user is encouraged to try to correct the interference by one or more of the following measures:

- 1) Reorient or relocate the receiving antenna.
- 2) Increase the separation between the apparatus and receiver.
- 3) Connect the apparatus into an outlet on a circuit different from that to which the receiver is connected.
- 4) Consult the dealer or an experienced radio/TV technician for help.

DECLARATION OF CONFORMITY

Trade Name: Emerson
Model: LC407EM1

Responsible Party: FUNAI CORPORATION, Inc.
Address: 19900 Van Ness Avenue, Torrance, CA 90501 U.S.A.
Telephone Number: 1-866-309-8819

This Class B digital apparatus complies with Canadian ICES-003. Standard Television Receiving Apparatus, Canada BETS-7/NTMR-7

CAUTION: Danger of explosion if battery is incorrectly replaced. Replace only with the same or equivalent type.

WARNING: Batteries (battery pack or battery installed) shall not be exposed to excessive heat such as sunshine, fire or the like.

Disconnect the mains plug to shut off when find trouble or not in use. The mains plug shall remain readily operable.

This apparatus should not be placed in a built-in installation such as a bookcase or rack unless proper ventilation is provided. Make sure to leave a space of 4 inches (10cm) or more around this apparatus.

WARNING: To prevent injury, this apparatus must be securely attached to the wall in accordance with the instructions.

(Hg) LAMP IN LCD CONTAINS MERCURY, DISPOSE ACCORDING TO LOCAL, STATE OR FEDERAL LAW.

Do not place the unit on the furniture that is capable of being tilted by a child and an adult leaning, pulling, standing or climbing on it. A falling unit can cause serious injury or even death.

NOTE ABOUT RECYCLING

- This unit's packaging materials are recyclable and can be reused. Please dispose of any materials in accordance with your local recycling regulations.
- Batteries should never be thrown away or incinerated but disposed of in accordance with your local regulations concerning chemical wastes.

**Trademark Information**

HDMI
HIGH-DEFINITION MULTIMEDIA INTERFACE

- HDMI, the HDMI Logo, and High-Definition Multimedia Interface are trademarks or registered trademarks of HDMI Licensing LLC in the United States and other countries.

DOLBY
DIGITAL

- Manufactured under license from Dolby Laboratories. Dolby and the double-D symbol are trademarks of Dolby Laboratories.



- ENERGY STAR® is a joint program of the U.S. Environmental Protection Agency and the U.S. Department of Energy helping us all save money and protect the environment through energy efficient products and practices.

Consumer Notice:

This TV has been set to maximize energy efficiency while delivering the best possible picture using the factory installed home mode settings.

Changing or enabling other features in this TV (e.g. brightened backlighting) will possibly increase energy consumption beyond the original ENERGY STAR® qualified limits.

- The American Academy of Pediatrics discourages television viewing for children younger than two years of age.

WHEN CARRYING THIS UNIT

- At least 2 people are required when carrying this unit.
- Make sure to hold the upper and bottom frames of the unit firmly as illustrated.

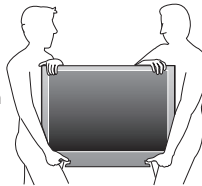
**TO AVOID THE HAZARDS OF ELECTRICAL SHOCK AND FIRE**

- Do not handle the AC power cord with wet hands.
- Do not pull on the AC power cord when disconnecting it from an AC outlet. Grasp it by the plug.
- Do not put your fingers or objects into the unit.

LOCATION AND HANDLING

- Do not install the unit in direct sunlight or in a place subject to dust or strong vibration.
- Avoid a place with drastic temperature changes.
- Install the unit in a horizontal and stable position. Do not place anything directly on top or bottom of the unit. Depending on your external devices, noise or disturbance of the picture and/or sound may be generated if the unit is placed too close to them. In this case, please ensure enough space between the external devices and the unit.
- Depending on the environment, the temperature of this unit may increase slightly. This is not a malfunction.
- Be sure to unplug the AC power cord from the AC outlet before carrying the unit.

INTRODUCTION

Contents

Important Safety Instructions	2
Trademark Information	3
INTRODUCTION	
Features	4
Supplied Accessories	5
Symbols Used in this Manual	5
Attaching the Base	5
Fixing the Unit on Your Furniture	5
Control Panel	6
Terminals	7
Remote Control Function	8
Installing the Batteries	8
PREPARATION	
Antenna Connection	9
Connection to Cable Receiver or Satellite Box	9
External Device Connection	10
Cable Management	14
Plug In the AC Power Cord	14
Initial Setup	15
WATCHING TV	
Freeze Mode	16
Sleep Timer	16
Sound Functions	16
Switching Each Input Mode	17
TV Screen Display Mode	17
Channel Selection	17
TV Screen Information	18
Reducing the Brightness	18
Fun-Link Options	18
OPTIONAL SETTING	
Main Menu	19
Autoprogram	19
Channel List	20
Add Channels	20
Antenna Confirmation	21
Language Selection	21
Picture Adjustment	22
Sound Adjustment	22
Closed Caption	24
Child Lock	27
Fun-Link	29
Energy Saving Mode	30
Location	30
Current Software Info	30
TROUBLESHOOTING	
FAQ	31
Troubleshooting Guide	32
INFORMATION	
Glossary	34
Maintenance	34
General Specifications	35
Electrical Specification	35
Other Specifications	35
Limited Warranty	37

Features

- **DTV/TV/CATV**
You can use your remote control to select channels which are broadcast in digital format and conventional analog format. Also, cable subscribers can access their cable TV channels.
- **Information Display (ATSC only)**
You can display the title, contents and other information of the current DTV program on the TV screen.
- **Autoprogram**
This unit automatically scans and memorizes channels available in your area, eliminating difficult setup procedures.
- **Child Lock**
This feature allows you to block children's access to inappropriate programs.
- **Closed Caption Decoder**
Built-in closed caption decoder displays text for closed caption supported programs.
- **MTS/SAP Tuner**
Audio can be selected from the remote control.
- **Auto Standby**
If there is no input signal and no operation for 15 minutes, the unit will go to the standby mode automatically.
- **Sleep Timer**
You can set the unit to go to the standby mode after a specific amount of time.
- **Choices for On-screen Language**
Select your on-screen language:
English, Spanish or French.
- **Stereo Sound Function**
- **PLL Frequency Synthesized Tuning**
Provides free and easy channel selection and lets you tune directly to any channel using the number and decimal point "▲" buttons on the remote control.
- **Various Adjustment for Picture and Sound**
Customizes image quality suitable for your room and sets your sound preference.
- **Fun-Link via HDMI Link**
(HDMI Cable not Included)
Fun-Link allows your other HDMI link devices (such as Magnavox DVD) to be controlled by the HDMI cable connected to your TV.
- **HDMI Input**
When using HDMI1 Input, you can enjoy this unit as a PC monitor if your PC has a DVI output terminal.
- **Component Video Input**
- **S-Video Input**
- **AV Input**
- **Digital Audio Output**
- **Analog Audio Output**

© 2010 Funai Electric Co., Ltd.

All rights reserved. No part of this manual may be reproduced, copied, transmitted, disseminated, transcribed, downloaded or stored in any storage medium, in any form or for any purpose without the express prior written consent of Funai. Furthermore, any unauthorized commercial distribution of this manual or any revision hereto is strictly prohibited. Information in this document is subject to change without notice. Funai reserves the right to change the content herein without the obligation to notify any person or organization of such changes.

FUNAI with the  design is a registered trademark of Funai Electric Co., Ltd. and may not be used in any way without the express written consent of Funai. All other trademarks used herein remain the exclusive property of their respective owners. Nothing contained in this manual should be construed as granting, by implication or otherwise, any license or right to use any of the trademarks displayed herein. Misuse of any trademarks or any other content in this manual is strictly prohibited. Funai shall aggressively enforce its intellectual property rights to the fullest extent of the law.

Supplied Accessories

Owner's Manual
(1EMN27419)



Quick Start Guide
(1EMN27420)



Remote Control
(NH200UD)



Registration card
(1EMN27139)



AC power cord
(WAV0162LW001) or
(WAV0162LTE03) or
(WAV152ZHN001)



Batteries
(AAA, 1.5V x 2)



Screw kit
for attaching the base
(1ESA23096)



- If you need to replace these accessories, please refer to the part No. with the illustrations and call our toll free customer support line found on the cover of this manual.

Note

- If you lose the screws, please purchase M5×12 Phillips head screws at your local store.

Attaching the Base

You must attach the base to the unit to have it as a table top unit. Be sure the front and rear of the base match the proper direction.

- Spread a thick and soft cloth over a table as shown. Place the main unit face up onto it. Make sure not to damage the screen. At least 2 people are required for this step.
- Insert 2 hooks under the bottom of the main unit into base holes. (shown by arrow ①), then move the base in the direction as shown by arrow ② until it stops and the 6 mounting holes are aligned.
- Drive Phillips head screws into the 6 threaded holes at the bottom of the base until they are tight.

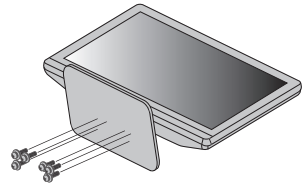
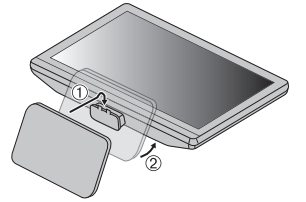
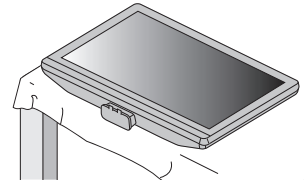

To remove the base from this unit

- Unscrew the Phillips head screws on step 3. After the screws are removed, move the base in the opposite direction as shown by arrow ② on step 2, then pull the base up toward the front of the unit. Be careful not to drop the base when you remove it.

Note

- When attaching the base, ensure that all screws are tightly fastened. If the base is not properly attached, it could cause the unit to fall, resulting in injuries as well as damage to the unit.
- Make sure to use a table which can support the weight of this unit and is larger than this unit.
- Make sure the table is in a stable location.
- When attaching the base, ensure that FRONT ↑ written on the base is upward. If it's not upward, the 2 hooks don't fit in the base.

Fixing the Unit on Your Furniture

Screw this unit on your furniture tightly using wood screws (not supplied) in the 2 holes at the back of the base as shown.

- Recommended screw dimension : 5.1 x 20 mm

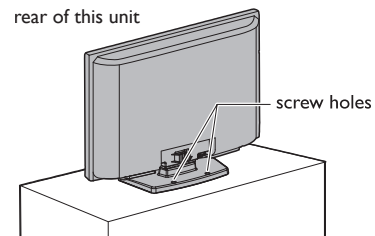

Note

- When you remove this unit make sure to unscrew the wood screws from your Wood Stand, Furniture and other wood item.

Symbols Used in this Manual

The following is the description for the symbols used in this manual. Description refers to:

ATSC : Digital TV operation

NTSC : Analog/Cable TV operation

- If neither symbol appears, the operation is applicable to both.

Control Panel

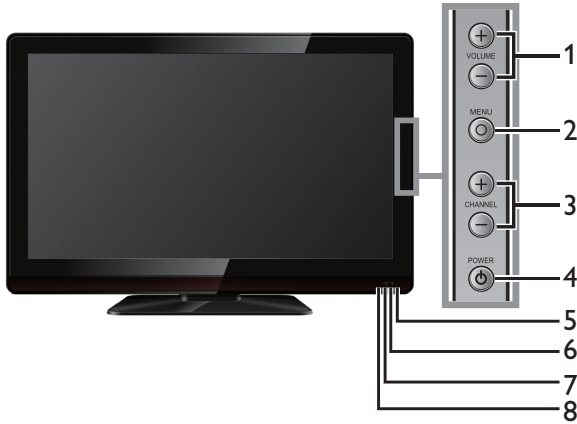

- 1 VOLUME +/-** ➡ p.16
Press to adjust the volume or move right (+)/left (-) through the main menu items.
- 2 MENU** ➡ p.19
- 3 CHANNEL +/-** ➡ p.17
Press to select channels or move up (+)/down (-) through the main menu items.
- 4 POWER** ➡ p.15
Press to turn the unit on and go to the standby mode. To completely turn off the unit, you must unplug the AC power cord.
- 5 Infrared sensor window**
Receives infrared rays transmitted from the remote control.
- 6 POWER indicator**
Lights up green when power is on.
- 7 STAND BY indicator**
Lights up red when the unit goes to standby mode.
- 8 Illuminance sensor window**
Alters the brightness of the TV screen automatically by detecting your room lighting level. Do not block anything in front of its window to work properly.

Terminals

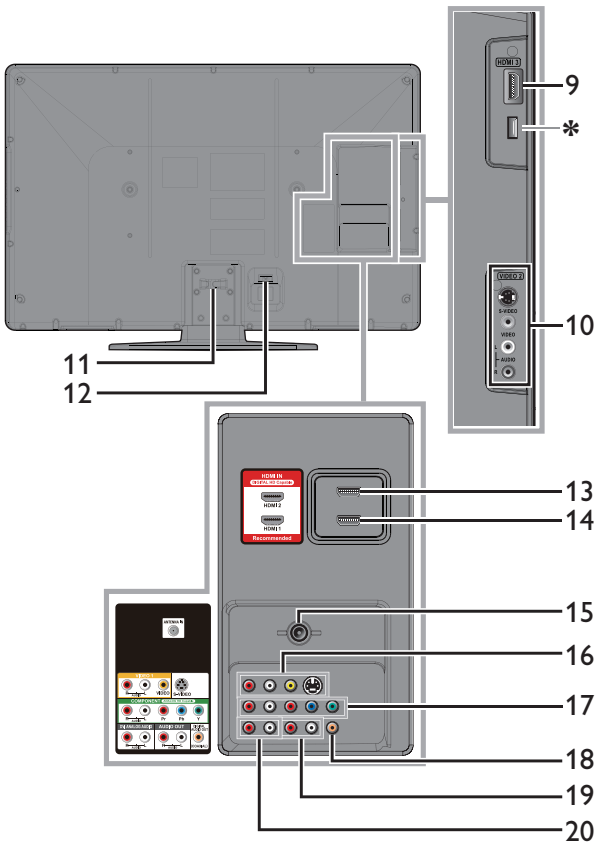

Side Panel

- 9 HDMI 3 Input jack ➡ p.9, 10
- 10 S-Video/Composite Video/Audio (L/R) Input jacks for VIDEO 2 ➡ p.11, 12

Rear Panel

- 11 Cable management ➡ p.14
- 12 AC power cord Inlet ➡ p.14
- 13 HDMI 2 Input jack ➡ p.9, 10
- 14 HDMI 1 Input jack ➡ p.9, 10, 13
HDMI connection for HDMI or DVI device.
When you connect your PC that has a DVI terminal, you can enjoy this unit as a PC monitor.
- 15 Antenna Input jack ➡ p.9
- 16 S-Video/Composite Video/Audio (L/R) Input jacks for VIDEO 1 ➡ p.11, 12
- 17 Component Video and Audio (L/R) Input jacks ➡ p.9, 11
- 18 Digital Audio Output jack ➡ p.12
- 19 Analog Audio (L/R) Output jacks ➡ p.12
- 20 Analog Audio (L/R) Input jacks for HDMI 1 ➡ p.10, 13
Audio cable connection from a DVI device.
When you connect your PC that has a DVI terminal, use a stereo mini plug conversion cable as well.
(For **HDMI 1** Input jack only)

Note for service terminal

* service terminal (service use only)

- Use this terminal only when a software update is necessary.
- User should not connect any devices to the service terminal such as digital camera, keyboard, mouse, etc. (because these will not work).
- The software update is, in most cases, handled by an authorized service person or in some circumstances the user may be asked to do the software update themselves.

Remote Control Function

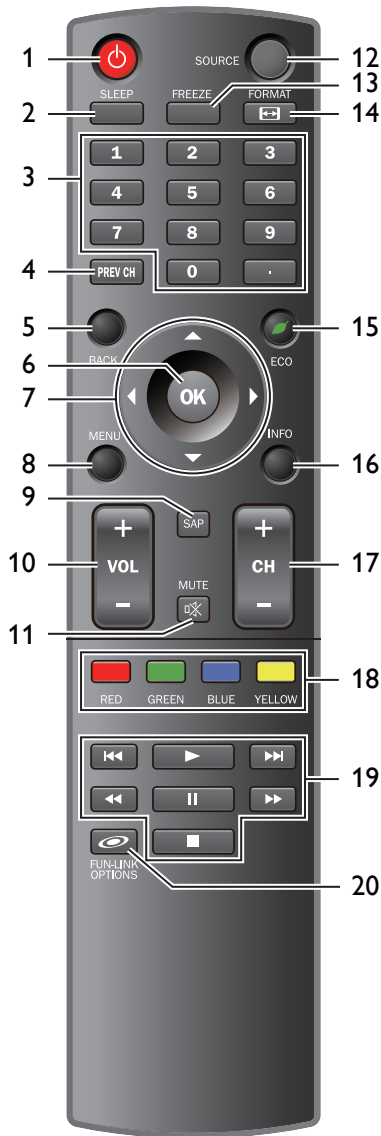

When using a universal remote control to operate this unit.



































- Make sure the component code on your universal remote control is set to our brand. Refer to the manual accompanying your remote control for more details.
- We do not guarantee 100% interoperability with all universal remote controls.

Note

- Buttons in gray background () are not available unless you are connected to devices that are compatible with Fun-Link function.
- We do not guarantee 100% interoperability with other brands of HDMI link compliant devices.

Battery Precautions:

- Be sure to follow the correct polarity as indicated in the battery compartment. Reversed batteries may cause damage to the device.
- Do not mix different types of batteries together (e.g. Alkaline and Carbon-Zinc, or rechargeable batteries like ni-cad, ni-mh, etc) or old batteries with fresh ones.
- If the device is not to be used for a long period of time, remove the batteries to prevent damage or injury from possible battery leakage.
- Do not try to recharge batteries; they can overheat and rupture.

- 1**  (power)  p.15
Press to turn the unit on and go to the standby mode.
To completely turn off the unit, you must unplug the AC power cord.
 - 2** SLEEP  p.16
 - 3** Number buttons  p.17
 - (dot)
Press to shift the subchannel from the main channel.
 - 4** PREV CH  p.17
Press to return to previously viewed channel.
 - 5** BACK  p.18
Press to return to the previous menu operation.
 - 6** OK  p.15
 - 7**  (cursor)  p.15
 - 8** MENU  p.19
 - 9** SAP  p.16
 - 10** VOL +/-  p.16
 - 11** MUTE   p.16
 - 12** SOURCE  p.17
 - 13** FREEZE  p.16
Press to freeze screen image.
 - 14** FORMAT   p.17
Press to select aspect ratio available for the TV screen.
 - 15**  ECO  p.18
Press to reduce the brightness.
 - 16** INFO  p.18
 - 17** CH +/-  p.17
- 18** RED / GREEN / BLUE / YELLOW  p.29
Functionally useful for Fun-Link.
 - 19**   p.29
Press to skip backward or forward chapters, titles or tracks of the disc.
 -   p.29
Press to begin the disc playback.
 -   p.29
Press to search backward or forward through the disc.
 -   p.29
Press to pause the disc playback.
 -   p.29
Press to stop the disc playback.
 - 20**  FUN-LINK OPTIONS  p.18, 29
Press to call up various menu from your Fun-Link device connected through an HDMI cable.

Installing the Batteries

Install the batteries (AAA, 1.5V x 2) matching the polarity indicated inside battery compartment of the remote control.

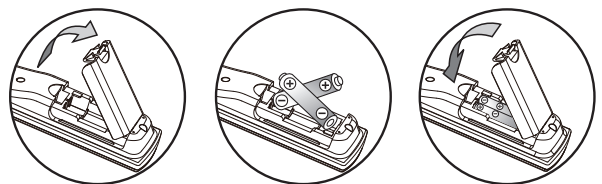

PREPARATION

No supplied cables are used with these connections:

Please purchase the necessary cables at your local store. Use an HDMI cable with the HDMI logo (a certified HDMI cable). High Speed HDMI cable (also known as HDMI category 2 cable) is recommended for the better compatibility.

Before you connect:

Be sure your antenna or other device is connected properly before plugging in the AC power cord.

Antenna Connection

Connect the RF coaxial cable on your home outlet to the antenna input jack of this unit.

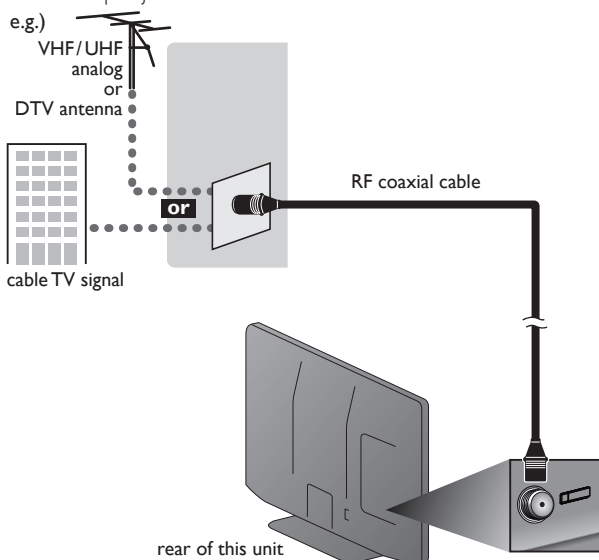

Once connections are completed, turn on the unit and begin initial setup. Channel scanning is necessary for the unit to memorize all available channels in your area. **[Initial Setup]** ➔ p.15

Note

- If you have any question about the DTV's antenna, visit www.antennaweb.org for further information.
- Depending on your antenna system, you may need different types of combiners (mixers) or separators (splitters). Contact your local electronics store for these items.
- For your safety and to avoid damage to this unit, please unplug the RF coaxial cable from the antenna input jack before moving the unit.
- If you use an antenna to receive analog TV, it should also work for DTV reception. Outdoor or attic antennas will be more effective than a set top or inside antenna.
- To switch your reception source easily between antenna and cable, install an antenna selector.
- If you are not receiving a signal from your cable service, contact the Cable provider.

Connection to Cable Receiver or Satellite Box

Use an HDMI or component video cables to connect the HDMI or the Component Video Input jacks of the unit to the HDMI or the component video output jacks of the cable receiver/satellite box.

If you connect to the unit's Component Video Input jacks, connect audio cables to the Audio L/R Input jacks right beside the Component Video connector:

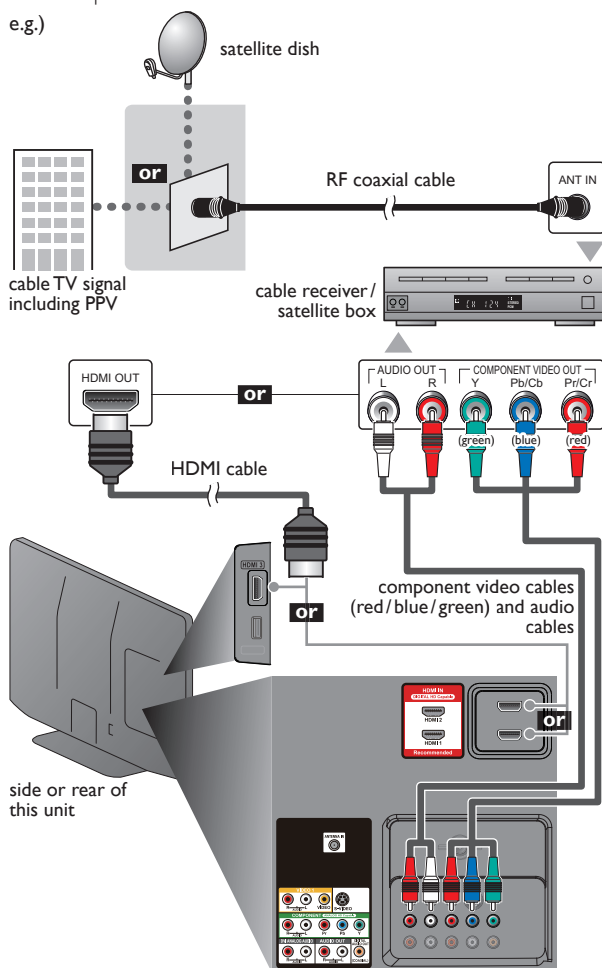

You can also connect this unit to the cable receiver or satellite box other than the HDMI or the component video output jacks because they might have different output jacks.

Required cables and connecting methods of the cable receiver/satellite box, or the availability channel for the clear QAM may differ depending on the cable/satellite provider. For more information, please contact your cable/satellite provider.

External Device Connection

HDMI Connection

HDMI connection offers the highest picture quality. HDMI (High-Definition Multimedia Interface) transports high definition video and multi-channel digital audio through a single cable. e.g.)

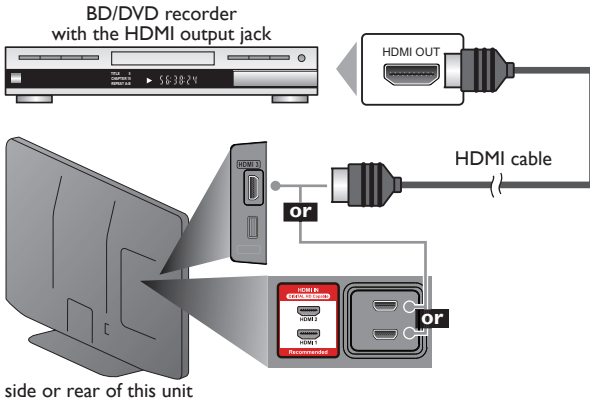

HDMI-DVI Connection

Use an HDMI-DVI conversion cable to connect the unit to external video devices equipped with DVI output jack.

e.g.)

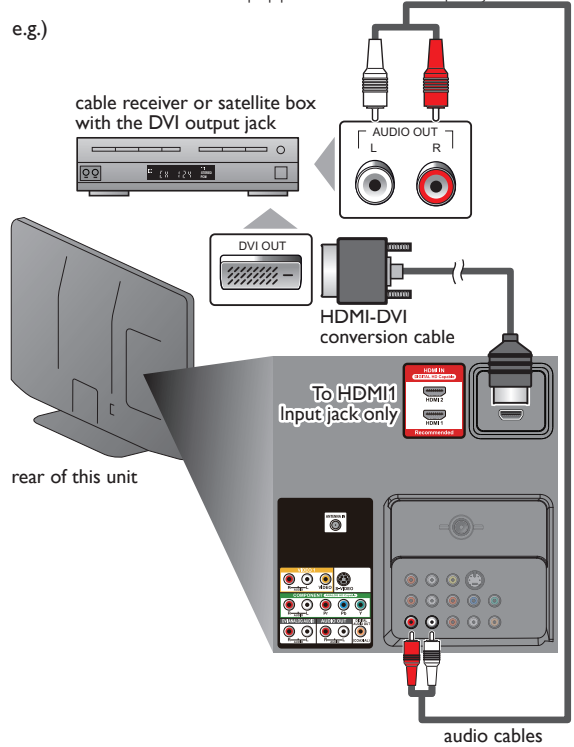

Note

For HDMI connection

- The unit accepts 480i, 480p, 720p, 1080i and 1080p 24/30/60Hz of video signals, and 32kHz, 44.1kHz and 48kHz of audio signals.
- This unit accepts only 2 channel audio signal (LPCM).
- You need to select "PCM" for the digital audio of the device you connected or check the HDMI audio setting. There may be no audio output if you select "Bitstream", etc.
- This unit accepts only signals in compliance with EIA861.

For HDMI-DVI connection

- The unit accepts 480i, 480p, 720p, 1080i and 1080p video signals.
- HDMI-DVI connection requires separate audio connections as well and the audio signals are converted from digital to analog.
- DVI does not display 480i image which is not in compliance with EIA/CEA-861/861B.

Component Video Connection

Component Video connection offers better picture quality for video devices connected to the unit.

If you connect to the unit's Component Video Input jacks, connect audio cables to the Audio L/R Input jacks right beside the Component Video connector.

e.g.)

BD/DVD recorder with the component video output jack

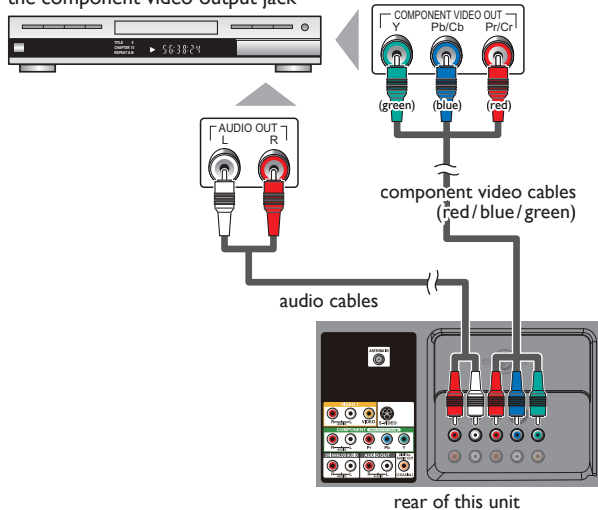

Note

- The unit accepts 480i/480p/720p and 1080i of video signals for this connection.

S-Video Connection

S-Video connection offers good picture quality for video devices connected to the unit. If you connect to the unit's S-Video Input jack, connect audio cables to the Audio L/R Input jacks right beside the Composite Video connector.

e.g.)

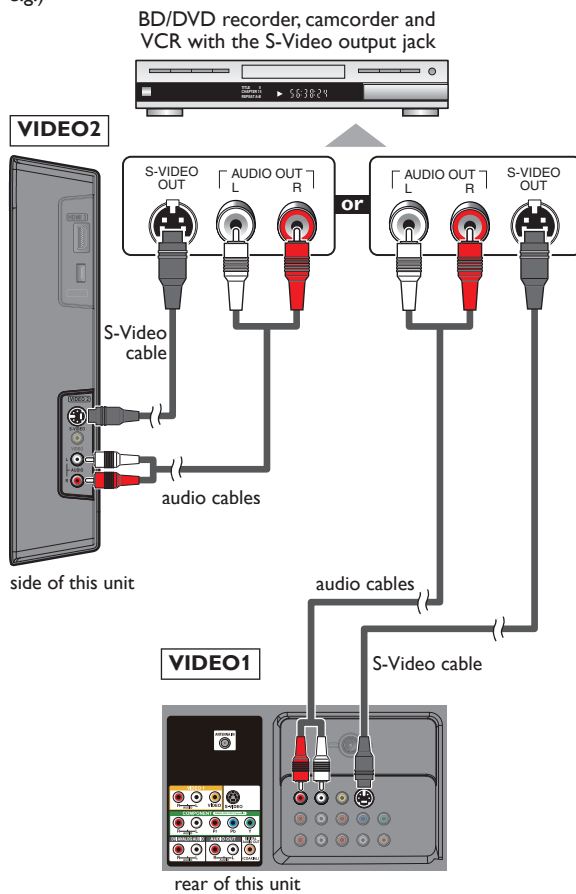

Composite Video Connection

Composite Video connection offers standard picture quality for video devices connected to the unit. If you connect to the unit's Composite Video Input jack, connect audio cables to the Audio L/R Input jacks right beside the Composite Video connector. When the audio jack of the video device is monaural, connect an audio cable to the Audio L Input jack.

e.g.)

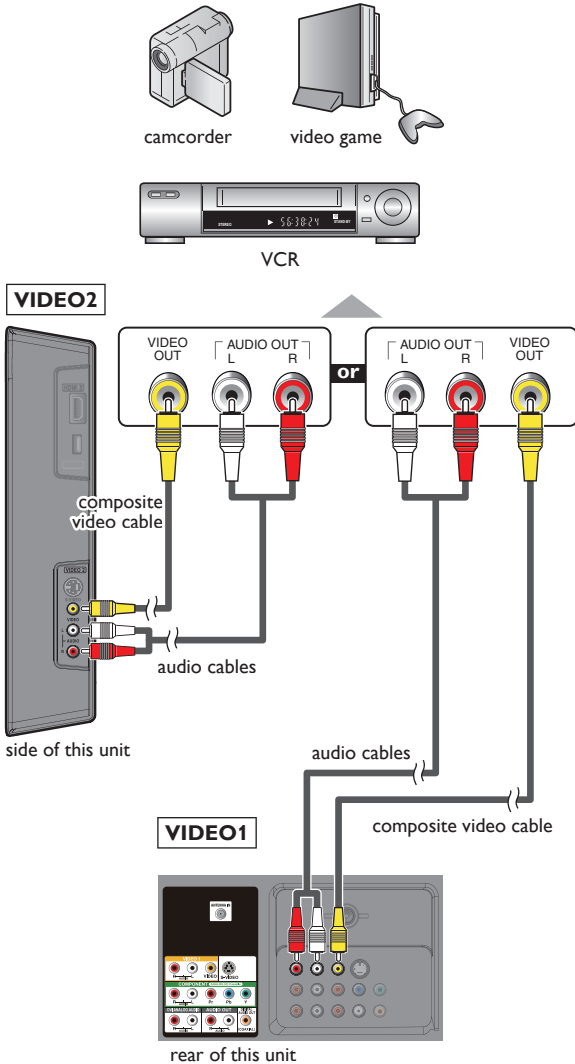

Note

- If you connect to the S-Video Input jack and the Composite Video Input jack at the same time, the S-Video connection will have priority.

Audio Output Connection

* Digital (for digital broadcasting only)

If you connect this unit to an external digital audio device, you can enjoy multi-channel audio like 5.1ch digital broadcasting sound.

Use a digital audio coaxial cable to connect the unit to external digital audio devices.

* Analog (for both analog and digital broadcasting)

If you connect this unit to an external analog audio device, you can enjoy stereo (2-channel) audio.

Use audio cables to connect the unit to external analog audio devices.

e.g.)

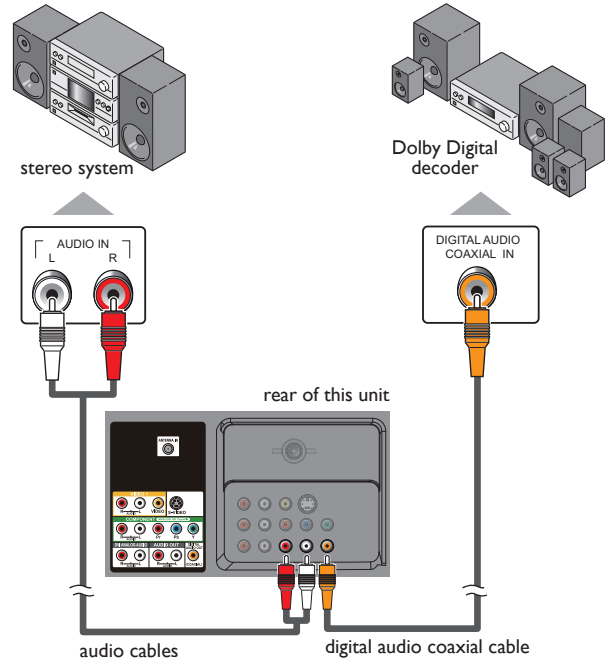

PC Connection

This unit can be connected to your PC that has a DVI terminal. Use an HDMI-DVI conversion cable for this connection and it requires stereo mini plug conversion cables as well. If you connect this unit to your PC, you can use this unit as a PC monitor:

e.g.)

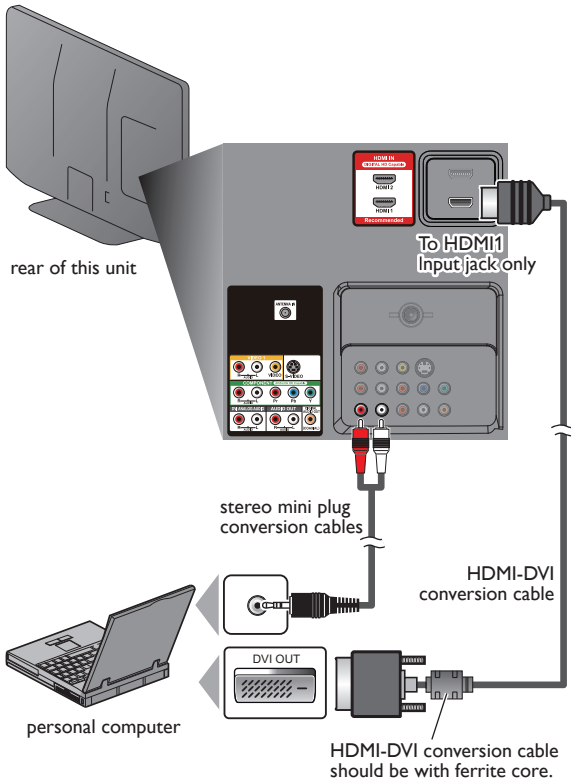

The following video signals can be displayed:

Format	Resolution	Refresh rate
VGA	640 × 480	60Hz
SVGA	800 × 600	
XGA	1,024 × 768	
WXGA	1,280 × 768	
	1,360 × 768	
FHD	1,920 × 1,080	

Other formats or non-standard signals will not be displayed correctly.

Note

- Please purchase the HDMI-DVI conversion cable that has a ferrite core.
- The following operations may reduce noise.
 - Attach a ferrite core to the AC power cord of your PC.
 - Unplug the AC power cord and use the built-in battery of your PC.

Cable Management

Keep the cables through this holder to avoid tangling them.

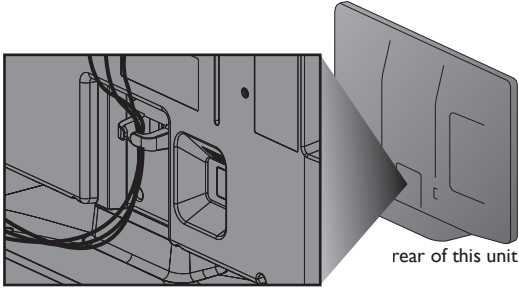

Use the following accessory with this connection:

- AC power cord x 1

Plug In the AC Power Cord

Make sure that the AC power cord must be plugged to an AC outlet after all the necessary connections are completed.

rear of this unit

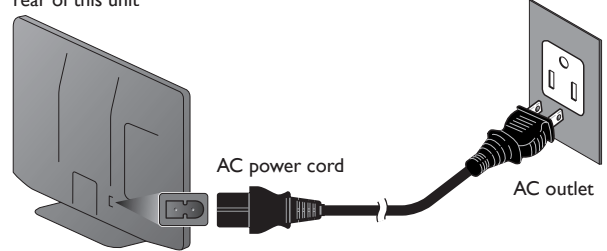

Caution:

- Do not connect the AC power cord to a power supply outside the indicated voltage of this unit (AC 120V). Connecting the AC power cord to a power supply outside of this range may result in fire or electrical shocks.

Note

- Each time you plug in the AC power cord, no operations will be performed for a few seconds. This is not a malfunction.

*These operations are accessible by remote control.
Some may also be accessible by controls on the main unit.*

- 4 Use ◀/▶ to select the desired location setting, then press **OK**.

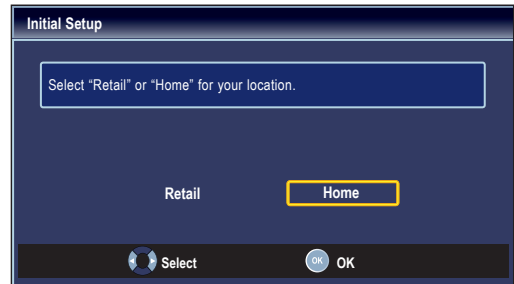

- Select **[Retail]** store, the unit will be set up with predefined setting for retail displays. In this setting, the power consumption may possibly exceed the limited requirement of the ENERGY STAR® qualification.
- Select **[Home]**, the unit is set to maximize the energy efficiency for home setting and it can be adjusted through a choice of picture and sound quality according to your preference.
- When the initial setup is completed, the lowest memorized channel with the confirmation message of the location setting will be displayed on the TV screen.

Initial Setup

This section will guide you through the unit's initial setting which includes selecting a language for your on-screen menu and autoprogram, which automatically scans and memorizes viewable channels.

Before you begin:

Make sure the unit is connected to antenna or cable.

- 1 After making all the necessary connections, press **⏻** to turn on the unit.
 - It may take a few moments to turn on the unit for the first time.
 - **[Initial Setup]** menu appears automatically after the unit is turned on.
- 2 Use ▲/▼ to select the on-screen language from the choices (English/Español/Français) on the right side of the TV screen.
- 3 Use ▲/▼ to select **[Antenna]** for TV channels or **[Cable]** for CATV channels, then press **OK**.

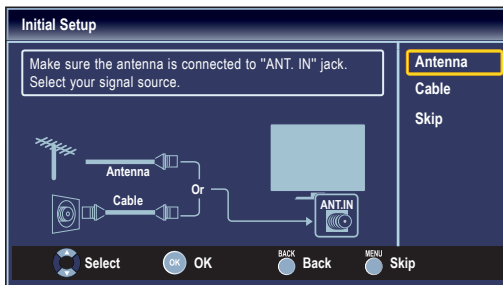

- **[Autoprogram]** will begin.

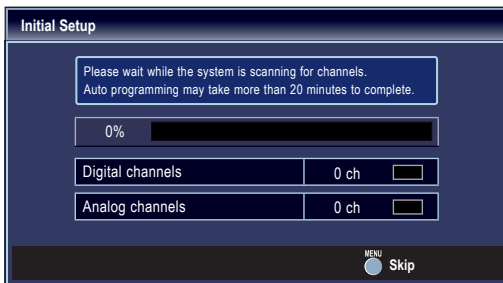

Note

- If you are not receiving a signal from your cable service, contact the Cable provider.
- If you press **⏻** or **MENU** during autoprogram, this setting will be canceled.
- The initial autoprogram function can be executed for either **[Antenna]** or **[Cable]** only once. When you change the connection (Antenna/Cable), set **[Autoprogram]** again. ➡ p.19
- If there is no signal input from the antenna terminal and no operation for several seconds after you turn on the unit, **[Helpful Hints]** appears. Follow the instructions listed on the TV screen.

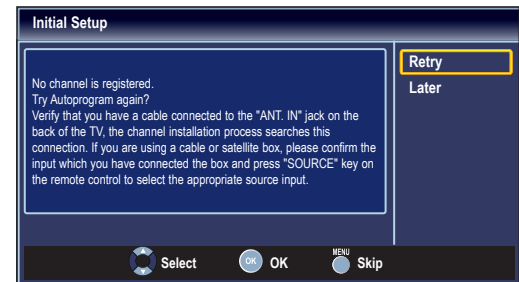

- You must set **[Home]** in step 4. Otherwise, **[Picture]** and **[Sound]** settings you adjusted will not be memorized after the unit goes to the standby mode.

After an initial setup is completed...

- If you want to scan the channels automatically again. **[Autoprogram]** ➡ p.19
- You can add the desired cable and analog channels unmemorized by autoprogram. **[Add Channels]** ➡ p.20
- If you want to change to another language. **[Language Selection]** ➡ p.21
- If you want to change the location setting. **[Location]** ➡ p.30

WATCHING TV

Freeze Mode can freeze the image shown on the TV screen for 5 minutes.

Press **FREEZE** to freeze the image.



- The sound output will not be paused.
- To cancel freeze mode, press any buttons except **OFF**.

Sleep Timer

can be set the unit to go to the standby mode after an incremental period of time.

Press **SLEEP** repeatedly to change the amount of time (increases the time by 30 minutes up to 120 minutes).



Press **SLEEP** once to call up the display for checking the remaining time.

- To cancel sleep timer, press **SLEEP** repeatedly until **[Sleep Off]** is displayed.



Sound Functions

describe how to change the audio or the audio language as well as the volume.

Volume Adjustment

Use **VOL +/-** to adjust the volume.



Volume 30 will be displayed for a few seconds when adjusting the volume.



Silence Mode

Press **MUTE** to turn off the sound temporarily.

Mute will be displayed for a few seconds.

- Press **MUTE** again or **VOL +/-** to recover the original volume.



Switching Audio Mode

ATSC

Press **SAP** repeatedly to cycle through the available audio languages.

- Available languages differ depending on the broadcast.
- **[Other]** is displayed when the audio language cannot be acquired, or the acquired languages are other than English, Spanish or French.



NTSC

Press **SAP** to display the currently selected audio mode.

While receiving an MTS broadcast, press repeatedly to cycle through the available audio channel.



e.g.) When all audio are available



STEREO : Outputs stereo-audio

SAP : Outputs second audio program

MONO : Outputs mono-audio



Switching Each Input Mode

can easily switch with the remote control between TV (ATSC or NTSC) and external devices when they are connected to the unit.

Press **SOURCE** or **CH +** repeatedly to cycle through the input modes.



- Pressing **CH -** reverses the direction of the input modes.

TV Screen Display Mode

5 types of display modes can be selected when the broadcasting station is sending 16:9 or 4:3 video signal. And 3 types of display modes can be selected for PC input signal.

Press **FORMAT** repeatedly to switch the TV aspect ratio.

For 16:9 video signal

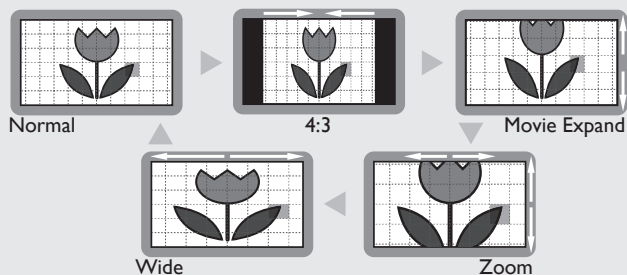

Normal displays a 16:9 picture at its original size.

4:3 displays a 16:9 picture at a 4:3 size; the picture is shortened horizontally. Sidebars appear on both edges of the screen.

Movie Expand displays a 16:9 picture that is vertically stretched to fill the screen. This only crops out the top of the picture.

Zoom displays a 16:9 picture at its maximum size without changing its horizontal and vertical ratio.

Wide displays a horizontally stretched picture. This crops out the left and right sides of the picture.

For 4:3 video signal

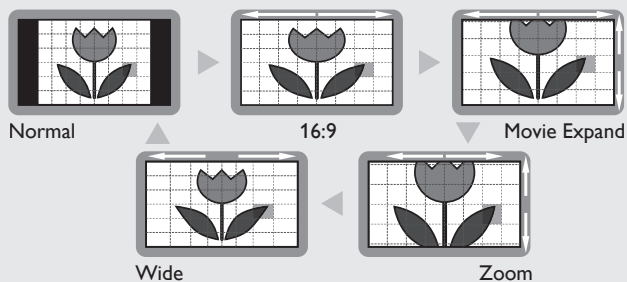

Normal displays a 4:3 picture at its original size. Sidebars appear on both edges of the screen.

16:9 displays a 4:3 picture at a 16:9 size; the picture is stretched horizontally to fill the screen.

Movie Expand displays a 4:3 picture at a 16:9 size; the picture is stretched more vertically at the top of the screen. This crops out the top of the picture.

Zoom displays a 4:3 picture at a 16:9 size; at its maximum size that is more vertically stretched to fill the screen. This crops out the top and bottom of the picture.

Wide displays the picture with its center at the original size and the edges stretched horizontally to fill the screen.

For PC input signal through HDMI1 Input mode

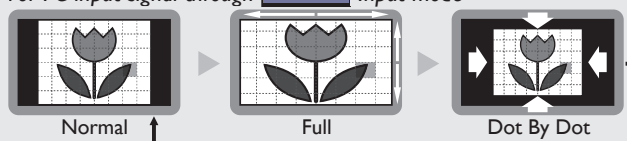

Normal displays a proportionately stretched picture. Sidebars appear on both edges of the screen.

Full displays a picture that is stretched out of proportion horizontally to fill the screen.

Dot By Dot displays a picture in its original size.

Channel Selection

Select channels by using **CH +/-** or the **Number** buttons.

- To select the memorized channels, use **CH +/-** or the **Number** buttons.
- To select the non-memorized channels, use the **Number** buttons.

11.1

To use **the Number buttons**

ATSC

- When selecting digital channel 11.1
Be sure to press **.** before entering the subchannel number.



NTSC

- When selecting cable or analog channel 11



Press **PREV CH** to return to the previously viewed channel.

Note

- [No Signal]** will appear on the TV screen after the subchannel broadcast is over.
- [Audio only program]** message will appear on the TV screen, when you receive only sound signal.

TV Screen Information

You can display the currently selected channel or other information such as the audio mode on the TV screen. In the digital mode, the detailed broadcasting information for the current channel such as program title, program guides are displayed.

Press **INFO**.

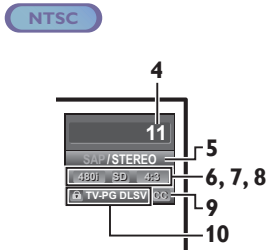
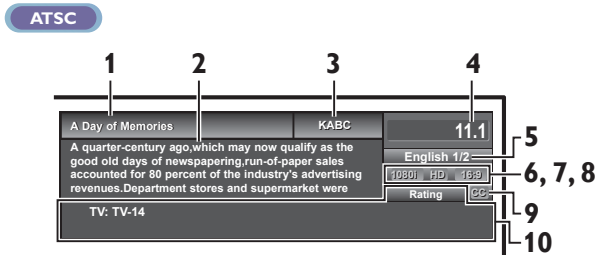

- 1 program title
- 2 program guide
(The program guide added to broadcasting information is displayed to a maximum of 4 lines.)
- 3 broadcast station
- 4 channel number
- 5 audio language (ATSC)/audio mode (NTSC)
[Switching Audio Mode] **▶▶▶** p.16
- 6 effective scanning lines and scan mode
- 7 TV format
- 8 program aspect ratio
- 9 CC (not available if closed caption is set to [Off])
- 10 child lock rating

- To clear the display, press **INFO** again. You can also press **BACK**.

Note

- When the program guide consists of more than 4 lines, use **▲/▼** to scroll.
- [No description provided.] is displayed when the program guide is not provided.
- While the program guide is displayed, the closed caption function is interrupted.
- In external input mode, the following screen is displayed; e.g.) When an external device is connected to Video1 Input jack.



- The information display will automatically disappear in 1 minute.

Reducing the Brightness

Backlight brightness can be reduced which may save on power consumption more than you just set [On] in [Energy Saving Mode]. **▶▶▶** p.30

- Press **ECO** once to reduce the brightness.
- Press **ECO** again to increase the brightness.

Note

- Even if this function is in effect, the brightness will be increased when you change [Energy Saving Mode] on or off due to the energy saving mode has priority.
- You must set [Home] in [Location]. **▶▶▶** p.30
Otherwise, the settings you adjusted will not be memorized after the unit goes to the standby mode.

Fun-Link Options

If you have our brand products such as BD player or DVD recorder that are compatible with Fun-Link functions, connect them to this unit via an HDMI cable so you can simply operate various items from this unit's remote control.

Before you begin:

You must set [On] in [Device Control] and [Fun-Link Control]. **▶▶▶** p.29

Otherwise, **FUN-LINK OPTIONS** does not work even if you connected our brand devices to this unit.

To enjoy Fun-Link, verified and recommended devices are as follows;

MAGNAVOX

NB530MGX
NB500MG1F
MBP1100/F7

SYLVANIA

NB530SLX
NB500SL1

- 1 Press **FUN-LINK OPTIONS** to display [Fun-Link Options] menu.

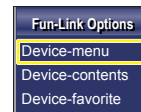

Device-menu	This function allows you to control the menu of your connected Fun-Link device.
Device-contents	This function allows you to control the top menu of your DVD or Blu-ray discs.
Device-favorite	This function allows you to control the pop-up menu of your Blu-ray discs.

- 2 Use **▲/▼/◀/▶/OK** on this unit's remote control to operate the desired functions for your devices.

Note

- Some of Fun-Link functions may not be available depending on your Fun-Link devices or discs.
- We do not guarantee 100% interoperability with other brands of HDMI link compliant devices.

OPTIONAL SETTING

Main Menu

This section describes the overview of the main menu displayed when you press **MENU**. The main menu consists of the function setting items below.

Press **MENU**.

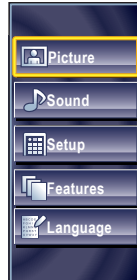

- | | | | |
|-----------------|------------------------------------------------------------------------------------------------------------------------------------------------|------|------|
| Picture | [Picture Adjustment] | ▣▣▣▣ | p.22 |
| Sound | [Sound Adjustment] | ▣▣▣▣ | p.22 |
| Setup | [Autoprogram] | ▣▣▣▣ | p.19 |
| | • You can automatically scan the viewable channels. | | |
| | [Channel List] | ▣▣▣▣ | p.20 |
| | • The Channels that were autoprogrammed are in this Channel list, use CH +/- to access them. | | |
| | [Add Channels] | ▣▣▣▣ | p.20 |
| | • You can add TV channels that were not found by the autoprogram scan. | | |
| Features | [Closed Caption] | ▣▣▣▣ | p.24 |
| | • You can change the display closed caption format which displays the dialogue of a TV program or other text information across the TV screen. | | |
| | [Child Lock] | ▣▣▣▣ | p.27 |
| | • You can set viewing limitations. | | |
| | [Fun-Link] | ▣▣▣▣ | p.29 |
| | • You can set Fun-Link options. | | |
| | [Energy Saving Mode] | ▣▣▣▣ | p.30 |
| | [Location] | ▣▣▣▣ | p.30 |
| | • Switch setting from [Retail] to [Home] to allow the desired [Picture] and [Sound] mode to be kept in memory. | | |
| | [Current Software Info] | ▣▣▣▣ | p.30 |
| Language | [Language Selection] | ▣▣▣▣ | p.21 |
| | • Change the Main Menu language. | | |

Autoprogram

If you switch wires (e.g. between antenna and CATV) or if you move the unit to a different area after the initial setting, or if you restore the DTV channels you deleted, it is recommended to use Autoprogram to perform a new channel search.

Before you begin:

Make sure the unit is connected to antenna or cable.

- 1 Press **MENU** to display the main menu.
- 2 Use **▲/▼** to select **[Setup]**, then press **OK**.
- 3 Use **▲/▼** to select **[Autoprogram]**, then press **OK**.
- 4 Use **▲/▼** to select an appropriate option, then press **OK**.

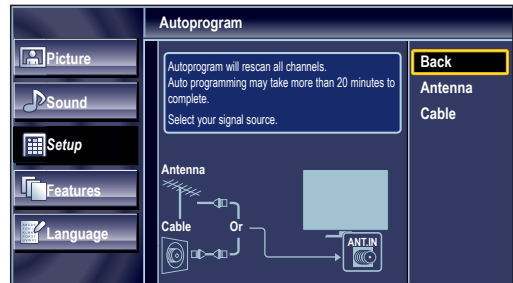

- When connected to VHF/UHF antenna, select **[Antenna]**.
- When connected to CATV, select **[Cable]**.
- **[Autoprogram]** will begin.

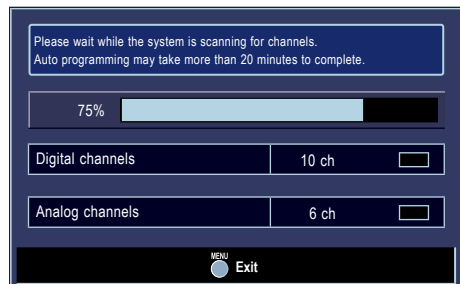

- When the scanning and memorizing are completed, the lowest memorized channel will be displayed.

Note

- After setting **[Autoprogram]**, using **CH +/-** on the remote control skips unavailable programs automatically.
- If you are not receiving a signal from your cable service, contact the Cable provider.
- If you press **⏻** or **MENU** during autoprogram, the setting will be canceled.
- Even if **[Autoprogram]** is completed, the channel setting will be lost if the AC power cord is unplugged before the unit goes to the standby mode by pressing **⏻**.
- The PIN code will be required once you set a PIN code in the **[Child Lock]**.
▣▣▣▣ p.27
- If you want to change your PIN code, follow the instruction of **[Change PIN]**. ▣▣▣▣ p.28

Channel List

The channels selected here can be skipped when selecting the channels using **CH +/-**.

Those channels can still be selected with **the Number buttons**.

- 1 Press **MENU** to display the main menu.
- 2 Use **▲/▼** to select [**Setup**], then press **OK**.
- 3 Use **▲/▼** to select [**Channel List**], then press **OK**.
- 4 Use **▲/▼** to select the channel you want to remove, then press **OK**.



- The channel display for the removed channel darkens. You will not be able to select the channel again using **CH +/-**.
- To reactivate a removed channel, use **▲/▼** and press **OK**. The registered channels are highlighted.
- When you remove a main channel, its subchannels are removed as well.

- 5 Press **MENU** to exit.

Note

- The channel with the **[DTV]** indicated on the display is ATSC. Otherwise the channel is NTSC.

Add Channels

This function lets you add the channels that were not added by the autoprogram due to reception conditions at the initial setting.

- 1 Press **MENU** to display the main menu.
- 2 Use **▲/▼** to select [**Setup**], then press **OK**.
- 3 Use **▲/▼** to select [**Add Channels**], then press **OK**.
- 4 Use **the Number buttons** to enter the number of the channel you want to add, then press **OK**.

11

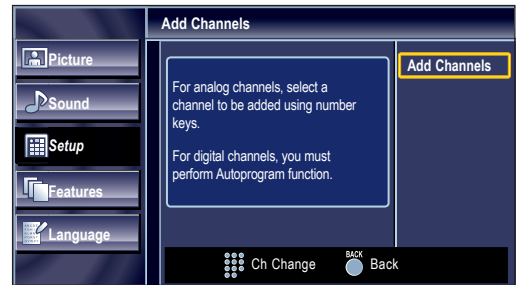

- 5 Press **MENU** to exit.

Note

- If setup completes successfully, **[Added to the channel list]** is displayed.
- If external input is used, it is not possible to register the channel and **[Unavailable]** will be displayed on the TV screen.
- By using **CH +/-**, you can select the memorized channels only.

Antenna Confirmation

ATSC

This function lets you check the digital signal strength of each channel.

- 1 Press **MENU** to display the main menu.
- 2 Use **▲/▼** to select **[Setup]**, then press **OK**.
- 3 Use **▲/▼** to select **[Antenna]**, then press **OK**.
- 4 Use the **Number buttons** or **CH +/-** to select the channel for which you want to check the digital signal strength.

11.1

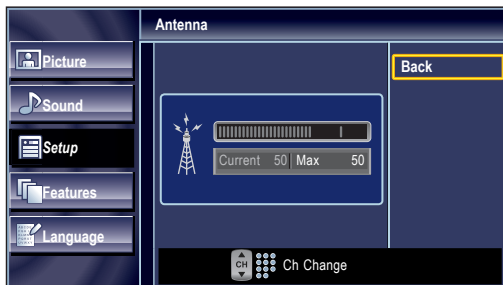

- If the channel is set to analog (cable) channel or external input, you cannot confirm the antenna condition.

Video1

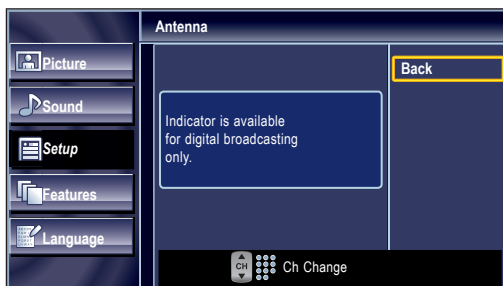

- 5 Press **MENU** to exit.

Language Selection

You can choose English, Spanish, or French as your on-screen language.

- 1 Press **MENU** to display the main menu.
- 2 Use **▲/▼** to select **[Language]**, then press **OK**.
- 3 Use **▲/▼** to select **[English]**, **[Español]** or **[Français]**, then press **OK**.



- 4 Press **MENU** to exit.

Note

- If you need the English menus instead of the Spanish or French menus, press **MENU**. Use **▲/▼** to select **[Idioma]** or **[Langue]**, then press **OK**. Use **▲/▼** to select **[English]**, then press **OK**. Press **MENU** to exit the main menu.

Picture Adjustment

You can adjust picture mode, or customize the picture quality as your preference.

Before you begin:

You must set [Home] in [Location]. ➡ p.30

Otherwise, the settings you adjusted will not be memorized after the unit goes to the standby mode.

- 1 Press **MENU** to display the main menu.
- 2 Use **▲/▼** to select [Picture], then press **OK**.
- 3 Use **▲/▼** to select the item you want to adjust, then press **OK**.

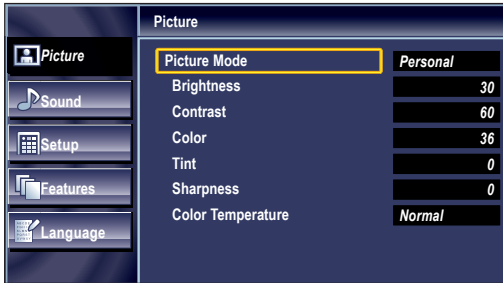

- 4 Adjust the following items.

Picture Mode

Use **▲/▼** to select the desired setting, then press **OK**. ([Personal], [Standard], [Sports], [Movie], and [Game])



Brightness, Contrast, Color, Tint, Sharpness, Color Temperature

You can only adjust the following options when you set to [Personal] in [Picture Mode]. Use **▲/▼** to select the desired setting, then use **◀/▶** to adjust.

Brightness 	Press ◀ to decrease brightness	Press ▶ to increase brightness
Contrast 	Press ◀ to decrease contrast	Press ▶ to increase contrast
Color 	Press ◀ to decrease color intensity	Press ▶ to increase color intensity
Tint 	Press ◀ to add red	Press ▶ to add green

Sharpness 	Press ◀ to soften	Press ▶ to sharpen
Color Temperature 	Press ◀ to add warm colors	Press ▶ to add cool colors

- 5 Press **MENU** to exit.

Sound Adjustment

You can adjust the sound mode, equalizer and some other sound functions.

Before you begin:

You must set [Home] in [Location]. ➡ p.30

Otherwise, the settings you adjusted will not be memorized after the unit goes to the standby mode.

- 1 Press **MENU** to display the main menu.
- 2 Use **▲/▼** to select [Sound], then press **OK**.
- 3 Use **▲/▼** to select the item you want to adjust, then press **OK**.

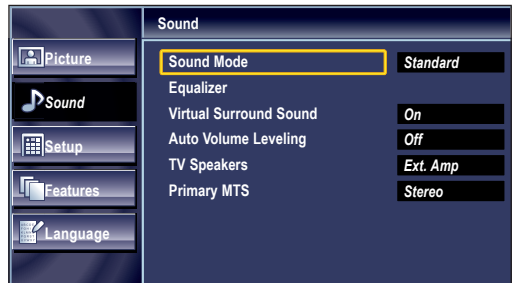

- 4 Adjust the following items.

Sound Mode

Use ▲/▼ to select the desired setting, then press OK. ([Personal], [Standard], [Movie], [Music], and [News])

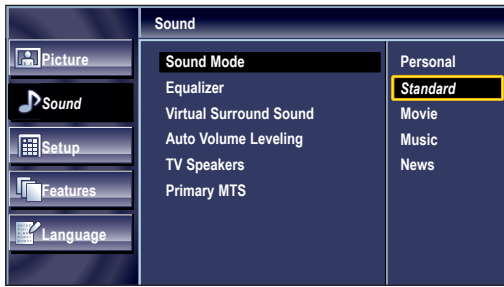

Equalizer

Adjust tonal quality for each frequencies. Use ◀/▶ to select the specific frequency and use ▲/▼ to adjust the level, then press OK.

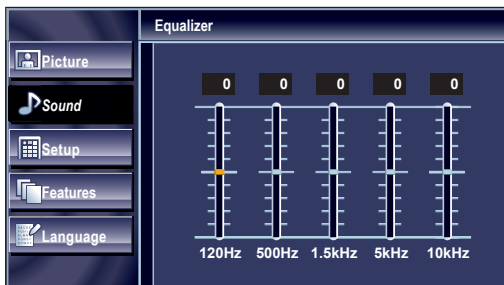

Virtual Surround Sound

Virtual surround sound gives you the stereo phonic virtual space through your existing 2-channel stereo system. Use ▲/▼ to select the desired option, then press OK.



On	Emphasized effect.
Off	Natural effect.

Auto Volume Leveling

This function keeps a constant loudness differential between the TV commercials and the programs. Use ▲/▼ to select the desired option, then press OK.

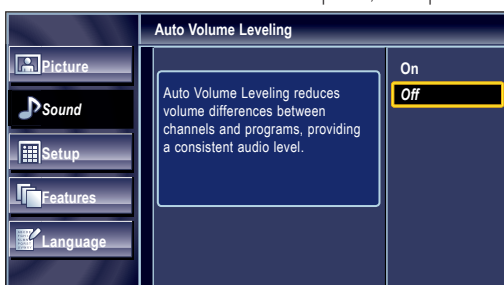

On	Reduces volume differences between the TV commercials and the programs.
Off	Removes the auto volume leveling.

TV Speakers

Select the audio output from the unit's speakers, or not. If your amplifier is HDMI link function compatible and connected by an HDMI cable to this unit, some sound operations such as volume up can be changed by using this unit's remote control. Make sure [Fun-Link Control] is set to [On]. ➡ p.29

Use ▲/▼ to select the desired option, then press OK.

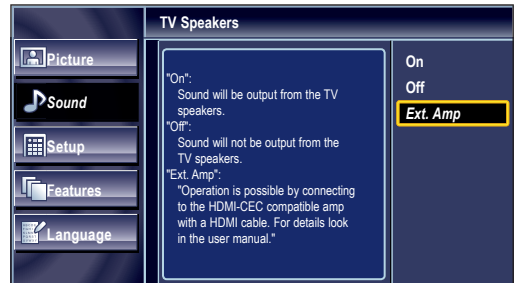

On	The sound will be output from the unit's speakers.
Off	The sound will not be output from the unit's speakers.
Ext. Amp	You can control audio output from your connected HDMI link devices by using this unit's remote control.

Note

- We do not guarantee 100% interoperability with other brands of HDMI link compliant devices.

Primary MTS

You can set the output mode as a default for the sound mode (NTSC only).

This setting is not interlocked when you change the output mode by pressing SAP. [Sound Functions] ➡ p.16

Use ▲/▼ to select the desired option, then press OK.

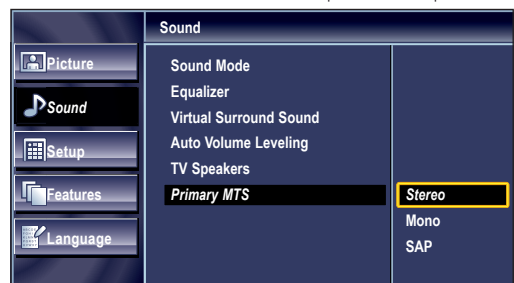

Stereo	Outputs stereo-audio.
Mono	Outputs mono-audio.
SAP	Outputs second audio program.

- 5 Press MENU to exit.

Closed Caption

You can view closed captioning (CC) for TV programs, movies and news. Closed caption refers to text of dialogue or descriptions displayed on-screen.

- 1 Press **MENU** to display the main menu.
- 2 Use **▲/▼** to select [**Features**], then press **OK**.
- 3 Use **▲/▼** to select [**Closed Caption**], then press **OK**.

See the following description for setting each item.

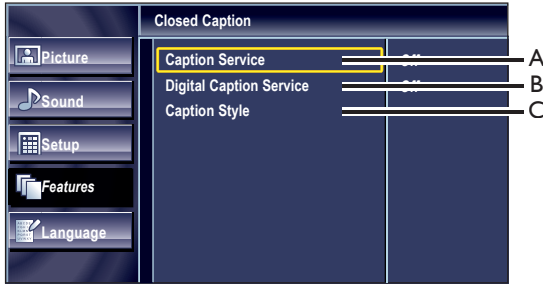

A. Caption Service

- 4 Use **▲/▼** to select [**Caption Service**], then press **OK**.
- 5 Use **▲/▼** to select the desired closed caption, then press **OK**.

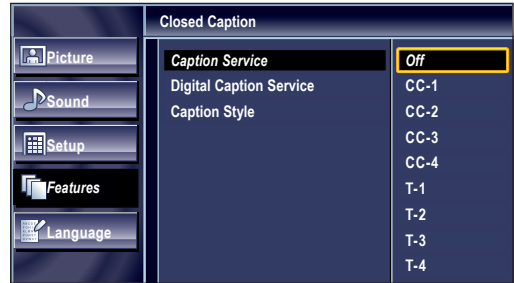

CC-1 and T-1	The primary caption and text services. The captioning or text is displayed in the same language as the program's dialogue (up to 4 lines of script on the TV screen, where it does not obstruct relevant parts of the picture).
CC-3 and T-3	Serve as the preferred data channels. The captioning or text is often a secondary language.
CC-2, CC-4, T-2 and T-4	Rarely available and broadcasters use them only in special conditions, such as when [CC-1] and [CC-3] or [T-1] and [T-3] are not available.

- There are 3 display modes according to programs:

Paint-on mode	Displays input characters on the TV screen immediately.
Pop-on mode	Once characters are stored in memory, they are displayed all at once.
Roll-up mode	Displays the characters continuously by scrolling (max. 4 lines).

- 6 Press **MENU** to exit.

B. Digital Caption Service

ATSC

In addition to the basic closed caption, DTV has its own closed caption called digital caption service. Use this menu to change the settings for digital caption service.

- Use ▲/▼ to select **[Digital Caption Service]**, then press **OK**.
- Use ▲/▼ to select the desired digital caption service, then press **OK**.

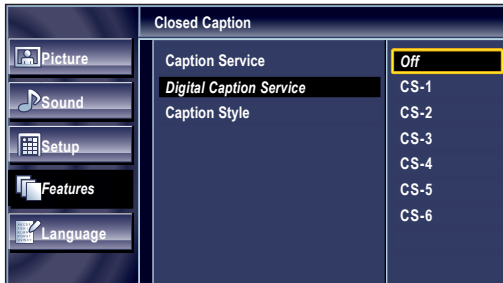

Off	Select if you do not want digital caption service.
CS-1 to CS-6	Select one of these before changing any other item in [Closed Caption] menu. Choose [CS-1] under normal circumstances.

- Press **MENU** to exit.

Note

- [Digital Caption Service]** that you can switch differs depending on the broadcast description.

C. Caption Style

ATSC

You can change the caption style such as font, color or size, etc.

- Use ▲/▼ to select **[Caption Style]**, then press **OK**.
- Use ▲/▼ to select **[User Setting]**, then press **OK**.



- Use ▲/▼ to select **[On]**, then press **OK**.
- Use ▲/▼ to select an item, then press **OK**. Then use ▲/▼ to select the desired setting and press **OK**.

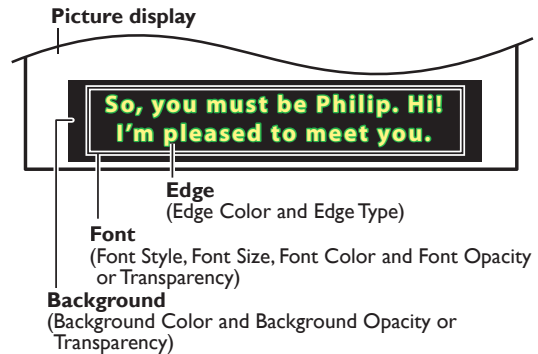

- The setting description for each item is shown on the next page.
- Review your setting choice made on the next page by looking in the upper right corner of the displayed setting box (not all selections show the differences selected).

Font Style

Closed Captioning font style can be changed as illustrated.



Font Size

Font size of the displayed caption can be switched as illustrated.

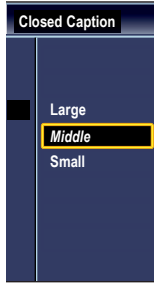

Font Color

Font color of the displayed caption can be switched as illustrated.



Font Opacity

Font opacity of the displayed caption can be switched as illustrated.

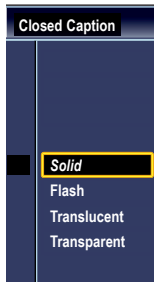

Background Color

Background color of the displayed caption can be switched as illustrated.



Background Opacity

Background opacity of the displayed caption can be switched as illustrated.

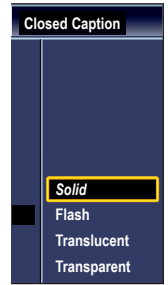

Edge Color

Edge color of the displayed caption can be switched as illustrated.



Edge Type

Edge type of the displayed caption can be switched as illustrated.



8 Press MENU to exit.

Note

- Closed caption will not be displayed when you are using an HDMI connection.
- To show the closed caption on your TV screen, broadcast signal must contain the closed caption data.
- Not all TV programs and commercials have the closed caption or all types of the closed caption.
- Captions and texts may not exactly match the TV voice.
- Changing channels may delay the closed caption for a few seconds.
- Adjusting or muting the volume may delay the closed caption for a few seconds.
- Abbreviations, symbols and other grammatical shortcuts may be used in order to keep pace with the on-screen action. This is not a malfunction.
- The caption or text characters will not be displayed while the main menu or functions display is shown.
- If a black box appears on the TV screen, this means that the closed caption is set to the text mode. To clear the box, select [CC-1], [CC-2], [CC-3], [CC-4] or [Off].
- If the unit receives poor quality television signals, the captions may contain errors, or there might be no captions at all. Some possible causes of poor quality signals are:
 - Automobile ignition noise
 - Electric motor noise
 - Weak signal reception
 - Multiplex signal reception (ghosts or screen flutter)
 - Data dropout and Pixelation (for DTV only)
- The unit retains the closed caption setting if the power fails.
- When the unit receives special effects playback signal (e.g. Search, Slow and Still) from a VCR's video output channel (ch3 or ch4), the unit may not display the correct caption or text.

Child Lock

Child lock reads the ratings for programs, then denies access to the programs which exceed the rating level you set. With this function, you can block certain programs inappropriate for children and any channels or external input modes can be invisible.

- 1 Press **MENU** to display the main menu.
- 2 Use **▲/▼** to select **[Features]**, then press **OK**.
- 3 Use **▲/▼** to select **[Child Lock]**, then press **OK**.

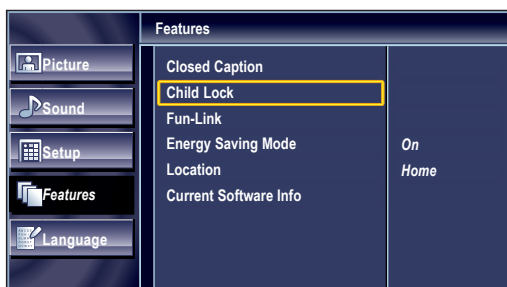

- 4 Use the **Number buttons** to enter the 4-digit numbers for your PIN code.

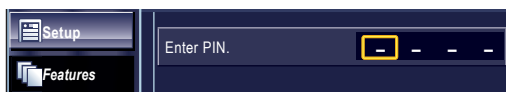

- When you have not set up your PIN code, enter **0, 0, 0, 0**.
- When the PIN code is correct, **[Child Lock]** menu is displayed.

See the following description for setting each item.



Note

- When you select a rating and set it to **[Block]**, the higher ratings will be blocked automatically. The lower ratings will be available for viewing.
- When you set the highest rating to **[View]**, all ratings turn to **[View]** automatically.
- To block any inappropriate programs, set your limits in **[US Movie Ratings Lock]**, **[US TV Ratings Lock]** and **[Region Ratings Lock]**.
- The child lock setting will be retained after a power failure (except the PIN code reverts to 0000).
- If the rating is blocked, **🔒** will appear.
- **[Region Ratings Lock]** will be available when the unit receives a digital broadcast using the new rating system.
- For the United States, the unit may download the Region Ratings Lock Table, if required.
- The Canadian rating systems on this unit are based on CEA-766-A and CRTIC policy.

A. Channel Lock

Particular channels or external input modes can be invisible in this function.

- 5 Use **▲/▼** to select **[Channel Lock]**, then press **OK**.
- 6 Use **▲/▼** to select the desired rating, then press **OK** repeatedly to switch between **[View]** and **[Block]**.

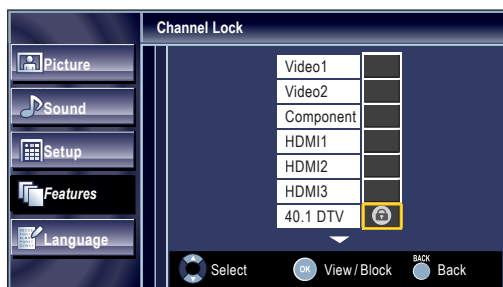

- 7 Press **MENU** to exit.

B. Setting US Movie ratings

US Movie ratings lock is the rating system created by MPAA.

- 5 Use **▲/▼** to select **[US Movie Ratings Lock]**, then press **OK**.
- 6 Use **▲/▼** to select the desired rating, then press **OK** repeatedly to switch between **[View]** and **[Block]**.

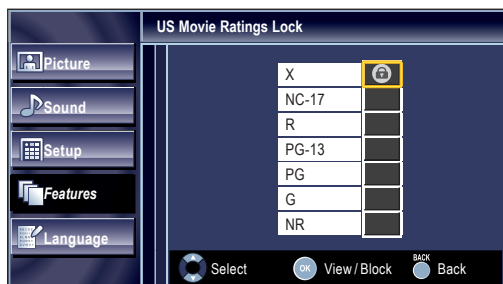

Rating	Category
X	Mature audience only
NC-17	No one under 17 admitted
R	Restricted; under 17 requires accompanying parent or adult guardian
PG-13	Unsuitable for children under 13
PG	Parental guidance suggested
G	General audience
NR	No rating

- 7 Press **MENU** to exit.

C. Setting TV ratings

- Use ▲/▼ to select [US TV Ratings Lock], then press OK.
- Use ▲/▼ / ◀/▶ to select the desired rating, then press OK repeatedly to switch between [View] and [Block].

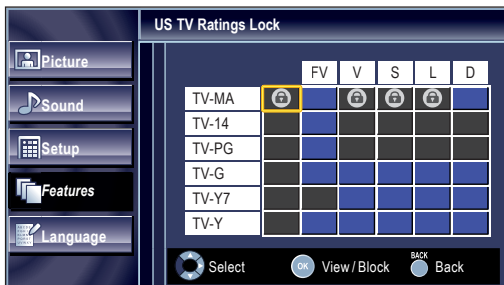

Rating	Category	
TV-MA	Mature audience only	higher ↑ ↓ lower
TV-14	Unsuitable for children under 14	
TV-PG	Parental guidance suggested	
TV-G	General audience	
TV-Y7	Appropriate for all children 7 and older	
TV-Y	Appropriate for all children	

- Press MENU to exit.

To set the sub ratings

As for TV-MA, TV-14, TV-PG, or TV-Y7, you can further set the sub ratings to block specific elements of programming. To set the sub ratings, follow the step below.

Use ▲/▼ / ◀/▶ to select the desired rating, then press OK repeatedly to switch between [View] and [Block].

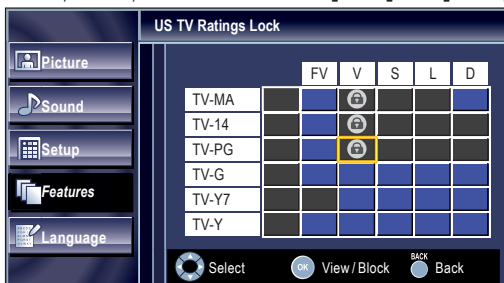

Sub Rating	Category	Rating
FV	Fantasy Violence	TV-Y7
V	Violence	TV-MA
S	Sexual Situation	TV-14
L	Coarse Language	TV-PG
D	Suggestive Dialogue	TV-14, TV-PG

Note

- Blocked sub rating will appear beside the main rating category in [US TV Ratings Lock] menu.
- You cannot block a sub rating (D, L, S or V) if the main rating is set to [View].
- Changing the category to [Block] or [View] automatically changes all its sub ratings to the same ([Block] or [View]).

D. Change PIN

Although the default PIN code (0000) is supplied with the unit, you can set your own PIN code.

- Use ▲/▼ to select [Change PIN], then press OK.
- Press the **Number buttons** to enter the new 4-digit PIN code.
 - Enter PIN code again in [Confirm PIN.] entry field.

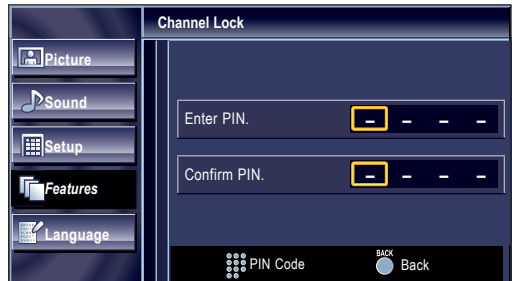

- Press MENU to exit.

Note

- Make sure new PIN code and confirm PIN code must be exactly the same. If they are different, the space is cleared for reentering.
- Your PIN code will be erased and return to the default (0000) when a power failure occurs. If you forget the PIN code, unplug the AC power cord while turning the unit on, wait for 10 seconds to plug the AC power cord again. The unit will restore the PIN code to 0000 as the factory default.

Fun-Link

This function allows you to operate the linked functions between our brand devices with a Fun-Link feature and this unit connecting through an HDMI cable.

- 1 Press **MENU** to display the main menu.
- 2 Use **▲/▼** to select [**Features**], then press **OK**.
- 3 Use **▲/▼** to select [**Fun-Link**], then press **OK**.



- 4 Use **▲/▼** to select the desired setting, then press **OK**.
- 5 Adjust the following items.

Fun-Link Control

Set the Fun-Link [**On**] or [**Off**].

The following additional settings will be grayed out when you set to [**Off**].

Use **▲/▼** to select the desired setting, then press **OK**.

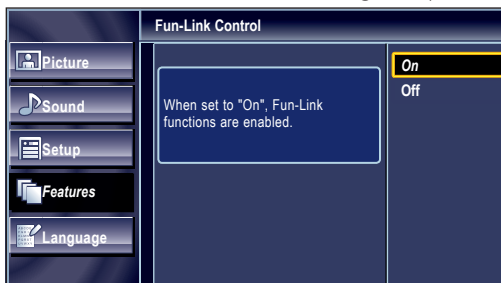

On	Selects if you have connected an external device that is compatible with the Fun-Link function.
Off	Disables all Fun-Link.

Auto Device Off

You can set your device to turn off by interlocking from this unit's power.

Use **▲/▼** to select the desired setting, then press **OK**.

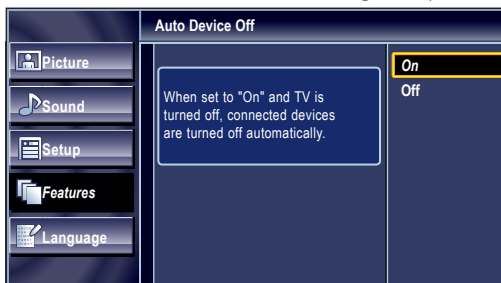

On	Your connected Fun-Link device turns off automatically when the unit goes to the standby mode.
Off	Your connected Fun-Link device stays on even if the unit goes to the standby mode.

Auto TV On

This unit will turn on detected when the power on signal is sent from your connected Fun-Link device.

Use **▲/▼** to select the desired setting, then press **OK**.

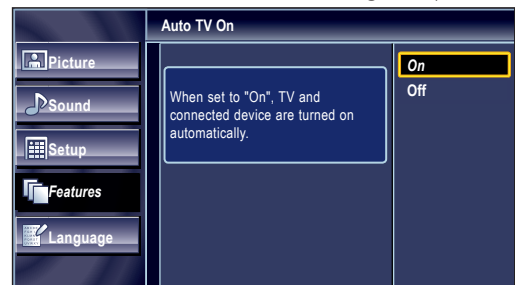

On	This unit turns on automatically when you turn on your connected Fun-Link device.
Off	This unit stays the standby mode even if you turn on your connected Fun-Link device.

Device Control

You can operate some functions such as disc playback or call up the menu of the connected devices, by using this unit's remote control.

Use **▲/▼** to select the desired setting, then press **OK**.

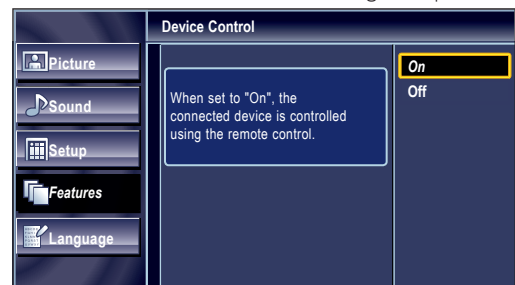

On	▶/■/▶▶/◀◀/▶▶/◀◀/ /FUN-LINK OPTIONS/▲/▼/◀/▶/OK/BACK/the Number buttons/RED/GREEN/BLUE/YELLOW can be used to control your connected Fun-Link devices by this unit's remote control.
Off	Disables the device control.

Device List

This function lets you see the product model number or name of connected devices.

Use **▲/▼** to select the desired HDMI device listed on the TV screen, then press **OK**.



- 6 Press **MENU** to exit.

Energy Saving Mode

You can set whether the power consumption is saved or not.

- 1 Press **MENU** to display the main menu.
- 2 Use **▲/▼** to select [**Features**], then press **OK**.
- 3 Use **▲/▼** to select [**Energy Saving Mode**], then press **OK**.
- 4 Use **▲/▼** to select the desired mode, then press **OK**.

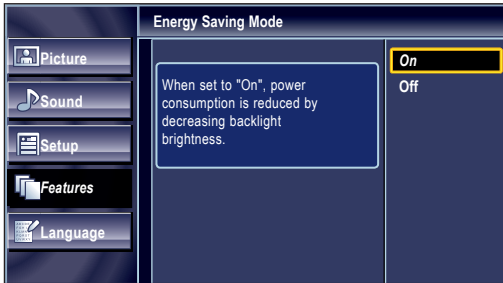

On	Reduces the power consumption.
Off	The power consumption may possibly exceed the limited requirement of the ENERGY STAR® qualification.

- 5 Press **MENU** to exit.

Current Software Info

This function shows what version of the software currently used.

- 1 Press **MENU** to display the main menu.
- 2 Use **▲/▼** to select [**Features**], then press **OK**.
- 3 Use **▲/▼** to select [**Current Software Info**], then press **OK**.
- 4 Confirm the version of the software currently used.

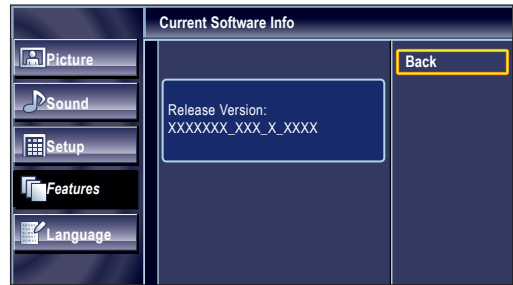

- 5 Press **MENU** to exit.

Location

When you select [**Retail**] store, the power consumption may possibly exceed the limited requirement of the ENERGY STAR® qualification.

- 1 Press **MENU** to display the main menu.
- 2 Use **▲/▼** to select [**Features**], then press **OK**.
- 3 Use **▲/▼** to select [**Location**], then press **OK**.
- 4 Use **▲/▼** to select the desired location, then press **OK**.

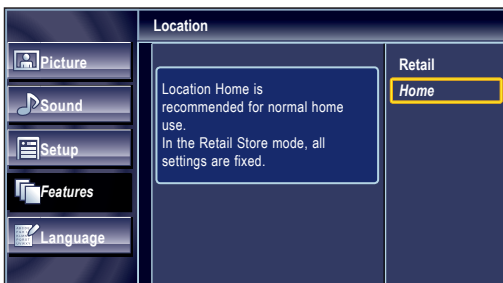

- 5 Press **MENU** to exit.

TROUBLESHOOTING

FAQ

Question	Answer
My remote control does not work. What should I do?	<ul style="list-style-type: none"> • Check the antenna or cable connection to the main unit. • Check the batteries of the remote control. • Check if there is an obstacle between the infrared sensor window and the remote control. • Test the signal output. If OK, then possible infrared sensor trouble. [IR Signal Check] ■■■▶ p.34 • Aim the remote control directly at the infrared sensor window on the front of the unit. • Reduce the distance to the unit. • Re-insert the batteries with their polarities (+/- signs) as indicated. • When there is an infrared-equipped device such as PC near this unit, it may interrupt the remote control signal of this unit. • Move the infrared-equipped device away from this unit, change the angle of the infrared sensor or turn off the infrared communication function.
How come the Initial setup appears every time I turn on this unit?	<ul style="list-style-type: none"> • Connect the RF coaxial cable to the unit directly and run the initial setup. • Make sure to complete the channel scan before the unit goes to the standby mode.
Why I cannot watch some RF signal TV programs.	<ul style="list-style-type: none"> • Make sure [Autoprogram] has been completed. ■■■▶ p.19 • Autoprogram must be completed when you set up the unit for the first time or move it to a location where previously unavailable channels are broadcast. • The selected channel may not be broadcasting. • When [Autoprogram] is interrupted and not completed, some channels will not be received. Make sure to complete. ■■■▶ p.19 • The selected channel cannot be viewed by the [Child Lock] setting. ■■■▶ p.27 • The unit requires some kind of antenna input. An indoor antenna (VHF /UHF), an external antenna (VHF /UHF) or an RF coaxial cable from your wall cable/satellite box needs to be plugged into the unit.
How come there is no image from the connected external devices?	<ul style="list-style-type: none"> • Check if the right input mode is selected by pressing SOURCE or using CH +/- . [Switching Each Input Mode] ■■■▶ p.17 • Check the antenna or cable connection to the unit. • When using the Component Video Connection check that the Green (Y), Blue (Pb/Cb) and Red (Pr/Cr) connectors are connected to their corresponding colored jacks on the unit.
Whenever I entered channel number, it changes automatically.	<ul style="list-style-type: none"> • Many digital channels have alternate channel numbers. The unit changes the numbers automatically to the ones signifying the broadcasting station channel number. These basic numbers used for previous analog broadcasts. (e.g., input ch#30 auto change to ch#6.1)
Why are captions not displayed entirely? Or, captions are delayed behind the dialogue.	<ul style="list-style-type: none"> • Captions that are delayed a few seconds behind the actual dialogue are common for live broadcasts. Most captioning production companies can display a dialogue to maximum of 220 words per minute. If a dialogue exceeds that rate, selective editing is used to insure that the captions remain up-to date with the current TV screen dialogue.
How can I set the clock ?	<ul style="list-style-type: none"> • There is no clock function on this unit.

Troubleshooting Guide

If the unit does not perform properly when operated as instructed in this manual, check the following chart and all connections once before calling for service.

Symptom	Remedy
No power	<ul style="list-style-type: none"> • Make sure the AC power cord is plugged in. • Make sure that the AC outlet supplies the proper voltage, plug another electrical appliance into the AC outlet to ensure that AC outlet operates normally. • If a power failure occurs, unplug the AC power cord for 1 minute to allow the unit to reset itself.
Control button does not work.	<ul style="list-style-type: none"> • Press only one button at a time. Do NOT press more than one button at the same time. • Ensure that no buttons on the remote are depressed and move freely.
Power is ON but no screen image.	<ul style="list-style-type: none"> • Check whether the connection of the antenna, cable receiver or satellite box is connected correctly. • Check whether all the cables to the unit are connected to the correct output jack of your device like BD/DVD recorder. • Make sure that the selected input mode is connected to the working input jack. • Check if your computer is NOT in sleep mode when the input mode of this unit is in PC mode. Tap any key on the keyboard to wake up your computer.
No picture or sound	<ul style="list-style-type: none"> • Check if the power is on. • Check if the right input mode is selected. • Check whether all the cables to the unit are connected to the correct output jack of your device like BD/DVD recorder. • View other TV channels. The problem might be limited to the broadcasting station or weak signal strength. • Unplug the AC power cord and wait for about 1 minute, then plug the AC power cord and turn on the unit again. • Check whether the connection of the antenna, cable receiver or satellite box is connected correctly. • Make sure that the selected input mode is connected to the working input jack. • Check if your computer is NOT in sleep mode when the input mode of this unit is in PC mode. Tap any key on the keyboard to wake up your computer. • Make sure that the sound is not muted. Press MUTE  so that the volume bar and current volume level will appear on the TV screen. • Make sure that the volume is NOT set to [0] or [Mute]. If so, use VOL +/- to adjust the desired volume.
No color	<ul style="list-style-type: none"> • View other TV channels. The problem might be limited to the broadcasting station. • Adjust [Color] in the main menu.
Adjusted [Picture] or [Sound] settings are not effective every time the unit is turned on.	<ul style="list-style-type: none"> • You must set [Home] in [Location].  p.30 Otherwise, the settings you adjusted will not be memorized after the unit goes to the standby mode.
Sound OK, picture poor	<ul style="list-style-type: none"> • Electrical interference from nearby appliances may affect picture quality. • Adjust [Contrast] and [Brightness] in the main menu. • View other TV channels. The problem might be limited to the broadcasting station or weak signal strength. • For the best picture quality, watch "High Definition" wide screen programs. If the HD content is not available, watch "Standard Definition" programs instead.
Picture OK, sound poor	<ul style="list-style-type: none"> • View other TV channels. The problem might be limited to the broadcasting station or weak signal strength. • Check if the audio cable is connected in correctly.
You see a distorted picture or hear an unusual sound.	<ul style="list-style-type: none"> • You may be getting interference from electrical appliances, automobiles, motorcycles or fluorescent lights. • Try moving the unit to another location to see if this is the cause of the problem.
Ghosts, lines or streaks in picture	<ul style="list-style-type: none"> • Electrical interference from nearby appliances may affect picture quality. • View other TV channels. The problem might be limited to the broadcasting station.

Symptom	Remedy
You see "noise" or "trash" on the screen.	<ul style="list-style-type: none"> When the capabilities of the unit exceed the capabilities of the digital broadcasting, the signal will be increased to match the capabilities of the display of the unit. This may cause noise or trash.
Different color marks on the TV screen	<ul style="list-style-type: none"> View other TV channels. The problem might be limited to the broadcasting station, missing data or pixelation.
You switch to a different input and the volume changes.	<ul style="list-style-type: none"> This unit will memorize the volume level from the last time you adjusted it. If the volume of the sound from another device is higher or lower, then the loudness will change.
You switch to a different input and the screen size changes.	<ul style="list-style-type: none"> This unit will memorize the viewing mode from the last time you used the particular input modes.
The display image does not cover the entire screen.	<ul style="list-style-type: none"> If you are watching TV or using the Composite Video, S-Video, Component Video or HDMI with 480i Input, press FORMAT  repeatedly to switch various screen modes.
Captions are displayed as a white box. No caption is displayed in the Closed Caption-supported program.	<ul style="list-style-type: none"> Interference from buildings or weather conditions may cause captioning to be incomplete. Broadcasting station may shorten the program to insert advertisement. The closed caption decoder cannot read the information of the shortened program.
Black box is displayed on the TV screen.	<ul style="list-style-type: none"> The text mode is selected for caption. Select [CC-1], [CC-2], [CC-3], [CC-4] or [Off].

Note

- The LCD panel is manufactured to provide many years of useful life. Occasionally a few non active pixels may appear as a fixed point of blue, green or red. This is not to be considered a defect in the LCD screen.
- Some functions are not available in specific modes, but this is not a malfunction. Read the description in this manual for more details on correct operations.

INFORMATION

Glossary

ATSC

Acronym that stands for Advanced Television Systems Committee and the name of the digital broadcasting standards.

Aspect Ratio

The width of a TV screen relative to its height. Conventional TVs are 4:3 (in other words, the TV screen is almost square); widescreen models are 16:9 (the TV screen is almost twice as wide as its height).

Component Video

This is a video signal format that conveys each of 3 principal colors of light (red, blue and green) through different signal lines. This allows the viewers to experience picture colors as original as it is. There are several signal formats, including Y/Pb/Pr and Y/Cb/Cr.

Dolby Digital

The system developed by Dolby Laboratories to compress digital sound. It offers stereo sound (2ch) or multi-channel audio.

HDMI (High-Definition Multimedia Interface)

Interface that supports all uncompressed, digital audio/video formats including set-top box, BD/DVD recorder or digital television, over a single cable.

HDTV (High Definition TV)

Ultimate digital format that produces high resolution and high picture quality.

NTSC

Acronym that stands for National Television Systems Committee and the name of analog broadcasting standards.

Off the air NTSC signals are no longer being sent by major broadcasting stations in the USA.

PIN code

A stored 4-digit number that allows access to parental control features.

SAP (Secondary Audio Program)

Second-audio channel delivered separately from main-audio channel. This audio channel is used as an alternate in bilingual broadcasting.

SDTV (Standard Definition TV)

Standard digital format that is similar to the NTSC picture quality.

S-Video

Offers higher quality images by delivering each signal, color (c) and luminance (y) independently of each other through a single cable.

Maintenance

Cabinet Cleaning

- Wipe the front panel and other exterior surfaces of the unit with a soft cloth.
- Never use a solvent or alcohol. Do not spray insecticide liquid near the unit. Such chemicals may cause damage and discoloration to the exposed surfaces.

Panel Cleaning

Wipe the panel of the unit with a soft cloth. Before cleaning the panel, disconnect the AC power cord.

Servicing

Should your unit become inoperative, do not try to correct the problem yourself. There are no user serviceable parts inside. Call our toll free customer support line found on the cover of this manual to locate an authorized service center.

IR Signal Check

If the remote control is not working properly, you can use a digital camera (including a cellular phone with built-in camera) to see if it is sending out an infrared signal.



With a digital camera (including built-in cell phone cameras):

Point the Digital Camera towards the remote control infrared diode at the front of the remote control. Press any button on the remote control and look through the camera display. If the infrared pulsating light appears through the camera, the remote control is sending out an IR signal.

General Specifications

TV format	ATSC/NTSC-M TV standard
Closed caption system	§15.122/FCC (digital CC) §15.119/FCC (analog CC)
Channel coverage (ATSC/NTSC)	
Terrestrial DTV (ATSC)	VHF 2~13 UHF 14~51 each channel has e.g.) 2.1~2.9, 3.1~3.9, etc.
Terrestrial Analog (NTSC)	VHF 2~13 UHF 14~69
CATV	2~13, A~W, W+1~W+94 (analog W+1~W+84), A-5~A-1, 5A
Tuning system	Channel frequency synthesized tuning system
Channel access	Direct access keyboard, Programmable scan, and up/down

Electrical Specification

Audio Output	10W, 8Ω × 2
--------------	-------------

Other Specifications

Terminals

Antenna Input	VHF/UHF/CATV	75 Ω unbalanced (F-type)
Audio Input	RCA jack (L/R) × 8	500mV rms
Composite Video Input	RCA jack × 2	1V p-p (75 Ω)
S-Video Input	Mini DIN 4 pin jack × 2	Y 1V p-p (75 Ω) C 286mV p-p (75 Ω)
Component Video Input	RCA jack × 3	Y 1V p-p (75 Ω) Pb/Cb 700mV p-p (75 Ω) Pr/Cr 700mV p-p (75 Ω)
HDMI Input	HDMI 19 pin × 3	
Digital Audio Output (coaxial)	RCA jack × 1	500mV p-p (75 Ω)
Analog Audio Output	RCA jack (L/R) × 2	500mV rms

Remote control

Digital encoded infrared light system

Operating temperature

41°F (5°C) to 104°F (40°C)

Power requirements

120V~ AC +/- 10%, 60Hz +/- 0.5%

Power consumption (maximum)

205W

LCD 40 inches full HD panel

Dimensions <without base>

<with base>

Width 39.2 inches(995.2mm) 39.2 inches(995.2mm)

Height 25.1 inches(637.0mm) 27.3 inches(691.7mm)

Depth 4.3 inches(107.5mm) 10.3 inches(260.0mm)

Weight 35.94 lbs. (16.30kg) 41.23 lbs. (18.70kg)

- Designs and specifications are subject to change without notice and without our legal obligation.
- If there is a discrepancy between languages, the default language will be English.

LIMITED WARRANTY NINETY (90) DAY LABOR / ONE (1) YEAR PARTS

WARRANTY COVERAGE:

This warranty obligation is limited to the terms as set forth below.

WHO IS COVERED:

This product warranty is issued to the original purchaser or the person receiving the product as a gift against defects in materials and workmanship as based on the date of original purchase ("Warranty Period") from an Authorized Dealer. The original sales receipt showing the product name and the purchase date from an authorized retailer is considered such proof.

WHAT IS COVERED:

This warranty covers new products if a defect in material or workmanship occurs and a valid claim is received within the Warranty Period. At its option, the company will either (1) repair the product at no charge, using new or refurbished replacement parts, or (2) exchange the product with a product that is new or which has been manufactured from new, or serviceable used parts and is at least functionally equivalent or most comparable to the original product in current inventory, or (3) refund the original purchase price of the product. Replacement products or parts provided under this warranty are covered against defects in materials and workmanship from the date of the replacement or repair for ninety (90) days or for the remaining portion of the original product's warranty, whichever provides longer coverage for you. When a product or part is exchanged, any replacement item becomes your property and the replaced item becomes company property. When a refund is given, your product becomes company property.

Note: Any product sold and identified as refurbished or renewed carries a ninety (90) day limited warranty.

Replacement product can only be sent if all warranty requirements are met. Failure to follow all requirements can result in delay.

WHAT IS NOT COVERED - EXCLUSIONS AND LIMITATIONS:

This Limited Warranty applies only to new company manufactured products that can be identified by the trademark, trade name, or logo affixed to it. This Limited Warranty does not apply to any hardware product or any software, even if packaged or sold with the product, as manufacturers, suppliers, or publishers may provide a separate warranty for their own products packaged with the bundled product.

The company is not liable for any damage to or loss of any programs, data, or other information stored on any media contained within the product, or other additional product or part not covered by this warranty. Recovery or reinstallation of programs, data or other information is not covered under this Limited Warranty.

This warranty does not apply (a) to damage caused by accident, abuse, misuse, neglect, misapplication, or non-supplied product, (b) to damage caused by service performed by anyone other than company approved Authorized Service Location, (c) to a product

or a part that has been modified without written company permission, or (d) if any serial number has been removed or defaced, or (e) product, accessories or consumables sold "AS IS" without warranty of any kind by including refurbished product sold "AS IS" by some retailers.

This Limited Warranty does not cover:

- Shipping charges to return defective product.
- Labor charges for installation or setup of the product, adjustment of customer controls on the product, and installation or repair of antenna/signal source systems outside of the product.
- Product repair and/or part replacement because of improper installation or maintenance, connections to improper voltage supply, power line surge, lightning damage, retained images or screen markings resulting from viewing fixed stationary content for extended periods, product cosmetic appearance items due to normal wear and tear, unauthorized repair or other cause not within the control of the company.
- Damage or claims for products not being available for use, or for lost data or lost software.
- Damage from mishandled shipments or transit accidents when returning product.
- A product that requires modification or adaptation to enable it to operate in any country other than the country for which it was designed, manufactured, approved and/or authorized, or repair of products damaged by these modifications.
- A product used for commercial or institutional purposes (including but not limited to rental purposes).
- Product lost in shipment and no signature verification receipt can be provided.
- Failure to operate per Owner's Manual.

TO OBTAIN ASSISTANCE...

Contact the Customer Care Center at:
1-866-309-8819

REPAIR OR REPLACEMENT AS PROVIDED UNDER THIS WARRANTY IS THE EXCLUSIVE REMEDY FOR THE CONSUMER, WITH THE ISSUING COMPANY NOT LIABLE FOR ANY INCIDENTAL OR CONSEQUENTIAL DAMAGES FOR BREACH OF ANY EXPRESS OR IMPLIED WARRANTY ON THIS PRODUCT. EXCEPT TO THE EXTENT PROHIBITED BY APPLICABLE LAW, ANY IMPLIED WARRANTY OF MERCHANTABILITY OR FITNESS FOR A PARTICULAR PURPOSE ON THIS PRODUCT IS LIMITED IN DURATION TO THE DURATION OF THIS WARRANTY.

Some states do not allow the exclusions or limitation of incidental or consequential damages, or allow limitations on how long an implied warranty lasts, so the above limitations or exclusions may not apply to you.

This warranty gives you specific legal rights. You may have other rights which vary from state/province to state/province.

FUNAI CORPORATION, Inc. 19900 Van Ness Avenue, Torrance, CA 90501

Free Manuals Download Website

<http://myh66.com>

<http://usermanuals.us>

<http://www.somanuals.com>

<http://www.4manuals.cc>

<http://www.manual-lib.com>

<http://www.404manual.com>

<http://www.luxmanual.com>

<http://aubethermostatmanual.com>

Golf course search by state

<http://golfingnear.com>

Email search by domain

<http://emailbydomain.com>

Auto manuals search

<http://auto.somanuals.com>

TV manuals search

<http://tv.somanuals.com>