

Emerson[®]

***Home Audio System
with 3 CD Changer,
Belt-Drive Turntable,
Dual Cassette Deck
and Remote Control***

OWNER'S MANUAL

MS9903TT

Visit our web site at www.emersonradio.com



CAUTION

TO PREVENT FIRE OR SHOCK HAZARD, DO NOT USE THIS PLUG WITH AN EXTENSION CORD, RECEPTACLE OR OTHER OUTLET UNLESS THE BLADES CAN BE FULLY INSERTED TO PREVENT BLADE EXPOSURE. TO PREVENT FIRE OR SHOCK HAZARD, DO NOT EXPOSE THIS APPLIANCE TO RAIN OR MOISTURE.



The lightning flash with arrow-head symbol, within an equilateral triangle is intended to alert the user to the presence of uninsulated 'dangerous voltage' within the product's enclosure that may be of sufficient magnitude to constitute a risk of electric shock to persons.

CAUTION

RISK OF ELECTRIC SHOCK
DO NOT OPEN

WARNING: TO REDUCE THE RISK OF ELECTRIC SHOCK DO NOT REMOVE COVER (OR BACK), NO USER SERVICEABLE PARTS INSIDE REFER SERVICING TO QUALIFIED SERVICE PERSONNEL.



The exclamation point within an equilateral triangle is intended to alert the user to the presence of important operating and maintenance (servicing) instructions in the literature accompanying the appliance.

IMPORTANT SAFETY INSTRUCTIONS

- 1.) Read these instructions.
- 2.) Keep these instructions.
- 3.) Heed all warnings.
- 4.) Follow all instructions.
- 5.) Do not use this apparatus near water.
- 6.) Clean only with dry cloth.
- 7.) Do not block any ventilation openings. Install in accordance with the manufacturer's instructions.
- 8.) Do not install near any heat sources such as radiators, heat registers, stoves, or other apparatus (including amplifiers) that produce heat.
- 9.) Do not defeat the safety purpose of the polarized or grounding-type plug. A polarized plug has two blades with one wider than the other. A grounding type plug has two blades and a third grounding prong. The wide blade or the third prong is provided for your safety. If the provided plug does not fit into your outlet, consult an electrician for replacement of the obsolete outlet.
- 10.) Protect the power cord from being walked on or pinched particularly at plugs, convenience receptacles, and the point where they exit from the apparatus.
- 11.) Only use attachments / accessories specified by the manufacturer.
- 12.) Unplug this apparatus during lightning storms or when unused for long periods of time.
- 13.) Refer all servicing to qualified service personnel. Servicing is required when the apparatus has been damaged in any way, such as power-supply cord or plug is damaged, liquid has been spilled or objects have fallen into the apparatus, the apparatus has been exposed to rain or moisture, does not operate normally, or has been dropped.
- 14.) This appliance shall not be exposed to dripping or splashing water and no object filled with liquids such as vases shall be placed on the apparatus.
- 15.) Do not overload wall outlet. Use only power source as indicated.
- 16.) Use replacement parts as specified by the manufacturer.
- 17.) The product may be mounted to a wall only if recommended by the manufacturer.
- 18.) Upon completion of any service or repairs to this product, ask the service technician to perform safety checks.



Thank you.....

For purchasing this Emerson complete home audio system including a stereo radio, 3 disc changer, dual cassette deck, stereo phonograph, matching speakers, and remote control.

Please read this Owner's Manual carefully and completely to make sure that you get the maximum benefit out of all the outstanding features we've included in this compact system. It's designed to give you many years of trouble free operation with an absolute minimum of care and maintenance.

Every component in this system was in perfect working order when it left our factory.

If you experience any problems with the set up or operation of this system please do not return it to the retail store. Please call the Emerson Customer Service Hotline toll free at 1-800-898-9020 and one of our service technicians will attempt to diagnose and correct the problem for you.

Once again, thanks for purchasing this Emerson audio product.

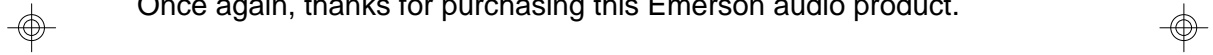

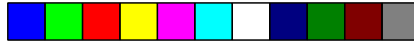

IMPORTANT NOTES

- Avoid installing this unit in places exposed to direct sunlight or close to heat radiating appliances such as electric heaters, on top of other stereo equipment that radiates too much heat, places lacking ventilation or dusty areas, places subject to constant vibration and/or humid or moist areas.
- Do not attempt to clean this unit with chemical solvents as this might damage the finish. Use a clean dry cloth.
- Operate controls and switches as described in the manual.
- Before turning 'On' the power, make certain that power cord is properly installed.
- Store your CDs, cassettes in a cool area to avoid damage from heat.
- When moving the set, be sure to first disconnect the power cord.

CLASS 1 LASER PRODUCT

CLASS 1 LASER PRODUCT
APPAREIL À LASER DE CLASSE 1
PRODUCTO LASER DE CLASE 1

CAUTION
INVISIBLE LASER RADIATION
WHEN OPEN AND INTERLOCKS
DEFEATED.
AVOID EXPOSURE TO BEAM



This product contains a low power Laser Device.

FCC INFORMATION

This equipment has been tested and found to comply with the limits for a Class B digital device, pursuant to Part 15 of the FCC Rules. These limits are designed to provide reasonable protection against harmful interference in a residential installation. This equipment generates, uses, and can radiate radio frequency energy and, if not installed and used in accordance with the instructions, may cause harmful interference to radio communications. However, there is no guarantee that interference will not occur in a particular installation. If this equipment does cause harmful interference to radio or television reception, which can be determined by turning the equipment off and on, the user is encouraged to try to correct the interference by one or more of the following measures:

- Reorient or relocate the receiving antenna.
- Increase the separation between the equipment and receiver.
- Connect the equipment into an outlet on a circuit different from that to which the receiver is connected.
- Consult the dealer or an experienced radio/TV technician for help.

This device complies with Part 15 of the FCC Rules. Operation is subject to the following two conditions:

- (1) This device may not cause harmful interference, and
- (2) This device must accept any interference received, including interference that may cause undesired operation.

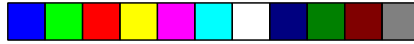

PREPARATION FOR USE

SPEAKER CONNECTION

Connect each speaker to the corresponding speaker terminals on the back panel of the main unit. Make sure that the **left** speaker is connected to the left (**L**) speaker jack and the **right** speaker to the right (**R**) speaker jack.

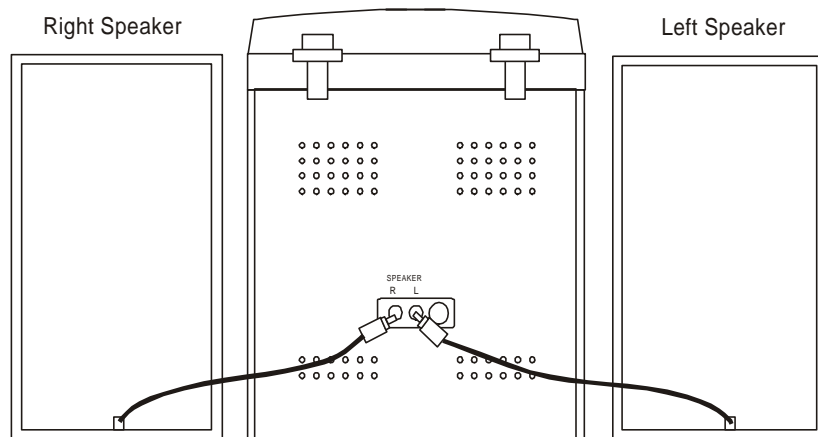

CONNECTING THE AC POWER CORD

After connecting the speakers unwind the AC power cord fully and connect it to any convenient household AC outlet.

NOTE:

This product is designed to operate on normal 120V 60Hz AC only. Connecting this system to any other power supply could result in damage to the unit which is not covered by your warranty. You will note that this system is equipped with a polarized AC power plug having one blade wider than the other. This is a safety feature.

If this plug does not fit into your existing AC outlet, do not try to defeat this safety feature by filing the wide blade to make it fit into your outlet. If this plug will not fit into your outlet, you probably have an outdated non-polarized AC outlet. You should have your outlet changed by a qualified licensed electrician.

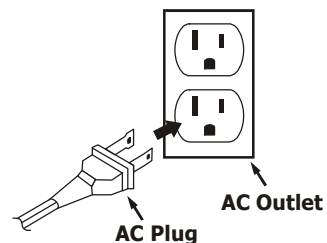



PROTECT YOUR FURNITURE !!

This model is equipped with non-skid rubber 'feet' to prevent the product from moving when you operate the controls. These 'feet' are made from non-migrating rubber material specially formulated to avoid leaving any marks or stains on your furniture. However certain types of oil based furniture polishes, wood preservatives, or cleaning sprays may cause the rubber 'feet' to soften, and leave marks or a rubber residue on the furniture. To prevent any damage to your furniture we strongly recommend that you purchase small self-adhesive felt pads, available at hardware stores and home improvement centers everywhere, and apply these pads to the bottom of the rubber 'feet' before you place the product on fine wooden furniture.



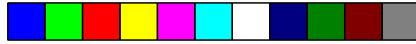

LOCATION OF CONTROLS AND INDICATORS



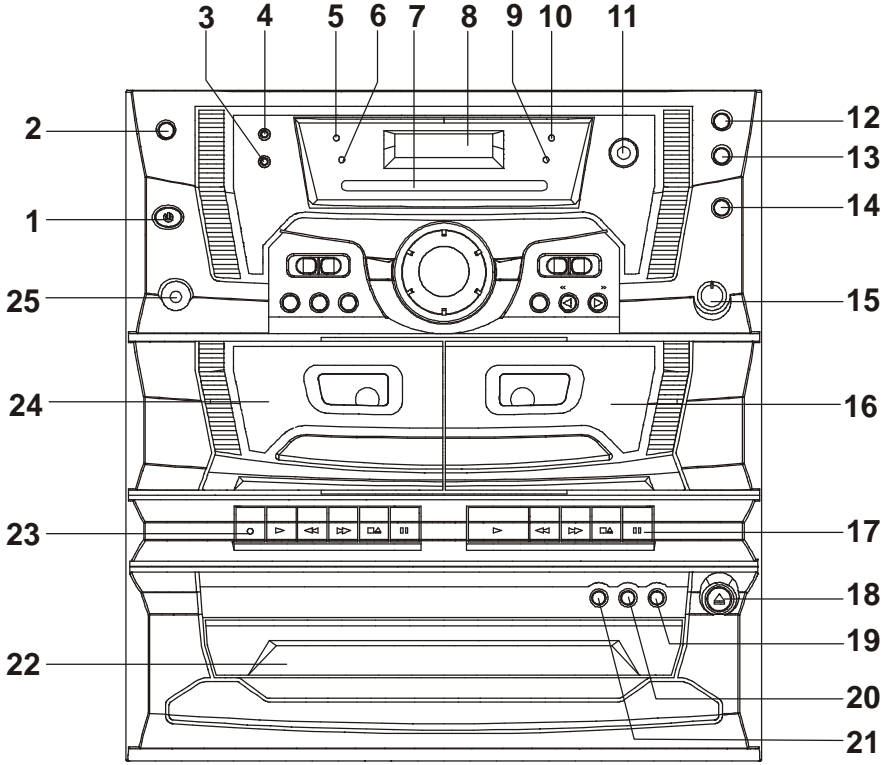



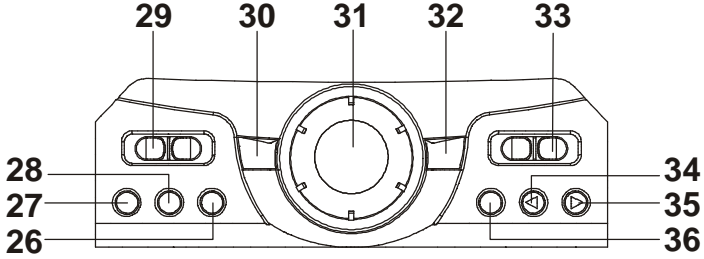

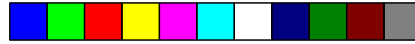
FRONT VIEW



CONTROL PANEL





- 1.) POWER  On/Off Button.
- 2.) PRESET EQ Button.
- 3.) FM STEREO Indicator.
- 4.) STANDBY/MUTE Indicator.
- 5.) ROCK Equalizer Indicator.
- 6.) POP Equalizer Indicator.
- 7.) Dial Scale.
- 8.) LCD Display.
- 9.) JAZZ Equalizer Indicator.
- 10.) CLASSIC Equalizer Indicator.
- 11.) Remote SENSOR.
- 12.) VOLUME UP Button.
- 13.) VOLUME DOWN Button.
- 14.) FM MONO/HI-SPEED DUBBING (ON  /OFF ) Button.
- 15.) BALANCE Control.
- 16.) Cassette DECK B Door.
- 17.) Cassette DECK B Control Keys.
- 18.) CD Tray Open/Close  Button.
- 19.) Disc 3 Select Button.
- 20.) Disc 2 Select Button.
- 21.) Disc 1 Select Button.
- 22.) CD Tray.
- 23.) Cassette DECK A Control Keys.
- 24.) Cassette DECK A Door.
- 25.) PHONES (Headphone) Jack.
- 26.) DISC SKIP Button.
- 27.) PROGRAM Button.
- 28.) REPEAT Button.
- 29.) FUNCTION (PHONO/TUNER/TAPE/CD) Selector Switch.
- 30.) STOP  Button.
- 31.) TUNING Control.
- 32.) PLAY/PAUSE  Button.
- 33.) BAND (FM/AM) Selector Switch.
- 34.) SKIP/SEARCH Reverse  Button.
- 35.) SKIP/SEARCH Forward  Button.
- 36.) INTRO Button.

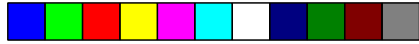

BACK VIEW

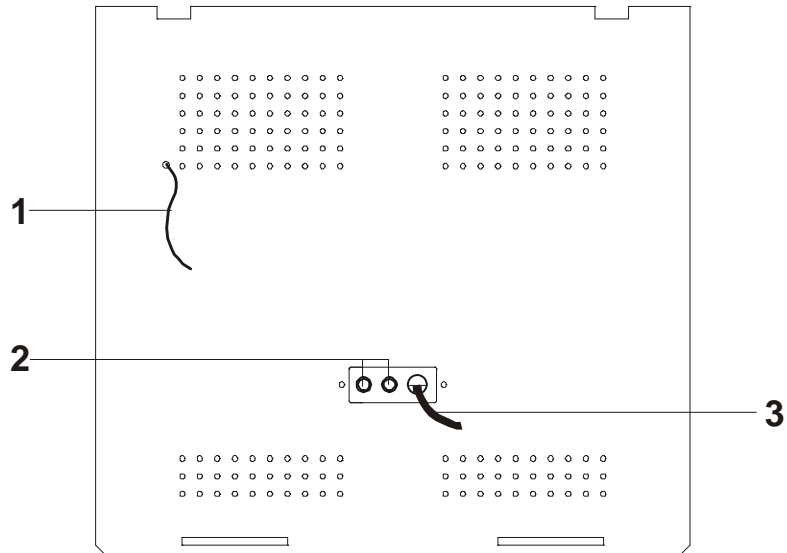

- 1.) FM Wire Antenna.
- 2.) Speaker L / R Jacks.
- 3.) AC Power Cord.



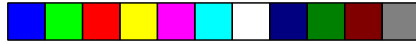

REMOTE CONTROL

- 1.) STANDBY/ON Button.
- 2.) STOP ■ Button.
- 3.) PROGRAM Button.
- 4.) PLAY/PAUSE ►|| Button.
- 5.) SKIP/SEARCH ►► Button.
- 6.) SKIP/SEARCH ◄◄ Button.
- 7.) DISC Select Button.
- 8.) MUTE Button.
- 9.) VOLUME – Button.
- 10.) VOLUME + Button.
- 11.) Battery Compartment (Back Cabinet).

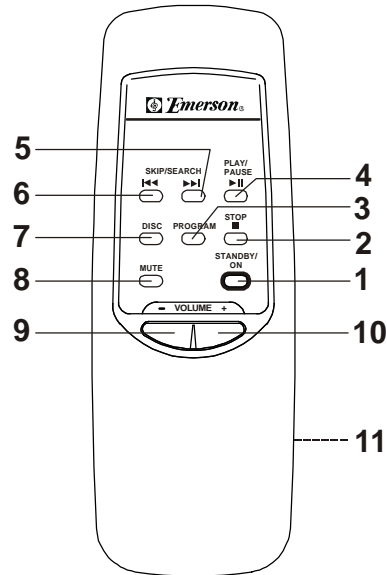

BATTERY INSTALLATION

- 1.) Open the battery compartment cover.
- 2.) Insert two "AAA" (UM4) batteries (not included) to match the polarities as indicated inside the battery compartment.
- 3.) Close the cover.

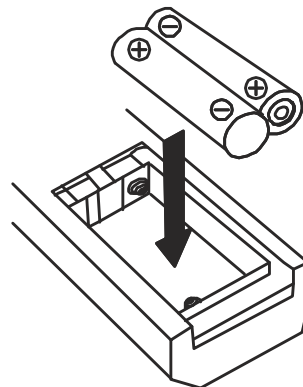

Battery Precautions

- Replacement of batteries must be done by an adult.
- Do not mix old and new batteries.
- Do not mix alkaline, standard (carbon-zinc) or rechargeable (nickel-cadmium) batteries.
- The supply terminals are not to be short-circuited.
- Non-rechargeable batteries are not to be recharged.
- Exhausted batteries are to be removed.
- Only batteries of the equivalent type are to be used.
- Batteries are to be inserted with the correct polarity.
- Dispose of batteries properly. Do not dispose of batteries in fire. The batteries may explode or leak.

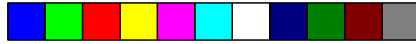

OPERATING INSTRUCTIONS

GENERAL CONTROLS

Preset Electronic Equalizer

When the unit is switched 'On' for the first time, the Equalizer will be in the "Flat" setting. Press the PRESET EQ button to select "ROCK", "POP", "CLASSIC" or "JAZZ" sound effect to suit your taste. The appropriate EQ Indicator lights to confirm your selection.





Mute Button (Remote Control Only)

To temporarily shut off the sound from the speakers press the MUTE button on the remote control. The STANDBY/MUTE indicator on front panel will flash and the sound will stop. Press the MUTE button again to cancel Mute and restore the sound. The MUTE indicator goes "Off".

Balance Control

This control adjusts the relative volume of the left and right speakers. When this control is set to the center-click position you will have equal volume from both speakers. If your normal listening position is closer to one of the two speakers, rotate this control to the left or to the right until the volume from both of the speakers sounds the same at your normal listening position.

FM Mono/Hi-Speed Dubbing "ON /OFF

This button is used to select between the FM STEREO and FM MONO operation modes (It is also used to select either  Normal Speed or  High Speed tape dubbing.) To receive FM Stereo broadcasts this switch must be set to the STEREO  position. However if you are listening to a distant or weak FM Stereo station and reception is unsatisfactory, setting the selector to the FM MONO  position may provide some improvement.

PHONES Jack

The Stereo Headphone Jack is located on the left front panel. Connect a set of stereo headphones (not included) to this jack for private listening without disturbing others. The speakers are automatically disconnected when headphones are connected to the headphone jack.

IMPORTANT: When using headphones always set the volume control to a low level before you put the headphones on. Then put the headphones on and gradually increase the volume to a comfortable listening level.



LISTENING TO THE RADIO

- 1.) Slide the FUNCTION selector to the TUNER position.
- 2.) Slide the BAND selector to the desired band, FM or AM.
- 3.) Tune to your desired station with the TUNING control. If you have tuned to a FM Stereo station the FM STEREO LED Indicator will light.
- 4.) Adjust the VOLUME control and EQ as desired.
- 5.) When you are finished listening press the POWER  button to shut the power 'Off'.

Antenna Information

AM – The AM antenna is inside the cabinet. IF AM reception is unsatisfactory try rotating the entire unit until you find the position that provides the best reception.

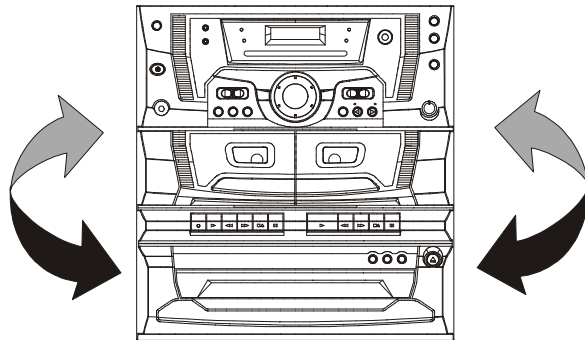

FM – For best FM reception, the FM lead wire antenna, located on the back of the set, should fully unwound and extended.

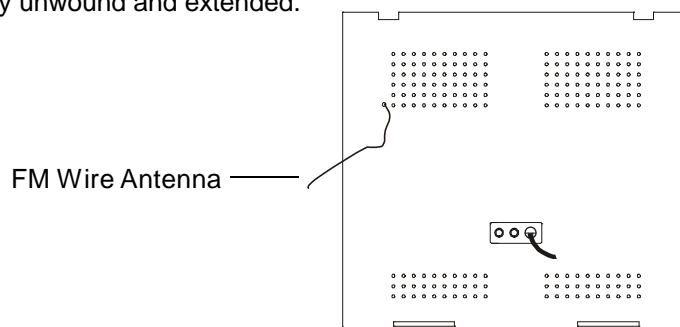

NOTE: If you are listening to a weak FM Stereo station you can usually improve the reception by pressing the FM MONO selector to the  ON position, however the sound will now be mono.

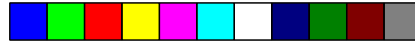



PLAYING COMPACT DISCS

IMPORTANT: This CD player can play normal CDs plus CD-R and CD-RW discs. However the playability of CD-R/RW discs may be affected by the type of software that was used in 'ripping' the tracks from the original discs and 'burning' the tracks onto the blank media. Playability may also be affected by the quality and condition of the blank media you use for recording. 100% compatibility cannot be guaranteed. This is not an indication of any problems with your player.

This system features a carousel type 3-CD changer which can provide you with up to 3 hours of uninterrupted music playback. You may load up to 3 CDs in the changer for continuous playback, or you may program up to 32 tracks among all 3 discs to be played back in the specific order you select.

LOADING THE DISCS

- 1.) Press the POWER  button to turn the system 'On'.
- 2.) Slide the FUNCTION selector to the CD position.
- 3.) Press the  Open/Close button to open the CD tray. When the tray opens two of the three CD pockets will be accessible to you. Load up to 2 CDs in the pockets making sure that the label side of the discs face up and that the discs are correctly centered in the pockets.
- 4.) Press the DISC SKIP button to rotate the CD tray and expose the 3rd CD pocket. Insert an additional disc in the open pocket if desired.
- 5.) Press the  Open/Close button to close the CD tray. The CD player will search for the first disc and the display will show the number of tracks and total playing time of that disc.

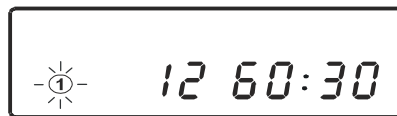

NOTES:

- Keep the CD disc tray closed when the system is not in use to prevent dirt and dust from entering the CD mechanism.
- Never place more than one CD in the same pocket of the CD tray. If two discs are loaded in the same pocket, the CD mechanism may jam and /or the discs themselves may be damaged.



TO BEGIN CD PLAYBACK

After you have loaded up the 3 CDs in the changer:

- 1.) Press the PLAY/PAUSE ►|| button to begin playback. The changer will search for the first available disc in the tray and will begin playback from Track 1 on the first disc. The number of the disc being played flashes on the display. It will continue playing until it has played all of the discs in the tray and then stops automatically.



NOTE: To begin playback from a specific disc, press the DISC SKIP button on front panel or DISC button on remote control to select the desired disc, and then press the PLAY/PAUSE ►|| button. Or, press the appropriate disc button (DISC 1, DISC 2, DISC 3.) on front panel for the disc you wish to start. Playback will begin on Track 1 of the selected disc. It stops automatically after finished playing all discs.

- 2.) Adjust the VOLUME and EQ control as desired.

- 3.) To temporarily stop playback, press the PLAY/PAUSE ►|| button again. The "||" indicator appears in the display. The disc continues to spin, but no sound is heard. Press the PLAY/PAUSE ►|| button once more to cancel pause and resume playback.



- 4.) To stop playback before the end of a disc, press the STOP ■ button.



IMPORTANT!!

If the disc is smudged or scratched it may skip or stop completely. This does not indicate a problem with the player. If this occurs, try playing another disc. If that disc plays properly, you may assume that the first disc is damaged and unplayable.

Simultaneous Play and Load System

This CD changer allows you to change two discs while a third disc continues playing. Press the CD drawer ▲ Open/Close button during playback. The drawer will open, allowing you to remove two discs and insert two new discs, while the third disc continues to play. After loading two new discs in the tray press the ▲ Open/Close button to close the drawer.

SKIP/SEARCH ►► / ◄◄ Buttons

To skip forward or back to the beginning of a particular track during playback, press the ►► or ◄◄ SKIP/SEARCH buttons repeatedly until the desired track number appears on the display. Playback will begin on the desired track.

To search for a particular passage on a track during playback, press and hold the ►► or ◄◄ SKIP/SEARCH buttons. The player will search rapidly forward or back. Release the buttons when you reach the desired point on the track and normal speed playback will resume at that point.



PROGRAMMED CD PLAYBACK

You can program the CD changer to play up to a total of 32 tracks on all 3 discs in any desired order.

NOTE: You can not program the CD changer during playback. If a disc is playing press the STOP ■ button first and then follow the instructions.

- 1.) Press the PROGRAM button once. The PROGRAM, EDIT indicators, program # 01, disc # 01 appears in the display.



- 2.) Press the DISC SKIP button or one of the three DISC buttons to select the disc which contains the first track you wish to program. Example: Disc 2.
- 3.) Press the ►► or ◀◀ buttons to select the first track you wish to program.

Example: Track 8.



- 4.) Press the PROGRAM button again to store the desired disc and track number into memory location Number 1. The display will change from Program Number "01" to Program Number "02".





- 5.) Use the DISC SKIP button or one of the three DISC buttons to select the disc containing the next track you wish to program. Example: Disc 3.
- 6.) Press the ►► or ◀◀ buttons to select the next track you wish to program. Example: Track 18.

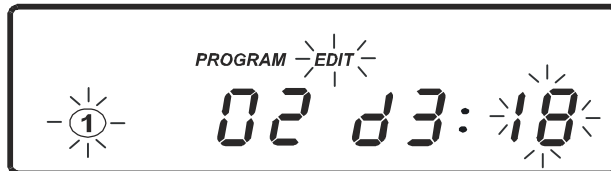

- 7.) Press the PROGRAM button again to store the desired disc and track into memory location Number "02".
 - Repeat the above procedure until you have stored up to 32 tracks in the program memory.
 - After all your desired tracks are programmed you may press the PROGRAM button to reconfirm that the information has been stored correctly.

- 8.) Press the PLAY/PAUSE ►► button to begin programmed playback. Playback will start at the first disc and track which you have programmed and will continue until all programmed discs and tracks (up to a total of 32) have been played.

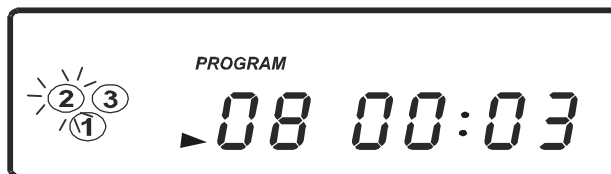

NOTE: If you press the ►► or ◀◀ buttons during programmed playback, the player will skip forward or back to the next track and disc which you have programmed, not the next track on the disc which is being played.

TO CLEAR THE PROGRAM MEMORY

If the disc is playing, press the STOP ■ button to stop the discs. Then press the STOP ■ button again, switch to other function, or turn power "Off" to clear the program memory,



REPEAT Playback (On Front Panel Only)

This system has a four-way repeat function which allows you to continuously repeat one track, one disc, all discs, or all of the tracks which you have programmed.

One Track Repeat

- 1.) Press the REPEAT button until the "REPEAT 1" Indicator appears in the CD display.
- 2.) Use the ►► or ◀◀ buttons (and the "DISC SKIP" button, if necessary) to select the exact track that you wish to repeat.
- 3.) Press the PLAY/PAUSE ►|| button to begin one track repeat. The selected track will begin playing. It will repeat continuously until repeat function is cancelled.



One Disc Repeat

- 1.) Press the REPEAT button until the "REPEAT 1 DISC" Indicator appears on the display. Press the DISC SKIP button to select the disc you wish to play.
- 2.) Press the PLAY/PAUSE ►|| button. The selected disc will begin to play starting with Track 1. When the final track on the disc has been played, it will automatically begin playing again starting with Track 1.



- 3.) To cancel One Disc Repeat playback, press the REPEAT button until the indicator no longer appears in the Display.



All Discs Repeat

- 1.) Press the REPEAT button until the "REPEAT ALL DISC" Indicator appears in the Display.
- 2.) Press the PLAY/PAUSE ►|| button, the changer will begin playing the first track of the disc which is in the play position. It will continue until it has played all tracks on all discs in the changer. When it has played the last track on the last disc it will begin playing again with the first track on the first disc. This All Discs Repeat will continue indefinitely.



- 3.) To cancel All Discs Repeat playback, press the REPEAT button until the Indicator no longer appears in the Display.

Programmed Repeat Playback

You can use the Program and Repeat features together to continuously repeat a programmed sequence of tracks. First, program the desired tracks according to Steps 1 through 7 in previous page. When Programmed Playback begins press the REPEAT button until the "REPEAT ALL DISC" Indicator appears in display. All the tracks in your programmed sequence will be repeated continuously.



To cancel Programmed Repeat Playback press the STOP ■ button until both the PROGRAM and REPEAT Indicators go 'Off'.



INTRO Scan (On Front Panel Only)

The Intro Scan feature lets you hear a 10 second introduction of each track on each disc. This feature is useful if you are trying to find a particular song but you do not know the title.

- 1.) Press the INTRO button once. The "INTRO" and "ALL DISC" Indicators appear in the display. The CD player will begin playing Track 1 of the disc in the play position. After 10 seconds it will advance to Track 2, and so on, until it has played the first 10 seconds of every track. Then it continues to next disc until all discs has been played.



- 2.) To cancel Intro Scan and resume normal playback, press the INTRO button again. The INTRO Indicator disappears.



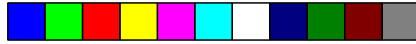

TURNTABLE

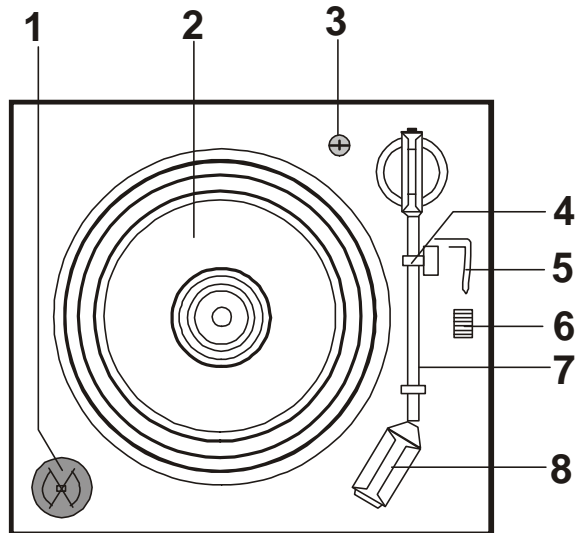

- 1.) 45 rpm LP Record Adapter.
- 2.) Platter.
- 3.) Transit Screw.
- 4.) Tone Arm Clamp.
- 5.) Tone Arm Lever (Cue Control).
- 6.) 33/45 rpm Speed Slide Switch.
- 7.) Tone Arm.
- 8.) Stylus and Protective Cover.

IMPORTANT!!

- **TO PROTECT THE TURNTABLE FROM DAMAGE DURING TRANSPORTATION, A SILVER TRANSIT SCREW IS LOCATED AT THE UPPER HAND CORNER OF THE TURNTABLE PLATFORM.**
- **BEFORE PLAYING, PLEASE USE A SCREWDRIVER TO TURN THE TRANSIT SCREW IN CLOCKWISE DIRECTION (SCREW GOING DOWN) COMPLETELY TO UNLOCK THE TURNTABLE.**
- **TO LOCK THE TURNTABLE AGAIN FOR TRANSPORTATION, PLEASE TURN THE SCREW IN COUNTER-CLOCKWISE DIRECTION.**



STEREO PHONOGRAPH OPERATION

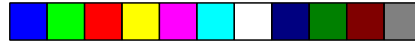

- 1.) Raise the turntable dust cover.
- 2.) Release the Tone Arm Clamp, and remove the stylus protector.
- 3.) Slide FUNCTION selector to PHONO position.
- 4.) Place a record on the turntable, over the central spindle.
- 5.) Place the 45 rpm adapter over the central spindle when playing 45 rpm records. Set the Speed Selector Switch to 33 or 45 rpm according to the record you are playing.
- 6.) Move the Tonearm to the beginning of the record, or to the start of a particular track. Gently lower the Tonearm onto the record to start playing. Adjust the Volume and Equalizer setting as desired.
- 7.) To pause during playback use the Cue Control lever to lift the Tone Arm from the record. To resume playback gently move the Cue Control forward to lower the Tone Arm back on to the record.
- 8.) At the end of the record the Tone Arm will automatically return to its rest and the turntable stops, however the system power is still 'On'.
- 9.) If you are finished playing records press the POWER  button to shut the system 'Off', or use the FUNCTION selector switch to select a different function.

NOTE: Do not turn or stop the turntable manually. Moving or jarring the Turntable without securing the Tone Arm clamp could result in damage to the Tone Arm.







CASSETTE OPERATION

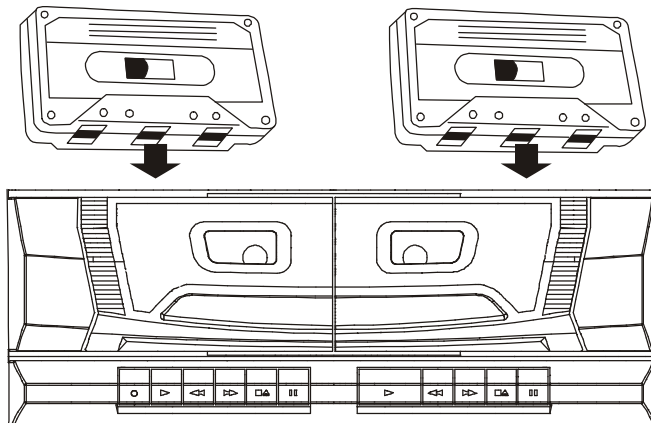



PLAYING CASSETTE TAPES



- 1.) Press the POWER  button to turn the system 'On'.
- 2.) Slide the FUNCTION selector to TAPE position to select the Tape mode.
- 3.) Press the Stop/Eject  key of either deck A or deck B to open the cassette door.
- 4.) Insert a prerecorded cassette into the slots on the door with the exposed tape facing down and the full reel on the left side. Close cassette door.



- 5.) Press the Play  key to begin playback.
- 6.) Adjust the VOLUME and EQ controls as desired.
- 7.) When the tape ends the Automatic Stop System releases the Play  key and shuts off the tape motor. Press the Stop/Eject  key to open the cassette door and remove your tape. To stop the tape before it ends press the Stop/Eject  key at any time.

Fast Forward and Rewind Controls

Press  or  key to advance or rewind the tape rapidly. When you reach the desired portion, or the end of the tape, press the Play  key to resume normal playback, or press the Stop/Eject  key to shut off the tape motor.

Note: the Automatic Stop System does not function in the fast forward  or rewind  modes.



Pause || Control

Press the **||** key to stop the tape temporarily. The tape movement stops but the tape motors continue to run. Press the **||** key again to cancel pause mode and resume normal playback.

CONTINUOUS PLAYBACK OF TWO CASSETTES

- 1.) Insert prerecorded tapes into both cassette compartments with the tape you want to play first in DECK B.
- 2.) Press the Play ► key of DECK B to begin playback.
- 3.) Press Pause **||** key and then Play ► key of DECK A.
- 4.) When the tape in DECK B ends, it stops and the Pause **||** key of DECK A will be released automatically to begin playback on DECK A.



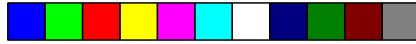

MAKING A TAPE RECORDING

This cassette recorder features an Automatic Recording Volume Level Control System that prevents overloaded or distorted recordings. You can change the volume level as often as you like during the recording process. It will not have any effect on the volume level of the recording itself.

- 1.) Insert a good quality blank tape into DECK A with the exposed tape facing down and the full reel on the left side. Close DECK A door.

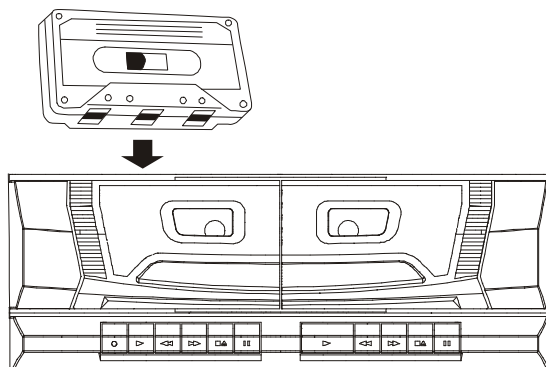

- 2.) Select the source you wish to record:

PHONO, TUNER, CD or TAPE (Tape Dubbing) and operate that source as you normally would.

- 3.) Press the Record ● key on DECK A to begin recording.

NOTE: When recording from Cassette B to Cassette A you can press the HI-SPEED DUBBING button to "ON ■" to select high speed dubbing which allows you to make recordings at approximately twice the normal recording speed.

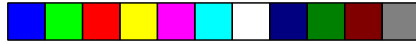

CARE AND MAINTENANCE

ABOUT CASSETTE TAPES

Whenever you record on a cassette any previously recorded material is erased as the new material is recorded. To prevent you from accidentally erasing material which you wish to save, blank cassettes are equipped with erase prevention tabs for each side of the tape. If the erase prevention tab for side A is removed, you cannot accidentally record on side A. The Record ● key cannot be depressed if the erase prevention tab on the cassette has been removed.

To prevent accidental erasing on side A of a cassette use a small screw driver or similar tool to break off the erase prevention tab for side A. This prevents the record key from locking.

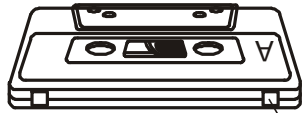

TAB FOR SIDE A.

BREAK OFF TO PREVENT RECORDING

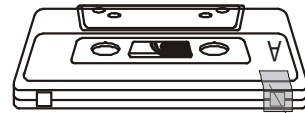

COVER OPENING WITH TAPE
IN ORDER TO RECORD AGAIN.

If later you do wish to record on side A of the cassette, cover the tab opening with a piece of cellophane tape. This will allow the Record ● key to function again.

CASSETTE CARE

Two common causes of trouble experienced when using cassettes are:

- 1.) Tape jamming — Leading to uneven speed in playback, and
- 2.) Tape tangling — Where the tape wraps itself around vital parts of the mechanism.

To reduce the likelihood of these problems occurring, the following precautions should be observed:

- Check that there are no loose layers of tape visible through the cassette center window (see Fig. 1). Take up any loose layers, using a pencil or hexagonal barrelled ballpoint pen, before inserting the cassette into the machine (see Fig. 2).

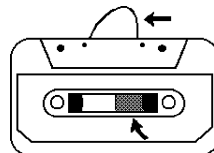

Fig.1



- If the cassette feels “tight” while performing operation shown (see Fig. 2), the tape may be jamming due to “ridges” formed in the winding of the tape (visible through the center window). These may be removed, in most cases, by fast winding of the cassette from one end to the other and back again.

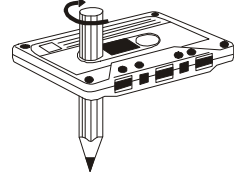



Fig. 2

- Use only well-known brands of tape. Avoid use of C-120 cassettes.

Furthermore, do not expose cassettes to direct sunlight, dust or oil, and do not touch the tape surfaces.

HEAD CLEANING

The tape heads, pinch roller and capstan require periodic cleaning. This removes particles of the metal oxide coating that wear off the tape and accumulate on these parts and impair performance. Switch off the power, press the Stop/Eject  key to open the cassette door, and press the Play  key. Clean the tape heads, pinch roller and capstan with a soft cloth or cotton pad dampened in isopropyl alcohol or special tape head cleaner.

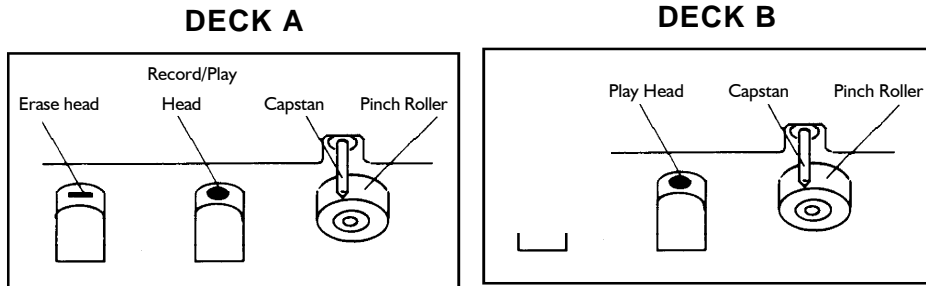

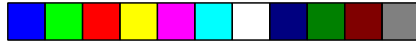

COMPACT DISC CARE

- To remove a disc from its storage case, press down on the center of the case and lift the disc out, holding it carefully by the edges.



- Fingerprints and dust should be carefully wiped off the disc's recorded surface with a soft cloth. Unlike conventional records, compact discs have no grooves to collect dust and microscopic debris, so gently wiping with a soft cloth should remove most particles. Wipe in a straight line from the inside to the outside of the disc. Small dust particles and light stains will have absolutely no effect on reproduction quality.

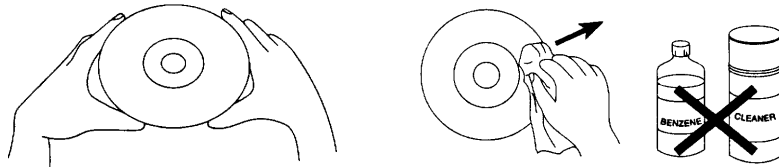

- Clean the disc periodically with a soft, lint-free, dry cloth. Never use detergents or abrasive cleaners to clean the disc. If necessary, use a CD cleaning kit.
- Never write on or affix labels to the surface of compact discs.

CARE OF THE CABINETS

- If the cabinets become dusty wipe them with a soft dry dust cloth. Do not use any wax or polish sprays on the cabinets.
- If the front panel becomes dirty or smudged with fingerprints it may be cleaned with a soft cloth slightly dampened with a mild soap and water solution. Never use abrasive cloths or polishes as these will mar the finish of your unit.

Caution: *Never allow any water or other liquids to get inside the unit while cleaning.*

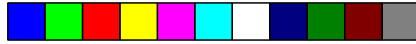

TO FIND THE LOCATION AND PHONE
NUMBER OF YOUR NEAREST SERVICE
CENTER PERMITTED TO PERFORM
WARRANTY...

CALL TOLL FREE: 1-800-695-0098

FOR ADDITIONAL SET-UP OR OPERATING ASSISTANCE
PLEASE CALL:
1-800-898-9020

FOR CUSTOMER SERVICE, PLEASE WRITE TO:
Emerson Radio Corp.,
Consumer Affairs Dept.,
5101 Statesman Drive,
Irving, TX 75063.



LIMITED WARRANTY

Emerson Radio Corp. warrants manufacturing defects in original material, including original parts and workmanship, under normal use and conditions, for a period of ninety (90) days from the date of original purchase in the U.S. With your dated proof of purchase, we will provide repair service at no charge for labor and parts at an authorized Depot Repair Facility, or replace the product in our discretion. For repair or replacement, pack your unit in a padded box, enclose your check or money order payable to Emerson Radio Corp. in the amount of \$9.00 (not required by California residents) to cover shipping and handling costs, and enclose a copy of your proof of purchase. Send your unit to:

Emerson Radio Corp.,
5101 Statesman Drive,
Irving, TX 75063.

This warranty does not cover damage from negligence, misuse, abuse, accident, failure to follow operating instructions, commercial use, rental, repairs by an unauthorized facility, or products purchased, used, serviced or damaged outside of the United States.

THIS WARRANTY GIVES YOU SPECIFIC LEGAL RIGHTS, AND YOU MAY ALSO HAVE OTHER RIGHTS WHICH VARY FROM STATE TO STATE.

AU898M

The serial number of your unit is located on a label on the back panel. Please take a moment to locate the serial number of your unit and write it in the space provided below. You may be asked to provide this number when calling to request customer service.

Model Number: MS9903TT

Serial Number: _____



EMERSON
Part No. 16-2910
508-03

Printed in China



Free Manuals Download Website

<http://myh66.com>

<http://usermanuals.us>

<http://www.somanuals.com>

<http://www.4manuals.cc>

<http://www.manual-lib.com>

<http://www.404manual.com>

<http://www.luxmanual.com>

<http://aubethermostatmanual.com>

Golf course search by state

<http://golfingnear.com>

Email search by domain

<http://emailbydomain.com>

Auto manuals search

<http://auto.somanuals.com>

TV manuals search

<http://tv.somanuals.com>