

Emerson®

***PORTABLE CD PLAYER WITH
AM/FM DIGITAL TUNER AND
CASSETTE RECORDER***

OWNER'S MANUAL

PD6870RD - Red

PD6870CH - Champagne Gold

Visit our web site at www.emersonradio.com

WARNING

TO PREVENT FIRE OR SHOCK HAZARD, DO NOT USE THIS PLUG WITH AN EXTENSION CORD, RECEPTACLE OR OTHER OUTLET UNLESS THE BLADES CAN BE FULLY INSERTED TO PREVENT BLADE EXPOSURE. TO PREVENT FIRE OR SHOCK HAZARD, DO NOT EXPOSE THIS APPLIANCE TO RAIN OR MOISTURE.



The lightning flash with arrowhead symbol, within an equilateral triangle is intended to alert the user to the presence of uninsulated 'dangerous voltage' within the product's enclosure that may be of sufficient magnitude to constitute a risk of electric shock to persons.

CAUTION

RISK OF ELECTRIC SHOCK
DO NOT OPEN

CAUTION: TO REDUCE THE RISK OF ELECTRIC SHOCK DO NOT REMOVE COVER (OR BACK), NO USER SERVICEABLE PARTS INSIDE. REFER SERVICING TO QUALIFIED SERVICE PERSONNEL.



The exclamation point within an equilateral triangle is intended to alert the user to the presence of important operating and maintenance (servicing) instructions in the literature accompanying the appliance.

IMPORTANT SAFETY INSTRUCTIONS

1. Read these instructions.
2. Keep these instructions.
3. Heed all warnings.
4. Follow all instructions.
5. Do not use this apparatus near water.
6. Clean only with dry cloth.
7. Do not block any ventilation openings. Install in accordance with the manufacturer's instructions.
8. Do not install near any heat sources such as radiators, heat registers, stoves, or other apparatus (including amplifiers) that produce heat.
9. Do not defeat the safety purpose of the polarized or grounding-type plug. A polarized plug has two blades with one wider than the other. A grounding type plug has two blades and a third grounding prong. The wide blade or the third prong are provided for your safety. If the provided plug does not fit into your outlet, consult an electrician for replacement of the obsolete outlet.
10. Protect the power cord from being walked on or pinched particularly at plugs, convenience receptacles, and the point where they exit from the apparatus.
11. Only use attachments / accessories specified by the manufacturer.
12. Unplug this apparatus during lightning storms or when unused for long periods of time.
13. Refer all servicing to qualified service personnel. Servicing is required when the apparatus has been damaged in any way, such as power-supply cord or plug is damaged, liquid has been spilled or objects have fallen into the apparatus, the apparatus has been exposed to rain or moisture, does not operate normally, has changed its performance, or has been dropped.
14. This appliance shall not be exposed to dripping or splashing water and that no object filled with liquids such as vases shall be placed on the apparatus.
15. Do not overload wall outlet. Use only power source as indicated.
16. Use replacement parts as specified by the manufacturer.
17. The product may be mounted to a wall only if recommended by the manufacturer.
18. Upon completion of any service or repairs to this product, ask the service technician to perform safety checks.

SAFETY INSTRUCTIONS

INFORMATION:

This equipment has been tested and found to comply with the limits for a Class B digital device, pursuant to Part 15 of the FCC Rules. These limits are designed to provide reasonable protection against harmful interference in a residential installation. This equipment generates, uses, and can radiate radio frequency energy and, if not installed and used in accordance with the instructions, may cause harmful interference to radio communications. However, there is no guarantee that interference will not occur in a particular installation. If this equipment does cause harmful interference to radio or television reception, which can be determined by turning the equipment off and on, the user is encouraged to try to correct the interference by one or more of the following measures:

- Reorient or relocate the receiving antenna.
- Increase the separation between the equipment and receiver.
- Connect the equipment into an outlet on a circuit different from that to which the receiver is connected.
- Consult the dealer or an experienced radio/TV technician for help.

LASER SAFETY: This unit employs a laser. Only qualified service personnel should attempt to service this device due to possible eye injury.

CAUTION: USE OF CONTROLS, ADJUSTMENTS OR PERFORMANCE OF PROCEDURES OTHER THAN THOSE SPECIFIED HEREIN MAY RESULT IN HAZARDOUS RADIATION EXPOSURE.

WARNING: DO NOT EXPOSE THIS APPLIANCE TO RAIN OR MOISTURE.

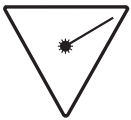

DANGER:

Invisible and hazardous laser radiation when open and interlock failed or defeated. Avoid direct exposure to beam.

FCC WARNING:

This equipment may generate or use radio frequency energy. Changes or modifications to this equipment may cause harmful interference unless the modifications are expressly approved in the instruction manual. The user could lose the authority to operate this equipment if an unauthorized change or modification is made.

Thank you for purchasing this Emerson portable audio system. This uniquely designed product has a built-in CD player with programmable memory and repeat playback. It also features a digital tuning AM/FM stereo radio and a stereo cassette player/recorder that will allow you to make direct recordings from either the radio or the CD player.

We are sure that this unit will provide you with many years of exceptional performance with a minimum of care and maintenance. Please review the contents of this instruction manual completely and carefully before operating your unit, to make sure that you understand all functions and operations and get the maximum benefit out of all the great features included in this product. If you should encounter any problems with the set-up or operation of this product, please contact the Emerson Radio Corporation Customer Service hot-line, toll free, at 1-800-898-9020.

The serial number of your unit can be found on a label on the bottom of the cabinet. We suggest that you record the serial number in the space provided below in case this information is ever needed at a future date.

Model Number: PD6870RD/PD6870CH

Serial Number: _____

PREPARATION FOR USE

Unpacking and Setup

- Carefully remove the unit from the display carton and remove all packing material from the unit itself.
- Remove any descriptive labels that may be found on either the front or top cabinet of the unit. Do not remove any labels located on either the back or bottom cabinet of the unit.
- The detachable AC power cord is packed in the carton separately from the unit. Make sure that the AC power cord is not accidentally discarded with the carton or packing material.
- Press the CD Door OPEN/CLOSE area to open the CD compartment door. There is a white card in the CD compartment which is intended to prevent the CD pickup from moving during shipment of the product. Remove this card from the CD compartment before use.

Power Sources

This portable audio system is designed to operate on either 120V AC 60Hz house current or 12V DC, using eight (8) 'C' batteries, not included. Attempting to operate this unit from any other power source may cause damage to the unit, which is not covered by your warranty.

AC Operation

Unwind the AC power cord and extend it to its full length. Insert the small end of the AC power cord into the AC socket on the back cabinet of the unit. Insert the other end of the AC power cord into any convenient 120V 60Hz household outlet.

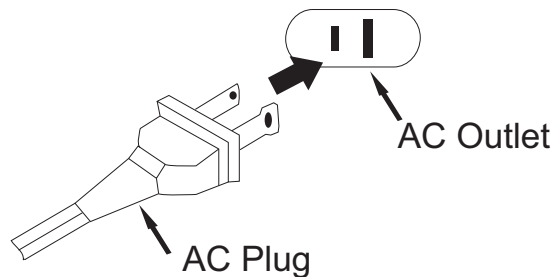

Please note that this unit is equipped with a polarized AC plug which has one blade wider than the other. This is a safety feature to reduce the likelihood of electric shock. This polarized AC plug will only fit in a polarized AC outlet. If you find that you cannot insert this plug into your outlet, you may have an obsolete non-polarized outlet. Please do not try to defeat this safety feature by using a non-polarized adapter or by filing the wider blade to make it fit into your outlet. If this plug does not fit into your outlet, you should contact a qualified licensed electrician to replace your obsolete outlet.

PREPARATION FOR USE (CONTINUED)

Battery Operation

The battery compartment is located on the rear of the unit.

- Remove the battery compartment door by pressing down on the two arrow marks and sliding the door in the direction of the arrows.
- Insert eight (8) 'C' size batteries into the battery compartment as shown below. Be sure to observe the polarity markings which are engraved inside the battery compartment. If the batteries are inserted incorrectly, the unit will not operate.
- Replace the battery compartment door.

NOTE: The AC power cord must be disconnected from the AC socket on the back of the unit in order for the unit to operate on battery power.

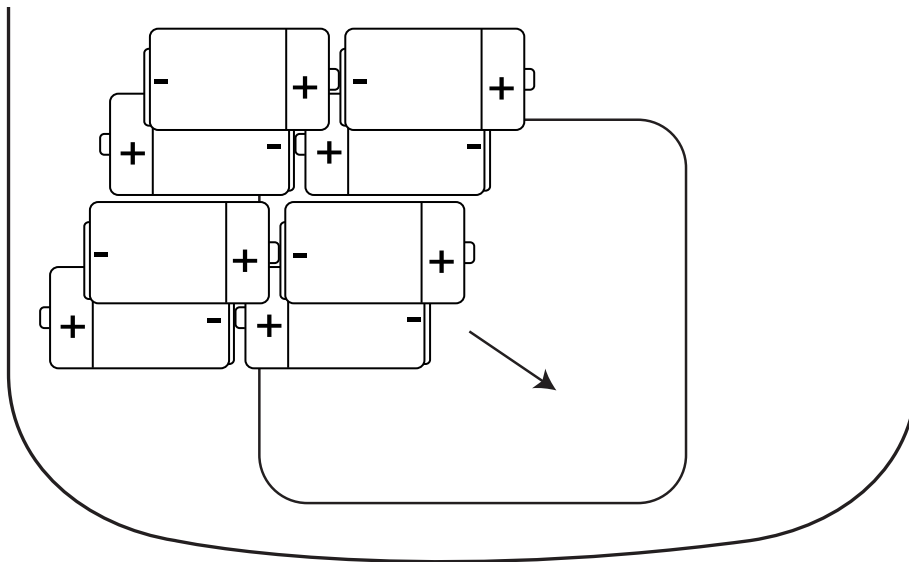

BATTERY PRECAUTIONS

Follow these precautions when using batteries in this device:

1. Use only the size and type of batteries specified.
2. Be sure to follow the correct polarity when installing the batteries as indicated in the battery compartment. Reversed batteries may cause damage to the device.
3. Do not mix different types of batteries together (e.g. Alkaline and Carbon-zinc) or old batteries with fresh ones.
4. If the device is not to be used for a long period of time, remove the batteries to prevent damage or injury from possible battery leakage.
5. Do not try to recharge batteries not intended to be recharged; they can overheat and rupture. (Follow battery manufacturer's directions.)

LOCATION OF CONTROLS AND INDICATORS

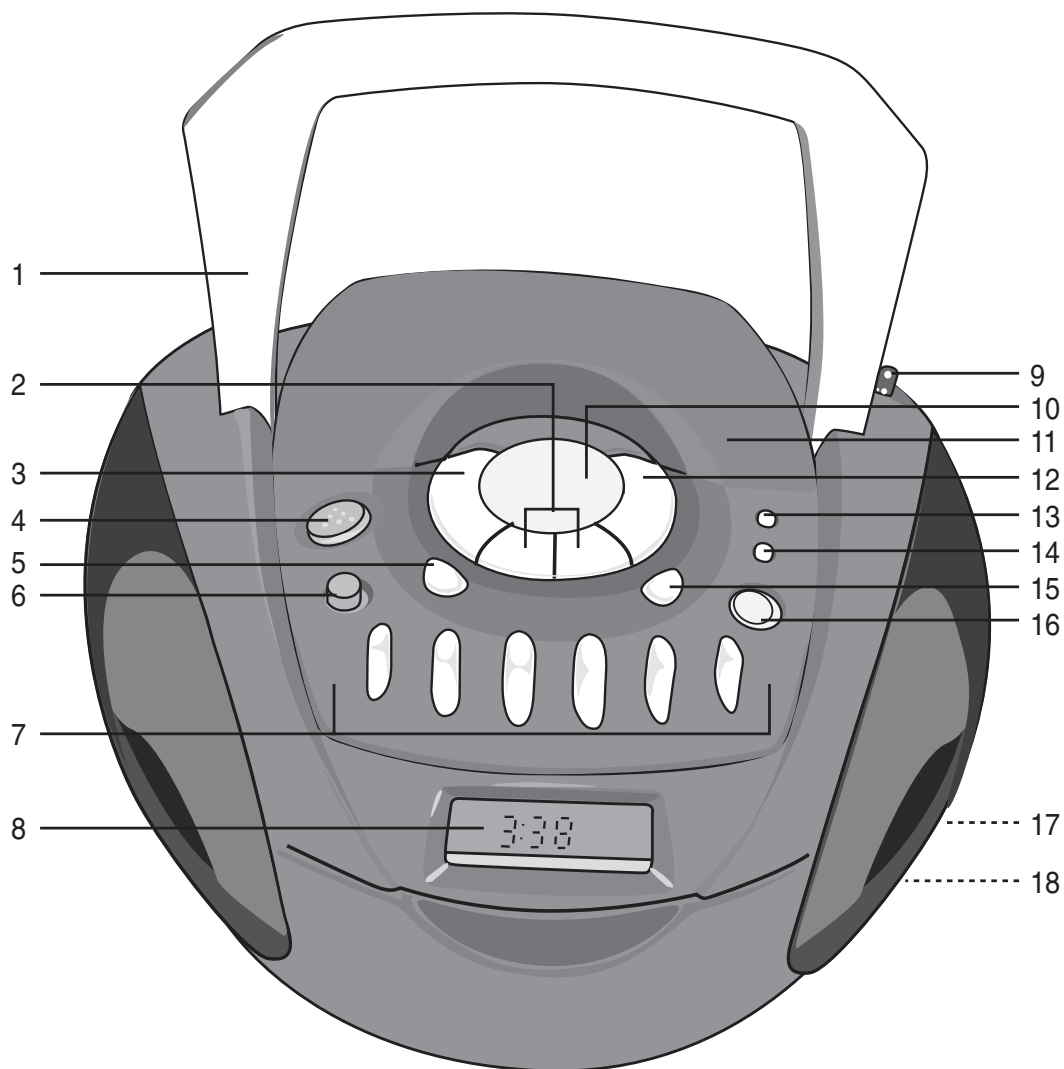

- | | |
|---|--|
| 1. Carrying Handle | PLAY (◀) |
| 2. Tuning CD Skip/Search ▶▶(+)/◀◀ (-) Buttons | RECORD (●) |
| 3. CD STOP(■) Button | 8. Display |
| 4. POWER Button | 9. Antenna |
| 5. PROGRAM/MEMORY/CLOCK SET Button | 10. VOLUME Control |
| 6. BASS BOOST Button | 11. CD Door OPEN/CLOSE Area |
| 7. Cassette Buttons:
PAUSE ()
STOP/EJECT (■▲)
FAST FORWARD (◀◀)
REWIND (▶▶) | 12. CD PLAY/PAUSE (▶) Button |
| | 13. BAND Button |
| | 14. LIGHT Button |
| | 15. MODE/MEMORY UP Button |
| | 16. FUNCTION Button |
| | 17. AC Jack (Rear of Unit) |
| | 18. Battery Compartment (Bottom of Unit) |

SETTING THE CLOCK

SETTING THE CLOCK

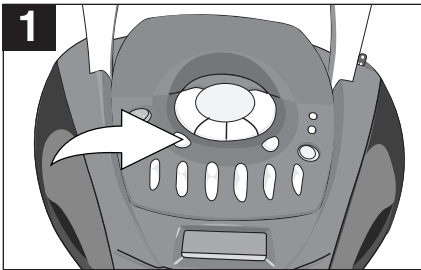

With the power off, press and release the PROGRAM/MEMORY/CLOCK SET button; "24H" or "12H" will blink in the display.

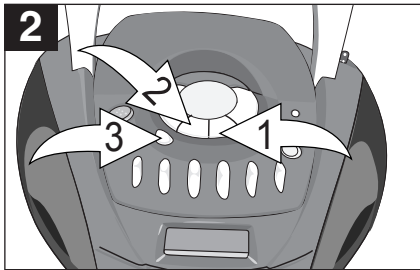

Press the CD Skip/Search (▶▶) ❶ or (◀◀) ❷ button to select the 12 hour or 24 hour mode (see note below), then press the PROGRAM/MEMORY/CLOCK SET button ❸ again; the hour digits will blink.

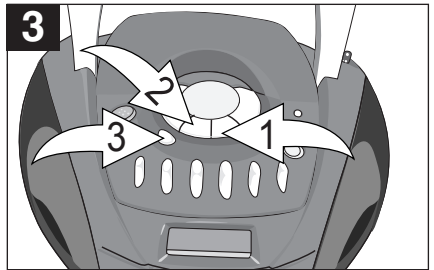

Press the CD Skip/Search (▶▶) ❶ or (◀◀) ❷ button to set the current hour, then press the PROGRAM/MEMORY/CLOCK SET button ❸ again; the minute digits will blink.

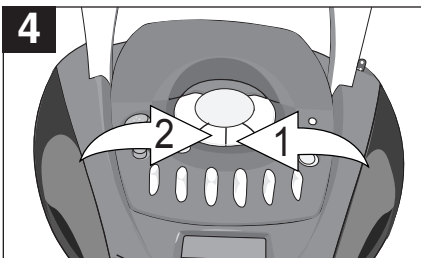

Press the CD Skip/Search (▶▶) ❶ or (◀◀) ❷ button to set the current minute.

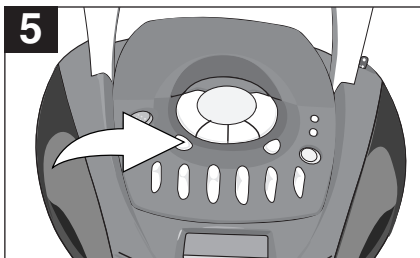

Press the PROGRAM/MEMORY/CLOCK SET button and the time will be set.

NOTE: In the 12 hour mode the display will show AM and PM indicators. In the 24 hour mode there are no AM or PM indicators. "1:00PM" is displayed as "13:00", "6:00PM" is displayed as "18:00" and 12 midnight is displayed as "0:00". The 12 hour mode is used in the USA and Canada. The 24 hour mode is used in Europe, Asia and other countries.

LIGHT BUTTON

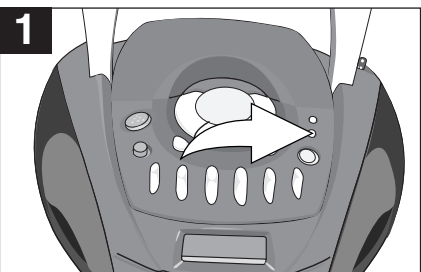

With the power on, press the LIGHT button to temporarily illuminate the display.

OPERATING INSTRUCTIONS

LISTENING TO THE RADIO

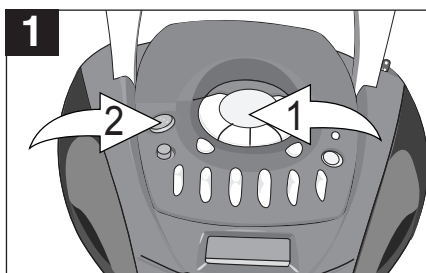

Set the VOLUME control ❶ to a low setting. Press the POWER button ❷ to turn the unit on.

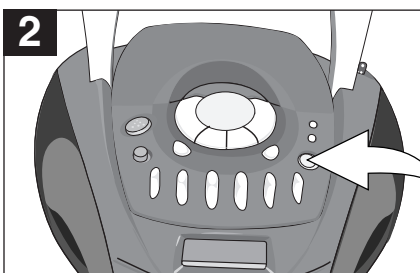

Press the FUNCTION button until the tuner ("AM" or "FM" and a frequency) appears in the display.

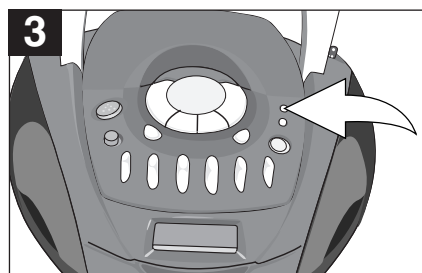

Press the BAND button to select AM or FM.

NOTE: If you select the FM band, be sure to raise the FM Rod Antenna and extend it to its full length.

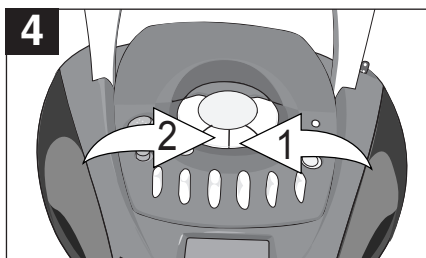

Press the Tuning/CD Skip/Search ►► ❶ or ◄◄ ❷ button to select a station (see Tuning note below).

NOTE: If the FM band is selected and you have tuned to an FM Stereo station, the FM Stereo indicator will light in the display.

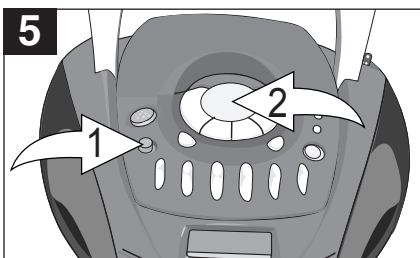

Adjust the BASS BOOST button ❶ and VOLUME control ❷ as desired.

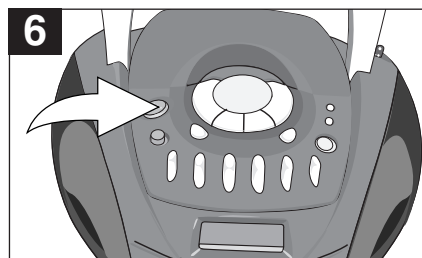

When you have finished listening, press the POWER button to turn the unit off.

TUNING:

MANUAL TUNING: Repeatedly press the Tuning/CD Skip/Search ►► or ◄◄ to manually advance the frequency in the display up or down until the desired frequency appears.

AUTOMATIC TUNING: Press and hold the Tuning/CD Skip/Search ►► or ◄◄ until the frequency in the display starts to scan, and then release the button; the tuner will search and then stop on the next strong station it finds. Repeat this procedure until the desired frequency appears in the display.

Hints for Better Reception

FM - Make sure that the telescopic FM Rod Antenna is raised and extended to its full length. You may have to vary the direction of the antenna to find the strongest signal for each FM station.

AM - The AM ferrite bar antenna is located inside the unit. It may be necessary to turn the unit slightly so that the internal antenna is pointing in the direction of the AM transmitter. You may have to experiment to find the position that provides the strongest reception for each of your favorite AM stations.

OPERATING INSTRUCTIONS (CONTINUED)

SETTING RADIO PRESETS

This unit can preset 10 AM and 10 FM radio stations for convenient recall.

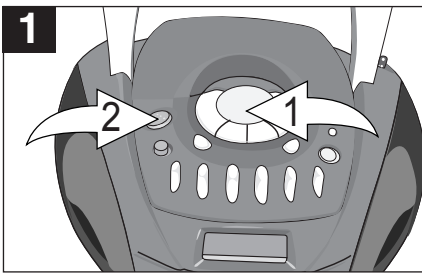

Set the VOLUME control ❶ to a low setting. Press the POWER button ❷ to turn the unit on.

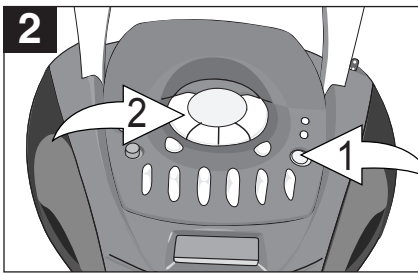

Press the FUNCTION button ❶ until tuner ("AM" or "FM" and a frequency) appears in the display. Press the BAND button ❷ to the desired band - FM or AM.

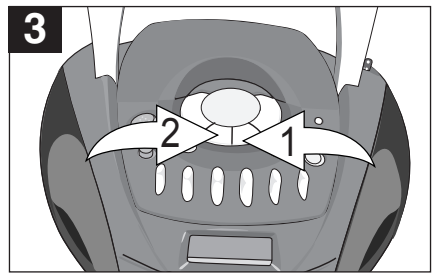

Use the CD Skip/Search (▶▶) ❶ or (◀◀) ❷ button to select a station.

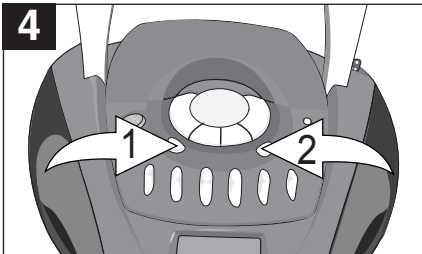

Press the PROGRAM/MEMORY/CLOCK SET button ❶. Within 9 seconds, press the MODE/MEMORY UP button ❷ until the desired memory number appears on the display.

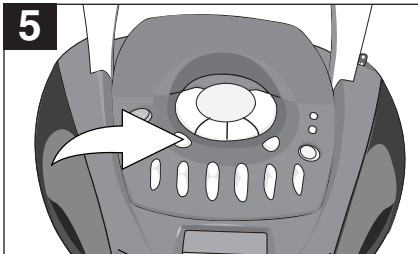

Press the PROGRAM/MEMORY/CLOCK SET button again to set the station in the selected memory.

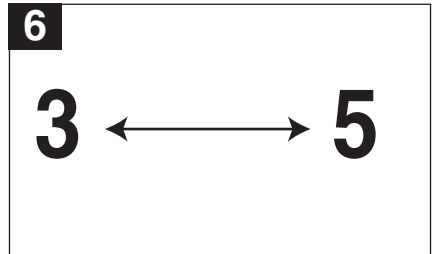

Repeat steps 3 through 5 to program up to 10 stations in each band, if desired.

In case the main power supply is interrupted, the memory presets will be erased.

RECALLING RADIO PRESETS



Follow steps 1 and 2 above.

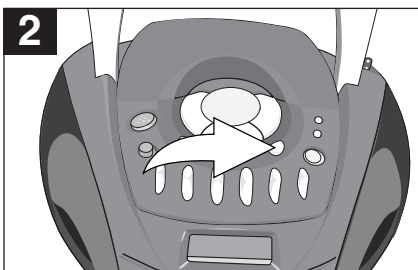

Press the MODE/MEMORY UP button to select a preset; the station will automatically be tuned in.

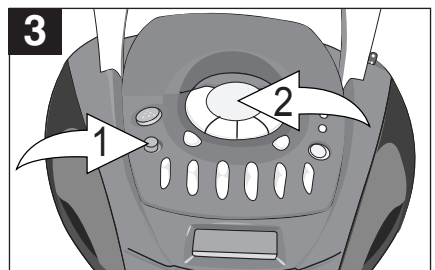

Adjust the BASS BOOST button ❶ and VOLUME control ❷ as desired.

OPERATING INSTRUCTIONS (CONTINUED)

PLAYING COMPACT DISCS

NORMAL PLAYBACK

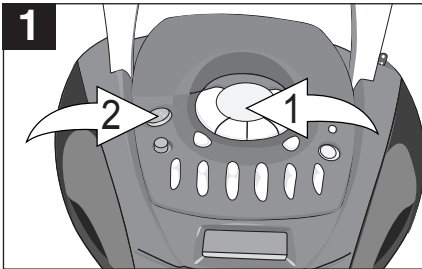

Set the VOLUME control ❶ to a low setting. Press the POWER button ❷ to turn the unit on.

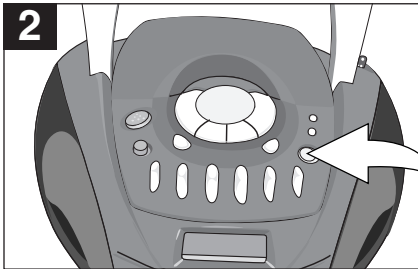

Press the FUNCTION button to select CD.

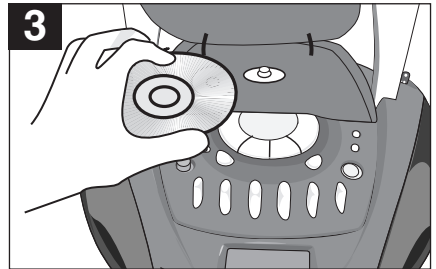

Press the CD Door OPEN/CLOSE area to open the CD compartment door. Place a CD on the center spindle, with the printed label side facing up. Close the CD compartment door.

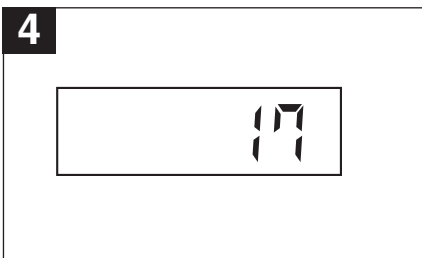

The CD player will read the table of contents on the disc and the total number of tracks on the disc will appear in the display.

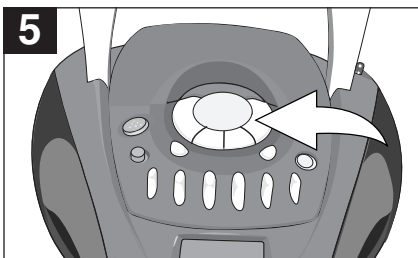

Press the CD PLAY/PAUSE (▶||) button to begin playback on Track 1.

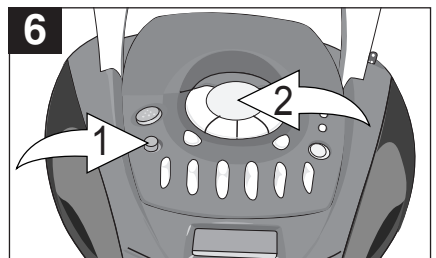

Adjust the BASS BOOST button ❶ and VOLUME control ❷ as desired. Playback will continue until all the tracks on the disc have been played.

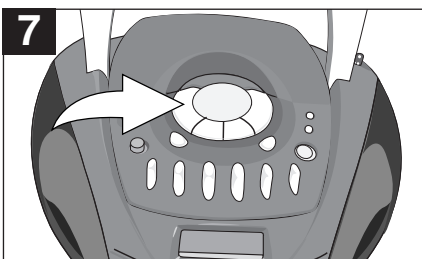

To stop playback before the disc ends, press the CD STOP (■) button. The disc will stop and the display will show the total number of tracks and playing time on the disc.

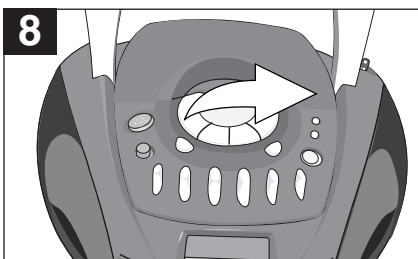

After the last track has been played, the disc stops automatically and the display shows the total number of tracks on the disc. If you are finished listening, press the CD Door OPEN/CLOSE area to open the CD Compartment door.

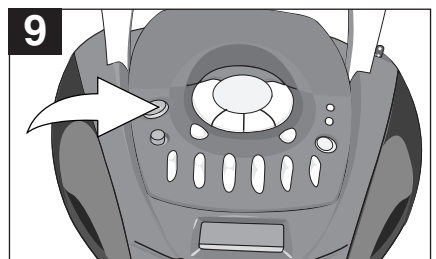

Remove your disc, close the CD Compartment door and press the POWER button to turn the unit off.

OPERATING INSTRUCTIONS (CONTINUED)

CD PAUSE CONTROL

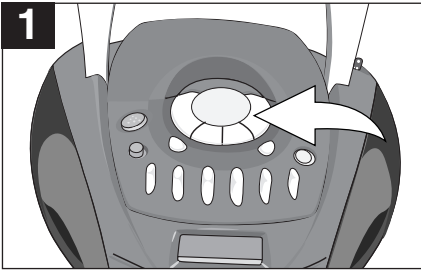

1 During CD playback, if you wish to pause the disc momentarily, press the CD PLAY/PAUSE (▶||) button again. Playback stops but the disc continues to spin and the Play indicator will blink.

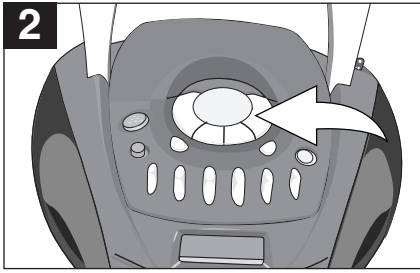

2 Press the CD PLAY/PAUSE (▶||) button again to release pause and resume normal CD playback.

TO BEGIN PLAYBACK FROM A SPECIFIC TRACK

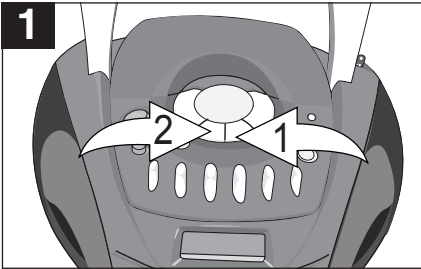

1 After you insert the disc into the CD player and the total number of tracks appear on the display, you may press either the CD Skip/Search (▶|1) ❶ or (|◀) ❷ button to select a specific track for playback.

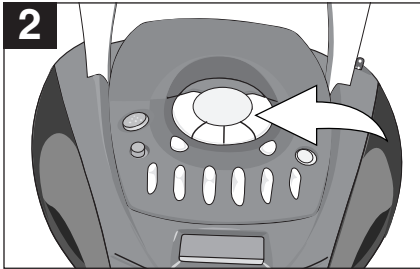

2 When the desired track number appears in the display, press the CD PLAY/PAUSE (▶||) button. Playback will begin on the track you selected.

FORWARD/REVERSE SKIP TRACK AND HIGH-SPEED MUSIC SEARCH (▶|/|◀)

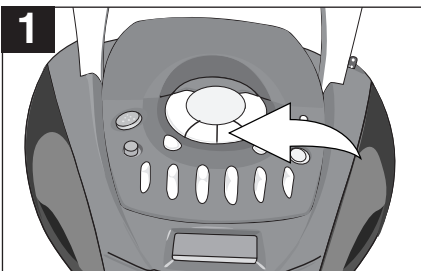

1 During playback, press the CD Skip/Search (▶|) button once to advance the player to the beginning of the next track. Press the CD Skip/Search (▶|) button repeatedly to advance the player to higher number tracks.

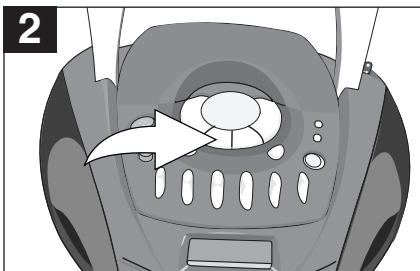

2 During playback, press the CD Skip/Search (|◀) button once to move the player back to the beginning of the current track. Press the CD Skip/Search (|◀) button repeatedly to move the player back to lower numbered tracks.

3 During playback, depress and hold either the CD Skip/Search (▶|) or (|◀) button to move the player forward or backward within a track to locate a specific musical passage. The player will move forward or backward at high speed as long as the button is depressed. When you release the CD Skip/Search (▶|) or (|◀) button, normal playback will resume at that point.

OPERATING INSTRUCTIONS (CONTINUED)

REPEAT/RANDOM PLAYBACK

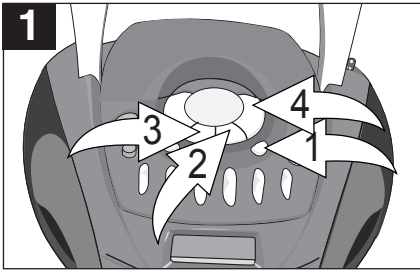

1 To repeat a single track, press the MODE/MEMORY UP button **1** once; the Repeat indicator will blink in the display. Press the CD Skip/Search (**2**) or (**3**) button **2** or (**3**) to select the specific track that you wish to repeat. When the desired track number appears in the display, press the CD PLAY/PAUSE (**4**) button **4** to begin playback. The specific track you selected will be repeated continuously.

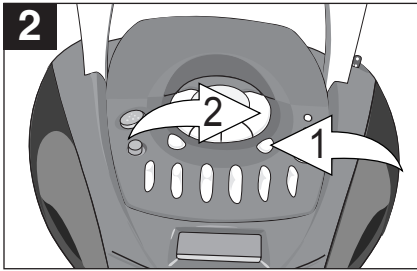

2 To repeat all of the tracks on a disc continuously, press the MODE/MEMORY UP button **1** twice; the Repeat indicator will light solid in the display. Press the CD PLAY/PAUSE (**2**) button **2** to begin all tracks repeat.

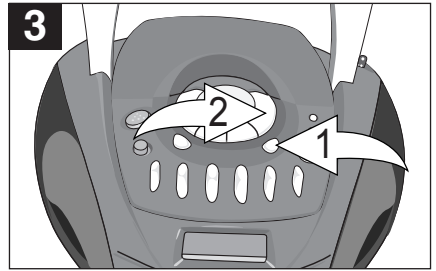

3 To randomly playback all the tracks on the CD, press the MODE/MEMORY UP button **1** a third time; "RND" will appear in the display. Press the CD PLAY/PAUSE (**2**) button **2** to begin random play.

To cancel Repeat or Random Playback, press the MODE/MEMORY UP button **1** a fourth time.

PROGRAMMED PLAYBACK

The CD player in this unit has a 20 track programmable memory that allows you to program up to 20 tracks on any disc for playback in any desired order. You may program 20 different tracks or you may also program certain tracks to play more than once.

To perform programmed playback, proceed as follows:

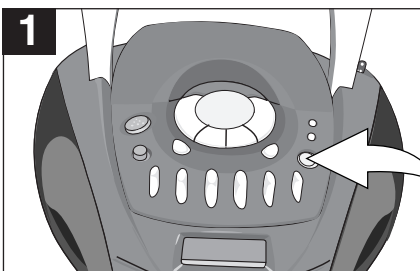

1 Press the FUNCTION button to select CD.

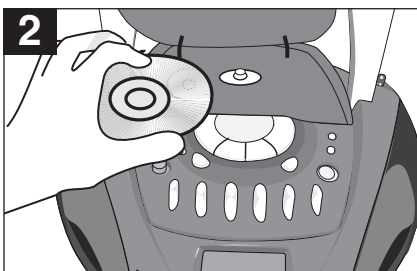

2 Open the CD Compartment door and insert your disc in the CD player. Close the CD compartment door. Wait for the CD player to read the table of contents and display the total number of tracks and playing time of the disc.

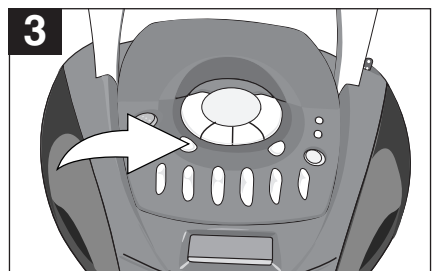

3 Press the PROGRAM/MEMORY/CLOCK SET button; "P01" (program number) will momentarily appear, then "00" (track number) and "MEM" will blink in the display.

PROGRAMMED PLAYBACK SECTION CONTINUED ON NEXT PAGE.

OPERATING INSTRUCTIONS (CONTINUED)

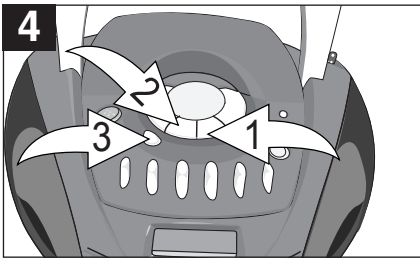

4 Press the CD Skip/Search (▶▶) ❶ or (◀◀) button ❷ to select the first track that you wish to program. When the desired track number appears in the display, press the PROGRAM/MEMORY/CLOCK SET button ❸ again.

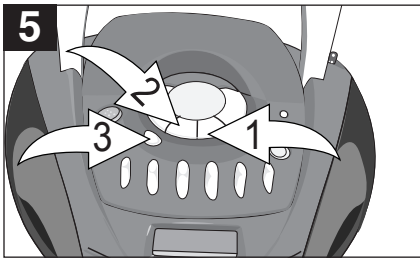

5 Press either the CD Skip/Search (▶▶) ❶ or (◀◀) button ❷ to select the next track you wish to program. When the desired track number appears in the display, press the PROGRAM/MEMORY/CLOCK SET button ❸ again.

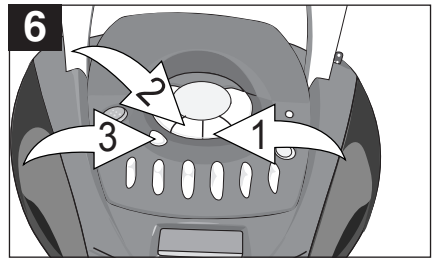

6 Repeat step 5 until you have programmed up to 20 track numbers into the CD Program Memory.

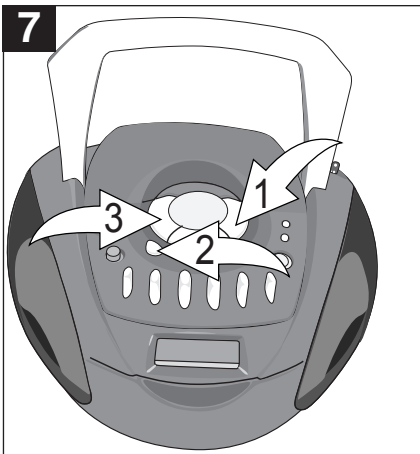

7 After programming up to 20 tracks in the CD Program Memory, press the CD PLAY/PAUSE (▶||) button ❶ to begin programmed playback. "MEM" will appear in the display and playback will begin on the first track that you programmed. The player will continue to play all of the tracks that you programmed in the order in which you programmed them. When the last programmed track has been played, the player will stop and the display will again show the total number of tracks on the disc. If you press the PROGRAM/MEMORY/CLOCK SET button ❷ and then press the CD PLAY/PAUSE (▶||) button ❶ again, playback will start on the first track you programmed and will continue until all the programmed tracks have been played. To cancel the Programmed Playback mode, press the PROGRAM/MEMORY/CLOCK SET button ❷ to enter the program mode, and then press the CD STOP (■) button ❸.

PROGRAMMED REPEAT

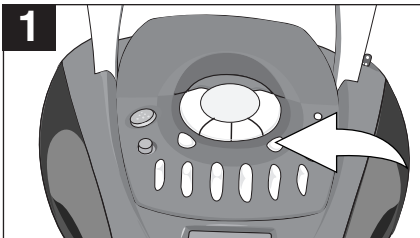

1 It is also possible to use the Program and Repeat functions together to repeat a specific program indefinitely. First, program the tracks you wish to hear in the order you wish to hear them, as described above. Then, press the MODE/MEMORY UP button twice. Both the MEMORY and REPEAT indicators will appear in the display.

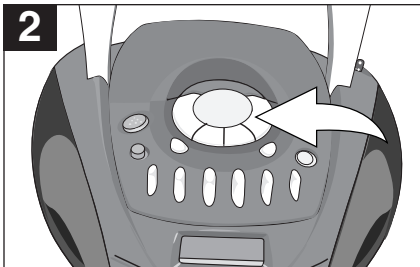

2 Press the CD PLAY/PAUSE (▶||) button to begin programmed repeat playback. The player will play the tracks you selected in the order in which you programmed them. When the last track in the program has been played, the entire program will begin again.

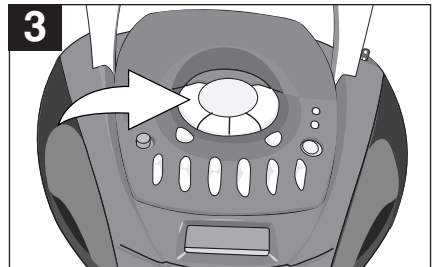

3 Program Repeat operation will continue indefinitely until you press the CD STOP (■) button or open the CD door.

OPERATING INSTRUCTIONS (CONTINUED)

PLAYING CASSETTE TAPES

PLAYBACK

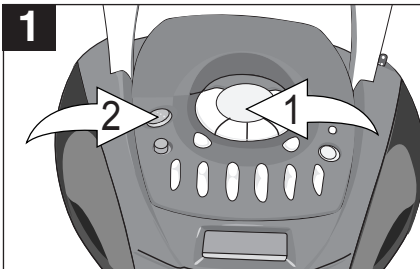

Press the **POWER** button ❶ to turn the unit on. Set the **VOLUME** control ❷ to a low setting.

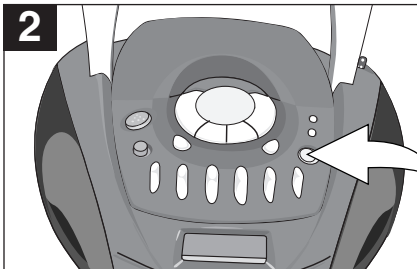

Press the **FUNCTION** button until "TAPE" appears in the display.

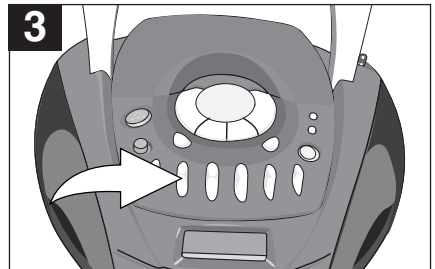

Press the **STOP/EJECT** (■▲) button to open the Cassette Door.

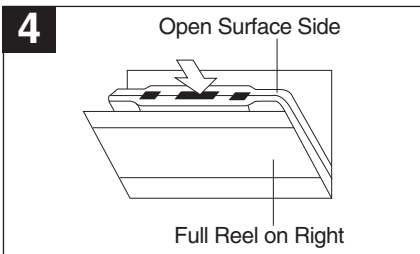

Insert a pre-recorded cassette into the slots in the Cassette Door with the open end facing up and the full reel on the right side. Close the cassette door.

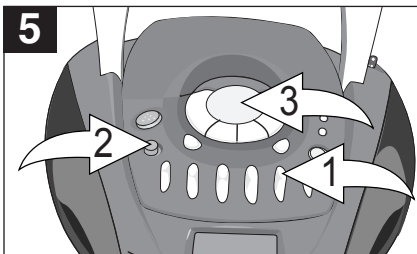

Press the cassette **PLAY** (◀) button ❶ to begin playback. Adjust the **BASS BOOST** button ❷ and **VOLUME** control ❸ as desired.

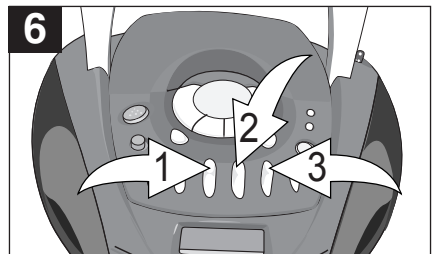

To advance or rewind the tape rapidly, press either the cassette **FAST FORWARD** (◀◀) ❶ or **REWIND** (▶▶) ❷ button. When you reach the desired point, press the cassette **PLAY** (◀) button ❸ to resume normal playback.

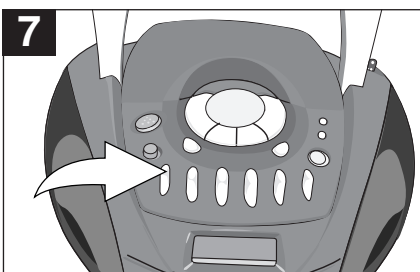

To pause playback momentarily, press the cassette **PAUSE** (||) button. The tape movement stops but the tape motor is still running. Press the cassette **PAUSE** (||) button again to release pause and resume normal playback.

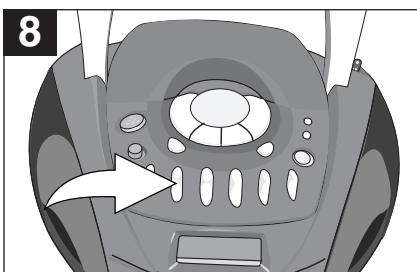

To stop playback before the tape ends, press the **STOP/EJECT** (■▲) button. The **PLAY** (◀) button is released and the tape motor shuts off.

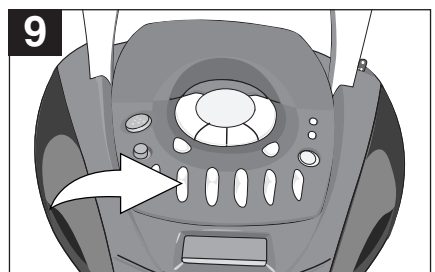

When the tape reaches the end, the auto-stop mechanism activates, the tape **PLAY** (◀) button is released and the tape motor shuts off. Press the **STOP/EJECT** (■▲) button to open the Cassette Door and remove the tape.

OPERATING INSTRUCTIONS (CONTINUED)

MAKING A TAPE RECORDING

The tape recorder in this unit allows you to make direct recordings from the radio or CD player to a blank cassette in the tape compartment. An automatic recording volume level control (ALC) circuit will automatically control the volume level of your recordings to prevent distortion. You may change the settings of the VOLUME control or the BASS BOOST button during a tape recording, as these controls have no effect on the material being recorded onto the tape.

To make a tape recording, proceed as follows:

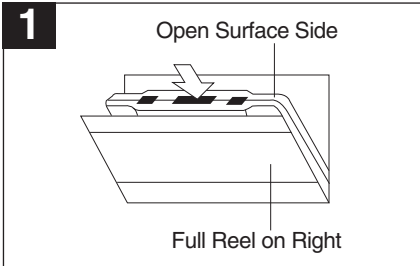

Open the Cassette Door and insert a good quality blank cassette tape into the slots on the door, with the open end facing up and the full reel on the right-hand side. Close the cassette door.

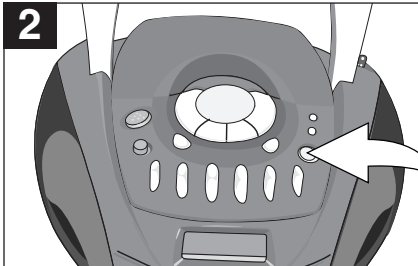

Press the FUNCTION button to select the function you wish to record, either radio or CD, and operate that function according to its own instructions.

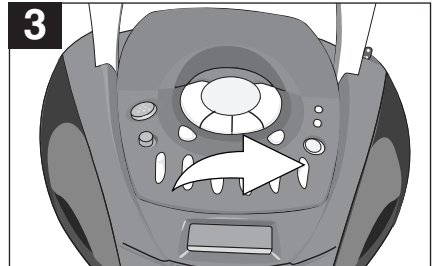

When you are ready to begin recording, press the cassette RECORD (●) button. The cassette PLAY (◀) button will also engage. The tape will begin moving and all of the material from your selected source will be recorded on the tape.

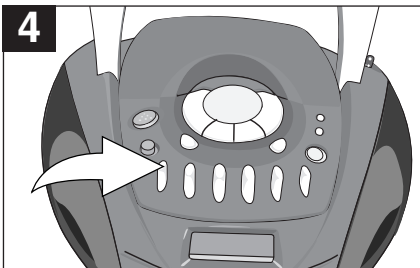

To avoid recording unwanted material, such as radio commercials, use the PAUSE (||) button to stop the recording temporarily. Release the pause (||) button to begin recording again.

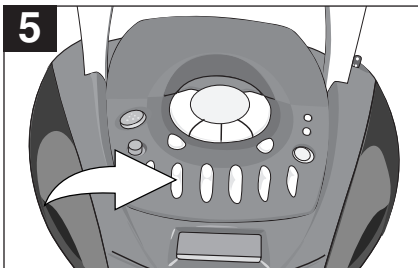

When you are finished recording, press the STOP/EJECT (■▲) button to stop the tape.

CASSETTE TAPES

SAFEGUARD AGAINST ACCIDENTAL ERASURE

When a new recording is made, any program material previously recorded is automatically erased and only the new recording remains. To safeguard valuable recordings from being erased accidentally, the cassette and the deck are equipped with a special device.

On the back of the cassette there is an erase prevention tab on each side. To prevent accidental erasing, break out these tabs with a screwdriver. If only one side of the tape is to be protected, break out the tab on the left side with the side desired facing you.

To record on a tape in which the tab has been broken, place a piece of adhesive tape over that area.

NOTE: When a tab is broken out, the record button cannot be depressed.

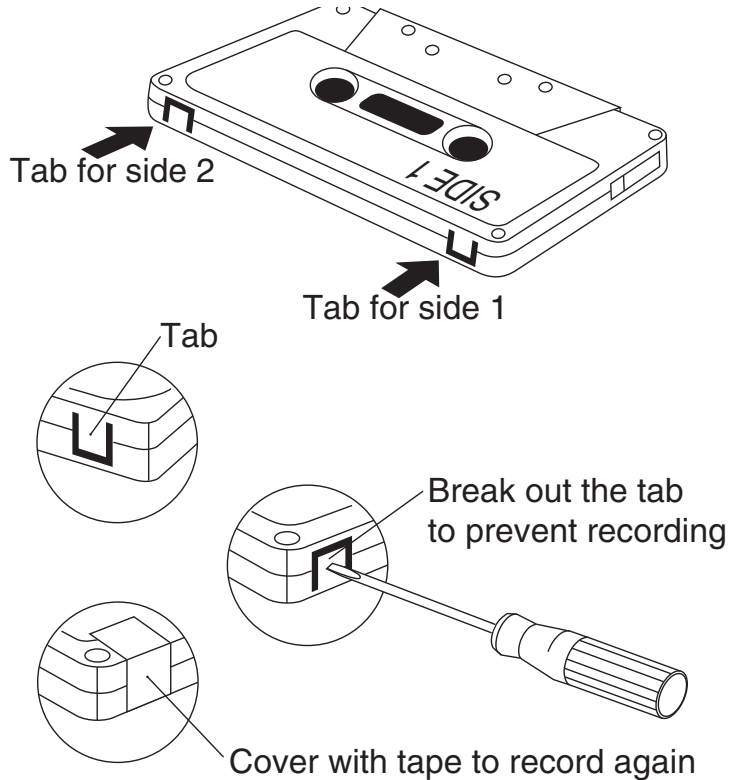

CASSETTE TAPE RECOMMENDATIONS

Standard tape lengths have 15 (C-30), 30 (C-60) and 45 (C-90) minutes of recording time on each side. Longer length tapes of 60 (C-120) minutes of recording time on each side are not recommended. Use only high quality tapes. If a problem develops, check the unit first with another cassette to determine if the problem is with the cassette, and not with the unit.

If there is any slack in the tape in the cassette, it should be removed before inserting the cassette. Place a pencil in one of the hubs and rotate clockwise until all slack is taken up.

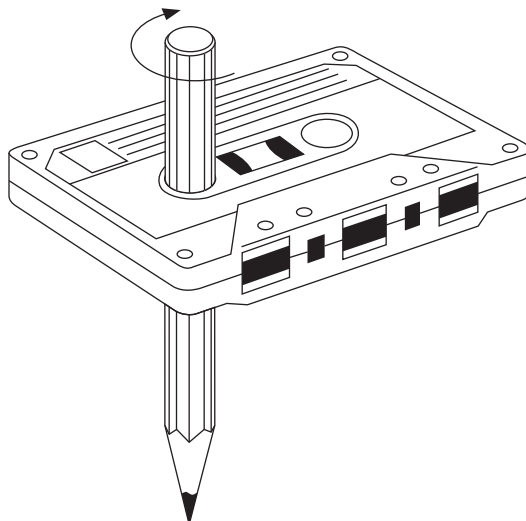

CARE AND MAINTENANCE

Caring for Compact Discs

- Treat the compact disc carefully. Handle the compact disc only by its edges. Never allow your fingers to come in contact with the shiny, unprinted side of the compact disc.
- Do not attach adhesive tape, stickers, etc. to the compact disc label.
- Clean the compact disc periodically with a soft, lint-free, dry cloth. Never use detergents or abrasive cleaners to clean the compact disc. If necessary, use a CD cleaning kit.
- If a compact disc skips or gets stuck on a section of the compact disc, it is probably dirty or damaged (scratched).
- When cleaning the compact disc, wipe in straight lines from the center of the compact disc to the outer edge of the compact disc. Never wipe in circular motions.

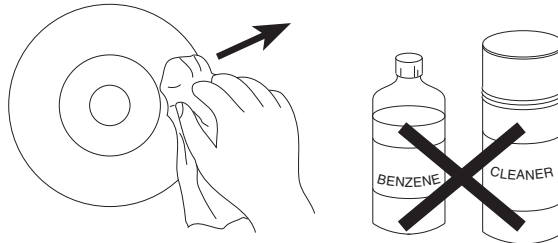
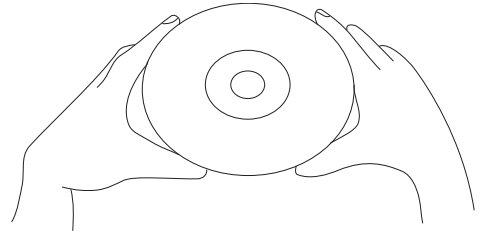

- This unit is designed to play only compact discs bearing the identification logo as shown here. Other compact discs may not conform to the CD standard and may not play properly.
- Compact discs should be stored in their cases after each use to avoid damage.
- Do not expose compact discs to direct sunlight, high humidity, high temperatures, or dust, etc. Prolonged exposure or extreme temperatures can warp the compact disc.
- Do not stick or write anything on either side of the compact disc. Sharp writing instruments, or the ink may damage the surface.



Cleaning the unit

- To prevent fire or shock hazard, disconnect your unit from the AC power source when cleaning.
- The finish on your unit may be cleaned with a dust cloth and cared for as other furniture. Use caution when cleaning and wiping the plastic parts.
- Mild soap and a damp cloth may be used on the front panel.
- Periodic cleaning of the tape heads, capstan and pinch roller is necessary to maintain good sound reproduction. Clean them after every 100 hours of use or less if playback has deteriorated. Use a cotton swab moistened with head cleaning solution or isopropyl alcohol, then wipe dry with another swab.

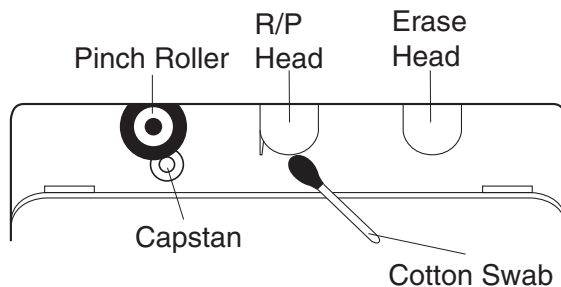

NOTE: Never use metal objects on or near the tape heads. Do not allow any cleaning material to fall into the tape assembly.

TROUBLESHOOTING GUIDE

Should this unit exhibit a problem, check the following before seeking service:

Symptom	Possible Cause	Solution
Radio		
Noise or sound distorted on radio broadcasts.	Station not tuned properly for AM or FM.	Retune the AM or FM broadcast station.
	FM: Rod Antenna is not extended.	Reorient FM Rod Antenna.
	AM: Unit is not positioned correctly.	Rotate unit until best reception is obtained.
FM STEREO indicator does not light.	Poor FM signal being received.	Retune station or try another station that broadcasts in stereo.
	Station is not broadcasting in stereo.	Change stations.
AM or FM, no sound.	FUNCTION button is not set to Tuner.	Press the FUNCTION button to select Tuner.
	Volume at minimum.	Increase volume.
Cassette Player		
No sound.	FUNCTION button is not set to the TAPE position.	Press the FUNCTION button to select Tape.
	Volume at minimum.	Increase volume.
Sound distorted.	Dirty head.	Clean the head.
Speed varies.	Tape old or worn.	Replace the tape.
	Batteries are low.	Replace the batteries.
Cassette Recorder		
Will not record.	Erase prevention tab removed.	Cover hole with adhesive tape.
Distorted sound on playback.	Defective tape or dirty tape head.	Replace tape or clean tape head.
Compact Disc Player		
CD Player will not play.	FUNCTION button is not set to CD.	Press the FUNCTION button to select CD.
	CD is not installed or installed upside-down.	Insert CD with label side up.
CD skips while playing.	Disc is dirty or scratched.	Wipe disc with cloth or use another disc.
General		
No power.	Batteries are dead or not installed properly.	Install fresh batteries properly.
	AC power cord is not connected.	Connect AC power cord.

LIMITED WARRANTY

Emerson Radio Corp. warrants manufacturing defects in original material, including original parts and workmanship, under normal use and conditions, for a period of ninety (90) days from the date of original purchase in the U.S. With your dated proof of purchase, we will provide repair service at no charge for labor and parts at an authorized Depot Repair Facility, or replace the product in our discretion. For repair or replacement, pack your unit in a padded box, enclose your check or money order payable to Emerson Radio Corp. in the amount of \$9.00 (not required by California residents) to cover shipping and handling costs, and enclose a copy of your proof of purchase. Send your unit to:

Emerson Radio Corp.
1901 Diplomat Drive
Farmers Branch, TX 75234

This warranty does not cover damage from negligence, misuse, abuse, accident, failure to follow operating instructions, commercial use, rental, repairs by an unauthorized facility, or products purchased, used, serviced or damaged outside of the United States.

THIS WARRANTY GIVES YOU SPECIFIC LEGAL RIGHTS, AND YOU MAY ALSO HAVE OTHER RIGHTS WHICH VARY FROM STATE TO STATE.

AU898M



TO FIND THE LOCATION AND
PHONE NUMBER OF YOUR
NEAREST AUTHORIZED
SERVICE CENTER...

CALL TOLL FREE: 1-800-695-0098

FOR ADDITIONAL SET-UP OR OPERATING ASSISTANCE
PLEASE CALL:
1-800-898-9020

FOR CUSTOMER SERVICE, PLEASE WRITE TO:
Emerson Radio Corp.
Consumer Affairs Dept.
1901 Diplomat Drive
Farmers Branch, TX 75234



EMERSON
PART NO.: 16-2848C
312-01

Printed in China

Free Manuals Download Website

<http://myh66.com>

<http://usermanuals.us>

<http://www.somanuals.com>

<http://www.4manuals.cc>

<http://www.manual-lib.com>

<http://www.404manual.com>

<http://www.luxmanual.com>

<http://aubethermostatmanual.com>

Golf course search by state

<http://golfingnear.com>

Email search by domain

<http://emailbydomain.com>

Auto manuals search

<http://auto.somanuals.com>

TV manuals search

<http://tv.somanuals.com>