EMERSON
QUIET KOOL®

OWNER'S MANUAL

MODEL: EAD30E1
EAD50E1
EAD70E1



DEHUMIDIFIER

THANK YOU!

Congratulations on your purchase and welcome to the EMERSON QUIET KOOL® Family. Your new EMERSON QUIET KOOL® Dehumidifier combines high-efficiency operation with portable convenience. By following the operating and care instructions in this manual, your dehumidifier will provide you with many years of reliable service.

INTRODUCTION

IMPORTANT SAFETY INSTRUCTIONS	
Basic Safety Precautions-----	01
Electrical Safety-----	03
PARTS AND FEATURES	
Key Parts and Components-----	04
Caster Installation-----	04
Control Panel-----	05
CHOOSING A LOCATION -----	08
AUTOMATIC DEFROST -----	08
CONTINUOUS MODE -----	08
MAINTENANCE -----	09
TROUBLESHOOTING	
Before Calling for Service-----	10
ERROR CODE -----	11

IMPORTANT SAFETY INSTRUCTIONS

READ ALL INSTRUCTIONS BEFORE USE

Your safety and the safety of others is very important.

We have provided many important safety messages in this manual and on your appliance. Always read and obey all safety messages.



This is the safety alert symbol.
This symbol alerts you to potential hazards that can hurt you and others.

All safety messages will follow the safety alert symbol and either the word "WARNING" or "CAUTION".

These words mean:



WARNING This symbol indicates the possibility of death or serious injury.



CAUTION This symbol indicates the possibility of injury or damage to property.

BASIC SAFETY PRECAUTIONS



WARNING To reduce the risk of fire, electric shock, or injury to persons when using this appliance, follow basic precautions, including the following:

- Do not attempt to repair or replace any part of your dehumidifier unless it is specifically recommended in this manual. All other services should be referred to a qualified technician.
- If the power cord becomes worn or damaged, the cord should only be replaced by a qualified service technician using genuine replacement parts.
- The dehumidifier should be plugged into its own grounded (15A, 60Hz, 115VAC circuit).
- Do not plug other appliances into the same outlet; it can overload the circuit and cause a fire or electric shock.
- Do not remove the round grounding prong from the plug. It can result in the risk of electric shock.
- This appliances is not designed for use by young children. Young children should be supervised to ensure that they do not play with or climb on the unit.
- Be sure all packaging materials are removed from the appliances before use. It can result in personal injury.
- Do not disassemble or modify the appliances or the power cord. It can result in the risk of electric shock or fire.
- Do not place the power cord or appliances near a heater, radiator, or other heat source. It can result in the risk of electric shock or fire.
- Do not use this or any appliance near flammable gases or liquids or other combustibles, such as gasoline, benzene, thinner, etc. It can result in the risk of electric shock or fire.
- Make sure the power cord is plugged firmly and completely into the outlet. It can result in the risk of electric shock or fire.

IMPORTANT SAFETY INSTRUCTIONS

READ ALL INSTRUCTIONS BEFORE USE

- Do not start or stop operation by plugging in or unplugging the power cord. It can result in the risk of electric shock.
- If the appliances are making unusual sounds or is emitting smoke or an unusual odor, unplug it immediately. It can result in the risk of electric shock or fire.
- Do not use if the electrical socket is loose or damaged. It can result in the risk of electric shock or fire.
- Do not operate with wet hands or in a excessive damp environment. It can result in the risk of electric shock.
- Do not use this or any electrical appliance if you smell gas. It can result in the risk of fire or explosion.
- Turn off and unplug the appliances before cleaning to avoid the risk of electric shock.
- Do not clean the unit with water. Water can enter the unit and damage the insulation, creating a shock hazard. If water enters the unit, unplug it immediately and contact Customer Service. It can result in the risk of electric shock.

BASIC SAFETY PRECAUTIONS



CAUTION To reduce the risk of fire, electric shock, or injury

to persons when using this appliances, follow basic precautions, including the following:

- To avoid possible cuts, avoid contacting the metal parts of the appliances when removing or re-installing the filter. It can result in the risk of personal injury.
- Do not block the air inlet or outlet of the appliance. Reduced air flow will result in poor performance and could damage the unit.
- Always grasp the plug when plugging in or unplugging the appliance. Never unplug by pulling on the cord. It can result in the risk of electrical shock and damage.
- Always turn off and unplug the appliances when it will not be used for extended period of time. This conserves energy and reduces the chance of accidents.
- Install the appliance on a sturdy, level floor capable of supporting up to 110 lbs (50 kg). Installation on a weak or unlevel floor can result in the risk of property damage and personal injury.
- Make sure the appliance is the correct size for the area you wish to dehumidify. Using an appliance that is the wrong size can waste energy and damage the unit.
- Close all doors and windows to the room for most efficient operation.
- To prevent damage to the surface finish, use only a soft cloth to clean the appliances. Do not use wax, thinner, or a strong detergent.
- To prevent spills and property damage, be sure to drain the appliance properly.

IMPORTANT SAFETY INSTRUCTIONS

READ ALL INSTRUCTIONS BEFORE USE

- To prevent the coils from freezing, do not operate the appliances if the room temperature is lower 41°F (5°C).
- Do not position the appliances so that pets or house plants are exposed to the direct air flow. It can result in the risk of injury to pets or house plants.
- This appliance is designed for normal household use.
- Do not drink the water from the bucket. Dispose of it properly outdoors or down the drain.
- Do not operate appliance without the filter securely in place. Operation without the filter could damage the unit.
- Clean the filter every two weeks, or more often if needed.

ELECTRICAL SAFETY



WARNING

Electrical Shock Hazard

- Failure to follow these instructions can result in death, fire, or electrical shock.
- This unit must be properly grounded.
- Do not, under any circumstances, cut or remove the ground prong.
- If you do not have a properly grounded outlet, or if there is any doubt that the outlet is not properly grounded, a qualified electrician should check the outlet and circuit, and, if necessary, install a properly grounded outlet.
- This dehumidifier must be plugged into a grounded 60 Hz, 115 VAC outlet protected by a 15 amp time delay fuse or circuit breaker.
- This dehumidifier must be installed in accordance with national wiring codes.
- Do not alter or modify the plug or cord of this dehumidifier. If the power cord becomes worn or damaged, the cord should only be replaced by a qualified service technician using genuine replacement parts.
- Do not use an extension cord.

SAVE THESE INSTRUCTIONS

PARTS AND FEATURES

KEY PARTS AND COMPONENTS

1. Air Outlet Grill
2. Control Panel
3. Carrying Handle
4. Bucket
5. Water Level
6. Casters
7. Air Intake Grill
8. Drain hole
9. Power Cable
10. Product manual(Not Shown)

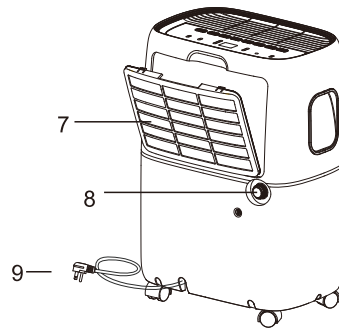
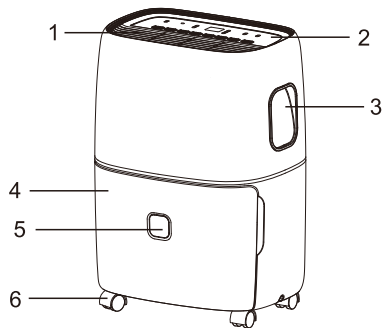

CASTER INSTALLATION

1. Remove casters from bucket.

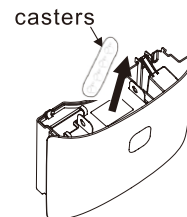

2. Install the caster.

Tilt the dehumidifier no more than 45° and forcibly insert the casters. Make sure the ring around the caster is flush against the bottom of the dehumidifier.

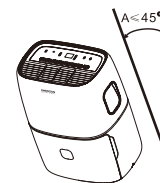

PARTS AND FEATURES

CONTROL PANEL

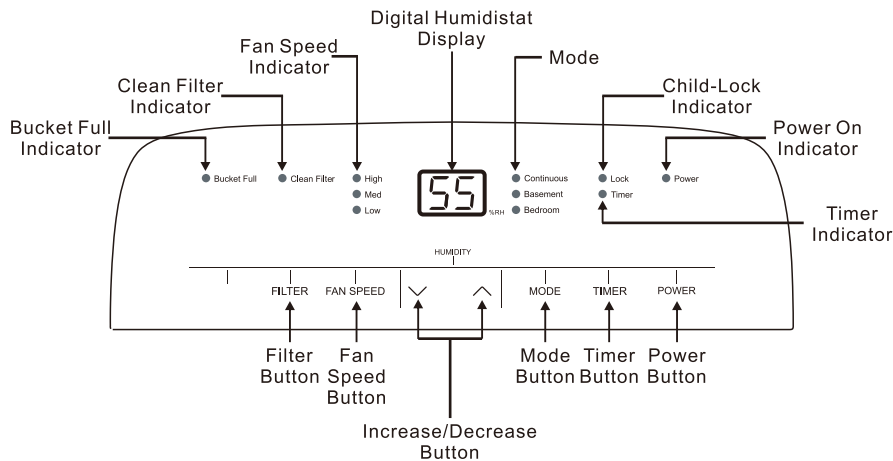

CONTROL PANEL

1) When first operating the dehumidifier, run it in Continuous mode for 24 hours.

2) Power On and Off - Press the POWER button once to manually turn the unit on. Press the POWER button once more to turn the unit off.

3) Humidity Selection - Press the ∇ or \blacktriangle buttons to choose the desired relative humidity in the room. Each press of the button will change the desired room humidity by 5%. The room humidity is selectable from 35%-80% or continuous. The unit will cycle on and off to maintain the humidity level chosen on the digital display. If you want the dehumidifier to operate continuously regardless of the room humidity, press the MODE button until you see "CO" on the digital display. This will enable continuous operation and the "Continuous" indicator will light up on the control panel.

NOTE: Continuous dehumidification -When stop using, the fan motor will continue to run for about 3 minutes to reduce water dripping from the evaporator. Please do not take away the bucket before the fan motor draw out the water inside to prevent water dripping, since the fan motor will keep running for 3 minutes.

4) Fan Speed Control - Press the FAN SPEED Button to cycle through the different fan speeds: High, Medium, and Low. The display will show selected fan speed.

5) Timer Auto On - To program the unit to automatically turn on, press the TIMER button when the unit is off. Press ∇ or \blacktriangle to increase or decrease the timer in 30 min increments (0.5 hours) up to 10 hours. After 10 hours, each press of the \blacktriangle button will increase the timer in 1 hour increments up to 24 hours. Once the desired time is reached, the unit will automatically turn on.

Timer Auto Shut-Off - To program the unit to automatically turn off, press the TIMER button when the unit is on. Each press of the ∇ or \blacktriangle buttons will change the timer setting in 30 min increments (0.5 hours) up to 10 hours. After 10 hours, each press of the ∇ or \blacktriangle buttons will increase or decrease the timer in 1 hour increments up to 24 hours. Once the desired time is over, the unit will automatically power off.

NOTE: Fan will continue to run even when the compressor is off. This is normal and allows the unit to circulate air and operate more efficiently

PARTS AND FEATURES

6) Bucket Full - When the water bucket is full of water, the unit will automatically shut off, make a beeping noise, and the Bucket Full Indicator will light up. The dehumidifier will not function until the water bucket is emptied and placed back inside the unit. The bucket should be cleaned every few weeks to prevent the growth of mold, mildew and bacteria. Use a mild detergent to clean the bucket. Once clean, completely dry the bucket and place it back inside the dehumidifier.

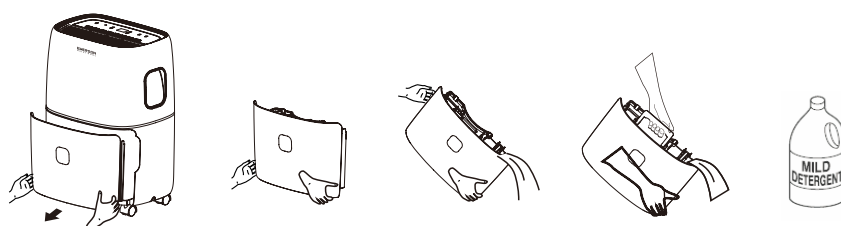

NOTE: Hold bucket with both hands when emptying.
Only available for 70 pint with model (EAD70E1).

NOTE: When the bucket is full or removed from the machine, the compressor will turn off, but the fan will continue to run for 3 minutes. This is for drying up the remaining condensate so it does not drip onto the bottom. Any drips during this time are a part of normal operation and are do not indicate a defective machine.

NOTE: When removing moisture from the air, the dehumidifier will exhaust warm air from the top exhaust vent.

NOTE: Because the bottom is uneven, do not place a full bucket on the floor.

7) Clean Filter - When the filter needs to be cleaned, the filter indicator will light up (after 250 hours of use). Remove the filter from the back of the unit by using your thumbs to press down on the filter tabs directly above the filter. Clean the filter with warm, soapy water. Dry thoroughly before replacing the filter. Once the filter is completely dry, place the filter back in the unit and press the FILTER button to reset the filter indicator.

CAUTION: DO NOT OPERATE THE DEHUMIDIFIER WITHOUT THE FILTER



NOTE: Do not clean filter in dishwasher

PARTS AND FEATURES

8) Pre-set Modes - Preset humidity level settings allow the user to easily move the dehumidifier room-to-room and select the corresponding mode for the location in which the dehumidifier is operating for optimum performance. Press the Mode button to choose from Bedroom, Living Room or Basement.

9) Child-Lock Mode - To lock the control panel, press and hold the TIMER button for 3 seconds. Locking the control panel prevents someone from accidentally changing the settings. When locked, the LOCK Indicator will light up. Press and hold the TIMER button for 3 seconds to unlock the control panel.

CHOOSING A LOCATION

A Dehumidifier operating in a basement will have little or no effect in drying out an adjacent enclosed storage area, such as a closet, unless there is adequate circulation of air in and out of the area.

- Do not use outdoors.
- This dehumidifier is intended for indoor use only. Place the dehumidifier on a smooth, level floor surface that is strong enough to support the unit with a full bucket of water.
- Allow at least 12"-18" of air flow on all sides.
- Place the dehumidifier in an area where the temperature will not fall below 41°F (5°C).
- Use the dehumidifier in cooking, laundry, bathing and dishwashing areas that have excessive moisture. NOTE: Place the dehumidifier away from a clothes dryer.
- Use the dehumidifier to prevent moisture damage anywhere books or valuables are stored.
- Use the dehumidifier in a basement to help prevent moisture.
- The dehumidifier must be operated in an enclosed area to be most effective.
- Close all doors, windows and other outside openings to the room.

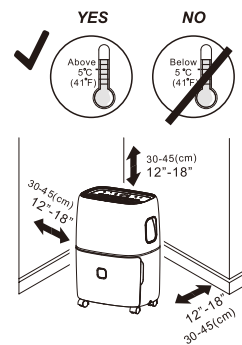

AUTOMATIC DEFROST

When frost builds up on the evaporator coils, the compressor will cycle off and the fan will continue to run until the frost disappears. When the coils are completely defrosted, the compressor or fan (depending on the model) will automatically restart and dehumidification will resume.

CONTINUOUS MODE—GARDEN HOSE INSTALLATION AND SETUP

Water can be automatically emptied by attaching a hose to the continuous drainage port on the back of the dehumidifier. This will allow the unit to run continuously (depending on the selected humidity level) without having to empty the water bucket. To drain, simply attach a standard garden hose (not included). The thread standard for garden hoses in the US and its territories is known as GHT or "garden hose thread" which has an outer diameter of 1 1/16 inches (1.0625 inches or 27.0 mm) and a pitch of 11.5 TPI.

- Place dehumidifier on a level surface.
- Unscrew the cap on the back of the unit to access the garden hose nozzle
- Thread a garden hose (not supplied) onto the accessible nozzle, lead to a floor drain and cut to length. Make sure that there are no kinks or knots in the garden hose. (See picture next page)
- Turn on the unit and press the MODE button until set to CONTINUOUS.

CONTINUOUS MODE—GARDEN HOSE INSTALLATION AND SETUP

Garden Hose Installation Reference Guide

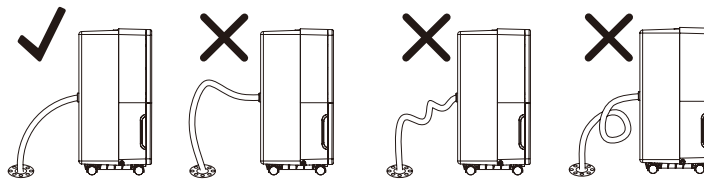

IMPORTANT NOTES:

Placing the dehumidifier on an uneven surface or improper hose installation may result in water filling up the bucket and causing the unit to shut off. Empty bucket if shut-off occurs, then check dehumidifier location and hose for proper setup. The bucket must be in place and securely seated for the dehumidifier to operate.

MAINTENANCE

Note: Make sure power is off and the power cord is not plugged into an electrical outlet prior to performing any maintenance on the unit.

Clean or Replace Filter - Refer to Operating Instructions Clean Filter section.

Clean the Unit Housing -

- 1) Keep the unit from being exposed directly to the sun to prevent color fading.
- 2) Clean the surface with a damp cloth and dry it with a soft towel.

Storing the Unit for an Extended Period of Time or Transporting the Unit

- 1) Clean or replace filter - Refer to Operating Instructions Clean Filter section.
- 2) Unplug the unit.
- 3) Empty any excess water.
- 4) The unit should be stored in a cool dry place.

TROUBLESHOOTING

BEFORE CALLING FOR SERVICE

Before you call for service, review this list. It may save you time and money. This list includes common occurrences that are not the result of a defect in workmanship or materials.

Problem	Possible Causes	Solutions
Dehumidifier does not start	<ul style="list-style-type: none"> • The dehumidifier is unplugged. • The fuse is blown / circuit breaker is tripped. • Dehumidifier has reached its present level or the bucket is full. • Bucket is not in the proper position. • Power Failure. 	<ul style="list-style-type: none"> • Make sure the dehumidifier's plug is pushed completely into the outlet. • Check the house fuse / circuit breaker box and replace fuse or reset breaker. • The dehumidifier automatically turns off when either condition occurs. Change to a lower setting or empty the water bucket and replace properly. • The bucket must be in place and securely seated for the dehumidifier to operate. • There is a protective time delay (up to 3 min.) to prevent tripping of the compressor overload. For this reason, the unit may not start normal dehumidification for 3 min. after it is powered back on.
Dehumidifier does not dry the air as it should	<ul style="list-style-type: none"> • Not enough time allowed for unit to remove moisture. • Airflow is restricted. • Dirty filter. • The Humidity Control may not be set low enough. • Doors and windows may not be closed tightly. • Clothes dryer may be blowing moist air into the room. • Room temperature is too low. 	<ul style="list-style-type: none"> • When first installed, allow at least 24 hours to maintain the desired dryness. • Make sure there are no curtains, blinds, or furniture blocking the front or back of the dehumidifier. See the CHOOSING A LOCATION section. • See the CLEAN FILTER section. • For drier air, press the ▼ button to lower the percent humidity desired in the room, or set the dehumidifier to CO for maximum dehumidification. • Check that all doors, windows, and other openings are securely closed. • Install the dehumidifier away from the dryer. The dryer should be vented outside. • Moisture removal is best at higher room temperatures. Lower room temperatures will reduce the moisture removal rate. This model is designed to operate at temperatures above 41°F (5°C).

TROUBLESHOOTING

Problem	Possible Causes	Solutions
Dehumidifier runs too much	<ul style="list-style-type: none"> The area to be dehumidified is too large. Doors and windows are open. 	<ul style="list-style-type: none"> The capacity of your dehumidifier may not be adequate for the room size. Close all doors and windows to the outside.
Frost appears on the coils	<ul style="list-style-type: none"> The dehumidifier has recently been turned on or the room temperature is too low. 	<ul style="list-style-type: none"> This is normal. Frost will usually disappear within 60 minutes.
Controls cannot be set	<ul style="list-style-type: none"> The compressor will turn off and the fan will automatically continue to run for approximately 3 minutes at a fixed setting. Air is moving through the unit. 	<ul style="list-style-type: none"> This is normal. Wait approximately 3 minutes and set the fan speed at the desired level. This is normal.
Water on the floor	<ul style="list-style-type: none"> Hose connection may be loose. Hose is attached but not draining 	<ul style="list-style-type: none"> Check the hose connection. See the CONTINUOUS MODE-GARDEN HOSE INSTALLATION AND SET UP Section Disconnect the hose if using the bucket or place the hose near a drain.
Water dripping after bucket is removed		<ul style="list-style-type: none"> After removing bucket it's the fan will continue to run for 3 minutes to dry up the remaining condensate so it does not drip onto the bottom. Any drips during this time are a part of normal operation and are do not indicate a defective machine.

ERROR CODE

Error Code	Description
EH	Humidity Sensor Fault
E1 or E2	Temperature Sensor Fault
E3	Lack of gas to protect

- If E3 appears, please check whether the ambient temperature range is from 5°C to 32°C.
- If the ambient temperature is over 32°C, place the unit into a room under 32°C (suggest 30°C) for two hours before running the air conditioner again.
- Start up the unit, if E3 appears again in 2 hours, please contact the service center.

For any questions or Technical Support,
Please Call Customer Service: 1-844-801-8880

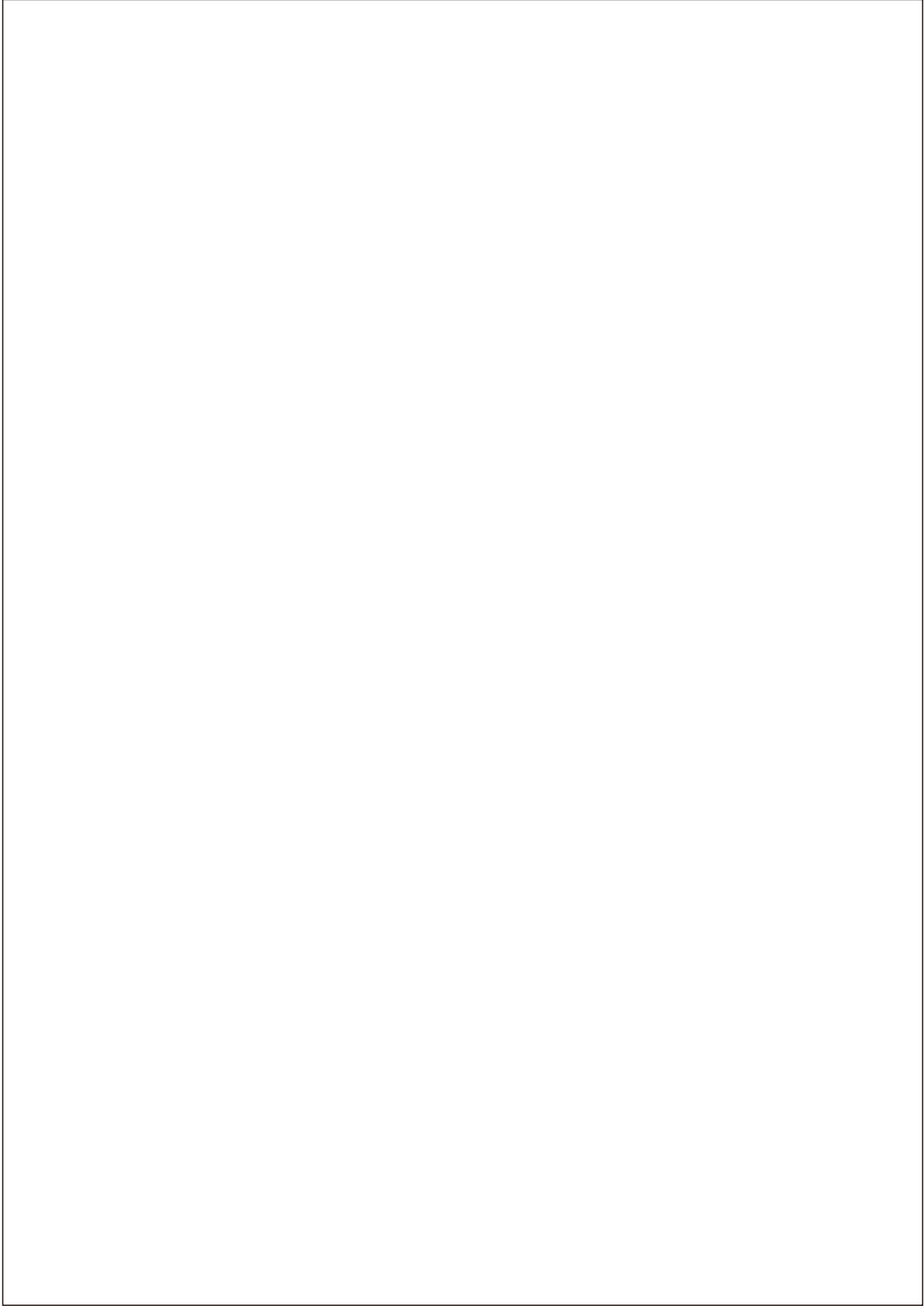

EMERSON
QUIET KOOL®

Free Manuals Download Website

<http://myh66.com>

<http://usermanuals.us>

<http://www.somanuals.com>

<http://www.4manuals.cc>

<http://www.manual-lib.com>

<http://www.404manual.com>

<http://www.luxmanual.com>

<http://aubethermostatmanual.com>

Golf course search by state

<http://golfingnear.com>

Email search by domain

<http://emailbydomain.com>

Auto manuals search

<http://auto.somanuals.com>

TV manuals search

<http://tv.somanuals.com>