

Quick Setup

Before using the projector, make sure you read the safety instructions in the online *User's Guide*.

Note: Your product may differ from the illustrations on this sheet, but the instructions are the same.

Connect the projector

Choose from the following connections. See the sections below or the online *User's Guide* for details.

Video device

Connect multiple video devices and use the **Source Search** button on the projector or the remote control to switch between them.

Home Cinema 660/760HD

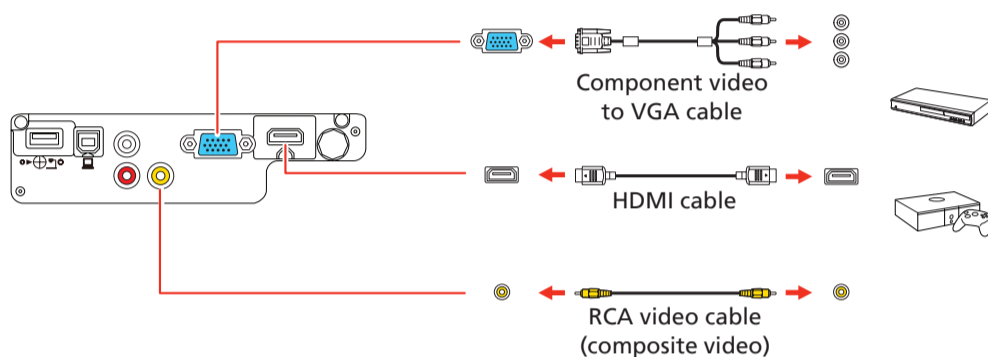

Home Cinema 1060

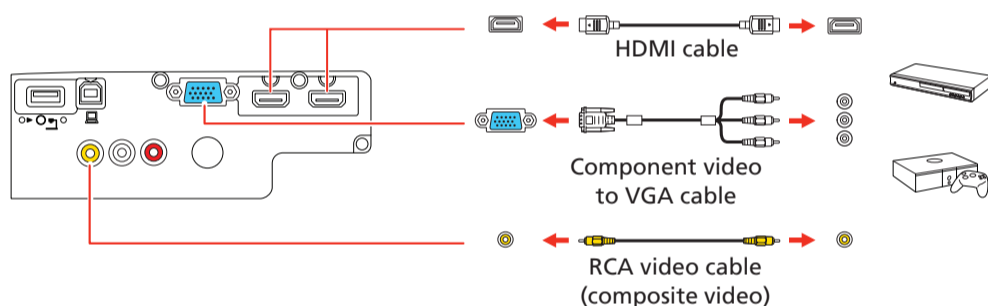

Mobile media device (Home Cinema 1060)

Connect tablets, smartphones, and other devices that support the MHL™ standard to the **HDMI2/MHL** port.

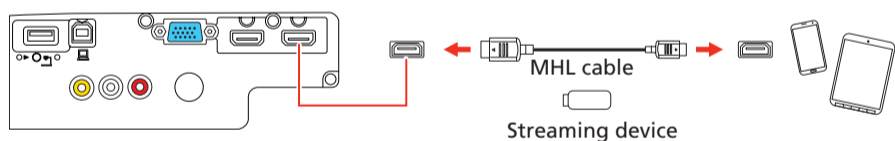

Some devices may require an adapter or may not require an MHL cable. Not all features or functions may be supported. Check your device's documentation for more information.

Computer

Connect one end of an HDMI cable to one of the projector's HDMI ports shown above and the other end to an HDMI port on your computer.

Note: For more information on connecting the projector to your computer or other devices (camera, USB flash drive, etc.), see the online *User's Guide*.

Connect audio

Built-in speaker

The projector has a built-in speaker that can play audio from a video source (DVD player, streaming device, etc.) connected by an HDMI cable. If you do not use an HDMI connection, you must connect your device's audio output to the projector's audio input.

Home Cinema 660/760HD

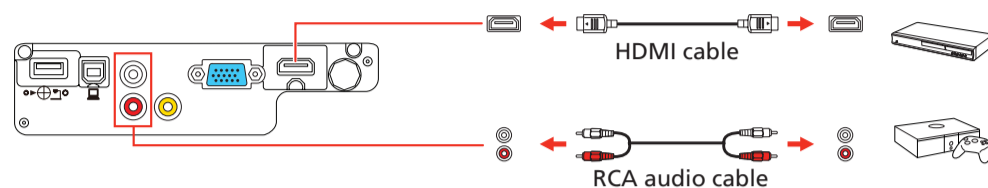

Home Cinema 1060

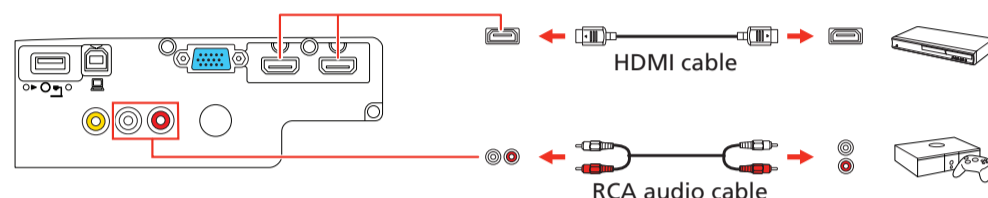

External speakers

Connect your device's audio output to your home theater receiver or powered speakers.

Note: The internal speaker is disabled when an external device is connected.

If you are using an HDMI connection to the projector, you may need to reduce the projector speaker volume to zero (0), or make sure that the correct audio output is selected on your device.

Home theater system

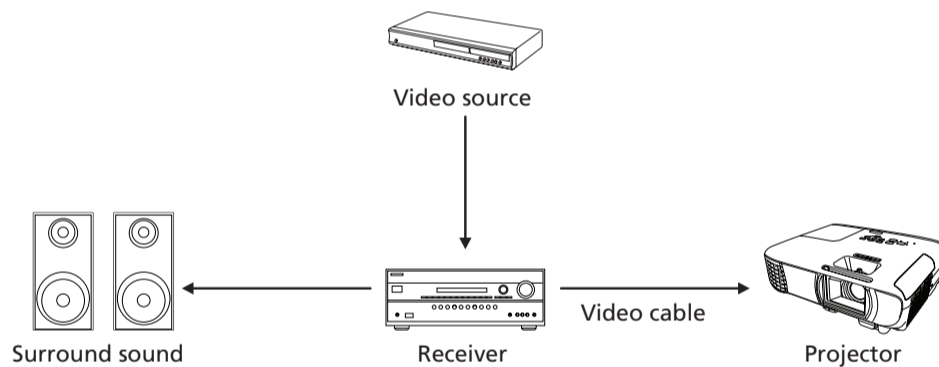

Powered speakers

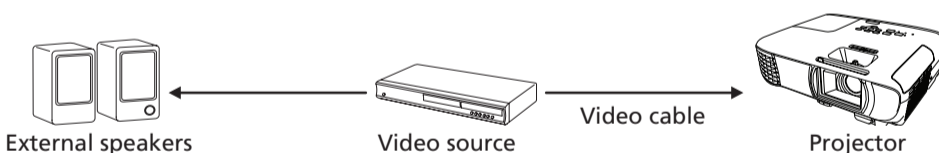

Note: See your home theater receiver documentation for more information on connections.

Turn on your equipment

- 1 Turn on your video source or computer.
- 2 Plug in the projector. The power light on the projector turns blue.

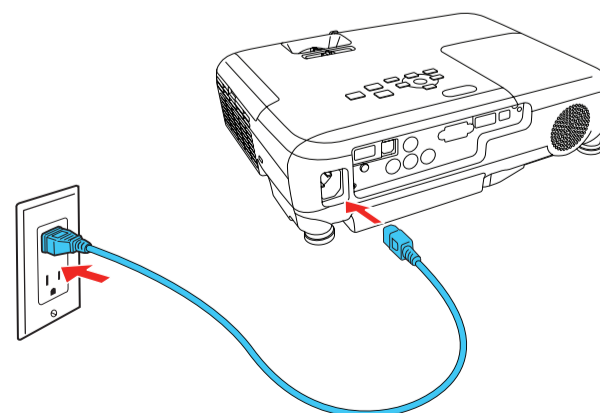

3 Open the A/V Mute slide all the way.

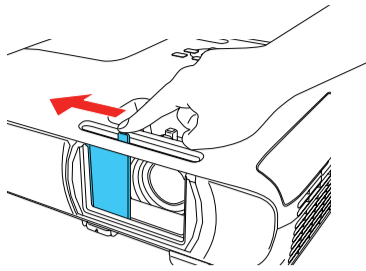

4 Press the power button on the projector or remote control. The projector beeps, the Status light flashes blue, and then stays on.

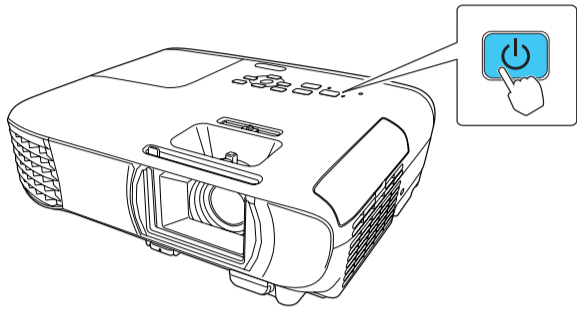

Note: To shut down the projector, press the power button twice.

5 Use the arrow buttons on the remote control to highlight any options on the Home screen that appears, then press to select it. You can switch between projection sources and quickly access various adjustment options from this screen.

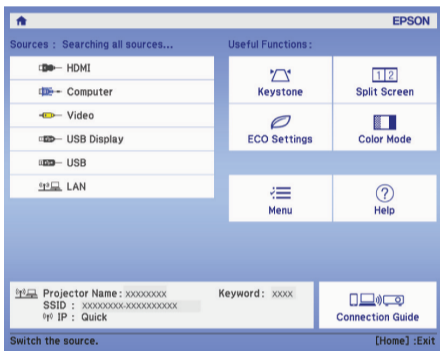

6 The default language of the menu system is English. To select another language, press the **Menu** button on the projector or the remote control. Select **Extended** and press . Select **Language** and press . Select your language and press . Press the **Menu** button to exit the menu system.

Adjust the image

1 If you don't see an image, press the **Source Search** button on the projector or the remote control to select the image source.

Note: If you still see a blank screen or have other display problems, see the tips in "Troubleshooting" on the back of this sheet.

2 To raise the image, press the foot release button and lift the front of the projector. Release the button to lock the foot in position.

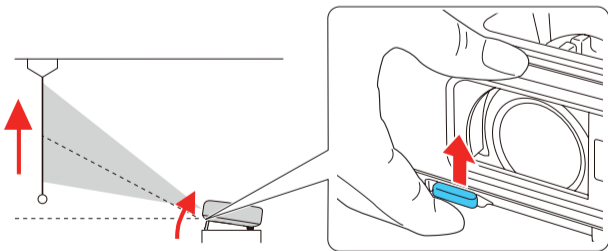

3 **Home Cinema 660:** To reduce or enlarge the image, press the **T** (reduce) or **W** (enlarge) button on the projector.

Home Cinema 760HD/1060: To reduce or enlarge the image, turn the zoom ring.

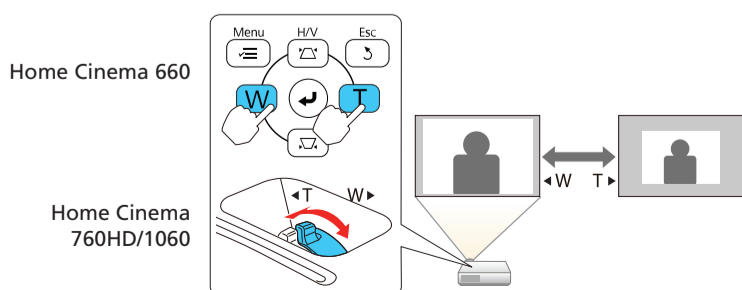

4 To sharpen the image, turn the focus ring.

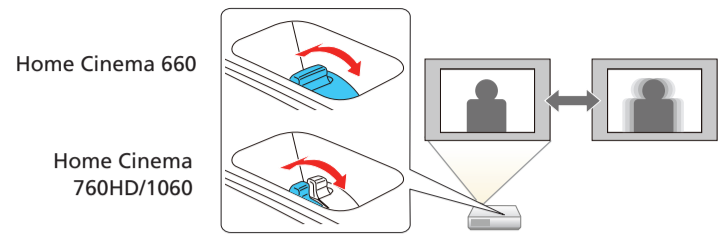

5 If your image looks like or , you may have placed the projector off to one side of the screen at an angle. Place the projector directly in front of the center of the screen, facing the screen squarely. If you can't move the projector, use the horizontal keystone slider on the projector to correct the image shape.

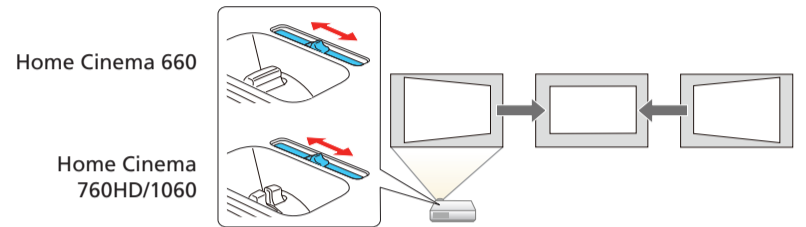

6 Your projector automatically adjusts images that look like or , but if necessary you can press the or button on the projector to correct it.

Using the remote control

Install the batteries as shown (two AA batteries).

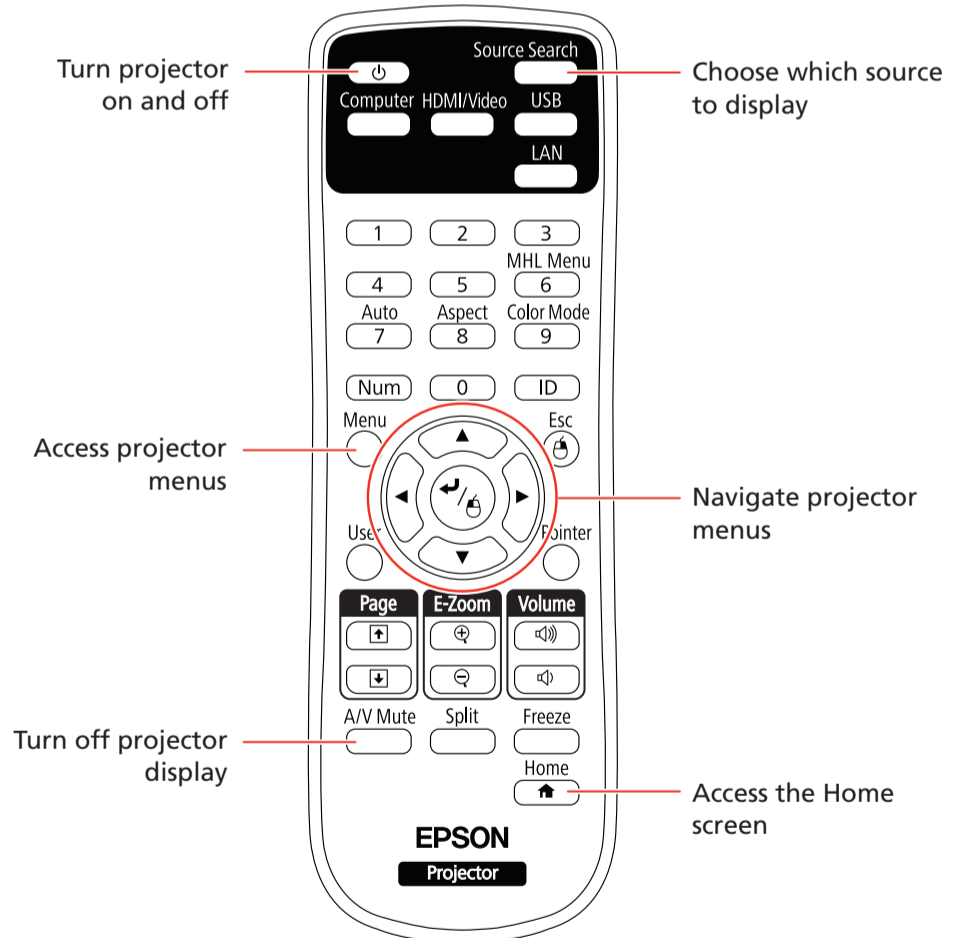
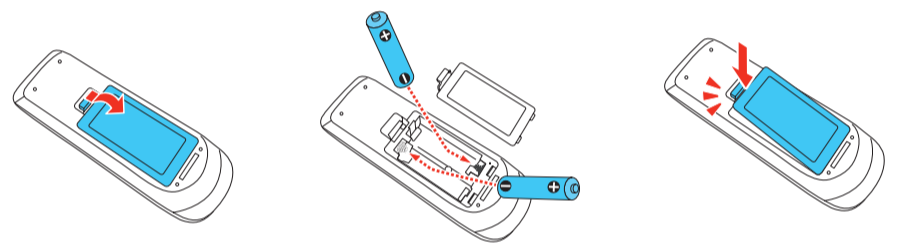

For more information on using the remote control, see the online [User's Guide](#).



Troubleshooting

If you see a blank screen or the **No signal** message after turning on your computer or video device, check the following:

- Make sure the Status light on the projector is blue and not flashing, and the A/V Mute slide is open.
- Press the **Source Search** button on the projector or remote control to switch to the correct image source, if necessary.
- Press the **Home** button on the projector or remote control to verify the source input and settings.
- On Windows® 7 or later, hold down the Windows key and press **P** at the same time, then click **Duplicate**.
- If you're using a Windows laptop, press the function key on your keyboard that lets you display on an external monitor. It may be labeled **CRT/LCD** or have an icon such as . You may have to hold down the **Fn** key while pressing it (such as **Fn + F7**). Wait a moment for the display to appear.
- If you're using a Mac laptop, open **System Preferences** and select **Displays**. Click the **Arrangement** tab and select the **Mirror Displays** checkbox.

Where to get help

Manual

For more information about using the projector, click the icon on your desktop to access the online manual (requires an Internet connection). If you don't have a User's Guide icon, you can install it from the projector CD or go to the Epson website, as described below.

Telephone support services

To use the Epson® PrivateLine® Support service, call (800) 637-7661. This service is available for the duration of your warranty period. You may also speak with a support specialist by calling (562) 276-4394 (U.S.) or (905) 709-3839 (Canada).

Support hours are 6 AM to 8 PM, Pacific Time, Monday through Friday, and 7 AM to 4 PM, Pacific Time, Saturday. Days and hours of support are subject to change without notice. Toll or long distance charges may apply.

Internet support

Visit www.epson.com/support (U.S.) or www.epson.ca/support (Canada) for solutions to common problems. You can download utilities and documentation, get FAQs and troubleshooting advice, or e-mail Epson.

Registration

Register today to get product updates and exclusive offers. You can use the CD included with your projector or register online at www.epson.com/webreg.

Optional accessories

For a list of optional accessories, see the online *User's Guide*.

You can purchase screens or other accessories from an Epson authorized reseller. To find the nearest reseller, call 800-GO-EPSON (800-463-7766). Or you can purchase online at www.epsonstore.com (U.S. sales) or www.epsonstore.ca (Canadian sales).

Notices

Declaration of Conformity

According to 47CFR, Part 2 and 15, Class B Personal Computers and Peripherals; and/or CPU Boards and Power Supplies used with Class B Personal Computers.

We: Epson America, Inc.
Located at: 3840 Kilroy Airport Way, MS: 3-13, Long Beach, CA 90806
Telephone: (562) 981-3840

Declare under sole responsibility that the product identified herein, complies with 47CFR Part 2 and 15 of the FCC rules as a Class B digital device. Each product marketed, is identical to the representative unit tested and found to be compliant with the standards. Records maintained continue to reflect the equipment being produced can be expected to be within the variation accepted, due to quantity production and testing on a statistical basis as required by 47CFR 2.909. Operation is subject to the following two conditions: (1) this device may not cause harmful interference, and (2) this device must accept any interference received, including interference that may cause undesired operation.

Trade Name: Epson
Type of Product: LCD Projector
Model: H847A/H848A/H849A
Marketing Name: Home Cinema 660/760HD/1060

Wireless LAN Safety and Specifications

Contains wireless LAN module model: WN7122BEP (Home Cinema 1060)

This document provides safety instructions and describes the specifications. Read this document carefully before use to ensure your safety and product performance.

Data transmission is always initiated by software, which is then passed down through the MAC, through the digital and analog baseband, and finally to the RF chip. Several special packets are initiated by the MAC. These are the only ways the digital baseband portion will turn on the RF transmitter, which it then turns off at the end of the packet. Therefore, the transmitter will be on only while one of the aforementioned packets is being transmitted. In other words, this device automatically discontinues transmission in case of either absence of information to transmit or operational failure.

This equipment is restricted to indoor operation only.

U.S. FCC Notices

Contains FCC ID: BKMAE-7122

This device complies with Part 15 of the FCC Rules. Operation is subject to the following two conditions: (1) This device may not cause harmful interference, and (2) this device must accept any interference received, including interference that may cause undesired operation.

This equipment has been tested and found to comply with the limits for a Class B digital device, pursuant to Part 15 of the FCC Rules. These limits are designed to provide reasonable protection against harmful interference in a residential installation. This equipment generates, uses and can radiate radio frequency energy and, if not installed and used in accordance with the instructions, may cause harmful interference to radio communications. However, there is no guarantee that interference will not occur in a particular installation. If this equipment does cause harmful interference to radio or television reception, which can be determined by turning the equipment off and on, the user is encouraged to try to correct the interference by one of the following measures:

- Reorient or relocate the receiving antenna.
- Increase the separation between the equipment and receiver.
- Connect the equipment into an outlet on a circuit different from that to which the receiver is connected.
- Consult the dealer or an experienced radio/TV technician for help.

Caution: Changes or modifications not expressly approved by the party responsible for compliance could void the user's authority to operate this equipment. Properly shielded and grounded cables and connectors must be used for connection to host computers and / or peripherals in order to meet FCC emission limits.

This transmitter must not be co-located or operating in conjunction with any other antenna or transmitter.

This equipment complies with FCC radiation exposure limits set forth for an uncontrolled environment and meets the FCC radio frequency (RF) Exposure Guidelines. This equipment should be installed and operated keeping the radiator at least 7.8 inches (20 cm) or more away from person's body.

Industry Canada (IC) Notices

Contains IC: 1052D-7122

CAN ICES-3 (B)/NMB-3 (B)

This device complies with Industry Canada's licence-exempt RSSs. Operation is subject to the following two conditions: (1) This device may not cause interference; and (2) This device must accept any interference, including interference that may cause undesired operation of the device.

This equipment complies with IC radiation exposure limits set forth for an uncontrolled environment and meets RSS-102 of the IC radio frequency (RF) Exposure rules. This equipment should be installed and operated keeping the radiator at least 7.8 inches (20 cm) or more away from person's body.

Epson America, Inc. Limited Warranty

Two-Year Projector Limited Warranty and 90-Day Lamp Limited Warranty

What Is Covered: Epson America, Inc. ("Epson") warrants to the original retail purchaser of the Epson projector product enclosed with this limited warranty statement that the product, if purchased new and operated in the United States, Canada, or Puerto Rico will be free from defects in workmanship and materials for a period of two years from the date of original purchase. This limited warranty applies only to the projector and not to the projector lamp, which carries a limited warranty period of ninety days from the date of original purchase. For warranty service, you may be required to provide proof of the date of original purchase.

What Epson Will Do To Correct Problems: If your product requires service during the limited warranty period, please call Epson at the number on the bottom of this statement and be prepared to provide the model, serial number, and, if required, date of original purchase. If Epson confirms that warranty service is required, Epson will, at its option, repair or replace the defective unit, without charge for parts or labor. If Epson authorizes an exchange for the defective unit, Epson will ship a replacement product to you, freight prepaid, so long as you use an address in the United States, Canada, or Puerto Rico. You are responsible for securely packaging the defective unit and returning it to Epson within five working days of receipt of the replacement. Epson requires a debit or a credit card number to secure the cost of the replacement product in the event that you fail to return the defective one. If Epson authorizes repair instead of exchange, Epson will direct you to send your product to Epson or its authorized service center, where the product will be repaired and sent back to you. You are responsible for packing the product and for all postage or shipping costs to and from the Epson authorized service center. When warranty service involves the exchange of the product or of a part, the item replaced becomes Epson property. The exchanged product or part may be new or refurbished to the Epson standard of quality. If service cannot be provided on the product for any reason and Epson no longer sells the same model, Epson will replace your product with a model of equal or superior value. Replacement products or parts assume the remaining warranty period of the original product. If Epson replaces the lamp as part of the warranty service, the replacement lamp carries the limited 90-day warranty stated above.

What This Warranty Does Not Cover: This warranty covers only normal use in the United States, Canada, or Puerto Rico.

This warranty does not cover the following:

- Excessive continual use
- Consumables such as filters
- Installation or removal
- Cosmetic damage caused by handling or normal wear and tear during usage
- Damage caused by failure to properly maintain the projector (see your online User's Guide for details)
- Damage caused by interaction with non-Epson products, such as add-in cards or cables
- Any problem resulting from misuse, abuse, improper installation, neglect, improper shipping, disasters such as fire, flood, and lightning, improper electrical current, software problems, exposure to chemical smoke, or excessive humidity
- Any problem resulting from service by other than Epson or an Epson Authorized Servicer

Epson is not responsible for warranty service should the Epson label or logo or the rating label or serial number be removed. This warranty is not transferrable. Epson is not responsible for your data or applications, which cannot be restored and should be backed up by you. Postage, insurance, or shipping costs incurred in presenting your Epson product for carry-in warranty service are your responsibility. If a claimed defect cannot be identified or reproduced in service, you will be held responsible for costs incurred.

DISCLAIMER OF OTHER WARRANTIES: THE WARRANTY AND REMEDY PROVIDED ABOVE ARE EXCLUSIVE AND IN LIEU OF ALL OTHER EXPRESS OR IMPLIED WARRANTIES INCLUDING, BUT NOT LIMITED TO, THE IMPLIED WARRANTIES OF MERCHANTABILITY, NONINFRINGEMENT OR FITNESS FOR A PARTICULAR PURPOSE. SOME LAWS DO NOT ALLOW THE EXCLUSION OF IMPLIED WARRANTIES. IF THESE LAWS APPLY, THEN ALL EXPRESS AND IMPLIED WARRANTIES ARE LIMITED TO THE WARRANTY PERIOD IDENTIFIED ABOVE. UNLESS STATED HEREIN, ANY STATEMENTS OR REPRESENTATIONS MADE BY ANY OTHER PERSON OR FIRM ARE VOID.

EXCLUSION OF DAMAGES; EPSON'S MAXIMUM LIABILITY: IN NO EVENT SHALL EPSON OR ITS AFFILIATES BE LIABLE FOR ANY SPECIAL, INCIDENTAL, OR CONSEQUENTIAL DAMAGES OR ANY LOST PROFITS RESULTING FROM THE USE OR INABILITY TO USE THE EPSON PRODUCT, WHETHER RESULTING FROM BREACH OF WARRANTY OR ANY OTHER LEGAL THEORY. IN NO EVENT SHALL EPSON OR ITS AFFILIATES BE LIABLE FOR DAMAGES OF ANY KIND IN EXCESS OF THE ORIGINAL RETAIL PURCHASE PRICE OF THE PRODUCT.

Arbitration, Governing Laws: Any dispute, claim or controversy arising out of or relating to this warranty shall be determined by arbitration in Los Angeles County, California before a single arbitrator. The arbitration shall be administered by JAMS pursuant to its Comprehensive Arbitration Rules and Procedures. Judgment on the award may be entered in any court having jurisdiction. Any action must be brought within three months of the expiration of the warranty. This clause shall not preclude parties from seeking provisional remedies in aid of arbitration from a court of appropriate jurisdiction. This warranty shall be construed in accordance with the laws of the State of California, except this arbitration clause which shall be construed in accordance with the Federal Arbitration Act.

Other Rights You May Have: This warranty gives you specific legal rights, and you may also have other rights which vary from jurisdiction to jurisdiction. Some jurisdictions do not allow limitations on how long an implied warranty lasts, or allow the exclusion or limitation of incidental or consequential damages, so the above limitations or exclusions may not apply to you.

In Canada, warranties include both warranties and conditions.

To find the Epson Authorized Reseller nearest you, please visit www.epson.com in the U.S. or www.epson.ca in Canada.

To find the Epson Customer Care Center nearest you, please visit www.epson.com/support in the U.S. or www.epson.ca/support in Canada.

To contact the Epson ConnectionSM, please call (800) 637-7661 or (562) 276-4394 in the U.S. and (905) 709-3839 in Canada or write to Epson America, Inc., P.O. Box 93012, Long Beach, CA 90809-3012.

EPSON
EXCEED YOUR VISION



EPSON is a registered trademark and EPSON Exceed Your Vision is a registered logomark of Seiko Epson Corporation. PrivateLine is a registered trademark and Epson Connection is a service mark of Epson America, Inc.

Mac is a trademark of Apple Inc., registered in the U.S. and other countries.

General Notice: Other product names used herein are for identification purposes only and may be trademarks of their respective owners. Epson disclaims any and all rights in those marks.

This information is subject to change without notice.

© 2017 Epson America, Inc., 4/17

Free Manuals Download Website

<http://myh66.com>

<http://usermanuals.us>

<http://www.somanuals.com>

<http://www.4manuals.cc>

<http://www.manual-lib.com>

<http://www.404manual.com>

<http://www.luxmanual.com>

<http://aubethermostatmanual.com>

Golf course search by state

<http://golfingnear.com>

Email search by domain

<http://emailbydomain.com>

Auto manuals search

<http://auto.somanuals.com>

TV manuals search

<http://tv.somanuals.com>