

**EPSON**<sup>®</sup>  
EXCEED YOUR VISION

androidtv



# User's Guide

Multimedia Projector

CO-FH02

## **Notations Used in This Guide** **5**

---

### **Using the Manual to Search for Information** ..... **6**

- Searching by Keyword ..... 6
- Jumping Directly from Bookmarks..... 6
- Printing Only the Pages You Need..... 6

### **Getting the Latest Version of the Documents**..... **7**

## **Introduction to Your Projector** **8**

---

### **Projector Parts and Functions** ..... **9**

- Projector Parts - Front ..... 9
- Projector Parts - Side..... 10
- Projector Parts - Rear..... 10
- Projector Parts - Base ..... 11
- Projector Parts - Projector Remote Control..... 11
- Projector Parts - Remote Control for Streaming Media Player ..... 13

## **Setting Up the Projector** **15**

---

### **Projector Placement** ..... **16**

- Precautions on Installation ..... 17
- Projector Setup and Installation Options..... 17
- Projection Distance..... 18

### **Installing Batteries in the Remote Control**..... **19**

- Remote Control Operation ..... 19

### **Projector Connections** ..... **21**

- Connecting to Video Sources ..... 21
  - Connecting to an HDMI Video Source ..... 21
- Connecting to a Computer..... 22
  - Connecting to a Computer for HDMI Video and Audio ..... 22
  - Connecting to an iPad/iPhone ..... 22

- Connecting to a Streaming Media Player ..... 23

## **Using Basic Projector Features** **24**

---

### **Turning On the Projector** ..... **25**

- Setting Up Android TV on the Streaming Media Player..... 26

### **Turning Off the Projector** ..... **28**

### **Selecting the Language for the Projector Menus** ..... **29**

### **Projection Modes** ..... **30**

- Changing the Projection Mode Using the Remote Control..... 30
- Changing the Projection Mode Using the Menus ..... 30

### **Displaying a Test Pattern** ..... **32**

### **Adjusting the Image Height**..... **33**

### **Image Shape** ..... **34**

- Auto V-Keystone ..... 34
- Correcting the Image Shape with the Keystone Button ..... 34
- Correcting the Image Shape with Quick Corner ..... 35

### **Focusing the Image Using the Focus Lever** ..... **37**

### **Resizing the Image with Zoom** ..... **38**

### **Adjusting the Image Position Using Image Shift**..... **39**

### **Image Aspect Ratio** ..... **40**

- Changing the Image Aspect Ratio ..... 40
- Available Image Aspect Ratios ..... 40

### **Adjusting Image Quality (Color Mode)** ..... **42**

- Changing the Color Mode ..... 42
- Available Color Modes..... 42

### **Controlling the Volume with the Volume Buttons** ..... **43**

## **Adjusting Projector Features 44**

Shutting Off the Image and Sound Temporarily (A/V Mute).....	45
Turning Off the Sound Temporarily (Mute).....	46
Stopping Video Action Temporarily .....	47
Zooming Images (E-Zoom).....	48
Saving a User's Logo Image .....	49
Saving a User Pattern .....	51
<b>Projector Security Features.....</b>	<b>52</b>
Password Security Types .....	52
Setting a Password.....	52
Selecting Password Security Types.....	53
Entering a Password to Use the Projector .....	54
Installing a Security Cable.....	54

## **Adjusting the Menu Settings 55**

<b>Using the Projector's Menus .....</b>	<b>56</b>
<b>Using the Displayed Keyboard .....</b>	<b>57</b>
Available Text Using the Displayed Keyboard .....	57
<b>Image Quality Settings - Image Menu.....</b>	<b>58</b>
<b>Projector Feature Settings - Settings Menu .....</b>	<b>60</b>
<b>Projector Information Display - Info Menu .....</b>	<b>62</b>
Info Menu - Projector Info Menu .....	62
<b>Projector Reset Options - Reset Menu .....</b>	<b>63</b>
<b>Copying Menu Settings Between Projectors (Batch Setup) .....</b>	<b>64</b>
Transferring Settings From a USB Flash Drive.....	64
Transferring Settings From a Computer .....	65
Batch Setup Error Notification.....	66

## **Maintaining the Projector 67**

<b>Projector Maintenance .....</b>	<b>68</b>
<b>Cleaning the Lens.....</b>	<b>69</b>
<b>Cleaning the Projector Case.....</b>	<b>70</b>
<b>Cleaning the Air Vents .....</b>	<b>71</b>

## **Solving Problems 72**

<b>Projection Problems.....</b>	<b>73</b>
<b>Projector Indicator Status .....</b>	<b>74</b>
<b>Solving Projector Power-On or Power-Off Problems .....</b>	<b>76</b>
Solving Projector Power Problems .....	76
When the Projector Lamp does not Turn on .....	76
Solving Projector Shutdown Problems.....	76
<b>Solving Image Problems .....</b>	<b>77</b>
Solving Missing Image Problems .....	77
Adjusting an Image that is not Rectangular .....	77
Adjusting a Fuzzy or Blurry Image.....	78
Fixing Partial Image Problems.....	78
Adjusting an Image that Contains Noise or Static.....	78
Adjusting a Flickering Image .....	79
Adjusting an Image with Incorrect Brightness or Colors .....	79
Adjusting an Upside-down Image.....	79
<b>Solving Sound Problems .....</b>	<b>81</b>
<b>Solving Remote Control Operation Problems.....</b>	<b>82</b>
<b>Solving HDMI Link Problems .....</b>	<b>83</b>
<b>Solving Epson Streaming Media Player Problems.....</b>	<b>84</b>
<b>When the Message "It is time to replace the projector." is Displayed .....</b>	<b>85</b>



<b>Appendix</b>	<b>86</b>
<b>Optional Accessories and Replacement Parts</b> .....	<b>87</b>
External Devices.....	87
<b>Screen Size and Projection Distance</b> .....	<b>88</b>
<b>Supported Monitor Display Resolutions</b> .....	<b>89</b>
<b>Projector Specifications</b> .....	<b>90</b>
Connector Specifications.....	90
<b>External Dimensions</b> .....	<b>91</b>
<b>List of Safety Symbols and Instructions</b> .....	<b>92</b>
<b>Warning Labels</b> .....	<b>94</b>
<b>Glossary</b> .....	<b>95</b>
<b>Notices</b> .....	<b>96</b>
FCC Compliance Statement .....	96
Indication of the manufacturer and the importer in accordance with requirements of EU directive .....	97
Indication of the manufacturer and the importer in accordance with requirements of United Kingdom directive .....	97
Restriction of Use.....	97
How to Dispose of the Projector .....	97
Operating System References .....	97
Trademarks .....	98
Copyright Notice .....	98
Copyright Attribution .....	98

# Notations Used in This Guide







## Safety Symbols

The projector and its manuals use graphical symbols and labels to indicate content that tells you how to use the projector safely.

Read and carefully follow the instructions that are marked with these symbols and labels to avoid injury to persons or damage to property.

 <b>Warning</b>	This symbol indicates information that, if ignored, could possibly result in personal injury or even death.
 <b>Caution</b>	This symbol indicates information that, if ignored, could possibly result in personal injury or physical damage due to incorrect handling.

## General Information Notations

<b>Attention</b>	This label indicates procedures that may result in damage or injury if sufficient care is not taken.
	This label indicates additional information that may be useful to know.
 button	Indicates the buttons on the remote control or the control panel. Example:  button
<b>Menu/Setting name</b>	Indicates projector menu and setting names. Example: Select the <b>Image</b> menu.  <b>Image &gt; Color</b>
	This label indicates links to the related pages.
	This label indicates the projector's current menu level.

## » Related Links

- "Using the Manual to Search for Information" [p.6](#)
- "Getting the Latest Version of the Documents" [p.7](#)

The PDF manual allows you to search for information you are looking for by keyword, or jump directly to specific sections using the bookmarks. You can also print only the pages you need. This section explains how to use a PDF manual that has been opened in Adobe Reader X on your computer.

### ► Related Links

- "Searching by Keyword" p.6
- "Jumping Directly from Bookmarks" p.6
- "Printing Only the Pages You Need" p.6

- Mac OS: Hold down the command key, and then press ←.

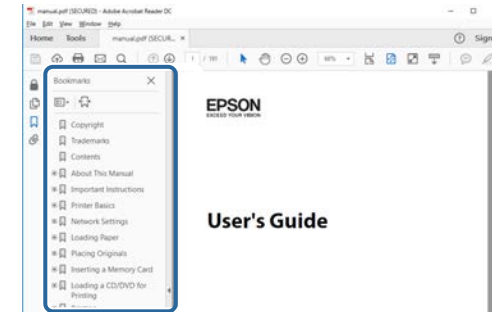

## Searching by Keyword

Click **Edit > Advanced Search**. Enter the keyword (text) for information you want to find in the search window, and then click **Search**. Hits are displayed as a list. Click one of the displayed hits to jump to that page.

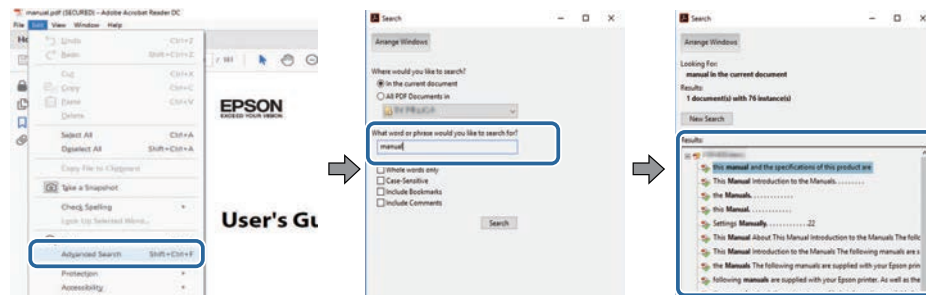

## Printing Only the Pages You Need

You can extract and print only the pages you need. Click **Print** in the **File** menu, and then specify the pages you want to print in **Pages in Pages to Print**.

- To specify a series of pages, enter a hyphen between the start page and the end page.  
Example: 20-25
- To specify pages that are not in series, divide the pages with commas.  
Example: 5, 10, 15

## Jumping Directly from Bookmarks

Click a title to jump to that page. Click + or > to view the lower level titles in that section. To return to the previous page, perform the following operation on your keyboard.

- Windows: Hold down **Alt**, and then press ←.

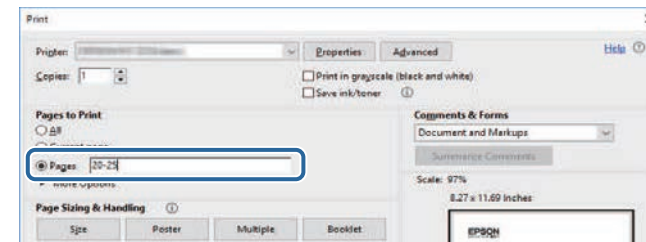

You can get the latest version of the manuals and specifications on the Epson Web site.

Visit [epson.sn](http://epson.sn), and enter your model name.

# Introduction to Your Projector

Refer to these sections to learn more about your projector's features and part names.

## ► **Related Links**

- "Projector Parts and Functions" [p.9](#)



The following sections explain the projector parts and their functions.

► **Related Links**

- "Projector Parts - Front" [p.9](#)
- "Projector Parts - Side" [p.10](#)
- "Projector Parts - Rear" [p.10](#)
- "Projector Parts - Base" [p.11](#)
- "Projector Parts - Projector Remote Control" [p.11](#)
- "Projector Parts - Remote Control for Streaming Media Player" [p.13](#)

## Projector Parts - Front

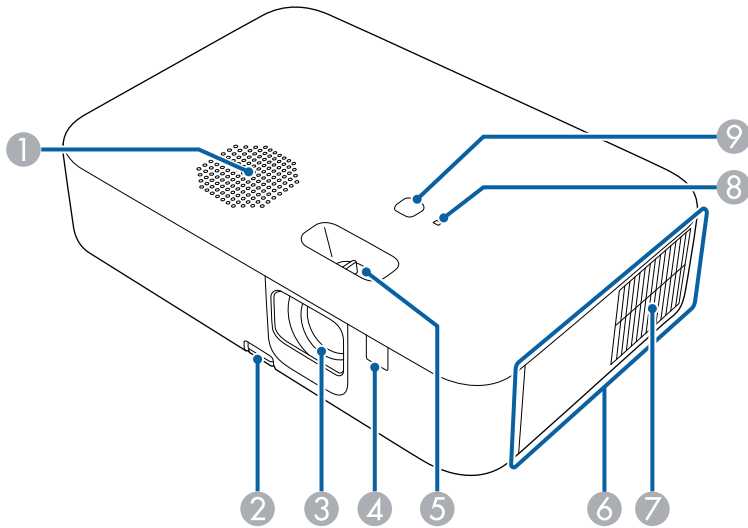

Name	Function
① Speaker	Outputs audio.
② Foot release lever	Press the foot release lever to extend and retract the front adjustable foot.
③ Lens	Images are projected from here.

Name	Function
④ Remote receiver	Receives signals from the remote control.
⑤ Focus lever	Adjusts the image focus.
⑥ Side cover	Open to use the HDMI port, Service port, and DC Out (2.0A) port.
⑦ Air intake vent	Takes in air to cool the projector internally.
⑧ Status indicator	Indicates the projector's status.
⑨ Power button [ ⏻ ]	Turn the projector on or off.

► **Related Links**

- "Projector Indicator Status" [p.74](#)
- "Remote Control Operation" [p.19](#)
- "Focusing the Image Using the Focus Lever" [p.37](#)
- "Cleaning the Air Vents" [p.71](#)
- "Adjusting the Image Height" [p.33](#)

## Projector Parts - Side

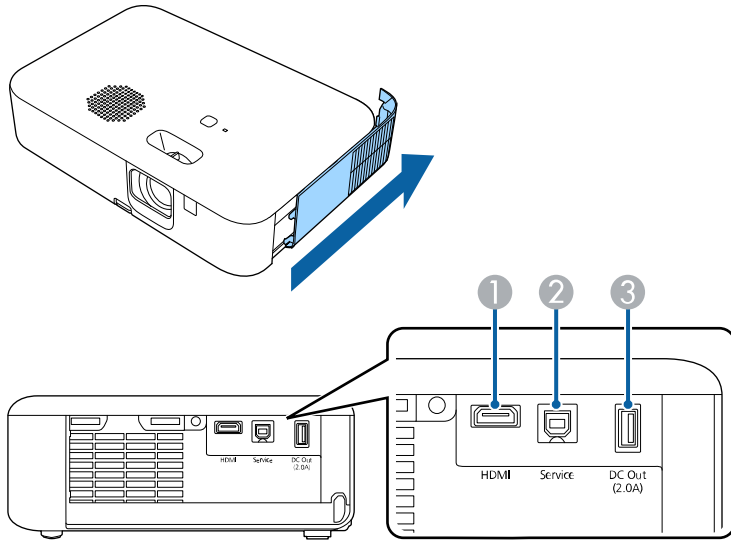

Name	Function
① HDMI port	Inputs video signals from HDMI compatible video equipment and computers. This port is compatible with HDCP 2.3.
② Service port	This port is not normally used.
③ USB-A (DC Out (2.0A)) port	Connects to a streaming media player to power it. Use to connect a USB memory device to save error and operation log files. It is also used for batch settings and firmware update. Hereinafter referred to as the USB-A port.

## Projector Parts - Rear

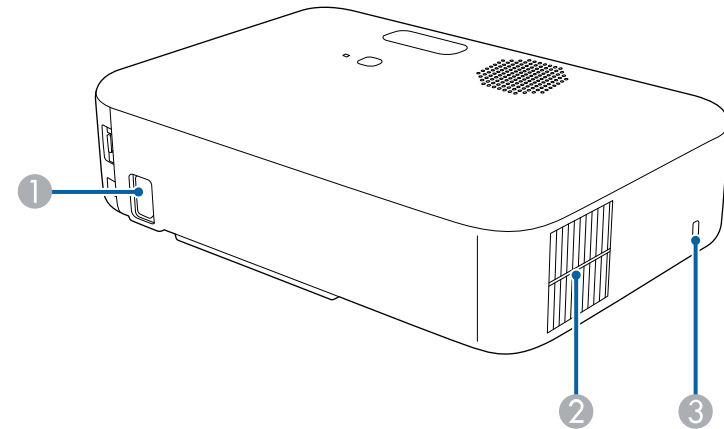

Name	Function
① Power inlet	Connects the power cord to the projector.
② Air exhaust vent	Exhaust vent for air used to cool the projector internally.

**⚠ Warning**

Do not look into the vents. If the lamp explodes, gases may escape and small fragments of glass may be scattered which could cause an injury. Contact a doctor if any fragments of broken glass are inhaled or get into the eyes or mouth.

### » Related Links

- "Projector Connections" [p.21](#)

Name	Function
	<p><b>⚠ Caution</b></p> <p>While projecting, do not put your face or hands near the air exhaust vent, and do not place objects that may become warped or damaged by heat near the vent. Hot air from the air exhaust vent could cause burns, warping, or accidents to occur.</p>
3 Security slot	The security slot is compatible with the Microsaver Security System manufactured by Kensington.

» **Related Links**

- "Installing a Security Cable" [p.54](#)

Name	Function
1 Air intake vent	Takes in air to cool the projector internally.
2 Front adjustable foot	When the projector is set up on a surface such as a desk, extend the foot to adjust the position of the image.

» **Related Links**

- "Adjusting the Image Height" [p.33](#)

---

## Projector Parts - Projector Remote Control

You can operate your projector using this remote control.





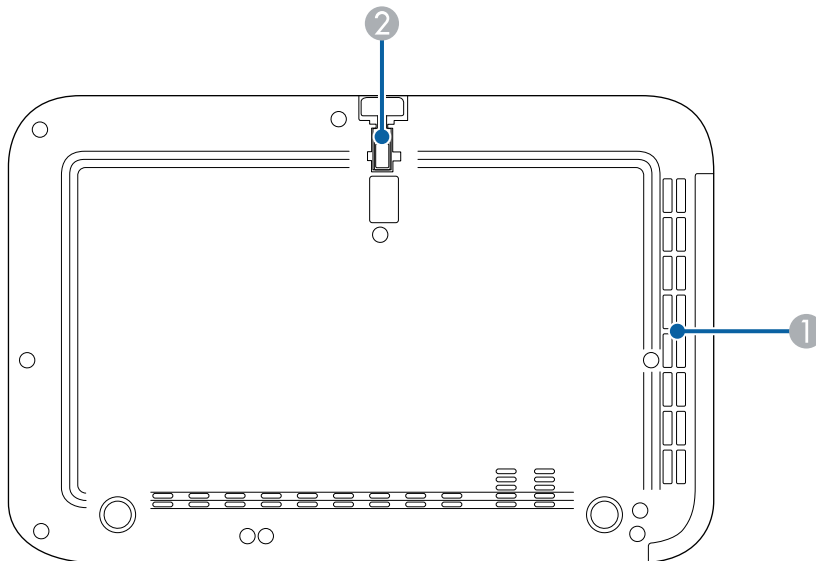

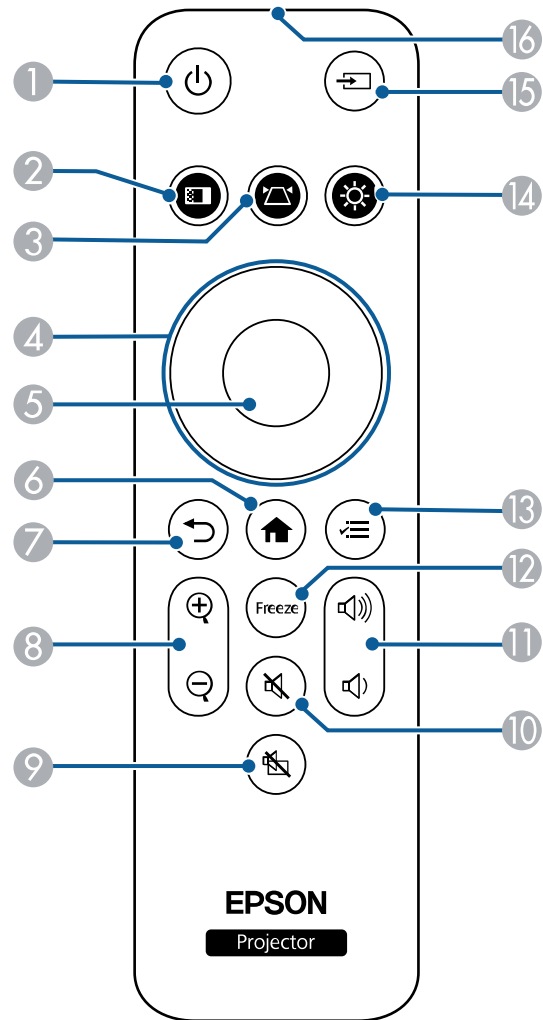

---



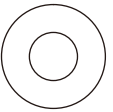

## Projector Parts - Base



Unless otherwise stated, all of the operations using a remote control in this guide are explained using this remote control.



Name		Function
1	Power button 	Turns the projector on or off.
2	Color Mode button 	Changes the color mode.
3	Keystone button 	Displays the <b>Keystone</b> adjustment screen or the <b>Quick Corner</b> screen.
4	Arrow buttons 	Selects menu items while displaying the projector's menu. When the ▲▼ or ◀▶ icons are displayed on the menu screen, use these buttons to select the menu items.
5	[Enter] button 	Enters the current selection and moves to the next level while displaying the projector's menu.
6	Home button 	Displays the Android TV™ home screen when you are using the streaming media player.
7	Esc button 	Stops the current function. Moves back to the previous menu level while displaying the projector's menu.
8	E-Zoom buttons 	Zooms into an area of the projected image and enlarges it on the screen.
9	A/V Mute button 	Turns the video and audio on or off temporarily.
10	Mute button 	Turns the audio on or off temporarily.

Name	Function
11 Volume up/down buttons 	Adjusts the volume for the speaker and headphones.
12 Freeze button 	Pauses or resumes images.
13 Menu button 	Displays and closes the projector's menu. You can use the projector's menus to adjust the settings that control how your projector works.
14 Brightness button 	Adjusts the brightness of the projected image.
15 Source button 	This button is not used.
16 Remote control light emitting area	Outputs remote control signals.







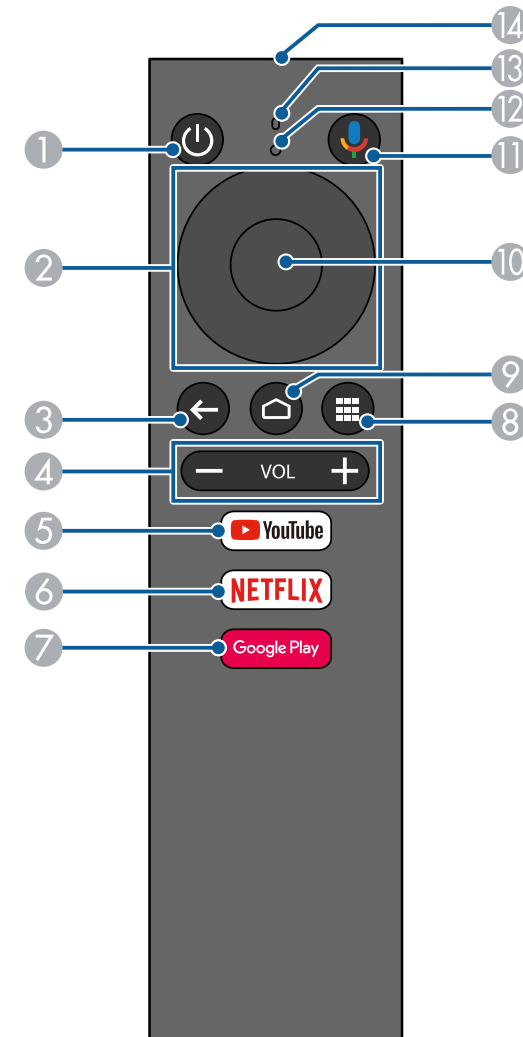

» **Related Links**

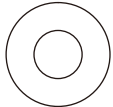
- "Zooming Images (E-Zoom)" [p.48](#)
- "Adjusting Image Quality (Color Mode)" [p.42](#)
- "Correcting the Image Shape with the Keystone Button" [p.34](#)
- "Using the Projector's Menus" [p.56](#)

## Projector Parts - Remote Control for Streaming Media Player

You can operate the Epson streaming media player (ELPAP12) using this remote control.



Name	Function
① Power button 	Turns the Epson streaming media player on or off.
② Directional pad 	Selects menu items.
③ Esc button 	Moves back to the previous menu level.
④ Volume up/down buttons 	Adjusts the volume for the Epson streaming media player.
⑤ YouTube button 	Starts the YouTube application.
⑥ Netflix button 	Starts the Netflix application.
⑦ Google Play button 	Opens Google Play.
⑧ Applications button 	Displays a list of the applications.
⑨ Home button 	Displays the Android TV home screen.
⑩ Enter button 	Enters the current selection and moves to the next level.

Name	Function
① Google Assistant button 	Allows you to quickly search 400,000+ movies and shows, get recommendations to match your mood, control smart home devices, and more.
② Indicator 	Turns on when outputting signals from the remote control.
③ Microphone 	Detects audio when you press the Google Assistant button.
④ Remote control light emitting area 	Outputs remote control signals.

» **Related Links**

- "Setting Up Android TV on the Streaming Media Player" [p.26](#)

# Setting Up the Projector

Follow the instructions in these sections to set up your projector.

## ► Related Links

- "Projector Placement" [p.16](#)
- "Installing Batteries in the Remote Control" [p.19](#)
- "Projector Connections" [p.21](#)

You can place the projector on almost any flat surface to project an image.

Note the following points when selecting a projector location:

- Place the projector on a sturdy and level surface.

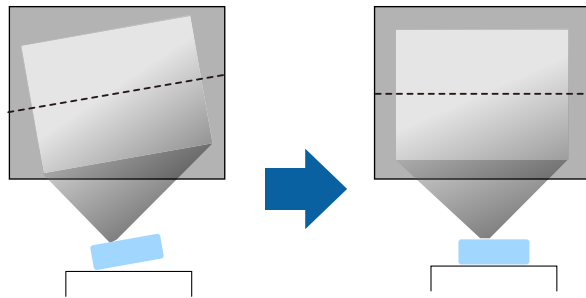

- Leave plenty of space around and under the projector for ventilation, and do not place it on top of or next to anything that could block the vents.
- Place the projector so it squarely faces the screen, not at an angle.

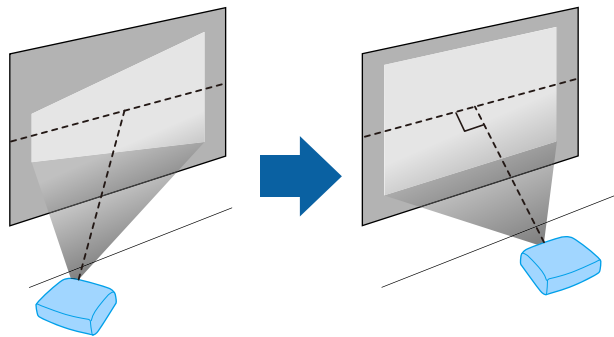

If you cannot install the projector squarely facing the screen, correct any resulting keystone distortion using the projector controls. For the best quality images, we recommend adjusting the installation position of the projector to achieve the correct image size and shape.

## Warning

- Do not install the projector in a location subject to high levels of dust or humidity, or in a location subject to smoke or steam. Otherwise, it could cause a fire or electric shock to occur.

## Warning

- Do not cover the projector's air intake or air exhaust vents. If the vents are covered, the internal temperature could rise and cause a fire.
- Do not use or store the projector in locations where it will be subject to dust or dirt. Otherwise, the quality of the projected image may decline, or the air filter may become clogged, resulting in a malfunction or fire.
- Do not install the projector on an unstable surface or in a location beyond the weight specifications of the projector. Otherwise, it could fall or topple causing an accident and injury.
- Do not use the projector on a flammable surface (such as a newspaper, plastic sheet, or carpet) or an electric carpet. The high heat generated by the projector could deform or discolor them, resulting in a fire.
- When installing the projector in a high position, take measures to prevent falling to ensure safety in an emergency, such as an earthquake, and to prevent accidents. If it is not installed correctly, it could fall causing an accident and injury.
- Do not install in locations where salt damage could occur, or in locations subject to corrosive gas such as sulphuric gas from hot springs. Otherwise, corrosion could cause the projector to fall. It could also cause the projector to malfunction.
- When using the projector outdoors at night, be careful not to trip over any extension power cords you are using. Otherwise, the projector could fall or topple causing an accident and injury.



## Attention

- Do not operate the projector on its side. This may cause the projector to malfunction.
- If you are using the projector at altitudes above 1,500 m, set the **High Altitude Mode** setting to **On** in the projector's menu to ensure the projector's internal temperature is regulated properly.  
☛ **Settings > Operation > High Altitude Mode**
- Try not to setup the projector in locations subject to high humidity and dust, or in locations subject to smoke from fires or tobacco smoke.

## » Related Links

- "Precautions on Installation" [p.17](#)
- "Projector Setup and Installation Options" [p.17](#)
- "Projection Distance" [p.18](#)
- "Image Shape" [p.34](#)
- "Projector Feature Settings - Settings Menu" [p.60](#)
- "Adjusting the Image Height" [p.33](#)
- "Focusing the Image Using the Focus Lever" [p.37](#)

## Precautions on Installation

Note the following precautions when installing the projector.

## Installation space

### Attention

- Be sure to leave the following amount of space around the projector so as not to block the air exhaust and intake vents.
- Do not install the projector in a location that does not allow air to circulate, such as on a shelf or in a box.

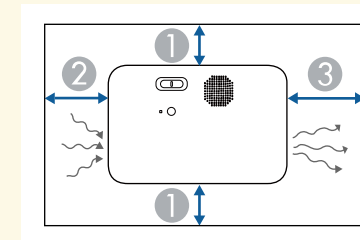

- ① 10 cm
- ② 20 cm
- ③ 30 cm

## Projector Setup and Installation Options

You can set up or install your projector in the following ways:

Front/Rear

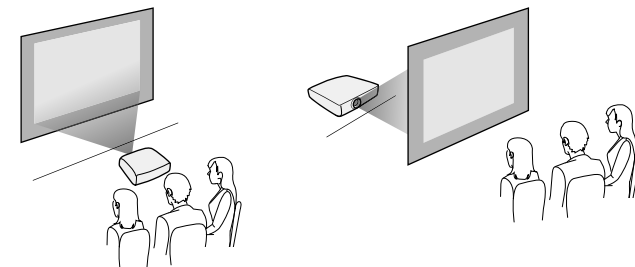

Make sure you select the correct **Projection** option in the projector's **Settings** menu according to the installation method being used.

☛ **Settings > Installation > Projection**

» **Related Links**

- "Projection Modes" [p.30](#)

---

## Projection Distance

The distance at which you place the projector from the screen determines the approximate size of the image. The image size increases the farther the projector is from the screen, but can vary depending on the zoom factor, aspect ratio, and other settings.

See the Appendix for details about how far to place the projector from the screen based on the size of the projected image.



When correcting keystone distortion, your image is slightly smaller.

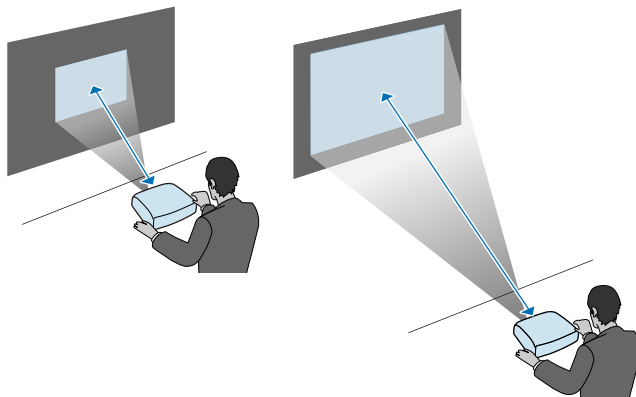

» **Related Links**

- "Screen Size and Projection Distance" [p.88](#)

The remote control uses the two AAA batteries that came with the projector.

## Attention

Make sure you read the *Safety Instructions* before handling the batteries.

- 1 Remove the battery cover as shown.

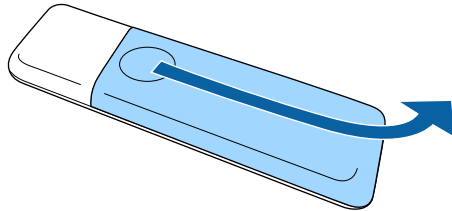

- 2 Remove the old batteries, if necessary.



Dispose of used batteries according to local regulations.

- 3 Insert the batteries with the + and - ends facing as shown.

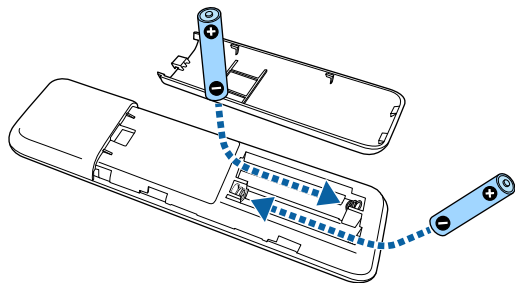

## Warning

Check the positions of the (+) and (-) marks inside the battery holder to ensure the batteries are inserted the correct way. If the batteries are not used correctly, they could explode or leak causing a fire, injury, or damage to the product.

- 4 Replace the battery cover and press it down until it clicks into place.

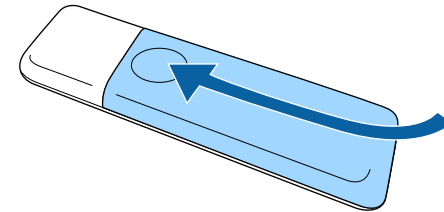

## » Related Links

- "Remote Control Operation" [p.19](#)

---

## Remote Control Operation

The remote control lets you control the projector from almost anywhere in the room.

Make sure that you aim the remote control at the projector's receivers within the distance and angles listed here.

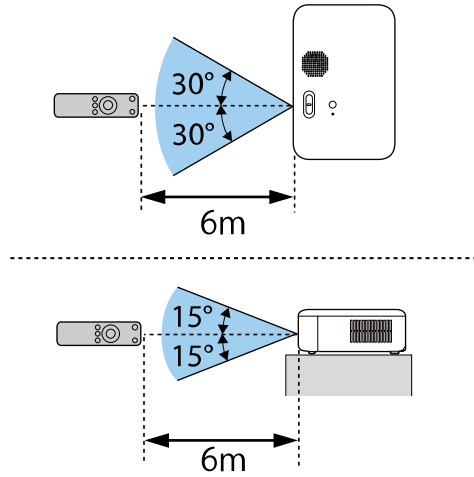

- Avoid using the remote control in conditions with bright fluorescent lights or in direct sunlight, or the projector may not respond to commands. If you are not going to use the remote control for a long time, remove the batteries.

See these sections to connect the projector to a variety of projection sources.

## Attention

- Check the shape and orientation of the connectors on any cable you plan to connect. Do not force a connector into a port if it does not fit. The device or your projector could be damaged or could malfunction.



See the *Quick Start Guide* for a list of cables supplied with your projector. Purchase optional or commercially available cables when necessary.

## » Related Links

- "Connecting to Video Sources" [p.21](#)
- "Connecting to a Computer" [p.22](#)
- "Connecting to a Streaming Media Player" [p.23](#)

---

## Connecting to Video Sources

Follow the instructions in these sections to connect video devices to the projector.



- If the port on the device you connect has an unusual shape, use the cable supplied with the device or an optional cable to connect to the projector.
- The cable differs depending on the output signal from the connected video devices.
- Some video devices are capable of outputting different types of signals. See your video device manual to confirm what type of signals can be output.

## » Related Links

- "Connecting to an HDMI Video Source" [p.21](#)

## Connecting to an HDMI Video Source

If your video source has an HDMI port, you can connect it to the projector using an HDMI cable and send the image source's audio with the projected image.

## Attention

Do not turn on the video source before connecting it to the projector. Doing so could damage the projector.

- 1** Remove the side cover by sliding it toward the rear.

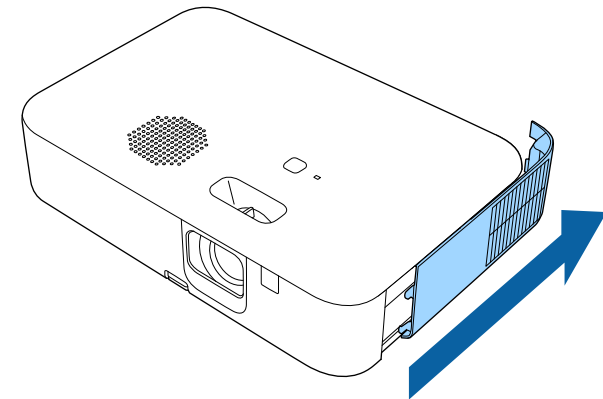

- 2** Connect the HDMI cable to your video source's HDMI output port.

**3** Connect the other end to the projector's HDMI port.

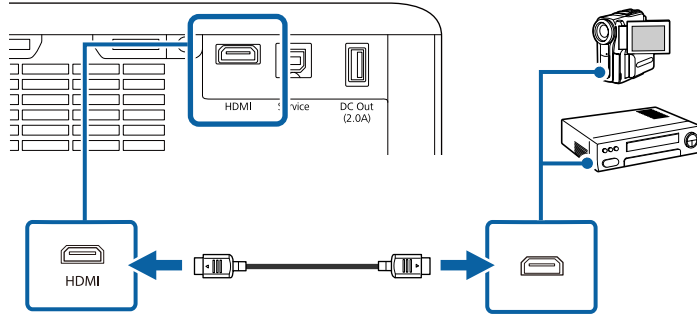

**1** Remove the side cover by sliding it toward the rear.

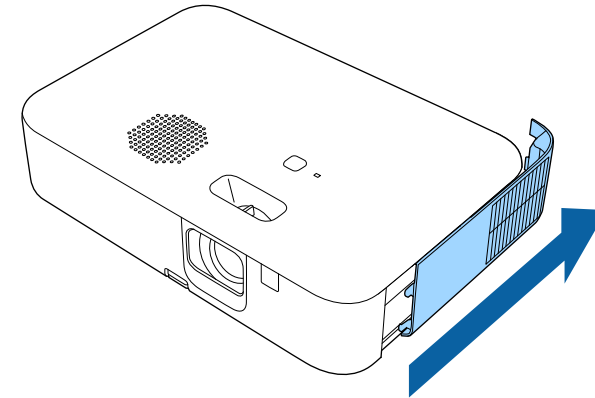

## Connecting to a Computer

Follow the instructions in these sections to connect a computer to the projector.

### » Related Links

- "Connecting to a Computer for HDMI Video and Audio" [p.22](#)
- "Connecting to an iPad/iPhone" [p.22](#)

## Connecting to a Computer for HDMI Video and Audio

If your computer has an HDMI port, you can connect it to the projector using an HDMI cable and send the computer's audio with the projected image.

**2** Connect the HDMI cable to your computer's HDMI output port.

**3** Connect the other end to the projector's HDMI port.

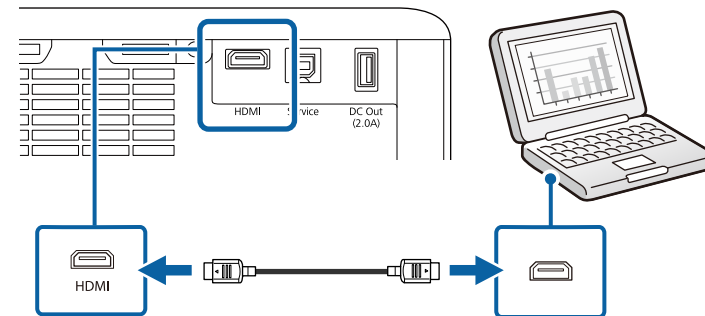

## Connecting to an iPad/iPhone

You can connect your iPad/iPhone to project videos. To connect your device to the projector's HDMI port, use a commercially available cable such as an HDMI conversion adapter.

---

## Connecting to a Streaming Media Player

You can connect your streaming media player to the projector's HDMI port. By connecting the power supply USB cable, you can power the streaming media player from the projector.

When you turn on the projector for the first time, a screen prompting you to connect the streaming media player is displayed. Follow the on-screen instructions to connect it to the projector.

# Using Basic Projector Features

Follow the instructions in these sections to use your projector's basic features.

## ► Related Links

- "Turning On the Projector" [p.25](#)
- "Turning Off the Projector" [p.28](#)
- "Selecting the Language for the Projector Menus" [p.29](#)
- "Projection Modes" [p.30](#)
- "Displaying a Test Pattern" [p.32](#)
- "Adjusting the Image Height" [p.33](#)
- "Image Shape" [p.34](#)
- "Focusing the Image Using the Focus Lever" [p.37](#)
- "Resizing the Image with Zoom" [p.38](#)
- "Adjusting the Image Position Using Image Shift" [p.39](#)
- "Image Aspect Ratio" [p.40](#)
- "Adjusting Image Quality (Color Mode)" [p.42](#)
- "Controlling the Volume with the Volume Buttons" [p.43](#)



Turn on the computer or video device you want to use after you turn on the projector.

- 1** Connect the power cord to the projector's power inlet and plug it into an electrical outlet.

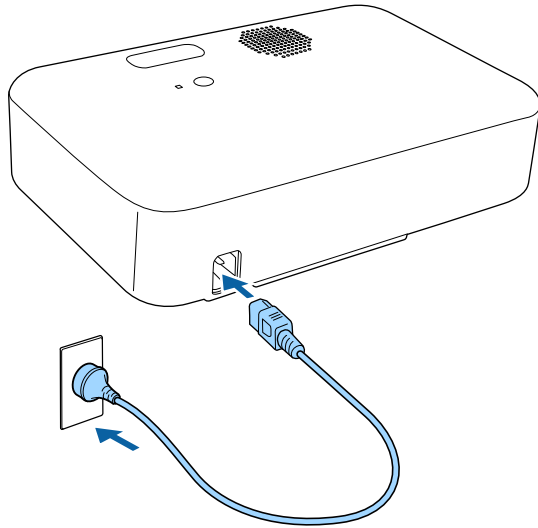

- 2** Press the power button on the projector or remote control to turn on the projector.

The status indicator flashes blue as the projector warms up. Once the projector is warmed up, the status indicator stops flashing and turns blue.

- 3** If you connected a computer or a video device, turn on the connected computer or video device you want to use.

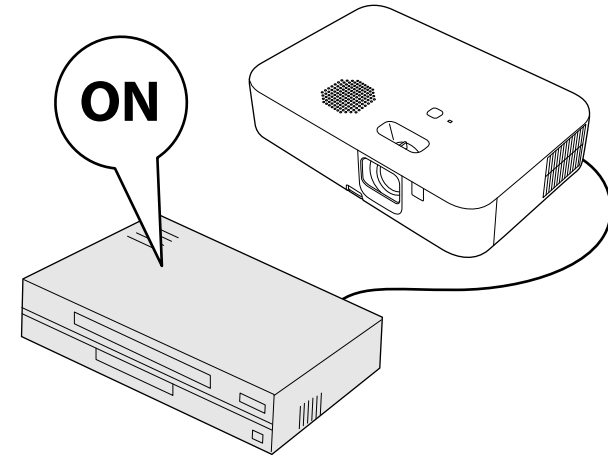

## Warning

- Never look into the projector lens when the lamp is on. This can damage your eyes and is especially dangerous for children.
- When turning on the projector at a distance using the remote control, make sure there is no one looking into the lens.
- During projection, do not touch the projector. The high heat generated by the projector lamp may cause a burn or injury.
- During projection, do not block the light from the projector with a book or other objects. If the light from the projector is blocked, the area on which the light shines becomes hot which could cause it to melt, burn, or start a fire. Also, the lens may get hot due to the reflected light which could cause the projector to malfunction. To stop projection, use the A/V Mute function, or turn off the projector.
- A mercury lamp with high internal pressure is used as the projector's light source. If the lamp is subjected to vibrations or shocks, or if it is used for an overly extended length of time, the lamp may break or it may not turn on. If the lamp explodes, gases may escape and small fragments of glass may be scattered which could cause an injury. Be sure to observe the instructions below.
  - Do not bring your face close to the projector while it is in use.
  - Do not swing or tilt the projector. Shards of glass may fall out and could cause an injury. Be very careful not to allow such pieces of glass to enter your eyes or mouth.
- If the lamp breaks, ventilate the area immediately, and contact a doctor if any fragments of broken glass are inhaled or get into the eyes or mouth.
- Do not turn the projector back on immediately after turning off the projector. Turning the projector on/off too frequently can shorten the lamp life.



- When the **Direct Power On** setting is set to **On** in the projector's **Settings** menu, the projector turns on as soon as you plug it in. Note that the projector also turns on automatically in cases such as recovery from a power outage.
  - **Settings > Operation > Direct Power On**
- If you select a specific port as the **Auto Power On** setting in the projector's **Settings** menu, the projector turns on as soon as it detects a signal or cable connection from that port.
  - **Settings > Operation > Auto Power On**

## » Related Links

- "Setting Up Android TV on the Streaming Media Player" [p.26](#)
- "Projector Feature Settings - Settings Menu" [p.60](#)

## Setting Up Android TV on the Streaming Media Player

When you turn on the projector for the first time, a screen prompting you to connect the streaming media player is displayed. Follow the on-screen instructions to connect it to the projector.

Next, follow the on-screen instructions to setup the Android TV.



You can change each of the settings even after completing the initial setup. Change the settings in the menu displayed when you press  at the top right of the Android TV home screen.

**1**

Turn on the projector.

**2**

When a screen prompting you to connect the streaming media player is displayed, follow the on-screen instructions to connect it to the projector.





If you have already connected the streaming media player, this screen is not displayed.

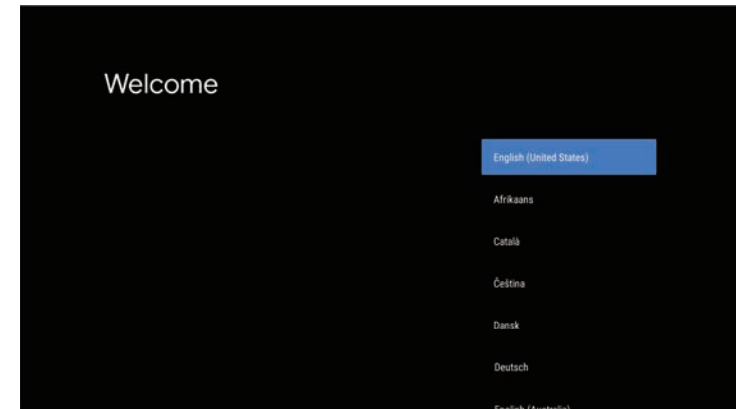

When pairing starts, the indicator on the remote control flashes. When pairing is complete, the indicator turns off.

- 4** When the language selection screen is displayed, select the language you want to use.



- 3** When the pairing screen is displayed, hold down the [Enter] button and  button on the remote control at the same time to pair the remote control and the projector.

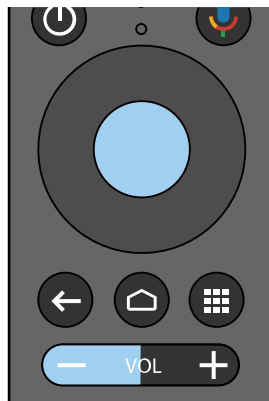

- 5** When the Wi-Fi setting screen is displayed, select the wireless network you want to use, and then follow the on-screen instructions to make necessary settings.
- An internet connection is required to view online content. Make sure you can use the Wi-Fi service.
  - The customer is responsible for any communication charges incurred when downloading the app or watching online content.
- 6** When the login screen is displayed, sign in using your Google Account.
- You can download various popular apps and games on Google Play by signing in with your Google Account.
  - You can also create a Google Account on your computer or smart device.

When you have finished the initial setup, the home screen is displayed.

Turn off the projector after use.



- Turn off this product when it is not in use to prolong the life of the projector. Lamp life varies depending on the mode selected, environmental conditions, and usage. Brightness decreases over time.
- Since the projector supports the direct shutdown feature, it can be turned off directly using the breaker.

- 1** Press the power button on the projector or remote control.  
The projector displays a shutdown confirmation screen.

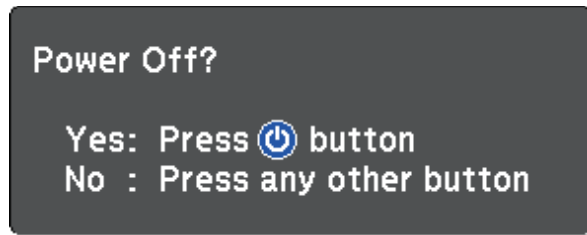

- 2** Press the power button again. (To leave it on, press any other button.)  
The projected image disappears and the status indicator turns off.





With Epson's Instant Off technology, there is no cool-down period so you can pack up the projector for transport right away.

- 3** To transport or store the projector, make sure the status indicator on the projector is off, and then unplug the power cord.

If you want to view the projector's menus and messages in another language, you can change the **Language** setting.

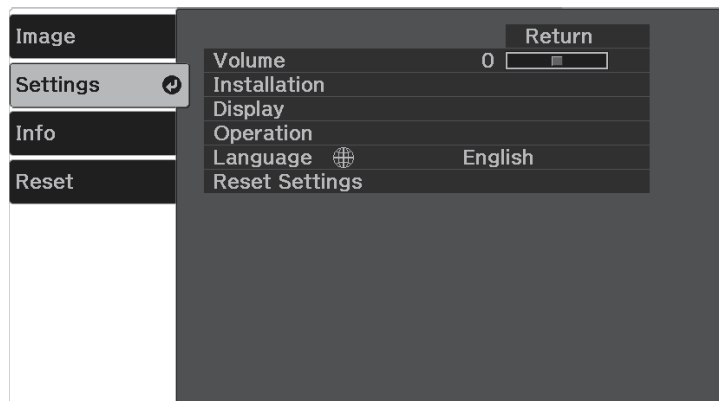
- 1** Turn on the projector.
- 2** Press the  button on the remote control.
- 3** Select the **Settings** menu and press [Enter].



- 4** Select the **Language** setting and press [Enter].
- 5** Select the language you want to use and press [Enter].
- 6** Press  or  to exit the menus.

Depending on how you positioned the projector, you may need to change the projection mode so your images project correctly.

- **Front** lets you project from a table in front of the screen.
- **Front/Upside Down** flips the image over top-to-bottom to project upside-down.
- **Rear** flips the image horizontally to project from behind a translucent screen.
- **Rear/Upside Down** flips the image over top-to-bottom and horizontally to project from behind a translucent screen.



#### » Related Links

- "Changing the Projection Mode Using the Remote Control" [p.30](#)
- "Changing the Projection Mode Using the Menu" [p.30](#)
- "Projector Setup and Installation Options" [p.17](#)

---

## Changing the Projection Mode Using the Remote Control

You can change the projection mode to flip the image over top-to-bottom.

- 1** Turn on the projector and display an image.
- 2** Hold down the  button on the remote control for five seconds. The image disappears briefly and reappears flipped top-to-bottom.
- 3** To change projection back to the original mode, hold down the  button for five seconds again.

---

## Changing the Projection Mode Using the Menu

You can change the projection mode to flip the image over top-to-bottom and/or left-to-right using the projector menus.

- 1** Turn on the projector and display an image.
- 2** Press the  button on the remote control.
- 3** Select the **Settings** menu and press [Enter].

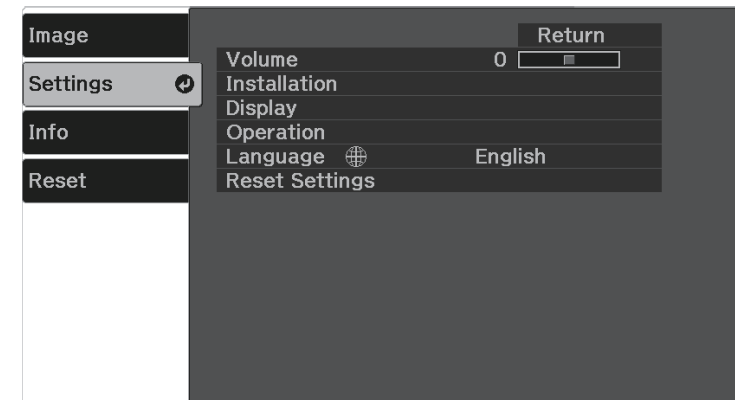

- 4** Select **Installation > Projection** and press [Enter].
- 5** Select a projection mode and press [Enter].

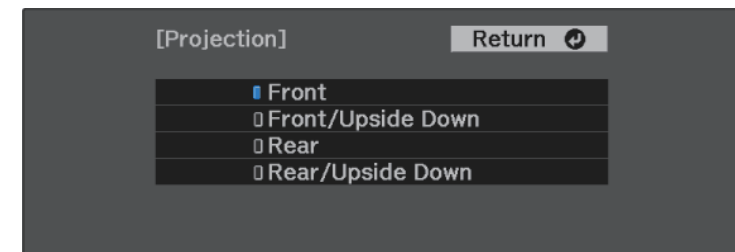

If you select **Front**, the **Keystone** adjustment screen is displayed. Use the arrow buttons on the remote control to adjust the image shape as necessary.

**6** Press  to exit the menus.

You can display a test pattern to adjust the projected image without connecting a computer or video device.



To set menu items that cannot be set while the test pattern is being displayed or to fine-tune the projected image, project an image from the connected device.

- 1 Turn on the projector.
- 2 Press the  button on the remote control.
- 3 Select the **Settings** menu and press [Enter].

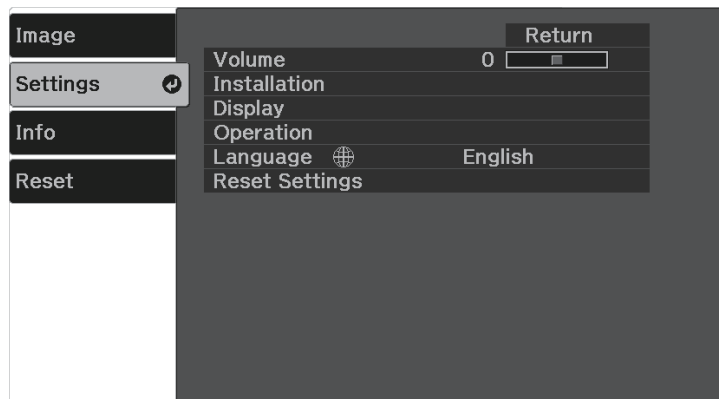

- 4 Select **Installation > Pattern > Test Pattern**, and press [Enter].  
The test pattern is displayed.
- 5 Adjust the image as necessary by adjusting the focus or changing the projector position.
- 6 Press  to clear the test pattern.



If you are projecting from a table or other flat surface and the image is too high or low, you can adjust the image height using the projector's adjustable foot.

The larger the angle of tilt, the harder it becomes to focus. Locate the projector so that it only needs to be tilted at a small angle.

- 1** Turn on the projector and display an image.
- 2** Press the foot release lever to extend and retract the front adjustable foot.

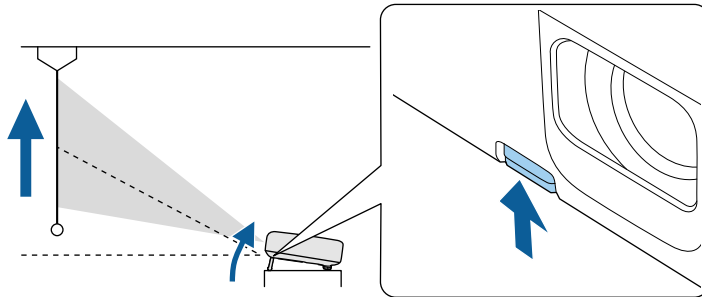

The foot extends from the projector.

You can adjust the position up to 12 degrees.

- 3** Release the lever to lock the foot.

If the projected image is unevenly rectangular, you need to adjust the image shape.

## ► Related Links

- ["Image Shape" p.34](#)

You can project an even, rectangular image by placing the projector directly in front of the center of the screen and keeping it level. If you place the projector at an angle to the screen, or tilt it up or down, or off to the side, you may need to correct the image shape.

After correction, your image is slightly smaller.

For the best quality images, we recommend adjusting the installation position of the projector to achieve the correct image size and shape.

#### ▶ Related Links

- "Auto V-Keystone" [p.34](#)
- "Correcting the Image Shape with the Keystone Button" [p.34](#)
- "Correcting the Image Shape with Quick Corner" [p.35](#)

## Auto V-Keystone

When the projector is moved or tilted, **Auto V-Keystone** automatically corrects any vertical keystone distortion.

**Auto V-Keystone** can correct the projected image distortion in these conditions:

- Projection angle is about 30° up or down
- The **Projection** setting is set to **Front** in the projector's **Settings** menu
  - ☛ **Settings > Installation > Projection**



- If you do not want to use the **Auto V-Keystone** function, set **Auto V-Keystone** to **Off** in the projector's menu.
  - ☛ **Settings > Installation > Keystone > H/V-Keystone > Auto V-Keystone**

#### ▶ Related Links

- "Projection Modes" [p.30](#)
- "Projector Feature Settings - Settings Menu" [p.60](#)

## Correcting the Image Shape with the Keystone Button

You can correct the shape of an image that is unevenly rectangular.

To correct the distortion in the horizontal and vertical directions independently, use the  button on the remote control.

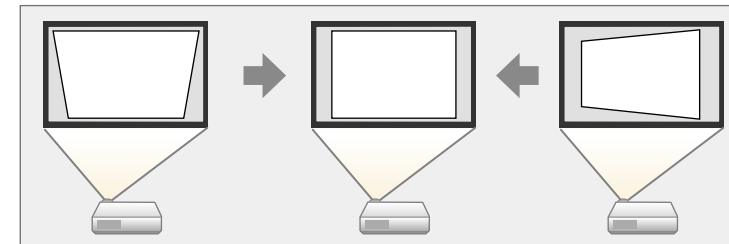

- You cannot combine H/V-Keystone correction with other image shape correction methods.
- You can correct keystone distortion by up to 30° right, left, up, or down.

**1**

Turn on the projector and display an image.

**2**

Press the  button on the remote control, select **H/V-Keystone**, and then press [Enter].

You see the **Keystone** adjustment screen:



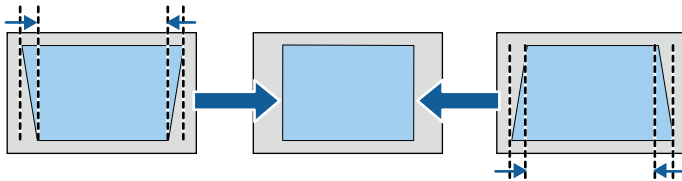

**3** Use the arrow buttons on the remote control to select between vertical and horizontal keystone correction and to adjust the image shape as necessary.

- **V-Keystone**

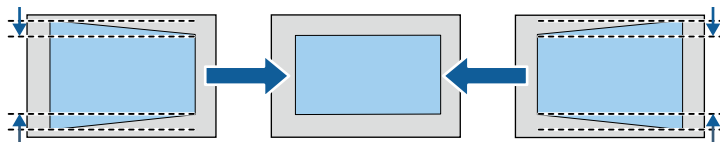

- **H-Keystone**



**4** When you are finished, press .

After correction, your image is slightly smaller.

» **Related Links**

- "Projector Feature Settings - Settings Menu" [p.60](#)

## Correcting the Image Shape with Quick Corner

You can use the projector's **Quick Corner** setting to correct the shape and size of an image that is unevenly rectangular.

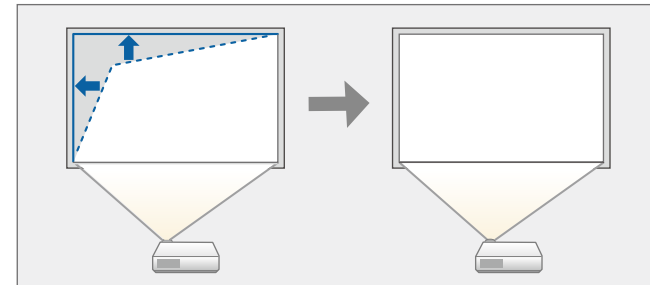

- 1** Turn on the projector and display an image.
- 2** Press the  button on the remote control.
- 3** Select the **Settings** menu and press [Enter].

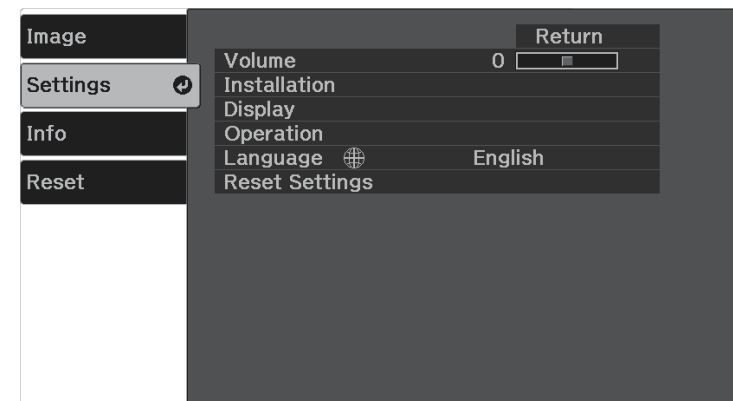

- 4** Select **Installation > Keystone** and press [Enter].

- 5** Select **Quick Corner** and press [Enter]. Then press [Enter] again if necessary.

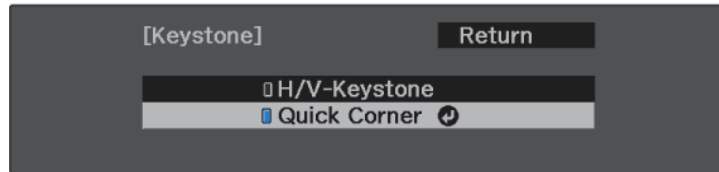

You see the area selection screen.

- 6** Use the arrow buttons to select the corner of the image you want to adjust. Then press [Enter].

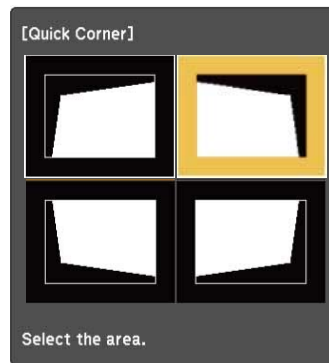

To reset the Quick Corner corrections, hold down  for about two seconds while the area selection screen is displayed, and then select **Yes**.

- 7** Press the arrow buttons to adjust the image shape as necessary.  
To return to the area selection screen, press [Enter].



If you see this screen, you cannot adjust the shape any further in the direction indicated by the gray triangle.



- 8** Repeat steps 6 and 7 as needed to adjust any remaining corners.
- 9** When you are finished, press .

## » Related Links

- "Projector Feature Settings - Settings Menu" [p.60](#)

You can correct the focus using the focus lever.

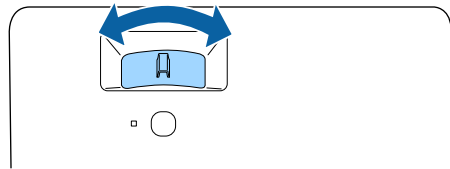
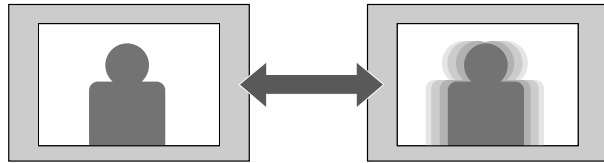

You can resize the image using the projector's menu.

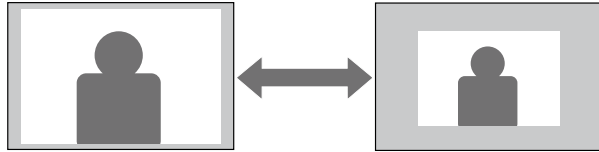

**6** Press  to exit the menus.

**1** Turn on the projector and display an image.

**2** Press the  button on the remote control.

**3** Select the **Settings** menu and press [Enter].

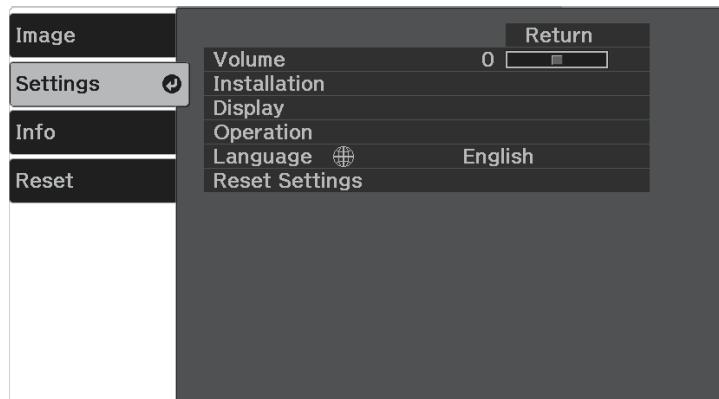

**4** Select **Installation** > **Zoom** and press [Enter].

**5** Press the left or right arrow button to adjust the zoom setting and press [Enter].





You can use the **Image Shift** feature to adjust the image position without moving the projector.

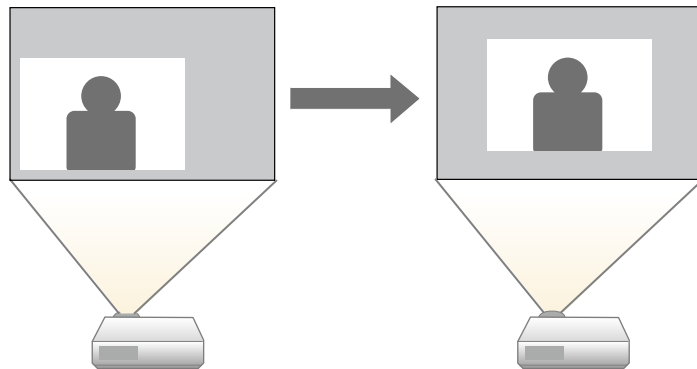

This feature is not available if **Zoom** is set to the widest setting.

Settings > Installation > Zoom



- 1 Turn on the projector and display an image.
- 2 Press the  button on the remote control.
- 3 Select the **Settings** menu and press [Enter].

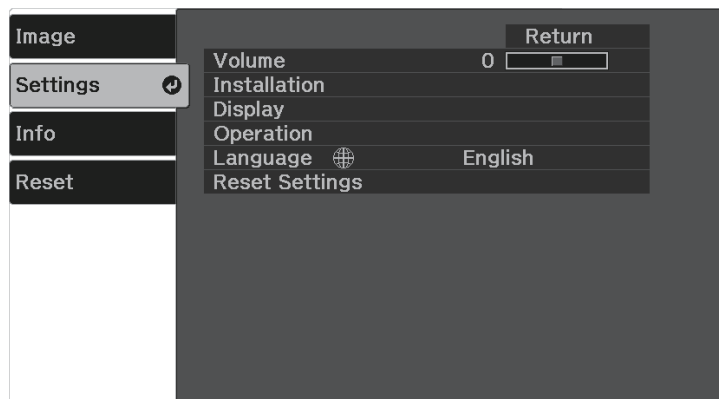

- 4 Select **Installation > Image Shift** and press [Enter].
- 5 Use the arrow buttons to adjust the image position.

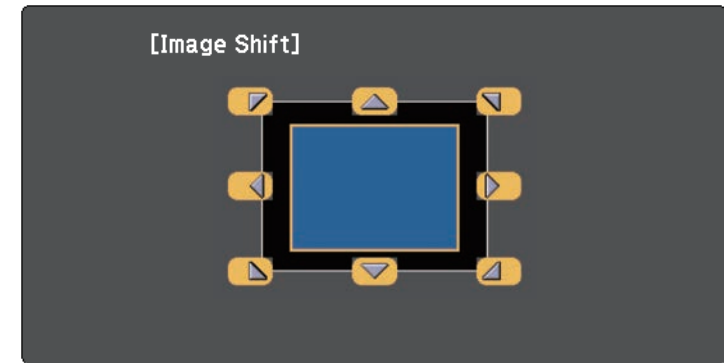

You can shift the image diagonally by pressing any pair of adjacent arrow buttons on the remote control.

- 6 Press the  button to close the adjustment screen.



The **Image Shift** setting is retained even if the projector is turned off. You need to re-adjust the position if you change the installation location or angle of the projector.

The projector can display images in different width-to-height ratios called aspect ratios. Normally, the input signal from your video source determines the image's aspect ratio. However, you can change the aspect ratio for certain images to fit your screen.

If you always want to use a particular aspect ratio for a certain video input source, you can select it using the projector's **Image** menu.

## » Related Links

- "Changing the Image Aspect Ratio" [p.40](#)
- "Available Image Aspect Ratios" [p.40](#)
- "Image Quality Settings - Image Menu" [p.58](#)

---

## Changing the Image Aspect Ratio

You can change the aspect ratio of the displayed image.

- 1** Turn on the projector and display an image.
- 2** Press the  button on the remote control.
- 3** Select the **Image** menu and press [Enter].



- 4** Select **Aspect** and press [Enter].

- 5** Select one of the available aspect ratios for your input signal and press [Enter].

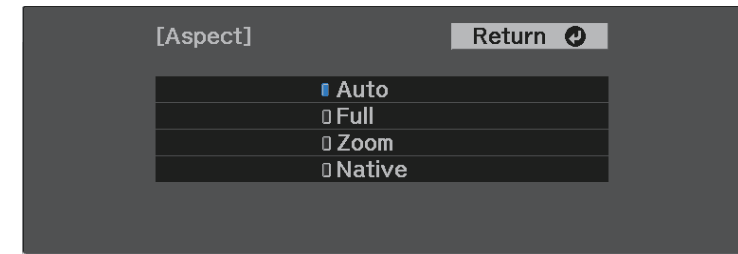

- 6** Press  to exit the menus.



The available aspect ratio setting varies depending on the input signal.

## » Related Links

- "Image Quality Settings - Image Menu" [p.58](#)

---

## Available Image Aspect Ratios

You can select the following image aspect ratios, depending on the input signal from your image source.





- Note that using the aspect ratio function of the projector to reduce, enlarge, or split the projected image for commercial purposes or for public viewing may infringe upon the rights of the copyright holder of that image based on copyright law.

Aspect mode	Description
Auto	Automatically sets the aspect ratio according to the input signal.
Full	Displays images using the full size of the projection area, but does not maintain the aspect ratio.
Zoom	Displays images using the full width of the projection area and maintains the aspect ratio of the image.
Native	Displays images as is (aspect ratio and resolution are maintained).



The projector offers different color modes to provide optimum brightness, contrast, and color for a variety of viewing environments and image types. You can select the mode designed to match your image and environment, or experiment with the available modes.

## » Related Links

- "Changing the Color Mode" [p.42](#)
- "Available Color Modes" [p.42](#)

## Changing the Color Mode

You can change the projector's Color Mode using the remote control to optimize the image for your viewing environment.

- 1** Turn on the projector and switch to the image source you want to use.
- 2** Press the  button on the remote control to change the Color Mode. The name of the Color Mode appears briefly on the screen and then image appearance changes.
- 3** To cycle through all of the available color modes for your input signal, press the  button repeatedly.



You can also set the **Color Mode** setting in the projector's **Image** menu.

## » Related Links

- "Image Quality Settings - Image Menu" [p.58](#)

## Available Color Modes

You can set the projector to use these color modes, depending on the input source you are using:



Color mode	Description
Dynamic	This is the brightest mode. Best for prioritizing brightness.
Vivid	Best for enjoying content with bright colors.
Cinema	Best for enjoying content such as movies.
Natural	Reproduces natural colors. This is the best option when you want to adjust the image color.

The volume buttons control the projector's internal speaker system.

You must adjust the volume separately for each connected input source.



- To adjust the volume for connected audio/video system, set the **HDMI Link** setting to **On** and the **Audio Out Device** setting to **AV System** in the projector's **Settings** menu.
  - ☛ **Settings > Operation > HDMI Link > HDMI Link**
  - ☛ **Settings > Operation > HDMI Link > Audio Out Device**

- 1** Turn on the projector and start a presentation.
- 2** To lower or raise the volume, press the  or  buttons on the remote control.  
A volume gauge appears on the screen.
- 3** To set the volume to a specific level for an input source, select **Volume** in the projector's **Settings** menu.

## **Caution**

Do not start a presentation at a high volume setting. Sudden loud noises may cause hearing loss.

Always lower the volume before powering off, so that you can power on and then gradually increase the volume.

## » **Related Links**

- "Projector Feature Settings - Settings Menu" [p.60](#)

# Adjusting Projector Features

Follow the instructions in these sections to use your projector's adjustment features.

## ► Related Links

- "Shutting Off the Image and Sound Temporarily (A/V Mute)" [p.45](#)
- "Turning Off the Sound Temporarily (Mute)" [p.46](#)
- "Stopping Video Action Temporarily" [p.47](#)
- "Zooming Images (E-Zoom)" [p.48](#)
- "Saving a User's Logo Image" [p.49](#)
- "Saving a User Pattern" [p.51](#)
- "Projector Security Features" [p.52](#)

You can temporarily turn off the projected image and sound. Any sound or video action continues to run, however, so you cannot resume projection at the point that you stopped it.

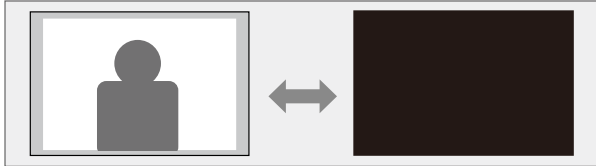

If you want to display an image such as a company logo or picture when the  button is pressed, you can select the screen displayed in the **A/V Mute** setting in the projector's **Settings** menu.

 **Settings > Display > A/V Mute**

**1** Press the  button on the remote control.  
The projected image and sound are interrupted.

**2** To turn the image and sound back on, press  again.



- The projector's power automatically turns off 30 minutes after A/V Mute is enabled. You can disable this feature.



 **Settings > Operation > A/V Mute Timer**

- The lamp is still operating during A/V Mute, so the lamp hours continue to accumulate.

## » Related Links

- "Projector Feature Settings - Settings Menu" [p.60](#)

You can temporarily turn off the sound.

- 1** Press the  button on the remote control.
- 2** To turn the sound back on, press  again.





You can temporarily stop the action in a video or computer presentation and keep the current image on the screen. Any sound or video action continues to run, however, so you cannot resume projection at the point that you stopped it.

**1** Press the  button on the remote control to stop the video action.

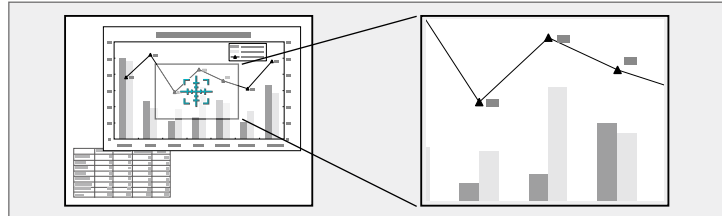
**2** To restart the video action in progress, press  again.

You can zoom into an area of the projected image and enlarge it on the screen.



- 1** Press the  button on the remote control.  
You see a crosshair on the screen indicating the center of the zoom area.
- 2** Use the following buttons on the remote control to adjust the zoomed image:
  - Use the arrow buttons to position the crosshair in the image area you want to zoom into. To move the crosshair diagonally, press any pair of adjacent arrow buttons at the same time.
  - Press the  button repeatedly to zoom into the image area. Press and hold the  button to zoom in more quickly.
  - To pan around the zoomed image area, use the arrow buttons.
  - To zoom out of the image, press the  button.
  - To return to the original image size, press .

The enlarged image is projected and the enlargement ratio is displayed on the screen.

You can enlarge the selected area to between one to four times in 25 incremental steps.



You can save an image on the projector and display it whenever the projector turns on. You can also display the image when the projector is not receiving an input signal. This image is called the user's logo screen.

You can select a photo, graphic, or company logo as the user's logo, which is useful in identifying the projector's owner to help deter theft. You can prevent changes to the user's logo by setting up password protection.

- If **User's Logo Protection** in the **Password Protection** setting is set to **On**, set to **Off** before saving the user's logo.
- When you copy the menu settings from one projector to another using the batch setup feature, user's logo is also copied. Do not register the information that you do not want to share between multiple projectors as a user's logo.
- You cannot save content that is protected by HDCP.

**1** Display the image you want to project as the user's logo.

**2** Press the  button on the remote control.

**3** Select the **Settings** menu and press [Enter].

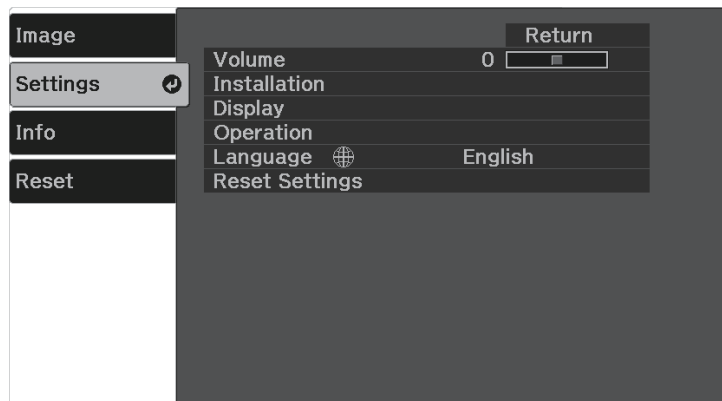

**4** Select **Display > User's Logo > Start Setting**, and press [Enter].

You see a prompt asking if you want to use the displayed image as a user's logo.

 Adjustments such as Keystone, Zoom, or Aspect are temporarily canceled when you select **User's Logo**.

**5** Select **Yes** and press [Enter].

**6** Check the displayed image, and then select **Yes** to save it as the user's logo.

The user's logo is overwritten and a completion message is displayed.

**7** Press  to exit the message screen.

**8** Select when you want to display the User's Logo screen:

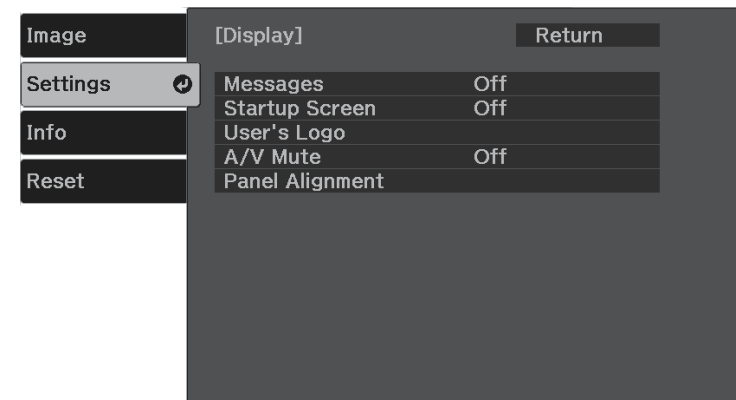

- To display it whenever you turn the projector on, select **Startup Screen** and set it to **On**.

- To display it whenever you press the  button, select **A/V Mute** and set it to **Logo**.



To prevent anyone from changing the User's Logo settings without first entering a password, set the **User's Logo Protection** setting to **On** in the **Password Protection** setting menu and set the password.

## » Related Links

- "Selecting Password Security Types" [p.53](#)

There are four types of patterns pre-registered in the projector, such as ruled lines and grid patterns. You can project these patterns to aid in presentations using the **Pattern Display** settings.

You can also save the image that is currently being projected as a User Pattern.



Once you save a User Pattern, the pattern cannot be returned to the factory default.

- 1 Project the image you want to save as the User Pattern.
- 2 Press the  button on the remote control.
- 3 Select the **Settings** menu and press [Enter].

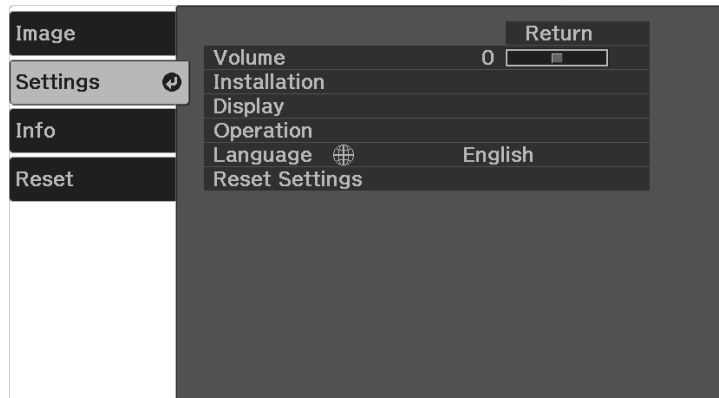

- 4 Select **Installation > Pattern > User Pattern**, and press [Enter].  
You see a prompt asking if you want to use the displayed image as a User Pattern.



- Adjustments such as Keystone, Zoom, or Aspect are temporarily cancelled when you select **User Pattern**.
- You cannot save digital images protected by HDCP technology as a User Pattern.

- 5 Select **Yes** and press [Enter].
- 6 Press [Enter].  
A message prompting you to save the projected image as a User Pattern is displayed.
- 7 Select **Yes** and press [Enter].  
A completion message is displayed.
- 8 Press [Enter].
- 9 Select **Pattern Type** and set it to **User Pattern**.
- 10 Press .
- 11 Select **Pattern Display** and press [Enter].  
The saved image is projected.

You can secure your projector to deter theft or prevent unintended use by setting up the following security features:

- Password security to prevent people who do not know the password from using the projector, and prevent changes to the startup screen and other settings.  
This acts as an anti-theft function as the projector cannot be used even if it is stolen, and you can limit who can use the projector.
- Security cabling to physically secure the projector in place.

#### » Related Links

- "Password Security Types" [p.52](#)
- "Installing a Security Cable" [p.54](#)

## Password Security Types

You can set up the following types of password security using one shared password:

- **Power On Protection** prevents anyone from using the projector without first entering a password. When plugging the power cord and turning on the projector at first time, you must enter the correct password. This also applies to **Direct Power On** and **Auto Power On**.
- **User's Logo Protection** prevents anyone from changing the custom screen displayed when the projector turns on, when no signal is being input, or when you use the A/V Mute feature. The custom screen discourages theft by identifying the projector's owner.

#### » Related Links

- "Setting a Password" [p.52](#)
- "Selecting Password Security Types" [p.53](#)
- "Entering a Password to Use the Projector" [p.54](#)

## Setting a Password

To use password security, you must set a password.



The default password is set to "0000". Change this to your own password.

- 1** Hold down the  button on the remote control for about five seconds.  
You see the Password Protection setting menu.

- 2** Select **Password** and press [Enter].

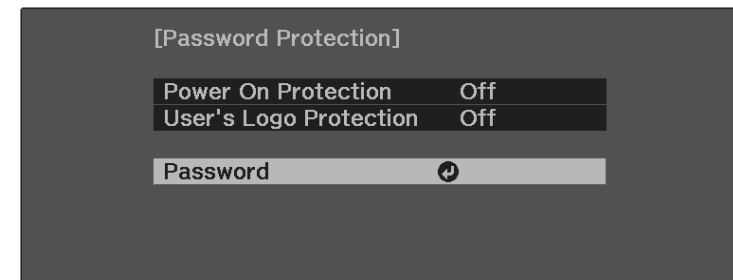

You see the prompt "Change the password?".

- 3** Select **Yes** and press [Enter].



If you select **No**, the Password Protection setting menu is displayed again.

- 4** Enter a four-digit password.

Highlight a number using the [Enter] button and arrow buttons, and then press [Enter] to select it. To select numbers from 5 to 9, press the  button.

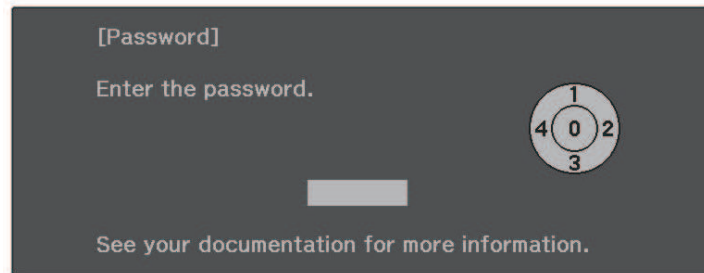



The password displays as \*\*\*\* as it is entered. A confirmation prompt is displayed when you enter the fourth digit.

- 5** Enter the password again.  
You see the message "Password accepted". If you enter the password incorrectly, a message is displayed prompting you to re-enter the password.
- 6** Press  to return to the menu.
- 7** Make a note of the password and keep it in a safe place.

## Selecting Password Security Types

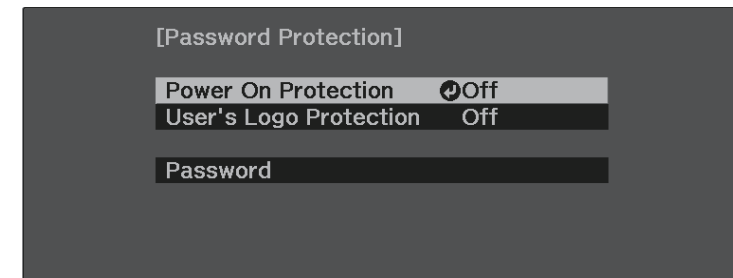
After setting a password, you see this menu, allowing you to select the password security types you want to use.



If you do not see this menu, hold down the  button on the remote control for five seconds until the menu appears.

- To prevent unauthorized use of the projector, select **On** as the **Power On Protection** setting.
- To prevent changes to the User's Logo screen or related display settings, select **On** as the **User's Logo Protection** setting.

You can attach the password protect sticker to the projector as an additional theft deterrent.



Be sure to keep the remote control in a safe place; if you lose it, you will not be able to enter the password.

## Entering a Password to Use the Projector

When the password screen is displayed, enter the correct password.

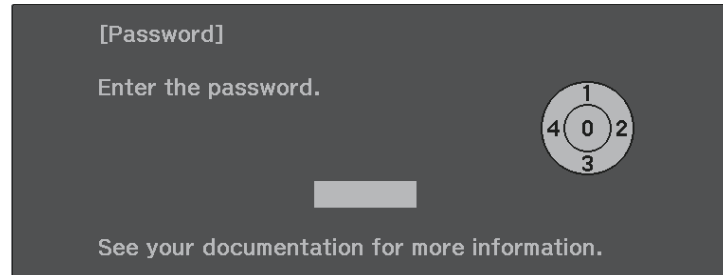

- 1** Enter the password using the [Enter] button and arrow buttons on the remote control.

To select numbers from 5 to 9, press the  button.

The password screen closes.

- 2** If the password is incorrect, you see a message and a prompt to try again. Enter the correct password to proceed.

### Attention

- If an incorrect password is entered five times in succession, the message "The projector's operation will be locked." is displayed for approximately 5 minutes, and the projector switches to standby mode. If this happens, disconnect the power plug from the electrical outlet, reinsert it, and turn the projector back on. The projector displays the password entry screen again so that you can enter the correct password.
- If you have forgotten the password, make a note of the "**Request Code:** xxxxx" number that appears on the screen and contact Epson for help.
- If you continue to repeat the above operation and input the wrong password 30 times in succession, the message "The projector's operation will be locked. Contact Epson as described in your documentation." is displayed and the projector does not accept any more password entries. Contact Epson for help.

## Installing a Security Cable

You can use the security slot on the projector to attach a Kensington Microsaver Security system as a theft deterrent.



For more details on the Microsaver Security System, see <http://www.kensington.com/>.

### » Related Links

- "Projector Parts - Rear" [p.10](#)

# Adjusting the Menu Settings

Follow the instructions in these sections to access the projector menu system and change projector settings.

## ► Related Links

- "Using the Projector's Menus" [p.56](#)
- "Using the Displayed Keyboard" [p.57](#)
- "Image Quality Settings - Image Menu" [p.58](#)
- "Projector Feature Settings - Settings Menu" [p.60](#)
- "Projector Information Display - Info Menu" [p.62](#)
- "Projector Reset Options - Reset Menu" [p.63](#)
- "Copying Menu Settings Between Projectors (Batch Setup)" [p.64](#)

You can use the projector's menus to adjust the settings that control how your projector works. The projector displays the menus on the screen.

**1** Press the  button on the remote control.

You see the menu screen displaying the **Image** menu settings.

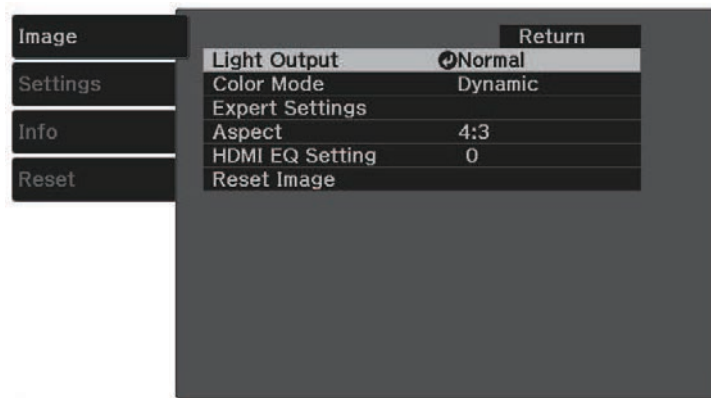

**2** Press the up or down arrow button  to move through the menus listed on the left. The settings for each menu are displayed on the right.

**3** To change settings in the displayed menu, press [Enter].

**4** Press the up or down arrow button  to move through the settings.

**5** Change the settings using the buttons listed on the bottom of the menu screens.

**6** To return all the menu settings to their default values, select **Reset**.

**7** When you finish changing settings on a menu, press .

**8** Press  or  to exit the menus.



You can use the displayed keyboard to enter numbers and characters.

- 1 Use the arrow buttons on the remote control to highlight the number or character you want to enter and press the [Enter] button.

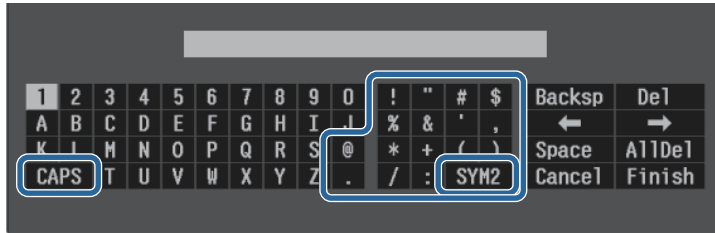

 Each time you select the **CAPS** key, the characters change between upper case and lower case. Each time you select the **SYM1/2** key, the symbols enclosed by the frame change.

- 2 After entering the text, select **Finish** on the keyboard to confirm your entries. Select **Cancel** to cancel entering text.

» **Related Links**

- "Available Text Using the Displayed Keyboard" [p.57](#)

## Available Text Using the Displayed Keyboard

You can enter the following text when using the displayed keyboard.

Text type	Details
Symbols	!"#\$%&'()*+,-./:;<=>?@[ \ ] ^_`{ }~

Text type	Details
Numbers	0123456789
Alphabet	ABCDEFGHIJKLMNOPQRSTUVWXYZ Z abcdefghijklmnopqrstuvwxyz

Settings on the **Image** menu let you adjust the quality of your image for the input source you are currently using.



Setting	Options	Description
Light Output	Normal Low (Eco)	Adjusts the brightness for the light source.
Color Mode	See the list of available color modes	Adjusts the vividness of image colors for various image types and environments.
Expert Settings	Brightness	Lightens or darkens the overall image. <b>Brightness:</b> lightens or darkens the overall image. <b>Contrast:</b> adjusts the difference between light and dark areas of the image. <b>Scene Adaptive Gamma:</b> adjusts the coloring according to the scene, and obtains a more vivid image. Select a large number to enhance contrast.

Setting	Options	Description
	Color	Adjusts the intensity of the image colors. <b>Color Saturation:</b> adjusts the intensity of the image colors. <b>Tint:</b> adjusts the balance of green to magenta tones in the image. <b>White Balance: Color Temp.</b> sets the color temperature according to the color mode you selected. Higher values tint the image blue and lower values tint the image red. <b>Customized</b> adjusts the individual R (red), G (green), and B (blue) components of the offset and gain.
	Sharpness	Adjusts the sharpness or softness of image details.
Aspect	See the list of available aspect ratios.	Sets the aspect ratio (width-to-height ratio) for the input source.
HDMI EQ Setting	—	Adjusts the HDMI input signal level depending on the devices connected to the HDMI port. If there is a lot of interference in the image, or if a problem such as no image being projected occurs, change the setting. If no images are displayed using a thumb-sized media streaming device, select <b>1</b> .
Reset Image	—	Resets all adjustment values on the <b>Image</b> menu for the selected color mode to their default settings. Adjustment values for the following item(s) are not reset: • <b>HDMI EQ Setting</b>

 The **Brightness** setting does not affect lamp brightness. To change the lamp brightness mode, use the **Light Output** setting.

## » Related Links

- "Available Color Modes" [p.42](#)
- "Available Image Aspect Ratios" [p.40](#)

Options on the **Settings** menu let you customize various projector features.

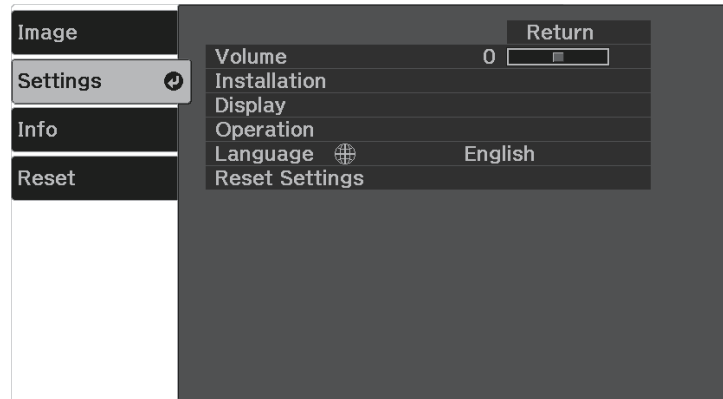

Setting	Options	Description
Volume	-	Adjusts the volume of the projector's speaker system.
Installation	Keystone	<b>H/V-Keystone:</b> select to manually correct horizontal and vertical sides. <b>Quick Corner:</b> select to correct image shape and alignment using an on-screen display.
	Zoom	Adjusts the image size.
	Image Shift	Shifts the image position horizontally and vertically. This feature is not available if the <b>Zoom</b> option is set to the widest setting.
	Projection	Selects the way the projector faces the screen so the image is oriented correctly.

Setting	Options	Description
	Pattern	Selects various pattern display options.  <div style="border: 1px solid black; background-color: #ffffcc; padding: 5px; margin: 10px 0;"> <p><b>Attention</b> If a pattern is displayed for a long time, a residual image may be visible in projected images.</p> </div> <p><b>Pattern Display:</b> lets you display the selected pattern type on the screen to aid in presentation.  <b>Pattern Type:</b> select from Patterns 1 to 4 or <b>User Pattern</b>. Patterns 1 to 4 display patterns pre-registered in the projector, such as ruled lines or grid patterns.  <b>User Pattern:</b> captures a projected screen and saves it as a pattern for display.  <b>Test Pattern:</b> displays a test pattern to assist in focusing and zooming the image and correcting image shape (press the  button to cancel pattern display).</p>
	Display	<p><b>Messages</b> Set to <b>On</b> to display messages such as color mode name, aspect ratio, or high temperature warning on your projected image. Set to <b>Off</b> if you do not want to display messages.</p> <p><b>Startup Screen</b> Set to <b>On</b> to display the User's Logo when the projector starts up.</p> <p><b>User's Logo</b> Creates a screen that the projector displays to identify itself and enhance security.</p> <p><b>A/V Mute</b> Sets the screen color or logo to display when A/V Mute is turned on.</p>

Setting	Options	Description
Operation	HDMI Link	<p><b>Device Connections:</b> lists the devices connected to the HDMI ports.</p> <p><b>HDMI Link:</b> enables or disables the HDMI Link features.</p> <p><b>Audio Out Device:</b> selects whether to output audio from the internal speakers or a connected audio/video system.</p> <p><b>Power On Link:</b> controls what happens when you turn on the projector or connected device.</p> <ul style="list-style-type: none"> <li>• <b>Bidirectional:</b> automatically turns on the connected device when you turn on the projector, and vice versa.</li> <li>• <b>Device -&gt; PJ:</b> automatically turns on the projector when you turn on the connected device.</li> <li>• <b>PJ -&gt; Device:</b> automatically turns on the connected device when you turn on the projector.</li> </ul> <p><b>Power Off Link:</b> controls whether connected devices are turned off when you turn off the projector.</p>
	Sleep Mode	Automatically turns off the projector after an interval of inactivity (when <b>On</b> ).
	Sleep Mode Timer	Sets the interval for <b>Sleep Mode</b> .
	A/V Mute Timer	Automatically turns off the projector after 30 minutes if <b>A/V Mute</b> is enabled (when <b>On</b> ).
	Direct Power On	Lets you turn on the projector by plugging it in without pressing the power button.
	Auto Power On	Select <b>On</b> to automatically start projection when the projector detects an input signal in standby mode.
	High Altitude Mode	Regulates the projector's operating temperature at altitudes above 1500 m.

Setting	Options	Description
	Indicators	Set to <b>Off</b> to turn off the indicator lights on the projector except when an error or warning occurs.
	Advanced	<p><b>Log Save Destination:</b> sets the location in which to save error and operation log files.</p> <p><b>Batch Setup Range:</b> select <b>All</b> to copy all of the projector menu settings using the batch setup feature. Select <b>Limited</b>, if you do not want to copy the following settings:</p> <ul style="list-style-type: none"> <li>• <b>Password Protection</b> settings</li> </ul>
Language	Various languages available	Select the language for projector menu and message displays.
Reset	—	Resets all adjustment values on the <b>Settings</b> menu to their default settings, except for the following: <ul style="list-style-type: none"> <li>• <b>Zoom</b></li> <li>• <b>Image Shift</b></li> <li>• <b>Projection</b></li> <li>• <b>Audio Out Device</b></li> <li>• <b>Power On Link</b></li> <li>• <b>Power Off Link</b></li> <li>• <b>High Altitude Mode</b></li> <li>• <b>Language</b></li> </ul>



When you set **User's Logo Protection** to **On** in the **Password Protection** screen, you cannot change settings related to user's logo display (**Startup Screen**, **A/V Mute** in the **Display** setting). Set **User's Logo Protection** to **Off** first.

You can display information about the projector and version by viewing the **Info** menu. However, you cannot change any settings in the menu.

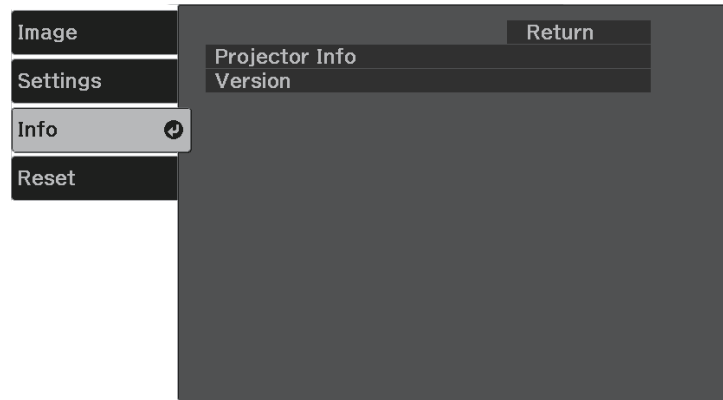

## Info Menu - Projector Info Menu

You can display information about the projector and input sources by viewing the **Projector Info** menu in the projector's **Info** menu.

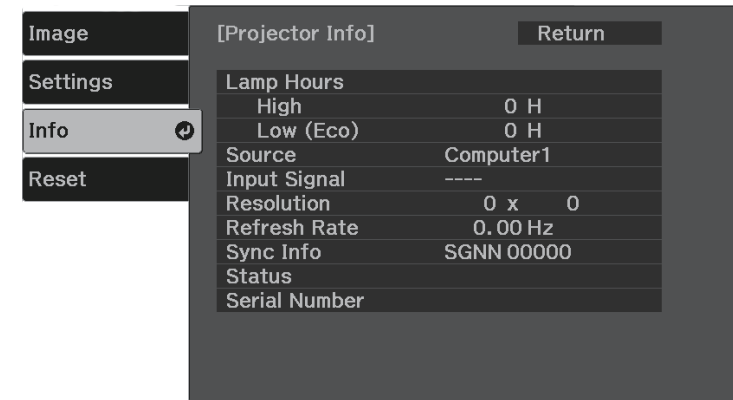

Information item	Description
Projector Info	Displays the projector information.
Version	Displays the projector's firmware version.

### » Related Links

- "Info Menu - Projector Info Menu" [p.62](#)

Information item	Description
Lamp Hours	Displays the number of hours ( <b>H</b> ) the lamp has been used in <b>High</b> and <b>Low (Eco)</b> .
Source	Displays the name of the port to which the current input source is connected.
Input Signal	Displays the input signal setting of the current input source.
Resolution	Displays the resolution of the current input source.
Refresh Rate	Displays the refresh rate of the current input source.
Sync Info	Displays information that may be needed by a service technician.
Status	Displays information about projector problems that may be needed by a service technician.
Serial Number	Displays the projector's serial number.

You can reset most of the projector settings to their default values using the **Reset All Config** option on the **Reset** menu.



Setting	Options	Description
Reset All Config	—	Resets most of the projector settings to their default values.

You cannot reset the following settings using the **Reset All Config** option:

- Zoom
- Image Shift
- Language

After selecting the projector's menu settings for one projector, you can use the following methods to copy the settings to other projectors, as long as they are the same model.

- by using a USB flash drive
- by connecting a computer and projector using a USB cable

Menu settings such as the following are not copied to the other projector.

- **Lamp Hours** and **Status** from the **Projector Info** menu



- Perform batch setup before adjusting the image settings such as keystone distortion correction. Since image adjustment values are also copied to another projector, the adjustments you made before performing the batch setup are overwritten and the projected screen you adjusted may change.
- When copying the menu settings from one projector to another, user's logo is also copied. Do not register the information that you do not want to share between multiple projectors as a user's logo.
- Make sure **Batch Setup Range** is set to **Limited** if you do not want to copy the following settings:
  - **Password Protection** settings
  - **Settings > Operation > Advanced > Batch Setup Range**

## Caution

Epson takes no responsibility for batch setup failures and associated repair costs due to power outages, communication errors, or other problems that may cause such failures.

### » Related Links

- "Transferring Settings From a USB Flash Drive" [p.64](#)
- "Transferring Settings From a Computer" [p.65](#)

## Transferring Settings From a USB Flash Drive

You can copy menu settings from one projector to another of the same model using a USB flash drive.



The USB flash drive must use a FAT format and not incorporate any security function. Delete any files on the drive before using it for batch setup or the settings may not be saved correctly.

- 1** Disconnect the power cord from the projector, and check that all of the projector's indicators have turned off.
- 2** Connect an empty USB flash drive directly to the projector's USB-A port.
- 3** Hold down the button on the remote control and connect the power cord to the projector.
- 4** When all of the projector's indicators turn on, release the button. The indicators start flashing and the batch setup file is written to the USB flash drive. When writing is finished, the projector turns off.

## Caution

Do not disconnect the power cord or the USB flash drive from the projector while the file is being written. If the power cord or USB flash drive is disconnected, the projector may not start correctly.

- 5** Remove the USB flash drive.





The file name for the batch setup file is PJCONFDATA.bin. If you need to change the file name, add text after PJCONFDATA using only alphanumeric characters. If you change the PJCONFDATA section of the file name, the projector may not be able to recognize the file correctly.

- 6** Disconnect the power cord from the projector to which you want to copy settings, and check that all of the projector's indicators have turned off.



**7** Connect the USB flash drive containing the saved batch setup file to the projector's USB-A port.

**8** Hold down the  button on the remote control and connect the power cord to the projector.

**9** When all of the projector's indicators turn on, release the  button. When all of the indicators start flashing, the settings are being written. When writing is finished, the projector turns off.

## Caution

Do not disconnect the power cord or the USB flash drive from the projector while the file is being written. If the power cord or USB flash drive is disconnected, the projector may not start correctly.

**10** Remove the USB flash drive.

## Transferring Settings From a Computer

You can copy menu settings from one projector to another of the same model by connecting the computer and projector with a USB cable.

**1** Disconnect the power cord from the projector, and check that all of the projector's indicators have turned off.

**2** Connect a USB cable to the computer's USB port and to the projector's Service (USB Mini-B) port.

**3** Hold down the  button on the remote control and connect the power cord to the projector.

**4** When all of the projector's indicators turn on, release the  button. The computer recognizes the projector as a removable disk.

**5** Open the removable disk icon or folder, and save the batch setup file to the computer.



The file name for the batch setup file is PJCONFDATA.bin. If you need to change the file name, add text after PJCONFDATA using only alphanumeric characters. If you change the PJCONFDATA section of the file name, the projector may not be able to recognize the file correctly.

**6** Eject the USB device (Windows) or drag the removable disk icon to the Trash (Mac).

**7** Disconnect the USB cable.  
The projector turns off.

**8** Disconnect the power cord from the projector to which you want to copy settings, and check that all of the projector's indicators have turned off.

**9** Connect the USB cable to the computer's USB port and to the projector's Service (USB Mini-B) port.

**10** Hold down the  button on the remote control and connect the power cord to the projector.

**11** When all of the projector's indicators turn on, release the  button. The computer recognizes the projector as a removable disk.

**12** Copy the batch setup file (PJCONFDATA.bin) that you saved to your computer to the top level folder of the removable disk.



Do not copy any files or folders other than the batch setup file to the removable disk.

**13** Eject the USB device (Windows) or drag the removable disk icon to the Trash (Mac).

**14** Disconnect the USB cable.

When all of the indicators start flashing, the settings are being written. When writing is finished, the projector turns off.

 **Caution**

Do not disconnect the power cord from the projector while the file is being written. If the power cord is disconnected, the projector may not start correctly.

» **Related Links**

- "Batch Setup Error Notification" [p.66](#)

## Batch Setup Error Notification

The projector's indicators notify you if an error occurs during a batch setup operation. Check the status of the projector's indicators and follow the instructions described in the table here.

Indicator status	Problem and solutions
Flashing orange	The batch setup file may be corrupt, or the USB flash drive or USB cable may not be connected correctly. Disconnect the USB flash drive or the USB cable, unplug and then plug in the projector's power cord, and then try again. If the problem persists, unplug the projector and contact Epson for help.

# Maintaining the Projector

Follow the instructions in these sections to maintain your projector.

## ► Related Links

- "Projector Maintenance" [p.68](#)
- "Cleaning the Lens" [p.69](#)
- "Cleaning the Projector Case" [p.70](#)
- "Cleaning the Air Vents" [p.71](#)

You may need to clean the projector's lens periodically, and clean the air vents to prevent the projector from overheating due to blocked ventilation.

The only part you should replace is the remote control batteries. If any other part needs replacing, contact Epson or an authorized Epson servicer.

## **Warning**

Before cleaning any part of the projector, turn it off and unplug the power cord. Never open any cover on the projector, except as specifically explained in this manual. Dangerous electrical voltages in the projector can injure you severely.

Clean the projector's lens periodically, or whenever you notice dust or smudges on the surface.

- To remove dust or smudges, gently wipe the lens with clean and dry lens-cleaning paper.
- If the lens is dusty, blow off dust using a blower, and then wipe the lens.

## **Warning**

- Before cleaning the lens, turn off the projector and unplug the power cord.
- Do not use any flammable gas sprays such as air dusters to blow off dust. The high heat generated by the projector may cause a fire.

## **Attention**

- Do not wipe the lens right after you turn off the projector. Doing so could damage the lens.
- Do not use any harsh materials to clean the lens and do not subject the lens to any impacts; otherwise, it could be damaged.

Before cleaning the projector case, turn off the projector and unplug the power cord.

- To remove dust or dirt, use a soft, dry, lint-free cloth.
- To remove stubborn dirt, use a soft cloth moistened with water and mild soap. Do not spray liquid directly on the projector.

### **Attention**

Do not use wax, alcohol, benzene, paint thinner, or other chemicals to clean the projector case. These can damage the case. Do not use canned air, or the gases may leave a flammable residue.

Clean the projector's air intake/exhaust vents periodically, or whenever you notice dust on the surface of the vents to prevent the projector from overheating due to blocked ventilation.

- 1** Turn off the projector and unplug the power cord.
- 2** Carefully remove the dust using a vacuum cleaner or a brush.

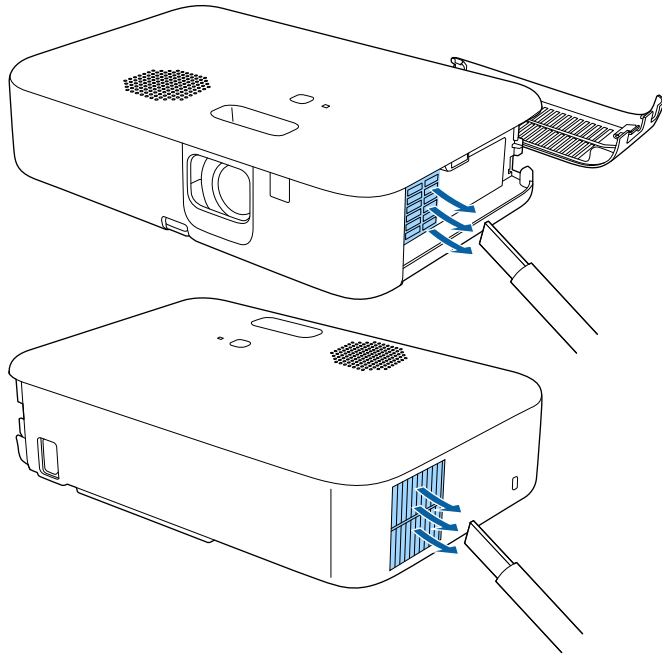

# Solving Problems

Check the solutions in these sections if you have any problems using the projector.

## ► Related Links

- "Projection Problems" [p.73](#)
- "Projector Indicator Status" [p.74](#)
- "Solving Projector Power-On or Power-Off Problems" [p.76](#)
- "Solving Image Problems" [p.77](#)
- "Solving Sound Problems" [p.81](#)
- "Solving Remote Control Operation Problems" [p.82](#)
- "Solving HDMI Link Problems" [p.83](#)
- "Solving Epson Streaming Media Player Problems" [p.84](#)
- "When the Message "It is time to replace the projector." is Displayed" [p.85](#)



If the projector is not working properly, turn it off, unplug it, and then plug it back in and turn it on.

If this does not solve the problem, check the following:

- The indicators on the projector may indicate the problem.
- The solutions in this manual can help you solve many problems.

If none of these solutions help, contact Epson for technical support.

The indicators on the projector indicate the projector status and let you know when a problem occurs. Check the status and color of the indicators and then refer to this table for a solution.

 If the indicators display a pattern not listed in the table below, turn the projector off, unplug it, and contact Epson for help.

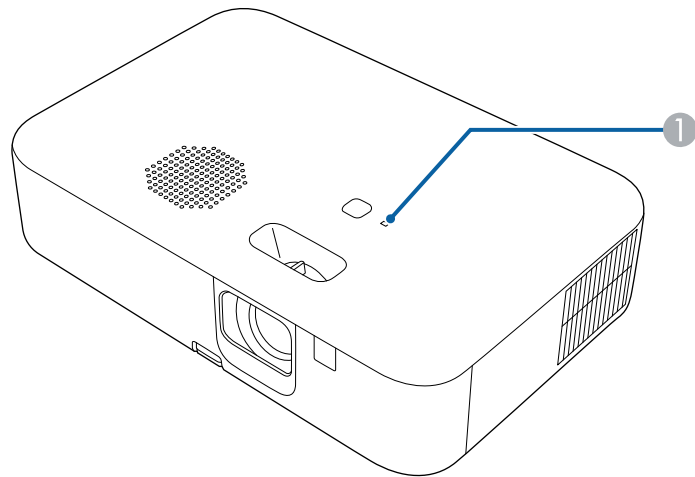

① Status indicator

### Projector status

Indicator status	Problem and solutions
Lit blue	Normal operation.
Flashing blue	Warming up, shutting down, or cooling down. When warming up, wait about 30 seconds for an image to appear. Remote control operations may be disabled when the indicator is flashing blue.

Indicator status	Problem and solutions
Off	Projector is in standby status. When you press the power button, projection starts.
Lit orange	Projector has overheated and turned off. Leave it turned off to cool down for 5 minutes. <ul style="list-style-type: none"> <li>• Make sure that the air vents are not clogged with dust or obstructed by nearby objects.</li> <li>• Make sure the environmental temperature is not too hot.</li> <li>• If the problem persists, unplug the projector and contact Epson for help.</li> </ul>
	Low air flow through the air filter. <ul style="list-style-type: none"> <li>• Make sure that the air vents are not clogged with dust or obstructed by nearby objects.</li> <li>• Make sure the environmental temperature is not too hot.</li> <li>• If the problem persists, unplug the projector and contact Epson for help.</li> </ul>
	Low air flow through the projector. <ul style="list-style-type: none"> <li>• Make sure that the air vents are not clogged with dust or obstructed by nearby objects.</li> <li>• Make sure the environmental temperature is not too hot.</li> <li>• If the problem persists, unplug the projector and contact Epson for help.</li> </ul>
Flashing orange	Lamp has a problem. Turn the projector off, unplug it, and contact Epson for help.
	A fan or sensor has a problem. Turn the projector off, unplug it, and contact Epson for help.
	Internal projector error. Turn the projector off, unplug it, and contact Epson for help.

Indicator status	Problem and solutions
	Power error (Ballast). Turn the projector off, unplug it, and contact Epson for help.

Check the solutions in these sections if the projector does not turn on when you press the power button or it turns off unexpectedly.

## » Related Links

- "Solving Projector Power Problems" [p.76](#)
- "Solving Projector Shutdown Problems" [p.76](#)

## Solving Projector Power Problems

If the projector does not turn on when you press the power button, try the following steps until the problem is solved.

- 1** Check the following items.
  - If you are using the remote control, check the batteries of the remote control.
  - Make sure the power cord is securely connected to the projector and to a working electrical outlet.
  - Check that you are not using the remote control for the streaming media player. Make sure you are using the projector remote control.
- 2** Disconnect the cord and contact Epson for help.

## » Related Links

- "When the Projector Lamp does not Turn on" [p.76](#)

## When the Projector Lamp does not Turn on

If the projector lamp does not turn on when you press the power button, the lamp may be broken.

### **Warning**

- Do not swing or tilt the projector. Shards of glass may fall out and could cause an injury.
- If any shards of glass get into your eyes or mouth, contact a doctor immediately.

## Solving Projector Shutdown Problems

If the projector turns off unexpectedly, try the following steps until the problem is solved.

- 1** Projectors may have entered sleep mode after a period of inactivity. Perform any operation to wake the projector. To turn off sleep mode, select **Off** as the **Sleep Mode** setting.
  - ☛ **Settings > Operation > Sleep Mode**
- 2** If the projector turns off unexpectedly, the A/V mute timer may be enabled. To turn off the A/V mute timer, select **Off** as the **A/V Mute Timer** setting in the projector's **Settings** menu.
  - ☛ **Settings > Operation > A/V Mute Timer**
- 3** When the status indicator is lit orange, the projector has overheated and turned off.



The cooling fans may run in standby status depending on the projector settings. Also, when the projector wakes from standby status, the fans may cause an unexpected noise. This is not a malfunction.

## » Related Links

- "Projector Feature Settings - Settings Menu" [p.60](#)

Check the solutions in these sections if you have any problems with projected images.

## ► Related Links

- "Solving Missing Image Problems" [p.77](#)
- "Adjusting an Image that is not Rectangular" [p.77](#)
- "Adjusting a Fuzzy or Blurry Image" [p.78](#)
- "Fixing Partial Image Problems" [p.78](#)
- "Adjusting an Image that Contains Noise or Static" [p.78](#)
- "Adjusting a Flickering Image" [p.79](#)
- "Adjusting an Image with Incorrect Brightness or Colors" [p.79](#)
- "Adjusting an Upside-down Image" [p.79](#)

---

## Solving Missing Image Problems

If no image is displayed, try the following steps until the problem is solved.

### 1 Check the projector's status:

- Press the  button on the remote control to see if the image was temporarily turned off.
- Check the status indicator to confirm that the projector is in normal operating status.
- Press the projector's power button to wake it from standby or sleep mode. Also, check if the connected computer is in sleep mode or displaying a blank screen saver.

☛ **Settings > Operation > Sleep Mode**

### 2 Check the cable connection:

- Make sure all necessary cables are securely connected and the power is on for the projector.
- Connect the video source directly to the projector.
- Replace the HDMI cable with the shorter one.

### 3 Check the status of your video source:

- If you are projecting from a streaming media player, make sure it is powered by the power supply USB cable on the projector.
- Turn on the connected streaming media player or video source, and press the play button to start a video, if necessary.
- Make sure the connected device meets the HDMI CEC standard. See the documentation supplied with the device for more information.
- If you are projecting from a laptop computer, make sure it is set up to display on an external monitor.

### 4 Check the following items:

- Turn off the projector and the connected streaming media player or video source, and then turn them back on.
- Set the CEC function for the connected device again and restart the device.
- Make sure the computer's display resolution does not exceed the projector's resolution and frequency limits. If necessary, select a different display resolution for your computer. (See your computer manual for details.)
- Resets all of the projector settings to their default values.

☛ **Reset > Reset All Config**

## ► Related Links

- "Projector Feature Settings - Settings Menu" [p.60](#)
- "Projector Reset Options - Reset Menu" [p.63](#)

---

## Adjusting an Image that is not Rectangular

If the projected image is not evenly rectangular, try the following steps until the problem is solved.

- 1 Place the projector directly in front of the center of the screen, facing it squarely, if possible.

- Adjust the image shape using the **Keystone** settings.
  - Settings > Installation > Keystone > H/V-Keystone
  - Settings > Installation > Keystone > Quick Corner

## » Related Links

- "Auto V-Keystone" [p.34](#)
- "Projector Reset Options - Reset Menu" [p.63](#)
- "Correcting the Image Shape with the Keystone Button" [p.34](#)
- "Correcting the Image Shape with Quick Corner" [p.35](#)

---

## Adjusting a Fuzzy or Blurry Image

If the projected image is fuzzy or blurry, try the following steps until the problem is solved.

- Adjust the image focus using the focus lever.
- Check the following items:
  - Position the projector close enough to the screen.
  - Position the projector so the keystone adjustment angle is not so wide that it distorts the image.
- Clean the projector's lens.



To avoid condensation on the lens after bringing the projector in from a cold environment, let the projector warm up to room temperature before using it.

- Adjust the **Sharpness** setting in the projector's **Image** menu to improve image quality.
  - Image > Expert Settings > Sharpness

- If you are projecting from a computer, use a lower resolution or select a resolution that matches the projector's native resolution.

## » Related Links

- "Image Quality Settings - Image Menu" [p.58](#)
- "Focusing the Image Using the Focus Lever" [p.37](#)
- "Cleaning the Lens" [p.69](#)

---

## Fixing Partial Image Problems

If only a partial computer image is displayed, try the following steps until the problem is solved.

- If you zoomed into or out of the image using the **Zoom** setting, press the  button until the projector returns to a full display.
- Make sure you selected the correct projection mode. You can select this using the **Projection** setting in the projector's **Settings** menu.
  - Settings > Installation > Projection
- Check your computer display settings to disable dual display and set the resolution within the projector's limits. (See your computer manual for details.)

## » Related Links

- "Projector Feature Settings - Settings Menu" [p.60](#)

---

## Adjusting an Image that Contains Noise or Static

If the projected image contains electronic interference (noise) or static, try the following steps until the problem is solved.

- 1** Check the cables connecting your video source to the projector. They should be:
  - Separated from the power cord to prevent interference
  - Securely connected at both ends
  - Not connected to an extension cable
- 2** If you adjusted the image shape using the projector controls, try decreasing the **Sharpness** setting in the projector's **Image** menu to improve image quality.
  - ☛ **Image > Expert Settings > Sharpness**
- 3** If you connected an extension power cable, try projecting without it to see if it caused interference in the signal.
- 4** Select a computer video resolution and refresh rate that are compatible with the projector.

#### » Related Links

- "Image Quality Settings - Image Menu" [p.58](#)

---

## Adjusting a Flickering Image

If the projected screen flickers, try the following steps until the problem is solved.

- 1** If the screen flickers only when a video signal is input, try replacing the cable connecting the projector and video device.
- 2** If **Light Output** is set to **Low (Eco)**, change this to **Normal** and try projecting an image for about two hours to see if it still flickers.
- 3** Disconnect all the cables connecting the projector and video devices, confirm no signal is being input, and then rest all the projector settings by performing **Reset All Config** in the projector's **Reset** menu.

#### » Related Links

- "Projector Reset Options - Reset Menu" [p.63](#)

---

## Adjusting an Image with Incorrect Brightness or Colors

If the projected image is too dark or bright, or the colors are incorrect, try the following steps until the problem is solved.

- 1** Try different color modes for your image and environment by selecting the **Color Mode** setting in the projector's **Image** menu.
- 2** Check your video source settings.
- 3** Adjust the available settings in the projector's **Image** menu for the current input source, such as **Brightness**, **Contrast**, **Tint**, and **Color Saturation**.
  - ☛ **Image > Expert Settings > Brightness**
  - ☛ **Image > Expert Settings > Color**
- 4** Make sure all the cables are securely connected to the projector and your video equipment. If you connected long cables, try connecting shorter cables.
- 5** Position the projector close enough to the screen.

#### » Related Links

- "Image Quality Settings - Image Menu" [p.58](#)

---

## Adjusting an Upside-down Image

If the projected image is upside-down, select the correct projection mode.



- ☛ **Settings > Installation > Projection**

## » Related Links

- "Projector Feature Settings - Settings Menu" [p.60](#)





If there is no sound or the volume is too low, try the following steps until the problem is solved.

- 1** Adjust the projector's volume settings using the  or  button on the remote control.



If you have adjusted the volume for your streaming media player using the remote control for the streaming media player, you may also need to adjust the volume again.

- 2** Check the cable connection between the projector and your video source.
- 3** Check the following settings on the projector:
  - Press the  button on the remote control to resume video and audio if they were temporarily stopped.
  - Press the  button on the remote control to unmute audio if it was muted.
- 4** Check the following settings on your video equipment:
  - Check your streaming media player or video source to make sure the volume is turned up and the audio output is set for the correct source.
  - Set the connected device to PCM output.
  - When you are connecting the projector to a Mac using an HDMI cable, make sure your Mac supports audio through the HDMI port.

## » Related Links

- "Projector Feature Settings - Settings Menu" [p.60](#)

If the projector does not respond to remote control commands, try the following steps until the problem is solved.



If you lose the remote control, you can order another one from Epson.

- 1** Check that the remote control batteries are installed correctly and have power. If necessary, replace the batteries.
- 2** Check that you are not using the remote control for the streaming media player. Make sure you are using the projector remote control.
- 3** Check to see if a button on the remote control is stuck down, causing it to enter sleep mode. Release the button to wake the remote control up.
- 4** Make sure you are operating the remote control within the reception angle and range of the projector.
- 5** Make sure the projector is not warming up or shutting down.
- 6** Strong fluorescent lighting, direct sunlight, or infrared device signals may be interfering with the projector's remote receivers. Dim the lights or move the projector away from the sun or interfering equipment.
- 7** The streaming media player and the remote control may have been disconnected. Perform pairing again by holding down the  and right arrow buttons on the remote control at the same time for about seven seconds.

## » Related Links

- "Remote Control Operation" [p.19](#)

If you cannot operate the connected devices using the HDMI Link features, try the following steps until the problem is solved.

- 1** Make sure the cable meets the HDMI CEC standard.
- 2** Make sure the connected device meets the HDMI CEC standard. See the documentation supplied with the device for more information.
- 3** Check if the device is available in the **Device Connections** list.  
If the device does not appear in the **Device Connections** list, it does not meet the HDMI CEC standards. Connect a different device.  
☛ **Settings > Operation > HDMI Link > Device Connections**
- 4** Check that all cables required for HDMI Link are securely connected.
- 5** Make sure the connected devices are turned on and in standby status. See the documentation supplied with the device for more information.
- 6** If you connect a new device or change the connection, set the CEC function for the connected device again and restart the device.

## » Related Links

- "Projector Feature Settings - Settings Menu" [p.60](#)

If you cannot operate the Epson streaming media player, try the following steps until the problem is solved.

- 1** Make sure the streaming media player is securely connected to the projector.
- 2** You need an Internet connection to view online content. Make sure your Wi-Fi is on.
- 3** The Epson streaming media player and the remote control may have been disconnected. Perform pairing again by holding down the  and right arrow buttons on the remote control at the same time for about seven seconds.

## Caution

The streaming media player supplied with your projector is designed for use with this projector. Depending on the connected display device, the streaming media player may not work correctly.



After repairing the streaming media player, Epson may return the device to you in its initial status. Make sure you make a note of the account information of each online service before you contact your local dealer or the nearest Epson repair center.

At the end of the projector lamp's life, the message "**It is time to replace the projector. See your documentation for more information.**" is displayed. Turn the projector off and consider replacing the projector even if the lamp continues to work.

## **Warning**

- If you continue to use the projector after the lamp's life expires, the possibility that the lamp may explode increases.
- If the lamp breaks, note the following points:
  - Ventilate the area immediately.
  - Do not swing or tilt the projector. Shards of glass may fall out and could cause an injury.
  - If any shards of glass get into your eyes or mouth, contact a doctor immediately.

# Appendix

Check these sections for the technical specifications and important notices about your product.

## ► **Related Links**

- "Optional Accessories and Replacement Parts" [p.87](#)
- "Screen Size and Projection Distance" [p.88](#)
- "Supported Monitor Display Resolutions" [p.89](#)
- "Projector Specifications" [p.90](#)
- "External Dimensions" [p.91](#)
- "List of Safety Symbols and Instructions" [p.92](#)
- "Warning Labels" [p.94](#)
- "Glossary" [p.95](#)
- "Notices" [p.96](#)

The following optional accessories and replacement parts are available. Please purchase these products as and when needed.

The following list of optional accessories and replacement parts is current as of: March 2022.

Details of accessories are subject to change without notice and availability may vary depending on the country of purchase.

► **Related Links**

- "External Devices" [p.87](#)

---

## External Devices

### **Streaming Media Player ELPAP12**

Use this streaming media player to watch online content.

Check the table here to determine how far to place the projector from the screen based on the size of the projected image.

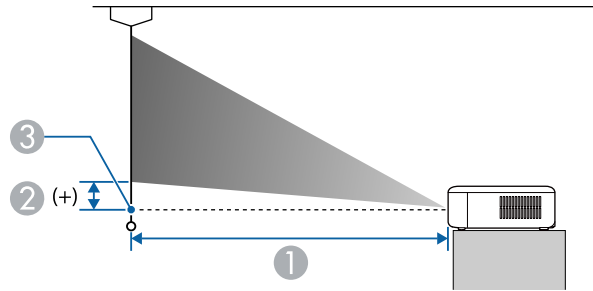

- ① Projection distance (cm)
- ② Distance from the center of the lens to the base of the screen (cm)
- ③ Center of lens

16:10 screen size		①	②
		Minimum (Wide) to Maximum (Tele)	
24"	52 × 32	67 - 91	-4 - 0
32"	69 × 43	90 - 122	-5 - 1
40"	86 × 54	113 - 154	-6 - 1
60"	129 × 81	171 - 231	-10 - 1
80"	172 × 108	228 - 309	-13 - 2
100"	215 × 135	286 - 387	-16 - 2
150"	323 × 202	430 - 581	-24 - 3
200"	431 × 269	574 - 776	-32 - 4
268"	577 × 361	770 - 1040	-43 - 5
300"	646 × 404	862 - 1165	-48 - 6
362"	780 × 487	1041 - 1406	-58 - 7

16:9 screen size		①	②
		Minimum (Wide) to Maximum (Tele)	
26"	58 × 32	67 - 91	-4 - 0
34"	75 × 42	89 - 120	-5 - 1
40"	89 × 50	105 - 142	-6 - 1
60"	133 × 75	158 - 214	-9 - 1
80"	177 × 100	211 - 286	-12 - 1
100"	221 × 125	264 - 358	-15 - 2
200"	443 × 249	531 - 717	-30 - 4
290"	642 × 361	771 - 1041	-43 - 5
300"	664 × 374	797 - 1077	-44 - 6
391"	866 × 487	1040 - 1404	-58 - 7

4:3 screen size		①	②
		Minimum (Wide) to Maximum (Tele)	
21"	43 × 32	66 - 91	-4 - 0
28"	57 × 43	89 - 121	-5 - 1
40"	81 × 61	128 - 174	-7 - 1
60"	122 × 91	194 - 262	-11 - 1
80"	163 × 122	259 - 350	-14 - 2
100"	203 × 152	324 - 438	-18 - 2
150"	305 × 229	487 - 658	-27 - 3
200"	406 × 305	650 - 878	-36 - 5
237"	482 × 361	771 - 1041	-43 - 5
300"	610 × 457	976 - 1319	-54 - 7
320"	650 × 488	1042 - 1407	-58 - 7



The tables here list the compatible refresh rate and resolution for each compatible video display format.

## HDMI Port Input Signals

Signal	Refresh rate (Hz)	Resolution (dots)
VGA	60	640 × 480
SVGA	60	800 × 600
XGA	60	1024 × 768
WXGA	60	1280 × 800
	60	1366 × 768
WXGA+	60	1440 × 900
WXGA++	60	1600 × 900
SXGA	60	1280 × 960
	60	1280 × 1024
SXGA+	60	1400 × 1050
WSXGA+	60	1680 × 1050
UXGA	60	1600 × 1200
1920 × 1080	50/60	1920 × 1080
WUXGA (Reduced Blanking)	60	1920 × 1200
SDTV (480i/480p)	59.94	720 × 480
SDTV (576i/576p)	50	720 × 576
HDTV (720p)	50/59.94/60	1280 × 720
HDTV (1080i)	50/59.94/60	1920 × 1080
HDTV (1080p)	23.98/24/29.97/30/50/59.94/60	1920 × 1080

Product name	CO-FH02
Dimensions	320 (W) × 82 (H) × 211 (D) mm (not including raised section)
LCD panel size	0.62"
Display method	Poly-silicon TFT active matrix
Resolution	2,073,600 pixels Full HD (1,920 (W) × 1,080 (H) dots) × 3
Focus adjustment	Manual
Zoom adjustment	1 to 1.35 (Digital Zoom)
Lamp	UHE lamp, 188 W
Lamp life	Normal Light Output mode: Up to 6,000 hours Low (Eco) Light Output mode: Up to 12,000 hours
Max. audio output	5 W
Speaker	1
Power supply	100-240V AC±10% 50/60Hz 2.9 - 1.3 A
Power consumption (100 to 120 V area)	Operating: 284 W
Power consumption (220 to 240 V area)	Operating: 270 W
Standby power consumption	0.5 W
Operating altitude	Altitude 0 to 3,048 m
Operating temperature *	Altitude of 0 to 2,286 m: +5 to +40°C (No condensation) Altitude of 2,287 to 3,048 m: +5 to +35°C (Humidity of 20 to 80%, No condensation)
Storage temperature	-10 to +60°C (Humidity of 10 to 90%, No condensation)
Mass	Approx. 2.6 kg

\* Lamp brightness automatically dims if the surrounding temperature gets too high. (Approximately 35°C at an altitude of 0 to 2,286 m, and approximately 30°C at an altitude of 2,287 to 3,048 m; however, this may vary depending on the surrounding environment.)

This product is also designed for IT power distribution system with phase-to-phase voltage 230V.

### Angle of tilt

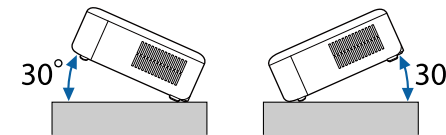

If you use the projector tilted at an angle of more than 30° it could be damaged and cause an accident.

### ► Related Links

- "Connector Specifications" [p.90](#)

## Connector Specifications

HDMI port	HDMI (Audio is only supported by PCM)
Service port	USB connector (Type B)
DC Out (2.0A) port	USB connector (Type A)



USB-A and Service port supports USB 2.0. However, USB ports are not guaranteed to operate all devices that support USB.

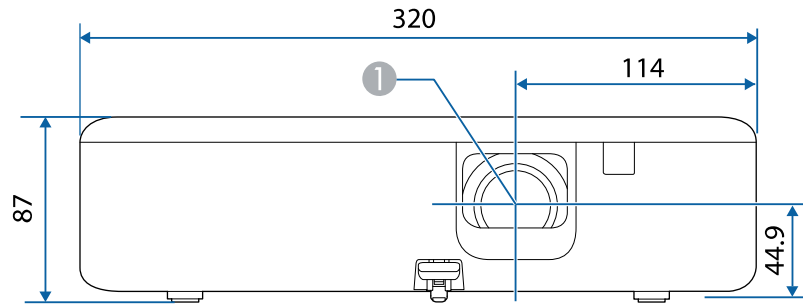



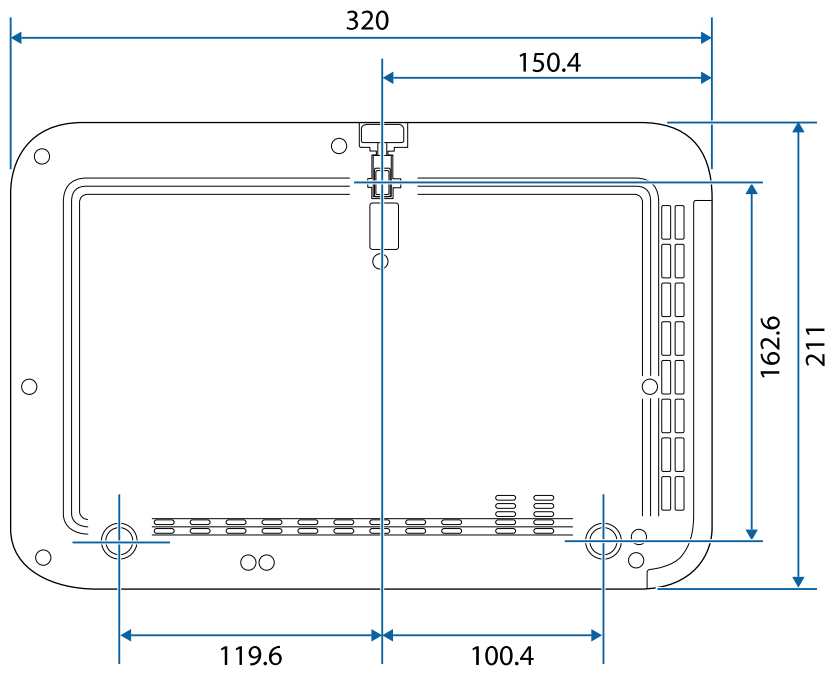













① Center of lens













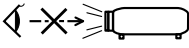

The unit in these illustrations is mm.

The following table lists the meaning of the safety symbols labeled on the equipment.

No.	Symbol mark	Approved standards	Description
1		IEC60417 No. 5007	"ON" (power) To indicate connection to the mains.
2		IEC60417 No. 5008	"OFF" (power) To indicate disconnection from the mains.
3		IEC60417 No. 5009	Stand-by To identify the switch or switch position by means of which part of the equipment is switched on in order to bring it into the stand-by condition.
4		ISO7000 No. 0434B, IEC3864-B3.1	Caution To identify general caution when using the product.
5		IEC60417 No. 5041	Caution, hot surface To indicate that the marked item can be hot and should not be touched without taking care.
6		IEC60417 No. 6042 ISO3864-B3.6	Caution, risk of electric shock To identify equipment that has risk of electric shock.
7		IEC60417 No. 5957	For indoor use only To identify electrical equipment designed primarily for indoor use.
8		IEC60417 No. 5926	Polarity of d.c. power connector To identify the positive and negative connections (the polarity) on a piece of equipment to which a d.c. power supply may be connected.

No.	Symbol mark	Approved standards	Description
9		—	The same as No. 8.
10		IEC60417 No. 5001B	Battery, general On battery powered equipment. To identify a device for instance a cover for the battery compartment, or the connector terminals.
11		IEC60417 No. 5002	Positioning of cell To identify the battery holder itself and to identify the positioning of the cell(s) inside the battery holder.
12		—	The same as No. 11.
13		IEC60417 No. 5019	Protective earth To identify any terminal which is intended for connection to an external conductor for protection against electric shock in case of a fault, or the terminal of a protective earth electrode.
14		IEC60417 No. 5017	Earth To identify an earth (ground) terminal in cases where neither the symbol No. 13 is explicitly required.
15		IEC60417 No. 5032	Alternating current To indicate on the rating plate that the equipment is suitable for alternating current only; to identify relevant terminals.
16		IEC60417 No. 5031	Direct current To indicate on the rating plate that the equipment is suitable for direct current only; to identify relevant terminals.

No.	Symbol mark	Approved standards	Description
17		IEC60417 No. 5172	Class II equipment To identify equipment meeting the safety requirements specified for Class II equipment according to IEC 61140.
18		ISO 3864	General prohibition To identify actions or operations that are prohibited.
19		ISO 3864	Contact prohibition To indicate injury that could occur due to touching a specific part of the equipment.
20		—	Never look into the optical lens while the projector is on.
21		—	To indicate that the marked item don't place anything on projector.
22		ISO3864 IEC60825-1	Caution, laser radiation To indicate the equipment has a laser radiation part.
23		ISO 3864	Disassembly prohibition To indicate a risk of injury, such as electric shock, if the equipment is disassembled.
24		IEC60417 No. 5266	Standby, partial standby To indicate that part of the equipment is in the ready status.
25		ISO3864 IEC60417 No. 5057	Caution, movable parts To indicate that you must keep away from movable parts according to protection standards.
26		IEC60417 No. 6056	Caution (Moving Fan Blades) As a safety precaution, stay away from the moving fan blades.

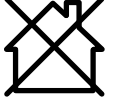
No.	Symbol mark	Approved standards	Description
27		IEC60417 No. 6043	Caution (Sharp Corners) To indicate sharp corners that should not be touched.
28		—	To indicate that looking into the lens while projecting is prohibited.
29		ISO7010 No. W027 ISO 3864	Warning, Optical radiation (such as UV, visible radiation, IR) Taking care to avoid injury to eyes and skin when in the vicinity of optical radiation.
30		IEC60417 No. 5109	Not to be used in residential areas. To identify electrical equipment which is not suitable for a residential area.

This product comes with warning labels.

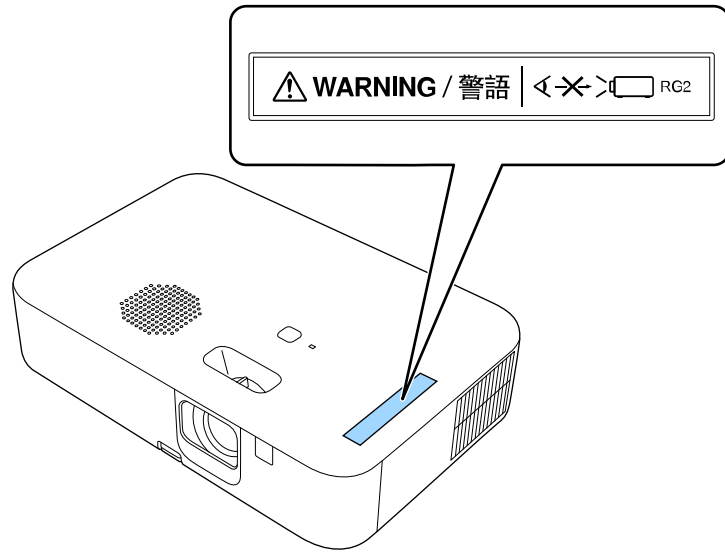

As with any bright source, do not stare into the beam, RG2 IEC/EN 62471-5:2015.

This section briefly explains the difficult terms that are not explained in the text of this guide. For details, refer to other commercially available publications.

Aspect Ratio	The ratio between an image's length and its height. Screens with a horizontal:vertical ratio of 16:9, such as HDTV screens, are known as wide screens. SDTV and general computer displays have an aspect ratio of 4:3.
Contrast	The relative brightness of the light and dark areas of an image can be increased or decreased to make text and graphics stand out more clearly, or to make them appear softer. Adjusting this particular property of an image is called contrast adjustment.
Full HD	A screen size standard with a resolution of 1,920 (horizontal) × 1,080 (vertical) dots.
HDCP	HDCP is an abbreviation for High-bandwidth Digital Content Protection. It is used to prevent illegal copying and protect copyrights by encrypting digital signals sent over DVI and HDMI ports. Because the HDMI port on this projector supports HDCP, it can project digital images protected by HDCP technology. However, the projector may not be able to project images protected with updated or revised versions of HDCP encryption.
HDMI™	An abbreviation for High Definition Multimedia Interface. HDMI™ is a standard aimed at digital consumer electronics and computers. This is the standard by which HD images and multichannel audio signals are digitally transmitted. By not compressing the digital signal, the image can be transferred at the highest quality possible. It also provides an encryption function for the digital signal.
HDTV	An abbreviation for High-Definition Television that refers to high-definition systems which satisfy the following conditions: <ul style="list-style-type: none"> <li>• Vertical resolution of 720p or 1080i or greater (p = Progressive, I = Interlace)</li> <li>• Screen aspect ratio of 16:9</li> </ul>

Interlace	Transmits information needed to create one screen by sending every other line, starting from the top of the image and working down to the bottom. Images are more likely to flicker because one frame is displayed every other line.
Progressive	Projects information to create one screen at a time, displaying the image for one frame. Even though the number of scan lines is the same, the amount of flicker in images decreases because the volume of information has doubled compared with an interlace system.
Refresh Rate	The light-emitting element of a display maintains the same luminosity and color for an extremely short time. Because of this, the image must be scanned many times per second to refresh the light-emitting element. The number of refresh operations per second is called the Refresh rate and is expressed in hertz (Hz).
SDTV	An abbreviation for Standard Definition Television that refers to standard television systems which do not satisfy the conditions for HDTV High-Definition Television.
SVGA	A screen size standard with a resolution of 800 (horizontal) × 600 (vertical) dots.
SXGA	A screen size standard with a resolution of 1,280 (horizontal) × 1,024 (vertical) dots.
Sync.	The signals output from computers have a specific frequency. If the projector frequency does not match this frequency, the resulting images are not of a good quality. The process of matching the phases of these signals (the relative position of the crests and the troughs in the signal) is called Synchronization. If the signals are not synchronized, flickering, blurriness, and horizontal interference occur.
VGA	A screen size standard with a resolution of 640 (horizontal) × 480 (vertical) dots.
XGA	A screen size standard with a resolution of 1,024 (horizontal) × 768 (vertical) dots.
WXGA	A screen size standard with a resolution of 1,280 (horizontal) × 800 (vertical) dots.

Check these sections for important notices about your projector.

► **Related Links**

- "FCC Compliance Statement" [p.96](#)
- "Indication of the manufacturer and the importer in accordance with requirements of EU directive" [p.97](#)
- "Indication of the manufacturer and the importer in accordance with requirements of United Kingdom directive" [p.97](#)
- "Restriction of Use" [p.97](#)
- "How to Dispose of the Projector" [p.97](#)
- "Operating System References" [p.97](#)
- "Trademarks" [p.98](#)
- "Copyright Notice" [p.98](#)
- "Copyright Attribution" [p.98](#)

## FCC Compliance Statement

### Supplier's DECLARATION of CONFORMITY

According to 47CFR, Part 2 and 15

Class B Personal Computers and Peripherals; and/or

CPU Boards and Power Supplies used with Class B Personal Computers

We: Epson America, Inc.

Located at: 3131 Katella Avenue, Los Alamitos, CA

Tel: 562-981-3840

Declare under sole responsibility that the product identified herein, complies with 47CFR Part 2 and 15 of the FCC rules as a Class B digital device. Each product marketed, is identical to the representative unit tested and found to be compliant with the standards. Records maintained continue to reflect the equipment being produced can be expected to be within the variation accepted, due to quantity production and testing on a statistical basis as required by 47CFR 2.906. Operation is subject to the following two conditions: (1) this device may not cause harmful interference, and (2) this

device must accept any interference received, including interference that may cause undesired operation.

Trade Name: EPSON

Type of Product: LCD Projector

Model: HA84A/HA85A/HA86A

Other destination model: HA84B/HA85B/HA86B

### FCC Compliance Statement For United States Users

This device complies with part 15 of the FCC Rules. Operation is subject to the following two conditions: (1) This device may not cause harmful interference, and (2) this device must accept any interference received, including interference that may cause undesired operation.

This equipment has been tested and found to comply with the limits for a Class B digital device, pursuant to Part 15 of the FCC Rules. These limits are designed to provide reasonable protection against harmful interference in a residential installation. This equipment generates, uses, and can radiate radio frequency energy and, if not installed and used in accordance with the instructions, may cause harmful interference to radio communications. However, there is no guarantee that interference will not occur in a particular installation. If this equipment does cause interference to radio and television reception, which can be determined by turning the equipment off and on, the user is encouraged to try to correct the interference by one or more of the following measures.

- Reorient or relocate the receiving antenna.
- Increase the separation between the equipment and receiver.
- Connect the equipment into an outlet on a circuit different from that to which the receiver is connected.
- Consult the dealer or an experienced radio/TV technician for help.

### WARNING

The connection of a non-shielded equipment interface cable to this equipment will invalidate the FCC Certification or Declaration of this device and may cause interference levels which exceed the limits established by the FCC for this equipment. It is the responsibility of the user to obtain and use a shielded equipment interface cable with this device. If this equipment has



more than one interface connector, do not leave cables connected to unused interfaces. Changes or modifications not expressly approved by the manufacturer could void the user's authority to operate the equipment.

---

### Indication of the manufacturer and the importer in accordance with requirements of EU directive

Manufacturer: SEIKO EPSON CORPORATION  
Address: 3-5, Owa 3-chome, Suwa-shi, Nagano-ken 392-8502 Japan  
Telephone: 81-266-52-3131  
<http://www.epson.com/>

Importer: EPSON EUROPE B.V.  
Address: Atlas Arena, Asia Building, Hoogoorddreef 5,1101 BA Amsterdam  
Zuidoost  
The Netherlands  
Telephone: 31-20-314-5000  
<http://www.epson.eu/>

---

### Indication of the manufacturer and the importer in accordance with requirements of United Kingdom directive

Manufacturer: SEIKO EPSON CORPORATION  
Address: 3-5, Owa 3-chome, Suwa-shi, Nagano-ken 392-8502 Japan  
Telephone: 81-266-52-3131  
<http://www.epson.com/>

Importer: Epson (UK) Ltd.  
Address: Westside, London Road, Hemel Hempstead, Hertfordshire, HP3 9TD,  
United Kingdom  
<http://www.epson.co.uk>

---

### Restriction of Use

When this product is used for applications requiring high reliability/safety such as transportation devices related to aviation, rail, marine, automotive etc.; disaster prevention devices; various safety devices etc; or functional/precision devices etc, you should use this product only after giving consideration to including fail-safes and redundancies into your design to maintain safety and total system reliability. Because this product was not intended for use in applications requiring extremely high reliability/safety such as aerospace equipment, main communication equipment, nuclear power control equipment, or medical equipment related to direct medical care etc, please make your own judgment on this product's suitability after a full evaluation.

---

### How to Dispose of the Projector

The lamp in this product contains mercury (Hg). When you dispose of the projector at the end of a product's life, check your local laws and regulations regarding disposal or recycling. Do not put it in the trash with ordinary garbage.

---

### Operating System References

- Microsoft® Windows® 8.1 operating system
- Microsoft® Windows® 10 operating system
- Microsoft® Windows® 11 operating system

In this guide, the operating systems above are referred to as "Windows 8.1", "Windows 10", and "Windows 11". Furthermore, the collective term "Windows" is used to refer to them all.

- macOS 10.13.x
- macOS 10.14.x
- macOS 10.15.x
- macOS 11.0.x
- macOS 12.0.x

In this guide, the collective term "Mac" is used to refer to all of the operating systems above.

---

## Trademarks

EPSON is a registered trademark, EXCEED YOUR VISION, ELPLP and their logos are registered trademarks or trademarks of Seiko Epson Corporation.

iPad, iPhone, Mac, OS X, iOS, and macOS are trademarks of Apple Inc.

Microsoft, Windows, and the Windows logo are trademarks or registered trademarks of Microsoft Corporation in the United States and/or other countries.

Google, Google Play, YouTube and Android TV are trademarks of Google LLC.

Google Assistant is not available in certain languages and countries. Availability of services varies by country and language.

HDMI, the HDMI Logo and High-Definition Multimedia Interface are trademarks or registered trademarks of HDMI Licensing Administrator, Inc.



Wi-Fi® is a trademark of the Wi-Fi Alliance®.

The Bluetooth® word mark and logo are registered trademarks of Bluetooth SIG, Inc., and the Seiko Epson Corporation uses these marks under license. Other trademarks or trade names are the property of their respective owners.

Netflix is a registered trademark of Netflix, Inc. **NETFLIX**

Other product names used herein are also for identification purposes only and may be trademarks of their respective owners. Epson disclaims any and all rights in those marks.

---

## Copyright Notice

All rights reserved. No part of this publication may be reproduced, stored in a retrieval system, or transmitted in any form or by any means, electronic, mechanical, photocopying, recording, or otherwise, without the prior written permission of Seiko Epson Corporation. No patent liability is assumed with respect to the use of the information contained herein. Neither is any liability assumed for damages resulting from the use of the information contained herein.

Neither Seiko Epson Corporation nor its affiliates shall be liable to the purchaser of this product or third parties for damages, losses, costs, or expenses incurred by the purchaser or third parties as a result of: accident, misuse, or abuse of this product or unauthorized modifications, repairs, or alterations to this product, or (excluding the U.S.) failure to strictly comply with Seiko Epson Corporation's operating and maintenance instructions.

Seiko Epson Corporation shall not be liable against any damages or problems arising from the use of any options or any consumable products other than those designated as Original Epson Products or Epson Approved Products by Seiko Epson Corporation.

The contents of this guide may be changed or updated without further notice.

---

## Copyright Attribution

This information is subject to change without notice.

© 2022 Seiko Epson Corporation

2022.4 414272600EN

## Free Manuals Download Website

<http://myh66.com>

<http://usermanuals.us>

<http://www.somanuals.com>

<http://www.4manuals.cc>

<http://www.manual-lib.com>

<http://www.404manual.com>

<http://www.luxmanual.com>

<http://aubethermostatmanual.com>

Golf course search by state

<http://golfingnear.com>

Email search by domain

<http://emailbydomain.com>

Auto manuals search

<http://auto.somanuals.com>

TV manuals search

<http://tv.somanuals.com>