



User's Guide

Multimedia Projector

EB-L1075U

EB-L1050U

EB-L1070U

EB-L1070W

EB-L1065U

EB-L1060W

EB-L1060U



EB-L1070

Notations Used in This Guide



- **Safety indications**

The documentation and the projector use graphical symbols to show how to use the projector safely.

The indications and their meaning are as follows. Make sure you understand them properly before reading the guide.

 Warning	This symbol indicates information that, if ignored, could possibly result in personal injury or even death due to incorrect handling.
 Caution	This symbol indicates information that, if ignored, could possibly result in personal injury or physical damage due to incorrect handling.

- **General information indications**

Attention	Indicates procedures which may result in damage or injury if sufficient care is not taken.
	Indicates additional information and points which may be useful to know regarding a topic.
	Indicates a page where detailed information regarding a topic can be found.
[Name]	Indicates the name of the buttons on the remote control or the control panel. Example: [Esc] button
Menu Name	Indicates Configuration menu items. Example: Select Brightness from Image . Image - Brightness

Make sure you read the following before you use the projector.

☛ [Safety Instructions](#)

Warning and Cautions on Installation

An optional ceiling mount is required when suspending the projector from a ceiling.

☛ "Optional Accessories" [p.233](#)

Warning

- Do not use or install the projector where it may be subject to water or rain, or high humidity, such as outdoors, in a bathroom, or shower room, and so on. Otherwise, it could cause a fire or electric shock.
- Do not install in locations where salt damage could occur, or in locations subject to corrosive gas such as sulphuric gas from hot springs. Otherwise, corrosion could cause the projector to fall. It could also cause the projector to malfunction.
- A special method of installation is required when suspending the projector from a ceiling (ceiling mount). If installation work is not carried out correctly, the projector could fall down. This may result in injury or accidents. Contact your local dealer or the nearest address provided in the Epson Projector Contact List.
☛ [Epson Projector Contact List](#)
- Failure to install the ceiling mount and projector may cause the projector to fall. After installing the specific Epson mount that supports your projector, make sure you secure the projector and the mount using wire that is strong enough to hold their weight.
- If you use adhesives on the ceiling mount fixing points to prevent the screws from loosening, or if you use things such as lubricants or oils on the projector, the projector case may crack causing it to fall from its ceiling mount. This could cause an accident or injury to anyone under the ceiling mount.
When installing or adjusting the ceiling mount, do not use adhesives, lubricants, oils, and so on to prevent the screws from loosening.

Warning

- Do not install the projector in locations subject to high humidity or dust, or locations subject to oil or steam, such as kitchen counters, kitchens, or near humidifiers. Otherwise, electric shock or fire could occur. Also, oily particles in the air could cause the projector case to deteriorate causing the projector to fall from the mount if it is suspended from a ceiling.
- Do not cover the projector's air intake vent or air exhaust vent. If either of the vents are covered, the internal temperature could rise and cause a fire.
- Do not place flammable objects in front of the lens. If you set the schedule to turn on the projector automatically, any flammable objects placed in front of the lens could cause a fire.
- Do not tie the power cord and other connection cables together. Otherwise, it could cause a fire.
- Only use the specified power-supply voltage. Otherwise, it could cause a fire or electric shock.

Warning

- Be careful when handling the power cord. Otherwise, it could cause a fire or electric shock. Note the following when handling the power cord.
 - Do not plug multiple power cords in a single electric outlet.
 - Do not plug in the power cord if there are any foreign substances, such as dust, stuck to it.
 - Make sure you insert the power cord all the way in.
 - Do not plug in or unplug the power cord with wet hands.
 - Do not pull the cord when unplugging the power cord. Make sure you hold it by the plug.
- Do not use a damaged power cord. Otherwise, it could cause a fire or electric shock. Note the following when handling the power cord.
 - Do not alter the power cord.
 - Do not place any heavy objects on the power cord.
 - Do not bend, twist, or pull the power cord forcibly.
 - Do not layout the power cord near a heating device.

Caution

Do not place the projector on an unstable surface, such as on an unstable table or tilted surface. When projecting vertically, install the projector appropriately to prevent the projector from falling. Otherwise it may cause an injury.

Attention

- Do not install the projector in a location that is subject to vibration or shock.
- Do not install the projector near a high-voltage line or object that generates magnetism. Otherwise the projector may not work correctly.
- Do not use or store the projector in a location that is subject to extreme temperatures. Also, avoid sudden temperature changes. Make sure you maintain the operating or storage temperature ranges.
 - ☛ “Projector General Specifications” [p.279](#)
- When installing the projector in an environment in which a high-powered laser beam is being used, make sure it is installed so that the laser beam does not hit the surface of the projection lens.
- When using at an altitude that exceeds 1,500 m, set **High Altitude Mode** to **On**.
 - ☛ **Extended - Operation - High Altitude Mode** [p.146](#)
- The projector can be installed at any angle. There is no vertical or horizontal limit to how the projector can be installed.

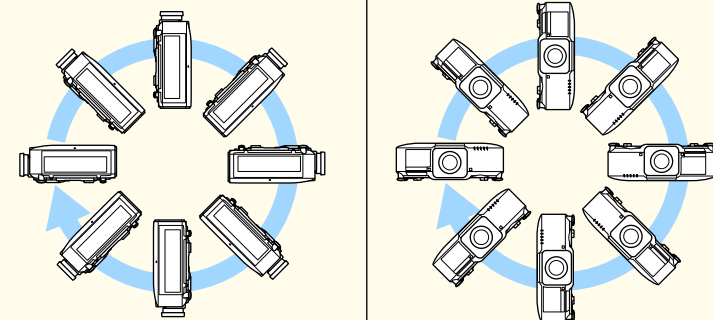

- You may need dedicated installation mounts to tilt and install the projector. Contact a professional and prepare the mount.
- Plan so that the mount does not fall.

Attention

- Make sure you secure the following space around the projector so as not to block the air exhaust vent and the air intake vent.

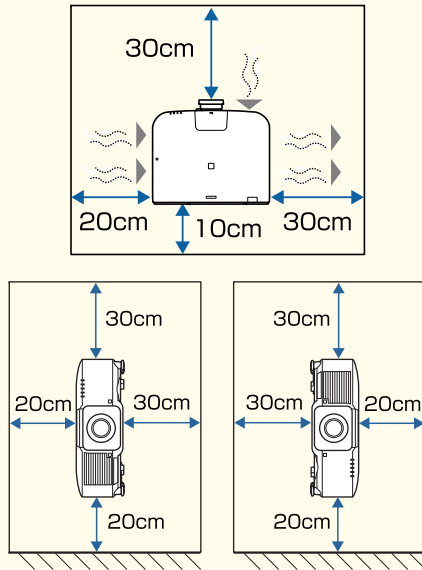

- When setting up multiple projectors, make sure there is a gap of at least 70 cm between the projectors. Also, make sure that the heat from the air exhaust vent does not go into the air intake vent.

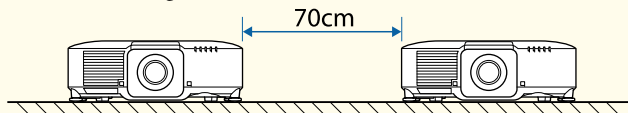

- Secure the following space when placing a partition between projectors.

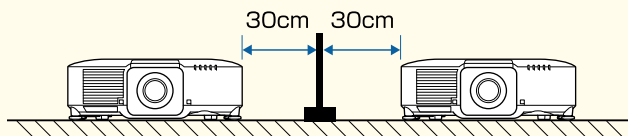

Attention

- Do not stack projectors directly on top of each other.

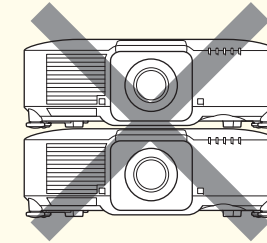

- When using the ceiling mount or the portrait mount, use commercially available M6 screws (up to a depth of 14 mm) to fix the projector's ceiling mount fixing points and the mount at four points.

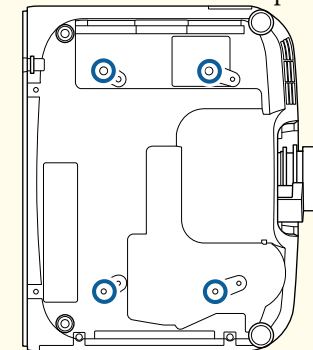

- We recommend setting the focus, zoom, and lens shift at least 20 minutes after you start the projection, because images are not stable right after turning on the projector.
- When adjusting the image height with the vertical lens shift, adjust by moving the image from the bottom to the top. If it is adjusted from the top to the bottom, the image position may move down slightly after adjusting.

Warning and Cautions on Usage

Warning

- Do not cover the projector's air intake vent or air exhaust vent. If either of the vents is covered, the internal temperature could rise and cause a fire.
- Do not look into the lens while projecting. The powerful light emitted could cause damage to eyesight. Take particular care when there are children present. When turning on the projector at a distance using the remote control, make sure there is no one looking into the lens.
- During projection, do not block the light from the projector with the lens cover (removable) or a book and so on.

If the light from the projector is blocked, the area on which the light shines becomes hot which could cause it to melt, burn, or start a fire. Also, the lens may get hot due to the reflected light which could cause the projector to malfunction. To stop projection, use the A/V Mute function, or turn off the projector.

- Do not open the projector's case. Never disassemble or remodel the projector. There are high-voltage components inside the projector that could cause fire, electric shock, or an accident.
- If an error occurs, disconnect the power cord from the electrical outlet, and contact your local dealer or the nearest address provided in the Epson Projector Contact List. If you continue using the projector as it is, it could cause an electric shock, fire, or even damage to eyesight.

 [Epson Projector Contact List](#)

Caution

Do not place objects that may become warped or otherwise affected by heat near the air exhaust vent and do not put your face or hands near the vent while projection is in progress.

Attention

- Only remove the lens unit when necessary. If dust or dirt enter the projector, projection quality deteriorates and it could cause a malfunction.
- Try not to touch the lens section with your hand or fingers. If fingerprints or oils are left on the surface of the lens, projection quality deteriorates.
- If you continue to project while the surface of the lens is dirty, projection quality deteriorates. Make sure you clean the lens.  “Cleaning the Lens” p.204
- Store the projector with the lens unit installed.
If the projector is stored without the lens unit, dust and dirt may get inside the projector and cause malfunctions or lower the quality of projection.
- When storing, make sure you remove the batteries from the remote control. If the batteries are left in the remote control for an extended period of time, they may leak.



- About the LCD panel
 - The LCD panel may contain pixels that are missing or appear bright all the time. This is not a sign of an error.
 - When a high-powered laser beams through the surface of the projection lens even when it is not being used, it can cause a malfunction in the LCD panel. Attach the lens cover when storing the projector.
- About the light source

The projector uses a laser as the light source. The laser has the following characteristics.

 - Depending on the surroundings, the brightness of the light source may decline. The brightness declines a lot when the temperature gets too high.
 - The brightness of the light source declines the longer it is used. You can change the relationship between usage time and decline in brightness in **Brightness Settings**.
 - ☛ "Relationship between Brightness Level and light source operation time" [p.78](#)
- About Light Source Calibration
 - When **Run Periodically** is set to **On** for Light Source Calibration, every time the usage time reaches 100 hours, calibration starts automatically for the light source when the projector is turned off. However, this does not start automatically when the projector is used continuously for more than 24 hours, or when direct shutdown is used regularly. Set **Light Source Calibration** in the scheduling function.
 - ☛ "Scheduling Function" [p.112](#)
 - When performing Light Source Calibration, the difference between the white balance and the brightness level for the light source is corrected.
 - ☛ **Reset - Light Source Calibration - Run Periodically** [p.162](#)

Warning and Cautions on the Laser

Warning

- Laser warning labels are attached inside the projector and on the side of the projector.

Inside

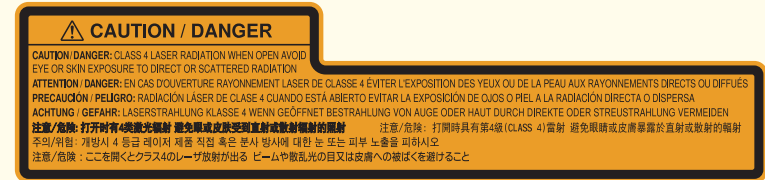

Side

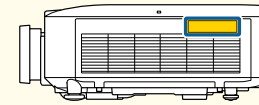
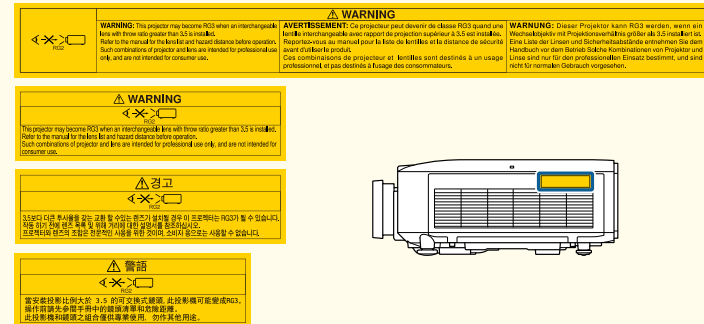

Warning

- Do not open the projector's case. The projector contains a high-powered laser.
- Do not look into the laser beam being emitted from the projection lens while projecting. (Based on the RG2 IEC/EN 62471-5: 2015)
- This projector may become RG3 when an interchangeable lens with a throw ratio greater than 3.5 is installed. See the manual for the lens list and hazardous distances before operation. Such combinations of projector and lens are intended for professional use only, and are not intended for consumer use.

Caution

- This projector is a Class 1 laser product that complies with the IEC/ EN60825-1: 2014 international standard for lasers.
- Do not disassemble the projector when disposing of it. Dispose according to your local or national laws and regulations.

Notes on Transporting

There are many glass parts and precision components inside the projector. To prevent damage due to impacts when transporting, handle the projector as follows.

Caution

The projector should not be carried by one person. At least two people are needed to unpack or carry the projector.

Attention

- Moving Nearby
 - Turn off the power to the projector and disconnect all cables.
 - Attach the cover to the lens.
- When Transporting

After checking the points in "Moving Nearby", prepare the following and then pack up the projector.

 - Remove the lens unit if an option lens is installed.
 - If the projector does not have a lens, attach the cover that was on the lens mount when you purchased the projector.
 - Attach the lens if the projector has a built-in lens. Upon purchase, attach the protective pad that is attached around the lens unit.
 - Move the lens position to the home position.
 "Adjusting the Position of the Projected Image (Lens Shift Adjustment)" [p.34](#)
 - Enclose the projector securely in packaging material to protect it from shock, and place it into a strong container. Be sure to notify the carrier company that it is precision equipment and that it needs to be kept horizontally during transportation.



Notations Used in This Guide 2

Introduction

Part Names and Functions 15

Front/Top	15
Rear	16
Connector Ports	17
Base	18
Control Panel	18
Remote Control	20
Handy remote control operations	22
Replacing the remote control batteries	23
Remote control operating range	24
Connecting a cable to the remote control	24

Preparing the Projector

Installing the Projector 27

Removing and Attaching the Projector Lens Unit	27
Attaching	27
Lens Calibration	29
Removing	30
Installation Settings	31
Changing the direction of the image (projection mode)	31
Screen Settings	32
Adjusting the position of the image on the projected screen	32
Displaying the Test Pattern	33
Adjusting the Position of the Projected Image (Lens Shift Adjustment)	34
Adjusting the Image Size	37
Correcting the Focus	38
Correcting Distortion (Image Warping)	38
Registering and Loading Lens Adjustment Values	39
Adjusting the Height of the Projected Image (for Normal Installment)	41
Adjusting the Horizontal Tilt (for Normal Installment)	42

ID Settings	42
Set the projector ID	42
Checking the projector ID	43
Setting the remote control ID	43
Setting the Time	44
Other Settings	45
Settings related to basic operations	45
Settings related to display	46

Connecting Equipment 47

Connecting a Computer	47
Connecting Image Sources	49
Connecting External Equipment	51
Connecting a LAN Cable	52
Connecting an HDBaseT Transmitter	53
Installing the Wireless LAN Unit	54
Attaching the Cable Cover	55
Attaching	55

Basic Usage

Turning On the Projector 58

Home Screen	59
-------------------	----

Turning Off the Projector 60

Projecting Images 61

Automatically Detecting Input Signals and Changing the Projected Image (Source Search)	61
Switching to the Target Image by Remote Control	62
Adjusting the Volume	63

Adjusting the Projected Images 64

Correcting Distortion in the Projected Image	64
H/V-Keystone	65
Quick Corner	66
Curved Surface	67
Corner Wall	71



- Point Correction 74
- Selecting the Projection Quality (Selecting Color Mode) 76
- Setting the Brightness 77
 - Guide to Estimated Remains 78
 - Relationship between Brightness Level and light source operation time 78
- Setting the Amount of Light of the Projected Image 79
- Changing the Aspect Ratio of the Projected Image 80
 - Changing methods 80
- Adjusting the Image 81
 - Hue, Saturation, and Brightness adjustment 81
 - Gamma adjustment 82
- Adjusting Image Resolution (Image Enhancement) 83
 - 4K Enhancement (EB-L1075U/EB-L1070U/EB-L1065U/EB-L1060U/EB-L1050U only) 83
 - Image Preset Mode 84
 - Frame Interpolation 85
 - Noise Reduction 86
 - MPEG Noise Reduction 86
 - Super-resolution 87
 - Detail Enhancement 87
- Projecting 3D Images 87

Useful Functions

- Multi-Projection Function 90**
 - Adjustment Procedure 90
 - Advance preparation 90
 - Adjusting the projected position 90
 - Adjusting the projected images 90
 - Tiling 90
 - Edge Blending 91
 - Black Level 93
 - Color Matching 96
 - Displaying a Scaled Image 97
- Projection Functions 99**
 - Projecting Two Images Simultaneously (Split Screen) 99

- Input Sources for Split Screen Projection 99
 - Operating procedures 100
 - Restrictions during split screen projection 102
- Hiding the Image and Sound Temporarily (A/V Mute) 102
- Freezing the Image (Freeze) 103
- Enlarging Part of the Image (E-Zoom) 104
- Saving a User's Logo 104

Content Playback Feature 106

- Switching to Content Playback Mode 106
- Playing a Playlist 106
- Adding Effects to Images (Effect Feature) 107
- Restrictions on Content Playback Mode 108

Memory Function 110

- Saving/Loading/Erasing/Resetting the Memory 110

Scheduling Function 112

- Saving an Event 112
 - Setting an Event 112
 - Checking an Event 113
 - Editing an Event 113

Security Functions 115

- Managing Users (Password Protection) 115
 - Kinds of Password Protection 115
 - Setting Password Protection 115
 - Entering the password 116
- Restricting Operation 117
 - Control Panel Lock 117
 - Lens Lock 118
 - Remote control button lock 118
- Anti Theft/Fall Prevention 119



Using the Projector on a Network

Wired Network Projection	121
Selecting Wired Network Settings	121
Wireless Network Projection	124
Selecting Wireless Network Settings Manually	124
Selecting Wireless Network Settings in Windows	127
Selecting Wireless Network Settings in Mac	127
Setting Up Wireless Network Security	127
Supported Client and CA Certificates	129
Using a QR Code to Connect a Mobile Device	130
Using a USB Key to Connect a Windows Computer	131
Secure HTTP	132
Importing a Web Server Certificate Using the Menus	132
Supported Web Server Certificates	133
Setting a certificate using a Web browser	133

Configuration Menu

Configuration Menu Operations	136
List of Functions	137
Configuration Menu Table	137
Network menu	138
Image Menu	140
Signal Menu	142
Settings Menu	143
Extended Menu	146
Network Menu	151
Notes on operating the Network menu	152
Soft keyboard operations	152
Basic menu	153
Wireless LAN menu	154
Wired LAN menu	157
Notifications menu	158

Others menu	159
Reset menu	160
Info Menu (Display Only)	161
Reset Menu	162

Batch Setup

Setup Using a USB Flash Drive	165
Saving settings to the USB flash drive	165
Reflecting saved settings to other projectors	167
Setup by Connecting the Computer and Projector with a USB Cable	168
Saving settings to a computer	168
Reflecting saved settings to other projectors	169
When Setup Fails	171

Troubleshooting

Using the Help	173
Reading the Indicators	175
Reading the Status Display	182
Explanations of the Display Content	183
Problem Solving	190
Problems Relating to Images	191
No images appear	191
Moving images are not displayed	191
Projection stops automatically	192
Not supported is displayed	192
No Signal is displayed	192
Images are fuzzy, out of focus, or distorted	193
Interference or distortion appear in images	193
The image is truncated (large) or small, the aspect is not suitable, or the image has been reversed	194
Image colors are not right	195
Images appear dark	195
Problems when Projection Starts	196
The projector does not turn on	196

Problems with Content Playback Mode 197
 Cannot play the playlist 197
 Other Problems 197
 There are afterimages (screen burn-in) in the projected image 197
 No sound can be heard or the sound is faint 198
 The remote control does not work 198
 Nothing appears on the external monitor 199
 I want to change the language for messages and menus 199
 Email is not received even if a problem occurs in the projector 200
 The battery that saves your clock settings is running low, is displayed 200

About Event ID 201

Maintenance

Cleaning the Parts 204

Cleaning the Projector 204
 Cleaning the Lens 204
 Cleaning the Air Filter and Air Intake Vent 204
 Cleaning the air filter 205
 Cleaning the air intake vent 206

Replacing Consumables 208

Replacing the Air Filter 208
 Air filter replacement period 208
 Replacing the air filter 208

Image Maintenance 210

Panel Alignment 210
 Color Uniformity 212

Appendix

Monitoring and Controlling 215

Epson Projector Management 215
 Changing Settings Using a Web Browser (Epson Web Control) 215

Displaying the Epson Web Control Screen 215
 Basic Control Screen 216
 OSD Control Pad Screen 217
 Lens Control Screen 218
 Status Information Screen 220
 Changing Settings Using a Web Browser (Content Playback Mode) 220
 Remote 222
 Playlists 223
 USB Memory Device 223
 Time Table 224
 OSD Control Pad 224
 Using the Mail Notification Function to Report Problems 225
 Reading error notification mail 225
 Management Using SNMP 226
 ESC/VP21 Commands 226
 Command list 226
 Cable layouts 226
 About PLink 227
 About Crestron Connected® 228
 Operating a projector from your computer 228
 About Web API 232

Optional Accessories and Consumables 233

Optional Accessories 233
 Consumables 233

Screen Size and Projection Distance 234

Projection Distances for EB-L1075U/EB-L1070U/EB-L1065U/EB-L1060U/EB-L1050U/
 EB-L1070W/EB-L1060W 234
 ELPLM08 234
 ELPLX01/ELPLX01W 235
 ELPLU03 236
 ELPLU04/ELPLU02 237
 ELPLW05 238
 ELPLW06/ELPLW04 239
 ELPLW08 240
 ELPLM15/ELPLM09/ELPLS04 241
 ELPLM10/ELPLM06 242
 ELPLM11/ELPLM07 243

ELPLL08/ELPLL07	244
ELPLR04	245
Projection Distances for EB-L1070	247
ELPLM08	247
ELPLX01/ELPLX01W	248
ELPLU03	249
ELPLU04/ELPLU02	250
ELPLW05	251
ELPLW06/ELPLW04	252
ELPLW08	253
ELPLM15/ELPLM09/ELPLS04	254
ELPLM10/ELPLM06	255
ELPLM11/ELPLM07	256
ELPLL08/ELPLL07	257
ELPLR04	258
Polarizer (ELPPL01) Installation Distance	259
EB-L1075U/EB-L1070U/EB-L1065U/EB-L1060U/EB-L1050U	259
EB-L1070W/EB-L1060W	259
EB-L1070	259
Adjustment Range for Projected Images	261
H/V-Keystone	261
Curved Surface	261
Corner Wall	268
Supported Monitor Displays	274
Supported Monitor Displays	274
PC	274
SD	276
HD	276
4K (EB-L1075U/EB-L1070U/EB-L1065U/EB-L1060U/EB-L1050U only)	277
Specifications	279
Projector General Specifications	279
Appearance	284
General Notes	285
About Notations	285

Trademarks and Copyrights	285
List of Safety Symbols	287
Index	289



Introduction

This chapter explains the names for each part.

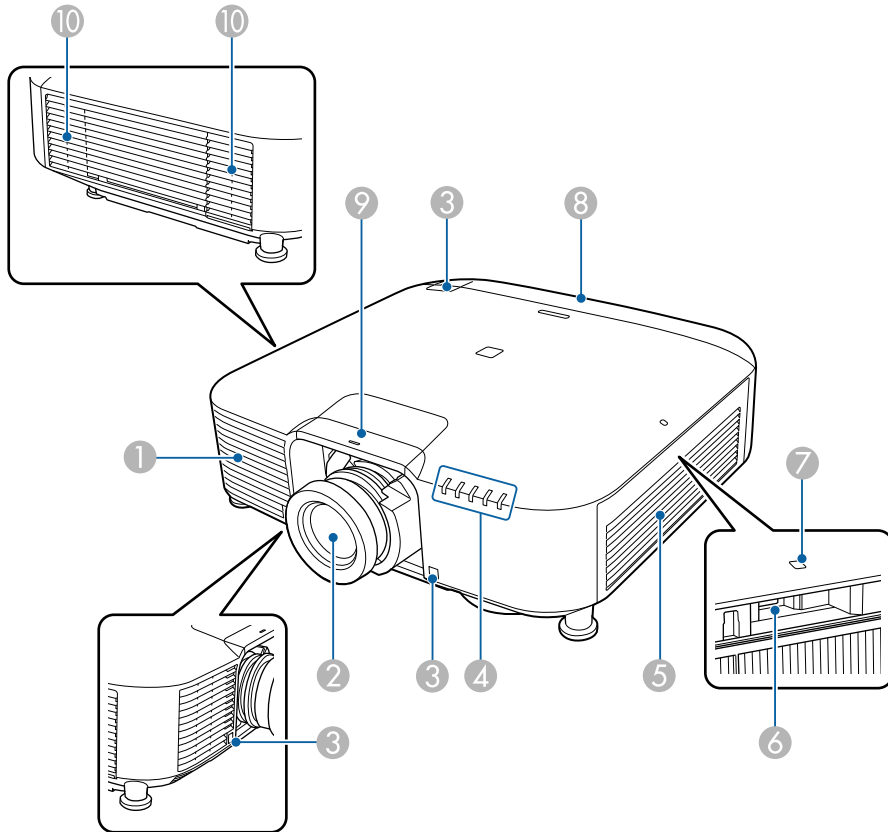

The illustrations in this guide show the lens unit attached to the projector.

Front/Top







Name	Function
① Air intake vent	Takes in air to cool the projector internally.

Name	Function
② Projection lens	<p>Images are projected through here.</p> <div style="border: 1px solid black; padding: 5px; margin: 5px 0;"> <p>⚠ Warning</p> <p>Do not look into the lens while projecting. This could cause damage to eyesight due to the powerful light emitted.</p> </div> <div style="border: 1px solid black; padding: 5px; margin: 5px 0;"> <p>⚠ Caution</p> <p>When shifting the lens, do not put your hands near the lens unit. Your fingers may get caught between the lens unit and the projector, and cause an injury.</p> </div>
③ Remote Receiver	Receives signals from the remote control.
④ Status indicators	<p>The color of the indicators and whether they are flashing or lit indicate the status of the projector.</p> <p>☛ "Reading the Indicators" p.175</p>
⑤ Air intake vent (air filter)	<p>Takes in air to cool the projector internally.</p> <p>☛ "Cleaning the Air Filter and Air Intake Vent" p.204</p>
⑥ USB-A port	<ul style="list-style-type: none"> Allows you to install the optional wireless LAN unit and connect the projector to the network. Allows you to connect a commercially available USB flash drive and play the playlist in Content Playback mode.
⑦ Wireless LAN indicator	<p>Indicates the access status to the optional wireless LAN unit.</p> <p>☛ "Optional Accessories and Consumables" p.233</p>
⑧ Cable cover	<p>Cover for the port connectors section at the rear to protect connected cables.</p> <p>☛ "Attaching the Cable Cover" p.55</p>

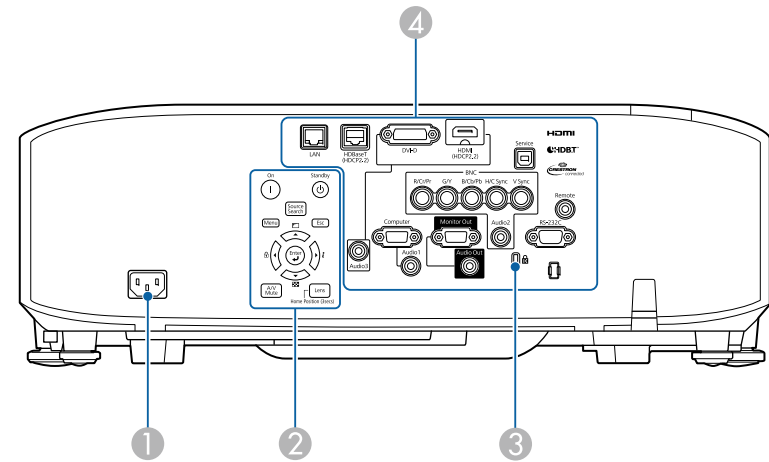
Name	Function
9 Lens replacement cover	<p>Remove when attaching or removing the lens.  "Removing and Attaching the Projector Lens Unit" p.27</p> <div style="border: 1px solid black; padding: 5px; background-color: #ffffcc;"> <p> Caution</p> <p>When moving the projector, do not hold the lens replacement cover. The lens replacement cover may be removed and the projector may fall, which could cause an injury.</p> </div>
10 Air exhaust vent	<p>Exhaust vent for air used to cool the projector internally.</p> <div style="border: 1px solid black; padding: 5px; background-color: #ffffcc;"> <p> Caution</p> <p>While projecting, do not put your face or hands near the air exhaust vent, and do not place objects that may become warped or damaged by heat near the vent. Hot air from the air exhaust vent could cause burns, warping, or accidents to occur.</p> </div>

Rear



Name	Function
1 Power inlet	Connects the power cord to the projector.
2 Control panel	 "Control Panel" p.18
3 Security slot	<p>The security slot is compatible with the Microsaver Security System manufactured by Kensington.</p> <p> "Anti Theft/Fall Prevention" p.119</p>
4 Connector Ports	 "Connector Ports" p.17

Connector Ports

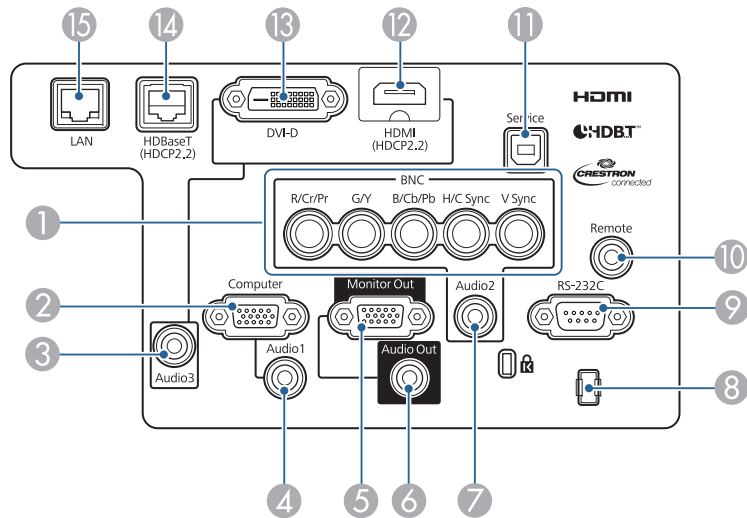

Name	Function
1 BNC port	For analog RGB signals from a computer and component video signals from other video sources.
2 Computer Port	For analog RGB signals from a computer and component video signals from other video sources.
3 Audio3 port	Inputs audio from equipment connected to the HDMI port or the DVI-D port.
4 Audio1 port	Inputs audio from equipment connected to the Computer port.
5 Monitor Out port	Outputs to an external monitor the analog signal from the computer connected to the Computer port or the BNC port. You cannot output signals input from other ports or component video signals.
6 Audio Out port	Outputs audio from the currently projected image to an external speaker.
7 Audio2 port	Inputs audio from equipment connected to the BNC port.

Name	Function
8 Cable holder	Run a commercially available cable tie to secure cables.
9 RS-232C port	When controlling the projector from a computer, connect it to the computer with an RS-232C cable. This port is for control use and should not normally be used. ☛ "ESC/VP21 Commands" p.226
10 Remote port	Connects the optional remote control cable set and inputs signals from the remote control. When the remote control cable is plugged into the Remote port, the remote receiver on the projector is disabled. ☛ "Optional Accessories and Consumables" p.233
11 Service port	This is used for batch settings. This port is for control use and should not normally be used. ☛ "Batch Setup" p.164
12 HDMI port	Inputs video signals from HDMI compatible video equipment and computers.
13 DVI-D port	Inputs the computer DVI-D signals.
14 HDBaseT port	Connects a LAN cable to the optional HDBaseT Transmitter. ☛ "Connecting an HDBaseT Transmitter" p.53 ☛ "Optional Accessories and Consumables" p.233
15 LAN port	Connects a LAN cable to connect to a network.

Base

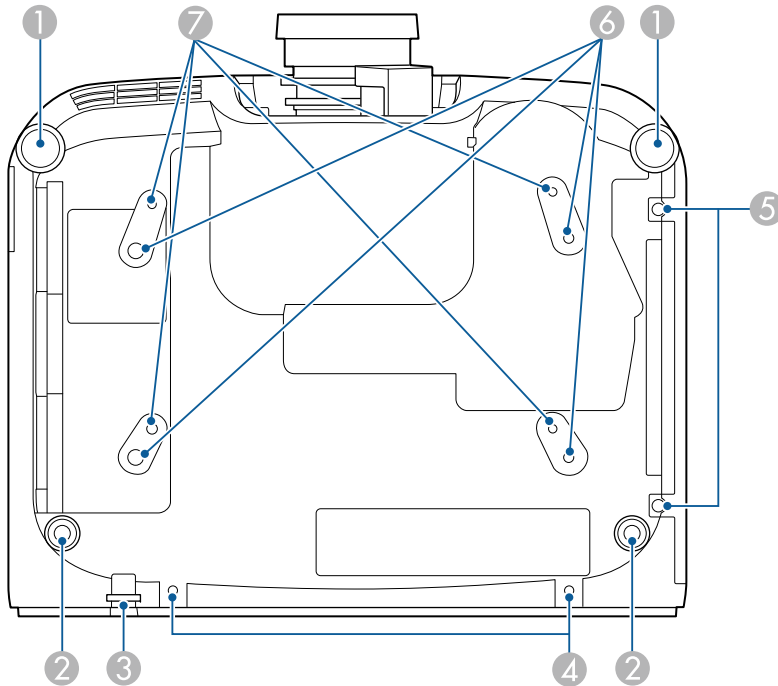

Name	Function
1 Front feet	When setup on a surface such as a desk, extend and retract the feet to adjust the height or tilt of the image. 🖱️ "Adjusting the Height of the Projected Image (for Normal Installment)" p.41 🖱️ "Adjusting the Horizontal Tilt (for Normal Installment)" p.42
2 Rear feet	
3 Security cable installation point	Pass a commercially available anti-theft wire lock or a wire to prevent the projector from falling through here and lock it in place. 🖱️ "Anti Theft/Fall Prevention" p.119

Name	Function
4 Screw holes to fix the cable cover	Screw holes to fix the cable cover in place. 🖱️ "Attaching the Cable Cover" p.55
5 Air filter cover fixing screw	Screws to fix the air filter cover in place.
6 Ceiling mount fixing points (ELPMB47/ELPMB48, 4 points)	Attach the optional ceiling mount here when suspending the projector from a ceiling. 🖱️ "Installing the Projector" p.27
7 Ceiling mount fixing points (ELPMB22, 4 points)	🖱️ "Optional Accessories and Consumables" p.233

Control Panel

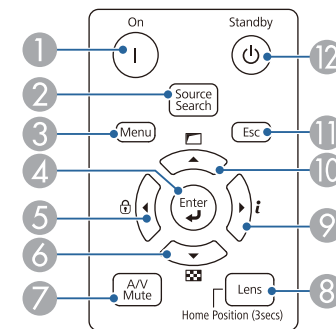

Name	Function
1 [⏻] button	Turns the projector on.
2 [Source Search] button	Changes to the next input source that is sending an image. 🖱️ "Automatically Detecting Input Signals and Changing the Projected Image (Source Search)" p.61
3 [Menu] button	Displays and closes the Configuration menu. 🖱️ "Configuration Menu Operations" p.136



	Name	Function
4	[↵] button	<ul style="list-style-type: none"> When the Configuration menu or the Help screen is displayed, it accepts and enters the current selection and moves to the next level. If pressed while projecting analog RGB signals from the Computer port or the BNC port, you can automatically optimize Tracking, Sync., and Position.
5	[⏪]/[🔒] buttons	<ul style="list-style-type: none"> Displays the Control Panel Lock screen allowing you to make settings to lock the control panel buttons. <ul style="list-style-type: none"> "Restricting Operation" p.117 If pressed when the Configuration menu or the Help screen is displayed, this button selects menu items and setting values. <ul style="list-style-type: none"> "Configuration Menu Operations" p.136 "Using the Help" p.173
6	[▼]/[🔍] buttons	<ul style="list-style-type: none"> Displays a test pattern. <ul style="list-style-type: none"> "Displaying the Test Pattern" p.33 If pressed when the Configuration menu or the Help screen is displayed, this button selects menu items and setting values. <ul style="list-style-type: none"> "Configuration Menu Operations" p.136 "Using the Help" p.173
7	[A/V Mute] button	Turns the video and audio on or off. <ul style="list-style-type: none"> "Hiding the Image and Sound Temporarily (A/V Mute)" p.102
8	[Lens] button	Displays the adjustment screens for lens shift, zoom, focus, and distortion in that order each time the button is pressed. If pressed for more than three seconds, the lens position moves to the home position.

	Name	Function
9	[▶]/[i] buttons	<ul style="list-style-type: none"> Displays the Info menu from the Configuration menu. <ul style="list-style-type: none"> "Info Menu (Display Only)" p.161 If pressed when the Configuration menu or the Help screen is displayed, this button selects menu items and setting values. <ul style="list-style-type: none"> "Configuration Menu Operations" p.136 "Using the Help" p.173
10	[▲]/[📐] buttons	<ul style="list-style-type: none"> Performs screen adjustments using the settings in Geometry Correction from the Configuration menu. <ul style="list-style-type: none"> Settings - Geometry Correction p.143 If pressed when the Configuration menu or the Help screen is displayed, this button selects menu items and setting values. <ul style="list-style-type: none"> "Configuration Menu Operations" p.136 "Using the Help" p.173
11	[Esc] button	<ul style="list-style-type: none"> Stops the current function. If pressed when the Configuration menu is displayed, it moves to the previous menu level. <ul style="list-style-type: none"> "Configuration Menu Operations" p.136
12	[⏻] button	Turns the projector off.

Remote Control

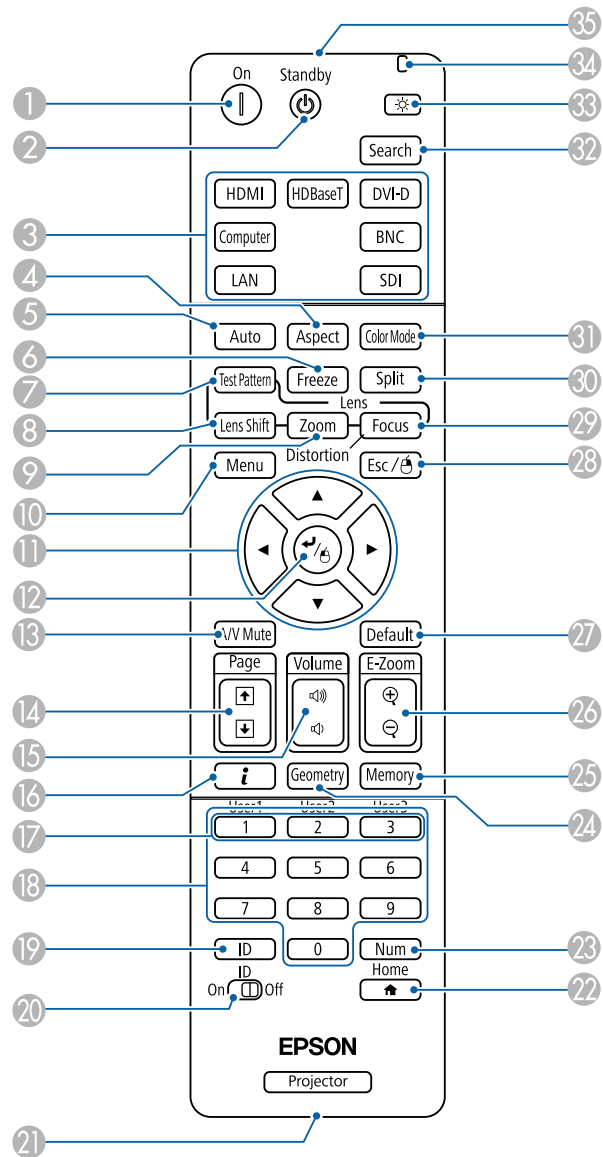

Name	Function
1 [On/Standby] button	Turns the projector on.
2 [Standby] button	Turns the projector off.
3 Change input buttons	Changes to images from each input port. ☛ "Switching to the Target Image by Remote Control" p.62 The [SDI] button is unavailable.
4 [Aspect] button	Each time the button is pressed, the aspect mode changes. ☛ "Changing the Aspect Ratio of the Projected Image" p.80
5 [Auto] button	If pressed while projecting analog RGB signals from the Computer port or the BNC port, you can automatically optimize Tracking, Sync., and Position.
6 [Freeze] button	Images are paused or unpaused. ☛ "Freezing the Image (Freeze)" p.103
7 [Test Pattern] button	Displays a test pattern. ☛ "Displaying the Test Pattern" p.33
8 [Lens Shift] button	Press to adjust the lens shift. ☛ "Adjusting the Position of the Projected Image (Lens Shift Adjustment)" p.34 If pressed for more than three seconds, the lens position moves to the home position.
9 [Zoom] button	Press to adjust the zoom. ☛ "Adjusting the Image Size" p.37
10 [Menu] button	Displays and closes the Configuration menu. ☛ "Configuration Menu Operations" p.136

Name	Function
⑪ [▲][▼][◀][▶] buttons	<ul style="list-style-type: none"> Press to adjust focus, zoom, distortion, and lens shift. <ul style="list-style-type: none"> "Adjusting the Position of the Projected Image (Lens Shift Adjustment)" p.34 "Adjusting the Image Size" p.37 "Correcting the Focus" p.38 When the Configuration menu or the Help screen is displayed, pressing these buttons selects menu items and setting values. <ul style="list-style-type: none"> "Configuration Menu Operations" p.136
⑫ [↵] button	<p>When the Configuration menu or the Help screen is displayed, it accepts and enters the current selection and moves to the next level.</p> <ul style="list-style-type: none"> "Configuration Menu Operations" p.136
⑬ [A/V Mute] button	<p>Turns the video and audio on or off.</p> <ul style="list-style-type: none"> "Hiding the Image and Sound Temporarily (A/V Mute)" p.102
⑭ [Page] buttons [⏪][⏩]	<ul style="list-style-type: none"> Press to change the test pattern while a test pattern is displayed. Moves to the previous or next image file when projecting images from a computer connected via a network.
⑮ [Volume] buttons [◀][▶]	<p>[◀] decreases the volume. [▶] increases the volume.</p> <ul style="list-style-type: none"> "Adjusting the Volume" p.63
⑯ [i] button	<p>Displays the Info menu from the Configuration menu.</p> <ul style="list-style-type: none"> "Info Menu (Display Only)" p.161
⑰ [User1] button [User2] button [User3] button	<p>Select any frequently used item from the Configuration menu items, and assign it to any of these buttons. By pressing the button, the assigned menu item selection/adjustment screen is displayed, allowing you to make one-touch settings/adjustments.</p> <ul style="list-style-type: none"> "Settings Menu" p.143

Name	Function
⑱ Numeric buttons	<ul style="list-style-type: none"> Enter the Password. <ul style="list-style-type: none"> "Setting Password Protection" p.115 Use this button to enter numbers in Network settings from the Configuration menu.
⑲ [ID] button	<p>Hold down this button and press the numeric buttons to select the ID for the projector you want to operate using the remote control.</p> <ul style="list-style-type: none"> "ID Settings" p.42
⑳ [ID] switch	<p>Use this switch to enable (On)/disable (Off) ID settings for the remote control.</p> <ul style="list-style-type: none"> "ID Settings" p.42
㉑ Remote port	<p>Connects the optional remote control cable set and outputs signals from the remote control.</p> <ul style="list-style-type: none"> "Optional Accessories" p.233 <p>When the remote control cable is plugged into this remote port, the remote control light-emitting is disabled.</p>
㉒ [Home] button	<p>Displays and closes the Home screen.</p> <ul style="list-style-type: none"> "Home Screen" p.59
㉓ [Num] button	<p>Hold down this button and press the numeric buttons to enter passwords and numbers.</p> <ul style="list-style-type: none"> "Setting Password Protection" p.115
㉔ [Geometry] button	<p>Corrects distortion in the projected image.</p> <ul style="list-style-type: none"> "Correcting Distortion in the Projected Image" p.64
㉕ [Memory] button	<p>Performs operations and makes settings for the memory function.</p> <ul style="list-style-type: none"> "Memory Function" p.110
㉖ [E-Zoom] buttons [⊕][⊖]	<p>Enlarges or reduces the image without changing the projection size.</p> <ul style="list-style-type: none"> "Enlarging Part of the Image (E-Zoom)" p.104

Name	Function
27 [Default] button	Enabled when [Default]: Reset is displayed on the configuration menu guide. The settings being adjusted are returned to their default values. ☛ "Configuration Menu Operations" p.136
28 [Esc] button	<ul style="list-style-type: none"> Stops the current function. If pressed when the Configuration menu is displayed, it moves to the previous level. ☛ "Configuration Menu Operations" p.136
29 [Focus] button	Each time the button is pressed, the adjustment screens for focus and distortion are displayed in that order. ☛ "Correcting the Focus" p.38
30 [Split] button	Each time the button is pressed, the image changes between projecting two images simultaneously by splitting the projected screen, or projecting one image as normal. ☛ "Projecting Two Images Simultaneously (Split Screen)" p.99
31 [Color Mode] button	Each time the button is pressed, the Color Mode changes. ☛ "Selecting the Projection Quality (Selecting Color Mode)" p.76
32 [Search] button	Changes to the next input source that is sending an image. ☛ "Automatically Detecting Input Signals and Changing the Projected Image (Source Search)" p.61
33 [☀️] button	Illuminates the buttons on the remote control for approximately 15 seconds. This is useful when using the remote control in the dark.
34 Indicator	A light is emitted when outputting remote control signals.
35 Remote control light-emitting area	Outputs remote control signals.

Handy remote control operations

You can perform the following operations by simply pressing one of the buttons on the remote control.

Operation	Set
Reverse the projected image vertically. (Switch the Projection between Front and Front/Ceiling) ☛ "Changing the direction of the image (projection mode)" p.31	Hold down the [A/V Mute] button for more than five seconds.
Selecting the password security settings. ☛ "Managing Users (Password Protection)" p.115	Hold down the [Freeze] button for more than five seconds. The Password Protection screen is displayed, and you can select various settings.
Locking or unlocking some of the operation of the buttons on the remote control. ☛ "Remote control button lock" p.118	Hold down the [🏠] button for more than five seconds.
Initializing the settings for the Remote Receiver in the Configuration menu. (Enables all Remote receivers for this projector.)	Hold down the [Menu] button for more than 15 seconds.

Operation	Set
Displaying frequently used Configuration menu items.	<p>Press the [User1], [User2], or [User3] button. You can set the menu item you want to assign to each button in User Button.</p> <p> Settings - User Button p.143</p> <p>The following items can be assigned. Light Source Mode, Multi-Projection, Resolution, On-Screen Display, Display the QR Code, Image Enhancement, Frame Interpolation, Link Menu, Content Playback, USB</p> <p>When you press the button for which On-Screen Display is assigned, menus or messages are not displayed on the screen. When the same button is pressed, they are displayed again. If On-Screen Display is enabled, you cannot operate the Configuration menu (except to switch the color mode and input source).</p>

Replacing the remote control batteries

If delays in the responsiveness of the remote control occur or if it does not operate after it has been used for some time, it probably means that the batteries are becoming flat. When this happens, replace them with new batteries. Have two AA size alkaline or manganese batteries ready. You cannot use other batteries except for the AA size alkaline or manganese.

Attention

Make sure you read the following manual before handling the batteries.

[Safety Instructions](#)

- 1 Remove the battery cover.
While pushing the battery compartment cover catch, lift the cover up.

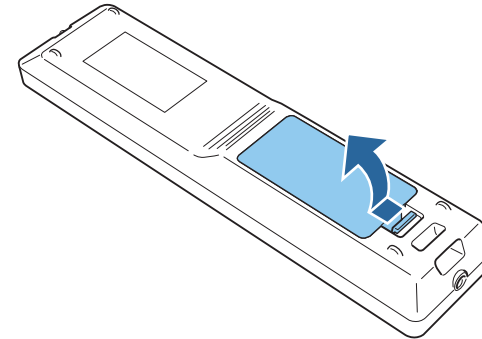

- 2 Replace the old batteries with new batteries.

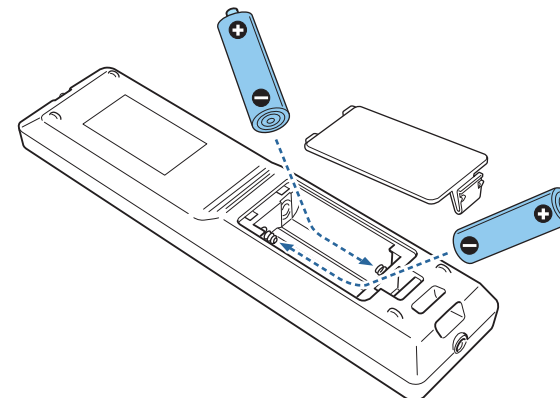

Caution

Check the positions of the (+) and (-) marks inside the battery holder to ensure the batteries are inserted the correct way.

If the batteries are not used correctly, they could explode or leak causing a fire, injury, or damage to the product.

- 3 Replace the battery cover.
Press the battery compartment cover until it clicks into place.

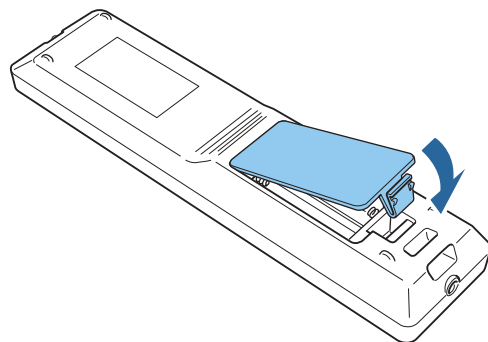

Remote control operating range

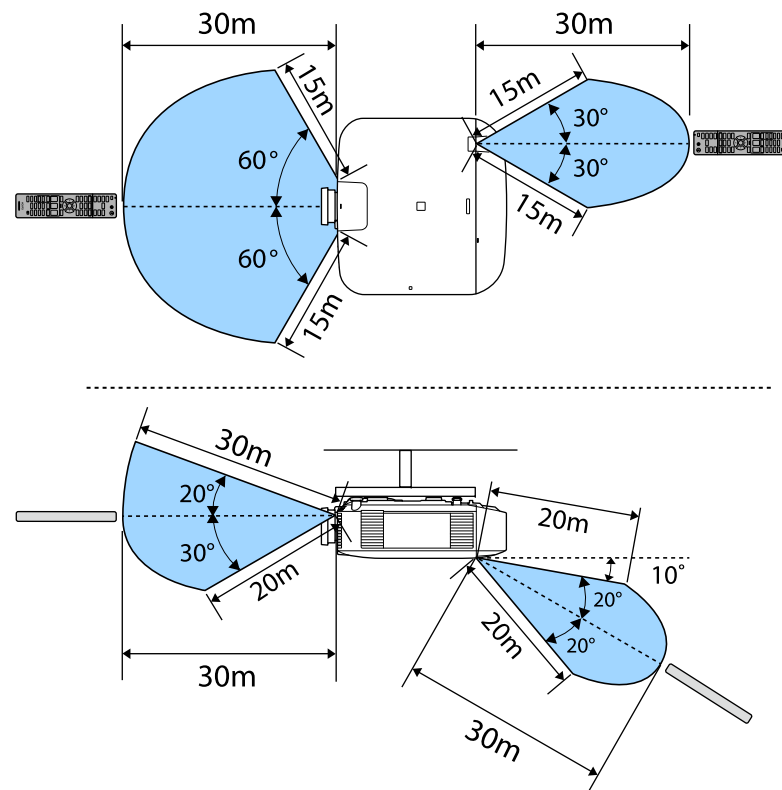

To restrict reception of the operation signals from the remote control, set **Remote Receiver**.

☛ **Settings - Remote Receiver p.143**

Connecting a cable to the remote control

You can make operations securely with the optional remote control cable set when you use multiple units of this projector in the same place or when there are obstacles around the remote receiver.

☛ "Optional Accessories" p.233

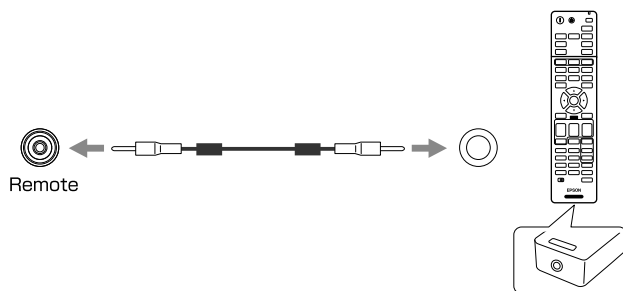
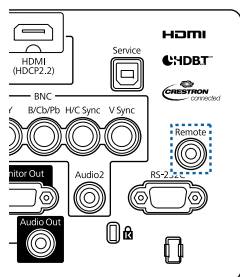

- When the remote control cable is plugged into the Remote port, the remote receiver on the projector is disabled.
- You can also connect the optional HDBaseT transmitter and remote control with the cable to control the projector.
 - ☛ "Connecting an HDBaseT Transmitter" p.53



Preparing the Projector

This chapter explains how to install the projector and connect projection sources.

Removing and Attaching the Projector Lens Unit

Warning

Make sure you disconnect the power cord from the projector before removing or attaching the lens unit to the projector. Otherwise, it could cause an electric shock.

Attaching

Attention



- Do not attach the lens unit when the projector's lens insertion section is facing up. Dust or dirt could enter the projector.
- Try not to touch the lens section with your hand or fingers. If fingerprints or oils are left on the surface of the lens, projection quality deteriorates.



- The projector supports lens with the following model numbers.
ELPLX01, ELPLX01W, ELPLU03, ELPLU04, ELPLW05, ELPLW06, ELPLW08, ELPLM08, ELPLM09, ELPLM10, ELPLM11, ELPLM15, ELPLL08, ELPLS04, ELPLU02, ELPLR04, ELPLW04, ELPLM06, ELPLM07, ELPLL07

When using the following lens, set the **Lens Type** in the Configuration menu according to the lens you are using so that distortion correction is performed correctly.

ELPLS04, ELPLU02, ELPLR04, ELPLW04, ELPLM06, ELPLM07, ELPLL07

-  **Extended - Operation - Advanced - Lens Type** [p.146](#)
- In a normal installation, the image may be tilted depending on your lens. Adjust the tilt of the image using the front and rear feet.
 -  "Adjusting the Horizontal Tilt (for Normal Installment)" [p.42](#)
- For information on installing ELPLX01/ELPLX01W, see the User's Guide supplied with ELPLX01/ELPLX01W.

- 1** Pull the lens replacement cover straight out.

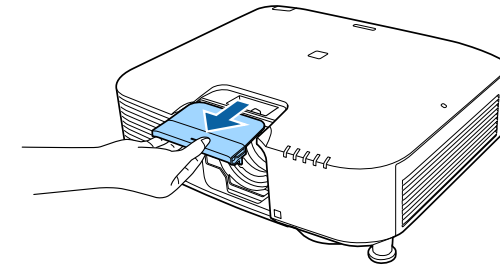

- 2** Release the lock lever if it is locked.

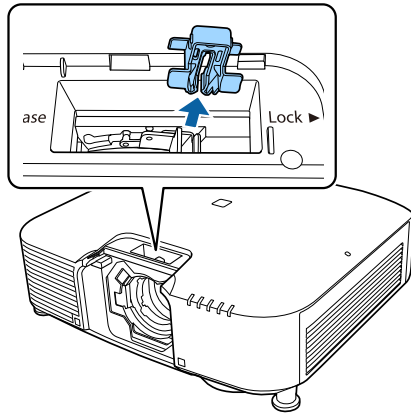

- 3** Pinch the lever, and then move it counter-clockwise.

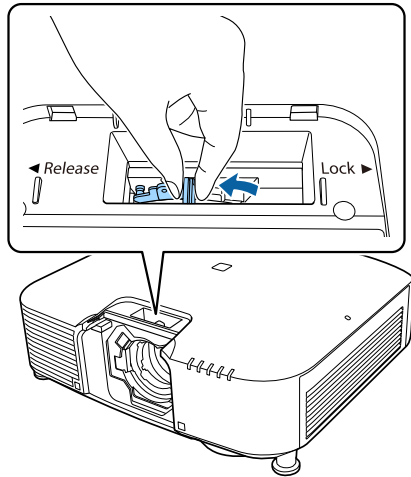

When using the following lens, attach the supplied lens connector cap to protect the port.

ELPLS04, ELPLU02, ELPLR04, ELPLW04, ELPLM06, ELPLM07, ELPLL07

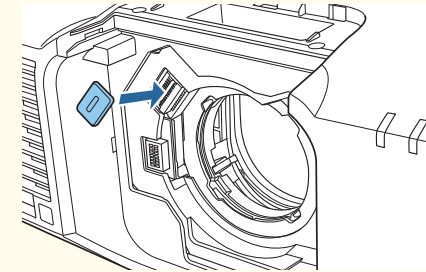

- 4** Insert the lens unit straight into the lens insertion section with the white circle on the lens on top.

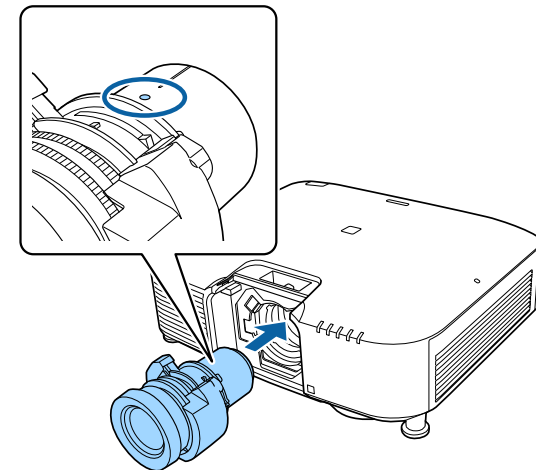

- 5** While holding the lens unit firmly, pinch the lever and turn it clockwise to lock the lens unit.

Check that the lens cannot be detached.

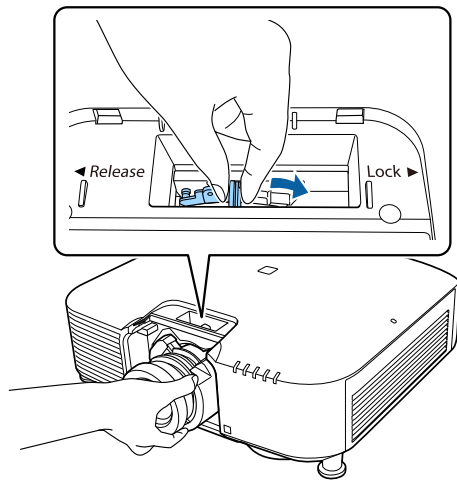

- 6** Secure the lever with the lever lock to make sure it does not come loose.

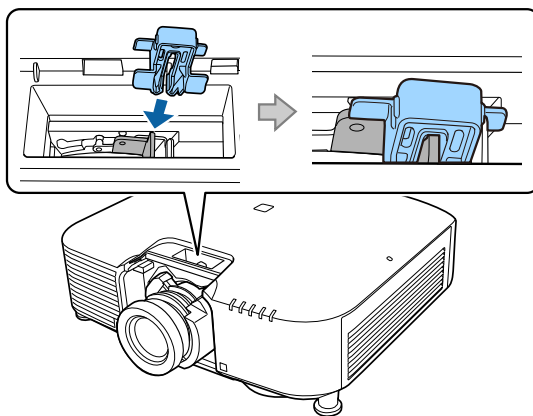

The lever is secured even without using the lever lock, but this adds an additional measure of safety.

- 7** Attach the lens replacement cover.

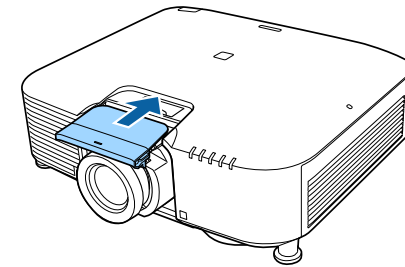

When projecting down, we recommend securing the front cover with commercially available screws (M3 x 8 mm).

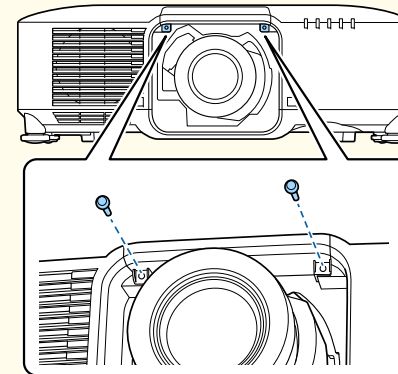

Lens Calibration

After replacing the lens unit, calibrate the lens so that the projector can correctly acquire the lens position and adjustment range.

After attaching a different lens unit from the previous one, a message is displayed when the projector is turned on.

Select **Yes** to calibrate the lens.

Lens calibration takes up to about 100 seconds until it is complete. When it is complete, the lens position returns to the position before calibration (ELPLX01/ELPLX01W returns to the standard position).

Attention

If the message "Lens Calibration failed." is displayed, remove the lens unit and then reinstall it. If the message continues to be displayed, stop using the projector, remove the power plug from the electrical outlet, and contact your local dealer or the nearest address provided in the Epson Projector Contact List.

 [Epson Projector Contact List](#)



- You can perform lens calibration using one of the following methods.
 - Press the [Default] button on the remote control for three seconds or more.
 - Configuration Menu
 -  **Extended - Operation - Lens Calibration** p.146
- If no message is displayed after attaching the lens unit, perform lens calibration from the Configuration menu.
- If you do not calibrate the lens, the following functions may not operate correctly.
Focus, Distortion, Zoom, Lens Shift, Memory (Lens Position)

Removing



Caution

Wait for a while after turning off the projector before removing the lens unit (Approx. 30 mins.). Touching the lens unit immediately after projecting or turning off may cause burns.

Attention

If the lens shift has been done, move the lens position to the home position before replacing the lens unit.

 "Adjusting the Position of the Projected Image (Lens Shift Adjustment)" p.34



The projector uses a laser as the light source. As a safety measure, the light source turns off when the lens is removed. Attach the lens, and then press the [ⓘ] button to turn it back on.

- 1** Pull the lens replacement cover straight out.

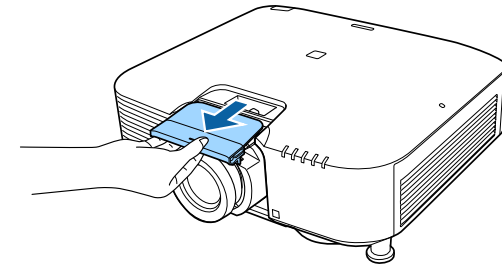

- 2** If the lock lever has been secured with a stopper, remove the stopper.

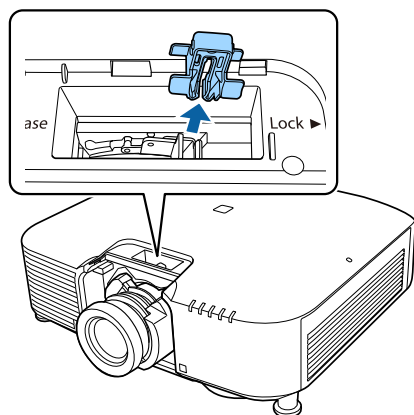

- 3 While holding the lens unit firmly, hold the lock lever and turn it counterclockwise to unlock the lens unit.

Pull the lens unit straight out as it is released.

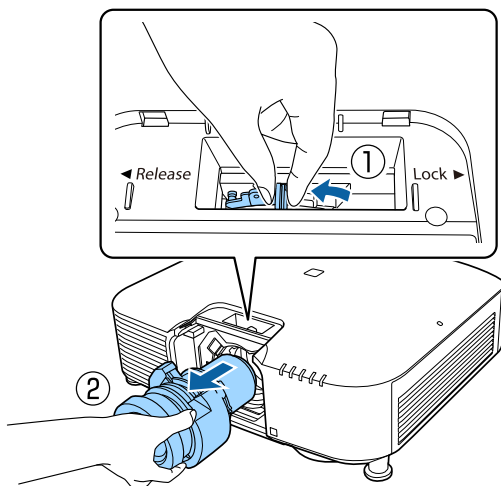

Installation Settings

Changing the direction of the image (projection mode)

You can change the direction of the image using **Projection** mode from the Configuration menu.

☛ **Extended - Projection** [p.146](#)

When Front is the standard, the image directions for each projection mode are as follows.

Front (default)



Rear



Front/Ceiling



Rear/Ceiling





- You can change the setting as follows by pressing down the [A/V Mute] button on the remote control for about five seconds.
Front ↔ Front/Ceiling
Rear ↔ Rear/Ceiling
- To rotate the menu display, set **OSD Rotation** in the Configuration menu.
☛ **Extended - Display - OSD Rotation** p.146

Screen Settings

Set the Screen Type according to the aspect ratio of the screen being used. The area where the image is displayed matches the shape of the screen.



- The settings for the **Screen Type** at the time of purchase are as follows:
- WUXGA/WXGA projector: **16:10**
 - XGA projector: **4:3**

- Press the [Menu] button while projecting.
☛ "Configuration Menu Operations" p.136
- Select **Display** from **Extended**.
- Select **Screen Type** from **Screen**.
- Select the screen's aspect ratio.
The shape of the background test pattern changes depending on the setting.

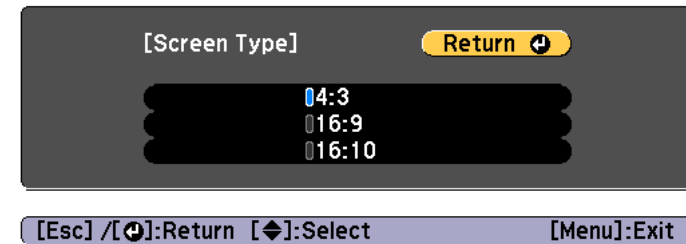

- Press the [Menu] button to finish making settings.



- When you change the Screen Type, adjust the aspect ratio for the projected image as well.
☛ "Changing the Aspect Ratio of the Projected Image" p.80
- The Message Broadcasting function for Epson Projector Management does not support this function.

Adjusting the position of the image on the projected screen

You can adjust the position of the image if there are margins between the edge of the image and the projected screen frame due to the Screen Type setting.

Example: When the **Screen Type** is set to **4:3** for the WUXGA/WXGA projector



You can move the image to the left and right.

- 1** Press the [Menu] button while projecting.
 ☛ "Configuration Menu Operations" [p.136](#)
- 2** Select **Display** from **Extended**.
- 3** Select **Screen Position** from **Screen**.
- 4** Use the [▲], [▼], [◀], and [▶] buttons to adjust the position of the image.

You can check the current display position by using the background test pattern.

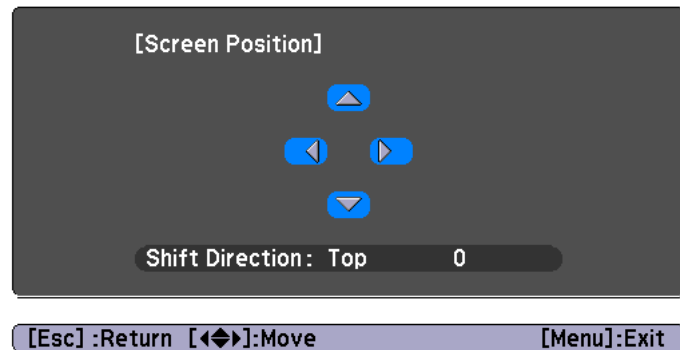

- 5** Press the [Menu] button to finish making settings.



The **Screen Position** cannot be adjusted in the following situations.

- If you are using a WUXGA/WXGA projector and the **Screen Type** is set to **16:10**
- If you are using an XGA projector and the **Screen Type** is set to **4:3**

Displaying the Test Pattern

A test pattern can be displayed to adjust the projection status without connecting video equipment.

The shape of a test pattern is according to the setting of **Screen Type**. Set **Screen Type** first.

☛ "Screen Settings" [p.32](#)

- 1** Press the [Test Pattern] button of the remote control or the [⊞] button on the control panel while projecting.
- 2** Press the [◀][▶] buttons on the remote control or the [↶] button on the control panel to change the test pattern.

Using the remote control

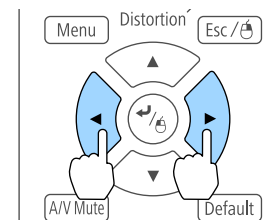

Using the control panel

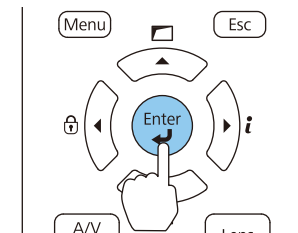

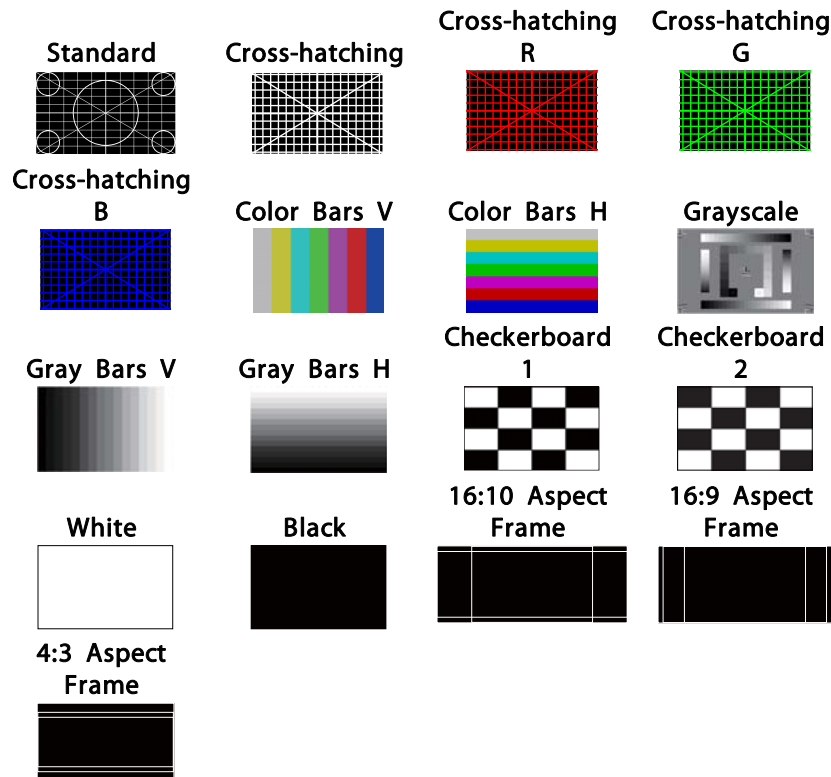

- To set menu items that cannot be set while the test pattern is being displayed or to fine-tune the projected image, project an image from the connected device.
- During image adjustment, press the [Page] buttons [↑] [↓] on the remote control to change the test pattern.
- You can also select a test pattern from the Configuration menu.
 - ☛ **Settings - Test Pattern p.143**

3 Press the [Esc] button to close the test pattern.

Adjusting the Position of the Projected Image (Lens Shift Adjustment)

The lens can be shifted to adjust the position of the projected image, for example, when the projector cannot be installed directly in front of the screen.

The ranges within which the image can be moved are shown below. The position of the projected image cannot be moved to both the horizontal and vertical maximum values.

EB-L1075U/EB-L1070U/EB-L1065U/EB-L1060U/EB-L1050U/EB-L1070W/
EB-L1060W

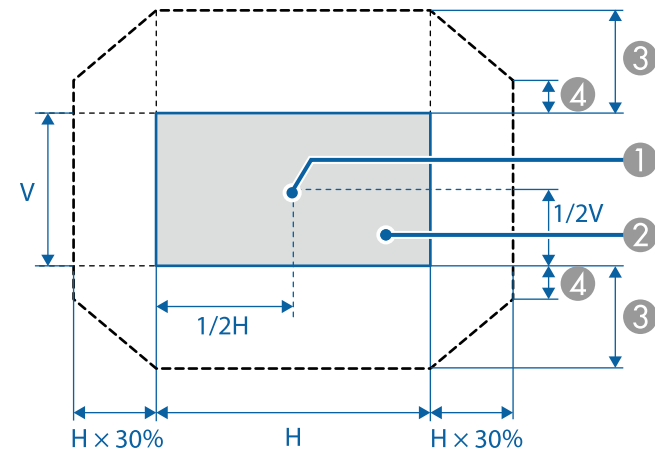

- ① Center of lens
- ② Projected image when the lens position is moved to the home position
- ③ Maximum motion range: V x 67%
- ④ When the horizontal direction is at the maximum value: V x 19%

EB-L1070

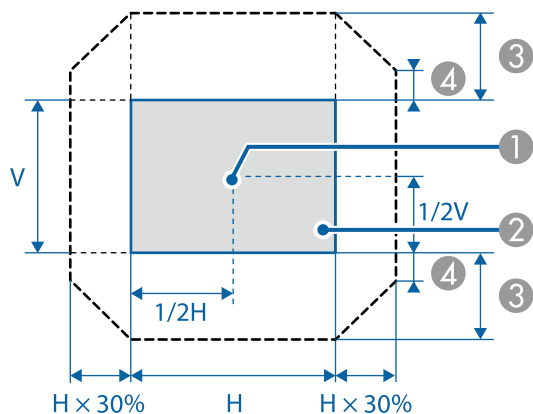

- ① Center of lens
- ② Projected image when the lens position is moved to the home position
- ③ Maximum motion range: $V \times 57\%$
- ④ When the horizontal direction is at the maximum value: $V \times 16\%$

When using ultra-short focus lens ELPLX01/ELPLX01W

EB-L1075U/EB-L1070U/EB-L1065U/EB-L1060U/EB-L1050U/EB-L1070W/
EB-L1060W

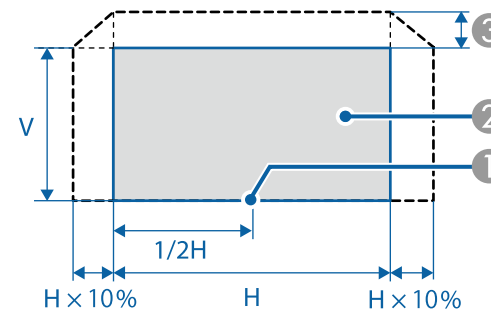

- ① Center of lens
 - ② Projected image for positional reference
 - ③ Maximum motion range: $V \times 17\%$
- * When the horizontal direction is at the maximum value, the image cannot be moved up.

EB-L1070

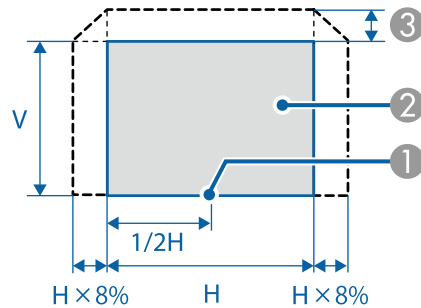

- ① Center of lens
- ② Projected image for positional reference
- ③ Maximum motion range: $V \times 7\%$

* When the horizontal direction is at the maximum value, the image cannot be moved up.



- When adjusting the image height with the vertical lens shift, adjust by moving the image from the bottom to the top. If it is adjusted from the top to the bottom, the image position may move down slightly after adjusting.
- We recommend setting the focus, zoom, and lens shift at least 20 minutes after you start the projection. After projecting videos, we recommend waiting for more than 20 minutes to make settings for the Focus/Zoom/Lens Shift.
- The image will be clearest when the lens position is moved to the home position.
- If you hold down the [Lens Shift] button on the remote control or the [Lens] button on the control panel for at least three seconds, the lens position moves to the home position.
- If you set **A/V Output** to **Always On**, you can move the lens position to the home position even if the projector is in standby mode.
 - ☛ **Extended - A/V Settings - A/V Output** p.146
- ELPLR04 does not support lens shift.

- 1** Press the [Lens Shift] button on the remote control or the [Lens] button on the control panel.

Repeatedly press the [Lens] button on the control panel until the lens shift adjustment screen is displayed.

Using the remote control

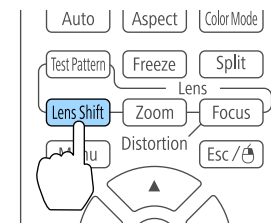

Using the control panel

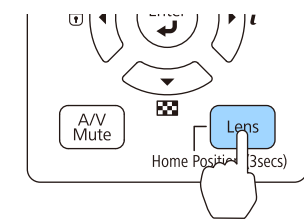

- 2** Press the [▲][▼][◀][▶] buttons to adjust the position of the projected image.

Using the remote control

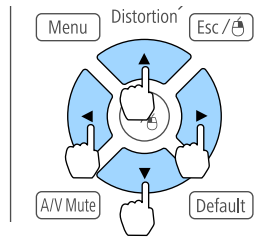

Using the control panel

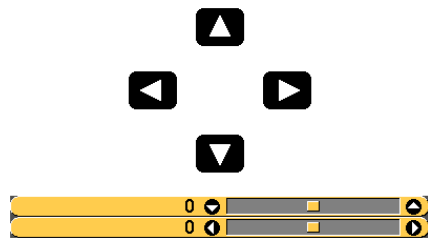
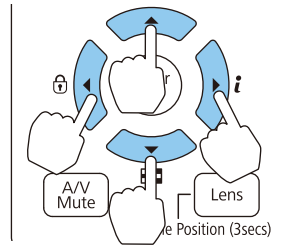

The displayed screen may differ depending on your lens.

- 3** Press the [Esc] button to finish the adjustment.

Adjusting the Image Size



This is not available for ELPLX01, ELPLX01W, and ELPLR04.

- 1** Press the [Zoom] button on the remote control or the [Lens] button on the control panel.
Repeatedly press the [Lens] button on the control panel until the zoom adjustment screen is displayed.

Using the remote control

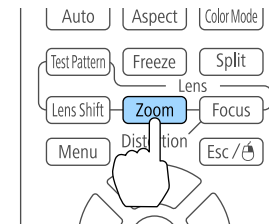

Using the control panel

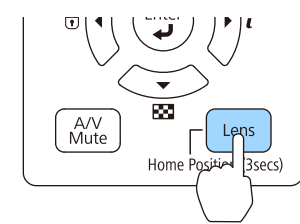

- 2** Press the [◀][▶] buttons to adjust.

Using the remote control

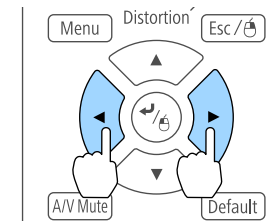

Using the control panel

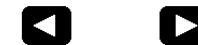
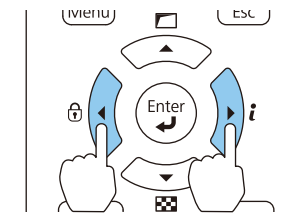

The displayed screen may differ depending on your lens.

- 3** Press the [Esc] button to finish the adjustment.

Correcting the Focus

- 1 Press the [Focus] button on the remote control or the [Lens] button on the control panel.
Repeatedly press the [Lens] button on the control panel until the focus adjustment screen is displayed.

Using the remote control

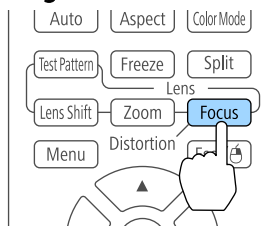

Using the control panel

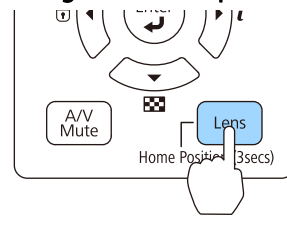

- 2 Press the [◀][▶] buttons to adjust.

Using the remote control

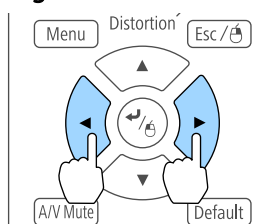

Using the control panel

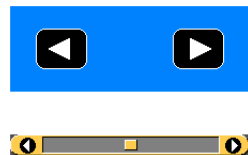
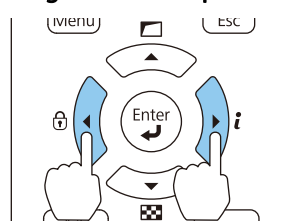

The displayed screen may differ depending on your lens.



When using the following lens, a message prompting you to adjust the distortion (image warping) is displayed. After adjusting the focus, adjust the distortion.

ELPLX01, ELPLX01W, ELPLU03, ELPLU04, ELPLW05, ELPLW08, ELPLU02

☛ "Correcting Distortion (Image Warping)" p.38

- 3 Press the [Esc] button to finish the adjustment.

Correcting Distortion (Image Warping)

When using a short throw zoom lens and focusing at the center of the screen, the surrounding image may warp and be out of focus. Follow the steps below to correct the warping.

- 1 Press the [Focus] button on the remote control or the [Lens] button on the control panel.
Repeatedly press the [Lens] button on the control panel until the focus adjustment screen is displayed.
- 2 Press the [◀][▶] buttons to focus the image around the center of the lens.

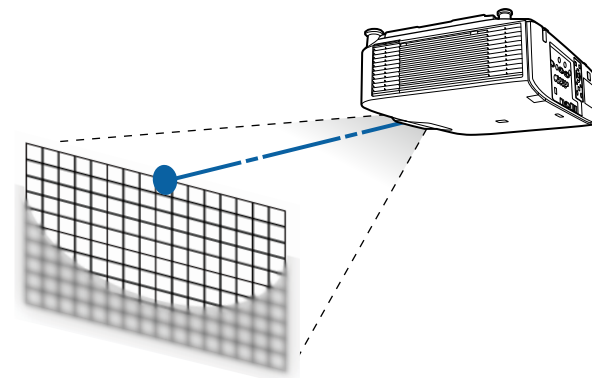

- 3** Press the [Focus] button on the remote control or the [Lens] button on the control panel again.
Repeatedly press the [Lens] button on the control panel until the distortion adjustment screen is displayed.
- 4** Press the [◀][▶] button to adjust the focus of the surrounding area.

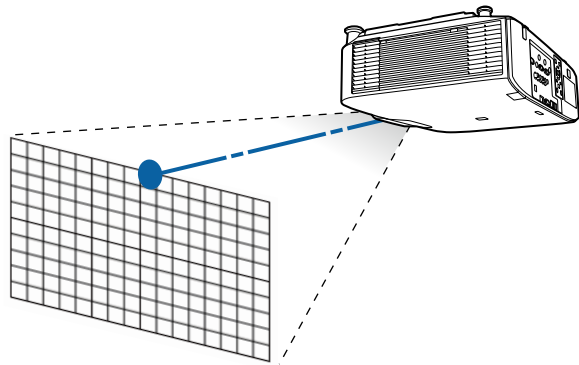

When using the ELPLU02, a message prompting you to manually adjust the distortion is displayed. Turn the distortion ring counterclockwise, and then adjust the focus. After adjusting the focus, manually turn the distortion ring to correct the image warping.

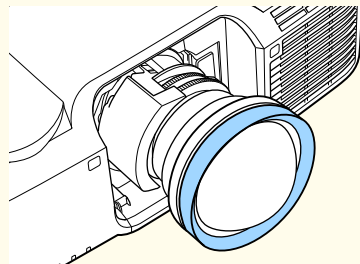

Registering and Loading Lens Adjustment Values

You can register a lens position whose lens shift, zoom, focus, and distortion was adjusted in memory, and load it when necessary. You can register up to 10 values.



- This feature cannot be used if the following lenses are attached. ELPLS04, ELPLU02, ELPLR04, ELPLW04, ELPLM06, ELPLM07, ELPLL07
- If you did not calibrate your lens, a message is displayed when you save a memory. Select **Yes** to calibrate the lens.
- The lens position when a memory is loaded may not completely match the lens position when the memory was saved.
- If there is a large discrepancy between the lens position when a memory is loaded and the lens position when the memory was saved, calibrate the lens.

 **Extended - Operation - Lens Calibration** [p.146](#)

- 1** Press the [Memory] button while projecting.

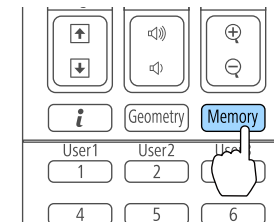

You can also operate from the Configuration menu.

 **Settings - Memory** [p.143](#)

- 2** Select **Lens Position**, and then press the [↵] button.

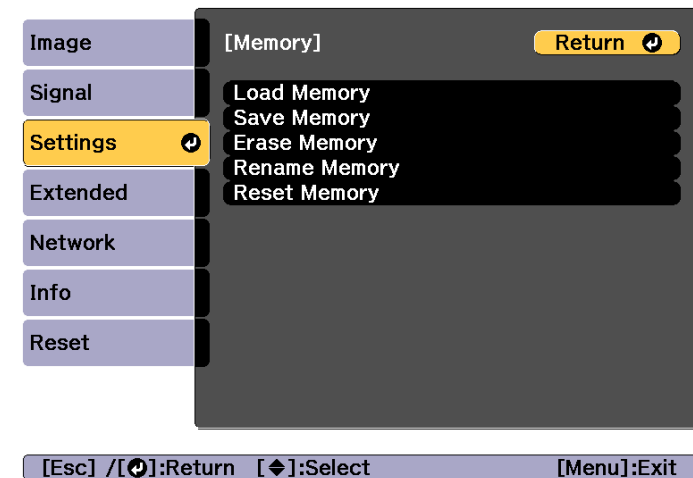
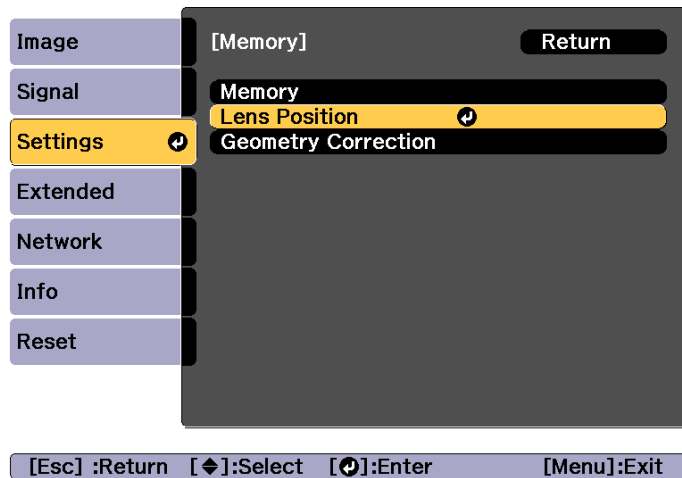

3 Select the function you want to perform, then press the [↵] button.

Function	Explanation
Load Memory	Loads the saved memory. When you select a memory name and press the [↵] button, the lens is automatically adjusted according to the settings of the selected memory.
Save Memory	Registers current settings in the memory. When you select a memory name and press the [↵] button, the settings are saved.
Erase Memory	Erases the registered memory. When you select a memory name and press the [↵] button, a message is displayed. Select Yes , and then press the [↵] button to erase the selected memory.
Rename Memory	Changes the memory name. Select the memory name you want to change, and then press the [↵] button. Enter the memory name using the soft keyboard.  "Soft keyboard operations" p.152 When you have finished, move the cursor over Finish , and then press the [↵] button.

Function	Explanation
Reset Memory	Resets the name and settings of a saved memory.



If the mark on the left of the memory name is turned blue, it means the memory has already been registered. When you select a registered memory, a message is displayed asking you to confirm that you want to overwrite the memory. If you select **Yes**, the previous settings are deleted and the current settings are registered.

Adjusting the Height of the Projected Image (for Normal Installation)

Extend or retract the front feet to make adjustments. You can adjust the position of the image by tilting the projector up to 10 degrees.

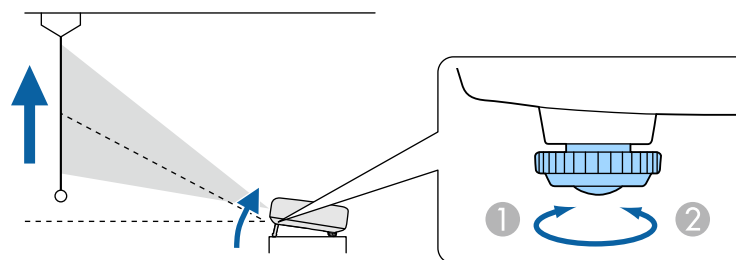

- ① Extend the front feet.
- ② Retract the front feet.



The larger the angle of tilt, the harder it becomes to focus. Install the projector so that it only needs to be tilted at a small angle.

Adjusting the Horizontal Tilt (for Normal Installation)

Extend and retract the front and rear feet to adjust the projector's horizontal tilt. You can adjust the tilt within a range of $\pm 1.5^\circ$.

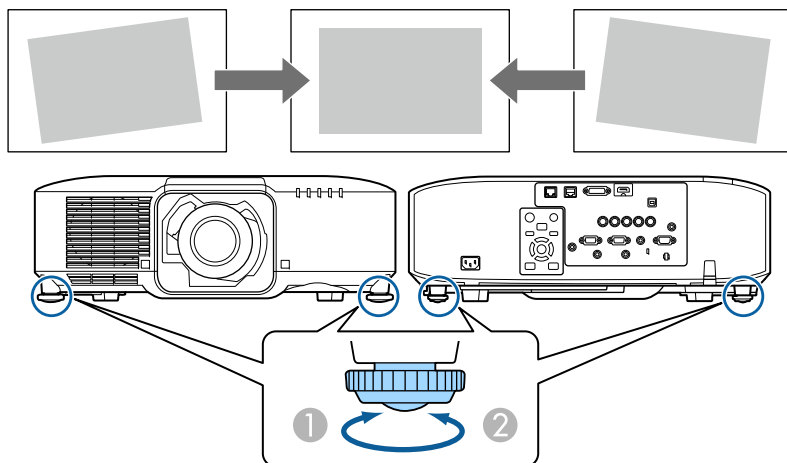

- ① Extend the front and rear feet.
- ② Retract the front and rear feet.

Attention

The rear feet are detachable. You can extend the feet by approximately 12 mm before they detach.

ID Settings

When an ID is set for the projector and the remote control, you can use the remote control to operate only the projector with a matching ID. This is very useful when managing multiple projectors. You can set up to 30 IDs.



- Operation using the remote control is possible only for projectors that are within the operating range of the remote control.
 - ☛ "Remote control operating range" [p.24](#)
- IDs are ignored when the projector ID is set to **Off** or the remote control ID is set to **0**.
- If you use Epson Web Control, you can operate a specific projector from a mobile device.
 - ☛ "Changing Settings Using a Web Browser (Epson Web Control)" [p.215](#)

Set the projector ID

- 1** Press the [Menu] button while projecting.
 - ☛ "Configuration Menu Operations" [p.136](#)
- 2** Select **Multi-Projection** from **Extended**.
- 3** Select **Projector ID**, and then press the [**↵**] button.
- 4** Press the [**◀**][**▶**] buttons to select an ID number.

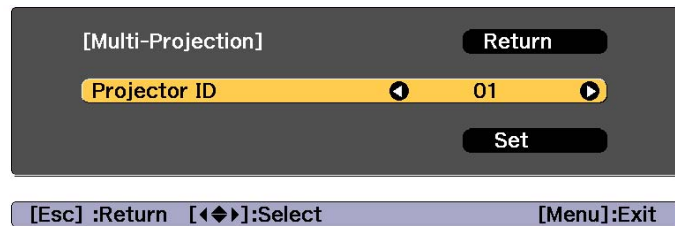

- 5** Select **Set**, and then press the [↵] button.
- 6** Press the [Menu] button to close the Configuration menu.

Checking the projector ID

During projection, press the [⏠] button while holding down the [ID] button.

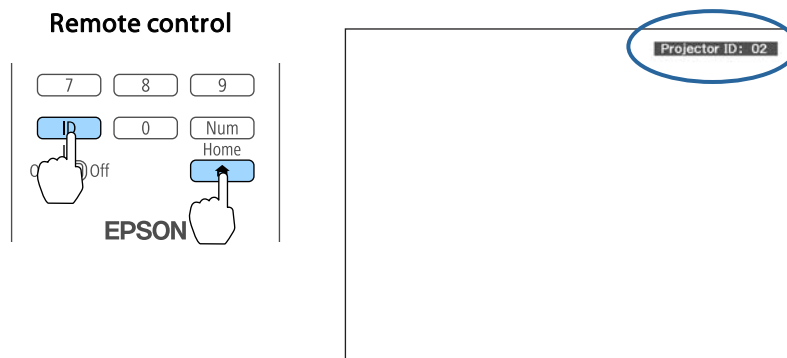

When you press the buttons, the current Projector ID is displayed on the projection screen. It disappears in about three seconds.

Setting the remote control ID

- 1** Set the remote control [ID] switch to On.

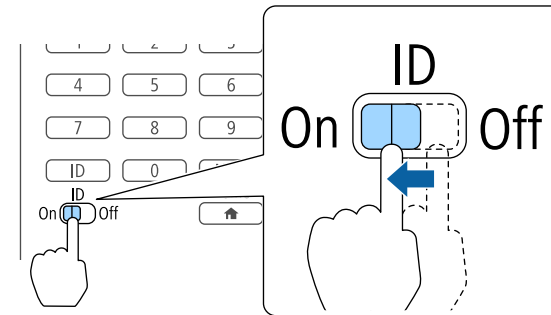

- 2** While holding the [ID] button, press a number button to select a number to match the ID of the projector you want to operate.

☞ "Checking the projector ID" p.43

Enter a two digit number (Example: 01 when the ID is 1).

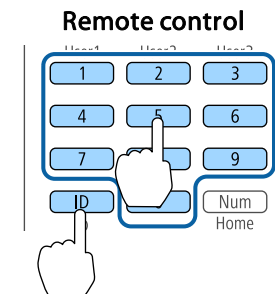

Once this setting has been made, the projector that can be operated by the remote control is limited.



The remote control ID setting is saved in the remote control. Even if the remote control batteries are removed to replace them and so on, the stored ID setting is retained. However, if the batteries are left out for a long time, it is reset to the default value (ID0).

Setting the Time

You can set the time for the projector. The set time is used for the schedule function.

☛ "Scheduling Function" [p.112](#)



- When you turn on the projector for the first time, the message "Do you want to set the time?" is displayed. When you select **Yes**, the screen from step 4 is displayed.
- When **Schedule Protection** is set to **On** in **Password Protection**, settings related to the date and time cannot be changed. You can make changes after setting **Schedule Protection** to **Off**.
☛ "Managing Users (Password Protection)" [p.115](#)

- 1** Press the [Menu] button while projecting.
☛ "Configuration Menu Operations" [p.136](#)
- 2** Select **Operation** from **Extended**.
- 3** Select **Date & Time**, and then press the [**↵**] button.
- 4** Make settings for the date and time.
Use the soft keyboard to enter the date and time.
☛ "Soft keyboard operations" [p.152](#)

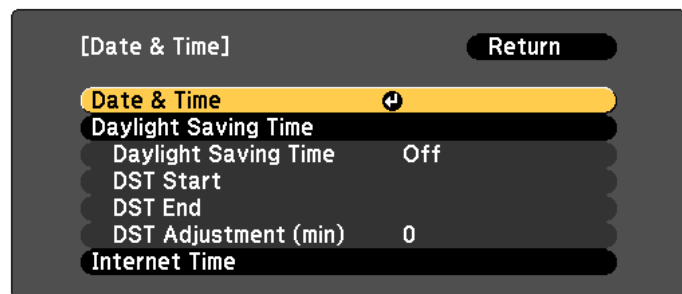

Date & Time

Submenu	Function
Date	Set today's date.
Time	Set the current time.
Time Difference (UTC)	Set the time difference from Coordinated Universal Time.
Set	The settings made in Date & Time are applied.

Daylight Saving Time

Submenu	Function
Daylight Saving Time	Set whether or not (On/Off) to activate the daylight saving time. DST Adjustment (min) adjusts the time difference between the standard time and daylight saving time.
DST Start	Set the date and time to start the daylight saving time.
DST End	Set the date and time to end the daylight saving time.
Set	The settings made in Daylight Saving Time are applied.

Internet Time

Submenu	Function
Internet Time	Set to On to update the time automatically through an Internet time server.
Internet Time Server	Input the IP address for an Internet time server.
Set	The settings made in Internet Time are applied.









When changing settings, make sure you select **Settings**, and then press the [**↵**] button.

- 5** Press the [Menu] button to finish making settings.

Other Settings

Settings related to basic operations

Purpose	Setting Methods
To start/stop projection by turning on/off the main power or plugging in or unplugging the power plug of the projector.	Set Direct Power On to On . (Default value: Off)  Extended - Operation - Direct Power On p.146 The projector can be powered off directly by the breaker because it supports the direct shutdown function.
To disable the automatic shutdown function.	Set Sleep Mode to Off . (Default value: On)  Extended - Operation - Sleep Mode p.146 Set A/V Mute Timer to Off .  Extended - Operation - A/V Mute Settings - A/V Mute Timer p.146
To disable buzzer beeps generated when the projector is powered on/off.	Set Beep to Off . (Default value: On)  Extended - Operation - Advanced - Beep p.146
To operate the projector by communication command even when the power of the projector is off.	Set Standby Mode to Communication On . (Default value: Communication Off)  Extended - Standby Mode p.146
To operate the projector by communication command while executing A/V Mute.	Set A/V Mute Release to A/V Mute .  Extended - Operation - A/V Mute Settings - A/V Mute Release p.146 The default value is Any Button . If you operate the projector while A/V Mute is on, A/V Mute is released.
Turn off the power by pressing the [⏻] button once.	Set Standby Confirmation to Off . (Default value: On)  Extended - Display - Standby Confirmation p.146

Settings related to display

Purpose	Setting Methods
To change the menu position.	Change the settings of Menu Position . ☛ Extended - Display - Menu Position p.146
To change the menu direction.	Change the settings of OSD Rotation . ☛ Extended - Display - OSD Rotation p.146
To prevent the display of menus, messages, or warnings on the screen.	Use User Button to set On-Screen Display to User Button 1 , User Button 2 , or User Button 3 . ☛ Settings - User Button p.143 When you press the button for which On-Screen Display is assigned, menus or messages are not displayed on the screen. When the same button is pressed, they are displayed again. If On-Screen Display is enabled, you cannot operate the Configuration menu (except to switch the color mode and input source).
To disable the display of the message on the projection screen when switching the source.	Set Messages to Off . (Default value: On) ☛ Extended - Display - Messages p.146 You can confirm warning by the display of the indicator. ☛ "Reading the Indicators" p.175 Dialogs related to operations and behaviors, laser warnings, termination of Message Broadcasting for Epson Projector Management, and projector ID are displayed.

Purpose	Setting Methods
To register and save the settings of the projected image.	Set Memory . ☛ "Memory Function" p.110 You can save the following settings. <ul style="list-style-type: none"> • Memory: Some settings in the Configuration menu • Lens Position: Adjustment values of the lens shift, zoom, focus, and distortion • Geometry Correction: Adjustment value of the geometry correction
To change the screen displayed on the background.	Change from Display . You can select from blue, black, and logo. If no logo is registered, the EPSON logo is displayed. Display Background : Set the screen display with no image signal input. (Default value: Blue) ☛ Extended - Display - Display Background p.146 Startup Screen : Set whether or not (On/Off) to display the user logo when the projector is turned on. (Default value: On) ☛ Extended - Display - Startup Screen p.146

The port name, location, and connector orientation differ depending on the source being connected.

Connecting a Computer

To project images from a computer, connect the computer using one of the following methods.

① **When using a commercially available computer cable**

Connect the computer's display output port to the projector's Computer port.

You can output audio from the Audio Out port on the projector by connecting the audio output port on the computer to the projector's Audio1 port using a commercially available audio cable.

② **When using a commercially available 5BNC cable**

Connect the computer's display output port to the projector's BNC port.

You can output audio from the Audio Out port on the projector by connecting the audio output port on the computer to the projector's Audio2 port using a commercially available audio cable.

③ **When using a commercially available HDMI cable**

Connect the HDMI port on the computer to the projector's HDMI port.

You can send the computer's audio with the projected image.

④ **When using a commercially available DVI-D cable**

Connect the DVI-D port on the computer to the projector's DVI-D port.

You can output audio from the Audio Out port on the projector by connecting the audio output port on the computer to the projector's Audio3 port using a commercially available audio cable.

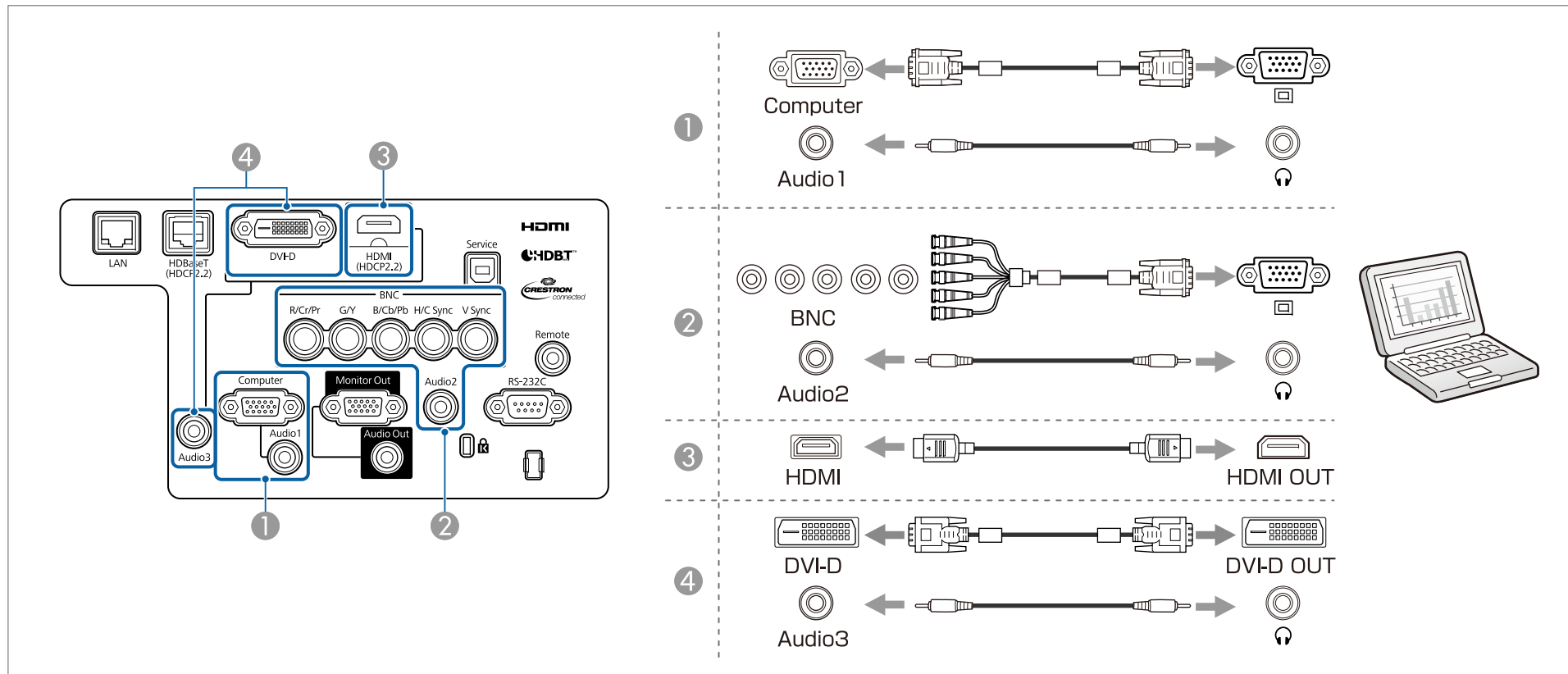

- Change the audio output from **Audio Settings**.
 - ☛ **Extended - A/V Settings - Audio Settings** [p.146](#)
- If audio is not sent using an HDMI cable, connect a commercially available audio cable to the Audio3 port to send the audio. Set **HDMI Audio Output** to **Audio3**.
 - ☛ **Extended - A/V Settings - Audio Settings - HDMI Audio Output** [p.146](#)

Connecting Image Sources

To project video images, connect to the projector using one of the following methods.

1 When using a commercially available component video cable (D-sub/component converter)

Connect the component output port on the image source to the projector's Computer port.

You can output audio from the Audio Out port on the projector by connecting the audio output port on the video equipment to the projector's Audio1 port using a commercially available audio cable.

2 When using a commercially available component video cable (RCA) and a BNC/RCA adapter

Connect the component output port on the video equipment to the projector's BNC port (R/Cr/Pr, G/Y, B/Cb/Pb).

You can output audio from the Audio Out port on the projector by connecting the audio output port on the video equipment to the projector's Audio2 port using a commercially available audio cable.

3 When using a commercially available HDMI cable

Connect the HDMI port on the image source to the projector's HDMI port.

You can send the image source's audio with the projected image.

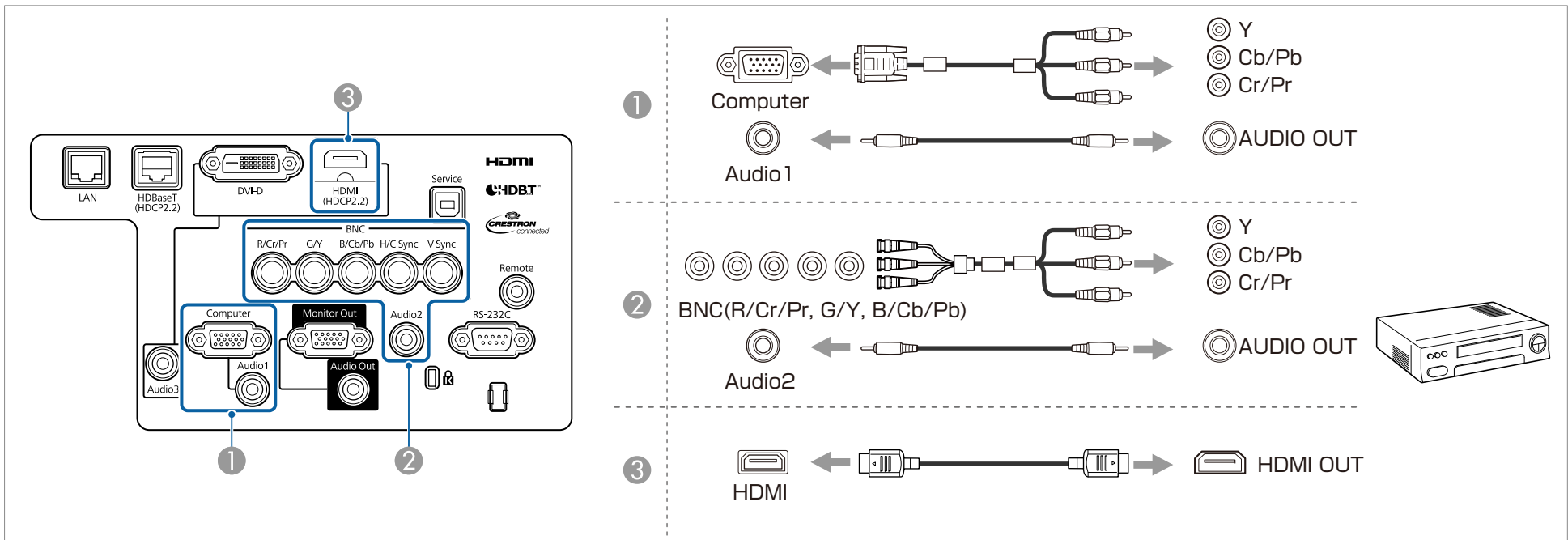

Attention

- If the input source is on when you connect it to the projector, it could cause a malfunction.
- If the orientation or shape of the plug differs, do not try to force it in. The device could be damaged or could malfunction.



- Change the audio output from **Audio Settings**.
 - ☛ **Extended - A/V Settings - Audio Settings** [p.146](#)
- If audio is not sent using an HDMI cable, connect a commercially available audio cable to the Audio3 port to send the audio. Set **HDMI Audio Output** to **Audio3**.
 - ☛ **Extended - A/V Settings - Audio Settings - HDMI Audio Output** [p.146](#)
- If the source you want to connect to has an unusually shaped port, use the cable supplied with the device or an optional cable to connect to the projector.

Connecting External Equipment

You can output images and audio by connecting an external monitor or speaker.

① **When outputting images to an external monitor**

Connect the external monitor to the projector's Monitor Out port using the cable supplied with the external monitor.

② **When outputting audio to an external speaker**

Connect the external speaker to the projector's Audio Out port using a commercially available audio cable.

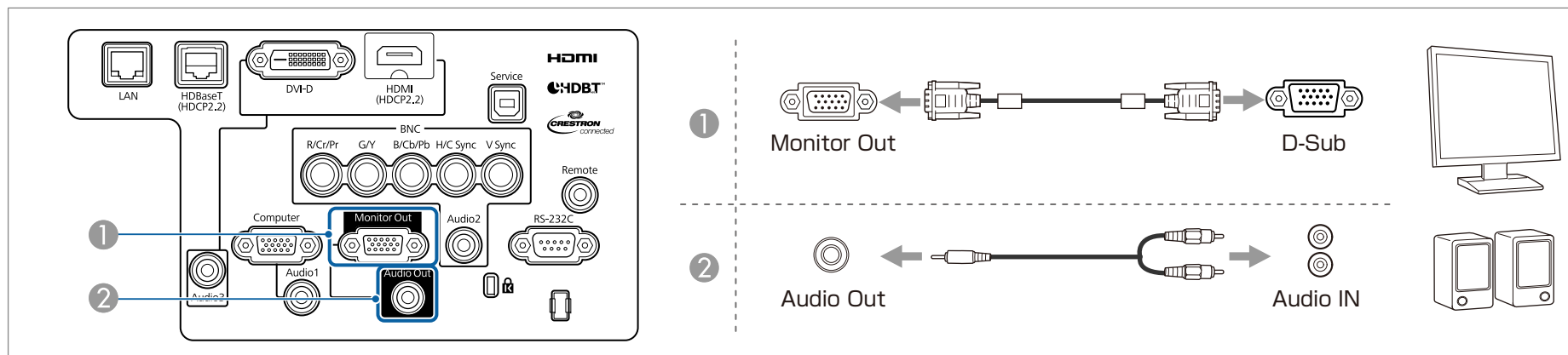

- Set **A/V Output** to **Always On** to output image even when the projector is in standby mode.
 🖱️ **Extended - A/V Settings - A/V Output** [p.146](#)
- Only analog RGB signals from the Computer port or BNC port can be output to an external monitor. You can set which signals to output in **Monitor Out**.
 🖱️ **Extended - A/V Settings - Monitor Out** [p.146](#)

Connecting a LAN Cable

Connect a LAN port on network hubs or other equipment to the projector's LAN port with a commercially available 100BASE-TX or 10BASE-T LAN cable.

By connecting a computer to the projector over a network, you can project images and check the status of the projector.

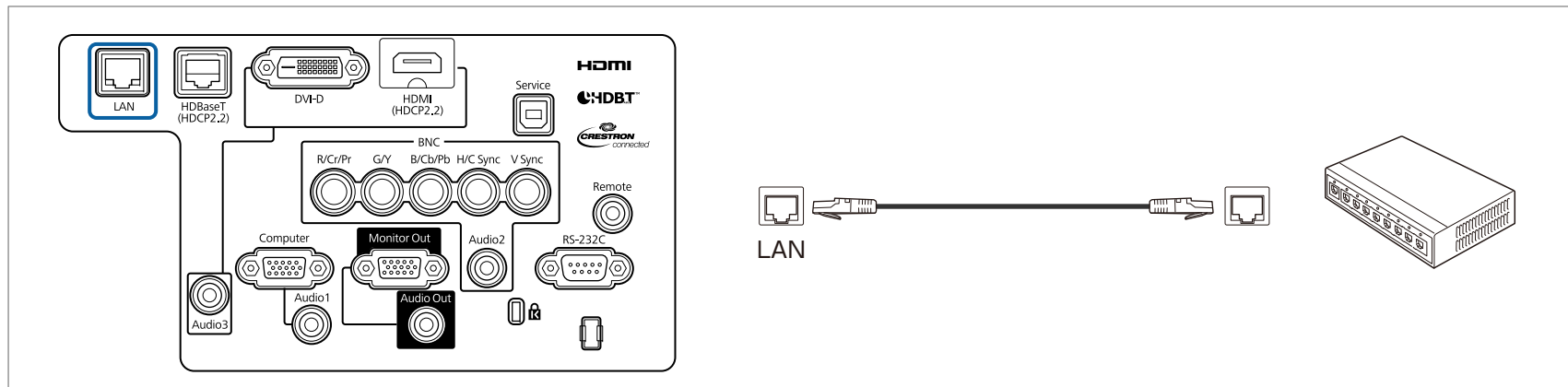

To prevent malfunctions, use a category 5 or higher shielded LAN cable.

Connecting an HDBaseT Transmitter

Connect the optional HDBaseT Transmitter with a commercially available 100BASE-TX LAN cable.

☛ "Optional Accessories" [p.233](#)

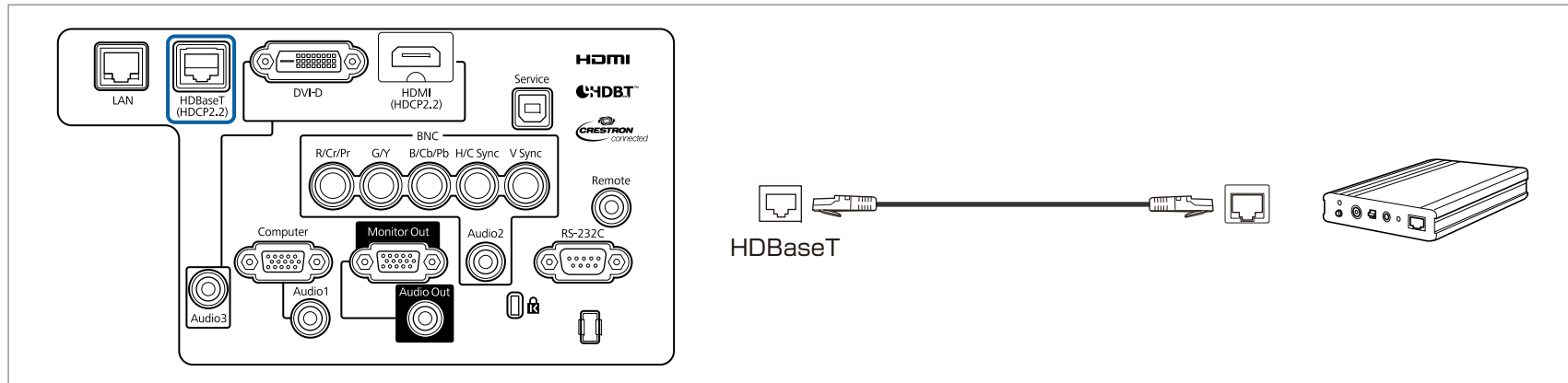

- Make sure you read the User's Guide supplied with the HDBaseT Transmitter carefully before use.
- For the LAN cable, use an HDBaseT Alliance-recommended STP cable (straight) of category 5e or higher. However, operation is not guaranteed for all input/output devices and environments.
- When connecting or disconnecting the LAN cable, make sure you turn off the power for the projector and the HDBaseT Transmitter.
- When performing Ethernet communication or serial communication, or when using the wired remote control via HDBaseT port, set **Control Communications** to **On** from the Configuration menu.
 - ☛ **Extended - HDBaseT - Control Communications** [p.146](#)

Note that when **Control Communications** is set to **On**, the projector's LAN port, RS-232C port, and Remote port are disabled.
- When using the Extron XTP transmitter or switcher, connect to the projector's HDBaseT port. Set **Extron XTP** to **On (Standby Mode and Control Communications are automatically set to On)**.
 - ☛ **Extended - HDBaseT - Extron XTP** [p.146](#)
- You can check the status of the signal being input to the HDBaseT port in **HDBaseT Signal Level**.
 - ☛ **Info - Projector Info - HDBaseT Signal Level** [p.161](#)

Installing the Wireless LAN Unit

- 1** Loosen the fixing screws and open the air filter cover. (You can loosen the screws with your fingers.)

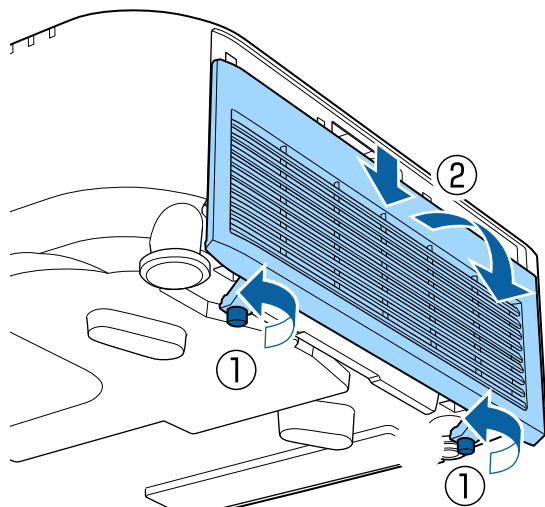

- 2** Use a plus-head screwdriver to loosen and remove the screw from the stopper for the Wireless LAN unit.

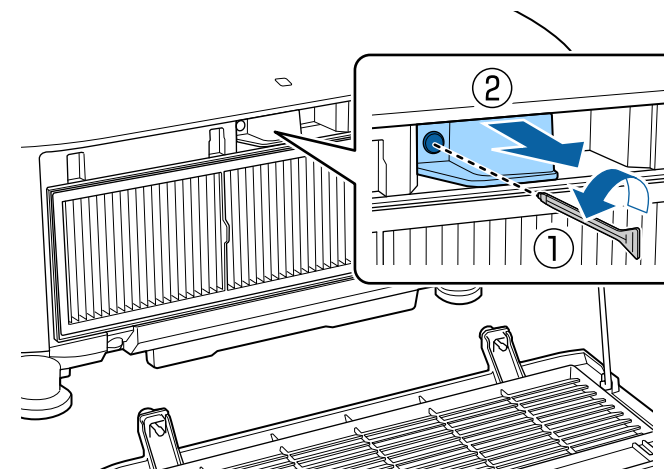

- 3** Install the Wireless LAN unit.

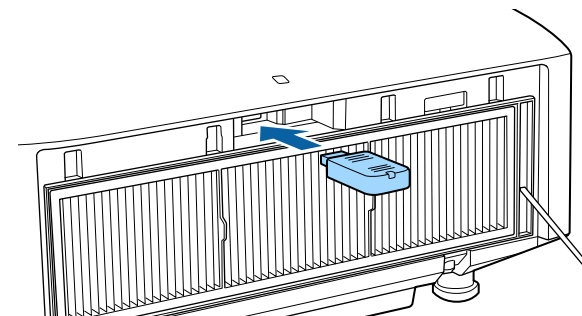

- 4** Secure the stopper with a screw.

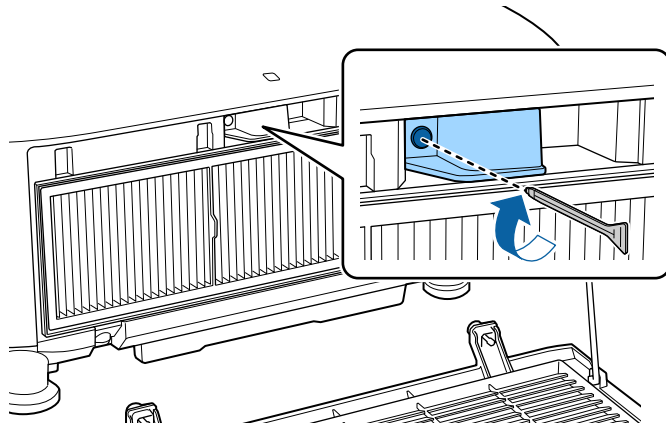

- 5** Close the air filter cover and tighten the fixing screws.

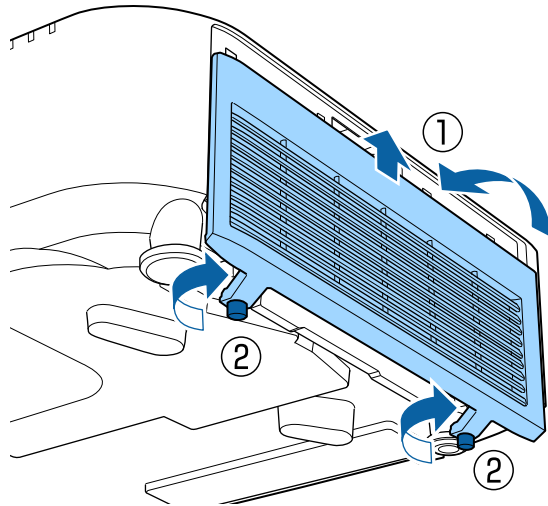

Attaching the Cable Cover

By attaching the cable cover, you can hide the connected cables giving a nice, clean finish to the projector installation. (The illustrations are of a projector installed on a ceiling.)

Warning

Do not tie the power cord and other connection cables together. Otherwise, it could cause a fire.

Attaching

- 1** Run a commercially available cable tie through the cable holder and tie the cables together.

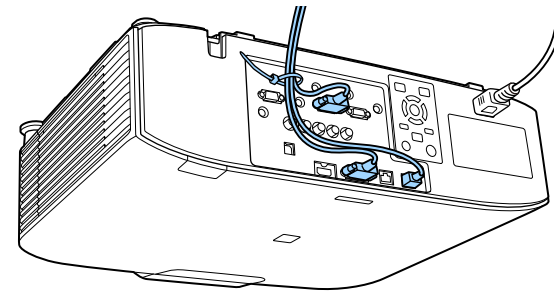

- 2** Attach the cable cover to the projector by routing the cables through the grooves in the cable cover.

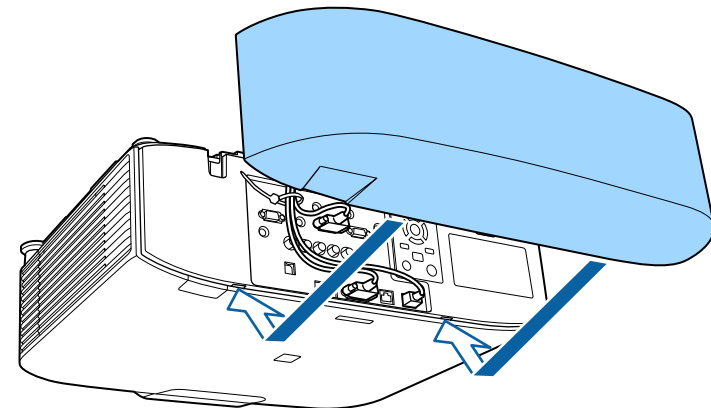

- 3** Tighten the two screws on the cable cover. (You can tighten the screws with your fingers.)

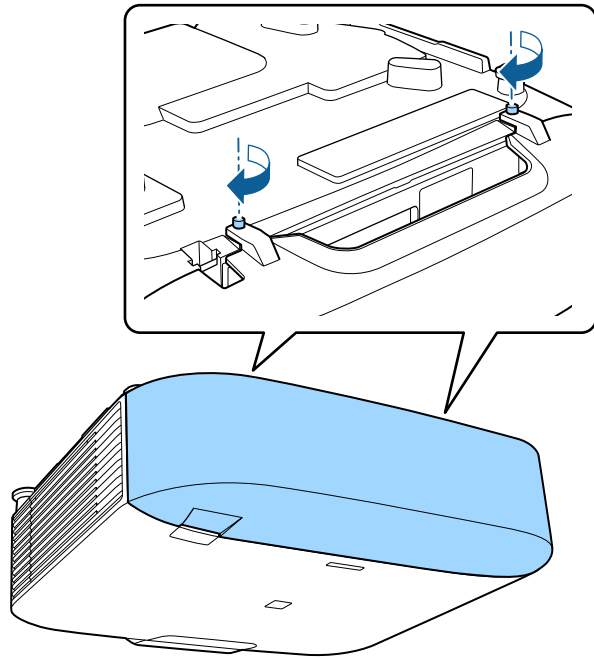



Basic Usage

This chapter explains how to project and adjust images.

Before turning on the projector, connect your computer or video equipment to the projector.

☛ "Connecting Equipment" [p.47](#)

- 1 Connect the projector to an electrical outlet with the power cord.

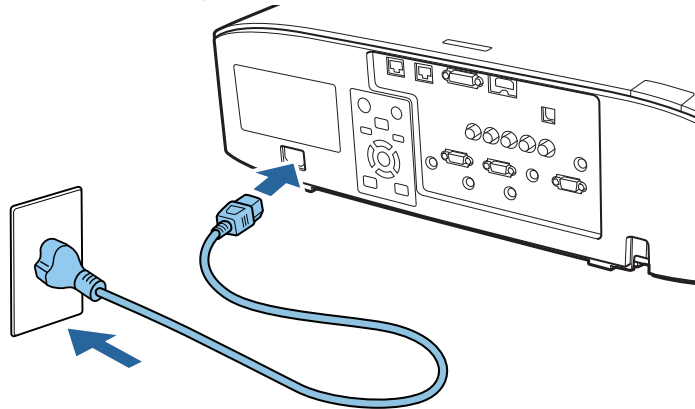

The projector's power indicator turns blue (it is in standby mode). This indicates that the projector is receiving power, but is not yet turned on.

- 2 Press the [ⓘ] button on the control panel or remote control to turn on the projector.

The confirmation buzzer beeps and the status indicator flashes blue as the projector warms up. Once the projector is warmed up, the status indicator stops flashing and turns blue.

If the image is not projected, try the following.

- Turn on the connected computer or video equipment.
- When using a laptop computer, change the screen output of the computer.
- Insert media such as a DVD and play it back.
- Press the [Search] button on the control panel or the remote control to detect the input source.

- Press the button for the input source that you want to project by using the remote control.
- If the Home screen is displayed, select the input source that you want to project.

Warning

- Do not look into the projector's lens during projection. Doing so may damage your eyes. Be especially careful if children are present.
- During projection, do not block the light from the projector with a book and so on. If the light from the projector is blocked, the area on which the light shines becomes hot which could cause it to melt, burn, or start a fire. Also, the lens may get hot due to the reflected light which could cause the projector to malfunction. To stop projection, use the A/V Mute function or turn off the projector.









- If **Direct Power On** is set to **On** in the **Extended** menu, the projector automatically turns on when the power cord is connected to it. When the power cord is plugged in, note that the projector turns on automatically in cases such as recovery from a power outage.
 - ☛ **Extended - Operation - Direct Power On** [p.146](#)
- If an image signal from the source selected in **Auto Power On** is input, the projector automatically turns on.
 - ☛ **Extended - Operation - Auto Power On** [p.146](#)

Home Screen

You can use the Home screen to easily select input sources or frequently used functions. The Home screen is displayed in the following situations.

- When the [] button on the remote control is pressed
- When the projector is turned on while **Home Screen Auto Disp.** is set to **On**
 - ☛ **Extended - Home Screen - Home Screen Auto Disp.** p.146
- When there is no signal from the selected input source when the projector is turned on

When the Home screen is displayed, use the [][][][] buttons on the control panel or remote control to select an item, and then press the [] button.

To hide the Home screen, press the [] button on the remote control again.

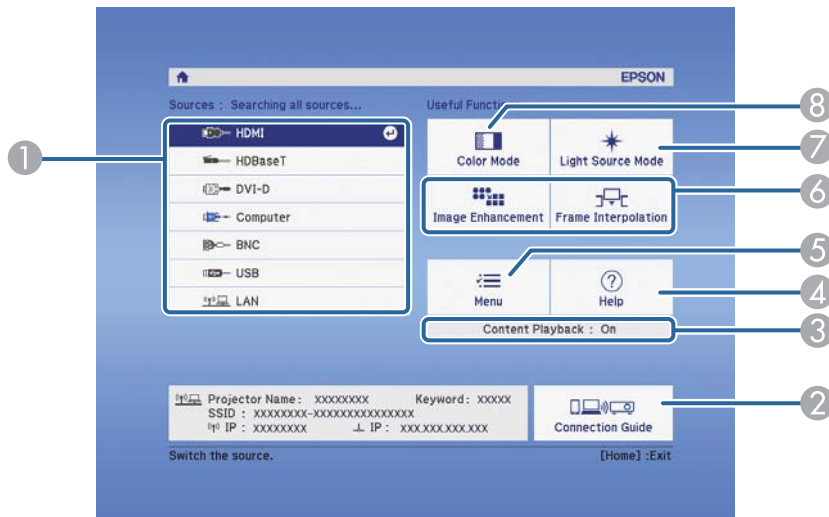

- | | |
|---|---|
| 1 | Select the input source that you want to project. |
|---|---|

- | | |
|---|---|
| 2 | Displays the Connection Guide. You can check which wireless connection method to use for your device. |
| 3 | Indicates that the projector is in Content Playback mode. |
| 4 | Displays the Help screen.
☛ "Using the Help" p.173 |
| 5 | Displays the Configuration menu. |
| 6 | Executes the function assigned to Custom Function 1 or Custom Function 2 in the Extended menu.
☛ Extended - Home Screen - Custom Function 1, Custom Function 2 p.146 |
| 7 | Select Light Source Mode.
☛ "Setting the Brightness" p.77 |
| 8 | Select Color Mode.
☛ "Selecting the Projection Quality (Selecting Color Mode)" p.76 |

 The Home screen disappears after 10 minutes of inactivity.



- To ensure a long projector service life, turn off the projector when you are not using it. The light source's operating life varies depending on the Configuration menu settings, environmental conditions, and usage conditions. The brightness of the projected image drops as projection time elapses.
- The projector can be powered off directly by the breaker because it supports the direct shutdown function.
- When the projector is used continuously for more than 24 hours, or when direct shutdown is used regularly, set **Light Source Calibration** using the scheduling function to adjust the light source periodically. You can also make settings from the Configuration menu.
 - ☛ "Scheduling Function" [p.112](#)
 - ☛ **Reset - Light Source Calibration** [p.162](#)

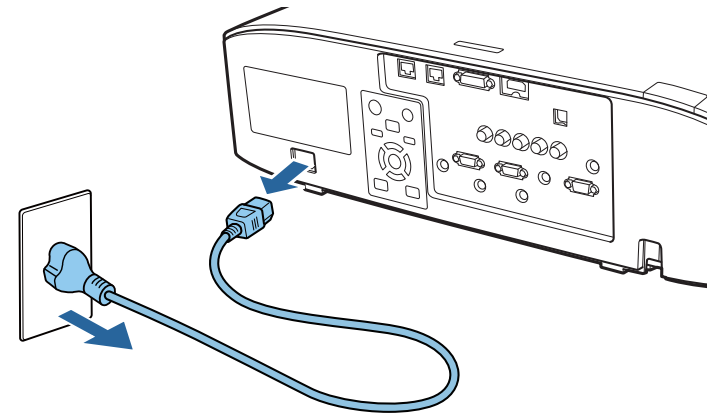

- 1** Press the [⏻] button on the control panel or the remote control. The shutdown confirmation screen is displayed.

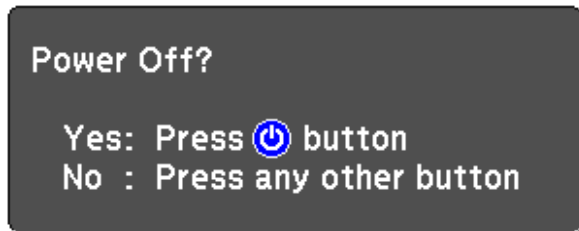

- 2** Press the [⏻] button again. (To cancel, press any other button.) After the buzzer beeps twice, the projected image disappears, and the status indicator turns off.
- 3** Disconnect the power cord.

Automatically Detecting Input Signals and Changing the Projected Image (Source Search)

Press the [Search] button to project images from the port currently receiving an image.

Using the remote control

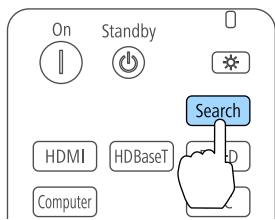

Using the control panel

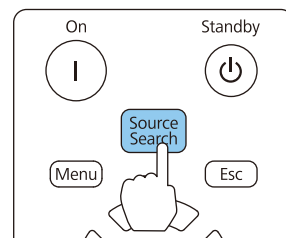

When two or more image sources are connected, repeatedly press the [Search] button until the target image is projected.

When your video equipment is connected, start playback before beginning this operation.



- You can set up the projector so that it automatically detects an image signal from another input source and projects the image when there is no image signal from the current input source.
 - Extended - Operation - Auto Source Search [p.146](#)
- The following screen is displayed while no image signals are input.

[Source Search]

	Signal Status
HDMI	Off
HDBaseT	Off
DVI-D	Off
Computer	Off
BNC	Off
LAN	Off

· Input an image signal.
· Press to select the source.

[]:Select []:Enter [Esc]:Exit

Switching to the Target Image by Remote Control

- Press the button of the input source that you want to project. The input ports for the buttons are shown below.

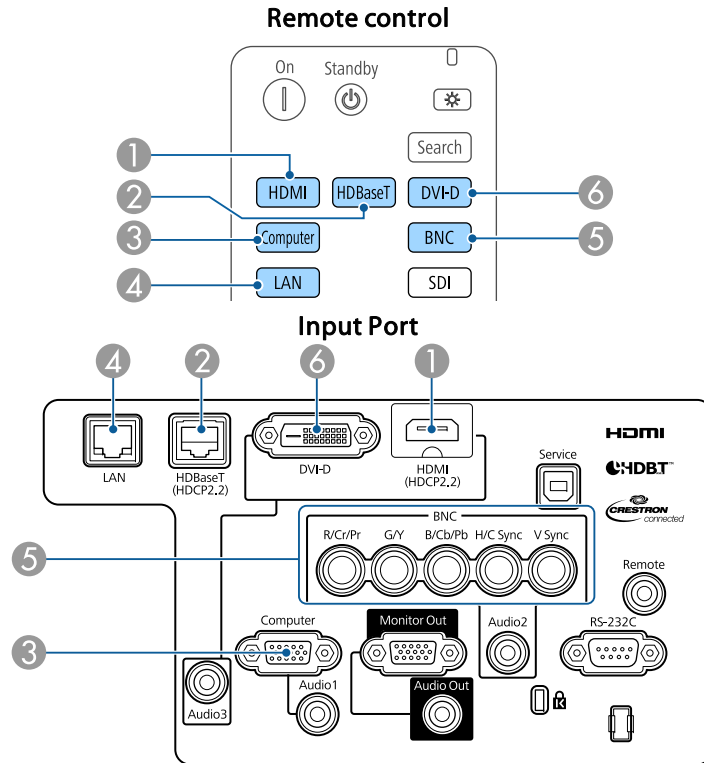

- ④ Changes to images from a computer connected via the network.



When using Content Playback mode, you can switch to the USB source by pressing the User Button assigned to **USB**.

- Press the [] button.

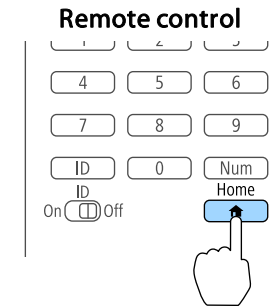

Select the input source to be projected, and then press the [] button.

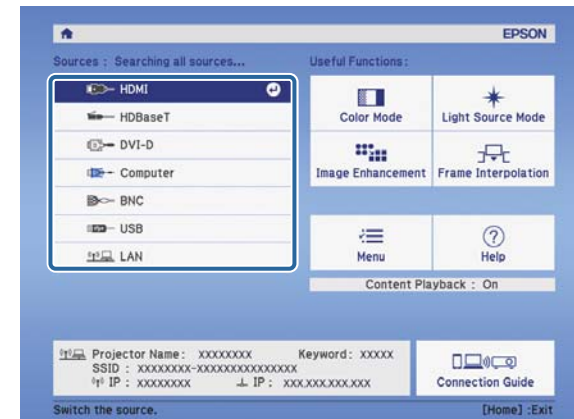

Adjusting the Volume

You can adjust the volume of the audio from the Audio Out port using one of the following methods.

- Press the [Volume] buttons on the remote control to adjust the volume.
 - [<v>] increases the volume.
 - [>v>] decreases the volume.

Remote control

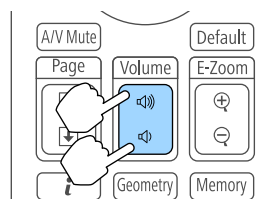

- Adjust the volume from the Configuration menu.
 - 👁 Settings - Volume [p.143](#)

Caution

Do not start at high volume.

A sudden excessive volume may cause loss of hearing. Always lower the volume before powering off, so that you can power on and then gradually increase the volume.

Correcting Distortion in the Projected Image

You can correct keystone distortion in projected images using one of the following methods.

- H/V-Keystone

This allows you to correct distortion in the horizontal and vertical directions independently.

☛ "H/V-Keystone" [p.65](#)

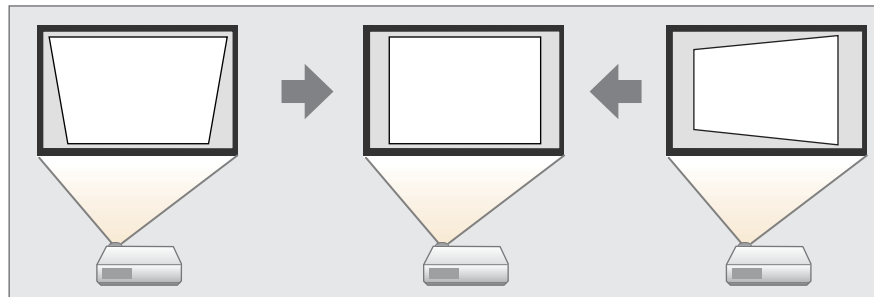

- Quick Corner

Correct the four corners independently.

☛ "Quick Corner" [p.66](#)

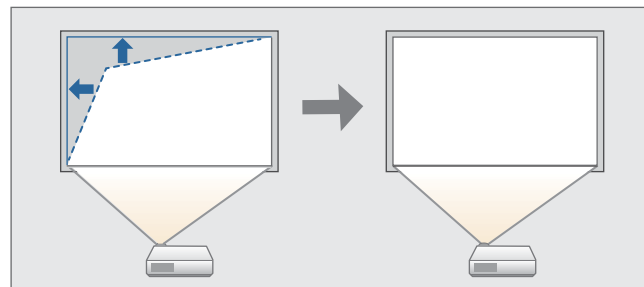

- Curved Surface

Correct distortion that occurs when projecting on a curved surface, and adjust the amount of expansion and contraction.

☛ "Curved Surface" [p.67](#)

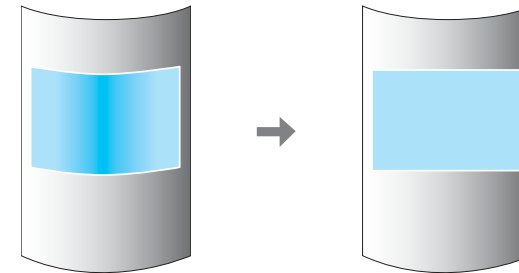

- Corner Wall

This allows you to correct distortion that occurs when projecting on a surface with right angles, such as a square pillar or the corner of a room, and adjust the amount of expansion and contraction.

☛ "Corner Wall" [p.71](#)

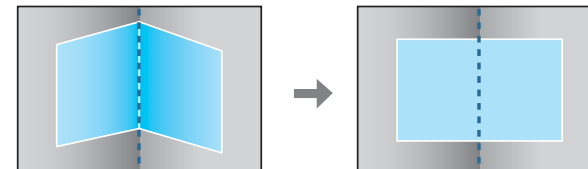

- Point Correction

Corrects slight distortion which occurs partially, or adjusts the image position in an overlapping area when projecting from multiple projectors.

☛ "Point Correction" [p.74](#)

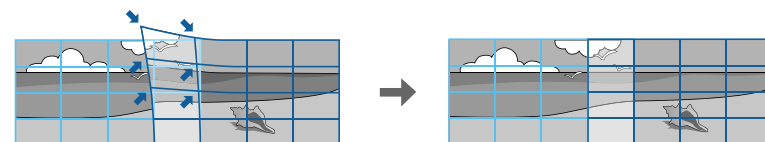



- By pressing the [Geometry] button on the remote control or the [] button on the control panel, a screen for selecting the adjustment method is displayed.
- When you want to re-adjust the projection position and so on, if you want to release the correction status temporarily, set the **Geometry Correction** to **Off**. Even when it is set to **Off**, the correction values are saved.
 - ☛ **Settings - Geometry Correction** p.143
- You can save the geometry correction settings using **Memory** in **Geometry Correction**, and load them when needed.
 - ☛ "Memory Function" p.110

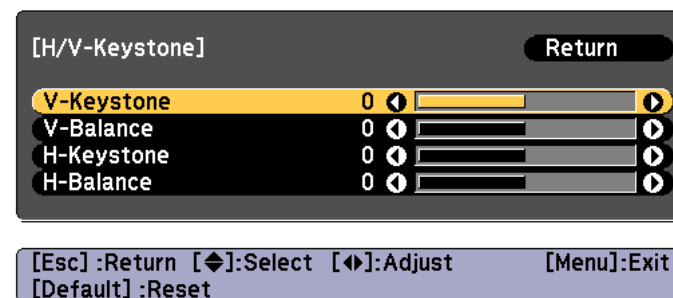

H/V-Keystone

This allows you to correct distortion in the horizontal and vertical directions independently.

Use the following to check the adjustment range for the image.

☛ "H/V-Keystone" p.261

- 1** Press the [Menu] button while projecting.
- 2** Select **Geometry Correction** from **Settings**.
- 3** Select **H/V-Keystone**, and then press the [] button.
"If this setting is changed, the image may be distorted." is displayed, press the [] button.
- 4** Use the [][] buttons to select the correction method, and then use the [][] buttons to make the corrections.

Correct the keystone distortion by using **V-Keystone** and **H-Keystone**.

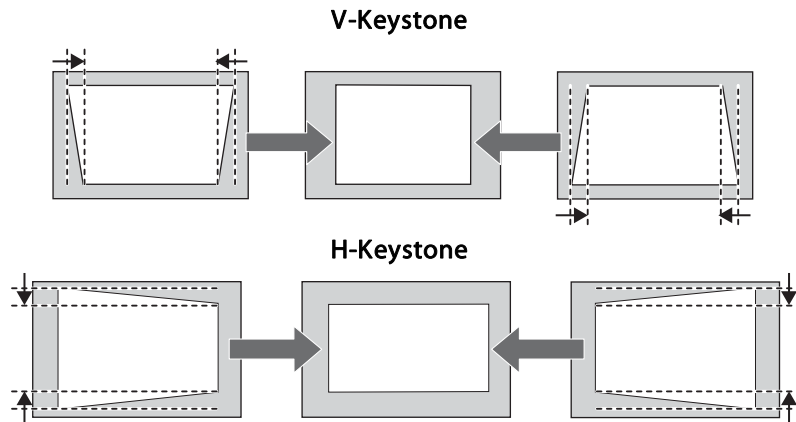

If the image aspect is incorrect, adjust the image balance by using **V-Balance** and **H-Balance**.

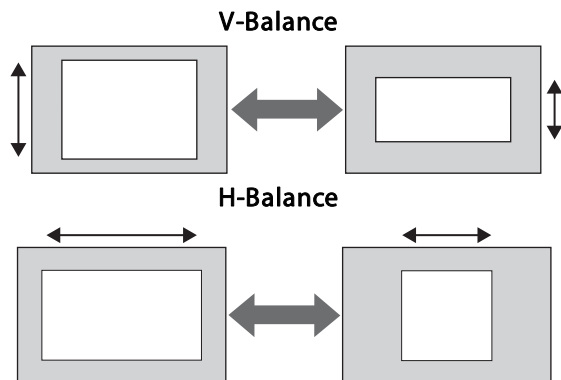

When you correct keystone distortion, the projected image may be reduced.

5 To complete the corrections, press the [Menu] button.



You cannot combine with other correction methods.

Quick Corner

This allows you to correct each of the four corners of the projected image independently.

- 1** Press the [Menu] button while projecting.
- 2** Select **Geometry Correction** from **Settings**.
- 3** Select **Quick Corner**, and then press the [↵] button.
"If this setting is changed, the image may be distorted." is displayed, press the [↵] button again.
- 4** Use the [▲], [▼], [◀], and [▶] buttons to select the corner you want to adjust, and then press the [↵] button.

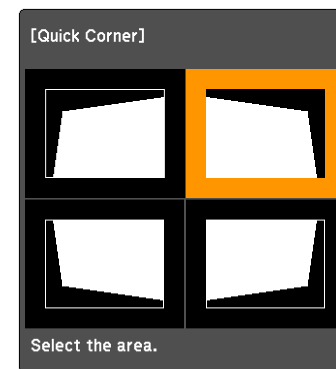

[↵/↶]: Select
 [↵]: Enter
 [Esc]: Return (press for 2 seconds to reset)



If the [Esc] button is pressed for approximately two seconds, the confirm default reset screen is displayed.

Select **Yes** to reset the result of Quick Corner corrections.

- 5 Use the [▲], [▼], [◀], and [▶] buttons to correct the position of the corner.

When you press the [↵] button, the screen shown in step 4 that allows you to select the area to be corrected is displayed.

If the message "Cannot adjust any further." is displayed while adjusting, you cannot adjust the shape any further in the direction indicated by the gray triangle.

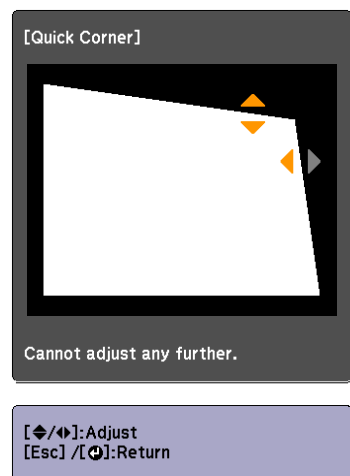

- 6 Repeat steps 4 and 5 as needed to adjust any remaining corners.
- 7 To complete the corrections, press the [Menu] button.

Curved Surface

This allows you to correct distortion that occurs when projecting on a curved surface, and adjust the amount of expansion and contraction.

Face the projector directly opposing the screen with the lens position moved to the home position.

☛ "Adjusting the Position of the Projected Image (Lens Shift Adjustment)" p.34



- Project onto an arc surface with the same radius.
- If a large amount of adjustment is performed, the focus may not be uniform even after making adjustments.
- If **4K Enhancement** is enabled, a message is displayed. Select **Yes** to disable **4K Enhancement**. (EB-L1075U/EB-L1070U/EB-L1065U/EB-L1060U/EB-L1050U only)

☛ **Image - Image Enhancement - 4K Enhancement** p.140

Use the following to check the adjustment range for the image.

☛ "Curved Surface" p.261

- 1 Press the [Menu] button while projecting.
- 2 Select **Geometry Correction** from **Settings**.
- 3 Select **Curved Surface**, and then press the [↵] button.

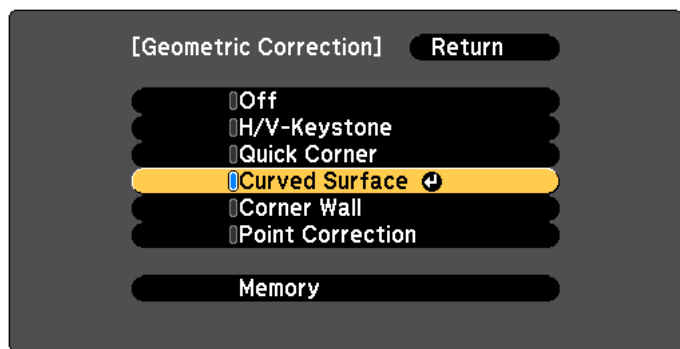

[Esc] :Return [↩]:Select [→]:Enter [Menu]:Exit

"If this setting is changed, the image may be distorted." is displayed, press the [↩] button.

4 Select **Curved Surface**, and then press the [↩] button.

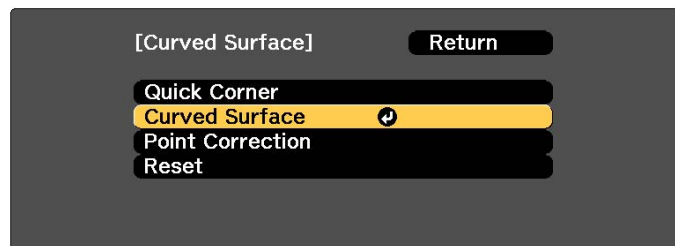

[Esc] :Return [↩]:Select [→]:Enter [Menu]:Exit

5 Select **Correct Shape**, and then press the [↩] button.

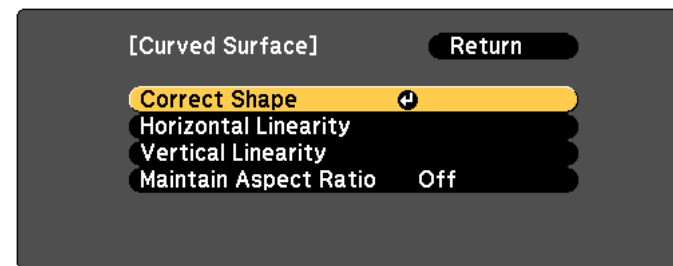

[Esc] :Return [↩]:Select [→]:Enter [Menu]:Exit

- 6** Use the [▲], [▼], [◀], and [▶] buttons to select the area you want to adjust, and then press the [↶] button.

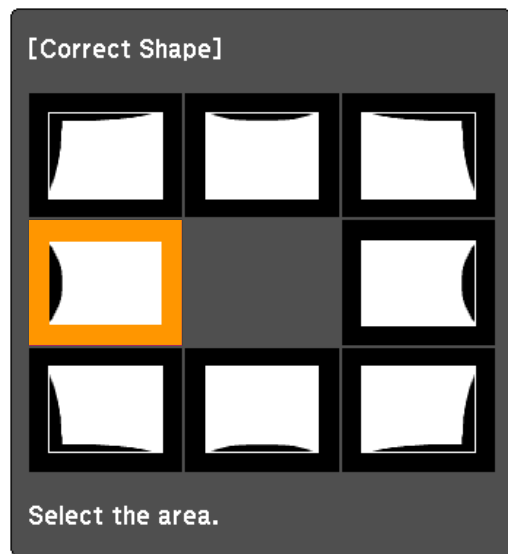

When selecting a corner, you can adjust the two sides next to the corner.



If the [Esc] button is pressed for approximately two seconds, the confirm default reset screen is displayed.

Select **Yes** to reset the result of Curved Surface.

- 7** Use the [▲], [▼], [◀], and [▶] buttons to adjust the shape.

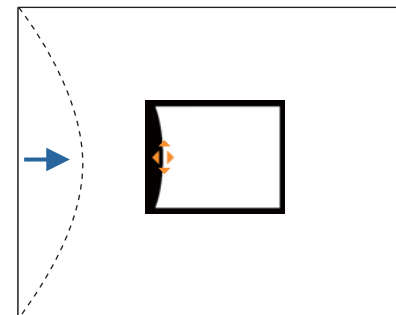

If the triangle in the direction you are adjusting the shape turns gray, as shown in the screenshot below, you cannot adjust the shape any further in that direction.

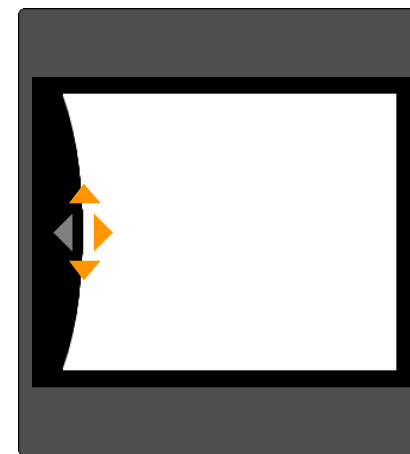

- 8** Press the [Esc] button to return to the previous screen.

- 9** Repeat steps from 6 to 8 as needed to adjust any remaining parts.

If the image expands or contracts, go to the next step and adjust the linearity.

10 Press the [Esc] button to display the screen from step 5. Select **Horizontal Linearity** or **Vertical Linearity**, and then press the [↵] button.

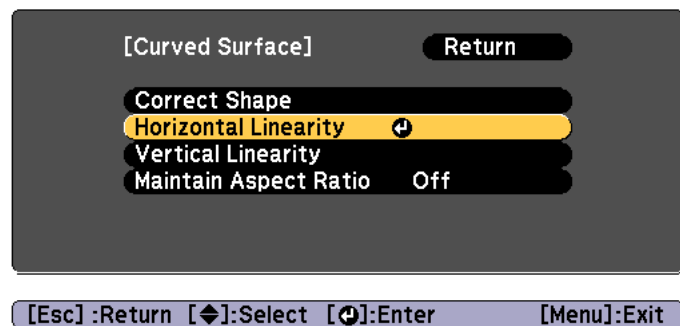

Select **Horizontal Linearity** to adjust the horizontal expansion or contraction, and select **Vertical Linearity** to adjust the vertical expansion or contraction.

 To compensate for expansion or contraction while maintaining the aspect ratio, set **Maintain Aspect Ratio** to **On**. You may not be able to perform corrections if you set this to **On** after correction. In this situation, return the corrections to their initial values, or reduce the amount of correction, and then try again.

11 Select the standard line for the adjustments, and then press the [↵] button.

Press the [◀][▶] buttons when selecting **Horizontal Linearity**, and the [▲][▼] buttons when selecting **Vertical Linearity**, and then press [↵].

The selected standard line is displayed in flashing orange and white.

 Changing the standard line resets the previous settings.

12 Adjust the linearity.
Correct it so that the distance between lines is equal.

When pressing the [◀] button

When **Horizontal Linearity** is selected When **Vertical Linearity** is selected

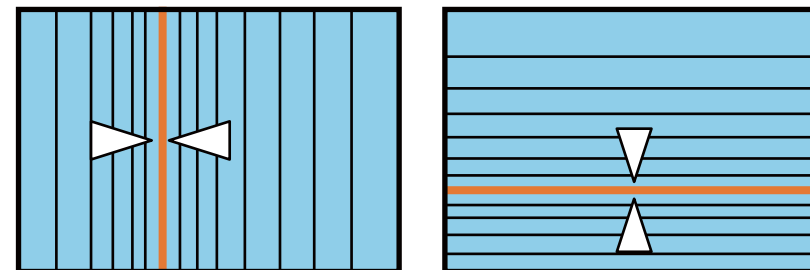

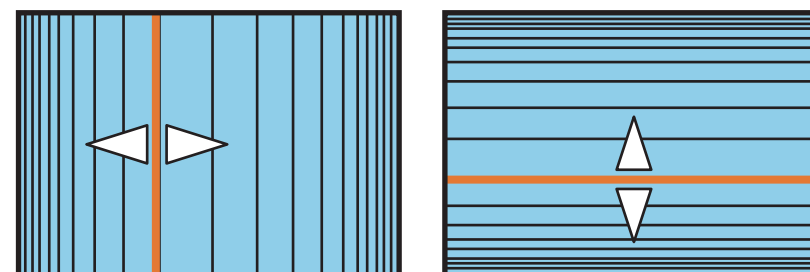

When pressing the [▶] button

When **Horizontal Linearity** is selected When **Vertical Linearity** is selected



13 To complete the corrections, press the [Menu] button.

 You can fine tune the corrected results. Use **Quick Corner** to adjust the tilt of the image, and then use **Point Correction** for fine tuning. Select **Quick Corner** or **Point Correction** on the screen from step 4.

-  "Quick Corner" [p.66](#)
-  "Point Correction" [p.74](#)

Corner Wall

This allows you to correct distortion that occurs when projecting on a surface with right angles, such as a square pillar or the corner of a room, and adjust the amount of expansion and contraction.

Face the projector directly opposing the screen with the lens position moved to the home position.

☛ "Adjusting the Position of the Projected Image (Lens Shift Adjustment)" p.34



- Project onto a surface with a right angle.
- If a large amount of adjustment is performed, the focus may not be uniform even after making adjustments.
- If **4K Enhancement** is enabled, a message is displayed. Select **Yes** to disable **4K Enhancement**. (EB-L1075U/EB-L1070U/EB-L1065U/EB-L1060U/EB-L1050U only)
 - ☛ **Image - Image Enhancement - 4K Enhancement** p.140
- This is not available for ELPLX01/ELPLX01W.

Use the following to check the adjustment range for the image.

☛ "Corner Wall" p.268

- 1 Press the [Menu] button while projecting.
- 2 Select **Geometry Correction** from **Settings**.
- 3 Select **Corner Wall**, and then press the [↵] button.

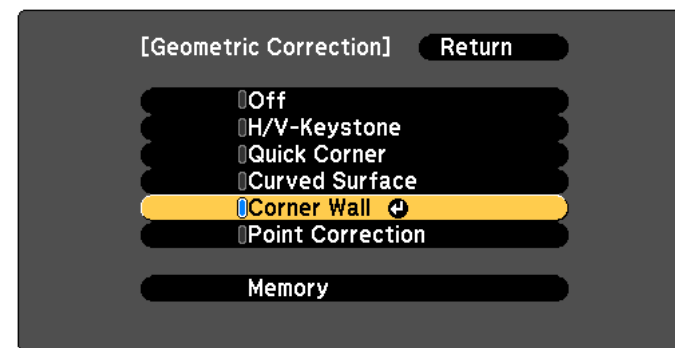

[Esc]:Return [↕]:Select [↵]:Enter [Menu]:Exit

"If this setting is changed, the image may be distorted." is displayed, press the [↵] button again.

- 4 Select **Corner Wall**, and then press the [↵] button.

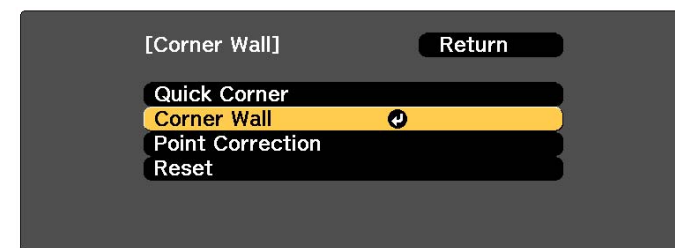

[Esc]:Return [↕]:Select [↵]:Enter [Menu]:Exit

- 5 Select **Corner Type**, and then press the [↵] button.

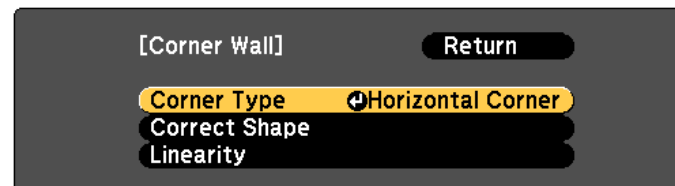

[Esc]:Return [↕]:Select [↵]:Enter [Menu]:Exit

- 6** According to the projection area, select **Horizontal Corner** or **Vertical Corner**, and then press the [**↵**] button.

When the surfaces line up horizontally:
Select **Horizontal Corner**.

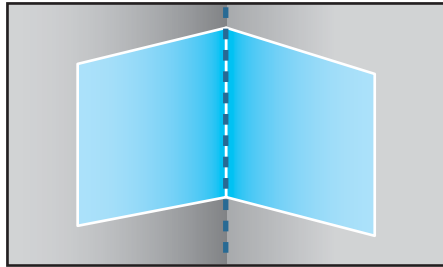

When the surfaces line up vertically:
Select **Vertical Corner**.

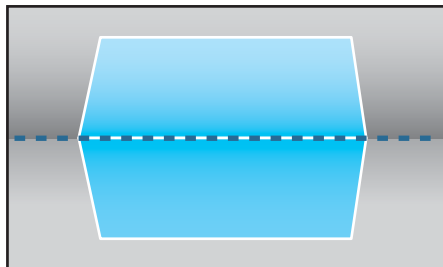

From here on, steps are explained using **Horizontal Corner** as an example.

- 7** Press the [Esc] button to display the screen from step 5. Select **Correct Shape**, and then press the [**↵**] button.

- 8** Adjust the position of the projector and the lens shift so that the line in the center of the screen matches the corner (the point where the two surfaces meet).

☛ "Adjusting the Position of the Projected Image (Lens Shift Adjustment)" [p.34](#)

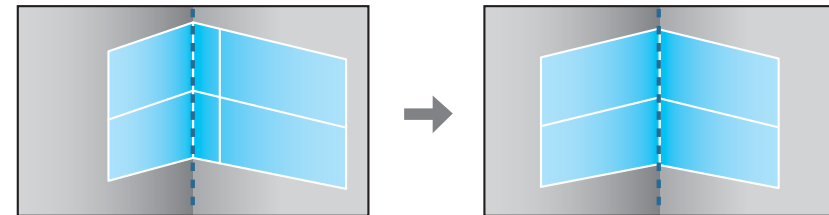

Each time you press the [**↵**] button, you can show or hide the image and the grid.

- 9** Use the [▲], [▼], [◀], and [▶] buttons to select the area you want to adjust, and then press the [↵] button.

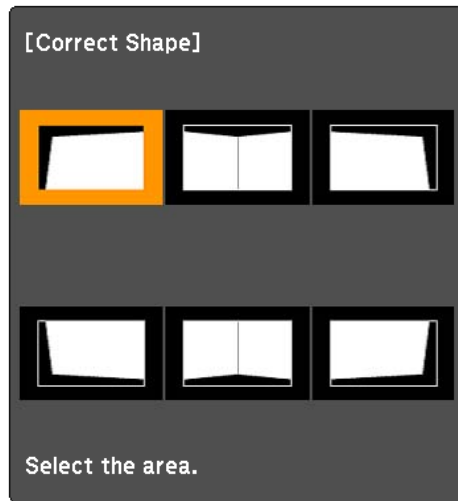

Adjustment tips

When **Horizontal Corner** is selected:

Adjust the upper area based on the lowest point (indicated by the **A** arrow).

Adjust the lower area based on the highest point (indicated by the **B** arrow).

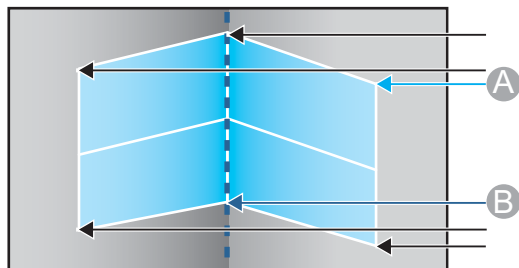

When **Vertical Corner** is selected:

Adjust the left and right based on the point nearest to the vertical line in the center of the screen.



If the [Esc] button is pressed for approximately two seconds, the confirm default reset screen is displayed.

Select **Yes** to reset the result of **Corner Wall**.

- 10** Press the [▲][▼][◀][▶] buttons to adjust the shape. If the message "Cannot adjust any further." is displayed while adjusting, you cannot adjust the shape any further in the direction indicated by the gray triangle.
- 11** Repeat steps 9 and 10 as needed to adjust any remaining parts. If the image expands or contracts, go to the next step and adjust the linearity.
- 12** Press the [Esc] button to display the screen from step 4. Select **Linearity**, and then press the [↵] button.

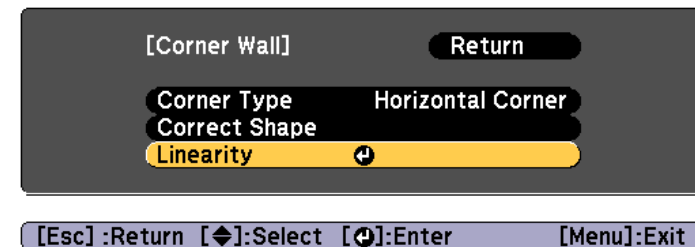

- 13** Press the [◀][▶] buttons to adjust the linearity.
Correct it so that the distance between lines is equal.

When pressing the [◀] button

When **Horizontal Corner** is selected When **Vertical Corner** is selected

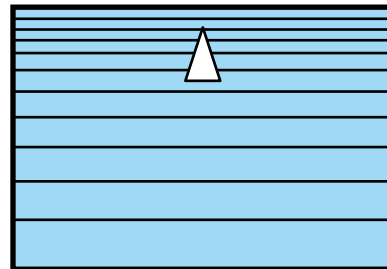
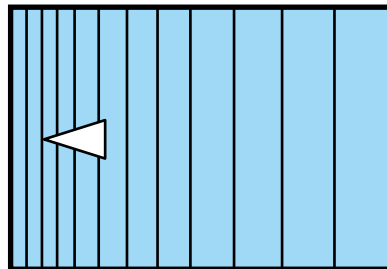

When pressing the [▶] button

When **Horizontal Corner** is selected When **Vertical Corner** is selected

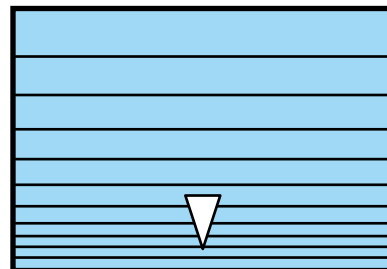
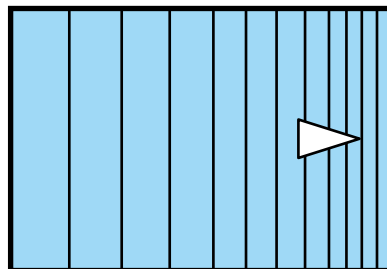

- 14** To complete the corrections, press the [Menu] button.



You can fine tune the corrected results. Use **Quick Corner** to adjust the tilt of the image, and then use **Point Correction** for fine tuning. Select **Quick Corner** or **Point Correction** on the screen from step 4.

- ☛ "Quick Corner" p.66
- ☛ "Point Correction" p.74

Point Correction

Divides the projected image by the grid and corrects the distortion by moving the point of intersection from side to side and up and down.



- You can make corrections in 0.5 pixel increments in all directions within the following ranges.
EB-L1075U/EB-L1070U/EB-L1065U/EB-L1060U/EB-L1050U: Vertical and horizontal up to a maximum of 32 pixels.
EB-L1070W/EB-L1060W/EB-L1070: Vertical and horizontal up to a maximum of 20 pixels.
- If **4K Enhancement** is enabled, a message is displayed. Select **Yes** to disable **4K Enhancement**. (EB-L1075U/EB-L1070U/EB-L1065U/EB-L1060U/EB-L1050U only)
☛ **Image - Image Enhancement - 4K Enhancement** p.140

- 1** Press the [Menu] button while projecting.
- 2** Select **Geometry Correction** from **Settings**.
- 3** Select **Point Correction**, and then press the [↵] button.

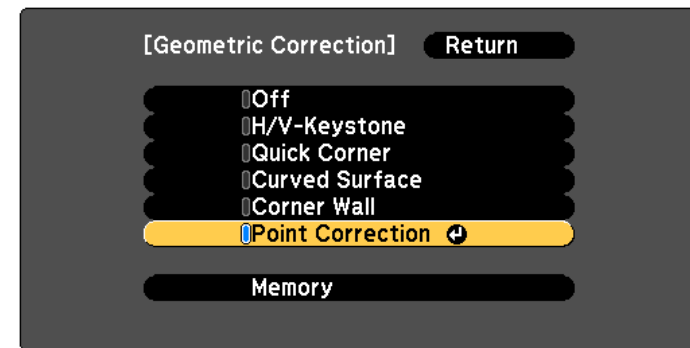

[Esc] :Return [◀]:Select [↵]:Enter [Menu]:Exit

"If this setting is changed, the image may be distorted." is displayed, press the [↵] button again.



If you reduce the number of points during correction, corrections at the position without a point are reset.

- 4** Select **Point Correction**, and then press the [↵] button.

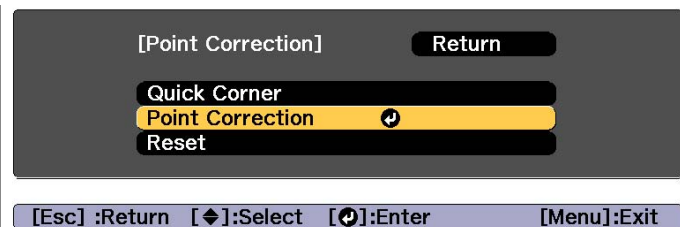

- 5** Select **Point Correction**, and then press the [↵] button.

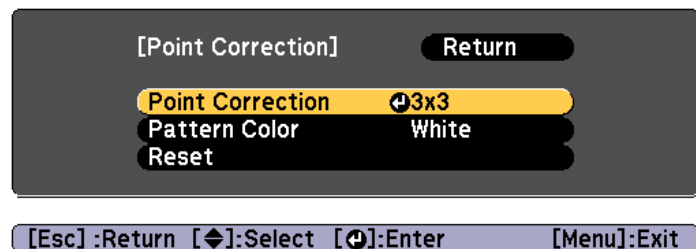

Point Correction	Select the point number (3x3, 5x5, 9x9, 17x17), and then make the Point Correction setting.
Pattern Color	Select the color of the grid when performing corrections.
Reset	Resets all corrections for Point Correction to their default values.

- 6** Select the point number (**3x3**, **5x5**, **9x9**, or **17x17**), and then press the [↵] button.

- 7** Use the [▲], [▼], [◀], and [▶] buttons to move to the point you want to correct, and then press the [↵] button.

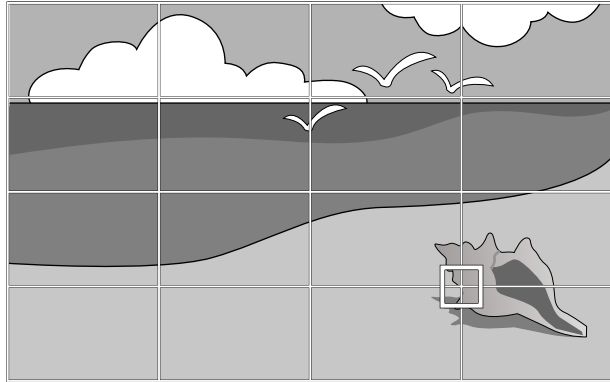

- 8** Use the [▲], [▼], [◀], and [▶] buttons to correct distortion.

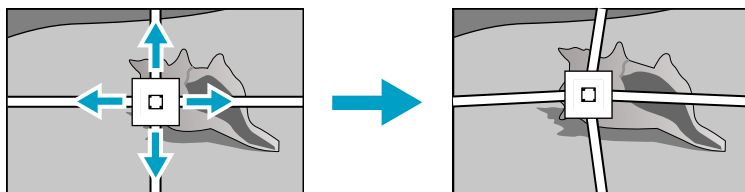

To continue to correct another point, press the [Esc] button to return to the previous screen, then repeat the steps 7 and 8.

Each time you press the [↵] button, you can show or hide the image and the grid.

- 9** To complete the corrections, press the [Menu] button.



You can fine tune the corrected results. Select **Quick Corner** on the screen from step 4 to adjust the tilt of the image.

☞ "Quick Corner" [p.66](#)

Selecting the Projection Quality (Selecting Color Mode)

You can easily obtain the optimum image quality simply by selecting the setting that best corresponds to your surroundings when projecting. The brightness of the image varies depending on the mode selected.

Mode	Application
Dynamic	This is the brightest mode. Ideal for use in a bright room.
Presentation	The images are vivid and brought to life. Ideal for making presentations or watching a TV program in a bright room.
Natural	Reproduces colors faithfully. Ideal for projecting still pictures such as photos.
Cinema	Gives images a natural tone. Ideal for watching films in a dark room.
BT.709	Produces images that conform to the ITU-R BT.709.
DICOM SIM	This produces images with clear shadows. Ideal for projecting X-ray photographs and other medical images. The projector is not a medical device and cannot be used for medical diagnosis.
Multi-Projection	Minimize the color tone difference between each projected image. Ideal for projecting from multiple projectors.

Each time you press the [Color Mode] button, the Color Mode name is displayed on the screen and the Color Mode changes.

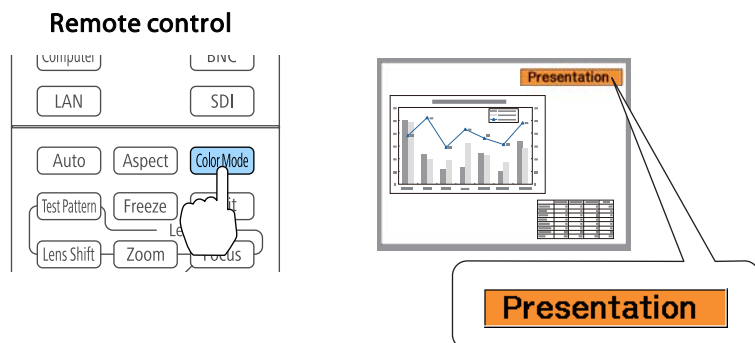

You can set Color Mode from the Configuration menu.

👉 Image - Color Mode [p.140](#)

Setting the Brightness

Set the brightness for the light source.

- 1** Press the [Menu] button while projecting.
- 2** Select **Brightness Settings** from **Settings**.
- 3** Select **Light Source Mode**, and then press the [↵] button.
- 4** Select the item you want to set, and then press the [↵] button.

Normal: Select this if you do not want to decrease the brightness. This makes the light source operation time approximately 20,000 hours.

Medium: Noise from the fan is louder than when **Quiet** is selected, but it does not decrease the brightness as much. This sets the

brightness at 85%. This makes the light source operation time approximately 20,000 hours.

Quiet: Select this if you are concerned about the noise made by the fan. This sets the brightness at 70%. This makes the light source operation time approximately 20,000 hours.

Extended: Select this to extend the life expectancy of the light source. This sets the brightness at 70%. This makes the light source operation time approximately 30,000 hours.

Custom: Select this to set the **Brightness Level** manually. When **Custom** is selected, **Constant Brightness** is available.

- 5** When **Light Source Mode** is set to **Custom**, select **Brightness Level**, and then use the [◀][▶] buttons to set the brightness.
- 6** To maintain a fixed brightness, select **Constant Brightness**, and set it to **On**.



- When **Constant Brightness** is set to **On**, you cannot change the settings for **Light Source Mode** and **Brightness Level**. When you want to change these settings, set **Constant Brightness** to **Off**.
- When **Constant Brightness** is set to **Off**, the value for **Brightness Level** changes depending on the current status of the light source.
- There may be a margin of error in the **Brightness Level**.
- When the projector is used continuously for more than 24 hours, or when direct shutdown is used regularly, set **Light Source Calibration** using the scheduling function. If this is not set, the Constant Brightness function does not work. You can also make settings from the Configuration menu.
 - 👉 "Scheduling Function" [p.112](#)
 - 👉 **Reset - Light Source Calibration** [p.162](#)

Guide to Estimated Remains

When **Constant Brightness** is set to **On**, the Estimated Remains is displayed. Estimated Remains indicates the amount of time for which constant brightness can be maintained.

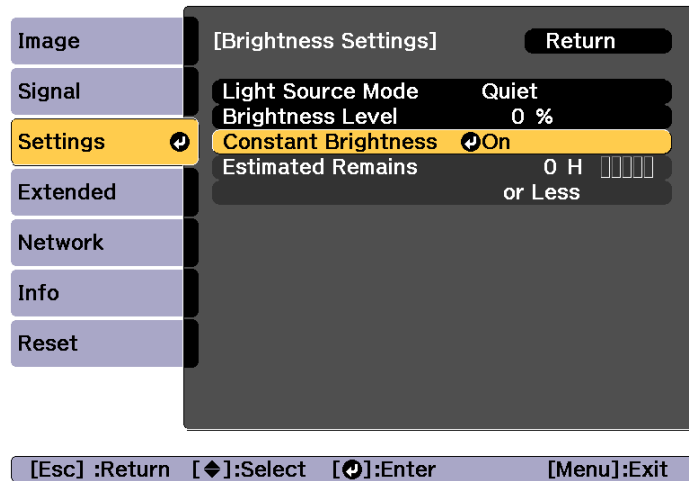

Display Level	Estimated Remains
	10,000 hours or more
█	8,000 to 9,999 hours
██	6,000 to 7,999 hours
███	4,000 to 5,999 hours
████	2,000 to 3,999 hours
█████	0 to 1,999 hours

 The time displayed on the screen is just a guide. 30,000 hours or more is displayed in units of 10,000; 2,000 to 29,999 hours is displayed in units of 1,000; and up to 1,999 hours is displayed in units of 100.

Relationship between Brightness Level and light source operation time

The following shows the relationship between Brightness Level and the light source operation time.

When Constant Brightness is set to Off

- ①: Brightness Level
- ②: Approximate light source operation time until its brightness is reduced by half

①	②
100%	20,000 hours
90%	21,000 hours
80%	24,000 hours
70%	30,000 hours
60%	37,000 hours
50%	47,000 hours
40%	61,000 hours
30%	71,000 hours

When Constant Brightness is set to On

- ①: Brightness Level
- ②: Approximate time for which constant brightness of the light source can be maintained

①	②	Illustration
85%	6,000 hours	
80%	10,000 hours	
70%	19,000 hours	
60%	29,000 hours	

①	②	Illustration
50%	41,000 hours	
40%	56,000 hours	
30%	78,000 hours	



- This is an approximate guide only and may change depending on the projector's usage and surroundings.
- The times above are the standard hours when using the projector continuously without changing the **Brightness Level** or **Constant Brightness** settings and are not guaranteed.
- This is an approximate guide only and may change depending on the projector's usage and surroundings. You may need to replace internal parts sooner than the estimated light source operation time.
- When **Constant Brightness** is set to **On**, and the approximate constant time has been exceeded, you may not be able to set a high value for **Brightness Level**.

Setting the Amount of Light of the Projected Image

By automatically setting the luminance according to the brightness of the displayed image, it lets you enjoy deep and rich images. You can also set the light source to turn off automatically.

- 1 Press the [Menu] button while projecting.
- 2 Select **Light Source Control** from **Image**, and then press the [↵] button.
- 3 Select **Light Source Control**, and then press the [↵] button.

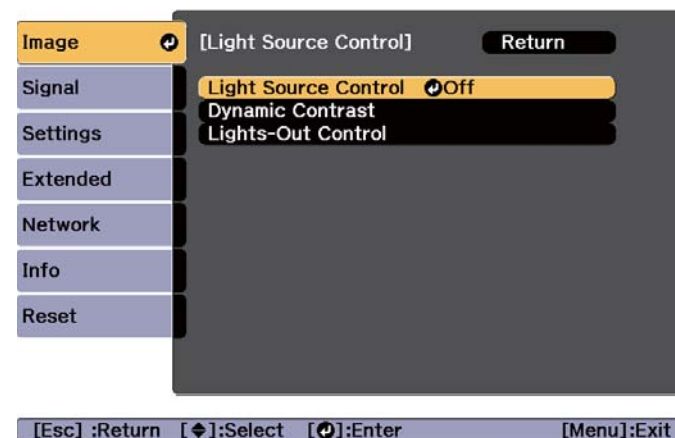

- 4 Select the light source operation according to the image signal, and then press the [↵] button.

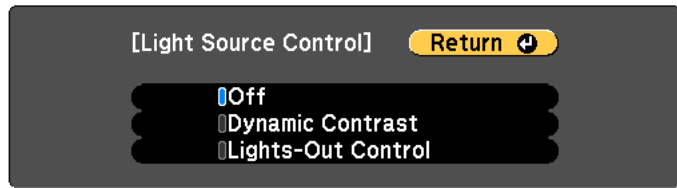

[Esc] / [⏪]:Return [⏩]:Select [Menu]:Exit

- **Off:** Select if you do not want to control the light source.
- **Dynamic Contrast:** Automatically adjust the amount of light when projecting according to the brightness of the image.
- **Lights-Out Control:** Automatically turns off the light after the set time has elapsed at the specified video level.

5 Press the [Esc] button to return to the previous screen.

6 If you selected **Dynamic Contrast** in step 4, make the following settings in **Dynamic Contrast**.

- **Response Speed:** Select **High Speed** to adjust the amount of light as soon as the scene changes.
- **Black Level:** Set the black level when the brightness level of the image signal is zero. When you select **0%**, the light source turns off.

7 If you selected **Lights-Out Control** in step 4, make the following settings in **Lights-Out Control**.

- **Lights-Out Signal Level:** Set the brightness level for the video signal being controlled. After turning off automatically when exceeding the specified image level, it turns on immediately.
- **Lights-Out Timer:** Set the amount of time before automatically turning off the light source.

8 Press the [Menu] button to finish making settings.

Changing the Aspect Ratio of the Projected Image

You can change the aspect ratio of the projected image to suit the type, the ratio of height and width, and the resolution of the input signals.

Available aspect modes vary depending on the Screen Type currently set.



- Set the **Screen Type** before changing the aspect ratio.
 - ☛ "Screen Settings" p.32
- This cannot be changed when **Scale Mode** is set to **Zoom Display**.
 - ☛ Signal - Scale - Scale Mode p.142

Changing methods

Each time you press the [Aspect] button on the remote control, the aspect mode name is displayed on the screen and the aspect ratio changes.

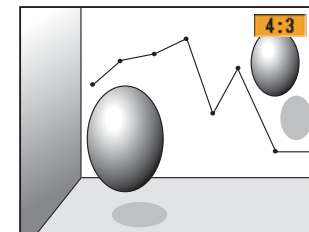
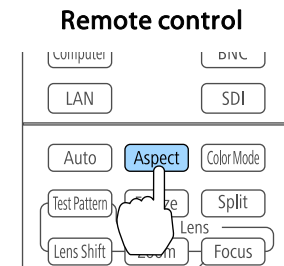

Aspect Mode	Explanation
Auto	Projects in an appropriate aspect ratio based on information from the signal being input.
Normal	Projects while retaining the aspect ratio of the input image.
4:3	Projects at an aspect ratio of 4:3.
16:9	Projects at an aspect ratio of 16:9.

Aspect Mode	Explanation
Full	Projects at the full size of the projected screen.
H-Zoom	Projects by enlarging the input image to the full width of the projected screen while retaining the aspect ratio. Areas that exceed the edges of the projected screen are not projected.
V-Zoom	Projects by enlarging the input image to the full height of the projected screen while retaining the aspect ratio. Areas that exceed the edges of the projected screen are not projected.
Native	Projects to the center of the projected screen at the resolution of the input image. Areas that exceed the edges of the projected screen are not projected.



- The available aspect ratios differ depending on the input signal from the connected device.
- You can also set the aspect ratio from the Configuration menu.
 🖱️ **Signal - Aspect** p.142
- If parts of the computer image are missing, set the **Resolution** setting to **Wide** or **Normal** from the Configuration menu, according to the resolution of the computer.
 🖱️ **Signal - Resolution** p.142

Adjusting the Image

Hue, Saturation, and Brightness adjustment

You can adjust the **Hue** (tint), **Saturation** (vividness), and **Brightness** of the six axes R (red), G (green), B (blue), C (cyan), M (magenta), and Y (yellow) according to your preferences.

1 Press the [Menu] button while projecting.

2 Select **Advanced** from **Image**, and then press the [↵] button.

3 Select **RGBCMY**, and then press the [↵] button.

4 Use the [▲][▼] buttons to select the color you want to adjust, and then press the [↵] button.

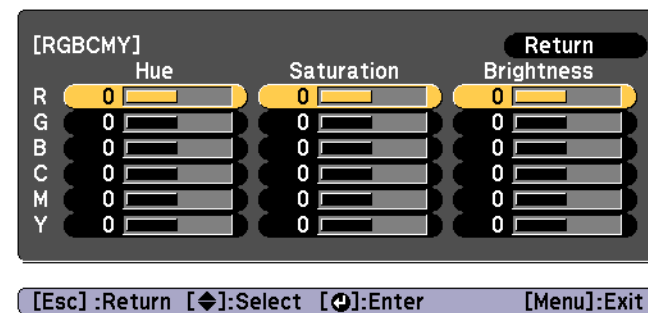

5 Use the [▲][▼] buttons to select the item, and then use the [◀][▶] buttons to make the adjustments.

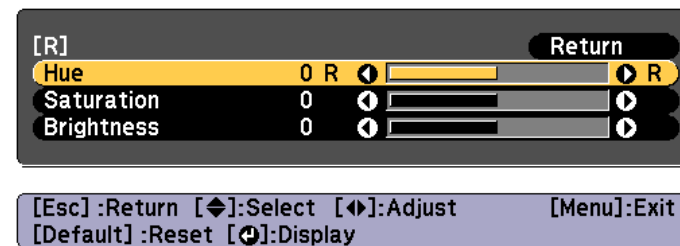

Each time you press the [↵] button, the adjustment screen changes.

6 To complete the corrections, press the [Menu] button.

Gamma adjustment

You can adjust differences in the halftone brightness that occurs depending on the connected device.



Adjust by projecting a still picture. Gamma cannot be adjusted correctly by using movies.

- 1** Press the [Menu] button while projecting.
- 2** Select **Advanced** from **Image**, and then press the [↵] button.
- 3** Select **Gamma**, and then press the [↵] button.
- 4** Use the [◀][▶] buttons to adjust the value.

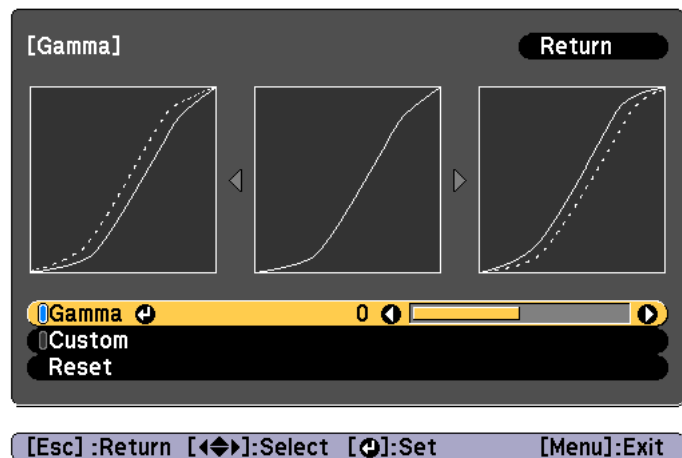

When a larger value is selected, the dark areas of images become brighter, but the color saturation for lighter areas may become weaker.

When a smaller value is selected, you can reduce the overall brightness of the image to make the image sharper.

If you select **DICOM SIM** from **Color Mode** on the **Image** menu, select the adjustment value according to the projection size.

- If the projection size is 120 inches or less, select a small value.
- If the projection size is 120 inches or more, select a large value.



Medical images may not be reproduced correctly according to your installation environment and screen specifications.

- 5** To make detailed adjustments, select **Custom**, and then press the [↵] button.
- 6** Use the [◀][▶] buttons to select the tone that you want to change, and then use the [▲][▼] buttons to make the adjustments. When you have finished making changes, confirm by using the [↵] button.

If you use the [◀][▶] buttons to select the tone that you want to change, the image flashes and you can check the tone area of the adjustment target.



- 7** When **Do you want to continue adjusting the setting?** is displayed, select **Yes** or **No**.

To adjust another tone, select **Yes**, and repeat the procedure from step 6.

Adjusting Image Resolution (Image Enhancement)

You can adjust the resolution of the image using **Image Enhancement** to reproduce a clear image with an emphatic texture and material feel.

- 1** Press the [Menu] button while projecting.
- 2** Select **Image Enhancement** from **Image**, and then press the [↵] button.

The following screen is displayed.

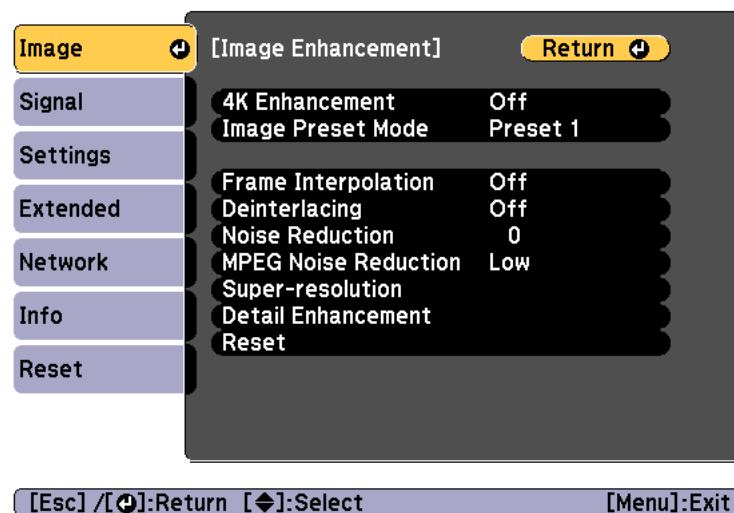

4K Enhancement (EB-L1075U/EB-L1070U/EB-L1065U/EB-L1060U/EB-L1050U only)

4K Enhancement is a function that projects an image at a doubled resolution by diagonally shifting 1 pixel in increments of 0.5 pixels.

A high-resolution image signal is projected in fine detail.

1 Select **4K Enhancement** from **Image Enhancement**, and then press the [**↵**] button.

2 Select one of the following, and then press the [**↵**] button.

Off: Disables 4K Enhancement. If a signal that exceeds the panel resolution of this projector is input, the image is displayed according to the panel resolution of this projector.

Full HD: If a signal with a resolution of 1080i/1080p/WUXGA or higher is input, 4K Enhancement is enabled.

WUXGA+: If a signal with a resolution that exceeds WUXGA is input, 4K Enhancement is enabled. To project a high-resolution movie, you can project a high-definition image by using this setting with **Image Preset Mode**.

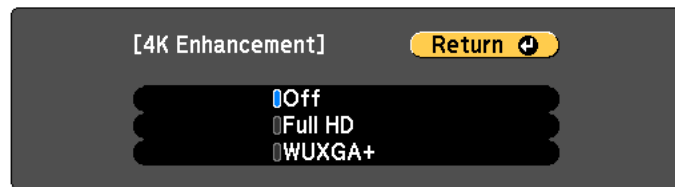

[Esc] / [⏪]:Return [↵]:Select [Menu]:Exit



- To project from multiple projectors, select **Off** to unify each image.
- **Off** is ideal for projecting presentation materials from computers and so on.
- If set to **Full HD** or **WUXGA+**, the status corrected using the following function is canceled.
Edge Blending, Scale, Curved Surface, Point Correction, Corner Wall
When **4K Enhancement** is set to **Off**, the settings return to their previous state.

3 Press the [Esc] button to return to the previous screen.

Image Preset Mode

Select the optimal setting according to the projected image from five presets prepared in advance.

The following settings are saved in the presets.

Frame Interpolation, Deinterlacing, Noise Reduction, MPEG Noise Reduction, Super-resolution, Detail Enhancement



- To minimize delays, set **Image Preset Mode** to **Off**.
- If you set **Image Preset Mode** to **Off**, you cannot set the other items in **Image Enhancement**.

1 Select **Image Preset Mode** from **Image Enhancement**, and then press the [**↵**] button.

2 Select one of the following, and then press the [**↵**] button.

Preset 1 to Preset 5: The settings saved in advance are applied to the image.

Off: Select this to turn off presets.

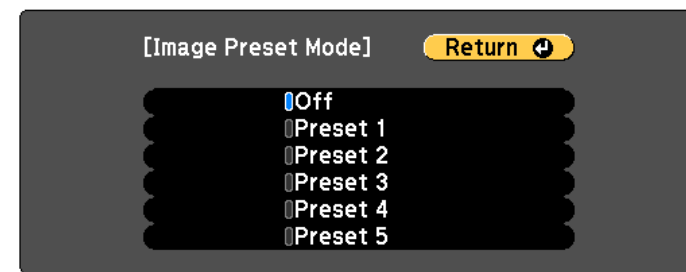

[Esc] / [⏪]:Return [↵]:Select [Menu]:Exit



- After selecting **Preset 1** to **Preset 5**, you can fine tune each setting individually. The setting after adjustment will be overwritten.
- The setting after adjustment will be overwritten separately when **4K Enhancement** is enabled and disabled.

3 Press the [Esc] button to return to the previous screen.

Frame Interpolation

The current and previous frames are used to create intermediate frames, interpolating to produce smooth-moving images. You can resolve clumsy-moving images, such as frame skipping when projecting a fast moving image.

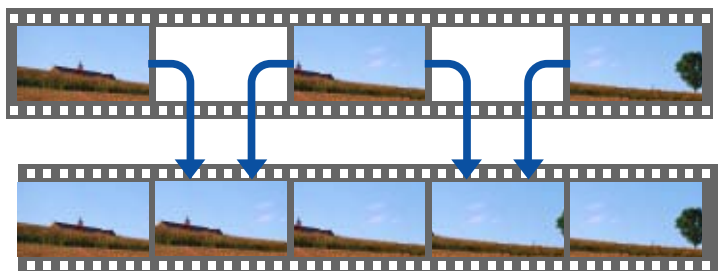

You cannot set Frame Interpolation in the following situations.

- When **4K Enhancement** is enabled
- When a signal with a resolution that exceeds WUXGA is input
- When **Aspect** is set to **V-Zoom**
- When **Scale** is set to **Auto** or **Manual**
- When **Edge Blending** is set to **On**

1 Select **Frame Interpolation** from **Image Enhancement**, and then press the [**↵**] button.

2 Select the level of interpolation from **Low**, **Normal** or **High**. Set to **Off** if noise occurs after setting them.

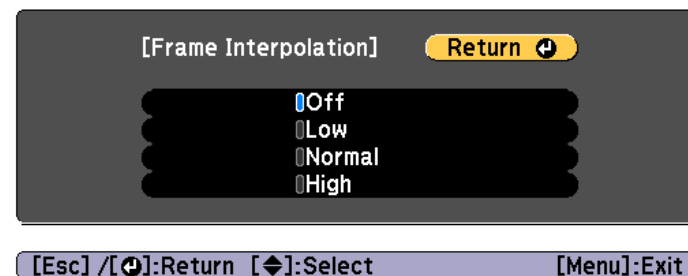

3 Press the [Menu] button to finish making settings.

Noise Reduction

You can smooth out rough images for softer image quality when inputting progressive signals or progressive interlace signals.



This is disabled in the following cases.

- When **4K Enhancement** is enabled
- When a signal with a resolution that exceeds WUXGA is input

1 Select **Noise Reduction** from **Image Enhancement**, and then press the [**↵**] button.

2 Use the [**◀**][**▶**] buttons to adjust the value.

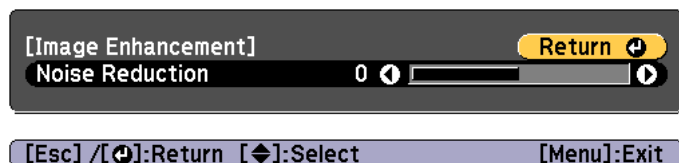

3 Press the [Esc] button to return to the previous screen.

MPEG Noise Reduction

You can reduce dot and block noise that occurs in outlines when projecting MPEG movies.



This is disabled in the following cases.

- When **4K Enhancement** is enabled
- When a signal with a resolution that exceeds WUXGA is input

1 Select **MPEG Noise Reduction** from **Image Enhancement**, and then press the [**↵**] button.

2 Select a level to reduce noise from **Low**, **Normal**, or **High**, and then press the [**↵**] button.

If **Off** is selected, **MPEG Noise Reduction** is disabled.

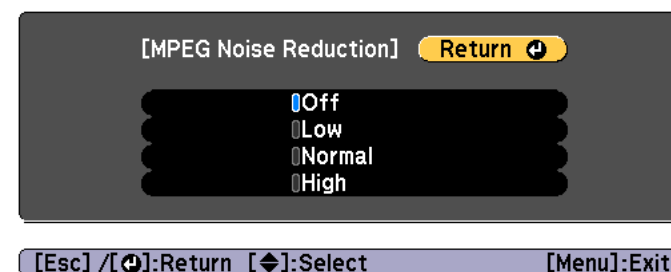

3 Press the [Esc] button to return to the previous screen.

Super-resolution

To display a crisp image, you can reduce the blurring that is created on the edge when the resolution of the image signal is scaled up and projected.

1 Select **Super-resolution** from **Image Enhancement**, and then press the [**↵**] button.

2 Use the [**▲**][**▼**] buttons to select the item, and then use the [**◀**][**▶**] buttons to make the adjustments.

Fine Line Adjust: If this parameter is set to a positive value, details such as hair or fabric patterns will be enhanced.

Soft Focus Detail: If this parameter is set to a positive value, the outline, background, and the other main parts of the objects in the image will be enhanced to show them clearly.

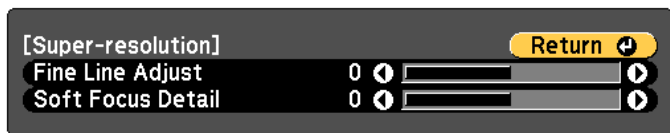

[Esc] / [**↵**]:Return [**◀**]:Select [Menu]:Exit

3 Press the [Esc] button to return to the previous screen.

Detail Enhancement

You can enhance the contrast in detailed areas of an image to create a more emphatic texture and material feel.

1 Select **Detail Enhancement** from **Image Enhancement**, and then press the [**↵**] button.

2 Use the [**▲**][**▼**] buttons to select the item, and then use the [**◀**][**▶**] buttons to make the adjustments.

Strength: The larger the value, the more the contrast is enhanced.

Range: The larger the value, the wider the range of detail enhancement becomes.

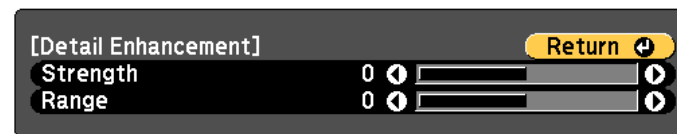

[Esc] / [**↵**]:Return [**◀**]:Select [Menu]:Exit



Depending on the image, a highlight may be noticeable at the border between colors. If this bothers you, set a smaller value.

3 Press the [Esc] button to return to the previous screen.

Projecting 3D Images

By using two projectors, you can project passive 3D images. The following are required to project and view 3D images.

- Polarizer
- Passive 3D glasses
- Mount for stacking

- Silver screen for passive 3D



This projector arranges the direction of polarizing projection for R (red), G (green), and B (blue). It is not necessary to inverse left and right eye G (green) image signals.



Useful Functions

This section describes the Multi-Projection, Split Screen, Memory, Schedule, and Security functions.

You can setup up to 9 projectors to project one large and wide image. You can adjust the difference of brightness and color tone between each projected image to create a seamless screen.



- Set **4K Enhancement** to **Off**. (EB-L1075U/EB-L1070U/EB-L1065U/EB-L1060U/EB-L1050U only)
- We recommend setting the focus, zoom, and lens shift at least 20 minutes after you start the projection, because images are not stable right after turning on the projector.
- If the values for **Geometry Correction** are large, the image position adjustment for overlapping images becomes difficult.
- The Test Pattern can be displayed to adjust the projection status without connecting video equipment.
 - ☛ "Displaying the Test Pattern" [p.33](#)
- If you project a dot by dot image that can be projected without being enlarged or reduced, you can make adjustments precisely.
- When **Run Periodically** is set to **On** in Light Source Calibration, calibration is automatically performed, and colors adjusted using multi-projection may change. Set this to **Off** to maintain the projected image as it is.
 - ☛ **Reset - Light Source Calibration - Run Periodically** [p.162](#)

Adjustment Procedure

Advance preparation

- (1) Turn on all projectors.
- (2) Set an ID for all projectors and the remote controls.
 - ☛ "Set the projector ID" [p.42](#)

Adjusting the projected position

- (1) Adjust the position (angle) of the projector.
 - ☛ "Installation Settings" [p.31](#)
- (2) Adjust the arrangement of the images.
 - ☛ "Tiling" [p.90](#)

Adjusting the projected images

- (1) Adjust the aspect ratio of the images.
 - ☛ "Screen Settings" [p.32](#)
 - ☛ "Changing the Aspect Ratio of the Projected Image" [p.80](#)
- (2) Adjust the lens shift.
 - ☛ "Adjusting the Position of the Projected Image (Lens Shift Adjustment)" [p.34](#)
- (3) Adjust the zoom and focus.
 - ☛ "Adjusting the Image Size" [p.37](#)
 - ☛ "Correcting the Focus" [p.38](#)
- (4) Adjust small differences in the images.
 - ☛ "Point Correction" [p.74](#)
- (5) Adjust the edges of the images.
 - ☛ "Edge Blending" [p.91](#)
 - ☛ "Black Level" [p.93](#)
- (6) Adjust the brightness and tint of the images.
 - ☛ "Color Matching" [p.96](#)
- (7) Select the sections of the images.
 - ☛ "Displaying a Scaled Image" [p.97](#)

Tiling

When using multiple projectors to create one large image, assign a projection position to each projector.

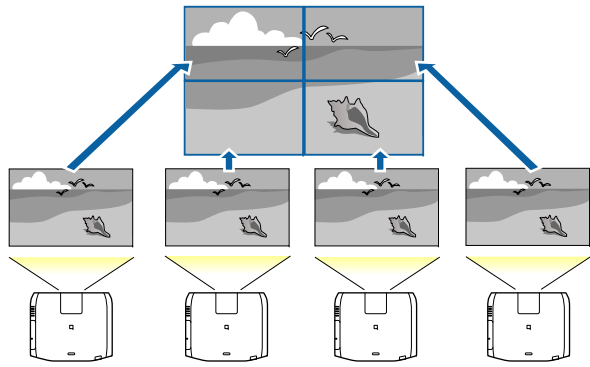

Before performing tiling, adjust the projected image so that it is a rectangle. Also, adjust the size and focus of the images.

- ☛ "Adjusting the Image Size" [p.37](#)
- ☛ "Correcting the Focus" [p.38](#)

- 1** Press the [Menu] button while projecting.
- 2** Select **Multi-Projection** from **Extended**, and then press the [↵] button.
- 3** Select **Tiling**, and then press the [↵] button.
- 4** Select **Layout**, and then press the [↵] button.
 - (1) Set the number of projectors in **Row** and **Column**.
 - (2) Select **Settings**, and then press the [↵] button.
- 5** Repeat steps 1 to 4 for each projector to be used for tiling.

- 6** Select **Location Setup**, and then press the [↵] button.

- (1) Set the positions of the projected images in **Row Order** and **Column Order**.

Row Order: Place screens from top to bottom in the order of 1, 2, 3.

Column Order: Place screens from left to right in the order of A, B, C.

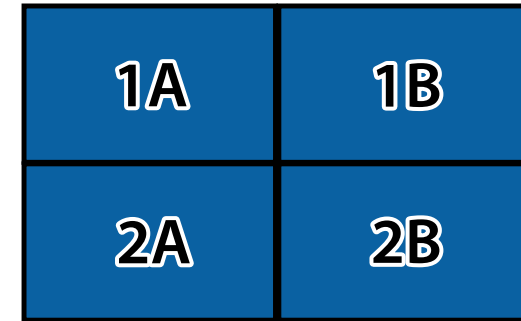

- (2) Select **Settings**, and then press the [↵] button.

- 7** Repeat step 6 for each projector.
- 8** Input the image signal to display the image.
 - ☛ "Automatically Detecting Input Signals and Changing the Projected Image (Source Search)" [p.61](#)

When tiling is complete, adjust any positional gaps and the tint of the projected images.

- ☛ "Adjusting the projected images" [p.90](#)

Edge Blending

You can fine tune the overlapping areas to make seamless screen.

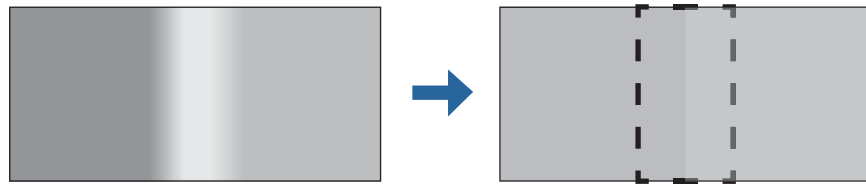

 Before performing edge blending to raise the precision of adjustments, press the [Color Mode] button on the remote control, and then set **Color Mode** to **Multi-Projection**.

- 1** Press the [Menu] button while projecting.
- 2** Select **Multi-Projection** from **Extended**.
- 3** Select **Edge Blending**, and then press the [↵] button.

The following screen is displayed.

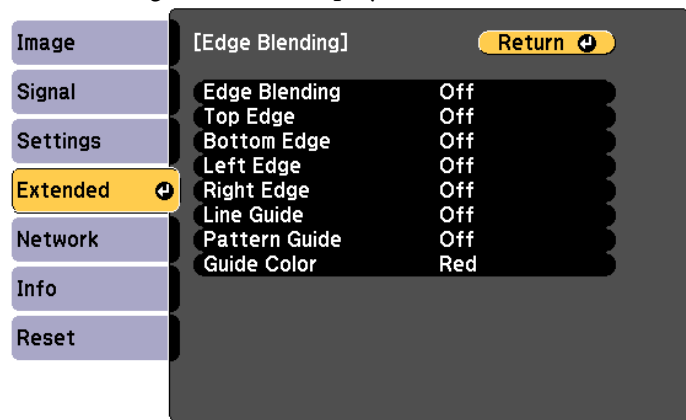

[Esc] / [⏪]:Return [↵]:Select [Menu]:Exit

Submenu	Function
Edge Blending	Set to On to activate Edge Blending. Set to Off when not projecting from multiple projectors.

Submenu	Function
Top Edge/Bottom Edge/Left Edge/Right Edge	<p>Blending: Set to On to activate Edge Blending towards your settings, and the blend range will be shaded.</p> <p>Blend Start Position: Displays blending start position as a red line, and adjusts at the level of one pixel.</p> <p>Blend Range: Adjusts the range to be shaded. Adjustment is possible at the level of one pixel. The maximum range is 45% of the resolution.</p> <p>Blend Curve: Select how to apply shading.</p>
Line Guide	Set to On to display a guide on the Edge Blending setting range.
Pattern Guide	Set to On to display a lattice pattern to match the position of the Edge Blending setting range.
Guide Color	Select a combination of guide colors.

- 4** Turn on Edge Blending.
 - (1) Select **Edge Blending**, and then press the [↵] button.
 - (2) Select **On**, and then press the [↵] button.
 - (3) Press the [Esc] button.
- 5** Set **Line Guide** to **On**.
 - (1) Select **Line Guide**, and then press the [↵] button.
 - (2) Select **On**, and then press the [↵] button.
 - (3) Press the [Esc] button.

 If the guide is not clear, you can change the color of the guide in **Guide Color**.

6 Set **Pattern Guide** to **On**.

- (1) Select **Pattern Guide**, and then press the [**↵**] button.
- (2) Select **On**, and then press the [**↵**] button.
- (3) Press the [Esc] button.

7 Set **Top Edge**, **Bottom Edge**, **Left Edge**, or **Right Edge** according to the parts of the image that are overlapped.

The following shows how to set screen (1) as an example.

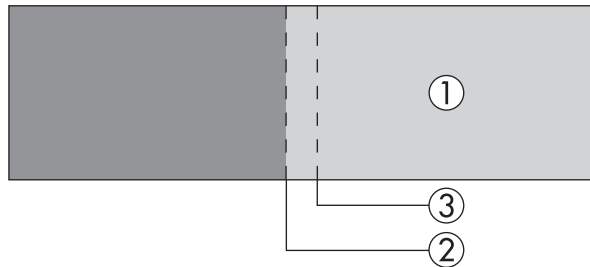

In the example above, you need to adjust the **Left Edge** because you can see the overlapping areas on the left side of the image (1).

- (1) Select **Left Edge**, and then press the [**↵**] button.
- (2) Select **Blending**, and then press the [**↵**] button.
- (3) Select **On**, and then press the [**↵**] button.
- (4) Press the [Esc] button.
- (5) In **Blend Start Position**, align the blending start position with the edge (2) of the image.
- (6) Press the [Esc] button.
- (7) In **Blend Range**, adjust the range (3) to be shaded.
The value for when the overlapped range and the guide are in the same position is the best.
- (8) In **Blend Curve**, adjust how to apply shading.
- (9) Press the [Esc] button.

8 After the settings are complete, set **Line Guide** and **Pattern Guide** to **Off** to finish.

Black Level

When a black image is displayed, only areas where the images overlap stand out. The black level function allows you to match the brightness and tone for areas where the images do not overlap with areas where the images overlap, to make the difference less noticeable.

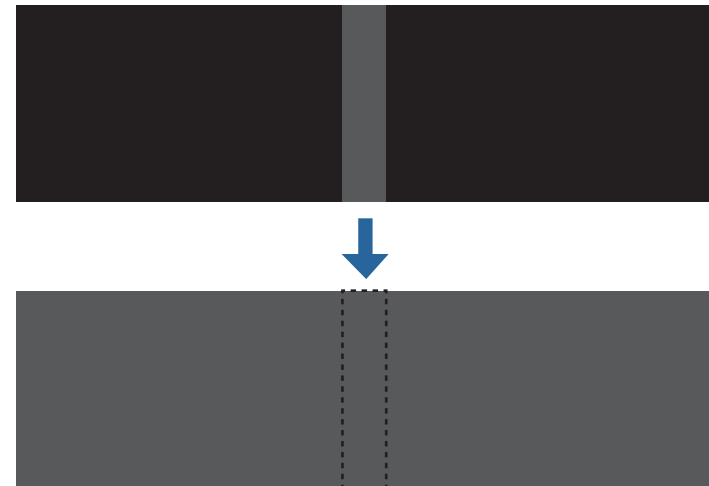

- You cannot adjust the Black Level when a test pattern is displayed.
- If the **Geometry Correction** value is large, you may not be able to adjust correctly.
- The brightness and tone may differ in areas where the images overlap as well as in other areas even after performing black level adjustment.
- If you change the **Top Edge/Bottom Edge/Right Edge/Left Edge** setting, the Black Level is returned to its default value.
☞ "Edge Blending" p.91

- 1 Select **Black Level** from **Multi-Projection**, and then press the [↵] button.

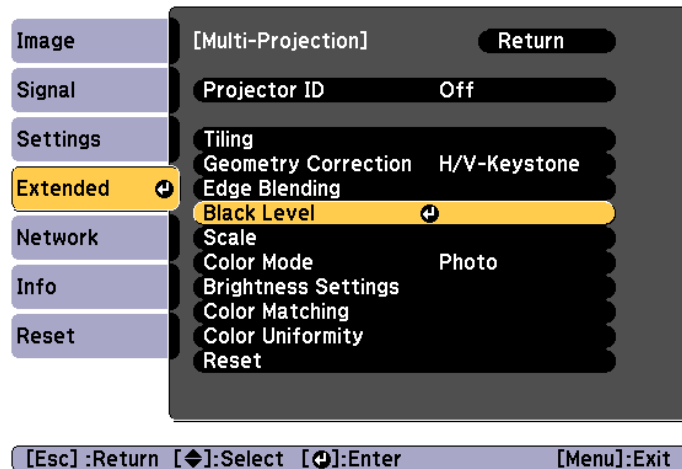

- 2 Select **Color Adjustment**, and then press the [↵] button.

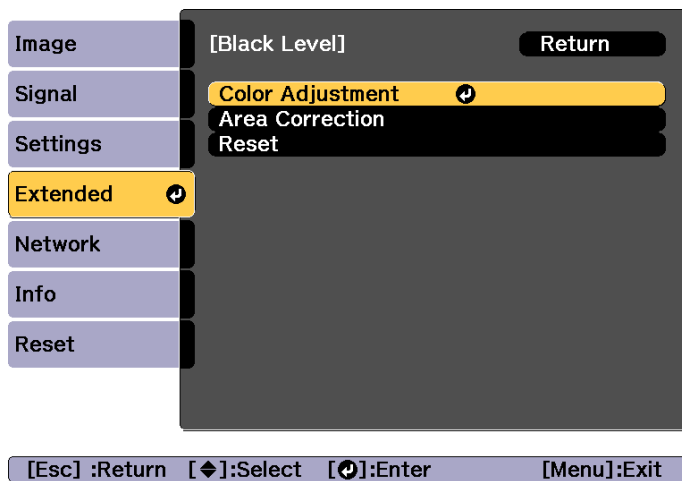

The areas are displayed based on the settings for **Top Edge/Bottom Edge/Right Edge/Left Edge**.

- 3 Select the area you want to adjust, and then press the [↵] button.

The selected area is displayed in orange.

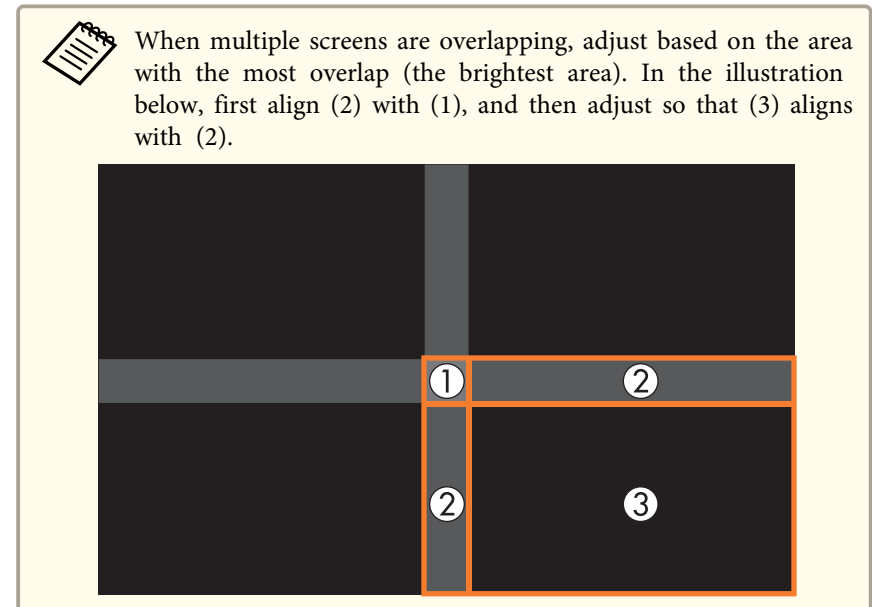

- 4 Adjust the black tone and brightness.

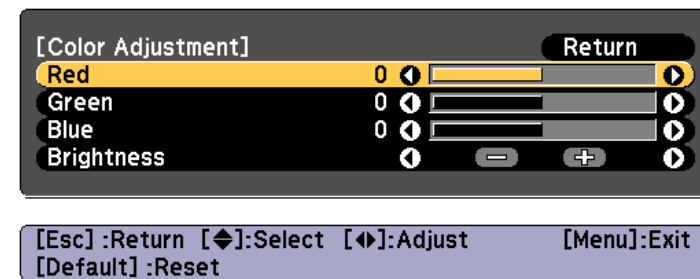

- 5 Repeat steps 3 and 4 as needed to adjust any remaining parts.



After this, if the tone for some areas do not match, adjust them by **Area Correction**.

- 6** Press the [Esc] button, to return to the screen displayed in step 2.

- 7** Select **Area Correction**, and then press the [**↵**] button.

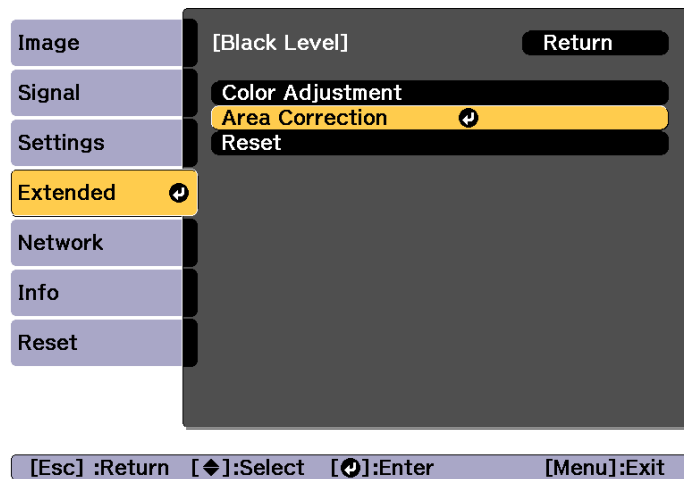

- 8** Select **Start Adjustments**, and then press the [**↵**] button.

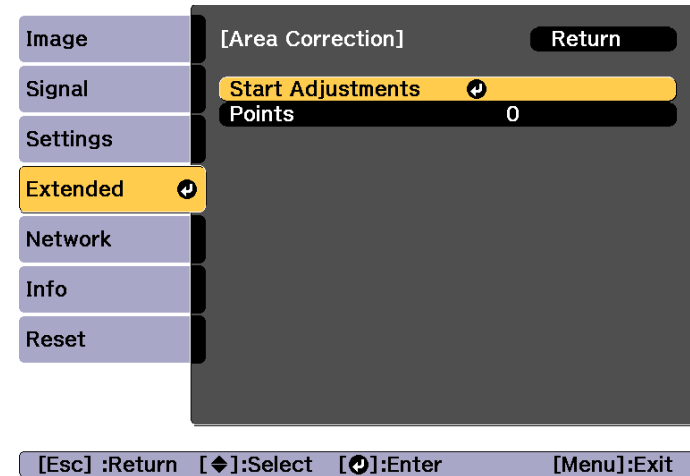

Boundary lines that indicate areas where images overlap are displayed.

The boundary lines are displayed based on the settings for **Top Edge/Bottom Edge/Right Edge/Left Edge**.

- 9** Use the [**▲**][**▼**][**◀**][**▶**] buttons to select a boundary line of the area you want to adjust.

The selected line is displayed in orange.



- 10** Press the [**↵**] button to confirm the selection.



11 Use the [▲][▼][◀][▶] buttons to adjust the boundary line positions, and then press the [↵] button.

12 Press the [▲][▼][◀][▶] buttons to select the point you want to move, and then press the [↵] button.

The selected point is displayed in orange.

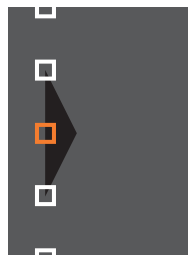

13 Press the [▲][▼][◀][▶] buttons to move the point.

To continue to move another point, press the [Esc] button to return to step 12, and then repeat steps 12 and 13.

To adjust another boundary line, press the [Esc] button until the screen for selecting a boundary line from step 9 is displayed.



To return **Black Level** to its default value, press the [Esc] button to return to the screen from step 7, select [Reset], and then press the [↵] button.

14 To complete the adjustment, press the [Menu] button.

Color Matching

You can fine tune the color balance and brightness from black to white for each color tone.

1 Select **Color Matching** from **Multi-Projection**, and then press the [↵] button.

The following screen is displayed.

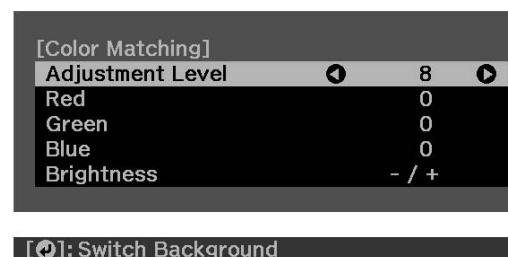

Half of the overlapped area is displayed in black so that it is easy to check the edge of the image.

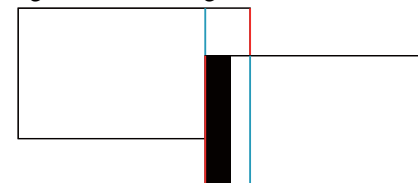







Adjustment Level: There are eight levels from white, through gray, and up to black. You can adjust each level individually.

Red, Green, Blue: Adjusts the tone for each color.

Brightness: Adjusts the image brightness.



Whenever the [] button is pressed, the screen changes between the projected image and the adjustment screen.

- 2** Select **Adjustment Level**, and then use the [][] buttons to set the adjustment level.
- 3** Select **Red**, **Green**, or **Blue**, and then press the [][] buttons to adjust the color tone.
- 4** Select **Brightness**, and then use the [][] buttons to adjust the brightness.
- 5** Return to step 1 and adjust each level.
- 6** Press the [Esc] button to return to the previous screen.

Displaying a Scaled Image

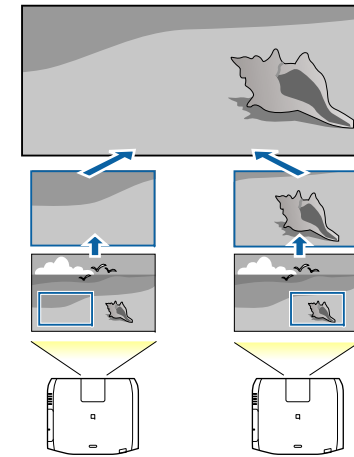

A section of the image is cropped and displayed. This allows you to create one large image by combining images projected from multiple projectors.



- 1** Project the image, and then press the [Menu] button.
- 2** Select **Multi-Projection** from **Extended**.



You can also perform the same operation from **Scale in Signal**.

- 3** Select **Scale**, and then press the [] button.
- 4** Turn on **Scale**.
 - (1) Select **Scale**, and then press the [] button.
 - (2) Select **Auto** or **Manual**, and then press the [] button.

Auto: Automatically adjusts the clipped area according to the adjustment values in Edge Blending and Tiling. You do not need to perform any steps after step 6.

Manual: Allows you to adjust the clipped area manually.
 - (3) Press the [Esc] button to return to the previous screen.



If auto adjustment does not work for the clipped image, adjust the aspect ratio, and then select **Auto**.

☛ "Changing the Aspect Ratio of the Projected Image" p.80

5 Set **Scale Mode**.

- (1) Select **Scale Mode**, and then press the [↵] button.
- (2) Select **Zoom Display** or **Full Display**, and then press the [↵] button.

Zoom Display: Adjusts according to the image currently displayed.

Enlarge



Move



Full Display: Adjusts according to the projector's panel size (the maximum area in which an image can be displayed).

Enlarge



Move



- (3) Press the [Esc] button to return to the previous screen.

6 Adjust the scale.

Select the adjustment method with the [▲][▼] buttons, then adjust using the [◀][▶] buttons. (Minimum magnification of 0.5 to maximum magnification of 10)

-+: Enlarges or reduces an image horizontally and vertically at the same time.

Scale Vertically: Enlarges or reduces an image vertically.

Scale Horizontally: Enlarges or reduces an image horizontally.

7 The image is clipped and adjusted.

- (1) Select **Clip Adjustment**, and then press the [↵] button.
If you select **Clip Range**, the range and coordinates of the image that the projector will project is displayed.
- (2) Use the [▲], [▼], [◀], and [▶] buttons to scroll the image.
Adjust the coordinates and size of each image while viewing the screen.
- (3) Press the [Menu] button to finish making settings.



You can check the displayed area after clipping for the entire image from **Clip Range**.

Projecting Two Images Simultaneously (Split Screen)

You can simultaneously project images from two sources on the right and left of the screen.

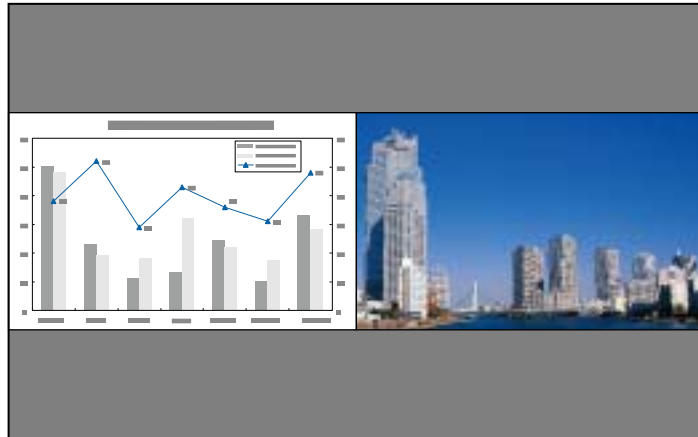

You cannot use the Split Screen feature in Content Playback mode.

Input Sources for Split Screen Projection

The combinations of input sources that can be projected on a split screen are listed below.

Left Screen	Right Screen					
	HDMI	HDBa-seT	DVI-D	Com-puter	BNC	LAN
HDMI	-	✓	✓	✓	✓	✓
HDBaseT	✓	-	✓	✓	✓	✓
DVI-D	✓	✓	-	✓	✓	✓
Computer	✓	✓	✓	-	-	-
BNC	✓	✓	✓	-	-	-
LAN	✓	✓	✓	-	-	-



- Signals with a horizontal resolution that exceeds 1920 are not supported.
- If **4K Enhancement** is enabled, a message is displayed. Select **Yes** to disable **4K Enhancement**. (EB-L1075U/EB-L1070U/EB-L1065U/EB-L1060U/EB-L1050U only)
 - ☛ **Image - Image Enhancement - 4K Enhancement** [p.140](#)

Operating procedures

Projecting on a split screen

- 1 Press the [Split] button on the remote control while projecting. The currently selected input source is projected on the left of the screen.

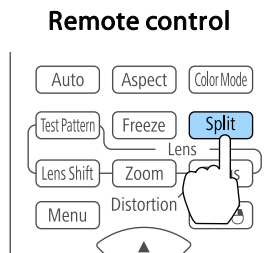

You can perform the same operations from the configuration menu.

☛ [Settings - Split Screen p.143](#)

- 2 Press the [Menu] button. The Split Screen Setup screen is displayed.

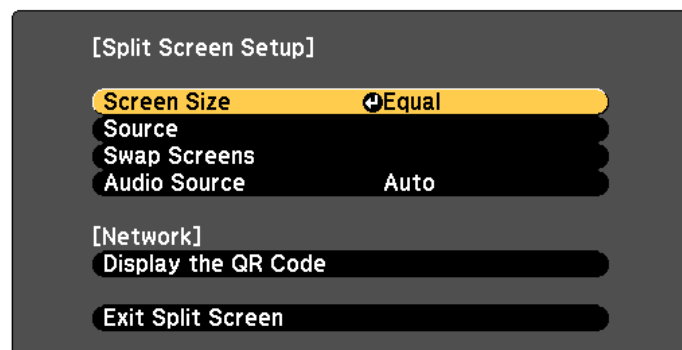

[↔]:Select [↵]:Enter [Menu]:Exit

- 3 Select **Source**, and then press the [↵] button.
- 4 Select each input source for **Left** and **Right**.

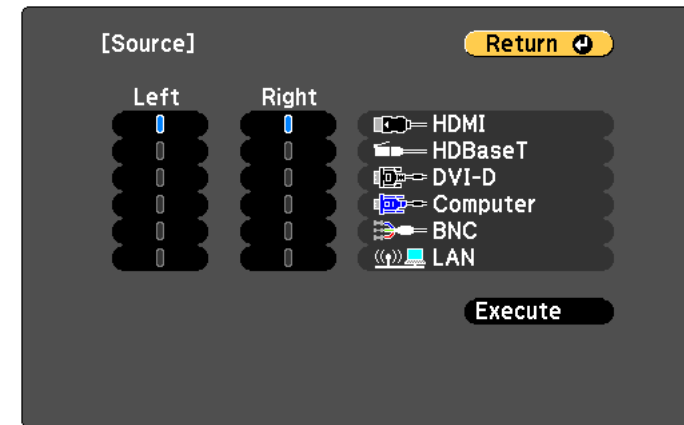

[Esc] / [↵]:Return [↔]:Select [Menu]:Exit



You can perform the same operations using the following procedure.

- ☛ "Automatically Detecting Input Signals and Changing the Projected Image (Source Search)" [p.61](#)
- ☛ "Switching to the Target Image by Remote Control" [p.62](#)

- 5 Select **Execute**, and then press the [↵] button. To switch the source during split screen projection, start the procedure from step 2.

Switching the left and right screens

Use the following procedure to switch the projected images.

- 1** Press the [Menu] button during split screen projection.
- 2** Select **Swap Screens**, and then press the [↵] button.
The projected images on the left and right are swapped.



Switching the left and right image sizes

- 1** Press the [Menu] button during split screen projection.
- 2** Select the **Screen Size**, and then press the [↵] button.
- 3** Select the screen size you want to display, and then press the [↵] button.

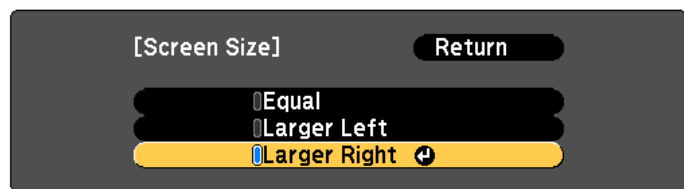

[Esc] :Return [↕]:Select [↵]:Set [Menu]:Exit

The projected images will appear as shown below after setting the screen size.

Equal

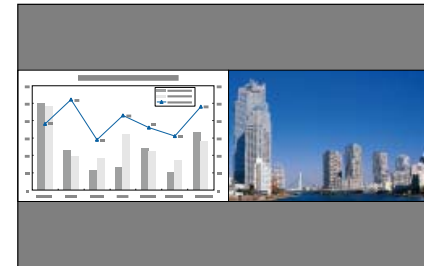

Larger Left

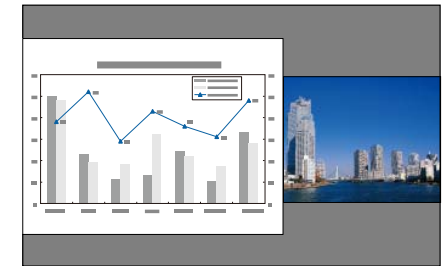

Larger Right

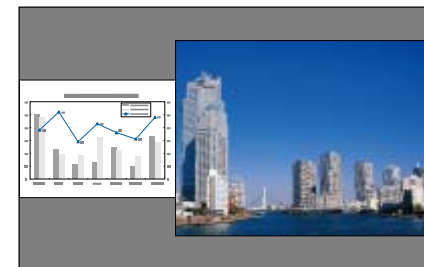

- You cannot enlarge both the left screen and right screen images at the same time.
- When one image is enlarged, the other image is reduced.
- Depending on the video signals that are input, the images on the left and right may not appear to be the same size even if **Equal** is set.

Changing the audio

- 1** Press the [Menu] button during split screen projection.
- 2** Select **Audio Source**, and then press the [↵] button.

- 3 Select the audio you want to output, and then press the [↵] button.

When you select **Auto**, audio is output for the enlarged screen. If the screen sizes are **Equal**, audio is output for the screen on the left.

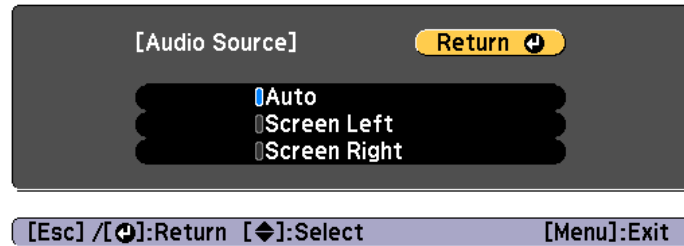

Ending the split screen

Press the [Esc] button to end split screen.

The following steps can also be used to end the split screen.

- Press the [Split] button on the remote control.
- Select **Exit Split Screen** on the Split Screen Setup screen.  [p.100](#)

Restrictions during split screen projection

Operating restrictions

The following operations cannot be performed during split screen projection.

- Setting the configuration menu
- E-Zoom
- Changing the aspect mode
- Using the [User1], [User2], or [User3] button on the remote control
- Help can be displayed only when image signals are not input or when an error or warning notification is displayed.
- The user's logo is not displayed.

Restriction relating to images

- For the image on the right screen, the default values for the **Image** menu are applied. However, the settings for the image projected on the left screen are applied to the image on the right screen for **Color Mode**, **Color Temp.**, **Frame Interpolation**, and **Super-resolution**.
- **Deinterlacing** and **Noise Reduction** are only enabled for the left screen.

Hiding the Image and Sound Temporarily (A/V Mute)

You can use this when you want to focus the audience's attention on what you are saying, or if you do not want to show details such as when you are changing between files during presentations from a computer.

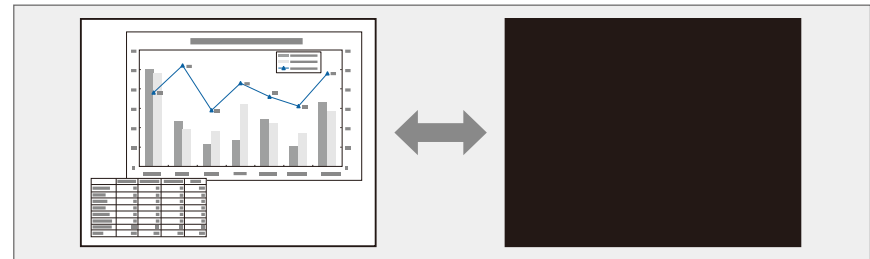

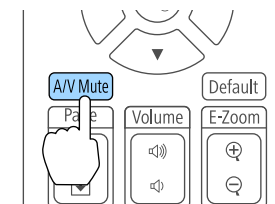

Each time you press the [A/V Mute] button, A/V Mute turns on or off.

Remote control





- When A/V Mute is enabled, the light source turns off.
- If you want to fade out or fade in when turning the video on or off, set the desired number of seconds in **Fade-out** and **Fade-in**.
 **Extended - Operation - A/V Mute Settings - Fade-out, Fade-in p.146**
- When A/V mute is activated and no operations are performed for about 2 hours, the projector turns off automatically. If you do not want to turn off the power, set **A/V Mute Timer** to **Off**.
 **Extended - Operation - A/V Mute Settings - A/V Mute Timer p.146**
- When **A/V Mute Release** is set to **A/V Mute** from the configuration menu, the following operations can still be performed without releasing A/V mute.
 - Change the source with the change input buttons on the remote control.
 - Control the projector from a computer using communication commands. **Extended - Operation - A/V Mute Settings - A/V Mute Release p.146**
 A/V mute is only released by pressing the [A/V Mute] button, or by sending an A/V mute Off command.
- When projecting moving images, the images and sound continue to be played back while A/V Mute is on. It is not possible to resume projection from the point where A/V Mute was activated.

Freezing the Image (Freeze)

When Freeze is activated on moving images, the frozen image continues to project on the screen, so you can project a moving image one frame at a time like a still photo. Also, you can perform operations such as changing between files during presentations from a computer without projecting any images if the Freeze function is activated beforehand.

Each time you press the [Freeze] button, Freeze turns on or off.

Remote control

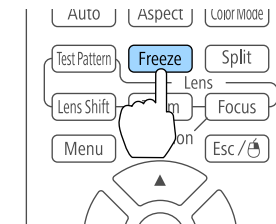

- Audio does not stop.
- When projecting moving images, the images continue to be played back while the screen is frozen. It is not possible to resume projection from the point where the screen was frozen.
- If the [Freeze] button is pressed while the Configuration menu or the Help screen is displayed, the menu or the Help screen that is displayed is closed.
- Freeze still works while E-Zoom is being used.

Enlarging Part of the Image (E-Zoom)

This is useful when you want to expand images to see them in greater detail, such as graphs and tables.

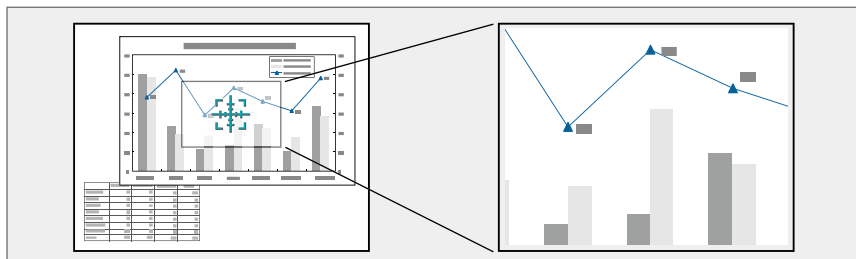

1 Start E-Zoom.

Press the [⊕] button to display the Cross (⊕).

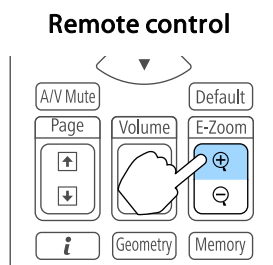

2 Move the Cross (⊕) to the area of the image that you want to enlarge.

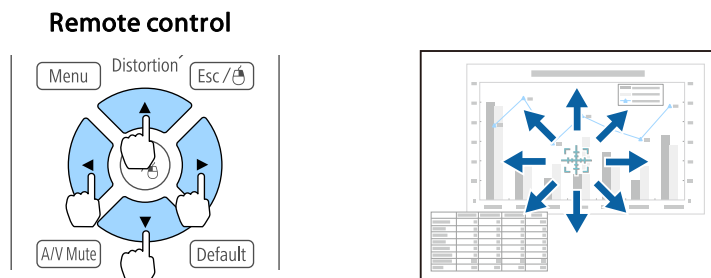

3 Enlarge.

Remote control

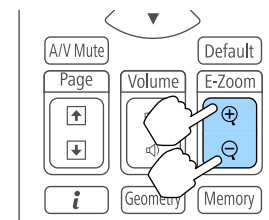

[⊕] button: Expands the area each time it is pressed. You can expand quickly by holding the button down.

[⊖] button: Reduces images that have been enlarged.

[Esc] button: Cancels E-Zoom.



- During enlarged projection, press the [▲], [▼], [◀], or [▶] buttons to scroll the image.
- E-Zoom is unavailable when **Scale** is on.
 🖱 **Signal - Scale** p.142
- If **4K Enhancement** is enabled, a message is displayed. Select **Yes** to disable **4K Enhancement**. (EB-L1075U/EB-L1070U/EB-L1065U/EB-L1060U/EB-L1050U only)
 🖱 **Image - Image Enhancement - 4K Enhancement** p.140

Saving a User's Logo

You can save the image that is currently being projected as a User's Logo.



- When **User's Logo Protection** from **Password Protection** is set to **On**, a message is displayed and the User's Logo cannot be changed. Perform operations after setting **User's Logo Protection** to **Off**.
 🖱 "Managing Users (Password Protection)" p.115
- If you use the batch setup function to copy menu settings between multiple projectors, the User's Logo is also copied. Do not set images that you do not want to share across multiple projectors as the User's Logo.

- 1 Project the image you want to save as the User's Logo, and then press the [Menu] button.

☛ "Configuration Menu Operations" [p.136](#)

- 2 Select **User's Logo** from **Extended**.



When you select **User's Logo**, settings such as Geometry Correction, E-Zoom, Aspect, Scale, and Screen Type are temporarily disabled.

- 3 Select **Start Setting**, and then press the [↵] button.

The confirmation screen is displayed.

- 4 Select **Yes**, and then press the [↵] button.

- 5 When the message "Save this image as the User's Logo?" is displayed, select **Yes**.

The image is saved. After the image has been saved, the message "Completed." is displayed.



Select **Reset** to delete the image you registered and return to the default settings.

Content Playback mode allows you to project images suitable for digital signage in locations such as museums, showrooms, and stores. You can project playlists of photos and videos stored in an external memory. You can use the effects features to change the color and shape of the projected image.



The Content Playback feature uses the USB-A port; this means that you cannot use the wireless LAN feature at the same time.

- 3 Select **On**, and then press the [**↵**] button.
A confirmation message is displayed.
- 4 Restart the projector to enable Content Playback mode.
- 5 Press the [**🏠**] button on the control panel or the remote control.
The Home screen is displayed.
- 6 Check that Content Playback mode is enabled.

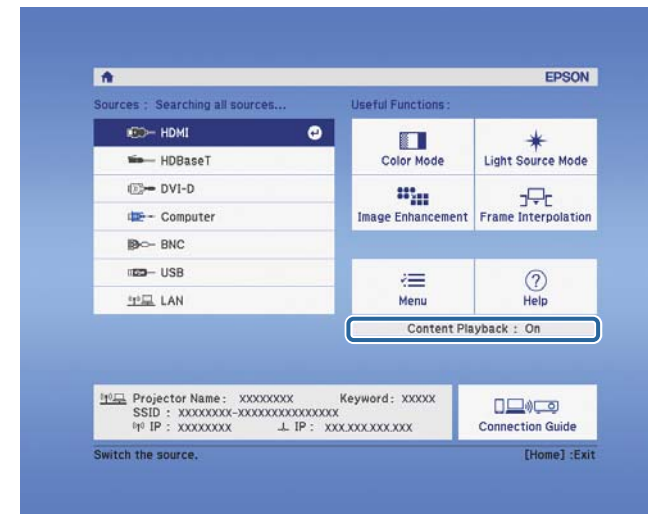

Switching to Content Playback Mode

Switch to Content Playback mode to play a playlist.

- 1 Press the [Menu] button while projecting.
- 2 Select **Content Playback** from **Settings**.

Playing a Playlist

Content Playback mode allows you to project photos and videos that have been saved as playlists.

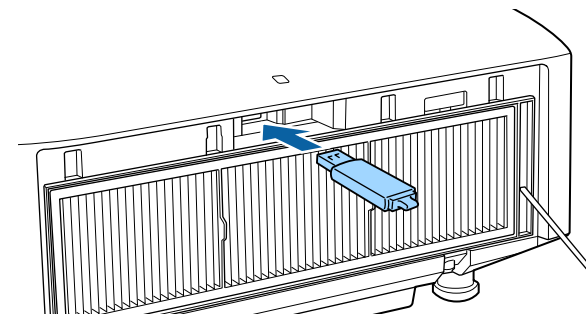
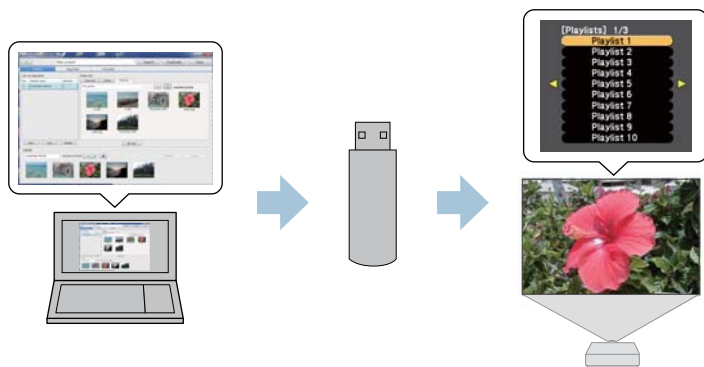

- You need to assign **USB** to a User Button in advance.
 ☛ **Settings - User Button** p.143
- The USB flash drive must meet the following requirements.
 - Formatted as FAT 16/32
 - Only one partition
 - No security features enabled
 - Do not use a multi-card reader or USB hub
 - Total length of USB flash drive is 6 cm or less

1 Create a playlist using Epson Projector Content Manager and save it to a USB flash device.



See the "Epson Projector Content Manager Operation Guide" for details.

2 Connect the USB flash drive to the projector's USB-A port (the wireless LAN module installation section) while Content Playback mode is enabled.

☛ "Installing the Wireless LAN Unit" p.54

3 Press the user button assigned to **USB** on the remote control. The first playlist or the scheduled playlist is played.



- Press the numeric buttons while holding down the [Num] button to play a playlist that has been registered to your favorites. You can register favorites using Epson Projector Content Manager.
- To select a playlist to play from the list, select **USB Viewer** from the **Settings** menu, and then use the up, down, left, and right buttons to select your file.
 ☛ **Settings - Content Playback - USB Viewer** p.143

Adding Effects to Images (Effect Feature)

In Content Playback mode, you can change the color and shape of the image you are projecting.





When using the Effect feature, you need to run **Refresh Mode** periodically.

☛ **Reset - Refresh Mode** p.162

- 1 Press the [Menu] button while Content Playback mode is enabled, select [Settings], and then press the [↵] button.

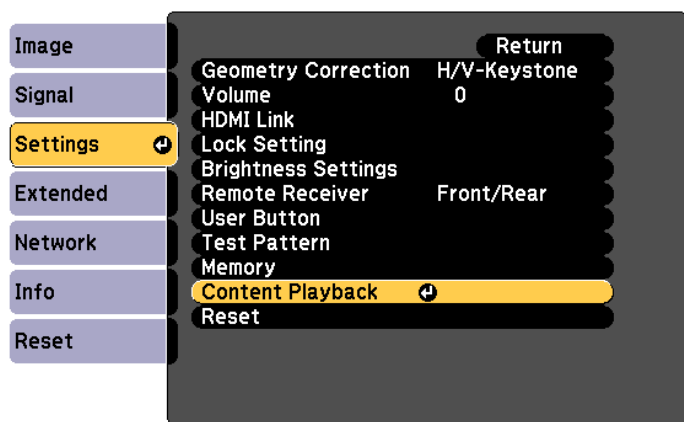

[Esc]:Return [↔]:Select [↵]:Enter [Menu]:Exit

- 2 Select **Overlay Effect** from **Content Playback**, and then press the [↵] button.

- 3 Set **Overlay Effect** to **On**, and then press the [↵] button.

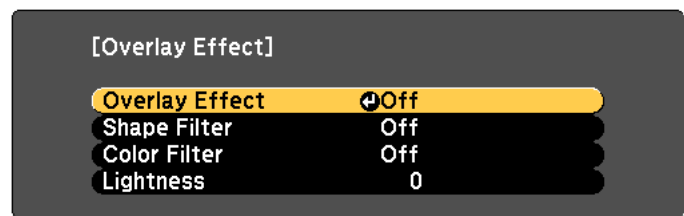

[↔]:Select [↵]:Enter [Menu]:Exit

- 4 Select **Shape Filter**, and then press the [↵] button.

- 5 Adjust the following items as necessary.

- **Shape:** Select the shape of the effect from Circle, Square, or Custom.



You can register your favorite images to Custom using Epson Projector Content Manager. See the "Epson Projector Content Manager Operation Guide" for details.

- **Filter Effect:** Select whether to mask the inside or the outside of the selected shape.
- **Size:** Set the size of the selected shape.
- **Position:** Set the display position of the selected shape.

- 6 Select **Color Filter**, and then press the [↵] button.

- 7 Adjust the following items as necessary.

- **Color Filter:** Select the color of the effect.
- **Custom:** Adjust the **Red**, **Green**, and **Blue**.

- 8 Select **Lightness** to set the brightness of the effect.

- 9 Press the [Menu] button to finish making settings.

Restrictions on Content Playback Mode

Operating restrictions

You cannot change the following operations or settings in Content Playback mode.



- Color Temp. (when **Warm White** or **Cool White** is selected as the **Color Filter**)
- Blanking
- Split Screen
- Display Background
- Screen
- Auto Source Search
- Remote Password
- Edge Blending
- Log Save Destination

Also, you cannot use Epson Projector Professional Tool in Content Playback mode.

The settings for the image currently displayed and values for geometry correction are saved as a memory, allowing you to load them when necessary.

Saving/Loading/Erasing/Resetting the Memory

- 1 Press the [Memory] button while projecting.

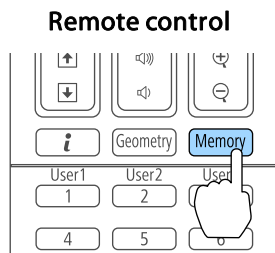

You can also operate from the Configuration menu.

☛ Settings - Memory p.143

- 2 Select a memory type, and then press the [↵] button.

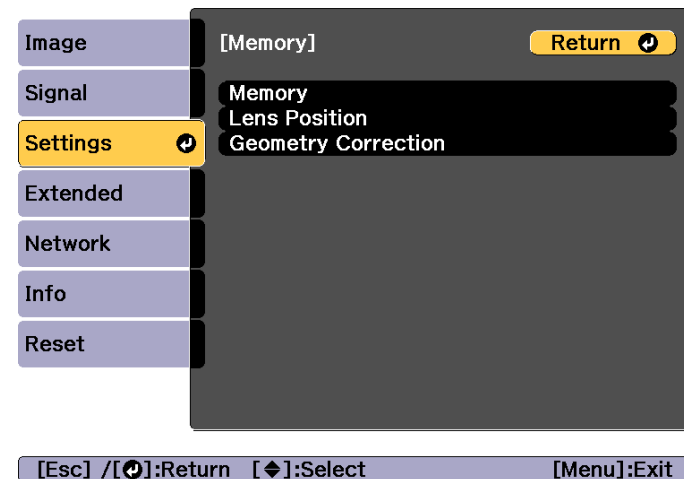

Memory: Settings for the following menu items are saved in the memory. You can register up to 10 values.

Top Menu	Submenu
Image	All setting items
Signal	Scale
Settings	Brightness Settings
Extended	Edge Blending Black Level Color Matching

Lens Position: Registers the position of the lens adjusted using lens shift, zoom, focus, and distortion. You can register up to 10 values. ☛ "Registering and Loading Lens Adjustment Values" p.39

Geometry Correction: Adjustment value of the geometry correction is saved. You can register up to 3 values.

- 3 Select the function you want to perform, then press the [↵] button.

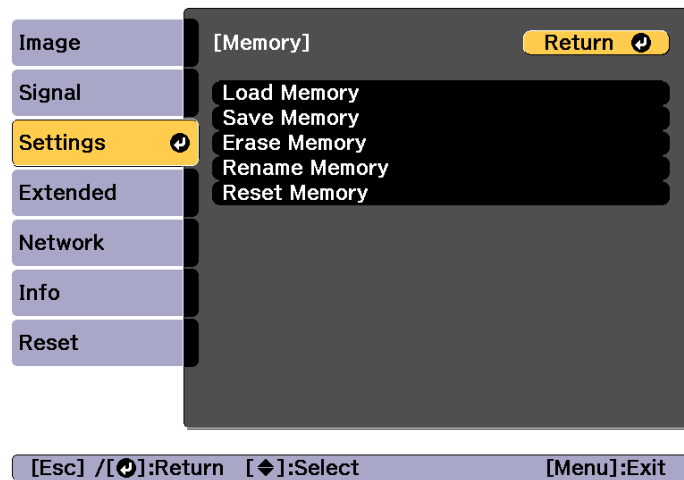

Function	Explanation
Load Memory	Loads the saved memory. When you select a memory and press the [Enter] button, the settings applied to the current image are replaced with the settings from the memory.
Save Memory	Registers current settings in the memory. When you select a memory name and press the [Enter] button, the settings are saved.
Erase Memory	Erases the registered memory. When you select a memory name and press the [Enter] button, a message is displayed. Select Yes , and then press the [Enter] button to erase the selected memory.
Rename Memory	Changes the memory name. Select the memory name you want to change, and then press the [Enter] button. Enter the memory name using the soft keyboard. ☛ "Soft keyboard operations" p.152 When you have finished, move the cursor over Finish , and then press the [Enter] button.

Function	Explanation
Reset Memory	Resets the name and settings of a saved memory. To reset all memories saved in Memory , Lens Position , and Geometry Correction , use Reset All Memories . ☛ Reset - Reset All Memories p.162



If the mark on the left of the memory name is turned blue, it means the memory has already been registered. When you select a registered memory, a message is displayed asking you to confirm that you want to overwrite the memory. If you select **Yes**, the previous settings are deleted and the current settings are registered.

You can schedule turning the projector power on/off and switching the input source, as events in the schedule. Registered events are executed automatically at the specified time on the specified dates or weekly. You can register up to 30 events in **Schedule**, and one event in **Extended Schedule**.

Saving an Event

Setting an Event

- 1 Press the [Menu] button while projecting.
 ☛ "Configuration Menu Operations" [p.136](#)
- 2 Select **Schedule Settings** from **Extended**.
- 3 Select **Add New** from **Schedule**.

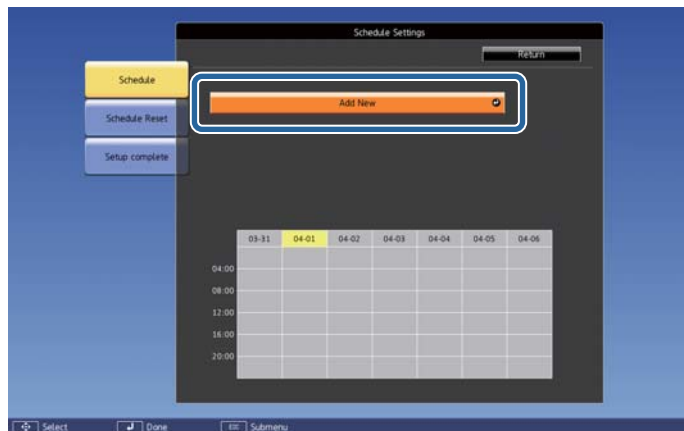

- 4 Set the schedule.

Submenu Name	Function
Event Settings	Select an operation of the projector when the event is executed. Select No Change for items that you do not want to change when the event occurs. You can set the following item operations. Schedule <ul style="list-style-type: none"> • Power • Source • Light Source Mode • A/V Mute • Light Source Calibration • Refresh Mode • Volume
Date / Time Settings	Set the date, day of the week, and time to execute the event. You can set up to four weeks later. Use the soft keyboard to enter the date and time. ☛ "Soft keyboard operations" p.152

- 5 Select **Save**, and then press the [↵] button.
 To register additional events, repeat steps 3 to 5.
- 6 Select **Setup complete**, and then select **Yes** to finish saving.



- Light Source Calibration does not start automatically when the projector is used continuously for more than 24 hours, or when direct shutdown is used regularly. Set **Light Source Calibration** to enable this function after every 100 hours of usage.
- When **Light Source Calibration** is enabled, turn on the projector at least 20 minutes before the event.





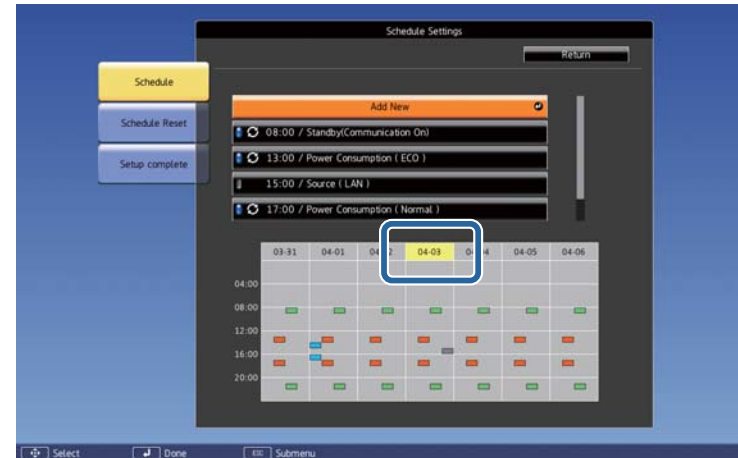

Checking an Event

This section explains how to check a Schedule event.

- 1 Press the [Menu] button while projecting.
- 2 Select **Schedule Settings** from **Extended**.

- 3 Press the [◀][▶] buttons to highlight the date you want to check. The details of the events registered on the selected date are displayed. The indicator turns on when an event is saved.



-  (Blue): Enabled event
-  (Gray): Disabled event
- : Regular event
-  (Aqua): Single event
-  (Orange): Regular event
-  (Green): Communication monitoring On/Off
-  (Gray): Disabled event

Editing an Event

- 1 Press the [Menu] button while projecting.
 "Configuration Menu Operations" [p.136](#)

- 2 Select **Schedule Settings** from **Extended**.
- 3 Use the [◀][▶] buttons to highlight the date containing the event you want to edit.
- 4 Highlight the event you want to edit, and then press the [Esc] button.

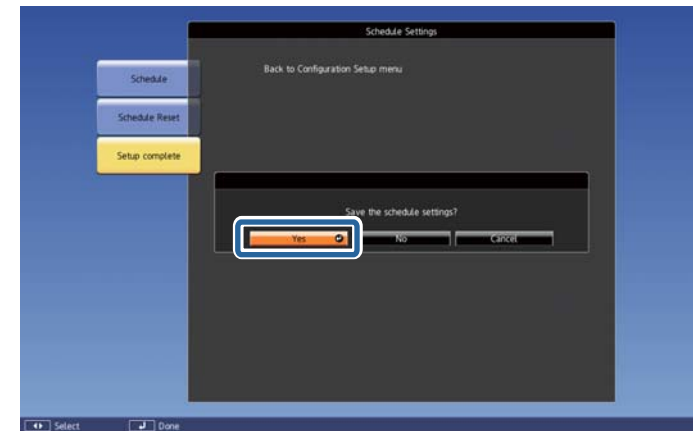
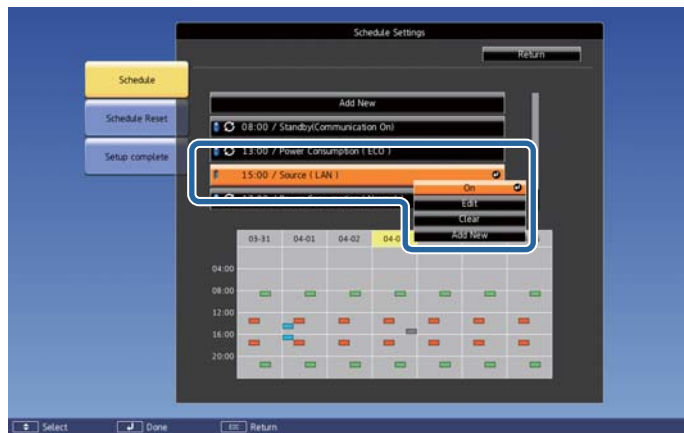

To delete all registered events, select **Schedule Reset**, and then select **Yes**. Select **Setup complete**, and then select **Yes** to delete the events.

- 5 Edit the event.

Submenu Name	Function
On/Disabled	Enable or disable the selected event.
Edit	Edits the content of the selected event. Select Save , and then press the [↵] button to complete the editing.
Clear	Deletes the selected event.
Add New	Saves a new event. Select Save , and then press the [↵] button to complete registering.

- 6 Select **Setup complete**, and then select **Yes** to finish editing.

The projector has the following enhanced security functions.

- **Password Protection**
You can limit who can use the projector.
- **Control Panel Lock/Remote Control Button Lock**
You can prevent people changing the settings on the projector without permission.
☛ "Restricting Operation" [p.117](#)
- **Anti-Theft Lock**
The projector is equipped with the following anti-theft security device.
☛ "Anti Theft/Fall Prevention" [p.119](#)

Managing Users (Password Protection)

When Password Protection is activated, people who do not know the password cannot use the projector to project images even if the projector power is on. Furthermore, the user's logo that is displayed when you turn on the projector cannot be changed. This acts as an anti-theft function as the projector cannot be used even if it is stolen. At the time of purchase, Password Protection is not activated.

Kinds of Password Protection

The following four kinds of Password Protect settings can be made according to how the projector is being used.

- **Power On Protection**
When **Power On Protection** is **On**, you need to enter a preset password after the projector is plugged in and turned on (this also applies to Direct Power On). If the correct password is not entered, projection does not start.

- **User's Logo Protection**

Even if someone tries to change the User's Logo set by the owner of the projector, it cannot be changed. When **User's Logo Protection** is set to **On**, the following setting changes for the User's Logo are prohibited.

- Capturing a User's Logo
- Setting **Display Background** or **Startup Screen** from **Display**
☛ **Extended - Display** [p.146](#)

- **Network Protection**

When **Network Protection** is set to **On**, changing the settings for **Network** is prohibited.

- ☛ "Network Menu" [p.151](#)

- **Schedule Protection**

When **Schedule Protection** is set to **On**, changing settings for the projector's system time or schedules is prohibited.

Setting Password Protection

Use the following procedure to set Password Protect.

- 1** During projection, hold down the [Freeze] button for about five seconds.

The Password Protection setting menu is displayed.

Remote control

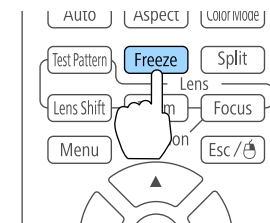



If Password Protection is already activated, you must enter the password.
If the password is entered correctly, the Password Protection setting menu is displayed.

☞ "Entering the password" p.116

- 2 Select the type of Password Protect you want to set, and then press the [↵] button.

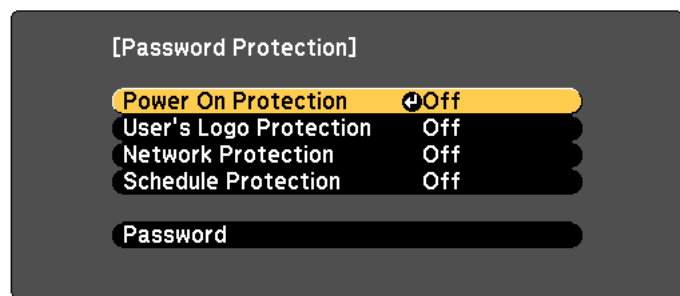

[↔]:Select [⏏]:Enter [Menu]:Exit

- 3 Select **On**, and then press the [↵] button.
Press the [Esc] button to display the screen from step 2.

- 4 Set the password.
 - (1) Select **Password**, and then press the [↵] button.
 - (2) When the message "Change the password?" is displayed, select **Yes** and then press the [↵] button. The default password is set to "0000". Change this to your own desired password. If you select **No**, the screen displayed in step 2 is displayed again.
 - (3) While holding down the [Num] button, enter a four digit number using the numeric buttons. The number entered is displayed as "* * * *". When you enter the fourth digit, the confirmation screen is displayed.

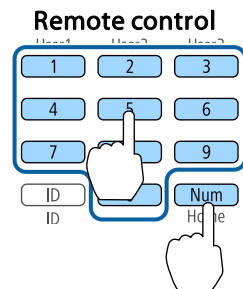

- (4) Re-enter the password.
"Password accepted." is displayed.
If you enter the password incorrectly, a message is displayed prompting you to re-enter the password.

Entering the password

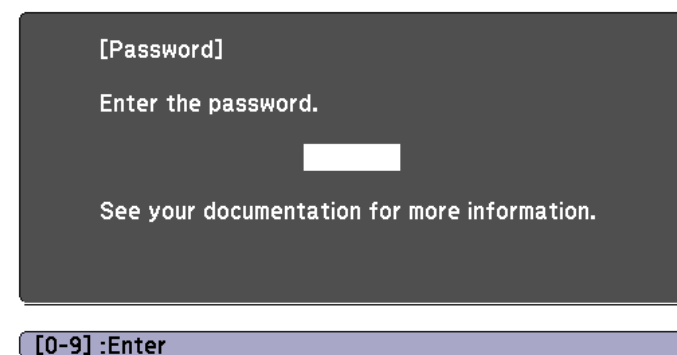

When the password entry screen is displayed, enter the password using the remote control.

While holding down the [Num] button, enter the password by pressing the numeric buttons.



When you enter the correct password, Password Protect is temporarily released.

Attention

- If an incorrect password is entered three times in succession, the message "The projector's operation will be locked." is displayed for approximately five minutes, and then the projector switches to standby mode. If this happens, disconnect the power plug from the electrical outlet and then reinsert it and turn the projector's power back on. The projector displays the password entry screen again so that you can enter the correct password.
- If you have forgotten the password, make a note of the "Request Code: xxxxx" number that appears on the screen and contact the nearest address provided in the Epson Projector Contact List.
 [Epson Projector Contact List](#)
- If you continue to repeat the above operation and input the wrong password thirty times in succession, the following message is displayed and the projector does not accept any more password entries. "The projector's operation will be locked. Contact your nearest Epson service center."
 [Epson Projector Contact List](#)

Restricting Operation

The following three kinds of operation restriction functions are available with the projector.

- **Control Panel Lock**
This is useful at events or shows when you want to deactivate all buttons during projection or at schools when you want to limit button operation.
- **Lens Lock**
This function deactivates all buttons on the remote control related to the lens operation to prevent improper lens adjustment after it is properly adjusted.
- **Remote control button lock**
This function deactivates buttons except for main buttons needed for basic remote control operation, to prevent mistakes in operations.

Control Panel Lock

Perform one of the following to lock the operation buttons on the control panel. Even if the control panel is locked, you can still use the remote control as usual.

- **Full Lock**
All of the buttons on the control panel are locked. You cannot perform any operations from the control panel, including turning the power on or off.
- **Partial Lock**
All of the buttons on the control panel, except for the [⏻] button, are locked.

- 1** Press the [🔒] button on the control panel during projection to display the Control Panel Lock screen.



You can also make settings in **Control Panel Lock** from the configuration menu.

 [Settings - Lock Setting - Control Panel Lock p.143](#)

- 2** Select either **Full Lock** or **Partial Lock** according to your purpose.

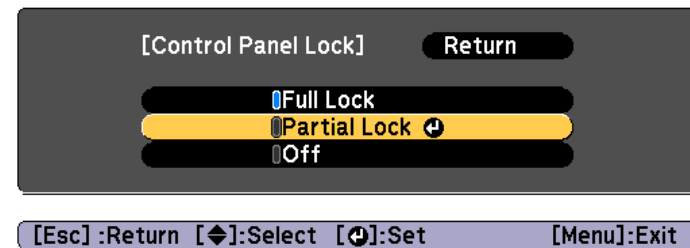

- 3** Select **Yes** when the confirmation message is displayed. The control panel buttons are locked according to the setting you chose.



You can release the control panel lock by one of the following two methods.

- Use the remote control to set **Control Panel Lock** to **Off** from the configuration menu.
 - ☛ **Settings - Lock Setting - Control Panel Lock p.143**
- Press and hold down the [] button on the control panel for about seven seconds, a message is displayed and the lock is released.

Lens Lock

This function locks the following buttons on the remote control related to the lens operation.

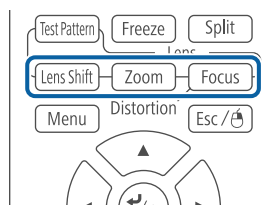



Set the **Lens Lock** to **On** in the Configuration menu.

☛ **Settings - Lock Setting - Lens Lock p.143**

Remote control button lock

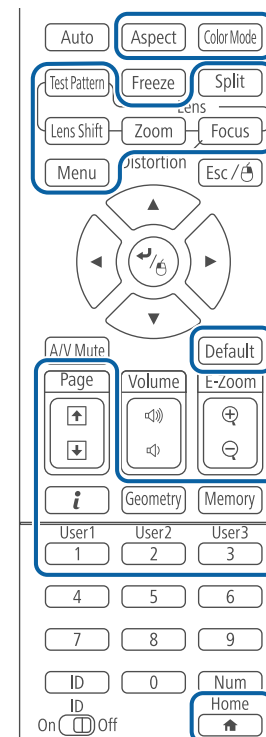
This function locks the following buttons on the remote control.



Each time the [] button is pressed for approximately 5 seconds, the remote control button lock turns on or off.

Remote control

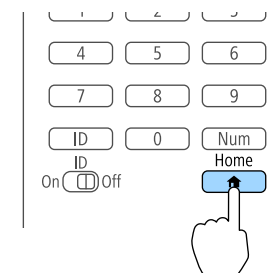



Even if the remote control button lock is on, the following operations are possible.

- Resetting default for the Remote Receiver setting
- Releasing the remote control button lock

Anti Theft/Fall Prevention

The projector is equipped with the following types of anti-theft security devices.

- Security slot

The security slot is compatible with the Microsaver Security System manufactured by Kensington.

See the following for more details on the Microsaver Security System.

☞ <http://www.kensington.com/>

- Security cable installation point

A commercially available theft-prevention wire lock can be passed through the installation point to secure the projector to a desk or pillar. See the documentation supplied with the wire lock for locking instructions.

You can also attach a safety wire to secure the projector and the ceiling mount to prevent it from falling.



Using the Projector on a Network

Follow the instructions in these sections to set up your projector for use on a network.

You can send images to your projector through a wired network. To do this, connect the projector to your network, and then set up your projector and computer for network projection.

After connecting and setting up the projector, install Epson iProjection from the EPSON Projector Software CD-ROM (if available) or Web site.

Epson iProjection software sets up your computer for network projection. It also allows you to hold interactive meetings by projecting user's computer screens over a network. See the "Epson iProjection Operation Guide (Windows/Mac)" for instructions.

Selecting Wired Network Settings

Before you can project from computers on your network, you need to select network settings on the projector.



Make sure you already connected the projector to your wired network using the LAN port.

☛ "Connecting a LAN Cable" [p.52](#)

- 1 Press the [Menu] button on the control panel or remote control.
- 2 Select the **Network** menu and press [Enter].
- 3 Select **Network Configuration** and press [Enter].

- 4 Select the **Basic** menu and press [Enter].

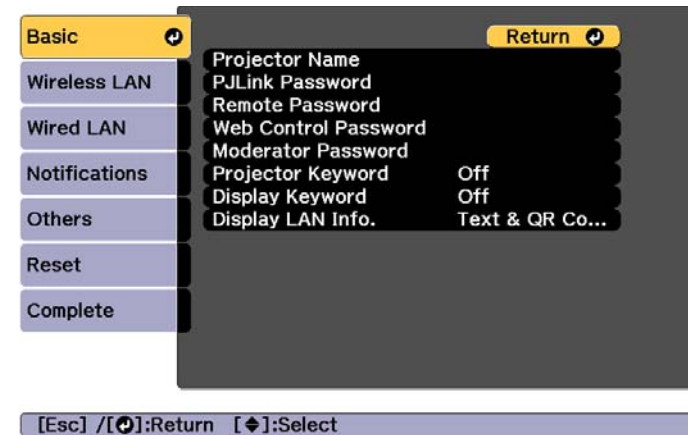

- 5 Select the basic options as necessary.

- **Projector Name:** Enter the projector name used to identify the projector over a network. You can enter up to 16 single-byte alphanumeric characters.
- **PJLink Password:** Lets you set a password for using the PJLink protocol for projector control. You can enter up to 32 single-byte alphanumeric characters.
- **Remote Password:** Allows you to set an authentication password for using the Remote function in Epson Web Control when setting or controlling the projector. You can enter up to 8 single-byte alphanumeric characters. (The user name is **EPSONREMOTE**; the default password is **guest**.)
- **Web Control Password:** Allows you to set an authentication password for using Web Control in Epson Web Control when setting or controlling the projector. You can enter up to 8 single-byte alphanumeric characters. (The user name is **EPSONWEB**; the default password is **admin**.)

- **Moderator Password:** Allows you to set an authentication password for using Epson iProjection when connecting to the projector as a moderator. Enter four digits for the password. (There is no default password.)
- **Projector Keyword:** Lets you turn on a security password to prevent access to the projector by anyone not in the room with it. You must enter a displayed keyword using Epson iProjection to project images and send or receive data.
- **Display Keyword:** Lets you display a projector keyword on the projection screen when connecting to the projector using Epson iProjection.
- **Display LAN Info.** lets you set the display format for the projector's network information.



Use the displayed keyboard to enter the name, passwords and keyword. Press [▲][▼][◀][▶] buttons on the remote control to highlight characters and press [Enter] to select them.

6 Select the **Wired LAN** menu and press [Enter].

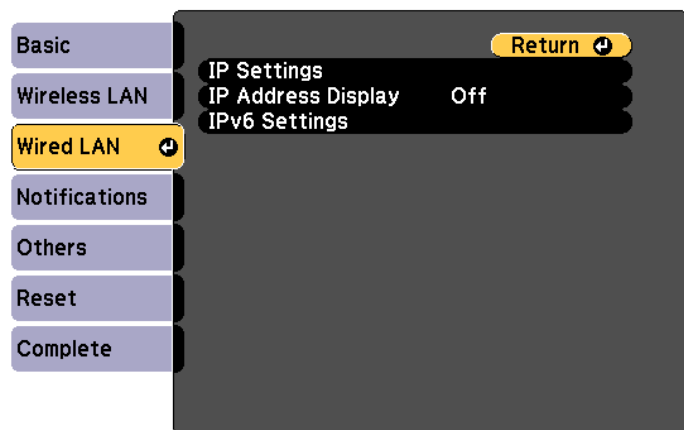

[Esc] / [Enter]: Return [Enter]: Select

7 Assign the IP settings for your network as necessary.

- If your network assigns addresses automatically, select **IP Settings** to set the **DHCP** setting to **On**.
- If you must set addresses manually, select **IP Settings** to set the **DHCP** setting to **Off**, and then enter the projector's **IP Address**, **Subnet Mask**, and **Gateway Address** as necessary.
- If you want to connect the projector to the network using IPv6, select **IPv6 Settings**.

☞ "Wired LAN menu" [p.157](#)



Press the [▲][▼][◀][▶] buttons on the remote control, and then select the number you want to enter on the soft keyboard displayed. Press the [Enter] button to confirm.

8 To prevent the IP address from being displayed on the LAN standby screen and Home screen, set the **IP Address Display** setting to **Off**.

9 If you have finished making settings, select **Setup complete**. Follow the on-screen instructions to save the settings and close the menu.

10 Press the [LAN] button on the remote control.

The wired network settings complete when you see the correct IP address on the LAN standby screen.

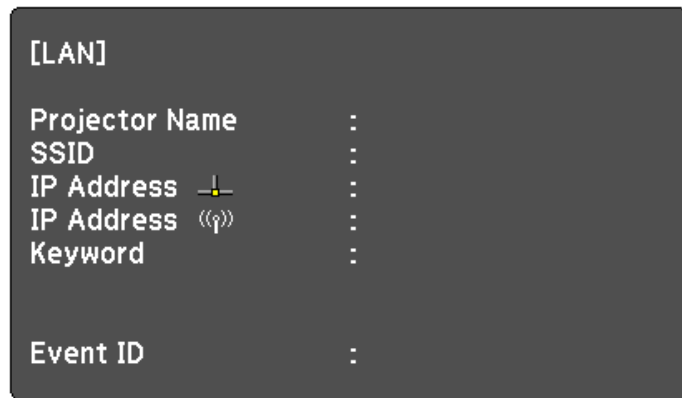

You can send images to your projector through a wireless network.

To do this, you must install the Epson 802.11b/g/n wireless LAN module, and then set up your projector and computer for wireless projection.

☛ "Installing the Wireless LAN Unit" [p.54](#)

You can connect the projector to your wireless network by configuring the connection manually using the projector's **Network** menus.

Set the projector's time before configuring the Network menu. If the time is not set, the wireless LAN may not be configured correctly.

☛ "Setting the Time" [p.44](#)

After installing the wireless LAN module and setting up the projector, install the network software from the EPSON Projector Software CD-ROM (if available) or download the software, as necessary. Use the following software and documentation to set up and control wireless projection:

- Epson iProjection (Windows/Mac) software allows you to hold interactive meetings by projecting the computer screens of users over a network. See the "Epson iProjection Operation Guide (Windows/Mac)" for instructions.
- Epson iProjection (iOS/Android) app allows you to project from iOS or Android mobile devices.
You can download Epson iProjection (iOS/Android) for free from the App Store or Google Play. Any fees incurred when communicating with the App Store or Google Play are the responsibility of the customer.
- Epson iProjection (Chromebook) allows you to project images from a Chromebook.
You can download Epson iProjection (Chromebook) for free from the Chrome Web Store. Any fees incurred when communicating with the Chrome Web Store are the responsibility of the customer.

Selecting Wireless Network Settings Manually

Before you can project from your wireless network, you need to select network settings for the projector.

- 1 Press the [Menu] button on the control panel or remote control.
- 2 Select the **Network** menu and press [Enter].

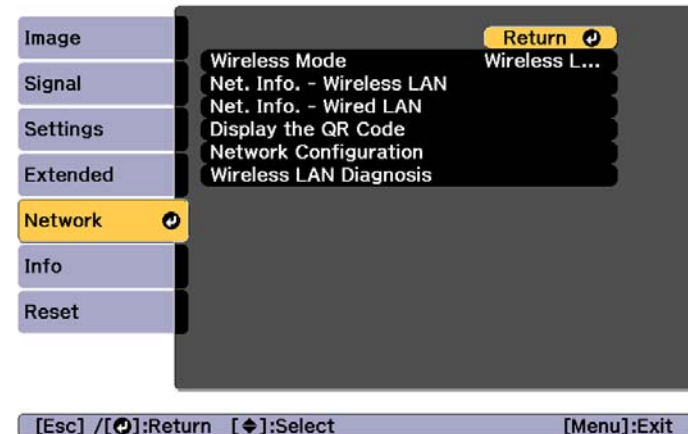

- 3 Set **Wireless Mode** to **Wireless LAN On**.

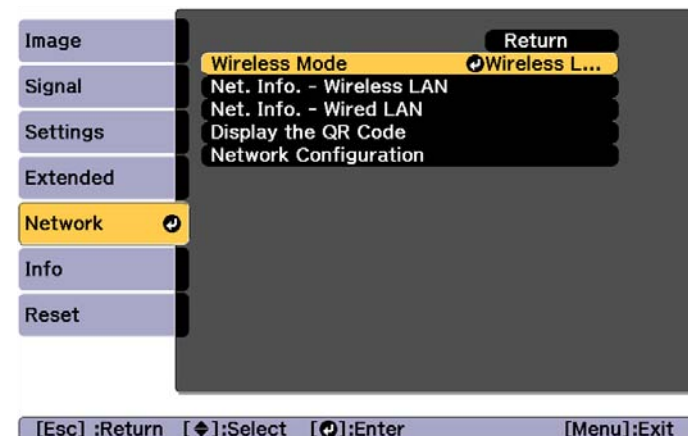

4 Select **Network Configuration** and press [Enter].

5 Select the **Basic** menu and press [Enter].

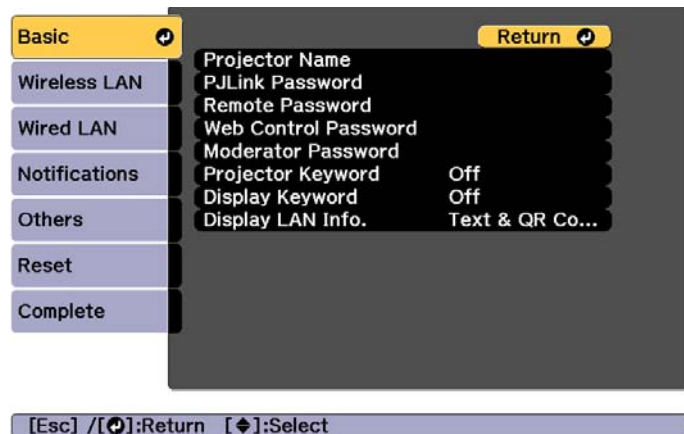

6 Select the basic options as necessary.

- **Projector Name:** Enter the projector name used to identify the projector over a network. You can enter up to 16 single-byte alphanumeric characters.
- **PjLink Password:** Lets you set a password for using the PjLink protocol for projector control. You can enter up to 32 single-byte alphanumeric characters.
- **Remote Password:** Allows you to set an authentication password for using the Remote function in Epson Web Control when setting or controlling the projector. You can enter up to 8 single-byte alphanumeric characters. (The user name is **EPSONREMOTE**; the default password is **guest**.)
- **Web Control Password:** Allows you to set an authentication password for using Web Control in Epson Web Control when setting or controlling the projector. You can enter up to 8 single-byte alphanumeric characters. (The user name is **EPSONWEB**; the default password is **admin**.)

- **Moderator Password:** Allows you to set an authentication password for using Epson iProjection when connecting to the projector as a moderator. Enter four digits for the password. (There is no default password.)
- **Projector Keyword:** Lets you turn on a security password to prevent access to the projector by anyone not in the room with it. Turn on "Projector Keyword" when using thumbnail display or the send function between the projector and connected devices.
- **Display Keyword:** Lets you display a projector keyword on the projection screen when connecting to the projector using Epson iProjection.
- **Display LAN Info.** lets you set the display format for the projector's network information.



Use the displayed keyboard to enter the name and password. Press [▲][▼][◀][▶] buttons on the remote control to highlight characters and press [Enter] to select them.

7 Select the **Wireless LAN** menu and press [Enter].

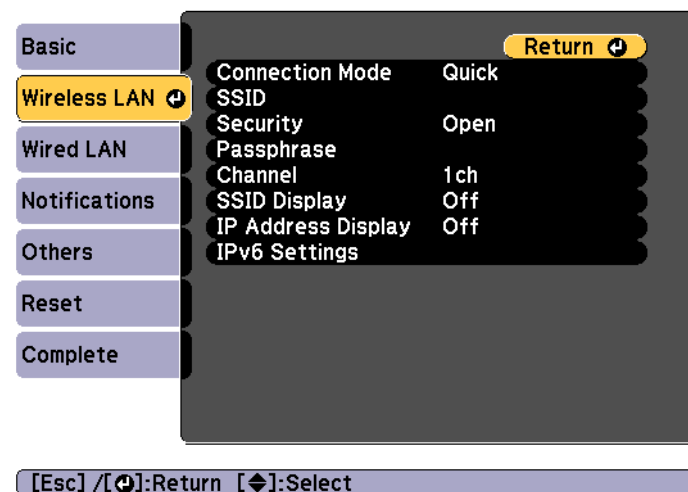

- 8** Select the **Connection Mode** setting.
- **Quick** lets you connect to multiple smartphones, tablets, or computers directly using wireless communication.
 - **Advanced**: Lets you connect to a smartphone, tablet, or computer over a wireless LAN access point.

- 9** If you selected the **Advanced** connection mode, select **Search Access Point** to select the access point you want to connect to.



If you need to assign the SSID manually, select **SSID** to enter the SSID.

- 10** For the **Advanced** connection mode, assign the IP settings for your network as necessary.
- If your network assigns addresses automatically, select **IP Settings** to set the **DHCP** setting to **On**.
 - If you must set addresses manually, select **IP Settings** to set the **DHCP** setting to **Off**, and then enter the projector's **IP Address**, **Subnet Mask**, and **Gateway Address** as necessary.
 - If you want to connect the projector to the network using IPv6, select **IPv6 Settings**.
 "Wireless LAN menu" [p.154](#)

- 11** To prevent the SSID or IP address from being displayed on the LAN standby screen and Home screen, set the **SSID Display** setting or the **IP Address Display** setting to **Off**.

- 12** If you have finished making settings, select **Setup complete**. Follow the on-screen instructions to save the settings and close the menu.

- 13** Press the [LAN] button on the remote control.
The wired network settings complete when you see the correct IP address on the LAN standby screen.

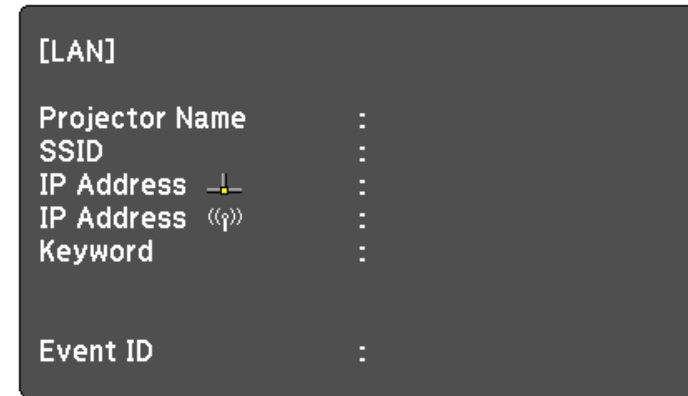

When you have finished making wireless settings for your projector, you need to select the wireless network on your computer. Then start the network software to send images to your projector through a wireless network.

Selecting Wireless Network Settings in Windows

Before connecting to the projector, select the correct wireless network on your computer.

- 1** To access your wireless utility software, double-click the network icon on the Windows taskbar.
- 2** When connecting in Advanced connection mode, select the network name (SSID) of the network the projector is connecting to.
- 3** Click **Connect**.

Selecting Wireless Network Settings in Mac

Before connecting to the projector, select the correct wireless network on your computer.

- 1** Click the AirPort icon on the menu bar at the top of the screen.
- 2** When connecting in Advanced connection mode, make sure AirPort is turned on and select the network name (SSID) of the network the projector is connecting to.

Setting Up Wireless Network Security

You can set up security for your projector to use on a wireless network. Set up one of the following security options to match the settings used on your network:

- WPA2-PSK security
- WPA2-EAP security *
- WPA/WPA2-PSK security *
- WPA/WPA2-EAP security *

* Only available for the Advanced connection mode.



Contact your network administrator for guidance on entering the correct information.

- 1** If you want to set up the WPA2-EAP or WPA/WPA2-EAP security, make sure your digital certificate file is compatible with projector registration and placed directly on the USB storage device.
☛ "Supported Client and CA Certificates" [p.129](#)
- 2** Press the [Menu] button on the control panel or remote control.
- 3** Select the **Network** menu and press [Enter].
- 4** Select **Network Configuration** and press [Enter].

- 5** Select the **Wireless LAN** menu and press [Enter].

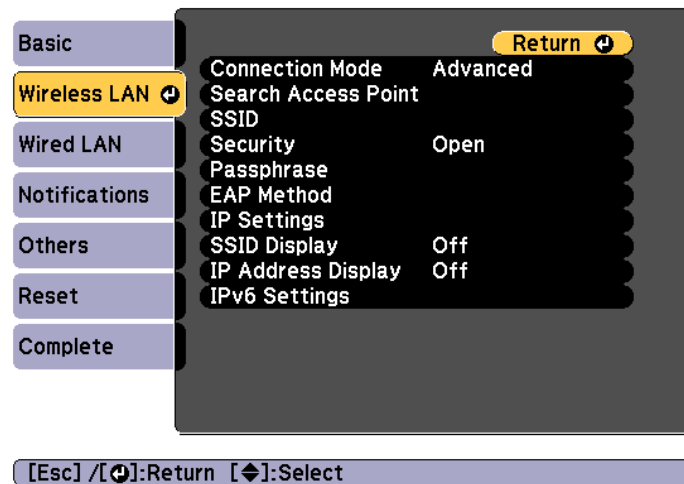

- 6** Select the **Security** setting and press [Enter].

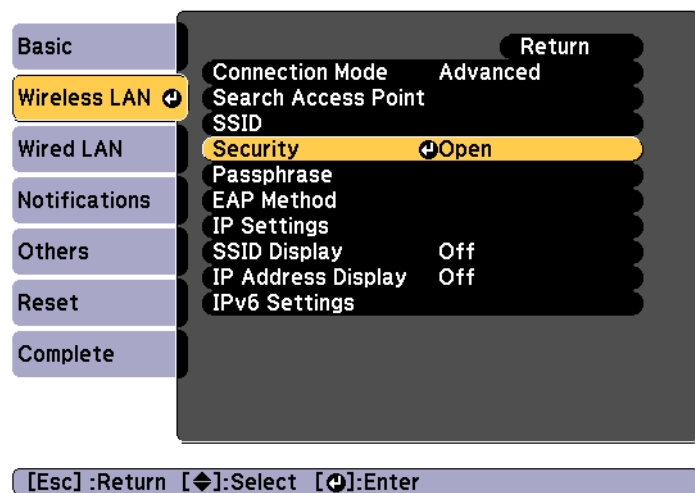

- 7** Select the security settings to match your network settings.

- WPA2-PSK, WPA/WPA2-PSK:

Select **Setup complete**. Follow the on-screen instructions to save the settings and close the menu.

- WPA2-EAP, WPA/WPA2-EAP:

Select **EAP Method** and press [Enter].

- 8** Select the protocol for authentication as the **EAP Type** setting.

- 9** To import your certificate, select the certificate type and press [Enter].

- **Client Certificate** for the **PEAP-TLS** or **EAP-TLS** type
- **CA certificate** for the **PEAP**, **PEAP-TLS**, **EAP-TLS**, or **EAP-FAST** type



You can also register the digital certificates from your Web browser. However, be sure to register just once or the certificate may not install correctly.

☛ "Setting a certificate using a Web browser" [p.133](#)

- 10** Select **Register** and press [Enter].

- 11** Connect a USB storage device to the projector's USB-A port (the wireless LAN module installation section).

If the wireless LAN module is already installed in the projector, remove it.

☛ "Installing the Wireless LAN Unit" [p.54](#)

- 12** Press [Enter] to display the certificate list.

- 13** Select the certificate to import using the displayed list.

A message is displayed prompting you to enter the password for the certificate.

- 14** Enter a password and press [Enter].
The certificate is imported and a completion message appears.

- 15** Select your EAP settings as necessary.

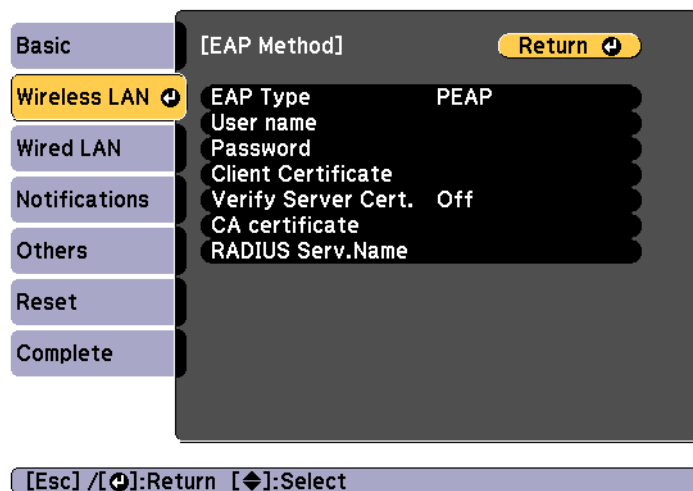

- **User Name:** Enter the user name. You can enter up to 64 single-byte alphanumeric characters. When entering more than 32 characters, use your Web browser to enter the text. When importing a client certificate, the name the certificate was issued to is automatically set.
- **Password:** Enter the password used for authentication in **PEAP**, **EAP-FAST**, and **LEAP**. You can enter up to 64 single-byte alphanumeric characters. When entering more than 32 characters, use your Web browser to enter the text.
- **Verify Server Cert.** lets you select whether or not to verify the server certificate when a CA certificate has been set.
- **RADIUS Serv.Name** lets you enter the server name to be verified.

- 16** If you have finished making settings, select **Setup complete**. Follow the on-screen instructions to save the settings and close the menu.

Supported Client and CA Certificates

You can register these types of digital certificates.

Client Certificate (PEAP-TLS/EAP-TLS)

Item	Explanation
Format	PKCS#12
Extension	PFX, P12
Encryption	RSA
Hashes	MD5/SHA-1/SHA-256/SHA-384/SHA-512
Key length	512/1024/2048/4096 bit
Password *	You need to setup a password. Up to 32 single-byte alphanumeric characters

CA Certificate (PEAP/PEAP-TLS/EAP-TLS/EAP-FAST)

Item	Explanation
Format	X509v3
Extension	DER/CER/PEM
Encryption	RSA
Hashes	MD5/SHA-1/SHA-256/SHA-384/SHA-512
Key length	512/1024/2048/4096 bit
Encoding	BASE64/Binary

* You can set a password using up to 64 alphanumeric characters. When entering more than 32 characters, use your Web browser to enter the text.

 "Changing Settings Using a Web Browser (Epson Web Control)"
p.215

Using a QR Code to Connect a Mobile Device

After making the wireless network settings for your projector, you can display a QR code on the screen and use it to connect a mobile device using the Epson iProjection (iOS/Android) app.



- Make sure you have installed the latest version of Epson iProjection on your device (Epson iProjection V1.3.0 or later supports this feature).
- You can download Epson iProjection for free from the App Store or Google Play. Any fees incurred when communicating with the App Store or Google Play are the responsibility of the customer.
- When using Epson iProjection in Quick connection mode, we recommend making security settings.

1 Press the [LAN] button on the remote control.

The QR code is displayed on the projected surface.



- If you do not see the QR code, set the **Display LAN Info.** setting to **Text & QR Code** in the projector's Network menu.
☛ **Network - Network Configuration - Display LAN Info.** [p.153](#)
- To hide the QR code, press the [Esc] button.
- When the QR code is hidden, press the [Enter] button to display the code.
- You can also display the QR code by selecting the icon on the Home screen.

2 Start Epson iProjection on your mobile device.

3 Read the projected QR code using Epson iProjection to connect it to the projector.



To correctly read the QR code, make sure you face the screen squarely and closely enough so that the projected code fits into the guide of the mobile device's QR code reader. If you are too far from the screen, the code may not be read.

When a connection is established, select **Contents** menu from ☰, and then select the file you want to project.

Using a USB Key to Connect a Windows Computer

You can set up your USB flash drive as a USB key to quickly connect the projector to a wireless LAN supported Windows computer. The USB key allows you to automatically select a computer's wireless network settings and project your presentation wirelessly.

- 1** Set up the USB key using Epson iProjection (Windows).
See the "Epson iProjection Operation Guide (Windows/Mac)" for instructions.
- 2** Make sure the wireless LAN module is installed.
- 3** Turn on the projector.
- 4** Press the [LAN] button on the remote control.
The LAN standby screen is displayed. Verify that an SSID and IP address are displayed.
- 5** Remove the wireless LAN module from the projector and insert the USB key into the same port used for the wireless LAN module.
 "Installing the Wireless LAN Unit" [p.54](#)
You see a projected message that the network information update is complete.
- 6** Remove the USB key.
Reinsert the wireless LAN module into the projector.
- 7** Connect the USB key to a USB port on your computer.
- 8** Follow the on-screen instructions to install the necessary application.



- If the Windows Firewall message is displayed, click **Yes** to disable the firewall.
- You need administrator authority to install the software.
- If it is not installed automatically, double-click **MPPLaunch.exe** in the USB key.

After a few minutes, your computer image is displayed by the projector. If it does not appear, press the [LAN] button on your projector's remote control or restart your computer.

- 9** Run your presentation.
- 10** When you have finished projecting wirelessly, select the **Safely Remove Hardware** option in the Windows taskbar, and then remove the USB key from your computer.



You may need to restart your computer to reactivate your wireless LAN connection.

You can use the HTTPS protocol to increase security between the projector and a Web browser communicating with it. To do this, you create a server certificate, install it on the projector, and turn on the **Secure HTTP** setting in the projector menus to verify the reliability of the Web browser.

☛ **Network - Network Configuration - Others - Secure HTTP** [p.159](#)

Even if you do not install a server certificate, the projector automatically creates a self-signed certificate and allows communication. However, because the self-signed certificate cannot verify reliability from a Web browser, you see a warning about the server's reliability when you access the projector from a Web browser. This warning does not prevent communication.

Importing a Web Server Certificate Using the Menus

You can create your Web server certificate, and import it using the projector menus and a USB flash drive.



You can also register the digital certificates from your Web browser. However, be sure to register just once or the certificate may not install correctly.

☛ [p.133](#)

- 1** If you want to set up the WPA2-EAP or WPA/WPA2-EAP security, make sure your digital certificate file is compatible with projector registration and placed directly on the USB storage device.
☛ "Supported Web Server Certificates" [p.133](#)
- 2** Press the [Menu] button on the control panel or remote control.
- 3** Select the **Network** menu and press [Enter].
- 4** Select **Network Configuration** and press [Enter].

- 5** Select the **Others** menu and press [Enter].

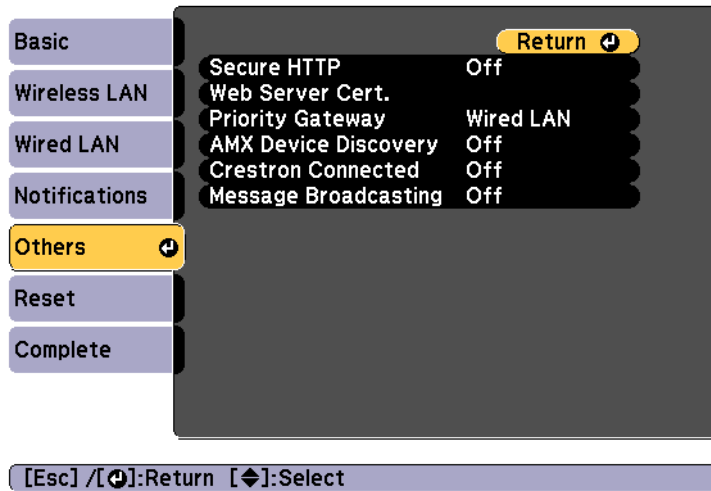

- 6** Select **On** as the **Secure HTTP** setting.

- 7** Select **Web Server Cert.** and press [Enter].

- 8** Select **Register** and press [Enter].

- 9** Connect a USB storage device to the projector's USB-A port (the wireless LAN module installation section).

If the wireless LAN module is already installed in the projector, remove it.

☛ "Installing the Wireless LAN Unit" [p.54](#)

- 10** Press [Enter] to display the certificate list.

- 11** Select the certificate to import using the displayed list.

A message is displayed prompting you to enter the password for the certificate.

- 12** Enter a password and press [Enter].

The certificate is imported and a completion message appears.

Supported Web Server Certificates

You can register these types of digital certificates.

Web Server Certificate (Secure HTTP)

Item	Explanation
Format	PKCS#12
Extension	PFX, P12
Encryption	RSA
Hashes	MD5/SHA-1/SHA-256/SHA-384/SHA-512
Key length	512/1024/2048/4096 bit
Common Name	Network Host Name
Organization	Optional
Password *	You need to setup a password. Up to 32 single-byte alphanumeric characters

* You can set a password using up to 64 alphanumeric characters. When entering more than 32 characters, use your Web browser to enter the text.

☛ "Setting a certificate using a Web browser" [p.133](#)

Setting a certificate using a Web browser

You can use an electronic certificate as the projector's security settings.



You can install the electronic certificate from the projector's Network menu. However, be sure to register just once or the certificate may not install correctly.

☞ "Setting Up Wireless Network Security" [p.127](#)

- 1** Prepare a certificate that is supported by the projector.
- 2** Make sure the projector is turned on.
- 3** Launch the Web browser on the computer or mobile device connected to the network.
- 4** Enter the IP address of the projector in the address input box of the browser to connect to the Epson Web Control screen.
The Epson Web Control screen is displayed.
- 5** Select **Advanced**.



You need to login to display the Advanced screen. When the login screen is displayed, enter your user name and password. (The user name is EPSONWEB; the default password is admin.)

- 6** Select **Certificate** from **Network**.
- 7** Click the **Choose File** button, select the certificate file.
- 8** Enter the password in the **Password** box, and then click **Send**.
- 9** When the settings are complete, click the **Apply**.



Configuration Menu

This chapter explains how to use the Configuration menu and its functions.

This section explains how to use the Configuration menu.

Although steps are explained using the remote control as an example, you can perform the same operations from the control panel. Check the guide under the menu for the available buttons and their operations.

1 Display the Configuration menu screen.

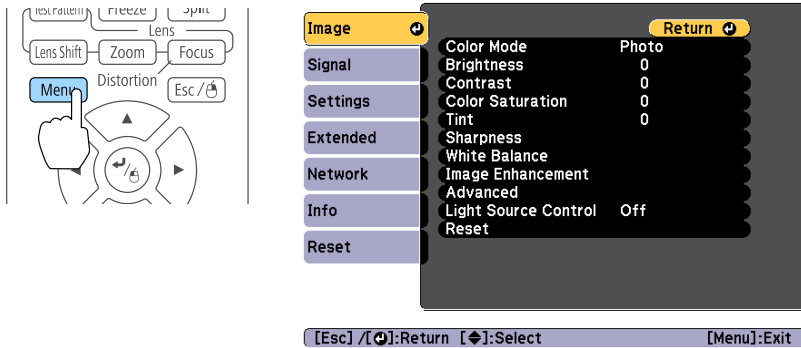

2 Select a top menu item.

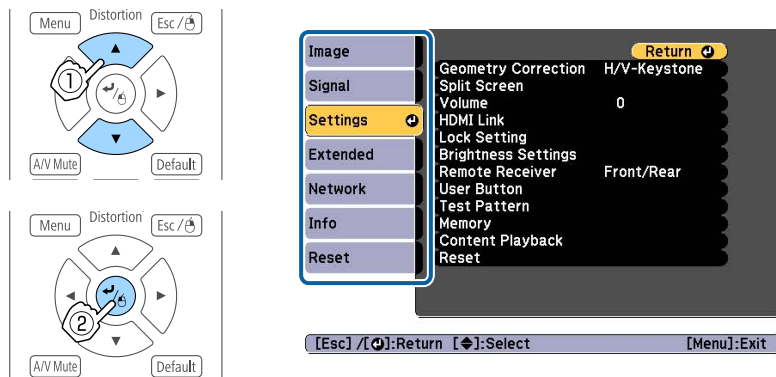

3 Select a submenu item.

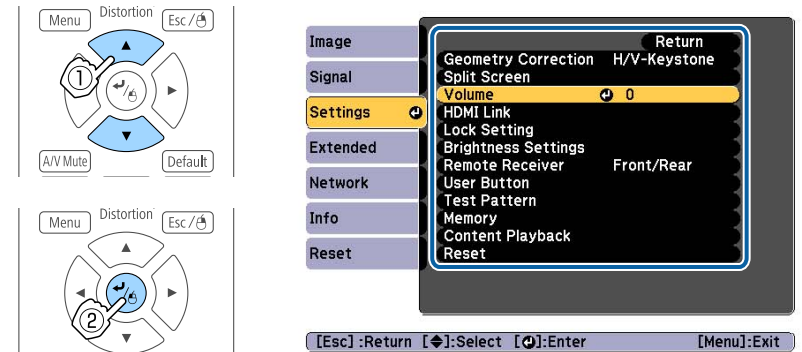

4 Change settings.

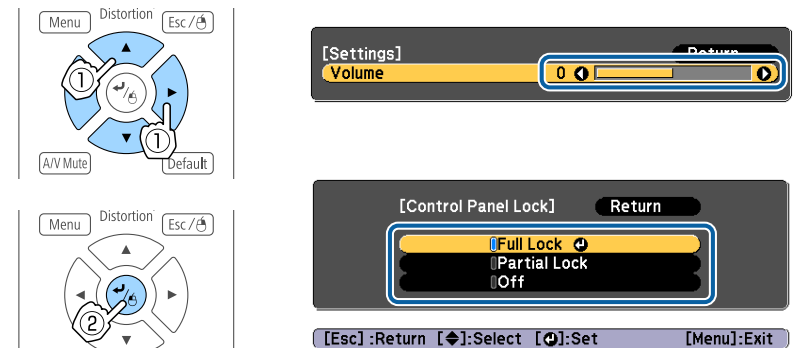

When "[Default]: Reset" is displayed on the guide under the menu, pressing the [Default] button on the remote control returns the settings being adjusted to their default values.

5 Press the [Menu] button to finish making settings.

Configuration Menu Table

Settable items vary depending on the model being used and the image signal and source being projected.

Top Menu Name	Submenu Name	Items or Setting Values
Image menu ☛ p.140	Color Mode	Dynamic, Presentation, Natural, Cinema, BT.709, DICOM SIM, Multi-Projection
	Brightness	0 to 100
	Contrast	0 to 100
	Color Saturation	0 to 100
	Tint	0 to 100
	Sharpness	Standard, Thin Line Enhancement, Thick Line Enhancement
	White Balance	Color Temp., G-M Correction, Offset R, Offset G, Offset B, Gain R, Gain G, Gain B
	Image Enhancement	4K Enhancement, Image Preset Mode, Frame Interpolation, Deinterlacing, Noise Reduction, MPEG Noise Reduction, Super-resolution, Detail Enhancement, Reset
	Advanced	Gamma, RGBCMY
Light Source Control	Light Source Control, Dynamic Contrast, Lights-Out Control	
Signal menu ☛ p.142	Resolution	Auto, Wide, Normal, and Manual
	Aspect	Auto, Normal, 4:3, 16:9, Full, H-Zoom, V-Zoom, Native
	Tracking	-
	Sync.	0 to 31

Top Menu Name	Submenu Name	Items or Setting Values
	Position	-128 to 127
	Auto Setup	On, Off
	Overscan	Auto, Off, 4%, and 8%
	Blanking	Top, Bottom, Left, and Right
	Advanced	Video Range, Input Signal, BNC Sync Termination, EDID, DDC Buffer
	Scale	Scale, Scale Mode, Scale Vertically, Scale Horizontally, Clip Adjustment, Clip Range
Settings menu ☛ p.143	Geometry Correction	Off, H/V-Keystone, Quick Corner, Curved Surface, Corner Wall, Point Correction, Memory
	Split Screen	-
	Volume	0 to 20
	HDMI Link	Device Connections, HDMI Link, Audio Out Device, Power On Link, Power Off Link, Link Buffer
	Lock Setting	Control Panel Lock, Lens Lock
	Brightness Settings	Light Source Mode, Brightness Level, Constant Brightness, Estimated Remains
	Remote Receiver	Front/Rear, Front, Rear, and Off
	User Button	User Button 1, User Button 2, and User Button 3
	Test Pattern	Standard, Cross-hatching, Cross-hatching R, Cross-hatching G, Cross-hatching B, Color Bars V, Color Bars H, Grayscale, Gray Bars V, Gray Bars H, Checkerboard 1, Checkerboard 2, White, Black, Aspect Frame

Top Menu Name	Submenu Name	Items or Setting Values
	Memory	Memory, Lens Position, Geometry Correction
	Content Playback	Content Playback, Overlay Effect, USB Viewer
Extended menu ☛ p.146	Home Screen	Home Screen Auto Disp., Custom Function 1, Custom Function 2
	Display	Menu Position, Message Position, Messages, Display Background, Startup Screen, Standby Confirmation, Air Filter Notice, Screen, Panel Alignment, Color Uniformity, OSD Rotation
	User's Logo	Start Setting, Reset
	Projection	Front, Front/Ceiling, Rear, and Rear/Ceiling
	Operation	Direct Power On, Sleep Mode, Sleep Mode Timer, High Altitude Mode, Auto Source Search, Auto Power On, Startup Source, A/V Mute Settings, Advanced, Date & Time, Lens Calibration
	A/V Settings	A/V Output, Monitor Out, and Audio Settings
	Standby Mode	Communication On and Communication Off
	HDBaseT	Control Communications, Extron XTP
	Multi-Projection	Projector ID, Tiling, Geometry Correction, Edge Blending, Black Level, Scale, Color Mode, Brightness Settings, Color Matching, Color Uniformity, Reset
	Schedule Settings	-

Top Menu Name	Submenu Name	Items or Setting Values
	Language	27 languages
Info menu ☛ p.161	Projector Info	Total Op. Time, Operation Hours, Source, Input Signal, Resolution, Refresh Rate, Sync Info, Status, Serial Number, Lens Type, Event ID, HDBaseT Signal Level
	Light Source Info	Light Source Hours, Estimated Remains
	Version	Main, Video2, Sub, Sub2, HDMI, HDBaseT, HDBaseT2
	Status Information	Status Information, Source, Signal Information, Network Wired, Network Wireless, Maintenance, Version
	Temp Warning Info	-
	Power On/Off History	-
	Reset menu ☛ p.162	Reset All Memories
Refresh Mode		Timer, Messages, Start
Light Source Calibration		Run Now, Run Periodically, Schedule Settings, Last Run
Reset All Config		-
Reset All (Factory Default)		Reset All (Factory Default), Password

Network menu

Top Menu Name	Submenu Name	Items or Setting Values
Basic menu ☛ p.153	Projector Name	-
	PJLink Password	-
	Remote Password	-

Top Menu Name	Submenu Name	Items or Setting Values
	Web Control Password	-
	Moderator Password	-
	Projector Keyword	On, Off
	Display Keyword	On, Off
	Display LAN Info.	Text & QR Code, Text
Wireless LAN menu ☛ p.154	Connection Mode	Quick, Advanced
	Search Access Point	-
	SSID	-
	Security	Open, WPA2-PSK, WPA/WPA2-PSK, WPA2-EAP, WPA/WPA2-EAP
	Passphrase	-
	EAP Method	EAP Type, User name, Password, Client Certificate, Verify Server Cert., CA certificate, RADIUS Serv.Name
	Channel	1ch, 6ch, and 11ch
	IP Settings	DHCP, IP Address, Subnet Mask, Gateway Address
	SSID Display	On, Off
	IP Address Display	On, Off
	IPv6 Settings	IPv6, Auto Configuration, Use Temporary Address
Wired LAN menu ☛ p.157	IP Settings	DHCP, IP Address, Subnet Mask, Gateway Address
	IP Address Display	On, Off

Top Menu Name	Submenu Name	Items or Setting Values
	IPv6 Settings	IPv6, Auto Configuration, Use Temporary Address
Notifications menu ☛ p.159	Mail Notification	On, Off
	SMTP Server	-
	Port Number	-
	From	-
	Address 1 Setting, Address 2 Setting, Address 3 Setting	Email Address, No Signal, System Error, Laser Error, High Temp Error, Air Filter Error, Laser Warning, High Temp Warning, Air Filter Warning, Air Filter Notice, Constant Bright. End
	SNMP	On, Off
	Trap IP Address 1, Trap IP Address 2	-
	Community Name	-
	PJLink Notification	On, Off
	Notified IP Address	-
Others menu ☛ p.159	Secure HTTP	On, Off
	Web Server Cert.	-
	Priority Gateway	Wired LAN, Wireless LAN
	AMX Device Discovery	On, Off
	Crestron Connected	On, Off
	Message Broadcasting	On, Off

Image Menu

Settable items vary depending on the image signal and source currently being projected. Setting details are saved for each color mode.

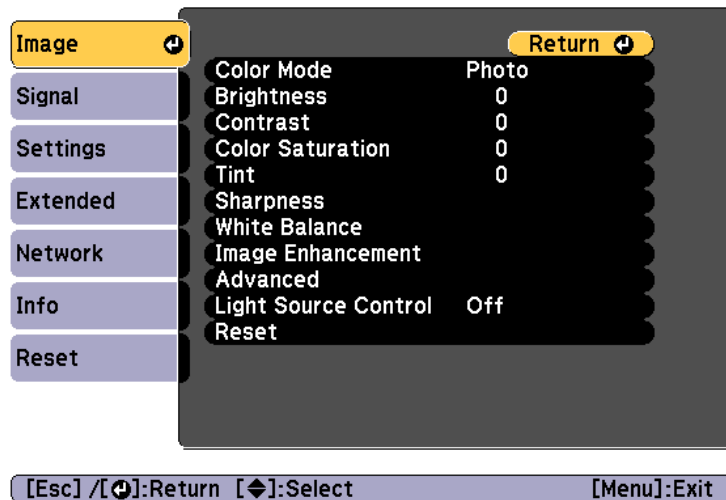

☛ "Automatically Detecting Input Signals and Changing the Projected Image (Source Search)" [p.61](#)



Submenu	Function
Color Mode	You can select the quality of the image to suit your surroundings. ☛ "Selecting the Projection Quality (Selecting Color Mode)" p.76
Brightness	Adjusts the image brightness.
Contrast	Adjusts the difference between light and shade in the images.
Color Saturation	Adjusts the color saturation for the images.
Tint	You can adjust the image tint.

Submenu	Function
Sharpness	Standard: You can adjust the image sharpness. Thin Line Enhancement: If this parameter is set to a positive value, details such as hair or fabric patterns will be enhanced. Thick Line Enhancement: If this parameter is set to a positive value, the outline, background, and the other main parts of the objects in the image will be enhanced to show them clearly.
White Balance	You can adjust the overall tint of the image. Color Temp.: You can adjust the overall tint of the image within a range from 3200K to 10000K. The image is tinted blue when a high value is selected and tinted red when a low value is selected. When Color Mode is set to Dynamic , the set Color Temp. may differ from the actual Color Temp. of the light from the projector. Use this menu as a guide. G-M Correction: The color tone is tinted red when set to a negative value, and tinted green when set to a positive value. Offset R/G/B, Gain R/G/B: You can adjust the offset and gain of each color R (red), G (green), and B (blue) individually.

Submenu	Function
Image Enhancement	<p>You can adjust the image resolution.  "Adjusting Image Resolution (Image Enhancement)" p.83</p> <p>4K Enhancement*: (EB-L1075U/EB-L1070U/EB-L1065U/EB-L1060U/EB-L1050U only) You can project at a doubled resolution.</p> <p>Image Preset Mode: You can select the optimal setting according to the projected image from five presets prepared in advance.</p> <p>Frame Interpolation: You can play fast moving images smoothly by producing intermediate frames between the original frames.</p> <p>Deinterlacing: (Only when the input signal is 480i, 576i, or 1080i) You can convert interlace signals into progressive signals. (IP conversion)</p> <p>Off is ideal for images with a large amount of movement, Video for general video images, and Film/Auto for movie films, computer graphics, and animation.</p> <p>Noise Reduction: You can smooth out the roughness in progressive images.</p> <p>MPEG Noise Reduction: You can reduce dot and block noise that occurs in outlines when projecting MPEG movies.</p> <p>Super-resolution: To display a crisp image, you can reduce the blurring that is created on the edge when the resolution of the image signal is scaled up and projected.</p> <p>Detail Enhancement: You can enhance the contrast of details in an image.</p> <p>Reset: Returns the selected preset to its defaults.</p>
Advanced	<p>You can make adjustments by choosing the following items.</p> <p>Gamma: You can adjust the coloring by selecting one of the gamma correction values, or referring to the projected graph.</p> <p>RGBCMY: You can adjust the hue, saturation, and brightness of each color R (red), G (green), B (blue), C (cyan), M (magenta), Y (yellow) individually.</p>

Submenu	Function
Light Source Control	<p>Light Source Control: Select the light source operations according to the image signal.  "Setting the Amount of Light of the Projected Image" p.79</p> <p>Dynamic Contrast: (This can only be set if Light Source Control is set to Dynamic Contrast) Automatically adjusts the amount of light when projecting according to the brightness of the image.</p> <p>Lights-Out Control: (This can only be set if Light Source Control is set to Lights-Out Control) Automatically turns off the light after the set time has elapsed at the specified video level.</p>
Reset	<p>You can reset all adjustment values for the Image menu to their default settings. See the following to return all menu items to their default settings.  "Reset Menu" p.162</p>

* This cannot be set when **Aspect** is set to **Native**.

Signal Menu

Settable items vary depending on the image signal and source currently being projected. Setting details are saved for each image signal.

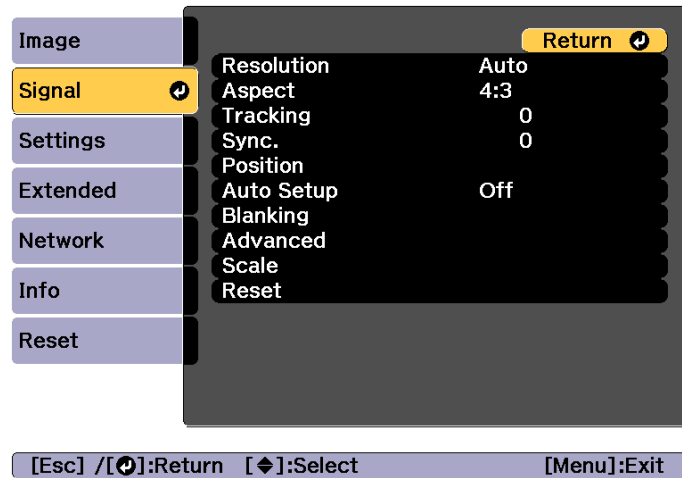

Submenu	Function
Sync.	(Only available when an analog RGB computer signal is being input.) You can adjust computer images when flickering, fuzziness, or interference appear in the images.
Position	You can adjust the display position up, down, left, and right when a part of the image is missing so that the whole image is projected.
Auto Setup	(Only available when an analog RGB computer signal is being input.) Set to On to automatically adjust Tracking, Sync., and Position to the optimum state when the input signal changes.
Overscan	Changes the output image ratio (the range of the projected image). You can set the cropping range to 4% or 8% . When set to Auto , this is automatically adjusted according to the input signal.
Blanking	You can hide images in the set area. Use the [◀] [▶] buttons to adjust the area. You can adjust by using a combination of Top , Bottom , Left , and Right . You can hide up to half of the projected image in each direction (except for one pixel).



Submenu	Function
Resolution	(Only available when an analog RGB computer signal is being input.) Set to Auto to automatically identify the resolution of the input signal. If images are not projected correctly when set to Auto , for example if some of the image is missing, set to Wide for wide screens, or set to Normal for 4:3 or 5:4 screens depending on the connected computer. Manual allows you to specify the resolution. This is ideal when connected computer is fixed.
Aspect	You can set the Aspect Ratio for projected images. ☛ "Changing the Aspect Ratio of the Projected Image" p.80
Tracking	(Only available when an analog RGB computer signal is being input.) You can adjust computer images when vertical stripes appear in the images.

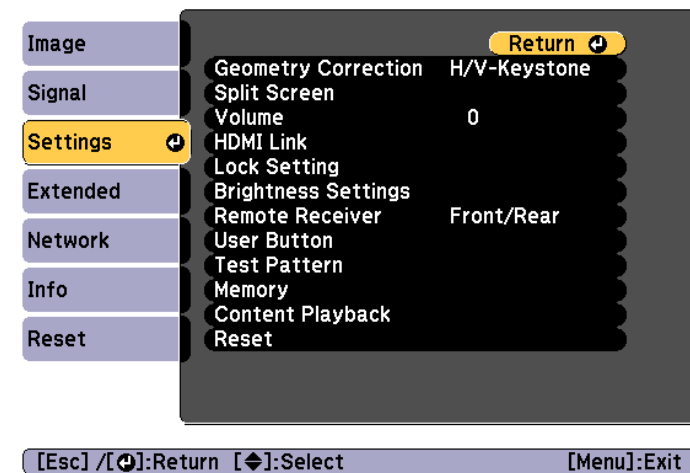

Submenu	Function
Advanced	<p>You can set by choosing the following items.</p> <p>Video Range: Select the video range for the input signal from the HDMI port, DVI-D port, or HDBaseT port. If the brightness range is 16 to 235, select Limited (16-235), if it is 0 to 255, select Full (0-255).</p> <p>Input Signal: Select an input signal from the Computer port or BNC port. If set to Auto, the input signal is set automatically according to the connected equipment. If colors do not appear correctly when set to Auto, select the appropriate signal according to the connected equipment.</p> <p>BNC Sync Termination: Set the end process for signals from the BNC In port. This should usually be set to Off. Set to On when analog (75Ω) termination such as for switchers is necessary.</p> <p>EDID: (Displayed when the current source is HDMI, HDBaseT, or DVI-D) Make settings related to EDID. Even in setups with multiple displays with different resolutions, you can switch the EDID of the current source and unify the EDID across the displays by setting the same EDID as the standard display.</p> <ul style="list-style-type: none"> • Preset EDID: Select the optimal setting from the presets prepared in advance. Change the preset sub menu settings for Resolution, Refresh Rate, and Color Depth if necessary. Select Settings, and then press the [↵] button. • Resolution: Select from the resolutions displayed. • Refresh Rate: Select from the refresh rates displayed. • Color Depth: Select the maximum color depth limit supported by the projector. When you select 12bit, the projected images support signals up to 12 bits. • Reset: You can reset all adjustment values for EDID to their default values. <p>DDC Buffer: (Displayed when the current source is HDMI or DVI-D) Setting this to On can sometimes improve images that are not displayed correctly from devices connected using an HDMI or DVI extension cable.</p>
Scale	<p>When using multiple projectors to project one image, adjust the range of the image displayed by each projector.</p> <p>☛ "Displaying a Scaled Image" p.97</p>

Submenu	Function
Reset	<p>You can reset all adjustment values on the Signal menu to their default settings, except for Input Signal and EDID.</p> <p>See the following to return all menu items to their default settings.</p> <p>☛ "Reset Menu" p.162</p>

Settings Menu



Submenu	Function
Geometry Correction	<p>You can correct distortion.</p> <p> "Correcting Distortion in the Projected Image" p.64</p> <ul style="list-style-type: none"> • Off: Temporarily cancels the geometry correction. • H/V-Keystone: Adjust V-Keystone, V-Balance, H-Keystone, and H-Balance to correct vertical and horizontal keystone distortion. • Quick Corner: Select and correct the four corners of the projected image. • Curved Surface: Corrects distortion that occurs when projecting on a curved surface. • Corner Wall: Corrects distortion that occurs when projecting on a surface with right angles. • Point Correction: Divides the projected image into a grid and corrects the distortion by moving the selected point of intersection from side to side and up and down. • Memory: You can save the adjustment value of the geometry correction and load it when needed.  "Memory Function" p.110
Split Screen	<p>You can split the screen into two screens.</p> <p> "Projecting Two Images Simultaneously (Split Screen)" p.99</p>
Volume	<p>You can adjust the volume. Setting values are saved for each source.</p>

Submenu	Function
HDMI Link	<p>Sets HDMI Link.</p> <p>Device Connections: Displays a list of the devices connected to the HDMI port.</p> <p>HDMI Link Enables or disables HDMI Link.</p> <p>Audio Out Device: When the projector is connected to an AV amplifier, select whether to output audio from the external speakers connected to the projector or to output audio from the AV amplifier's speakers.</p> <p>Power On Link: Set the operation to perform when turning on the projector or a connected device.</p> <ul style="list-style-type: none"> • Bidirectional: Turns on the connected device when the projector is turned on, or turns on the projector when the connected device is turned on. • Connected Device→PJ: Turns on the projector when the connected device is turned on. • PJ→Connected Device: Turns on the connected device when the projector is turned on. <p>Power Off Link: Set whether or not to turn off the connected device when the projector is turned off.</p> <p>Link Buffer: If HDMI Link is not working properly, changing this setting may improve linking operations.</p>
Lock Setting	<p>Control Panel Lock: You can use this to restrict operation of the projector's control panel.  "Control Panel Lock" p.117</p> <p>Lens Lock: When set to On, [Lens Shift], [Zoom], and [Focus] button operations on the remote control are disabled.  "Lens Lock" p.118</p>

Submenu	Function
Brightness Settings	<p>Light Source Mode: Set the brightness for the light source.</p> <ul style="list-style-type: none"> • Normal: Select this if you do not want to decrease the brightness. This makes the light source operation time approximately 20,000 hours. • Medium: Noise from the fan is louder than when Quiet is selected, but it does not decrease the brightness as much. This sets the brightness at 85%. This makes the light source operation time approximately 20,000 hours. • Quiet: Select this if you are concerned about the noise made by the fan. This sets the brightness at 70%. This makes the light source operation time approximately 20,000 hours. • Extended: Select this to extend the life expectancy of the light source. This sets the brightness at 70%. This makes the light source operation time approximately 30,000 hours. • Custom: Select this to set the brightness level within a range of 30 to 100%. <p>Brightness Level: (Only available when Light Source Mode is set to Custom) Sets the brightness for the light source.</p> <p>Constant Brightness: (Only available when Light Source Mode is set to Custom) When set to On, the brightness of the light source set in Brightness Level is maintained as it is. When Constant Brightness is set to On, you cannot change the settings for Light Source Mode and Brightness Level.</p> <p>☛ "Setting the Brightness" p.77</p> <p>Estimated Remains: When Constant Brightness is set to On, this indicates the amount of time for which constant brightness can be maintained.</p> <p>☛ "Guide to Estimated Remains" p.78</p>

Submenu	Function
Remote Receiver	<p>You can limit the reception of the operation signal from the remote control.</p> <p>When set to Off, you cannot perform any operations from the remote control. If you want to make operations from the remote control, hold down the [Menu] button on the remote control for at least 15 seconds to reset the setting to its default value.</p>
User Button	<p>Select the items in the Configuration menu that you want to assign to the [User1], [User2], and [User3] buttons on the remote control. The following items can be assigned.</p> <p>Light Source Mode, Multi-Projection, Resolution, On-Screen Display, Display the QR Code, Image Enhancement, Frame Interpolation, Link Menu, Content Playback, USB</p> <p>(USB is only enabled when Content Playback is set to On.)</p>
Test Pattern	<p>You can display a test pattern to adjust the projection without connecting other equipment when you set up the projector.</p> <p>☛ "Displaying the Test Pattern" p.33</p>
Memory	<p>Perform operations and make settings for the memory function.</p> <p>☛ "Memory Function" p.110</p>
Content Playback	<p>Content Playback: When this is set to On, you can play playlists created in Epson Projector Content Manager.</p> <p>Overlay Effect*: Adds color and shape decorations to the image. (This is only enabled when Content Playback is set to On.)</p> <p>USB Viewer: Plays playlists stored on a USB flash device. (This is only enabled when Content Playback is set to On.)</p>

Submenu	Function
Reset	<p>You can reset all adjustment values on the Settings menu to their default settings, except for Audio Out Device, Power On Link, Power Off Link, Link Buffer, User Button, Memory, Content Playback.</p> <p>See the following to return all menu items to their default settings.</p> <p>☛ "Reset Menu" p.162</p>

* This cannot be set when **Edge Blending** is set to **On**

Extended Menu

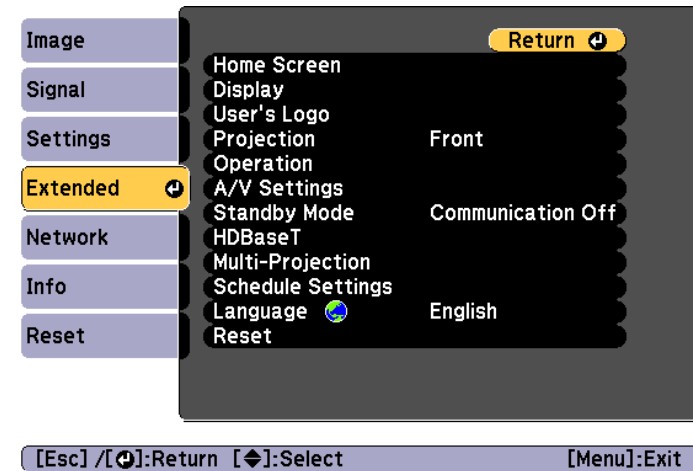





Submenu	Function
Home Screen	<p>Home Screen Auto Disp.: When set to On, the Home screen is displayed when the projector turns on. The Home screen is not displayed when the selected source has an image signal when the projector turns on.</p> <p>Custom Function 1, Custom Function 2: Select functions to be assigned to the Home screen from the following five functions. Network Settings, Info, Image Enhancement, Frame Interpolation, Split Screen</p>

Submenu	Function
Display	<p>You can make settings related to the projector's display.</p> <p>Menu Position: Select the position to display the menu on the projected screen.</p> <p>Message Position: Select the position to display the message on the projected screen.</p> <p>Messages: When set to Off, the following items will not be displayed.</p> <p>Item names when the Source, Color Mode, or Aspect is changed, messages when no signal is being input, and warnings such as High Temp Warning.</p> <p>Display Background*: You can set the screen background to Black, Blue, or Logo when no image signal is available.</p> <p>Startup Screen*: Set to On to display the User's Logo when you start projecting.</p> <p>Standby Confirmation: If it is set to Off, you can turn off the power simply by pressing the [⏻] button once.</p> <p>Air Filter Notice: You can set whether or not (On/Off) to enable Air Filter Notice. When this is set to On and a clog in the air filter is detected, the message is displayed on the screen.</p> <p>Screen: (This is unavailable when projecting images from a computer over a network.) Set the aspect ratio and position of the projected screen according to the screen being used.</p> <p>☛ "Screen Settings" p.32</p> <p>Panel Alignment: Corrects color misalignments (red and blue) in the screen.</p> <p>☛ "Panel Alignment" p.210</p> <p>Color Uniformity: Adjusts the color tone balance for the whole screen.</p> <p>☛ "Color Uniformity" p.212</p> <p>OSD Rotation: Rotates the menu direction by 90° degrees.</p>
User's Logo *	<p>You can change the user's logo that is displayed as a background during Display Background, A/V Mute, and so on.</p> <p>☛ "Saving a User's Logo" p.104</p>











Submenu	Function
Projection	<p>Select from one of the following projection methods depending on how the projector is installed.</p> <p>Front, Front/Ceiling, Rear, Rear/Ceiling</p> <p>You can change the setting as follows by pressing down the [A/V Mute] button for about five seconds.</p> <p>Front ↔ Front/Ceiling</p> <p>Rear ↔ Rear/Ceiling</p>



Submenu	Function
Operation	<p>Direct Power On: Set to On to turn on the projector simply by plugging it in.</p> <p>When the power cord is plugged in, note that the projector turns on automatically in cases such as a power outage being restored.</p> <p>Sleep Mode: When set to On, this automatically stops projection when no image signal is being input and no operations are carried out.</p> <p>Sleep Mode Timer: When Sleep Mode is set to On, you can set the time before the projector automatically turns off within a range of 1 to 30 minutes.</p> <p>High Altitude Mode: Set this to On if you are using the projector above an altitude of 1,500 meters.</p> <p>Auto Source Search: Set to On to automatically detect an image signal from another source and project the image when there is no image signal from the current source.</p> <p>Auto Power On: If it is set to Computer or BNC, the projector is turned on when the signals are received from the Computer port or BNC port, even when the projector is in standby status.</p> <p>Startup Source: Select the source you want to project when the projector is turned on in Content Playback mode.</p> <p>A/V Mute Settings: Perform settings related to A/V mute.</p> <ul style="list-style-type: none"> • Fade-in: Specify the number of seconds for fade-in when displaying an image. • Fade-out: Specify the number of seconds for fade-out when hiding an image. • A/V Mute Timer: When it is set to On, if no operations are performed for about 2 hours after A/V mute is activated, the projector turns off automatically. • A/V Mute Release: When it is set to A/V Mute, you can release A/V mute only by pressing the [A/V Mute] button (or by sending an A/V mute Off command). When set to Any Button, A/V mute is released when any operation is performed on the projector.

Submenu	Function
	<p> "Hiding the Image and Sound Temporarily (A/V Mute)" p.102</p> <p>Advanced: The following items can be set.</p> <ul style="list-style-type: none"> • Beep: When this is set to On, the confirmation buzzer beeps to notify you that the power turns on or off, or cooling down is finished. • Indicators: When set to Off, the projector's indicators are turned off, except for abnormality or warning. • Log Save Destination: Set where you want to save the operation logs for the projector. Select USB and Internal Memory to save the logs to the USB flash drive connected to the projector's USB-A port. Logs are saved as text files (.log) on the USB flash drive. The following logs are saved. <ul style="list-style-type: none"> - Error information - Laser information - Temperature logs - Operation logs • Batch Setup Range: Select All to copy all of the menu settings using the batch setting function. Select Limited if you do not want to copy the following settings. <ul style="list-style-type: none"> - EDID from the Signal menu - Network menu • Lens Type: When using the following lens, select the model number of the lens. ELPLS04, ELPLU02, ELPLR04, ELPLW04, ELPLM06, ELPLM07, ELPLL07 <p>Date & Time: Make system time settings for the projector.</p> <p> "Setting the Time" p.44</p> <p>Lens Calibration: Acquires the information of the lens installed on the projector.</p>

Submenu	Function
A/V Settings	<p>A/V Output: Set this to Always On if you want to output audio and images to an external device even when the projector is in standby status.</p> <p>Monitor Out: Select the image source output to an external monitor when the projector is in standby status. When set to Auto, analog RGB signals from the Computer port or the BNC port are output depending on which source was selected when the projector was turned off.</p> <p>Audio Settings: Performs the following audio related settings.</p> <ul style="list-style-type: none"> • Audio Output: Select the audio to be output when projecting images from the Computer port, BNC port, or DVI-D port. When set to Auto, audio is output from the audio input port corresponding to each image input port.  "Connecting Equipment" p.47 • HDMI Audio Output: Select the audio source when projecting images from the HDMI port. If you select HDMI, audio for the image is output as it is. If you select Audio3, audio is output from the Audio3 port.
Standby Mode	<p>If you set Communication On, you can perform the following operations even if the projector is in standby mode.</p> <ul style="list-style-type: none"> • Monitor and control the projector over a network. • Output audio and images to an external device. (Only when A/V Output is set to Always On.) • Communication from the HDBaseT port is enabled. (Only when Control Communications is set to On.) <div style="border: 1px solid black; padding: 5px; margin-top: 10px;">  When monitoring or controlling the projector using wireless LAN, set Connection Mode to Advanced.  Network - Wireless LAN - Connection Mode p.154 </div>

Submenu	Function
HDBaseT	<p>Control Communications: (This cannot be set when Extron XTP is set to On.) When set to On, Ethernet communication, serial communication, and the wired remote control through the HDBaseT Transmitter connected to the HDBaseT port are all enabled.</p> <p>Extron XTP: Set to On when you connect the Extron XTP transmitter or switcher to the HDBaseT port. See the following Extron Web site for more details on the XTP system. http://www.extron.com/</p> <div style="border: 1px solid black; padding: 10px; margin-top: 10px;">  <ul style="list-style-type: none"> • When Control Communications or Extron XTP is set to On, Standby Mode is automatically set to Communication On. • When Control Communications or Extron XTP is On, the projector's LAN port, RS-232 port, and Remote port are disabled. • When Extron XTP is set to On, the fan may rotate in standby mode but this is not abnormal. </div>

Submenu	Function
Multi-Projection	<p>Make settings when projecting from multiple projectors.  "Multi-Projection Function" p.90</p> <p>Projector ID: Set the ID from 01 to 30. Off indicates that no ID is set.  "ID Settings" p.42</p> <p>Tiling: Set the number of split screens and positions of each projected image.  "Tiling" p.90</p> <p>Geometry Correction: Corrects distortion in the projected image.  "Correcting Distortion in the Projected Image" p.64</p> <p>Edge Blending: Corrects a border between multiple images to create a seamless screen.  "Edge Blending" p.91</p> <p>Black Level: Adjusts the differences in brightness and tone for areas where images overlap and areas where the images do not overlap.  "Black Level" p.93</p> <p>Scale: When using multiple projectors to project one image, adjust the range of the image displayed by each projector.  "Displaying a Scaled Image" p.97</p> <p>Color Mode: Select the appropriate color mode according to the type of image and the surroundings. Select the same color mode for all projectors.</p> <p>Brightness Settings: Set the brightness for the light source.  "Setting the Brightness" p.77</p> <p>Color Matching: Corrects the differences in the tint and brightness between images.  "Color Matching" p.96</p> <p>Color Uniformity: Adjusts the color tone balance for the whole screen.  "Color Uniformity" p.212</p> <p>Reset: You can reset all adjustment values for the Multi-Projection menu to their default settings.</p>

Submenu	Function
Schedule Settings	<p>You can set the projector's schedule so that it performs a specific operation at a pre-scheduled time.  "Scheduling Function" p.112</p>
Language	<p>You can set the language for messages and menus.</p>
Reset	<p>You can reset all adjustment values for the Extended menu to their default settings. However, the following items are not reset. Screen Type, Screen Position, Panel Alignment, Color Uniformity, Projection, High Altitude Mode, Auto Source Search, A/V Mute Release, Lens Type, Date & Time, Lens Calibration, A/V Output, Monitor Out, Standby Mode, Control Communications, Extron XTP, Projector ID, Tiling, Edge Blending, Black Level, Scale, Color Mode, Brightness Settings, Color Matching, Language See the following to return all menu items to their default settings.  "Reset Menu" p.162</p>

- * When **User's Logo Protection** is set to **On** in **Password Protection**, you cannot change settings related to user's logo. You can make changes after setting **User's Logo Protection** to **Off**.
 "Managing Users (Password Protection)" [p.115](#)

Network Menu

When **Network Protection** is set to **On** in **Password Protection**, a message is displayed and the network settings cannot be changed. Set **Network Protection** to **Off** and then configure the network.

☛ "Setting Password Protection" [p.115](#)

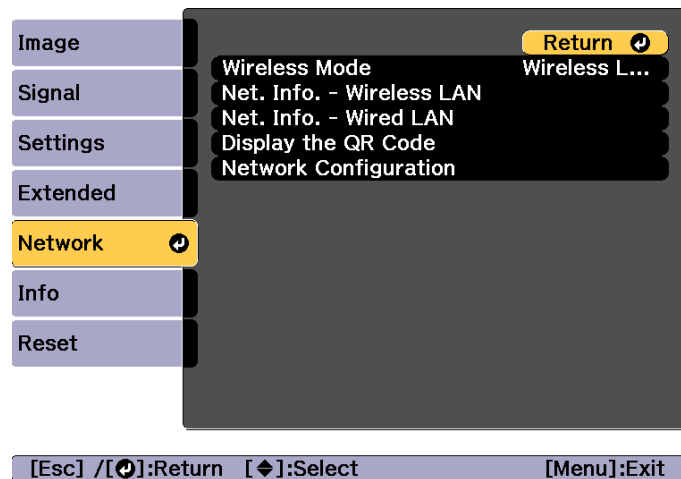

Submenu	Function
Wireless Mode	Set this to Wireless LAN On when connecting the projector and a computer via a wireless LAN. If you do not want to connect via wireless LAN, turn it Off to prevent unauthorized access by others.

Submenu	Function
Net. Info. - Wireless LAN	<p>Displays the following network setting status information.</p> <ul style="list-style-type: none"> • Connection Mode • Wireless LAN system • Antenna Level • Projector Name • SSID • DHCP • IP Address • Subnet Mask • Gateway Address • MAC Address • Region Code <p>When IPv6 is selected, the following information is displayed.</p> <ul style="list-style-type: none"> • IPv6 Address (Manual): IPv6 Address, Prefix Length, Gateway Address • IPv6 Address (Auto): Temporary Address, Link-local Address, Stateless Address, Stateful Address
Net. Info. - Wired LAN	<p>Displays the following network setting status information.</p> <ul style="list-style-type: none"> • Projector Name • DHCP • IP Address • Subnet Mask • Gateway Address • MAC Address • IPv6 Address (Manual): IPv6 Address, Prefix Length, Gateway Address • IPv6 Address (Auto): Temporary Address, Link-local Address, Stateless Address, Stateful Address
Display the QR Code	When connecting iOS or Android devices using Epson iProjection, read the QR code displayed.

Submenu	Function
Network Configuration	The following menus are available for setting Network items. Basic, Wireless LAN, Wired LAN, Notifications, Others, Reset

Notes on operating the Network menu

Selecting from the top menu and sub menus, and changing selected items is the same as making operations from the Configuration menu.

When done, make sure you go to the **Complete** menu, and select **Yes**, **No**, or **Cancel**. When you select **Yes** or **No**, you are returned to the Configuration menu.



Yes: Saves the settings and exits the Network menu.

No: Does not save the settings and exits the Network menu.

Cancel: Continues displaying the Network menu.

Soft keyboard operations

The Network menu contains items that require input of alphanumerics during setup. In this case, the following software keyboard is displayed. Use [▲][▼][◀][▶] buttons to move the cursor to the desired key, and then press the [↵] button to enter the selected character. Enter figures by holding down the [Num] button on the remote control, and pressing the

numeric buttons. After inputting, press **Finish** on the keyboard to confirm your input. Press **Cancel** on the keyboard to cancel your input.



- Each time the CAPS key is selected and the [↵] button is pressed, it sets and changes between upper case and lower case letters.
- Each time the SYM1/2 key is selected and the [↵] button is pressed, it sets and changes the symbol keys for the section enclosed by the frame.

The following types of character can be entered.

Numbers	0123456789
Letters	ABCDEFGHIJKLMNOPQRSTUVWXYZ abcdefghijklmnopqrstuvwxyz
Symbols	!"#\$%&'()*+,-./:;<=>?@[\] ^ _ ` { } ~

Basic menu

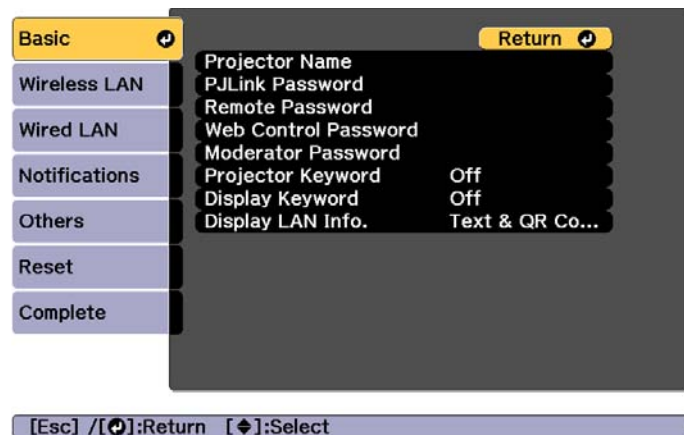

Submenu	Function
Projector Name	Enter the projector name used to identify the projector over a network. When editing, you can enter up to 16 single-byte alphanumeric characters. (" * + , / : ; < = > ? [\] ` and spaces cannot be used.)
PJLink Password	Set a password to use when you access the projector using compatible PJLink software. You can enter up to 32 single-byte alphanumeric characters. (Spaces and symbols cannot be used.) ☛ "About PJLink" p.227
Remote Password	Set a password to use Remote in Epson Web Control. You can enter up to 8 single-byte alphanumeric characters. (* : and spaces cannot be used.) The default user name is "EPSONREMOTE" and the default password is "guest". ☛ "Changing Settings Using a Web Browser (Epson Web Control)" p.215

Submenu	Function
Web Control Password	Set a password for authentication to use when making settings and controlling the projector using Web Control in Epson Web Control. You can enter up to eight single-byte alphanumeric characters (* : and spaces cannot be used). The default user name is "EPSONWEB" and the default password is "admin". ☛ "Changing Settings Using a Web Browser (Epson Web Control)" p.215
Moderator Password	Enter the four digit authentication password for using Epson iProjection when connecting to the projector as a moderator. (There is no default password.)
Projector Keyword	Set this to On to enable a security password to prevent other users from accidentally projecting images. When projecting images from a computer or mobile device, you need to enter the keyword displayed on the projection screen in Epson iProjection.
Display Keyword	When this is set to On and when connecting to the projector using Epson iProjection, the projector keyword is displayed on the projection screen. This is only enabled when Projector Keyword is set to On .
Display LAN Info.	Set the display format for the projector's network information. If you display the QR code, you can connect to a network just by reading the QR code in Epson iProjection. Text & QR Code is set by default.

Wireless LAN menu

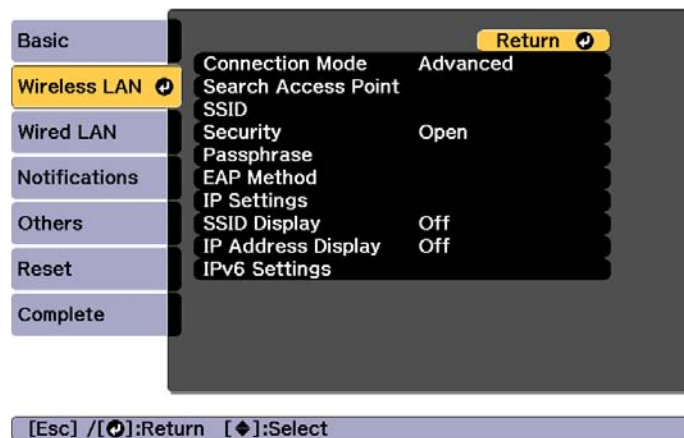

To connect the projector to a computer using a wireless LAN, install the Wireless LAN unit (ELPAP10).

☛ "Installing the Wireless LAN Unit" [p.54](#)



Submenu	Function
Connection Mode	Set the connection mode to use when connecting the projector and a computer via a wireless LAN. Quick: Lets you directly connect to a smartphone, tablet, or computer via a wireless LAN. Advanced: Lets you connect to a smartphone, tablet, or computer over a wireless LAN access point. The connection is established in infrastructure mode.
Search Access Point	When Connection Mode is set to Advanced , you can search for surrounding access points, and set the SSID to be connected from those access points. Depending on the access point settings, they may not be displayed in the list. ☛ "Search Access Point screen" p.156

Submenu	Function
SSID	Enter an SSID. When an SSID is provided for the wireless LAN system in which the projector participates, enter the SSID. You can enter up to 32 single-byte alphanumeric characters.
Security	Select the security type according to the wireless LAN settings. Open: Security is not set. WPA2-PSK: Communication is performed using WPA2 security. Uses AES method for encryption. When establishing a connection from a computer to the projector, enter the value set in the passphrase. WPA/WPA2-PSK*: Connects in WPA personal mode. Encryption method is selected automatically according to the access point settings. Set a passphrase which is the same for the access point. WPA2-EAP*: Communication is performed using WPA2 security. Uses AES method for encryption. WPA/WPA2-EAP*: Connects in WPA enterprise mode. Encryption method is selected automatically according to the access point settings.
Passphrase	Enter a passphrase used to connect to the network when Security is set to WPA2-PSK or WPA/WPA2-PSK . You can enter at least 8 and up to 63 single-byte alphanumeric characters. You can enter up to 32 characters on the Configuration menu. When entering more than 32 characters, use your Web browser to enter the text. ☛ "Changing Settings Using a Web Browser (Epson Web Control)" p.215 When Connection Mode is set to Quick , the initial passphrase is set.

Submenu	Function
EAP Method	<p>Set protocols for WPA2-EAP and WPA/WPA2-EAP authentication.</p> <p>EAP Type: Select the certification protocol.</p> <ul style="list-style-type: none"> • PEAP: Authentication protocol widely used in Windows Server. • PEAP-TLS: Authentication protocol used in Windows Server. Select when using a client certificate. • EAP-TLS: Authentication protocol widely used to use a client certificate. • EAP-FAST, LEAP: Select this when these authentication protocols are used. <p>User name: Enter a user name to be used for authentication. You can enter up to 64 single-byte alphanumeric characters.</p> <p>You can enter up to 32 characters on the Configuration menu. When entering more than 32 characters, use your Web browser to enter the text.</p> <p> "Changing Settings Using a Web Browser (Epson Web Control)" p.215</p> <p>If you also need to enter a domain name, add the domain name before the user name separated by a backslash (domain name\user name).</p> <p>Password: Enter the password used for authentication in PEAP, EAP-FAST, and LEAP. You can enter up to 64 single-byte alphanumeric characters. You can enter up to 32 characters on the Configuration menu. When entering more than 32 characters, use your Web browser to enter the text.</p> <p> "Changing Settings Using a Web Browser (Epson Web Control)" p.215</p> <p>When the password is entered and Finish is selected, the value is set and displayed as an asterisk (*).</p> <p>Client Certificate: Imports client certificates for use in PEAP-TLS and EAP-TLS.</p>

Submenu	Function
	<p>Verify Server Cert.: Set to On to perform verification for the certificate of the certification server. To verify a server certificate, you need to set CA certificate.</p> <p>CA certificate: Imports CA certificates for use in PEAP, PEAP-TLS, EAP-TLS, and EAP-FAST.</p> <p>RADIUS Serv.Name: Specify the name of the certification server. You can enter up to 32 single-byte alphanumeric characters.</p>
Channel	You can select the channels used to connect in Quick mode. If interference from other signals occurs, use a different channel.
IP Settings*	<p>Perform network settings.</p> <p>DHCP: Set to On to configure the network using DHCP. If this is set to On, you cannot set any more addresses.</p> <p>IP Address: Enter the IP address assigned to the projector. You can enter a number from 0 to 255 in each field of the address. However, the following IP addresses cannot be used.</p> <p>0.0.0.0, 127.x.x.x, 224.0.0.0 to 255.255.255.255 (where x is a number from 0 to 255)</p> <p>Subnet Mask: Enter the projector's subnet mask. You can enter a number from 0 to 255 in each field of the address. However, the following subnet masks cannot be used.</p> <p>0.0.0.0, 255.255.255.255</p> <p>Gateway Address: Enter the IP address for the gateway for the projector. You can enter a number from 0 to 255 in each field of the address. However, the following Gateway Address cannot be used.</p> <p>0.0.0.0, 127.x.x.x, 224.0.0.0 to 255.255.255.255 (where x is a number from 0 to 255)</p>
SSID Display	To prevent the SSID from being displayed on the LAN Standby screen, set this to Off .
IP Address Display	To prevent the IP address from being displayed on the LAN Standby screen, set this to Off .

Submenu	Function
IPv6 Settings	<p>Perform settings to use the IPv6 protocols.</p> <div style="border: 1px solid black; padding: 5px; margin: 10px 0;">  <ul style="list-style-type: none"> The following functions support IPv6 protocols. <ul style="list-style-type: none"> Epson Web Control PJLink When setting the IPv6 address manually, make settings in Advanced from Epson Web Control. <ul style="list-style-type: none"> "Changing Settings Using a Web Browser (Epson Web Control)" p.215 </div> <p>IPv6: Set this to On when using IPv6 protocols. Make sure one link local address is set when using IPv6. This is composed of the interface ID created from fe80:: and the projector's MAC address.</p> <p>Auto Configuration: Set this to On to automatically acquire an IPv6 address from RA (Router Advertisement). The address is composed as shown below.</p> <ul style="list-style-type: none"> Stateless Address (0 to 6): Created automatically by combining the prefix acquired from the RA (Router Advertisement) and the interface ID created from the projector's MAC address. Stateful Address (0 to 1): Created automatically from the DHCP server using DHCPv6. <p>Use Temporary Address: Set this to On to temporarily validate the IPv6 address (0 to 1) when Auto Configuration is On.</p>

* This can only be selected when Connection Mode is set to **Advanced**.

Type of security

When the optional wireless LAN unit is attached and being used in Advanced connection mode, it is strongly recommended that you set security.

WPA is an encryption standard that improves the security for wireless networks. The projector supports TKIP and AES encryption methods.

WPA also includes user authentication functions. WPA authentication provides two methods: using an authentication server, or authenticating between a computer and an access point without using a server. This projector supports the latter method, without a server.





For setting details, follow the instructions from your network administrator.

Search Access Point screen

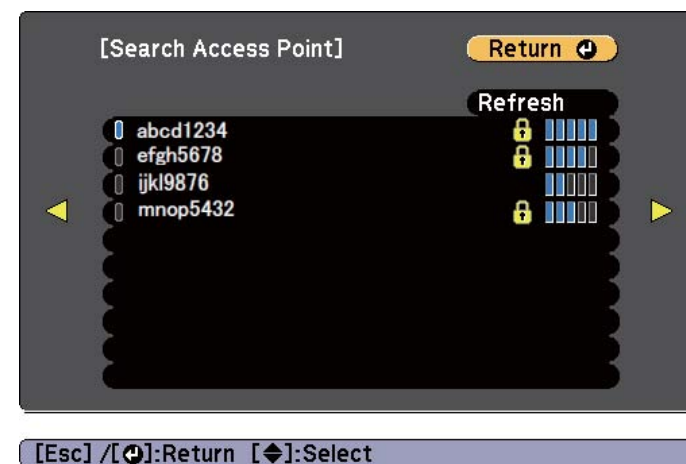
Detected access points are displayed in a list.



Submenu	Function
Refresh	Searches for the access point again.
	Indicates an already set access point.

Submenu	Function
	<p>Indicates the access points where security is set.</p> <p>If you select an access point where security has not been set, the Wireless LAN menu is displayed.</p> <p>If you select an access point where security has been set, the Security menu is displayed. Select a type of security according to the security settings for the access point.</p>

Wired LAN menu

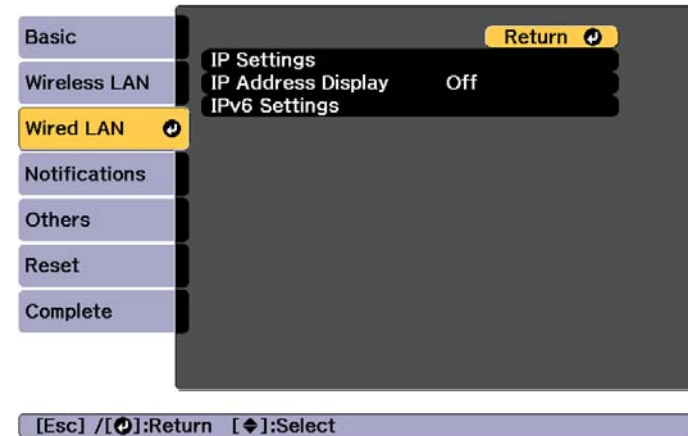

Submenu	Function
IP Settings	<p>You can make settings related to the following addresses.</p> <p>DHCP: Set to On to configure the network using DHCP. If this is set to On, you cannot set any more addresses.</p> <p>IP Address: Enter the IP address assigned to the projector. You can enter a number from 0 to 255 in each field of the address. However, the following IP addresses cannot be used. 0.0.0.0, 127.x.x.x, 224.0.0.0 to 255.255.255.255 (where x is a number from 0 to 255)</p> <p>Subnet Mask: Enter the projector's subnet mask. You can enter a number from 0 to 255 in each field of the address. However, the following subnet masks cannot be used. 0.0.0.0, 255.255.255.255</p> <p>Gateway Address: Enter the IP address for the gateway for the projector. You can enter a number from 0 to 255 in each field of the address. However, the following Gateway Address cannot be used. 0.0.0.0, 127.x.x.x, 224.0.0.0 to 255.255.255.255 (where x is a number from 0 to 255)</p>

Submenu	Function
IP Address Display	To prevent the IP address from being displayed on the LAN Standby screen, set this to Off .
IPv6 Settings	<p>Perform settings to use the IPv6 protocols.</p> <div style="border: 1px solid black; padding: 5px; margin: 10px 0;"> <ul style="list-style-type: none"> • The following functions support IPv6 protocols. <ul style="list-style-type: none"> - Epson Web Control - PjLink • When setting the IPv6 address manually, make settings in Advanced from Epson Web Control. <ul style="list-style-type: none"> ☛ "Changing Settings Using a Web Browser (Epson Web Control)" p.215 </div> <p>IPv6: Set this to On when using IPv6 protocols. Make sure one link local address is set when using IPv6. This is composed of the interface ID created from fe80:: and the projector's MAC address.</p> <p>Auto Configuration: Set this to On to automatically acquire an IPv6 address from RA (Router Advertisement). The address is composed as shown below.</p> <ul style="list-style-type: none"> • Stateless Address (0 to 6): Created automatically by combining the prefix acquired from the RA (Router Advertisement) and the interface ID created from the projector's MAC address. • Stateful Address (0 to 1): Created automatically from the DHCP server using DHCPv6. <p>Use Temporary Address: Set this to On to temporarily validate the IPv6 address (0 to 1) when Auto Configuration is On.</p>

Notifications menu

When this is set, you receive an email notification if a problem or warning occurs in the projector.

☛ "Reading error notification mail" [p.225](#)

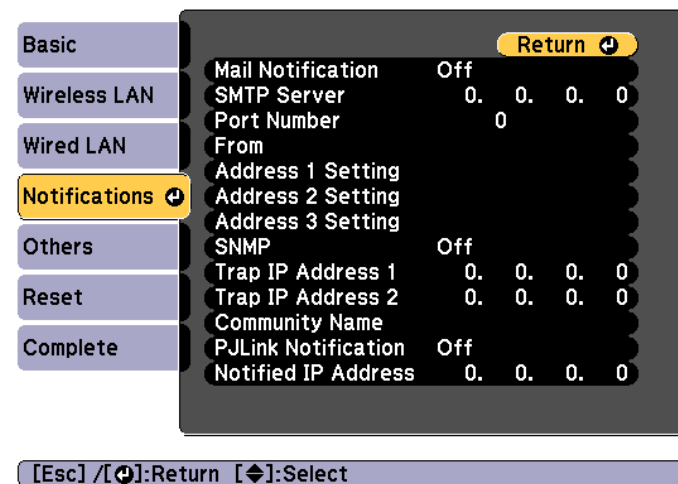

Submenu	Function
Mail Notification	Set to On to send an email to the preset addresses when a problem or warning occurs with a projector.
SMTP Server	You can input the IP Address for the SMTP server for the projector. You can enter a number from 0 to 255 in each field of the address. However, the following IP addresses cannot be used. 127.x.x.x, 224.0.0.0 to 255.255.255.255 (where x is a number from 0 to 255)
Port Number	You can input the port number for the SMTP server. The default value is 25. You can input numbers between 1 to 65535.
From	Enter the email address of the sender. You can enter up to 64 single-byte alphanumeric characters. You can enter up to 32 characters on the Configuration menu. When entering more than 32 characters, use your Web browser to enter the text. (" () , ; < > [\] and spaces cannot be used.) ☛ "Changing Settings Using a Web Browser (Epson Web Control)" p.215

Submenu	Function
Address 1 Setting/ Address 2 Setting/ Address 3 Setting	Set the destination email addresses for the notification email, and the notification content. You can register up to three destinations. You can enter up to 64 single-byte alphanumeric characters. You can enter up to 32 characters on the Configuration menu. When entering more than 32 characters, use your Web browser to enter the text. ("() , ; < > [\] and spaces cannot be used.) ☛ "Changing Settings Using a Web Browser (Epson Web Control)" p.215
SNMP	Set to On to monitor the projector using SNMP. To monitor the projector, you need to install the SNMP manager program on your computer. SNMP should be managed by a network administrator. The default value is Off .
Trap IP Address 1/Trap IP Address 2	You can register up to two IP addresses for the SNMP trap notification destination. You can enter a number from 0 to 255 in each field of the address. However, the following IP addresses cannot be used. 127.x.x.x, 224.0.0.0 to 255.255.255.255 (where x is a number from 0 to 255)
Community Name	Set the community name of SNMP. You can enter up to 32 single-byte alphanumeric characters. (Spaces and symbols cannot be used.)
PJLink Notification	Set this to On to use the PJLink notification function.
Notified IP Address	Enter the IP address of the computer to which you want to send notifications of the projector's operating status using the PJLink notification function. You can enter a number from 0 to 255 in each field of the address. However, the following IP addresses cannot be used. 127.x.x.x, 224.0.0.0 to 255.255.255.255 (where x is a number from 0 to 255)

Others menu

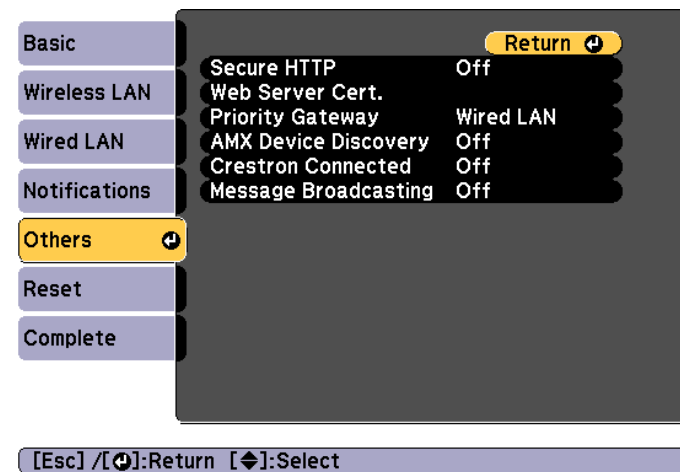

Submenu	Function
Secure HTTP	To strengthen security, communication between the projector and computer in Epson Web Control is encrypted. When setting security with Epson Web Control, we recommend setting this to On .
Web Server Cert.	Imports the Web server certificate used in Secure HTTP.
Priority Gateway	For the priority gateway, select either Wired or Wireless .
AMX Device Discovery	When you want to allow the projector to be detected by AMX Device Discovery, set this to On . Set this to Off if you are not connected to an environment controlled by a controller from AMX or AMX Device Discovery.
Crestron Connected	Set this to On only when monitoring or controlling the projector over the network using Crestron Connected®. Otherwise, set this to Off . ☛ "About Crestron Connected®" p.228 Changes in projector settings take effect upon restarting. When this is set to On , you cannot use the Message Broadcasting feature in Epson Projector Management.

Submenu	Function
Message Broad-casting	Set this to On to receive information sent by the Message Broadcasting feature in the Epson Projector Management software. Download software and User's Guides from the following Web site. http://www.epson.com

Reset menu

Resets all of the network settings.

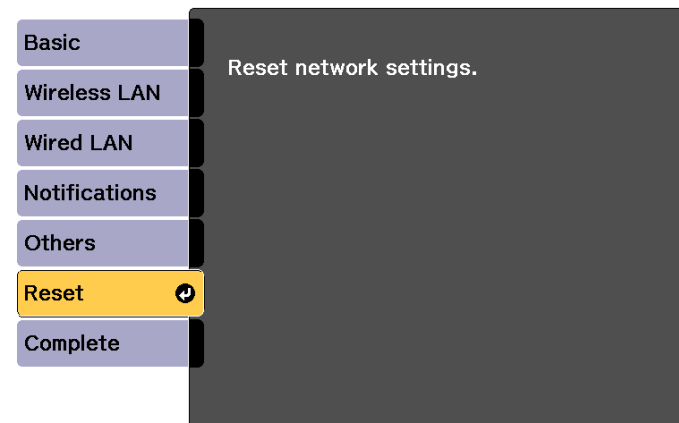

[◆]:Select [⏏]:Enter

Submenu	Function
Reset network settings.	To reset all of the Network settings, select Yes .

Info Menu (Display Only)

Lets you check the status of the image signals being projected and the status of the projector. Items that can be displayed vary depending on the source currently being projected.

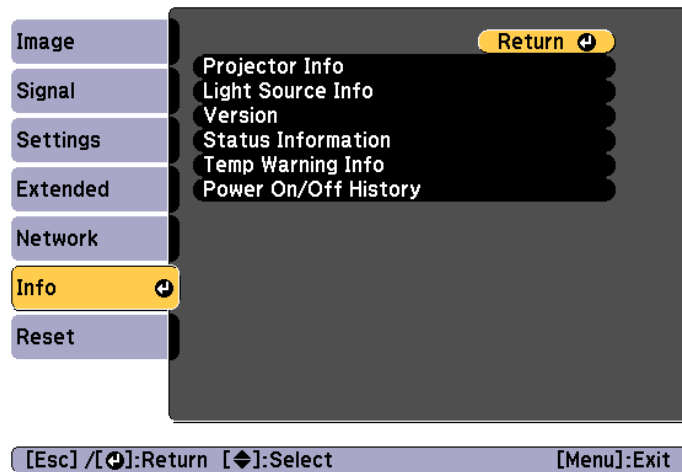

Submenu		Function
Projector Info	Operation Hours*	Displays the operation time after turning on the projector.
	Source	You can display the source name for the connected equipment currently being projected.
	Input Signal	You can display the content of Input Signal set in the Signal menu according to the source.
	Resolution	You can display the resolution.
	Refresh Rate	You can display the Refresh Rate.

Submenu		Function
	Sync Info	You can display the image signal information. This information may be needed if service is required.
	Status	This is information about errors that have occurred on the projector. This information may be needed if service is required.
	Serial Number	Displays the projector's serial number.
	Lens Type	Displays the model number of your lens.
	Event ID	When problems occur when the projector and computer are connected through the network, information on the problem is displayed using an Event ID. See the following page for information on interpreting the Event ID. ☛ "About Event ID" p.201
	HDBaseT Signal Level	Displays the level for the image signal being input from the HDBaseT port. When this is displayed in yellow, the strength of the signal level is reduced. We recommend the following signal levels. <ul style="list-style-type: none"> • 1080p: 16dB or more • 4K: 18dB or more
Light Source Info	Light Source Hours	Displays the operating time for the light source according to the light source mode.
	Estimated Remains	When Constant Brightness is set to On , this displays the amount of time for which the brightness of the light source can be maintained.

Submenu		Function
Version	Main Video2 Sub Sub2 HDMI HDBaseT HDBaseT2	Displays the projector's firmware version information.
Status Information		Displays the projector's status. ☛ "Reading the Status Display" p.182
Temp Warning Info		Displays a high temperature warning. When you select Detail when a Warning or Error is displayed, you can check detailed logs for before and after the error was detected.
Power On/Off History		Displays the power on/off logs.

* The cumulative use time is displayed as "0H" for the first 10 hours. 10 hours and above is displayed as "10H", "11H", and so on.

Reset Menu

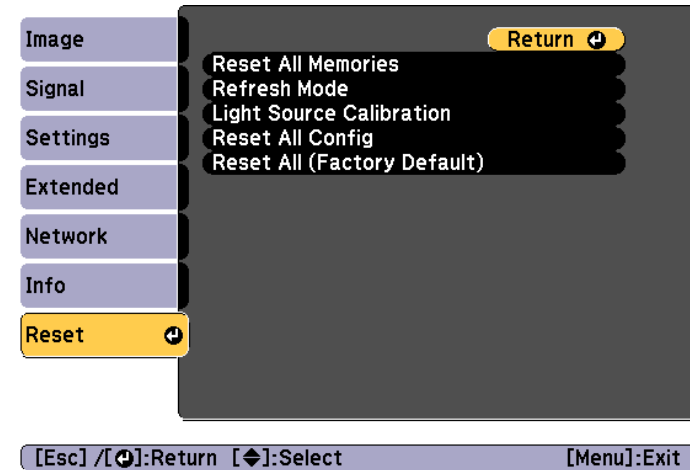

Submenu	Function
Reset All Memories	Resets all names and settings saved in Memory , Lens Position , and Geometry Correction . ☛ "Memory Function" p.110
Refresh Mode	Make settings related to the Refresh Mode. <ul style="list-style-type: none"> • Timer: Select when to run Refresh Mode. • Messages: Select whether or not to display messages during refresh operations. • Start: Removes any afterimages (screen burn-in) that remain in the projected image. The projector turns off once the set time has elapsed. When you press any button on the control panel or remote control, a message is displayed asking if you want to continue using Refresh Mode.

Submenu	Function
Light Source Calibration	<p>Make settings related to Light Source Calibration. When performing Light Source Calibration, the difference between the white balance and the brightness level for the light source is corrected. We recommend running this function periodically.</p> <ul style="list-style-type: none"> • Run Now: Starts Light Source Calibration. This cannot be started in the following cases. <ul style="list-style-type: none"> - Within 20 minutes of turning on the projector. - If the surrounding temperature gets too high, and the brightness has been automatically dimmed. • Run Periodically: When this is set to On, Light Source Calibration is performed every 100 hours of use. When Off is selected to maintain the projected image that has been adjusted using Multi-Projection, perform corrections using Run Now or set the scheduling function to perform Light Source Calibration periodically. • Schedule Settings: Displays the schedule settings screen. Set Light Source Calibration to run periodically. • Last Run: Displays the last date and time Light Source Calibration was performed.
Reset All Config	<p>You can reset all items in the Configuration menu to their default settings.</p> <p>The following items are not reset to their defaults: Input Signal, EDID, Memory, Content Playback, User's Logo, all items for Network menus, Language, Date & Time, Panel Alignment, Color Uniformity, Lens Calibration, Color Matching, Light Source Info, and Operation Hours.</p>
Reset All (Factory Default)	<p>Resets all of the projector's settings. However, Date & Time, Operation Hours, Light Source Info, Password Protection items and their passwords are not reset. You need to enter a password to perform a reset. The default password is set to "0000". Change this to your own desired password.</p>

Once the Configuration menu content has been set for one projector, you can use it to perform batch setup for multiple projectors (batch setup function). The batch setup function is only for projectors with the same model number.

Use one of the following methods.

- Setup using a USB flash drive.
- Setup by connecting the computer and projector with a USB cable.
- Set through Epson Projector Management.

This manual explains the USB flash drive and the USB cable methods.



- The content for Light Source Info and Status Information from the Info menu is not reflected by the batch setup function.
- Perform batch setup before adjusting the projected image. Adjustment values for the projected image, such as Geometry Correction are reflected by the batch setup function. If batch setup is performed after adjusting the projected image, the adjustments you made may change.
- By using the batch setup function, the registered User's Logo is set for the other projectors. Do not register confidential information and so on as the User's Logo.
- If you do not want to copy the following settings, set **Batch Setup Range** to **Limited**.
 - EDID from the **Signal** menu
 - **Network** menu (except for the **Notifications** menu and the **Others** menu)
- ☛ **Extended - Operation - Advanced - Batch Setup Range** [p.146](#)
- Items for which Password Protection is set are not copied.



Caution

Performing batch setup is the customer's responsibility. If batch setup fails due to a power failure, communication error, and so on, the customer is responsible for any repair costs incurred.

Setup Using a USB Flash Drive

This section explains how to perform batch setup using a USB flash drive.



- Use a FAT format USB flash drive.
- The batch setup function cannot be used by USB flash drives that incorporate security functions. Use a USB flash drive that does not incorporate security functions.
- The batch setup function cannot be used by USB card readers or USB hard disks.

Saving settings to the USB flash drive

- 1** Disconnect the power cord from the projector, and check that all of the projector's indicators have turned off.
- 2** Connect a USB flash drive to the projector's USB-A port (the wireless LAN module installation section).
 - ☛ "Installing the Wireless LAN Unit" [p.54](#)

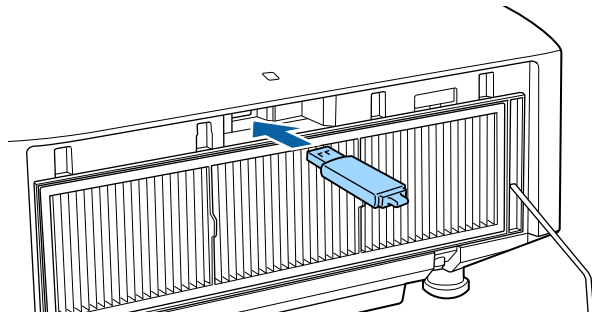

- Connect the USB flash drive directly to the projector. If the USB flash drive is connected to the projector through a USB hub, the settings may not be saved correctly.
- Connect an empty USB flash drive. If the USB flash drive contains data other than the batch setup file, the settings may not be saved correctly.
- If you have saved a batch setup file from another projector to the USB flash drive, delete the file or change the file name. The batch setup function cannot overwrite a batch setup file.
- The file name for the batch setup file is PJCONFDATA.bin. If you need to change the file name, add text after PJCONFDATA. If you change the file name in any other way, the projector may not be able to recognize the file correctly.
- You can only use single-byte characters for the file name.

- 3** While holding down the [Esc] button on the remote control or the control panel, connect the power cord to the projector.

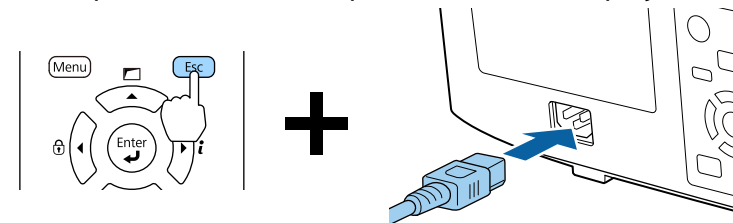

When the projector's indicators turn on as follows, release the [Esc] button.

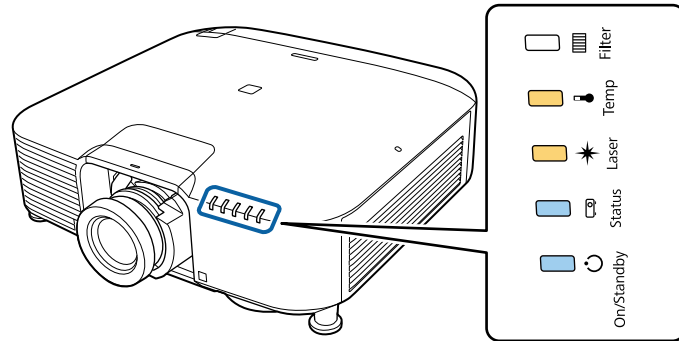

Power supply	Status	Laser	Temp
Blue - On	Blue - On	Orange - On	Orange - On

When all of the indicators start flashing, the batch setup file is being written.

⚠ Caution

- Do not disconnect the power cord from the projector while the file is being written. If the power cord is disconnected, the projector may not start correctly.
- Do not disconnect the USB flash drive from the projector while the file is being written. If the USB flash drive is disconnected, the projector may not start correctly.

When writing completes normally, the projector enters standby status.

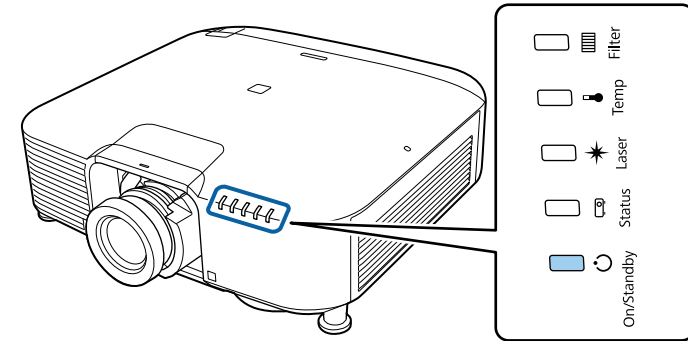

Power
Blue - On

When the projector is in standby status, remove the USB flash drive.

Reflecting saved settings to other projectors

- 1** Disconnect the power cord from the projector, and check that all of the projector's indicators have turned off.
- 2** Connect the USB flash drive on which the settings are saved to the projector's USB-A port (the wireless LAN module installation section).

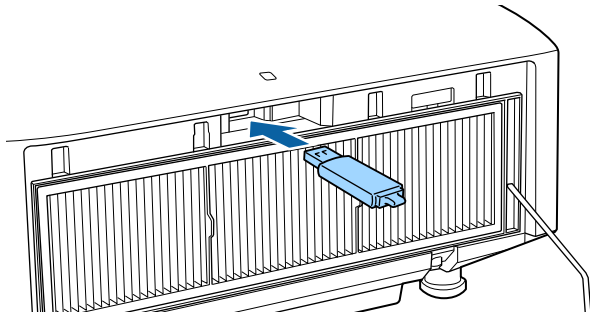

- When the USB flash drive contains 1 to 3 types of batch setup files, the file is reflected to the projector with the same model number. If there are multiple files for a projector with the same model number, the settings may not be reflected correctly.
- When there are four or more types of batch setup files on the USB flash drive, the settings may not be reflected correctly.
- Do not store any data except for the batch setup file on the USB flash drive. If the USB flash drive contains data other than the batch setup file, the settings may not be reflected correctly.

- 3** While holding down the [Menu] on the remote control or the control panel, connect the power cord to the projector.

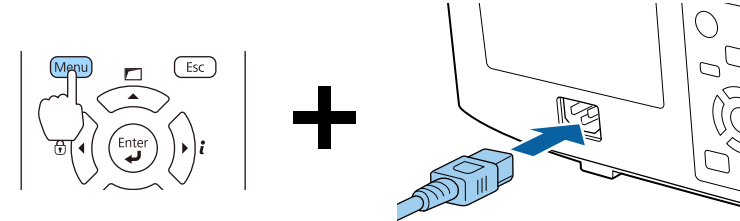

When the projector's indicators turn on as follows, release the [Menu] button.

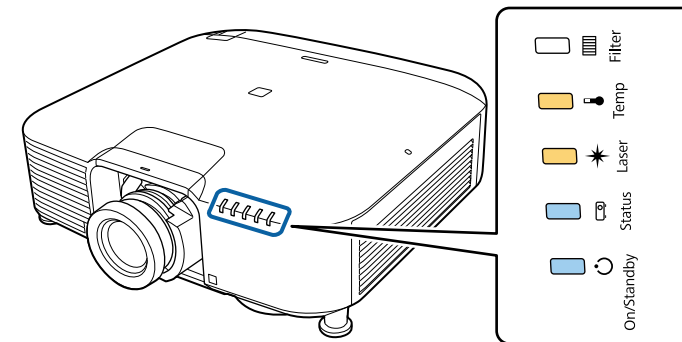

Power supply	Status	Laser	Temp
Blue - On	Blue - On	Orange - On	Orange - On

The indicators remain on for about 75 seconds.

When all of the indicators start flashing, the settings are being written.

Caution

- Do not disconnect the power cord from the projector while the settings are being written. If the power cord is disconnected, the projector may not start correctly.
- Do not disconnect the USB flash drive from the projector while the settings are being written. If the USB flash drive is disconnected, the projector may not start correctly.

- 4** When writing completes normally, the projector enters standby status.

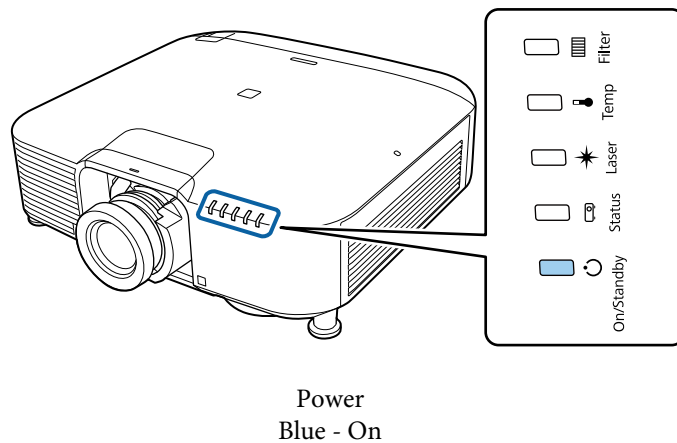

When the projector is in standby status, remove the USB flash drive.

Setup by Connecting the Computer and Projector with a USB Cable



The following operating systems support the batch setup function.

- Windows Vista or later
- Mac OS X 10.7.x or later

Saving settings to a computer

- 1** Disconnect the power cord from the projector, and check that all of the projector's indicators have turned off.
- 2** Connect the computer's USB port to the projector's Service port with a USB cable.

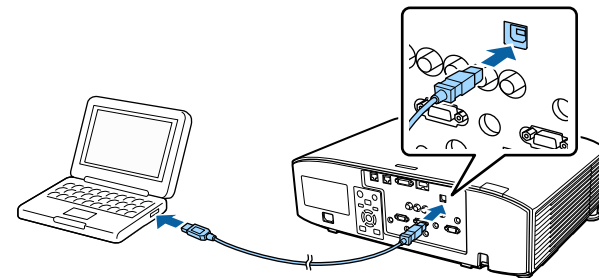

- 3** While holding down the [Esc] button on the remote control or the control panel, connect the power cord to the projector.

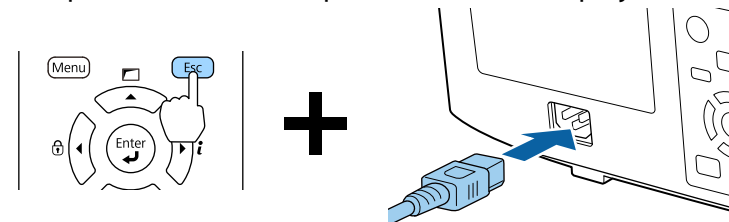

When the projector's indicators turn on as follows, release the [Esc] button.

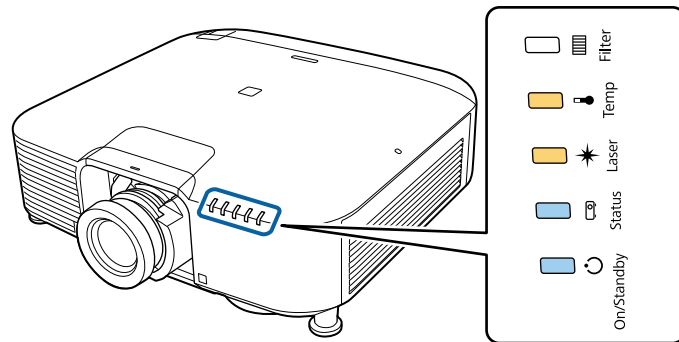

Power supply	Status	Laser	Temp
Blue - On	Blue - On	Orange - On	Orange - On

The projector is recognized as a removable disk by the computer.

- 4 Open the removable disk, and save the batch setup file (PJCONFDATA.bin) to the computer.

 If you need to change the name of the batch setup file, add text after PJCONFDATA. If you change the file name, the projector may not be able to recognize the file correctly.

- 5 Perform "Remove USB device" on your computer, and then disconnect the USB cable.

 When using Mac, perform "Remove EPSON_PJ".

The projector enters standby status.

Reflecting saved settings to other projectors

- 1 Disconnect the power cord from the projector, and check that all of the projector's indicators have turned off.
- 2 Connect the computer's USB port to the projector's Service port with a USB cable.

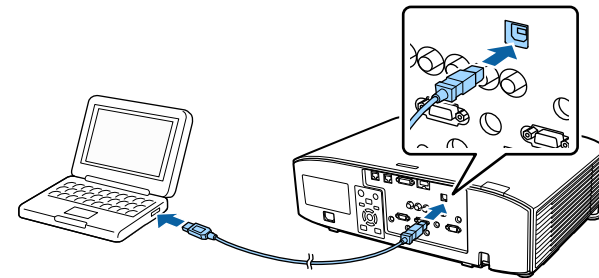

- 3** While holding down the [Menu] on the remote control or the control panel, connect the power cord to the projector.

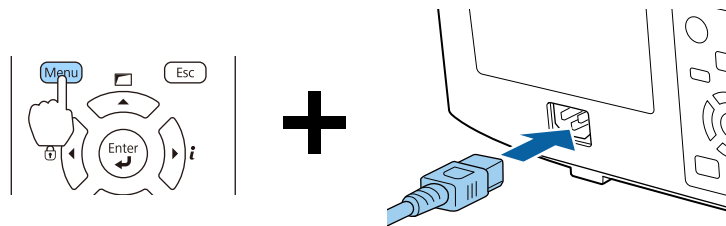

When the projector's indicators turn on as follows, release the [Menu] button.

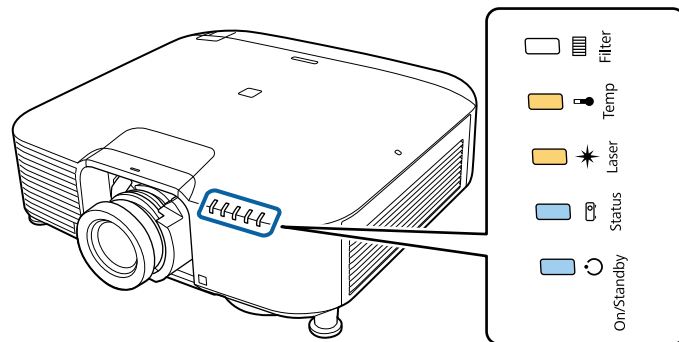

Power supply	Status	Laser	Temp
Blue - On	Blue - On	Orange - On	Orange - On

The projector is recognized as a removable disk by the computer.

- 4** Copy the batch setup file (PJCONFDATA.bin) that you saved to your computer to the top level folder of the removable disk.

 Do not copy any files or folders other than the batch setup file to the removable disk.

- 5** Perform "Remove USB device" on your computer, and then disconnect the USB cable.

 When using Mac, perform "Remove EPSON_PJ".

When all of the indicators start flashing, the settings are being written.

 **Caution**

Do not disconnect the power cord from the projector while the settings are being written. If the power cord is disconnected, the projector may not start correctly.

When writing completes normally, the projector enters standby status.

When Setup Fails

The Indicators notify you if an error occurs. Check the status of the indicators.

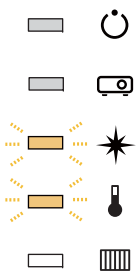
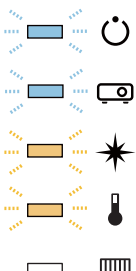
Status of the Indicators	Remedy
 <p>Laser: Orange - flashing fast Temp: Orange - flashing fast</p>	<p>The batch setup file may be corrupt, or the USB flash drive may not be connected correctly. Disconnect the USB flash drive, unplug and then plug in the projector's power cord, and then try again.</p>
 <p>Power: Blue - flashing fast Status: Blue - flashing fast Laser: Orange - flashing fast Temp: Orange - flashing fast</p>	<p>Writing the settings may have failed and an error may have occurred in the projector's firmware. Stop using the projector, remove the power plug from the electrical outlet, and contact your local dealer or the nearest address provided in the Epson Projector Contact List. Epson Projector Contact List</p>



Troubleshooting

This chapter explains how to identify problems and what to do if a problem is found.

If a problem occurs with the projector, you can display the Help screen to assist you. You can also set the projector to an appropriate state by answering the questions.

- 1 Press the [**Home**] button.

The Home screen is displayed.

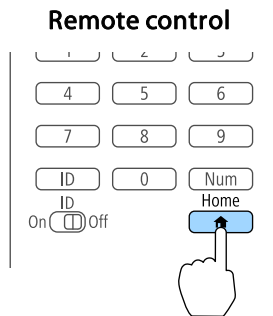

- 2 Select Help, and then press the [**Enter**] button.

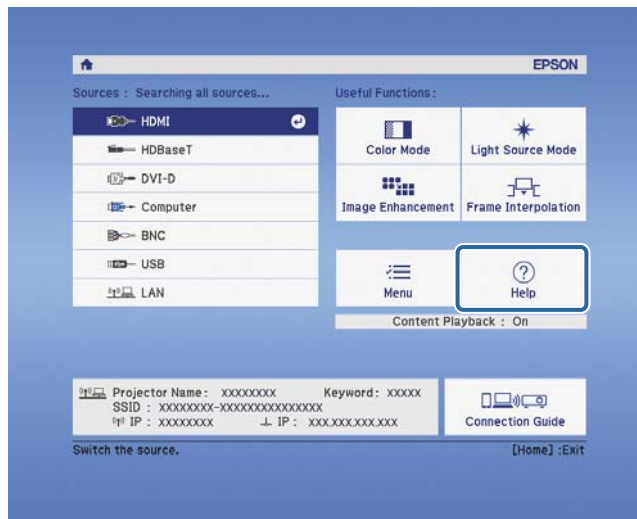

The Help screen is displayed.

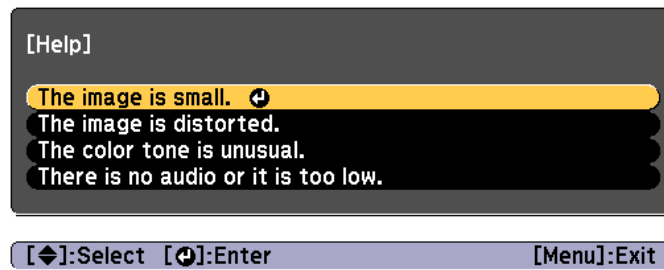

- 3 Select a menu item.

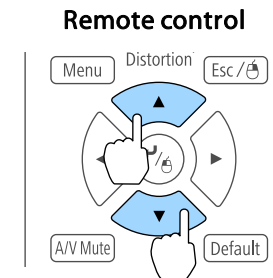

- 4 Confirm the selection.

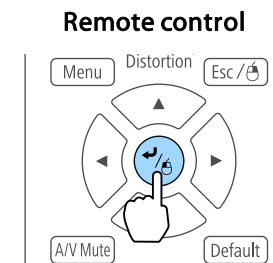

Questions and solutions are displayed as shown on the screen below. Press the [Menu] button to exit Help.

The image is small.

- ❓ Is zoom set to minimum?
· Press the [Zoom] button to change the size of the image.
- ❓ Is the projector too close to the screen?
· Move the projector away from the screen.

[Esc] :Return

[Help] :Exit



See the following if the Help function does not provide a solution to the problem.

☞ "Reading the Indicators" [p.175](#)



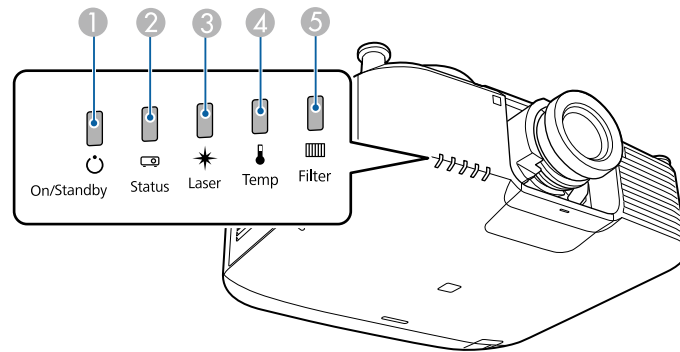







This projector has the following five indicators to indicate the projector's status.





























- ① Power indicator
Indicates the projector's status.
- ② Status indicator
Indicates the projector's status.
- ③ Laser indicator
Indicates the light source status.
- ④ Temp indicator
Indicates the internal temperature status. This is normally turned off.
- ⑤ Filter indicator
Indicates the air filter status. This is normally turned off.

The following indicator status are used during regular operation.





















"Status varies" indicates that the indicators turn on, off, or flash depending on the status of the projector.



























Indicator					Projector's Status	Explanation
Power supply	Status	Laser	Temp	Filter		
 Blue - On	 Off	 Off	 Off	 Off	Standby condition Network monitoring status	Power is being supplied to the projector. In this status, you can start projecting by pressing the [①] button on the remote control or control panel. (Sometimes, when the power cord is unplugged, the power indicator remains lit for a short period, but this is not a fault.) The projector is being monitored and controlled over a network (when Standby Mode is set to Communication On). If the power cord is disconnected and then reconnected in this status, the power indicator flashes blue.
 Blue - On	 Blue - Flashing	 Status varies	 Off	 Off	Warm-up status	This is the status immediately after turning on the projector. Warm-up takes approximately 30 seconds after the light source turns on. The [⏻] button is disabled during warm-up.















Indicator					Projector's Status	Explanation
Power supply	Status	Laser	Temp	Filter		
 Blue - On	 Blue - On	 Status varies	 Off	 Off	Projecting	The projector is projecting.
 Blue - On	 Blue - Flashing	 Off	 Off	 Off	Cool down status	This is the status immediately after turning off the power. In this status, all buttons are disabled.
 Blue - Flashing	 Off	 Off	 Off	 Off	Preparing Network monitoring	Preparing to monitor and control this projector over a network. During network monitoring preparation, all button operations are disabled.
 Blue - On	 Blue - On	 Blue - Flashing	 Off	 Off	A/V Mute activated	A/V Mute is active.
 Status varies	 Blue - Flashing	 Orange - Flashing	 Status varies	 Status varies	Refresh Mode activated	Refresh Mode is active.  Reset - Refresh Mode p.162















When an error has occurred in the projector, the error status is indicated by the indicator's color and combination of flashing or lit.

Refer to the following table to see what the indicators mean and how to remedy problems that they indicate.

Indicator					Cause	Remedy or Status
Power supply	Status	Laser	Temp	Filter		
 Off	 Blue - Flashing	 Orange - Flashing	 Off	 Off	Internal Error	Stop using the projector, remove the power plug from the electrical outlet, and contact your local dealer or the nearest address provided in the Epson Projector Contact List.  Epson Projector Contact List
 Off	 Blue - Flashing	 Off	 Orange - Flashing	 Off	Fan Error Sensor Error	Stop using the projector, remove the power plug from the electrical outlet, and contact your local dealer or the nearest address provided in the Epson Projector Contact List.  Epson Projector Contact List
 Off	 Blue - Flashing	 Off	 Orange - On	 Off	High Temp Error (Overheating)	The light source turns off automatically and projection stops. Wait for about five minutes. After about five minutes, the projector switches to standby mode, so check the following three points. <ul style="list-style-type: none"> • Check that the air filter, air exhaust vent, and air intake vent are clear, and that the projector is not positioned against a wall. • Check if the temperature around the air intake is too high. • If the air filter are clogged, remove the power cord from the electrical outlet, and then clean or replace them. <ul style="list-style-type: none">  "Cleaning the Air Filter and Air Intake Vent" p.204  "Replacing the Air Filter" p.208 If the error continues after checking the points above, stop using the projector, remove the power plug from the electrical outlet, and contact your local dealer or the nearest address provided in the Epson Projector Contact List.  Epson Projector Contact List
						When using at an altitude of 1500 m or more, set High Altitude Mode to On .  Extended - Operation - High Altitude Mode p.146

Indicator					Cause	Remedy or Status
Power supply	Status	Laser	Temp	Filter		
 Off	 Blue - Flashing	 Orange - On	 Off	 Off	Laser Error Retardation Plate Error	Stop using the projector, remove the power plug from the electrical outlet, and contact your local dealer or the nearest address provided in the Epson Projector Contact List.  Epson Projector Contact List
 Off	 Blue - Flashing	 Off	 Off	 Orange - On	Filter Airflow Error	Check the following two points. <ul style="list-style-type: none"> • Check that the air filter and air exhaust vents are clear, and that the projector is not positioned against a wall. • If the air filter is clogged, turn off the power, remove the power cord from the electrical outlet, and then clean or replace them.  "Cleaning the Air Filter and Air Intake Vent" p.204  "Replacing the Air Filter" p.208 After checking, connect the power cord to the electrical outlet. If the error continues after checking the points above, stop using the projector, remove the power plug from the electrical outlet, and contact your local dealer or the nearest address provided in the Epson Projector Contact List.  Epson Projector Contact List
 Off	 Blue - Flashing	 Orange - On	 Orange - On	 Off	Lens Shift Error	Stop using the projector, remove the power plug from the electrical outlet, and contact your local dealer or the nearest address provided in the Epson Projector Contact List.  Epson Projector Contact List
 Off	 Blue - Flashing	 Orange - On	 Orange - On	 Off	Lens Error No Lens	Install the lens unit. If the lens unit is already installed, remove it and then reinstall it. If the error continues after checking the points above, stop using the projector, remove the power plug from the electrical outlet, and contact your local dealer or the nearest address provided in the Epson Projector Contact List.  Epson Projector Contact List

Indicator					Cause	Remedy or Status
Power supply	Status	Laser	Temp	Filter		
 Blue - Flashing	 Status varies	 Status varies	 Orange - Flashing	 Status varies	High Temp Warning	This is not an error. However, if the temperature rises too high again, projection stops automatically. Check the following three points. <ul style="list-style-type: none"> • Check that the air filter, air exhaust vent, and air intake vent are clear, and that the projector is not positioned against a wall. • Check if the temperature around the air intake is too high. • If the air filter is clogged, turn off the power, remove the power cord from the electrical outlet, and then clean or replace them. <ul style="list-style-type: none"> ☛ "Cleaning the Air Filter and Air Intake Vent" p.204 ☛ "Replacing the Air Filter" p.208
 Blue - Flashing	 Status varies	 Orange - Flashing	 Status varies	 Status varies	Laser Warning	Stop using the projector, remove the power plug from the electrical outlet, and contact your local dealer or the nearest address provided in the Epson Projector Contact List. ☛ Epson Projector Contact List
 Blue - Flashing	 Status varies	 Orange - Flashing	 Status varies	 Status varies	Lens Warning	An unsupported lens is attached. Use a supported lens. ☛ "Optional Accessories and Consumables" p.233

Indicator					Cause	Remedy or Status
Power supply	Status	Laser	Temp	Filter		
 Blue - Flashing	 Status varies	 Status varies	 Status varies	 Orange - On	Low Air Flow	<p>This is not an error. However, projection stops automatically if the airflow falls any further. The message "The air filter is clogged. Clean or replace the air filter." is displayed. Check the following two points.</p> <ul style="list-style-type: none"> • Check that the air filter and air exhaust vents are clear, and that the projector is not positioned against a wall. • If the air filter is clogged, turn off the power, remove the power cord from the electrical outlet, and then clean or replace them. <ul style="list-style-type: none"> ☛ "Cleaning the Air Filter and Air Intake Vent" p.204 ☛ "Replacing the Air Filter" p.208 <p>If the error continues after checking the points above, stop using the projector, remove the power plug from the electrical outlet, and contact your local dealer or the nearest address provided in the Epson Projector Contact List.</p> <p>☛ Epson Projector Contact List</p>
 Status varies	 Status varies	 Status varies	 Status varies	 Orange - Flashing	Air Filter Notice	<p>"Time to clean the air filter. Clean or replace the air filter." is displayed. Turn off the projector's power, unplug the power cord from the electrical outlet, and then clean the air filter.</p> <p>☛ "Cleaning the Air Filter and Air Intake Vent" p.204</p> <p>The indicators or messages regarding air filter notice are displayed only when Air Filter Notice is set to On in the Configuration menu.</p> <p>☛ Extended - Display - Air Filter Notice p.146</p>
 Status varies	 Status varies	 Orange - Flashing	 Status varies	 Status varies	Constant Brightness End	<p>Ends the Constant Brightness mode in Brightness Settings.</p> <p>☛ "Setting the Brightness" p.77</p>



- See the following if the projector is not operating properly, even though the indicators are all showing normal.
 - ☛ "Problem Solving" [p.190](#)
- If the indicators are in a state not shown in this table, stop using the projector, remove the power plug from the electrical outlet, and contact your local dealer or the nearest address provided in the Epson Projector Contact List.
 - ☛ [Epson Projector Contact List](#)

You can display the operating status of the projector on the projected image. You can check the detailed status of the projector by using button operations.

1 Press the [i] button while projecting.

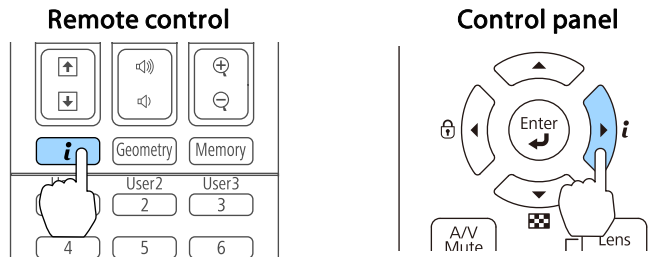

2 Select **Status Information**, and then press the [↵] button.

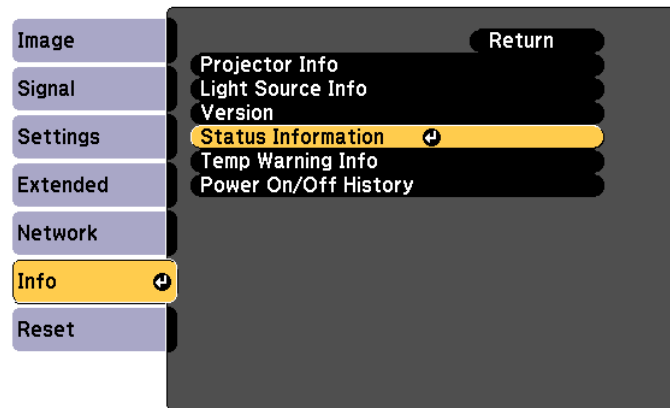

[Esc]:Return [↵]:Select [↵]:Enter [Menu]:Exit



You can also operate from the Configuration menu.

☞ **Info - Status Information** p.161

3 Use the [◀][▶] buttons or the [▲][▼] buttons to select a category.

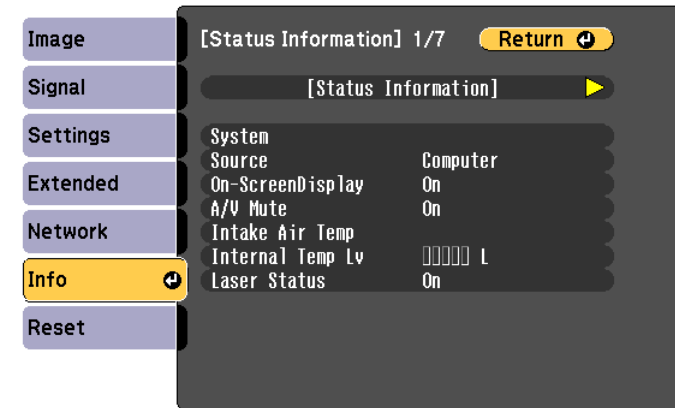

[Esc]/[↵]:Return [◀▶]:Select [Menu]:Exit

Each display category contains the following information.

- Status Information : Operating status of the projector
- Source : Input signal information
- Signal Information : Input digital signal information
- Network Wired : Wired LAN settings
- Network Wireless : Wireless LAN settings
- Maintenance : Operating time for the projector and light source
- Version : Projector's firmware version

Explanations of the Display Content

Category	Item	Status Display	Explanation
Status Information	System	Displays the projector's status. See the following for more information on how to remedy the errors and warnings. ☛ "Reading the Indicators" p.175	
		OK	The projector is in normal status.
		Warm-Up	The projector is warming up.
		Standby	The projector is in standby status.
		Cool Down	The projector is in cool down status.
		Temp Error	A high temp error has occurred.
		Fan Error	A fan error has occurred.
		Sensor Error	A sensor error has occurred.
		Power Error	A power error (Ballast) has occurred.
		Internal Error	An internal error has occurred.
		Airflow Error	A filter airflow error has occurred.
		Temp Warning	A high temp warning has occurred.
		Internal Warning	A warning about the internal system has occurred.
		Airflow Decline	A low air flow error has occurred.
		Power Warning	A power warning (Ballast) has occurred.
		Clean Filter	An air filter notice has occurred.
		Lens Error	A lens error has occurred.
		Laser Error	A laser error has occurred.
		Laser Warning	A laser warning has occurred.
		Temp Error FE	A laser error has occurred because the laser temperature is too high.
Temp Warning FE	A laser warning has occurred because the laser temperature is too high.		

Category	Item	Status Display	Explanation
Status Information	Source	HDMI	Displays the source name for the connected equipment currently being projected.
		HDBaseT	
		DVI-D	
		Computer	
		BNC	
		USB	
		LAN	
	On-Screen Display	On	Displays the settings for the On-Screen Display . When set to Off , the menus or messages are not displayed on the projected images.
		Off	
	A/V Mute	On	Displays the operating status of A/V mute.
		Off	
	Intake Air Temp	–	Displays the air intake temperature.
	Internal Temp Lv	–	Displays the projector's internal temperature.
Laser Status	On	Displays the operating status of the light source.	
	Off		
Source	Source	HDMI	Displays the source name for the connected equipment currently being projected.
		HDBaseT	
		DVI-D	
		Computer	
		BNC	
		USB	
		LAN	
	Resolution	–	Displays the resolution of the current input signal. No Signal: No signals are being input. Not Supported: The projector does not support the current input signal.

Category	Item	Status Display	Explanation
Source	Color Space	RGB	Displays the color space of the current input signal.
		YCbCr	
		YPbPr	
	H-Frequency	–	Displays the horizontal frequency of the current input signal.
	V-Frequency	–	Displays the vertical frequency of the current input signal.
	Sync Polarity	H:Posi / V:Posi	Displays the Sync polarity.
		H:Posi / V:Nega	
		H:Nega / V:Posi	
		H:Nega / V:Nega	
	Sync Mode	Composite Sync	Displays the sync type.
		Separate Sync	
		Sync On Green	
	Detected Mode	–	Displays the discriminant resolution of the current input signal.
	Transport	Interlace	Displays the scanning method.
		Progressive	
	Video Range	Auto(Limited)	Displays the video level of the projector.
Auto(Full)			
Limited(16-235)			
Full(0-255)			



Items displayed for source vary depending on the model being used and the image signal and source being projected.

Category	Item	Status Display	Explanation
Signal Information	5V Detect	Detected	Displays the detection results of 5V signals.
		Not Detect	
	TMDS Clock	–	Displays the TMDS frequency of the current input signal.
	H-Frequency	–	Displays the horizontal frequency of the current input signal.
	V-Frequency	–	Displays the vertical frequency of the current input signal.
	DetChg 5CFHMP123	–	Displays the factors of signal changes.
	Stable Time	–	Displays the operating time since the input source is determined.
	HDCP Status	Non-HDCP	Displays the HDCP status.
		Passed	
		Failed	
	HDCP Ri	–	
	HDCP AKSV	–	
	HDCP An	–	
	HDCP Ver	–	Displays the HDCP version.
	AVI VIC	–	Displays the VIC information (AVI) of the current input signal.
	AVI Checksum	OK	Displays the checksum result for AVI.
		NG	
	AVI Sampling Str	RGB4:4:4	Displays color sampling for AVI.
		YCbCr4:4:4	
		YCbCr4:2:2	
YCbCr4:2:0			
Signal Mode	HDMI	Displays the signal mode.	
	DVI		
EDID Mode	–	Displays the EDID mode.	
HDBaseT Level	–	You can display the image signal information from the HDBaseT port.	



Items displayed for Signal Information vary depending on the model being used and the image signal and source being projected.











Category	Item	Status Display	Explanation
Network Wired	Projector Name	–	Displays the projector name used to identify the projector when connected to a network.
	Connection Mode	HDBaseT	Displays the connection path for LAN.
		LAN	
	DHCP	On	Displays the DHCP settings.
		Off	
	IP Display	On	Displays the IP address display settings.
		Off	
IP Address	–	Displays the IP address.	
MAC Address	–	Displays the MAC address.	
Network Wireless	Projector Name	–	Displays the projector name used to identify the projector when connected to a network.
	Connection Mode	Quick	Displays the connection mode to use when connecting the projector and a computer over a wireless LAN.
		Advanced	
	SSID Display	On	Displays the SSID display settings.
		Off	
	IP Display	On	Displays the IP address display settings.
		Off	
	SSID	–	Displays the SSID.
	IP Address	–	Displays the IP address.
	DHCP	On	Displays the DHCP settings.
		Off	
	MAC Address	–	Displays the MAC address.
	Security	No	Displays the security settings.
WPA2-PSK			
WPA/WPA2-PSK			
Antenna Level	LEVEL 0-5	Displays the reception status for Wi-Fi.	



Category	Item	Status Display	Explanation
Maintenance	Operation Time	–	Displays the total operation time of the projector.
	Laser Op.Time	–	Displays the laser operating time for each setting in Light Source Mode.
Version	Serial No.	–	Displays the projector's serial number.
	Main	–	Displays the projector's firmware version information.
	Video2	–	
	Sub	–	
	Sub2	–	
	HDMI	–	
	HDBaseT	–	
	HDBaseT2	–	

If any of the following problems occur and the indicators do not offer a solution, refer to the pages given for each problem.

Problems Relating to Images

<ul style="list-style-type: none"> • No images appear Projection does not start, the projection area is completely black, or the projection area is completely blue. 	 p.191
<ul style="list-style-type: none"> • Moving images are not displayed Videos played back on a computer are black or no image is projected, or the video is not played back on the computer. 	 p.191
<ul style="list-style-type: none"> • Projection stops automatically 	 p.192
<ul style="list-style-type: none"> • The message "Not supported" is displayed 	 p.192
<ul style="list-style-type: none"> • "No Signal" is displayed 	 p.192
<ul style="list-style-type: none"> • Images are fuzzy, out of focus, or distorted 	 p.193
<ul style="list-style-type: none"> • Interference or distortion appear in images 	 p.193
<ul style="list-style-type: none"> • The image is truncated (large) or small, the aspect ratio is not suitable, or the image has been reversed Only part of the image is displayed, the height and width ratios of the image are not correct, or the image may appear reversed from top to bottom or left to right. 	 p.194
<ul style="list-style-type: none"> • Image colors are not right The whole image appears purplish or greenish, images are black & white, or colors appear dull. 	 p.195
<ul style="list-style-type: none"> • Images appear dark 	 p.195







Problems when Projection Starts

<ul style="list-style-type: none"> • The projector does not turn on 	 p.196
---	---

Problems with Content Playback Mode

<ul style="list-style-type: none"> • Cannot play the playlist 	 p.197
---	---

Other Problems

<ul style="list-style-type: none"> • There are afterimages (screen burn-in) in the projected image 	 p.197
<ul style="list-style-type: none"> • No sound can be heard or the sound is faint 	 p.198
<ul style="list-style-type: none"> • The remote control does not work 	 p.198
<ul style="list-style-type: none"> • Nothing appears on the external monitor 	 p.199
<ul style="list-style-type: none"> • I want to change the language for messages and menus 	 p.199
<ul style="list-style-type: none"> • Email is not received even if a problem occurs in the projector 	 p.200
<ul style="list-style-type: none"> • "The battery that saves your clock settings is running low." is displayed 	 p.200

Problems Relating to Images

No images appear

Check	Remedy
Did you press the [ⓘ] button on the remote control or control panel?	Press the [ⓘ] button to turn on the power.
Are the indicators switched off?	The power cord is not connected correctly or power is not being supplied. Connect the projector's power cord correctly. Check that your electrical outlet or power source is functioning correctly.
Is A/V Mute active?	Press the [A/V Mute] button to release A/V Mute. ☛ "Hiding the Image and Sound Temporarily (A/V Mute)" p.102
Are the Configuration menu settings correct?	Reset all of the settings. ☛ Reset - Reset All Config p.162
Is the image to be projected completely black? (Only when projecting computer images)	Some input images, such as screen savers, may be completely black.
Is Windows Media Center displayed in full screen? (Only during network connection)	When Windows Media Center is displayed at full screen, you cannot project using a network connection. Reduce the screen size.
Is an application using the Windows DirectX function displayed? (Only during network connection)	Applications using the Windows DirectX function may not display images correctly.

Moving images are not displayed

Check	Remedy
Is the computer's image signal being output to the LCD and the monitor? (Only when projecting images from a laptop computer or a computer with a built-in LCD screen)	Change the image signal from the computer to external output only. Check your computer's documentation, or contact the computer's manufacturer.
Are the contents of the moving image you are trying to project copyright protected?	The projector may not be able to project copyright protected moving images that are being played back on a computer. For more details, see the user's guide supplied with the player.

Projection stops automatically

Check	Remedy
Is Sleep Mode set to On ?	Press the [ⓘ] button to turn on the power. If you do not want to use Sleep Mode, change the setting to Off . ☛ Extended - Operation - Sleep Mode p.146

"Not supported" is displayed

Check	Remedy
Do the image signal resolution and the refresh rate correspond to the mode? (Only when projecting computer images)	Refer to the computer's documentation for how to change the image signal resolution and the refresh rate output from the computer. ☛ "Supported Monitor Displays" p.274

"No Signal" is displayed

Check	Remedy
Are the cables connected correctly?	Check that all the cables required for projection are securely connected. Check that no cables are disconnected and that there are no poor contacts in the cables.
Is the correct port selected?	Change the image by pressing the [Search] button. ☛ "Automatically Detecting Input Signals and Changing the Projected Image (Source Search)" p.61
Is the power for the computer or video source turned on?	Turn the power on for the equipment.
Are the image signals being output to the projector? (Only when projecting images from a laptop computer or a computer with a built-in LCD screen)	If the image signals are only being output to the computer's LCD monitor or to the accessory monitor, you need to change the output to an external destination as well as the computer's own monitor. For some computer models, when the image signals are output externally, they no longer appear on the LCD monitor or accessory monitor. If the connection is made while the power of the projector or computer is already turned on, the Fn key (Function key) that changes the computer's image signal to external output may not work. Turn the power for the computer and the projector off and then back on again. ☛ Computer's documentation

Images are fuzzy, out of focus, or distorted

Check	Remedy
Is the focus adjusted correctly?	Make sure that at least 20 minutes has passed after the projection starts, and press the [Focus] button on the remote control to adjust the focus. ☛ "Correcting the Focus" p.38
Is the projector at the correct distance?	Is it projecting outside of the recommended projection distance range? Setup within the recommended range. ☛ "Screen Size and Projection Distance" p.234
Has condensation formed on the lens?	If the projector is suddenly taken from a cold environment to a warm environment, or if sudden ambient temperature changes occur, condensation may form on the surface of the lens, and this may cause the images to appear fuzzy. Set the projector up in the room about one hour before it is used. If condensation forms on the lens, turn the projector off and wait for the condensation to disappear.

Interference or distortion appear in images

Check	Remedy
Are the cables connected correctly?	Check that all the cables required for projection are securely connected. ☛ "Connecting Equipment" p.47
Is an extension cable being used?	If an extension cable is used, electrical interference may affect the signals.
Is the correct resolution selected? (Only when projecting computer images)	Set the computer so that the signals being output are compatible with the projector. ☛ "Supported Monitor Displays" p.274 ☛ Computer's documentation
Is the Sync./Tracking adjusted correctly? (Only when projecting computer images)	Press the [Auto] button on the Remote Control or the [↵] button on the Control panel to perform automatic adjustment. If the images are not adjusted correctly even after performing automatic adjustment, you can also make adjustments from the Configuration menu. ☛ Signal - Tracking, Sync. p.142
Is the Resolution set to anything other than Auto ? (Only when projecting on a split screen)	The image may be collapsed if the Resolution on the Configuration menu and the resolution of the projected image are not the same. If the image is collapsed, set the Resolution to Auto . ☛ Signal - Resolution p.142

The image is truncated (large) or small, the aspect is not suitable, or the image has been reversed

Check	Remedy
Have the Screen been set correctly?	Make the appropriate Screen for the screen being used. ☛ "Screen Settings" p.32
Is the aspect adjusted correctly?	Press the [Aspect] button to select an aspect suitable for the input source. ☛ "Changing the Aspect Ratio of the Projected Image" p.80
Is a wide panel computer image being projected? (Only when projecting computer images)	Change the setting according to the signal for the connected equipment. ☛ Signal - Resolution p.142
Is the image still being enlarged by E-Zoom?	Press the [Esc] button on the remote control to cancel E-Zoom. ☛ "Enlarging Part of the Image (E-Zoom)" p.104
Is Scale turned on?	Set Scale to Off on the configuration menu. ☛ Signal - Scale - Scale p.142
Is the display range restricted by Blanking ?	Appropriately set Blanking in the configuration menu. ☛ Signal - Blanking p.142
Is the image position adjusted correctly?	(Only when projecting analog RGB signals input from the Computer port) Press the [Auto] button on the remote control or the [] button on the control panel to adjust the position. You can also adjust the position from the Configuration menu. ☛ Signal - Position p.142
Is the computer set for dual display? (Only when projecting computer images)	If dual display is activated in the Display Properties of the computer's Control Panel, only about half of the image on the computer screen is projected. To display the entire image on the computer screen, turn off the dual display setting. ☛ Computer video driver documentation
Is the correct resolution selected? (Only when projecting computer images)	Set the computer so that the signals being output are compatible with the projector. ☛ "Supported Monitor Displays" p.274 ☛ Computer's documentation
Is the image direction correct?	Make the correct settings in Projection from the Configuration menu. ☛ "Installation Settings" p.31

Image colors are not right

Check	Remedy
Do the input signal settings match the signals from the connected device?	Change the setting according to the signal for the connected equipment. ☛ Signal - Advanced - Input Signal p.142
Is the image brightness adjusted correctly?	Adjust the Brightness setting from the Configuration menu. ☛ Image - Brightness p.140
Are the cables connected correctly?	Check that all the cables required for projection are securely connected. Check that no cables are disconnected and that there are no poor contacts in the cables. ☛ "Connecting Equipment" p.47
Is the Contrast adjusted correctly?	Adjust the Contrast setting from the Configuration menu. ☛ Image - Contrast p.140
Is the color adjustment set correctly?	Adjust the Gamma or RGBCMY setting from the Configuration menu. ☛ Image - Advanced p.140 ☛ "Adjusting the Image" p.81
Are the color saturation and tint adjusted correctly?	Adjust the Color Saturation and Tint settings from the Configuration menu. ☛ Image - Color Saturation, Tint p.140
Are you projecting from multiple projectors at the same time?	Make sure that Light Source Calibration from the Reset menu is set correctly for all of the projectors. If Light Source Calibration is only executed for some of the projectors, there may be differences in the White Balance or the Brightness Level between projectors. If there are still differences in the color, set Light Source Calibration to Off .

Images appear dark

Check	Remedy
Is the image brightness set correctly?	Check the Brightness and Brightness Settings values from the Configuration menu. ☛ Image - Brightness p.140 ☛ Settings - Brightness Settings p.143
Is the Contrast adjusted correctly?	Adjust the Contrast setting from the Configuration menu. ☛ Image - Contrast p.140

Check	Remedy
Is only one projector being used?	Check if the following item is set to dark. ☛ Extended - Multi-Projection- Brightness Settings p.146



Problems when Projection Starts

The projector does not turn on

Check	Remedy
Did you press the [⏻] button on the remote control or control panel?	Press the [⏻] button to turn on the power.
Are the indicators switched off?	The power cord is not connected correctly or power is not being supplied. Disconnect and then reconnect the power cord. Check that your electrical outlet or power source is functioning correctly.
Do the indicators turn on and off when the power cord is touched?	There is probably a poor contact in the power cable, or the power cable may be defective. Reinsert the power cable. If this does not solve the problem, stop using the projector, disconnect the power cable from the electrical outlet, and contact your local dealer or the nearest address provided in the Epson Projector Contact List. ☛ Epson Projector Contact List
Is the Control Panel Lock set to Full Lock ?	Press the [⏻] button on the remote control. If you do not want to use Control Panel Lock , change the setting to Off . ☛ "Control Panel Lock" p.117
Is the correct setting for the remote receiver selected?	Check the Remote Receiver from the Configuration menu. ☛ Settings - Remote Receiver p.143
Was the power cord plugged back in or was the breaker turned on immediately after direct power off?	If the operation described in the column on the left is performed when Direct Power On is set to On , the power may not turn back on. Press the [⏻] button to turn on the power.
Is the [ID] switch on the remote control set to On?	When the switch is set to On, you can use the remote control to operate only a projector with a matching ID. Set the [ID] switch to Off. ☛ "Setting the remote control ID" p.43

Problems with Content Playback Mode

Cannot play the playlist

Check	Remedy
Is Content Playback set to On ?	Set Content Playback to On , and then restart the projector. You can only play playlists on USB flash drives in Content Playback mode.  Settings - Content Playback - Content Playback p.143
Are there any playlists on the USB flash drive?	Make sure the USB flash drive contains a playlist. See the "Epson Projector Content Manager Operation Guide" for details on creating playlists.
Is the USB flash drive connected to the projector?	Make sure the USB flash drive is connected directly to the projector. Do not use a multcard reader or a USB hub.
Is the USB flash drive partitioned?	If the USB flash drive is partitioned, you may not be able to play back playlists. Delete all of the partitions before saving the playlists on the USB flash drive.
Are you playing the same playlist on projectors with different resolutions?	Do not share a playlist between projectors that are different in resolution. Color and shape effects added by using Overlay Effect may not be reproduced correctly.  Settings - Content Playback - Overlay Effect p.143

Other Problems

There are afterimages (screen burn-in) in the projected image

Check	Remedy
Are you using Refresh Mode?	You can remove afterimages (screen burn-in) from the projected image by using Refresh Mode. Select Start from Refresh Mode in the Reset menu.  Reset - Refresh Mode p.162

No sound can be heard or the sound is faint

Check	Remedy
Check that the audio/video cable is securely attached to both the projector and audio source.	Disconnect the cable from the Audio port, and then reconnect the cable.
Is the projector volume set to the minimum?	Adjust the volume so that sound can be heard. ☛ Settings - Volume p.143 ☛ "Adjusting the Volume" p.63
Is the volume for the computer or from the image source set to the minimum?	Adjust the volume so that sound can be heard.
Is A/V Mute active?	Press the [A/V Mute] button to release A/V Mute. ☛ "Hiding the Image and Sound Temporarily (A/V Mute)" p.102
Is the audio cable's specification "No resistance"?	When using a commercially available audio cable, make sure it is labeled "No resistance".
Is it connected with an HDMI cable?	If no audio is output when connecting via an HDMI cable, set the connected equipment to PCM output.
Is the correct audio input selected?	Check the Audio Settings from the configuration menu. ☛ Extended - A/V Settings - Audio Settings p.146

The remote control does not work

Check	Remedy
Is the remote control light-emitting area pointing towards the remote receiver on the projector during operation?	Point the remote control towards the remote receiver. ☛ "Remote control operating range" p.24
Is the remote control too far from the projector?	Check the operating range. ☛ "Remote control operating range" p.24
Is direct sunlight or strong light from fluorescent lamps shining onto the remote receiver?	Set the projector up in a location where strong light does not shine onto the remote receiver.
Is the correct setting for the Remote Receiver selected?	Check the Remote Receiver from the Configuration menu. ☛ Settings - Remote Receiver p.143
Are the batteries dead or have the batteries been inserted correctly?	Make sure the batteries are inserted correctly or replace the batteries with new ones if necessary. ☛ "Replacing the remote control batteries" p.23

Check	Remedy
Are the remote control ID and the projector ID matched?	Make sure the ID for the projector you want to operate and the ID for the remote control match. To operate all projectors by remote control regardless of the ID setting, set the [ID] switch on the remote control to Off. ☛ "ID Settings" p.42
Is the optional remote control cable connected to the projector's Remote port?	When the remote control cable is connected, the projector's remote receiver is disabled. When not using the remote control cable set, disconnect it from the Remote port.
Is Control Communications or Extron XTP set to On ?	The Remote port is disabled. When using the optional remote control cable set, set Control Communications or Extron XTP to Off . ☛ Extended - HDBaseT p.146
Is the remote control button lock set?	When the remote control button lock is set, buttons except for those needed for basic remote control operations are deactivated. Hold down the [] button to cancel the remote control button lock. ☛ "Remote control button lock" p.118

Nothing appears on the external monitor

Check	Remedy
Are images input from a port other than the Computer port or BNC port?	Only RGB signals from the Computer port or the BNC port can be displayed on an external monitor.
Are you projecting a split screen?	Only RGB signals projected on the left screen from the Computer port or the BNC port can be displayed on an external monitor. ☛ "Projecting Two Images Simultaneously (Split Screen)" p.99
Is the projector in standby status?	Check that Standby Mode , A/V Output , and Monitor Out from the Configuration menu are set correctly. ☛ Extended - Standby Mode, A/V Settings p.146

I want to change the language for messages and menus

Check	Remedy
Change the Language setting.	Adjust the Language setting from the Configuration menu. ☛ Extended - Language p.146

Email is not received even if a problem occurs in the projector





Check	Remedy
Is Standby Mode set to Communication On ?	To use the Mail Notification function when the projector is in standby, set Communication On in Standby Mode from the Configuration menu. ☛ Extended - Standby Mode p.146
Is power being supplied to the projector?	Check that your electrical outlet or power source is functioning correctly.
Is the Mail Notification function set correctly in the Configuration menu?	An error notification email is sent according to the Notifications settings in the Configuration menu. Check if it is set correctly. ☛ "Notifications menu" p.158

"The battery that saves your clock settings is running low." is displayed

Check	Remedy
The internal power supply that saves your clock settings is running low.	Contact your local dealer or the nearest address provided in the Epson Projector Contact List. ☛ Epson Projector Contact List

Check the numbers and then apply the following countermeasures. If you cannot resolve the problem, contact your network administrator, or contact your local dealer or the nearest address provided in the Epson Projector Contact List.

 [Epson Projector Contact List](#)

Event ID	Cause	Remedy
0432 0435	Failed to start the network software.	Restart the projector.
0434 0481 0482 0485	Network communication is unstable.	Check the network communication status, and reconnect after waiting for a while.
0433	Cannot play transferred images.	Restart the network software.
0484	Communication was disconnected from the computer.	
0483 04FE	The network software ended unexpectedly.	Check the status of network communications. Restart the projector.
0479 04FF	A system error occurred in the projector.	Restart the projector.
0891	Cannot find an access point with the same SSID.	Set the computer, the access point, and the projector to the same SSID.
0892	The WPA/WPA2 authentication type does not match.	Check that the wireless LAN security settings are correct.
0893	The TKIP/AES encryption types do not match.	 Network - Wireless LAN p.154
0894	Communication was disconnected because the projector connected to an unauthorized access point.	Contact your network administrator for more information.
0898	Failed to acquire DHCP.	Check that the DHCP server is operating correctly. If you are not using DHCP, turn off the DHCP setting.  Network - Wireless LAN p.154 , Wired LAN p.157
0899	Other communication errors	If restarting the projector or network software does not solve the problem, contact your local dealer or the nearest address provided in the Epson Projector Contact List.  Epson Projector Contact List
089A	The EAP authentication type is not the same.	Check that the wireless LAN security settings are correct. Also, check if the certificate is installed correctly.  Network - Wireless LAN p.154
089B	EAP server authentication failed.	
089C	EAP client authentication failed.	



Event ID	Cause	Remedy
089D	Key exchange failed.	
0920	The internal power supply that saves your clock settings is running low.	Contact your local dealer or the nearest address provided in the Epson Projector Contact List.  Epson Projector Contact List



Maintenance

This chapter provides information on maintenance procedures to ensure the best level of performance from the projector for a long time to come.

You should clean the projector if it becomes dirty or if the quality of projected images starts to deteriorate.



Caution

When cleaning, unplug the power cable from the electric outlet. Otherwise, it could cause an electric shock.

Cleaning the Projector

Clean the projector's surface by wiping it gently with a soft cloth.

If the projector is particularly dirty, moisten the cloth with water and firmly wring it out before wiping, and then finish with a dry cloth.

Attention

Do not use volatile substances such as wax, benzene, or thinner, or kitchen detergent to clean the projector's surface. The quality of the case may change or become discolored.

Cleaning the Lens

Use a commercially available cloth for cleaning glasses to gently wipe the lens.



Warning

Do not use sprays that contain flammable gas to remove dust and lint from the lens. The projector may catch fire due to the high internal temperature.

Use a vacuum cleaner or a hand-held air blower to remove any dust and lint attached to the lens.

Attention

Do not rub the lens with harsh materials or subject the lens to shocks, as it can easily become damaged.

Cleaning the Air Filter and Air Intake Vent

When the following message is displayed and the filter indicator flashes orange, clean the air filter and the air intake vent.

"Time to clean the air filter. Clean or replace the air filter."

"The projector is overheating. Make sure nothing is blocking the air vent, and clean or replace the air filter."

"The air filter is clogged. Clean or replace the air filter."



Warning

Do not use sprays that contain flammable gas to remove dust and lint from the filter.

The projector may catch fire due to the high internal temperature. Use a vacuum cleaner or a hand-held air blower to remove any dust and lint attached to the air filter and so on.

Attention

- If dust collects on the air filter, it can cause the internal temperature of the projector to rise, and this can lead to problems with operation and shorten the optical engine's service life. Clean the air filter immediately when the message is displayed.
- Do not rinse the air filter in water. Do not use detergents or solvents.
- When using a brush for cleaning, use one with long soft bristles, and brush it lightly. If it is brushed too strongly, dust will be ground into the air filter and cannot be removed.

Cleaning the air filter

The air filter can be replaced even when the projector is suspended from a ceiling.

- 1** After you turn off the projector's power and the confirmation buzzer beeps, disconnect the power cord.
- 2** Loosen the fixing screws and open the air filter cover.

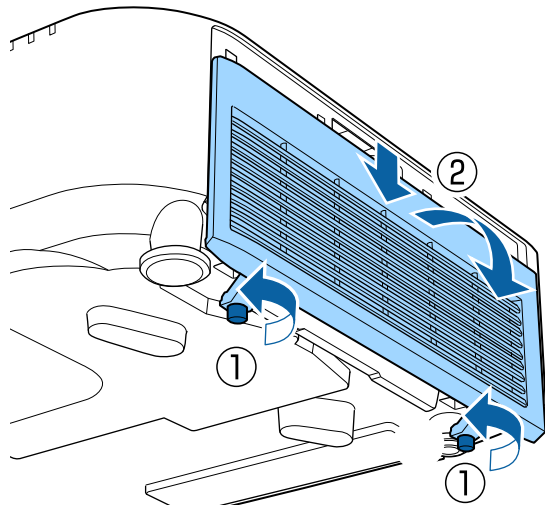

- 3** Remove the air filter.
Grip the tab of the air filter, and pull it straight out.

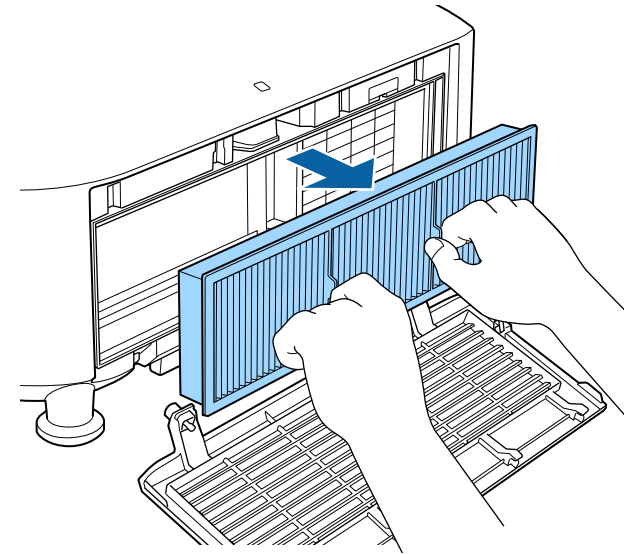

- 4** With the front (the side with tabs) of the air filter facing down, tap the air filter four or five times to shake off the dust. Turn it over and tap the other side in the same way.

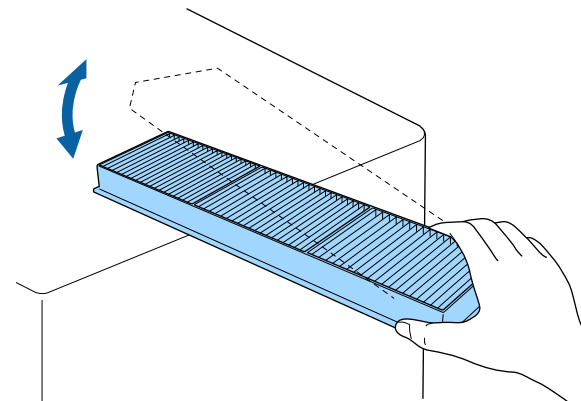

Attention

If the air filter is hit too hard, it may become unusable due to deformities and cracks.

- 5** Remove any dust remaining on the air filter by using a vacuum cleaner from the front side.

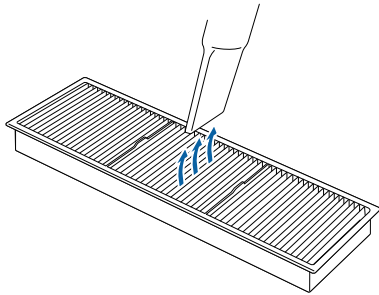

- 6** Replace the air filter.

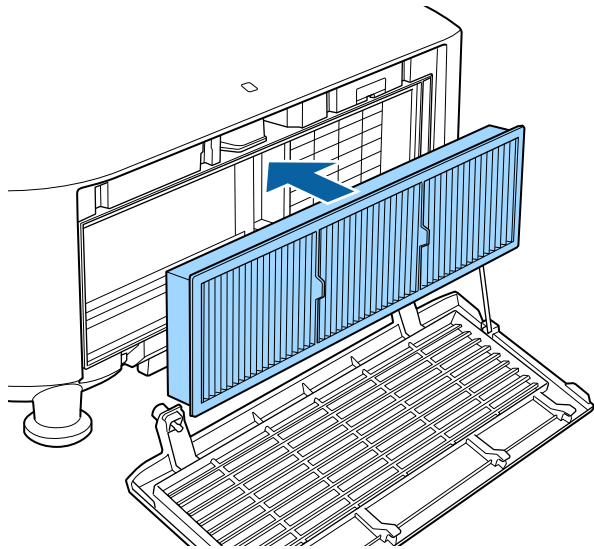

- 7** Close the air filter cover and tighten the fixing screws.

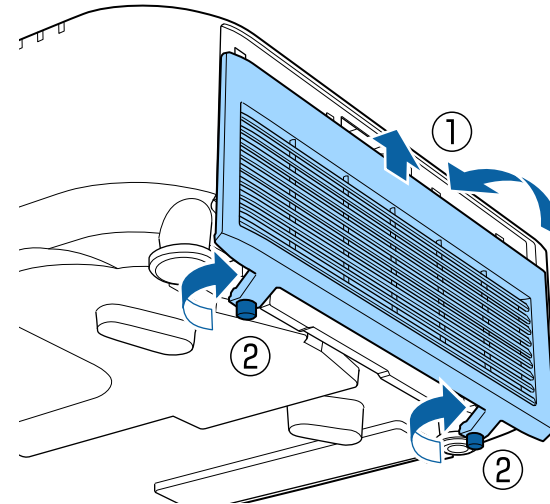

- If a message is frequently displayed, even after cleaning, it is time to replace the air filter. Replace it with a new air filter.
 - ☛ "Replacing the Air Filter" [p.208](#)
- It is recommended that you clean the air filter every 20,000 hours. Clean it more often than this if using the projector in a particularly dusty environment.
- The indicators or messages regarding Air Filter Notice are displayed only when **Air Filter Notice** is set to **On** from the Configuration menu.
 - ☛ **Extended - Display - Air Filter Notice** [p.146](#)

Cleaning the air intake vent

- 1** After you turn off the projector's power and the confirmation buzzer beeps, disconnect the power cord.
- 2** Use a vacuum cleaner or a soft brush to carefully remove the dust.

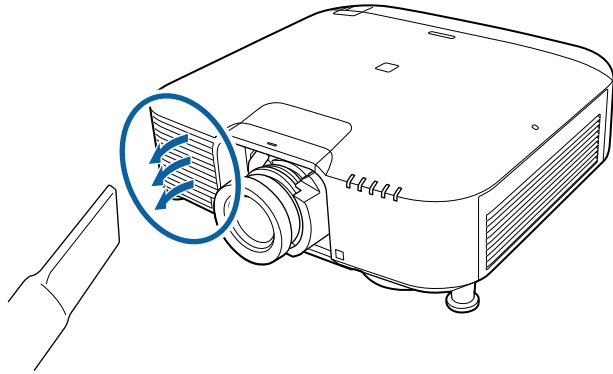

This section explains how to replace the air filter.

Replacing the Air Filter

Air filter replacement period

If the message is displayed frequently even though the air filter has been cleaned, replace the air filter.

Replacing the air filter

The air filter can be replaced even when the projector is suspended from a ceiling.

- 1** After you turn off the projector's power and the confirmation buzzer beeps, disconnect the power cord.
- 2** Loosen the fixing screws and open the air filter cover.

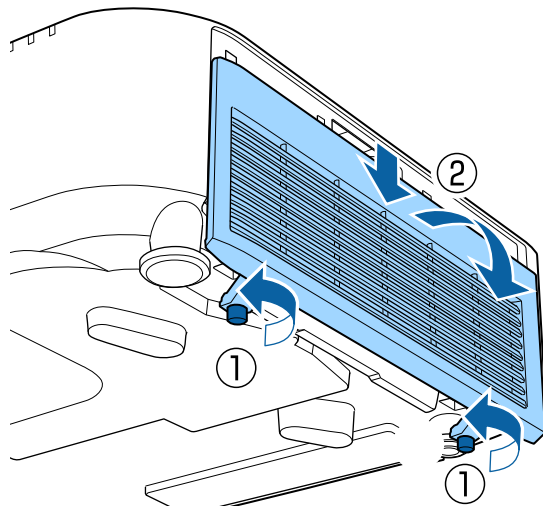

- 3** Remove the air filter.
Grip the tab of the air filter, and pull it straight out.

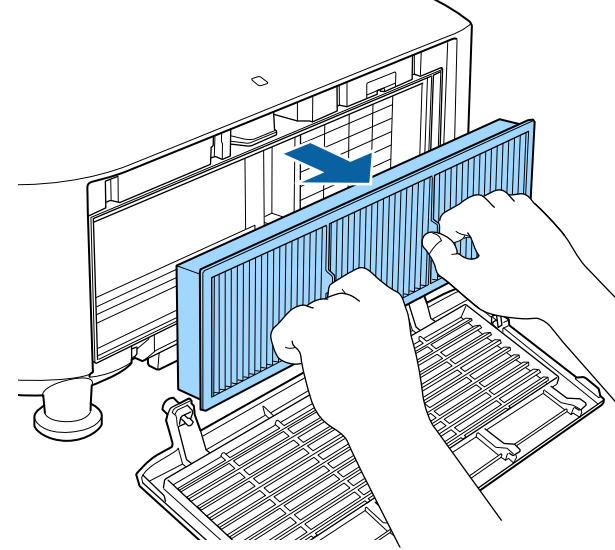

- 4** Install the new air filter.

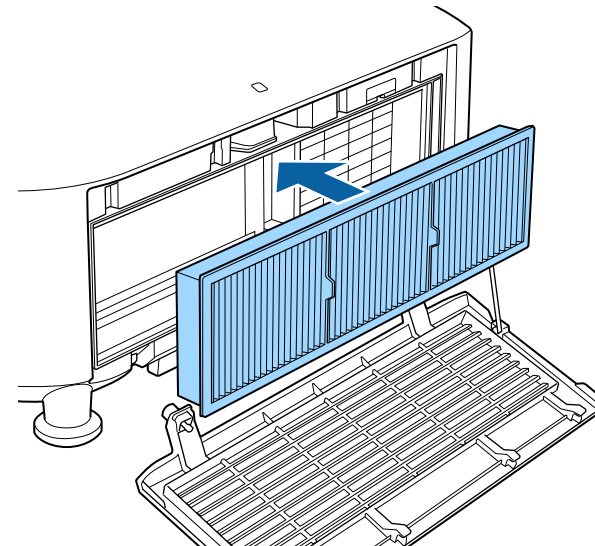

5 Close the air filter cover and tighten the fixing screws.

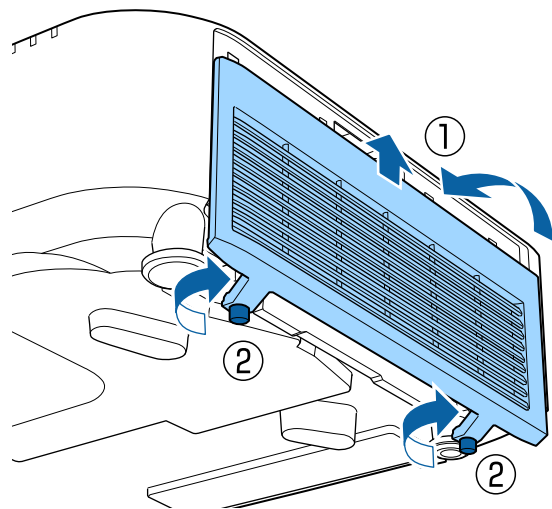

Dispose of used air filters properly in accordance with your local regulations.

Material of the frame part: Polypropylene

Material of the filter part: Polypropylene

Panel Alignment

Adjusts the pixel color shift for the LCD panel. You can adjust the pixels horizontally and vertically by 0.125 pixels within a range of ± 3 pixels.



- Image quality may decline after performing LCD alignment.
- Images for pixels that extend beyond the edge of the projected screen are not displayed.

- 1 Press the [Menu] button while projecting.
- 2 Select **Display** from **Extended**.
- 3 Select **Panel Alignment**, and then press the [\leftarrow] button.

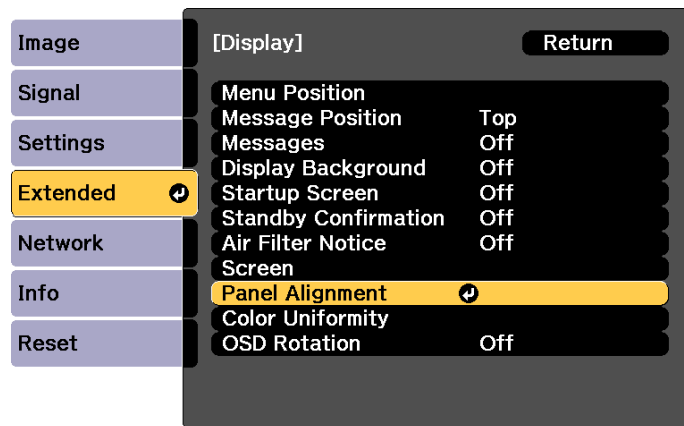

[Esc] :Return [Left Arrow]:Select [Enter]:Enter [Menu]:Exit

- 4 Enable **Panel Alignment**.

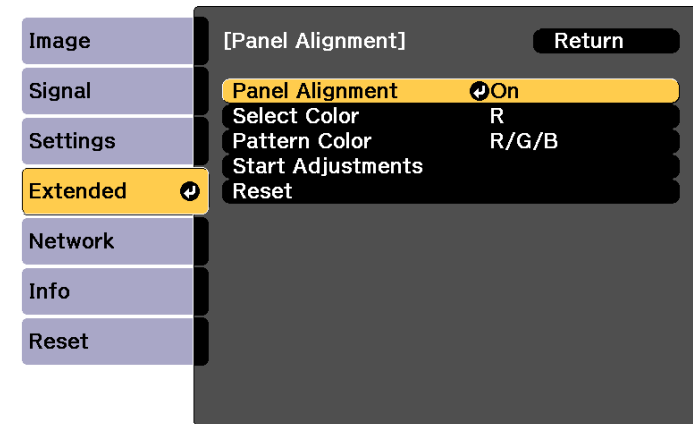

[Esc] :Return [Left Arrow]:Select [Enter]:Enter [Menu]:Exit

- (1) Select **Panel Alignment**, and then press the [\leftarrow] button.
- (2) Select **On**, and then press the [\leftarrow] button.
- (3) Press the [Esc] button to return to the previous screen.

- 5 Select the color you want to adjust.

- (1) Select **Select Color**, and then press the [\leftarrow] button.
- (2) Select **R** (red) or **B** (blue), and then press the [\leftarrow] button.
- (3) Press the [Esc] button to return to the previous screen.

- 6 Select the grid color displayed when making adjustments from **Pattern Color**.

- (1) Select **Pattern Color**, and then press the [\leftarrow] button.

- (2) Select a combination of R (red), G (green), and B (blue) for the grid color.
- R/G/B:** Displays a combination all three colors; red, green and blue. The actual color of the grid is white.
- R/G:** This is available when **R** is selected from **Select Color**. Displays a combination of two colors; red and green. The actual color of the grid is yellow.
- G/B:** This is available when **B** is selected from **Select Color**. Displays a combination of two colors; green and blue. The actual color of the grid is cyan.
- (3) Press the [Esc] button to return to the previous screen.

- 7** Select **Start Adjustments**, and then press the [**↵**] button.
- First, select **Shift the whole panel** to adjust the entire LCD panel. When the start confirmation message is displayed, press the [**↵**] button to start adjustment.



The image may become distorted while adjusting. The image is restored once adjustments are complete.

- 8** Use the [**▲**][**▼**][**◀**][**▶**] buttons to make adjustments, and then press the [**↵**] button.
- 9** To perform more detailed adjustments, select **Adjust the four corners**, and then press the [**↵**] button to confirm.
- 10** Use the [**▲**], [**▼**], [**◀**], and [**▶**] buttons to make adjustments, and then press the [**↵**] button to move to the next adjustment point.
- 11** When you have adjusted all four corners, select **Exit**, and then press the [**↵**] button.

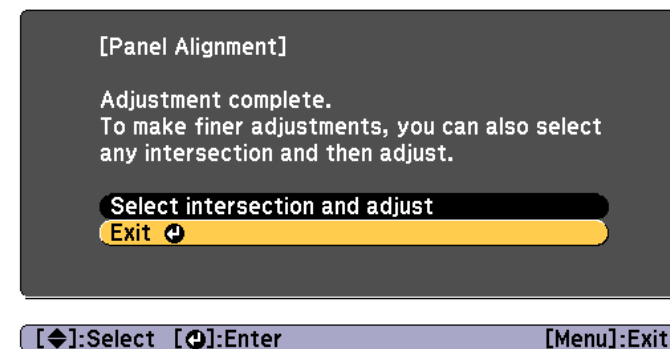

If you feel you still need to make adjustments after correcting all four points, select **Select intersection and adjust** and then continue making adjustments.

Color Uniformity

Adjusts the color tone for the whole screen.



The color tone may not be uniform even after performing color uniformity.

- 1 Press the [Menu] button while projecting.
- 2 Select **Display** from **Extended**.
- 3 Select **Color Uniformity**, and then press the [↵] button.
The following screen is displayed.

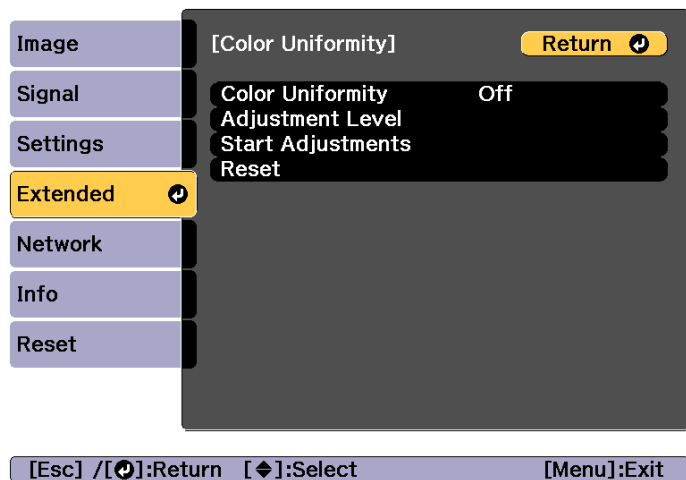

Color Uniformity: Turns color uniformity on or off.

Adjustment Level: There are eight levels from white, through gray, and up to black. You can adjust each level individually.

Start Adjustments: Starts adjusting color uniformity.

Reset: Resets all adjustments and settings for **Color Uniformity** to their default values.



The image may become distorted while adjusting **Color Uniformity**. The image is restored once adjustments are complete.

- 4 Select **Color Uniformity**, and then press the [↵] button.
- 5 Set to **On**, and then press the [Esc] button.
- 6 Select **Adjustment Level**, and then press the [↵] button.
- 7 Use the [◀][▶] buttons to set the adjustment level.
- 8 Press the [Esc] button to return to the previous screen.
- 9 Select **Start Adjustments**, and then press the [↵] button.
- 10 Select the area you want to adjust, and then press the [↵] button.
Adjust the outer areas first, and then adjust the whole screen.

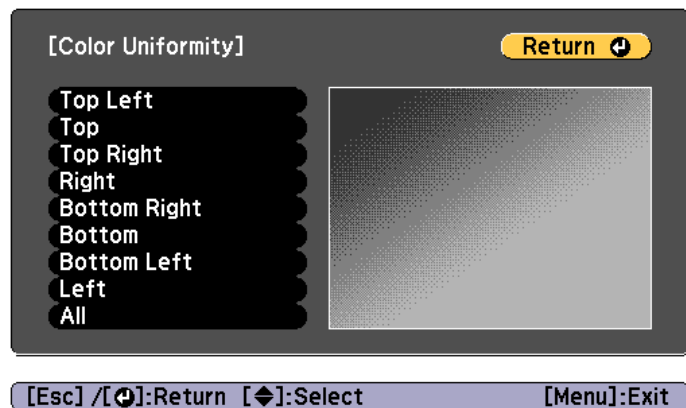

- 11** Use the [▲][▼] buttons to select the color you want to adjust, and then use the [◀][▶] buttons to adjust.

Press the [◀] button to weaken the color tone. Press the [▶] button to strengthen the color tone.

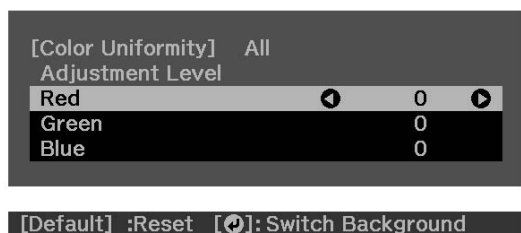

- 12** Return to step 6 and adjust each level.
- 13** To complete the adjustment, press the [Menu] button.



Appendix

Epson Projector Management

Epson Projector Management lets you carry out operations such as checking the status of multiple Epson projectors that are connected to a network at a computer monitor, and controlling the projectors from the computer.

Download the Epson Projector Management software from the following website.

<http://www.epson.com>

Changing Settings Using a Web Browser (Epson Web Control)

By using a Web browser of a computer or mobile device connected to the projector on a network, you can set functions and control the projector. This function allows you to perform setup and control operations remotely.

You can use the following Web browsers.

- Internet Explorer 11.0 or later (except for Metro) (Windows)
- Microsoft Edge (Windows)
- Safari (Mac)
- Chrome (Android)



If you set **Standby Mode** to **Communication On**, you can use the Web browser to make settings and perform control even if the projector is in standby mode (when the power is off).

☞ **Extended - Standby Mode** [p.146](#)

Displaying the Epson Web Control Screen

Use the following procedure to display the Epson Web Control screen.

Make sure your device and projector are ready for the network connection.



If your Web browser is set up to connect via a proxy server, the Epson Web Control screen cannot be displayed. To display Web Control, you need to make settings so that a proxy server is not used for a connection.

- 1 Connect your device to the same network as the connected projector.

The connection method varies depending on the device. See the manual supplied with your device for details. When using a mobile device, check the Wi-Fi settings.

- 2 Start the Web browser on your device.

- 3 Connect by entering the address of the connected projector in the URL field of the Web browser.

The Home screen is displayed.

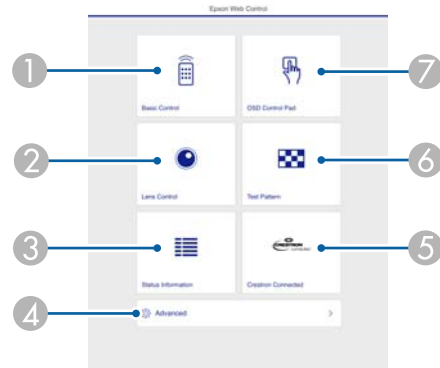

- 1 **Basic Control**
☛ "Basic Control Screen" p.216
- 2 **Lens Control**
☛ "Lens Control Screen" p.218
- 3 **Status Information**
☛ "Status Information Screen" p.220
- 4 **Advanced**
You are moved to the Advanced screen.
- 5 **Crestron Connected**
☛ "About Crestron Connected®" p.228

- 6 **Test Pattern**
☛ "Test Pattern Operation Screen" p.219
- 7 **OSD Control Pad**
☛ "OSD Control Pad Screen" p.217



- When performing the functions from the Home screen, you may be prompted to enter the user name and password. When the login screen is displayed, enter your user name and password. (The user name is **EPSONWEB**; the default password is **admin**.)
- You cannot change the user name. You can change the password in the Network menu from the Configuration menu.
☛ **Network - Basic - Web Control Password** p.153
- You must enter the user name for Web Control Password even when the password is disabled.
- You can only set the following items from the **Advanced** screen.
Monitor Password (up to 16 single-byte alphanumeric characters)
☛ **Network - Basic - Monitor Password** p.153
IPv6 Settings (Manual)
☛ **Network - IPv6 Settings** p.154, p.157
Add HTTP port (for the port number used for Web control, use anything except for 80 (default), 843, 3620, 3621, 3625, 3629, 4352, 4649, 5357, 10000, 10001, 41794)
☛ **Network - Others** p.159

Basic Control Screen

You can perform basic projector operations.

When the login screen is displayed, enter your user name and password. (The user name is **EPSONREMOTE**; the default password is **guest**.)

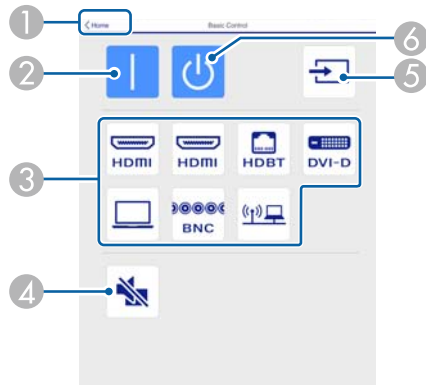

- ① Moves to the Home screen.
- ② Turns the projector on.
- ③ Switches to the target image.
- ④ Turns the video and audio on or off.
- ⑤ Automatically detects the input signal.
- ⑥ Turns the projector off.

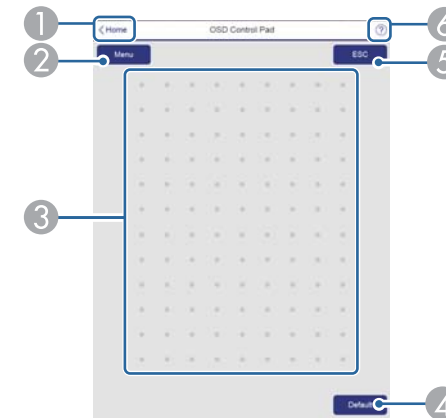

- ① Moves to the Home screen.
- ② Displays and closes the Configuration menu.
- ③ You can operate the Configuration menu using your finger or mouse. Flick to select an item, and tap to confirm the selection.
- ④ Enabled when **Default**: Reset is displayed on the Configuration menu guide. The settings being adjusted are returned to their default values.
- ⑤ Returns to the previous menu level in the Configuration menu.
- ⑥ Displays information on using the OSD Control Pad.

OSD Control Pad Screen

You can operate the Configuration menu of the projector.



Items in the Configuration menu that cannot be set in Epson Web Control are listed below.

- Image menu - Advanced - Gamma - Custom
- Signal menu - Advanced - BNC Sync Termination, EDID, DDC Buffer
- Settings menu - HDMI Link, User Button, Content Playback
- Extended menu - Display - Message Position
- Extended menu - User's Logo
- Extended menu - Operation - Advanced - Lens Type
- Extended menu - Operation - Lens Calibration
- Extended menu - Language
- Network menu - Search Access Point, Crestron Connected

The settings for items on each menu are the same as the projector's Configuration menu.

☞ "Configuration Menu" [p.135](#)

Lens Control Screen

You can operate the lens of the projector.

Focus/Distortion Operation Screen

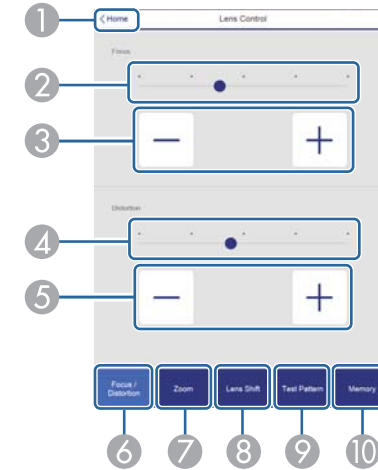

- ① Moves to the Home screen.
- ② Move the slider to adjust the focus.
- ③ Press the buttons to adjust the focus.
- ④ Move the slider to adjust image warping.*
- ⑤ Press the buttons to adjust image warping.*
- ⑥ Displays the Focus / Distortion operation screen.
- ⑦ Displays the Zoom operation screen.
- ⑧ Displays the Lens Shift operation screen.
- ⑨ Displays the Test Pattern operation screen.
- ⑩ Displays the Memory operation screen.

* This is not available for ELPLU02.

Zoom Operation Screen

This is not available for ELPLX01, ELPLX01W, and ELPLR04.

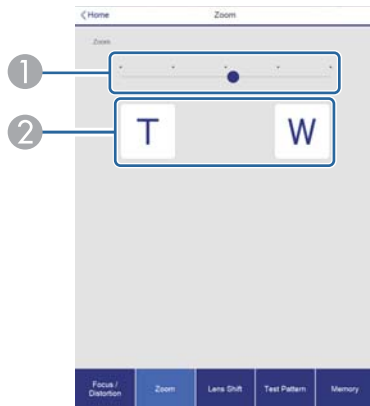

- ① Move the slider to adjust the zoom.
- ② Press the buttons to adjust the zoom.

Lens Shift Operation Screen

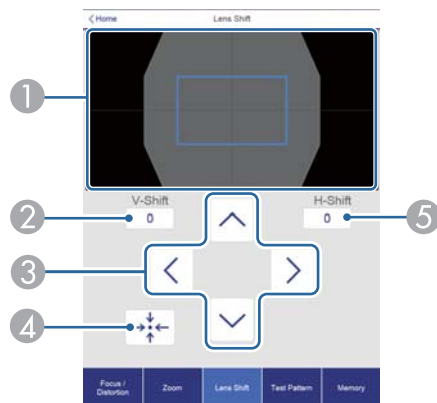

- ① Displays the position of the image as a blue square. When you move the image position, a red square is displayed at the destination.
- ② Displays the vertical image position. You can directly specify the position by tapping it and entering a number.
- ③ Moves the image position up, down, left, or right.

- ④ Moves the lens position to the home position if you press the **OK** button in the confirmation screen.
- ⑤ Displays the horizontal image position. You can directly specify the position by tapping it and entering a number.

Test Pattern Operation Screen

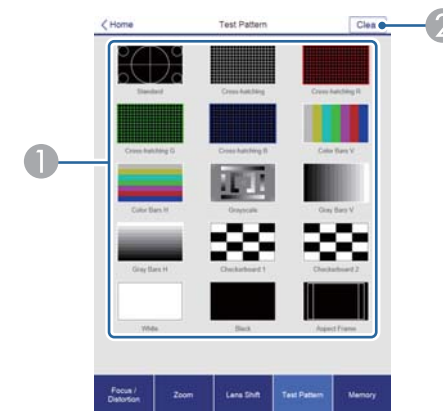

- ① Displays a test pattern.
- ② Closes the test pattern.

Memory Operation Screen

See the following for memory function details.

☞ "Memory Function" [p.110](#)

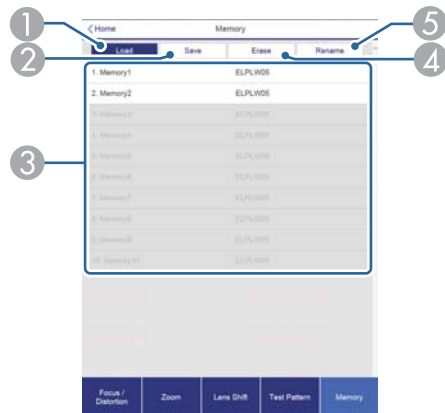

- ① Loads a memory.
- ② Saves a memory.
- ③ Displays a list of memories.
- ④ Erases a memory.
- ⑤ Changes a memory name.

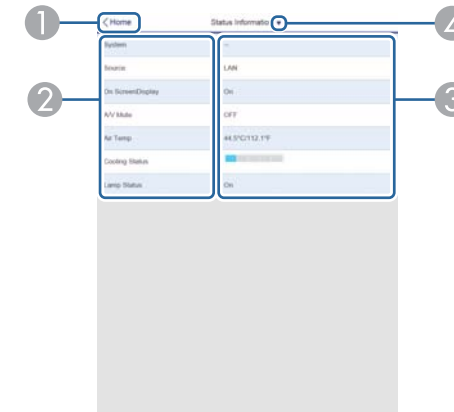

- ① Moves to the Home screen.
- ② Displays the item name.
- ③ Displays the status of each item.
- ④ Selects a category from the following.
Status Information, Source, Signal Information, Network Wired, Network Wireless, Maintenance, Version, Air Temp Info

Status Information Screen

You can check the projector's status. See the following for display details.

☛ "Reading the Status Display" [p.182](#)

Changing Settings Using a Web Browser (Content Playback Mode)

In Content Playback mode, you can use a Web browser to set and control network projectors, and edit playlists.



You can also control projectors using a Web browser from Epson iProjection (iOS/Android).

Attention

Do not remove the USB flash drive from the projector or unplug the power cord in the following situations. Otherwise, data on the USB flash drive may be corrupted.

- While viewing the Playlist screen
- While viewing the USB flash drive screen

- 1** Make sure that the projector is in Content Playback mode.
- 2** Connect your device to the same network as the connected projector.
- 3** Start the Web browser on your device. Enter the IP address of the projector in the address input box of the browser to connect to the Epson Web Control screen. When entering an IPv6 address, enclose the address in square brackets [].
The Epson Web Control screen is displayed.

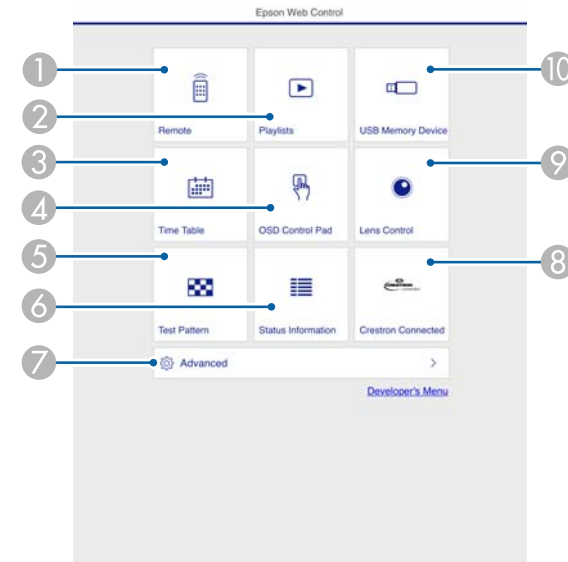

- 1** You can use this to operate the projector remotely.
- 2** Edit the playlist you want to play in Content Playback mode.
- 3** Displays the Timetable screen.
- 4** Operate the Configuration menus using your finger or mouse.
- 5** Displays a test pattern.
- 6** Displays the projector's status.
- 7** Make advanced settings for the projector.
- 8** Displays the Crestron Connected operation screen. This is only enabled when using Crestron Connected.
- 9** Operate the lens of the projector.
- 10** Save the data for your playlists to a USB flash drive.

- 4** Select the item you want to use.



You may need to login to set options on the Epson Web Control screen. When the login screen is displayed, enter your user name and password.

(The user name is **EPSONWEB**; the default password is **admin**.)

- You can change the password in **Web Control Password** from the **Network**.
 - **Network - Network Configuration - Basic - Web Control Password** [p.153](#)
- You can only set the following items from **Advanced**.
 - Monitor Password (up to 16 single-byte alphanumeric characters)
 - IPv6 Settings (Manual)
 - Add HTTP port (for the port number used for Web control, use anything except for 0 (default), 843, 3620, 3621, 3625, 3629, 4352, 4649, 5357, 10000, 10001, 41794)

Remote

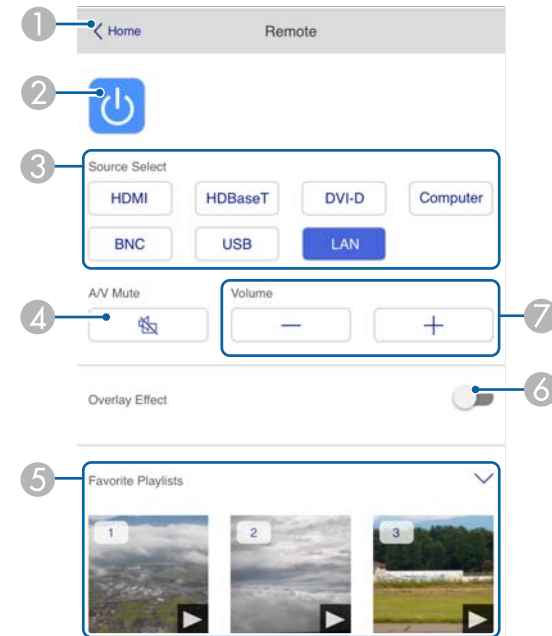

- 1 Moves to the Epson Web Control home screen.
- 2 Turns the projector on or off.
- 3 Selects the input source.
- 4 Turns the video and audio on or off temporarily.
- 5 Selects your favorite playlist.
- 6 Turns **Overlay Effect** on or off.
- 7 Adjusts the volume for the speakers.

Playlists

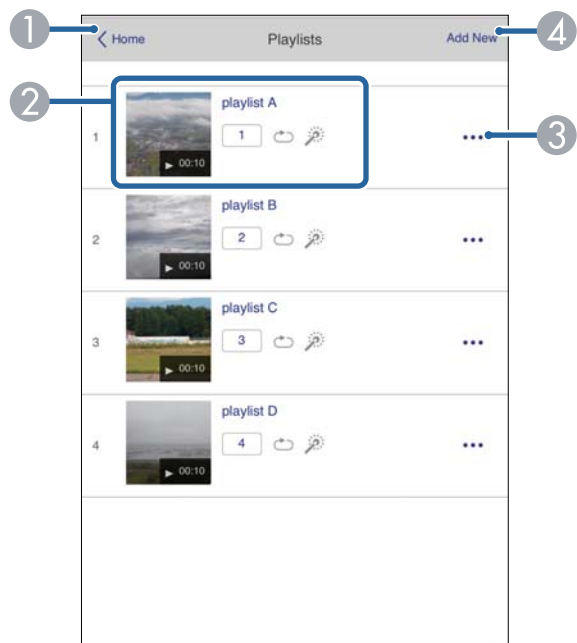

- ① Moves to the Epson Web Control home screen.
- ② Controls playback of the playlist.
- ③ Edits the playlist.
- ④ Creates a new playlist.

USB Memory Device

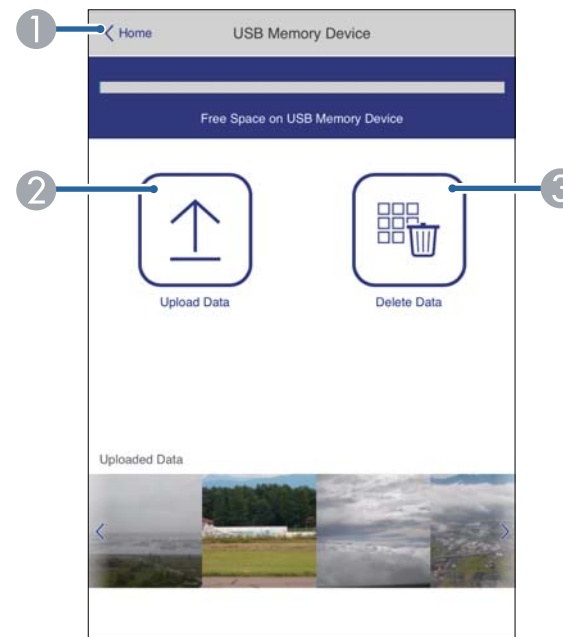

- ① Moves to the Epson Web Control home screen.
- ② Saves photos and videos you want to add to your playlists to the USB flash drive.
- ③ Deletes photos and videos from the USB flash drive.

Time Table

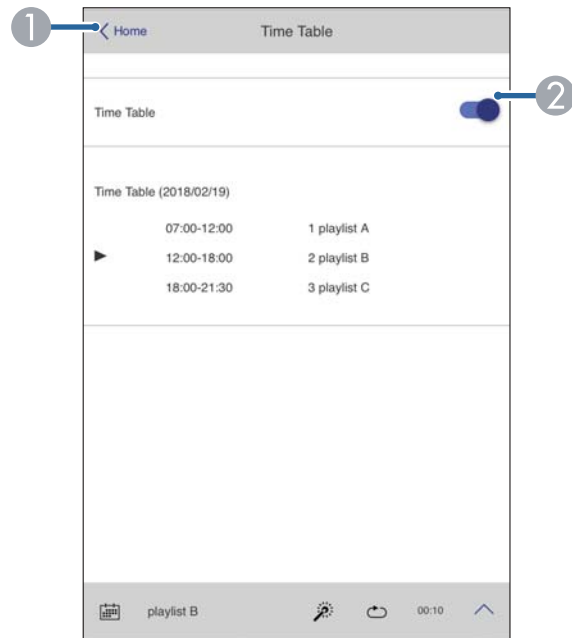

- ① Moves to the Epson Web Control home screen.
- ② Turns the timetable on or off.



The timetable feature in Epson Projector Content Manager allows you to specify when the playlist will be played.

See the "Epson Projector Content Manager Operation Guide" for details.

OSD Control Pad

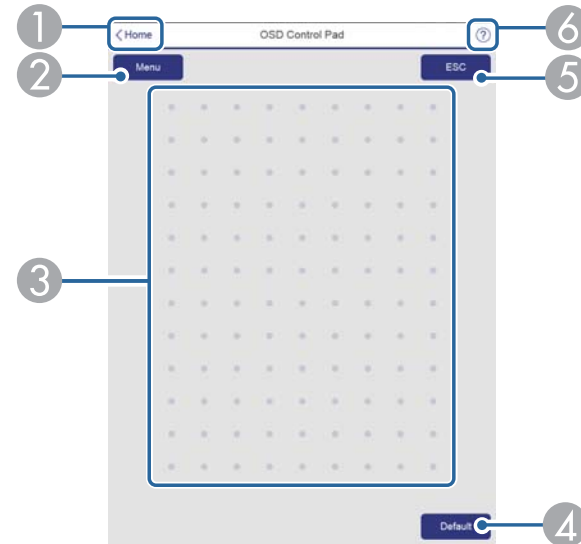

- ① Moves to the Epson Web Control home screen.
- ② Displays the Configuration menu.
- ③ Operate the menus using your finger or mouse.
- ④ Enabled when **Default: Reset** is displayed on the menu guide. The settings being adjusted are returned to their default values.
- ⑤ Returns to the previous menu.
- ⑥ Displays the help topics.



See the following for items in the Configuration menu that cannot be set in Epson Web Control.

☞ "OSD Control Pad Screen" [p.217](#)

Using the Mail Notification Function to Report Problems

When you set Mail Notification, notification messages are sent to the preset email addresses when a problem or warning occurs with a projector. This will enable the operator to be notified of problems with projectors even at locations away from the projectors.

☛ **Network - Notifications - Mail Notification** [p.158](#)



- Up to a maximum of three notification destinations (addresses) can be registered, and notification messages can be sent to all three destinations at once.
- If a projector develops a critical problem and suddenly stops working, it may not be able to send a message notifying an operator of the problem.
- If you set **Standby Mode** to **Communication On**, you can control the projector even if it is in standby mode (when the power is off).

☛ **Extended - Standby Mode** [p.146](#)

Reading error notification mail

When the Mail Notification function is set to On and a problem or warning occurs in the projector, the following email will be sent.

Sender: The email address set in **From**

Subject: EPSON Projector

Line 1: The projector name where the problem has occurred

Line 2: The IP address set for the projector where the problem has occurred.

Line 3 and on: Details of the problem

The details of the problem are listed line by line. The main message contents are listed below.

- Clean Air Filter
- Constant brightness expired (Constant Bright. End)
- Internal error
- Fan related error
- Sensor error
- Laser error (Laser Error/Laser Does Not Turn On)
- Laser warning
- Retardation Plate Error
- Internal temperature error
- High-speed cooling in progress
- Low Air Flow
- Low Air Flow Error
- No-signal
No Signal is input to the projector. Check the connection status or check that the power for the signal source is turned on.
- Lens shift error
- No lens

See the following to deal with problems or warnings.

☛ "Reading the Indicators" [p.175](#)

Management Using SNMP

By setting **SNMP** to **On** in the Configuration menu, notification messages are sent to the specified computer when a problem or warning occurs. This allows you to check for problems with projectors even at locations away from the projectors.

 **Network - Notifications - SNMP** [p.158](#)



- SNMP should be managed by a network administrator or someone who is familiar with the network.
- To use the SNMP function to monitor the projector, you need to install the SNMP manager program on your computer.
- The SNMP Agent for this projector complies with version 1 (SNMPv1).
- The managing function using SNMP cannot be used over wireless LAN in Quick connection mode.
- Up to two destination IP addresses can be saved.

ESC/VP21 Commands

You can control the projector from an external device using ESC/VP21.

Command list

When the power ON command is transmitted to the projector, the power turns on and it enters warm-up mode. When the projector's power has turned on, a colon ":" (3Ah) is returned.

When a command is input, the projector executes the command and returns a ":", and then accepts the next command.

If the command being processed terminates abnormally, an error message is output and a ":" is returned.

The main contents are listed below.

Item		Command	
Power ON/OFF	On	PWR ON	
	Off	PWR OFF	
Signal selection	Computer	Auto	SOURCE 1F
		RGB	SOURCE 11
		Component	SOURCE 14
	BNC	Auto	SOURCE BF
		RGB	SOURCE B1
		Component	SOURCE B4
	HDMI		SOURCE 30
	USB		SOURCE 52
	LAN		SOURCE 53
	DVI-D		SOURCE A0
HDBaseT		SOURCE 80	
A/V Mute On/Off	On	MUTE ON	
	Off	MUTE OFF	

Add a Carriage Return (CR) code (0Dh) to the end of each command and transmit.

For more details, contact your local dealer or the nearest address provided in the Epson Projector Contact List.

 [Epson Projector Contact List](#)

Cable layouts

Serial connection

- Connector shape: D-Sub 9-pin (male)

- Projector input port name: RS-232C

<At the projector>



<At the computer>

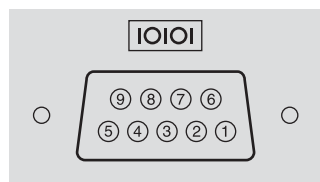

<At the projector>

(PC serial cable)

<At the computer>

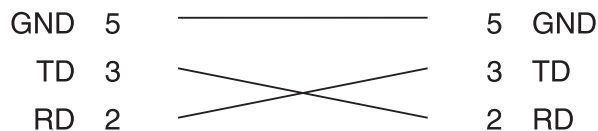

Signal Name	Function
GND	Signal wire ground
TD	Transmit data
RD	Receive data

Communications protocol

- Default baud rate setting: 9600 bps
- Data length: 8 bit
- Parity: None
- Stop-bit: 1 bit
- Flow control: None

About PJLink

PJLink was established by the JBMIA (Japan Business Machine and Information System Industries Association) as a standard protocol for controlling network-compatible projector's as part of their efforts to standardize projector control protocols.

The projector complies with the PJLink Class2 standard established by the JBMIA.

The port number used by the PJLink search function is 4352 (UDP).

You need to make network settings before you can use PJLink. See the following for more information on network settings.

☛ "Network Menu" p.151

It complies with all commands except for the following commands defined by PJLink Class2, and agreement was confirmed by the PJLink standard adaptability verification.

URL: <http://pjlink.jbmia.or.jp/english/>

- Non-compatible commands

	Function	PJLink Command
Mute settings	Image muting set	AVMT 11
	Audio muting set	AVMT 21

- Input ports and corresponding input source number

Input Port Name	Input Source Number
Computer	11
BNC	13
DVI-D	31
HDMI	32

Input Port Name	Input Source Number
USB	41
LAN	52
HDBaseT	56

- Manufacturer name displayed for "Manufacture name information query"
EPSON
- Model name displayed for "Product name information query"
EPSON L1075U/L1070U
EPSON L1065U/L1060U
EPSON L1050U
EPSON L1070W
EPSON L1060W
EPSON L1070

About Crestron Connected®

Crestron Connected® is an integrated control system provided by Crestron®. It can be used to monitor and control multiple devices connected on a network.

The projector supports the control protocol, and can therefore be used in a system built with Crestron Connected®.

Visit the Crestron® Web site for details on Crestron Connected®. (Only English-language displays are supported.)

<https://www.crestron.com/products/line/crestron-connected>

The following provides an overview of Crestron Connected®.

• Remote operation using a Web browser

You can operate a projector from your computer just like using a remote control.

• Monitoring and control with application software

You can use Crestron RoomView® Express/Crestron Fusion® provided by Crestron® to monitor devices in the system, to communicate with the help desk, and to send emergency messages.

This manual describes how to perform operations on your computer using a Web browser.



- You can only enter single-byte alphanumeric characters and symbols.
- The Message Broadcasting feature for Epson Projector Management is unavailable while using Crestron Connected®.
- If you set **Standby Mode** to **Communication On**, you can control the projector even if it is in standby mode (when the power is off).
☛ **Extended - Standby Mode p.146**

Operating a projector from your computer

Displaying the operation window

Check the following before carrying out any operations.

- Make sure the computer and projector are connected to the network.
- Set **Crestron Connected** to **On** from the **Network** menu.
☛ **Network - Others - Crestron Connected p.159**

1

Start the Web browser on the computer.

- 2 Enter the IP address of the projector in the address field of the Web browser, and press the Enter key on the keyboard.
The Epson Web Control home screen is displayed.
- 3 Press **Crestron Connected**.
The operation window is displayed.

Using the operation window

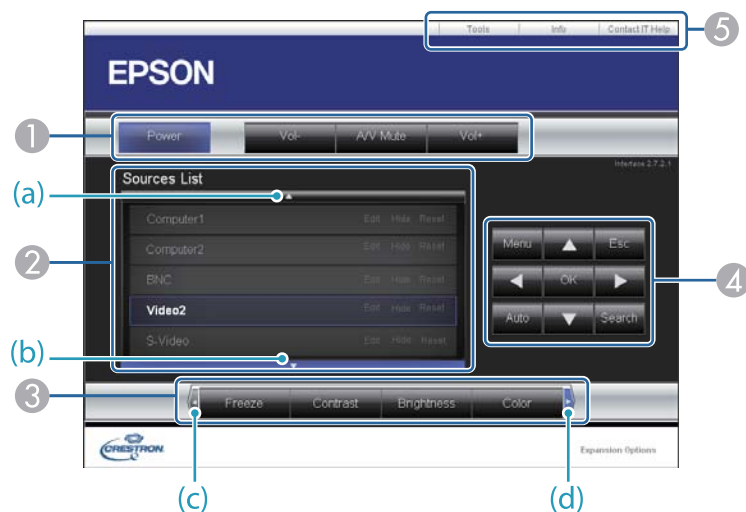

- 1 You can perform the following operations when you click the buttons.

Button	Function
Power	Turns the projector power on or off.
Vol-/Vol+	Adjusts the volume.

Button	Function
A/V Mute	Turns the video and audio on or off. ☛ "Hiding the Image and Sound Temporarily (A/V Mute)" p.102

- 2 Switch to the image from the selected input source. To display input sources that are not shown in Source List, click (a) or (b) to scroll up or down. The current video signal input source is displayed in blue.
You can change the source name if necessary.
- 3 You can perform the following operations when you click the buttons. To display buttons that are not shown in Source List, click (c) or (d) to scroll left or right.

Button	Function
Freeze	Images are paused or unpaused. ☛ "Freezing the Image (Freeze)" p.103
Contrast	Adjusts the difference between light and shade in the images.
Brightness	Adjusts the image brightness.
Color	Adjusts the color saturation for the images.
Sharpness	Adjusts the image sharpness.
Zoom	Click the [⊕] button to enlarge the image without changing the projection size. Click the [⊖] button to reduce the image that was enlarged with the [⊕] button. Click the [▲] [▼] [◀] [▶] buttons to change the position of an enlarged image. ☛ "Enlarging Part of the Image (E-Zoom)" p.104

- 4 The [▲] [▼] [◀] [▶] buttons perform the same operations as the [▲] [▼] [◀] [▶] buttons on the remote control. You can perform the following operations when you click the other buttons.

Button	Function
OK	Performs the same operation as the [↵] button on the remote control. ☛ "Remote Control" p.20
Menu	Displays and closes the Configuration menu.
Auto	If clicked while projecting analog RGB signals from the Computer port, you can automatically optimize Tracking, Sync., and Position.
Search	Changes to the next input source that is sending an image. ☛ "Automatically Detecting Input Signals and Changing the Projected Image (Source Search)" p.61
Esc	Performs the same operation as the [Esc] button on the remote control. ☛ "Remote Control" p.20

5 You can perform the following operations when you click the tabs.

Tab	Function
Help	Displays the Help Desk window. Used to send messages to, and receive messages from, the administrator using Crestron Connected®.
Info	Displays information on the projector that is currently connected.
Tools	Changes settings in the projector that is currently connected. See the next section.

Using the tools window

The following window is displayed when you click the **Tools** tab on the operation window. You can use this window to change settings in the projector that is currently connected.

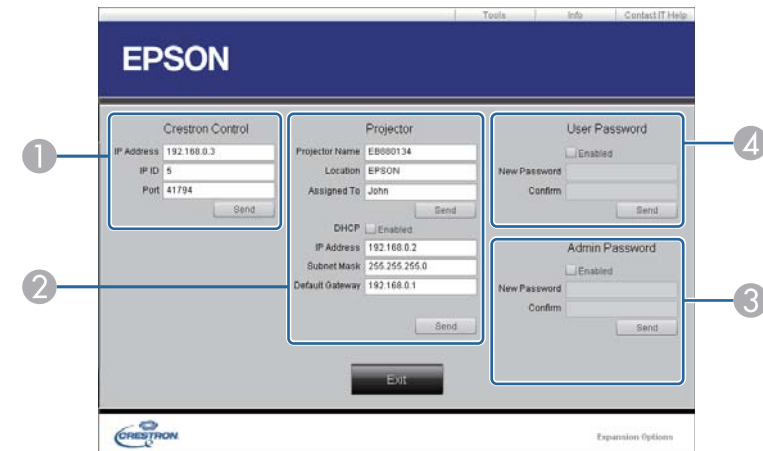

- 1 **Crestron Control**
Make settings for Crestron® central controllers.
- 2 **Projector**
The following items can be set.

Item	Function
Projector Name	Enter a name to differentiate the projector that is currently connected from other projectors on the network. (The name can contain up to 15 single-byte alphanumeric characters.)
Location	Enter an installation location name for the projector that is currently connected on the network. (The name can contain up to 32 single-byte alphanumeric characters and symbols.)
Assigned To	Enter a user name for the projector. (The name can contain up to 32 single-byte alphanumeric characters and symbols.)

Item	Function
DHCP	Select the Enabled check box to use DHCP. You cannot enter an IP address if DHCP is enabled.
IP Address	Enter the IP address to assign to the currently connected projector.
Subnet Mask	Enter a subnet mask for the currently connected projector.
Default Gateway	Enter the gateway address for the currently connected projector.
Send	Click this button to confirm the changes made to the Projector .

3 Admin Password

Select the **Enabled** check box to require a password to open the Tools window. The following items can be set.

Item	Function
New Password	Enter the new password when changing the password to open the Tools window. (The name can contain up to 26 single-byte alphanumeric characters.)
Confirm	Enter the same password as you entered in New Password . If the passwords are not the same, an error is displayed.
Send	Click this button to confirm the changes made to the Admin Password .

4 User Password

Select the **Enabled** check box to require a password to open the operation window on the computer. The following items can be set.

Item	Function
New Password	Enter the new password when changing the password to open the operation window. (The name can contain up to 26 single-byte alphanumeric characters.)
Confirm	Enter the same password as you entered in New Password . If the passwords are not the same, an error is displayed.
Send	Click this button to confirm the changes made to the User Password .

About Web API

You can use Web API to operate the projector when Content Playback mode is enabled.

You can enable Web API from a Web browser.



You can apply API authentication (Digest authentication) to Web API communications.
The user name for API authentication is EPSONWEB; the password is the Web Control Password.

- 1** Open the Epson Web Control home screen in your Web browser.
- 2** Press **Developer's Menu**.
- 3** Set **Enable API** to **On**.
 "Changing Settings Using a Web Browser (Epson Web Control)" [p.215](#)

The following Web API commands are supported by the projector.

URL	Supported methods	Explanation
http://<ip address>/api/v01/contentmgr/remote/power/on	GET/POST/PUT	Turns on the projector. It takes a while for the Web API to respond.
http://<ip address>/api/v01/contentmgr/remote/power/off	GET/POST/PUT	Turns off the projector.
http://<ip address>/api/v01/contentmgr/playlist/play/:id	GET/POST/PUT	Plays the playlist with the specified ID. Enter the playlist ID in :id. You can check the playlist ID from the Developer's Menu on the home screen.
http://<ip address>/api/v01/contentmgr/playlist/stop	GET/POST/PUT	Stops the playlist.

Enter the projector's IP address in <ip address>.

For example, the following URL commands the projector with the IP address 192.168.0.2 to play the playlist with the ID 3.
http://192.168.0.2/api/v01/contentmgr/playlist/play/3

If secure HTTP is enabled, change the http in the URL to https.

The following optional accessories and consumables are available. Please purchase these products as and when needed. The following list of optional accessories and consumables is current as of: June 2019. Details of accessories are subject to change without notice and availability may vary depending on the country of purchase.

Optional Accessories

Lens unit

ELPLX01, ELPLX01W, ELPLU03, ELPLU04, ELPLW05, ELPLW06, ELPLW08, ELPLM08, ELPLM10, ELPLM11, ELPLM15, ELPLL08

See the following for more information on the projection distance for each lens.

🔍 "Screen Size and Projection Distance" [p.234](#)

Computer cable ELPKC02

(1.8 m - for mini D-Sub15-pin/mini D-Sub 15pin)

Computer cable ELPKC09

(3 m - for mini D-Sub15-pin/mini D-Sub 15pin)

Computer cable ELPKC10

(20 m - for mini D-Sub15-pin/mini D-Sub 15pin)

Remote control cable set ELPKC28

(10 m 2 piece set)

Use this to guarantee operation from the remote control from a distance.

HDBaseT Transmitter ELPHD01

This transmitter performs long distance transmissions for HDMI signals and control signals for one LAN cable. Based on the HDBaseT standard. (HDCP 2.2 is not supported.)

Wireless LAN unit ELPAP10

Use when connecting the projector to a computer wirelessly and projecting.
(Frequency band: 2.4 GHz)

Polarizer ELPPL01

Use this when stacking two projectors and projecting 3D images.

Passive 3D Glasses (standard five piece set) ELPGS02A

Passive 3D Glasses (five piece set for children) ELPGS02B

Passive polarized 3D glasses. Use these when viewing 3D images with two projectors.

Document Camera ELPDC13, ELPDC21

Use when projecting images such as books, OHP documents, or slides.

Pipe 450 (450 mm)* ELPFP13

Pipe 700 (700 mm)* ELPFP14

Use when installing the projector on a high ceiling.

Ceiling mount* ELPMB22

Low ceiling mount* ELPMB47

High ceiling mount* ELPMB48

Use when installing the projector on a ceiling. Do not use for any other purpose.

* Special techniques are required to suspend the projector from a ceiling. Contact your local dealer or the nearest address provided in the Epson Projector Contact List.

🔍 [Epson Projector Contact List](#)

Consumables

Air filters ELPAF46

Use as a replacement for used air filters.

Projection Distances for EB-L1075U/EB-L1070U/EB-L1065U/EB-L1060U/EB-L1050U/EB-L1070W/EB-L1060W

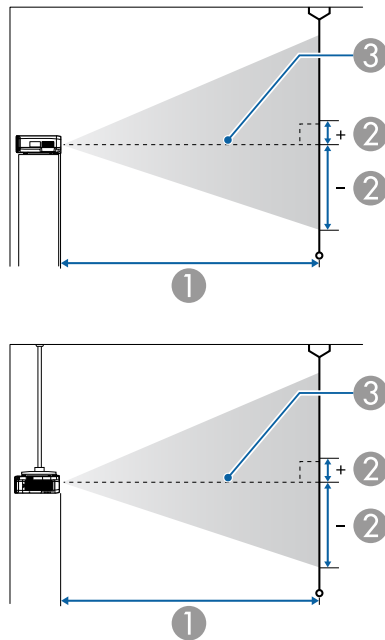

- ① Projection distance
- ② is the distance from the center of the lens to the base of the screen. This changes depending on the setting for vertical lens shift.
- ③ Center of lens



If the screen is larger than 300 inches, fine text and images may not be displayed clearly.

ELPLM08

This section shows the projection distances for models equipped with standard lenses.

Unit: cm

4:3 Screen Size		①	②
		Minimum (Wide) to Maximum (Tele)	Vertical lens shift Bottom to Top
45"	100x75	156 to 253	-81 to +12
50"	102x76	174 to 281	-90 to +13
60"	122x91	210 to 338	-108 to +16
80"	163x122	281 to 453	-143 to +22
100"	203x152	353 to 567	-179 to +27
120"	244x183	424 to 681	-215 to +32
150"	305x229	532 to 853	-269 to +40
200"	406x305	711 to 1139	-359 to +54
250"	508x381	890 to 1424	-448 to +67
300"	610x457	1069 to 1710	-538 to +81
500"	1016x762	1785 to 2853	-896 to +134
800"	1626x1219	2858 to 4568	-1434 to +215
1000"	2032x1524	3574 to 5711	-1793 to +269

Unit: cm

16:9 Screen Size		①	②
		Minimum (Wide) to Maximum (Tele)	Vertical lens shift Bottom to Top
49"	108x61	154 to 250	-76 to +15
50"	111x62	157 to 255	-78 to +16
60"	133x75	190 to 307	-94 to +19



16:9 Screen Size		①	②
		Minimum (Wide) to Maximum (Tele)	Vertical lens shift Bottom to Top
80"	177x100	255 to 411	-125 to +25
100"	221x125	320 to 514	-156 to +31
120"	266x149	385 to 618	-187 to +38
150"	332x187	482 to 774	-234 to +47
200"	443x249	645 to 1033	-312 to +63
250"	553x311	807 to 1293	-390 to +78
300"	664x374	970 to 1552	-468 to +94
500"	1107x623	1620 to 2590	-779 to +157
800"	1771x996	2595 to 4147	-1247 to +251
1000"	2214x1245	3244 to 5185	-1559 to +313

Unit: cm

16:10 Screen Size		①	②
		Minimum (Wide) to Maximum (Tele)	Vertical lens shift Bottom to Top
50"	108x67	153 to 248	-79 to +12
60"	130x81	185 to 298	-95 to +14
80"	172x108	248 to 399	-127 to +19
100"	215x135	311 to 500	-158 to +24
120"	258x162	374 to 601	-190 to +29
150"	323x202	469 to 753	-238 to +36
200"	431x269	627 to 1005	-317 to +48
250"	538x337	785 to 1258	-396 to +59
300"	646x404	943 to 1510	-475 to +71
500"	1077x673	1576 to 2520	-792 to +119

16:10 Screen Size		①	②
		Minimum (Wide) to Maximum (Tele)	Vertical lens shift Bottom to Top
800"	1723x1077	2524 to 4035	-1267 to +190
1000"	2154x1346	3157 to 5044	-1584 to +238

ELPLX01/ELPLX01W

Zoom is not supported.

Unit: cm

4:3 Screen Size		①	②
			Vertical lens shift Bottom to Top
89"	181x136	74	0 to +24
100"	203x152	84	0 to +27
120"	244x183	102	0 to +32
150"	305x229	129	0 to +40
200"	406x305	173	0 to +54
250"	508x381	218	0 to +67
300"	610x457	262	0 to +81
350"	711x533	307	0 to +94
500"	1016x762	440	0 to +134
800"	1626x1219	708	0 to +205

Unit: cm

16:9 Screen Size		①	②
			Vertical lens shift Bottom to Top
98"	217x122	74	+7 to +31

16:9 Screen Size		①	②
			Vertical lens shift Bottom to Top
100"	221x125	76	+7 to +31
120"	266x149	92	+8 to +38
150"	332x187	116	+10 to +47
200"	443x249	157	+14 to +63
250"	553x311	197	+17 to +78
300"	664x374	238	+21 to +94
350"	775x436	278	+24 to +110
500"	1107x623	399	+35 to +157
800"	1771x996	642	+55 to +251

Unit: cm

16:10 Screen Size		①	②
			Vertical lens shift Bottom to Top
100"	215x135	74	0 to +24
120"	258x162	89	0 to +29
150"	323x202	113	0 to +36
200"	431x269	152	0 to +48
250"	538x337	192	0 to +59
300"	646x404	231	0 to +71
350"	754x471	270	0 to +83
400"	862x538	310	0 to +95
500"	1077x673	388	0 to +119
800"	1723x1077	625	0 to +190
1000"	2154x1346	782	0 to +238

ELPLU03

Unit: cm

4:3 Screen Size		①	②
		Minimum (Wide) to Maximum (Tele)	Vertical lens shift Bottom to Top
71"	144x108	112 to 135	-127 to +19
80"	163x122	126 to 152	-143 to +22
100"	203x152	159 to 191	-179 to +27
120"	244x183	191 to 230	-215 to +32
150"	305x229	240 to 289	-269 to +40
200"	406x305	321 to 386	-359 to +54
250"	508x381	403 to 483	-448 to +67
300"	610x457	484 to 581	-538 to +81
500"	1016x762	809 to 971	-896 to +134
800"	1626x1219	1297 to 1555	-1434 to +215

Unit: cm

16:9 Screen Size		①	②
		Minimum (Wide) to Maximum (Tele)	Vertical lens shift Bottom to Top
78"	173x97	111 to 134	-122 to +24
80"	177x100	114 to 138	-125 to +25
100"	221x125	144 to 173	-156 to +31
120"	266x149	173 to 209	-187 to +38
150"	332x187	218 to 262	-234 to +47
200"	443x249	291 to 350	-312 to +63
250"	553x311	365 to 439	-390 to +78
300"	664x374	439 to 527	-468 to +94



16:9 Screen Size		①	②
		Minimum (Wide) to Maximum (Tele)	Vertical lens shift Bottom to Top
500"	1107x623	734 to 881	-779 to +157
800"	1771x996	1177 to 1412	-1247 to +251

Unit: cm

16:10 Screen Size		①	②
		Minimum (Wide) to Maximum (Tele)	Vertical lens shift Bottom to Top
80"	172x108	111 to 134	-127 to +19
100"	215x135	140 to 168	-158 to +24
120"	258x162	169 to 203	-190 to +29
150"	323x202	212 to 255	-238 to +36
200"	431x269	283 to 341	-317 to +48
250"	538x337	355 to 427	-396 to +59
300"	646x404	427 to 513	-475 to +71
500"	1077x673	714 to 857	-792 to +119
800"	1723x1077	1145 to 1373	-1267 to +190
1000"	2154x1346	1432 to 1717	-1584 to +238

Unit: cm

ELPLU04/ELPLU02

4:3 Screen Size		①	②
		Minimum (Wide) to Maximum (Tele)	Vertical lens shift Bottom to Top
45"	100x75	93 to 113	-81 to +12
50"	102x76	104 to 126	-90 to +13

4:3 Screen Size		①	②
		Minimum (Wide) to Maximum (Tele)	Vertical lens shift Bottom to Top
60"	122x91	126 to 153	-108 to +16
80"	163x122	170 to 205	-143 to +22
100"	203x152	214 to 258	-179 to +27
120"	244x183	258 to 311	-215 to +32
150"	305x229	324 to 390	-269 to +40
200"	406x305	434 to 522	-359 to +54
250"	508x381	543 to 654	-448 to +67
300"	610x457	653 to 786	-538 to +81
500"	1016x762	1092 to 1313	-896 to +134
800"	1626x1219	1751 to 2105	-1434 to +215

Unit: cm

16:9 Screen Size		①	②
		Minimum (Wide) to Maximum (Tele)	Vertical lens shift Bottom to Top
49"	108x61	92 to 112	-76 to +15
50"	111x62	94 to 114	-78 to +16
60"	133x75	114 to 138	-94 to +19
80"	177x100	154 to 186	-125 to +25
100"	221x125	194 to 234	-156 to +31
120"	266x149	234 to 282	-187 to +38
150"	332x187	293 to 354	-234 to +47
200"	443x249	393 to 473	-312 to +63
250"	553x311	493 to 593	-390 to +78
300"	664x374	592 to 713	-468 to +94



16:9 Screen Size		①	②
		Minimum (Wide) to Maximum (Tele)	Vertical lens shift Bottom to Top
50"	1107x623	991 to 1192	-779 to +157
80"	1771x996	1589 to 1910	-1247 to +251

Unit: cm

16:10 Screen Size		①	②
		Minimum (Wide) to Maximum (Tele)	Vertical lens shift Bottom to Top
50"	108x67	91 to 111	-79 to +12
60"	130x81	111 to 134	-95 to +14
80"	172x108	149 to 181	-127 to +19
100"	215x135	188 to 227	-158 to +24
120"	258x162	227 to 274	-190 to +29
150"	323x202	285 to 344	-238 to +36
200"	431x269	382 to 460	-317 to +48
250"	538x337	479 to 577	-396 to +59
300"	646x404	576 to 693	-475 to +71
500"	1077x673	964 to 1159	-792 to +119
800"	1723x1077	1546 to 1858	-1267 to +190
1000"	2154x1346	1934 to 2324	-1584 to +238

ELPLW05

Unit: cm

4:3 Screen Size		①	②
		Minimum (Wide) to Maximum (Tele)	Vertical lens shift Bottom to Top
45"	100x75	111 to 158	-81 to +12
50"	102x76	124 to 176	-90 to +13
60"	122x91	150 to 212	-108 to +16
80"	163x122	203 to 285	-143 to +22
100"	203x152	255 to 357	-179 to +27
120"	244x183	308 to 430	-215 to +32
150"	305x229	387 to 539	-269 to +40
200"	406x305	519 to 720	-359 to +54
250"	508x381	650 to 902	-448 to +67
300"	610x457	782 to 1083	-538 to +81
500"	1016x762	1308 to 1809	-896 to +134
800"	1626x1219	2097 to 2898	-1434 to +215

Unit: cm

16:9 Screen Size		①	②
		Minimum (Wide) to Maximum (Tele)	Vertical lens shift Bottom to Top
49"	108x61	109 to 156	-76 to +15
50"	111x62	112 to 159	-78 to +16
60"	133x75	136 to 192	-94 to +19
80"	177x100	183 to 258	-125 to +25
100"	221x125	231 to 324	-156 to +31
120"	266x149	279 to 390	-187 to +38



16:9 Screen Size		①	②
		Minimum (Wide) to Maximum (Tele)	Vertical lens shift Bottom to Top
150"	332x187	351 to 489	-234 to +47
200"	443x249	470 to 653	-312 to +63
250"	553x311	590 to 818	-390 to +78
300"	664x374	709 to 983	-468 to +94
500"	1107x623	1187 to 1642	-779 to +157
800"	1771x996	1903 to 2631	-1247 to +251

Unit: cm

16:10 Screen Size		①	②
		Minimum (Wide) to Maximum (Tele)	Vertical lens shift Bottom to Top
50"	108x67	109 to 155	-79 to +12
60"	130x81	132 to 187	-95 to +14
80"	172x108	178 to 251	-127 to +19
100"	215x135	225 to 315	-158 to +24
120"	258x162	271 to 379	-190 to +29
150"	323x202	341 to 475	-238 to +36
200"	431x269	457 to 636	-317 to +48
250"	538x337	573 to 796	-396 to +59
300"	646x404	690 to 956	-475 to +71
500"	1077x673	1154 to 1597	-792 to +119
800"	1723x1077	1852 to 2559	-1267 to +190
1000"	2154x1346	2317 to 3201	-1584 to +238

ELPLW06/ELPLW04

Unit: cm

4:3 Screen Size		①	②
		Minimum (Wide) to Maximum (Tele)	Vertical lens shift Bottom to Top
45"	97x61	175 to 240	-81 to +12
50"	102x76	195 to 267	-90 to +13
60"	122x91	236 to 322	-108 to +16
80"	163x122	317 to 432	-143 to +22
100"	203x152	398 to 543	-179 to +27
120"	244x183	479 to 653	-215 to +32
150"	305x229	600 to 818	-269 to +40
200"	406x305	803 to 1094	-359 to +54
250"	508x381	1005 to 1369	-448 to +67
300"	610x457	1207 to 1645	-538 to +81
500"	1016x762	2017 to 2747	-896 to +134
800"	1626x1219	3232 to 4400	-1434 to +215

Unit: cm

16:9 Screen Size		①	②
		Minimum (Wide) to Maximum (Tele)	Vertical lens shift Bottom to Top
49"	108x61	173 to 237	-76 to +15
50"	111x62	176 to 242	-78 to +16
60"	133x75	213 to 292	-94 to +19
80"	177x100	287 to 392	-125 to +25
100"	221x125	360 to 492	-156 to +31
120"	266x149	434 to 592	-187 to +38

16:9 Screen Size		①	②
		Minimum (Wide) to Maximum (Tele)	Vertical lens shift Bottom to Top
150"	332x187	544 to 742	-234 to +47
200"	443x249	728 to 992	-312 to +63
250"	553x311	912 to 1242	-390 to +78
300"	664x374	1096 to 1492	-468 to +94
500"	1107x623	1831 to 2493	-779 to +157
800"	1771x996	2934 to 3994	-1247 to +251

Unit: cm

16:10 Screen Size		①	②
		Minimum (Wide) to Maximum (Tele)	Vertical lens shift Bottom to Top
50"	108x67	172 to 235	-79 to +12
60"	130x81	207 to 284	-95 to +14
80"	172x108	279 to 381	-127 to +19
100"	215x135	350 to 478	-158 to +24
120"	258x162	422 to 576	-190 to +29
150"	323x202	529 to 722	-238 to +36
200"	431x269	708 to 965	-317 to +48
250"	538x337	887 to 1208	-396 to +59
300"	646x404	1066 to 1452	-475 to +71
500"	1077x673	1781 to 2425	-792 to +119
800"	1723x1077	2854 to 3885	-1267 to +190
1000"	2154x1346	3569 to 4859	-1584 to +238

ELPLW08

Unit: cm

4:3 Screen Size		①	②
		Minimum (Wide) to Maximum (Tele)	Vertical lens shift Bottom to Top
45"	100x75	127 to 179	-81 to +12
60"	122x91	171 to 240	-108 to +16
80"	163x122	229 to 322	-143 to +22
100"	203x152	288 to 404	-179 to +27
120"	244x183	346 to 486	-215 to +32
150"	305x229	434 to 609	-269 to +40
200"	406x305	580 to 813	-359 to +54
250"	508x381	726 to 1018	-448 to +67
300"	610x457	872 to 1223	-538 to +81
500"	1016x762	1457 to 2042	-896 to +134
800"	1626x1219	2334 to 3270	-1434 to +215

Unit: cm

16:9 Screen Size		①	②
		Minimum (Wide) to Maximum (Tele)	Vertical lens shift Bottom to Top
49"	108x61	125 to 177	-76 to +15
60"	133x75	154 to 218	-94 to +19
80"	177x100	208 to 292	-125 to +25
100"	221x125	261 to 366	-156 to +31
120"	266x149	314 to 441	-187 to +38
150"	332x187	393 to 552	-234 to +47
200"	443x249	526 to 738	-312 to +63



16:9 Screen Size		①	②
		Minimum (Wide) to Maximum (Tele)	Vertical lens shift Bottom to Top
250"	553x311	659 to 924	-390 to +78
300"	664x374	792 to 1110	-468 to +94
500"	1107x623	1323 to 1853	-779 to +157
800"	1771x996	2119 to 2969	-1247 to +251

Unit: cm

16:10 Screen Size		①	②
		Minimum (Wide) to Maximum (Tele)	Vertical lens shift Bottom to Top
50"	108x67	124 to 175	-79 to +12
60"	130x81	150 to 212	-95 to +14
80"	172x108	202 to 284	-127 to +19
100"	215x135	253 to 356	-158 to +24
120"	258x162	305 to 429	-190 to +29
150"	323x202	383 to 537	-238 to +36
200"	431x269	512 to 718	-317 to +48
250"	538x337	641 to 899	-396 to +59
300"	646x404	770 to 1080	-475 to +71
500"	1077x673	1287 to 1803	-792 to +119
800"	1723x1077	2061 to 2888	-1267 to +190
1000"	2154x1346	2578 to 3611	-1584 to +238

ELPLM15/ELPLM09/ELPLS04

Unit: cm

4:3 Screen Size		①	②
		Minimum (Wide) to Maximum (Tele)	Vertical lens shift Bottom to Top
45"	100x75	233 to 379	-81 to +12
50"	102x76	260 to 422	-90 to +13
60"	122x91	313 to 508	-108 to +16
80"	163x122	420 to 679	-143 to +22
100"	203x152	527 to 851	-179 to +27
120"	244x183	635 to 1023	-215 to +32
150"	305x229	795 to 1281	-269 to +40
200"	406x305	1063 to 1711	-359 to +54
250"	508x381	1331 to 2140	-448 to +67
300"	610x457	1598 to 2570	-538 to +81
500"	1016x762	2669 to 4288	-896 to +134
800"	1626x1219	4276 to 6866	-1434 to +215

Unit: cm

16:9 Screen Size		①	②
		Minimum (Wide) to Maximum (Tele)	Vertical lens shift Bottom to Top
49"	108x61	230 to 374	-76 to +15
50"	111x62	235 to 382	-78 to +16
60"	133x75	284 to 460	-94 to +19
80"	177x100	381 to 616	-125 to +25
100"	221x125	478 to 772	-156 to +31
120"	266x149	575 to 928	-187 to +38

16:9 Screen Size		①	②
		Minimum (Wide) to Maximum (Tele)	Vertical lens shift Bottom to Top
150"	332x187	721 to 1162	-234 to +47
200"	443x249	964 to 1552	-312 to +63
250"	553x311	1207 to 1942	-390 to +78
300"	664x374	1450 to 2332	-468 to +94
500"	1107x623	2423 to 3893	-779 to +157
800"	1771x996	3881 to 6233	-1247 to +251

Unit: cm

16:10 Screen Size		①	②
		Minimum (Wide) to Maximum (Tele)	Vertical lens shift Bottom to Top
50"	108x67	229 to 372	-79 to +12
60"	130x81	276 to 447	-95 to +14
80"	172x108	370 to 599	-127 to +19
100"	215x135	465 to 751	-158 to +24
120"	258x162	560 to 903	-190 to +29
150"	323x202	702 to 1131	-238 to +36
200"	431x269	938 to 1510	-317 to +48
250"	538x337	1175 to 1890	-396 to +59
300"	646x404	1411 to 2269	-475 to +71
500"	1077x673	2357 to 3787	-792 to +119
800"	1723x1077	3776 to 6064	-1267 to +190
1000"	2154x1346	4722 to 7582	-1584 to +238

ELPLM10/ELPLM06

Unit: cm

4:3 Screen Size		①	②
		Minimum (Wide) to Maximum (Tele)	Vertical lens shift Bottom to Top
45"	100x75	359 to 549	-81 to +12
50"	102x76	400 to 611	-90 to +13
60"	122x91	483 to 736	-108 to +16
80"	163x122	648 to 986	-143 to +22
100"	203x152	813 to 1236	-179 to +27
120"	244x183	979 to 1485	-215 to +32
150"	305x229	1227 to 1860	-269 to +40
200"	406x305	1640 to 2484	-359 to +54
250"	508x381	2053 to 3109	-448 to +67
300"	610x457	2466 to 3733	-538 to +81
500"	1016x762	4119 to 6230	-896 to +134
800"	1626x1219	6598 to 9976	-1434 to +215

Unit: cm

16:9 Screen Size		①	②
		Minimum (Wide) to Maximum (Tele)	Vertical lens shift Bottom to Top
49"	108x61	355 to 542	-76 to +15
50"	111x62	362 to 554	-78 to +16
60"	133x75	437 to 667	-94 to +19
80"	177x100	587 to 894	-125 to +25
100"	221x125	737 to 1121	-156 to +31
120"	266x149	887 to 1347	-187 to +38

16:9 Screen Size		①	②
		Minimum (Wide) to Maximum (Tele)	Vertical lens shift Bottom to Top
150"	332x187	1112 to 1687	-234 to +47
200"	443x249	1488 to 2254	-312 to +63
250"	553x311	1863 to 2821	-390 to +78
300"	664x374	2238 to 3388	-468 to +94
500"	1107x623	3738 to 5655	-779 to +157
800"	1771x996	5989 to 9056	-1247 to +251

Unit: cm

16:10 Screen Size		①	②
		Minimum (Wide) to Maximum (Tele)	Vertical lens shift Bottom to Top
50"	108x67	352 to 538	-79 to +12
60"	130x81	425 to 649	-95 to +14
80"	172x108	571 to 869	-127 to +19
100"	215x135	717 to 1090	-158 to +24
120"	258x162	863 to 1311	-190 to +29
150"	323x202	1082 to 1641	-238 to +36
200"	431x269	1447 to 2193	-317 to +48
250"	538x337	1812 to 2744	-396 to +59
300"	646x404	2177 to 3296	-475 to +71
500"	1077x673	3637 to 5502	-792 to +119
800"	1723x1077	5827 to 8811	-1267 to +190
1000"	2154x1346	7287 to 11017	-1584 to +238

ELPLM11/ELPLM07

Unit: cm

4:3 Screen Size		①	②
		Minimum (Wide) to Maximum (Tele)	Vertical lens shift Bottom to Top
45"	100x75	521 to 799	-81 to +12
50"	102x76	582 to 890	-90 to +13
60"	122x91	703 to 1073	-108 to +16
80"	163x122	945 to 1438	-143 to +22
100"	203x152	1188 to 1804	-179 to +27
120"	244x183	1430 to 2169	-215 to +32
150"	305x229	1793 to 2717	-269 to +40
200"	406x305	2399 to 3631	-359 to +54
250"	508x381	3005 to 4544	-448 to +67
300"	610x457	3610 to 5458	-538 to +81
500"	1016x762	6033 to 9112	-896 to +134
800"	1626x1219	9667 to 14594	-1434 to +215

Unit: cm

16:9 Screen Size		①	②
		Minimum (Wide) to Maximum (Tele)	Vertical lens shift Bottom to Top
49"	108x61	515 to 789	-76 to +15
50"	111x62	526 to 806	-78 to +16
60"	133x75	636 to 972	-94 to +19
80"	177x100	856 to 1304	-125 to +25
100"	221x125	1076 to 1635	-156 to +31
120"	266x149	1296 to 1967	-187 to +38



16:9 Screen Size		①	②
		Minimum (Wide) to Maximum (Tele)	Vertical lens shift Bottom to Top
150"	332x187	1626 to 2465	-234 to +47
200"	443x249	2176 to 3294	-312 to +63
250"	553x311	2726 to 4124	-390 to +78
300"	664x374	3276 to 4953	-468 to +94
500"	1107x623	5475 to 8271	-779 to +157
800"	1771x996	8774 to 13248	-1247 to +251

Unit: cm

16:10 Screen Size		①	②
		Minimum (Wide) to Maximum (Tele)	Vertical lens shift Bottom to Top
50"	108x67	511 to 784	-79 to +12
60"	130x81	618 to 945	-95 to +14
80"	172x108	832 to 1268	-127 to +19
100"	215x135	1046 to 1591	-158 to +24
120"	258x162	1260 to 1913	-190 to +29
150"	323x202	1581 to 2398	-238 to +36
200"	431x269	2116 to 3205	-317 to +48
250"	538x337	2651 to 4012	-396 to +59
300"	646x404	3186 to 4819	-475 to +71
500"	1077x673	5326 to 8047	-792 to +119
800"	1723x1077	8536 to 12889	-1267 to +190
1000"	2154x1346	10676 to 16117	-1584 to +238

ELPLL08/ELPLL07

Unit: cm

4:3 Screen Size		①	②
		Minimum (Wide) to Maximum (Tele)	Vertical lens shift Bottom to Top
45"	100x75	776 to 1095	-81 to +12
50"	102x76	866 to 1220	-90 to +13
60"	122x91	1046 to 1470	-108 to +16
80"	163x122	1405 to 1971	-143 to +22
100"	203x152	1764 to 2472	-179 to +27
120"	244x183	2124 to 2972	-215 to +32
150"	305x229	2662 to 3724	-269 to +40
200"	406x305	3561 to 4975	-359 to +54
250"	508x381	4459 to 6227	-448 to +67
300"	610x457	5357 to 7479	-538 to +81
500"	1016x762	8949 to 12485	-896 to +134
800"	1626x1219	14338 to 19996	-1434 to +215

Unit: cm

16:9 Screen Size		①	②
		Minimum (Wide) to Maximum (Tele)	Vertical lens shift Bottom to Top
49"	108x61	767 to 1082	-76 to +15
50"	111x62	784 to 1105	-78 to +16
60"	133x75	947 to 1332	-94 to +19
80"	177x100	1273 to 1787	-125 to +25
100"	221x125	1599 to 2241	-156 to +31
120"	266x149	1925 to 2696	-187 to +38



16:9 Screen Size		①	②
		Minimum (Wide) to Maximum (Tele)	Vertical lens shift Bottom to Top
150"	332x187	2414 to 3378	-234 to +47
200"	443x249	3230 to 4514	-312 to +63
250"	553x311	4045 to 5650	-390 to +78
300"	664x374	4860 to 6787	-468 to +94
500"	1107x623	8122 to 11333	-779 to +157
800"	1771x996	13014 to 18151	-1247 to +251

Unit: cm

16:10 Screen Size		①	②
		Minimum (Wide) to Maximum (Tele)	Vertical lens shift Bottom to Top
50"	108x67	761 to 1074	-79 to +12
60"	130x81	920 to 1295	-95 to +14
80"	172x108	1237 to 1737	-127 to +19
100"	215x135	1555 to 2180	-158 to +24
120"	258x162	1872 to 2622	-190 to +29
150"	323x202	2348 to 3285	-238 to +36
200"	431x269	3141 to 4391	-317 to +48
250"	538x337	3935 to 5497	-396 to +59
300"	646x404	4728 to 6602	-475 to +71
500"	1077x673	7901 to 11025	-792 to +119
800"	1723x1077	12661 to 17659	-1267 to +190
1000"	2154x1346	15834 to 22082	-1584 to +238

ELPLR04

Zoom and lens shift are not supported.

Unit: cm

4:3 Screen Size		①	②
45"	91x69	102	-34
50"	102x76	114	-38
60"	122x91	138	-46
80"	163x122	186	-61
100"	203x152	234	-76
120"	244x183	282	-91
150"	305x229	354	-114
200"	406x305	473	-152
250"	508x381	593	-191
300"	610x457	713	-229
500"	1016x762	1193	-381
800"	1626x1219	1912	-610

Unit: cm

16:9 Screen Size		①	②
49"	108x61	101	-30
50"	111x62	103	-31
60"	133x75	124	-37
80"	177x100	168	-50
100"	221x125	212	-62
120"	266x149	255	-75
150"	332x187	320	-93
200"	443x249	429	-125



16:9 Screen Size		①	②
250"	553x311	538	-156
300"	664x374	647	-187
500"	1107x623	1082	-311
800"	1771x996	1735	-498

Unit: cm

16:10 Screen Size		①	②
50"	108x67	100	-34
60"	130x81	121	-40
80"	172x108	163	-54
100"	215x135	206	-67
120"	258x162	248	-81
150"	323x202	312	-101
200"	431x269	417	-135
250"	538x337	523	-168
300"	646x404	629	-202
500"	1077x673	1053	-337
800"	1723x1077	1688	-538
1000"	2154x1346	2112	-673

Projection Distances for EB-L1070

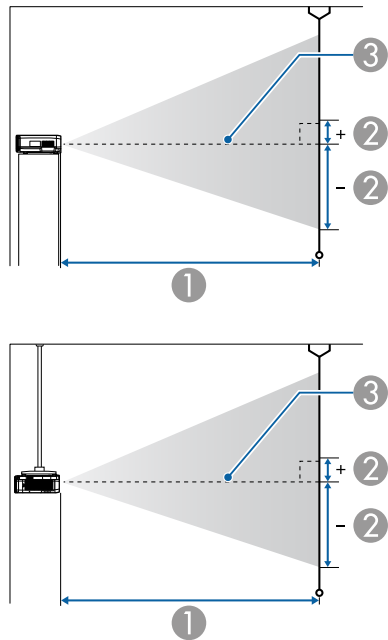

- ① Projection distance
- ② is the distance from the center of the lens to the base of the screen. This changes depending on the setting for vertical lens shift.
- ③ Center of lens



If the screen is larger than 300 inches, fine text and images may not be displayed clearly.

ELPLM08

This section shows the projection distances for models equipped with standard lenses.

Unit: cm

4:3 Screen Size		①	②
		Minimum (Wide) to Maximum (Tele)	Vertical lens shift Bottom to Top
50"	102x76	147 to 239	-82 to +6
60"	122x91	178 to 288	-98 to +7
80"	163x122	239 to 385	-131 to +9
100"	203x152	299 to 482	-164 to +12
120"	244x183	360 to 580	-197 to +14
150"	305x229	452 to 726	-246 to +17
200"	406x305	604 to 969	-328 to +23
250"	508x381	756 to 1213	-410 to +29
300"	610x457	908 to 1456	-492 to +35
500"	1016x762	1517 to 2430	-820 to +58
800"	1626x1219	2431 to 3891	-1312 to +93
1000"	2032x1524	3040 to 4865	-1640 to +116

Unit: cm

16:9 Screen Size		①	②
		Minimum (Wide) to Maximum (Tele)	Vertical lens shift Bottom to Top
46"	102x57	148 to 240	-73 to +15
50"	111x62	161 to 261	-79 to +17
60"	133x75	194 to 314	-95 to +20
80"	177x100	260 to 420	-126 to +27
100"	221x125	327 to 526	-158 to +33
120"	266x149	393 to 632	-189 to +40
150"	332x187	493 to 791	-237 to +50

16:9 Screen Size		①	②
		Minimum (Wide) to Maximum (Tele)	Vertical lens shift Bottom to Top
200"	443x249	658 to 1057	-316 to +67
250"	553x311	824 to 1322	-395 to +83
300"	664x374	990 to 1587	-474 to +100
500"	1107x623	1654 to 2648	-789 to +167
800"	1771x996	2649 to 4240	-1263 to +267
1000"	2214x1245	3312 to 5301	-1579 to +334

Unit: cm

16:10 Screen Size		①	②
		Minimum (Wide) to Maximum (Tele)	Vertical lens shift Bottom to Top
48"	103x65	150 to 243	-77 to +12
50"	108x67	156 to 254	-80 to +13
60"	130x81	189 to 305	-96 to +15
80"	172x108	253 to 408	-128 to +21
100"	215x135	318 to 512	-160 to +26
120"	258x162	382 to 615	-192 to +31
150"	323x202	479 to 770	-241 to +39
200"	431x269	640 to 1028	-321 to +51
250"	538x337	802 to 1286	-401 to +64
300"	646x404	963 to 1544	-481 to +77
500"	1077x673	1609 to 2576	-802 to +129
800"	1723x1077	2577 to 4125	-1283 to +206
1000"	2154x1346	3223 to 5157	-1603 to +257

ELPLX01/ELPLX01W

Zoom is not supported.

4:3 Screen Size		①	②
			Vertical lens shift Bottom to Top
100"	203x152	71	0 to +12
120"	244x183	86	0 to +14
150"	305x229	109	0 to +17
200"	406x305	147	0 to +23
250"	508x381	185	0 to +29
300"	610x457	223	0 to +35
350"	711x533	261	0 to +40
400"	813x610	299	0 to +46
500"	1016x762	375	0 to +58
800"	1626x1219	603	0 to +93
1000"	2032x1524	755	0 to +116

Unit: cm

16:9 Screen Size		①	②
			Vertical lens shift Bottom to Top
92"	204x115	71	+19 to +31
100"	221x125	77	+21 to +33
120"	266x149	94	+25 to +40
150"	332x187	119	+31 to +50
200"	443x249	160	+42 to +67
250"	553x311	202	+52 to +83
300"	664x374	243	+62 to +100



16:9 Screen Size		①	②
			Vertical lens shift Bottom to Top
350"	775x436	285	+73 to +117
500"	1107x623	409	+104 to +167
800"	1771x996	657	+166 to +267

Unit: cm

16:10 Screen Size		①	②
			Vertical lens shift Bottom to Top
95"	205x128	71	+13 to +24
100"	215x135	75	+13 to +26
120"	258x162	91	+16 to +31
150"	323x202	116	+20 to +39
200"	431x269	156	+27 to +51
250"	538x337	196	+34 to +64
300"	646x404	236	+40 to +77
350"	754x471	277	+47 to +90
500"	1077x673	398	+67 to +129
800"	1723x1077	639	+108 to +206

Unit: cm

ELPLU03

4:3 Screen Size		①	②
		Minimum (Wide) to Maximum (Tele)	Vertical lens shift Bottom to Top
80"	163x122	107 to 129	-131 to +9

4:3 Screen Size		①	②
		Minimum (Wide) to Maximum (Tele)	Vertical lens shift Bottom to Top
100"	203x152	134 to 162	-164 to +12
120"	244x183	162 to 196	-197 to +14
150"	305x229	204 to 245	-246 to +17
200"	406x305	273 to 328	-328 to +23
250"	508x381	342 to 411	-410 to +29
300"	610x457	411 to 494	-492 to +35
500"	1016x762	687 to 826	-820 to +58
800"	1626x1219	1101 to 1323	-1312 to +93
1000"	2032x1524	1377 to 1655	-1640 to +116

Unit: cm

16:9 Screen Size		①	②
		Minimum (Wide) to Maximum (Tele)	Vertical lens shift Bottom to Top
74"	164x92	108 to 130	-117 to +25
80"	177x100	117 to 141	-126 to +27
100"	221x125	147 to 177	-158 to +33
120"	266x149	177 to 213	-189 to +40
150"	332x187	222 to 268	-237 to +50
200"	443x249	297 to 358	-316 to +67
250"	553x311	373 to 448	-395 to +83
300"	664x374	448 to 539	-474 to +100
500"	1107x623	749 to 900	-789 to +167
800"	1771x996	1200 to 1442	-1263 to +267

Unit: cm

16:10 Screen Size		①	②
		Minimum (Wide) to Maximum (Tele)	Vertical lens shift Bottom to Top
76"	164x102	108 to 130	-122 to +20
80"	172x108	113 to 137	-128 to +21
100"	215x135	143 to 172	-160 to +26
120"	258x162	172 to 208	-192 to +31
150"	323x202	216 to 260	-241 to +39
200"	431x269	289 to 348	-321 to +51
250"	538x337	362 to 436	-401 to +64
300"	646x404	436 to 524	-481 to +77
500"	1077x673	728 to 876	-802 to +129
800"	1723x1077	1168 to 1403	-1283 to +206

4:3 Screen Size		①	②
		Minimum (Wide) to Maximum (Tele)	Vertical lens shift Bottom to Top
300"	610x457	555 to 669	-492 to +35
500"	1016x762	929 to 1119	-820 to +58
800"	1626x1219	1490 to 1794	-1312 to +93
1000"	2032x1524	1864 to 2244	-1640 to +116

Unit: cm

16:9 Screen Size		①	②
		Minimum (Wide) to Maximum (Tele)	Vertical lens shift Bottom to Top
46"	102x57	88 to 107	-73 to +15
50"	111x62	96 to 117	-79 to +17
60"	133x75	117 to 141	-95 to +20
80"	177x100	157 to 191	-126 to +27
100"	221x125	198 to 240	-158 to +33
120"	266x149	239 to 289	-189 to +40
150"	332x187	300 to 362	-237 to +50
200"	443x249	402 to 485	-316 to +67
250"	553x311	504 to 607	-395 to +83
300"	664x374	606 to 730	-474 to +100
500"	1107x623	1013 to 1220	-789 to +167
800"	1771x996	1624 to 1955	-1263 to +267

ELPLU04/ELPLU02

Unit: cm

4:3 Screen Size		①	②
		Minimum (Wide) to Maximum (Tele)	Vertical lens shift Bottom to Top
50"	102x76	88 to 107	-82 to +6
60"	122x91	107 to 129	-98 to +7
80"	163x122	144 to 174	-131 to +9
100"	203x152	181 to 219	-164 to +12
120"	244x183	219 to 264	-197 to +14
150"	305x229	275 to 332	-246 to +17
200"	406x305	368 to 444	-328 to +23
250"	508x381	462 to 557	-410 to +29



Unit: cm

16:10 Screen Size		①	②
		Minimum (Wide) to Maximum (Tele)	Vertical lens shift Bottom to Top
48"	103x65	90 to 109	-77 to +12
50"	108x67	93 to 114	-80 to +13
60"	130x81	113 to 138	-96 to +15
80"	172x108	153 to 185	-128 to +21
100"	215x135	193 to 233	-160 to +26
120"	258x162	232 to 281	-192 to +31
150"	323x202	292 to 352	-241 to +39
200"	431x269	391 to 471	-321 to +51
250"	538x337	490 to 591	-401 to +64
300"	646x404	589 to 710	-481 to +77
500"	1077x673	985 to 1187	-802 to +129
800"	1723x1077	1580 to 1902	-1283 to +206

4:3 Screen Size		①	②
		Minimum (Wide) to Maximum (Tele)	Vertical lens shift Bottom to Top
200"	406x305	440 to 612	-328 to +23
250"	508x381	552 to 767	-410 to +29
300"	610x457	664 to 922	-492 to +35
500"	1016x762	1112 to 1540	-820 to +58
800"	1626x1219	1784 to 2467	-1312 to +93
1000"	2032x1524	2232 to 3086	-1640 to +116

Unit: cm

ELPLW05

Unit: cm

4:3 Screen Size		①	②
		Minimum (Wide) to Maximum (Tele)	Vertical lens shift Bottom to Top
50"	102x76	104 to 149	-82 to +6
60"	122x91	127 to 180	-98 to +7
80"	163x122	171 to 242	-131 to +9
100"	203x152	216 to 303	-164 to +12
120"	244x183	261 to 365	-197 to +14
150"	305x229	328 to 458	-246 to +17

16:9 Screen Size		①	②
		Minimum (Wide) to Maximum (Tele)	Vertical lens shift Bottom to Top
46"	102x57	104 to 149	-73 to +15
50"	111x62	114 to 163	-79 to +17
60"	133x75	139 to 196	-95 to +20
80"	177x100	187 to 264	-126 to +27
100"	221x125	236 to 331	-158 to +33
120"	266x149	285 to 398	-189 to +40
150"	332x187	358 to 499	-237 to +50
200"	443x249	480 to 668	-316 to +67
250"	553x311	602 to 836	-395 to +83
300"	664x374	724 to 1005	-474 to +100
500"	1107x623	1212 to 1678	-789 to +167
800"	1771x996	1944 to 2689	-1263 to +267



Unit: cm

16:10 Screen Size		①	②
		Minimum (Wide) to Maximum (Tele)	Vertical lens shift Bottom to Top
48"	103x65	106 to 151	-77 to +12
50"	108x67	111 to 158	-80 to +13
60"	130x81	135 to 191	-96 to +15
80"	172x108	182 to 256	-128 to +21
100"	215x135	230 to 322	-160 to +26
120"	258x162	277 to 387	-192 to +31
150"	323x202	348 to 486	-241 to +39
200"	431x269	467 to 650	-321 to +51
250"	538x337	586 to 813	-401 to +64
300"	646x404	704 to 977	-481 to +77
500"	1077x673	1179 to 1633	-802 to +129
800"	1723x1077	1891 to 2616	-1283 to +206

4:3 Screen Size		①	②
		Minimum (Wide) to Maximum (Tele)	Vertical lens shift Bottom to Top
200"	406x305	682 to 930	-328 to +23
250"	508x381	854 to 1164	-410 to +29
300"	610x457	1026 to 1398	-492 to +35
500"	1016x762	1715 to 2336	-820 to +58
800"	1626x1219	2749 to 3741	-1312 to +93
1000"	2032x1524	3438 to 4678	-1640 to +116

Unit: cm

ELPLW06/ELPLW04

Unit: cm

4:3 Screen Size		①	②
		Minimum (Wide) to Maximum (Tele)	Vertical lens shift Bottom to Top
50"	102x76	165 to 227	-82 to +6
60"	122x91	199 to 274	-98 to +7
80"	163x122	268 to 368	-131 to +9
100"	203x152	337 to 461	-164 to +12
120"	244x183	406 to 555	-197 to +14
150"	305x229	509 to 696	-246 to +17

16:9 Screen Size		①	②
		Minimum (Wide) to Maximum (Tele)	Vertical lens shift Bottom to Top
46"	102x57	165 to 228	-73 to +15
50"	111x62	180 to 248	-79 to +17
60"	133x75	218 to 299	-95 to +20
80"	177x100	293 to 401	-126 to +27
100"	221x125	368 to 503	-158 to +33
120"	266x149	443 to 605	-189 to +40
150"	332x187	556 to 759	-237 to +50
200"	443x249	743 to 1014	-316 to +67
250"	553x311	931 to 1269	-395 to +83
300"	664x374	1119 to 1524	-474 to +100
500"	1107x623	1869 to 2545	-789 to +167
800"	1771x996	2995 to 4076	-1263 to +267



Unit: cm

16:10 Screen Size		①	②
		Minimum (Wide) to Maximum (Tele)	Vertical lens shift Bottom to Top
48"	98x73	168 to 231	-77 to +12
50"	108x67	175 to 241	-80 to +13
60"	130x81	212 to 291	-96 to +15
80"	172x108	285 to 390	-128 to +21
100"	215x135	358 to 489	-160 to +26
120"	258x162	431 to 589	-192 to +31
150"	323x202	540 to 738	-241 to +39
200"	431x269	723 to 986	-321 to +51
250"	538x337	906 to 1234	-401 to +64
300"	646x404	1088 to 1483	-481 to +77
500"	1077x673	1818 to 2476	-802 to +129
800"	1723x1077	2914 to 3966	-1283 to +206

4:3 Screen Size		①	②
		Minimum (Wide) to Maximum (Tele)	Vertical lens shift Bottom to Top
200"	406x305	493 to 692	-328 to +23
250"	508x381	617 to 866	-410 to +29
300"	610x457	741 to 1040	-492 to +35
500"	1016x762	1238 to 1737	-820 to +58
800"	1626x1219	1984 to 2782	-1312 to +93
1000"	2032x1524	2481 to 3479	-1640 to +116

Unit: cm

ELPLW08

Unit: cm

4:3 Screen Size		①	②
		Minimum (Wide) to Maximum (Tele)	Vertical lens shift Bottom to Top
50"	102x76	120 to 169	-82 to +6
60"	122x91	145 to 204	-98 to +7
80"	163x122	194 to 273	-131 to +9
100"	203x152	244 to 343	-164 to +12
120"	244x183	294 to 413	-197 to +14
150"	305x229	368 to 517	-246 to +17

16:9 Screen Size		①	②
		Minimum (Wide) to Maximum (Tele)	Vertical lens shift Bottom to Top
46"	102x57	120 to 169	-73 to +15
60"	133x75	158 to 222	-95 to +20
80"	177x100	212 to 298	-126 to +27
100"	221x125	266 to 374	-158 to +33
120"	266x149	320 to 450	-189 to +40
150"	332x187	402 to 564	-237 to +50
200"	443x249	537 to 754	-316 to +67
250"	553x311	672 to 944	-395 to +83
300"	664x374	808 to 1134	-474 to +100
500"	1107x623	1349 to 1893	-789 to +167
800"	1771x996	2162 to 3032	-1263 to +267



Unit: cm

16:10 Screen Size		①	②
		Minimum (Wide) to Maximum (Tele)	Vertical lens shift Bottom to Top
48"	103x65	122 to 172	-77 to +12
60"	130x81	154 to 216	-96 to +15
80"	172x108	206 to 290	-128 to +21
100"	215x135	259 to 364	-160 to +26
120"	258x162	312 to 438	-192 to +31
150"	323x202	391 to 549	-241 to +39
200"	431x269	522 to 733	-321 to +51
250"	538x337	654 to 918	-401 to +64
300"	646x404	786 to 1103	-481 to +77
500"	1077x673	1313 to 1842	-802 to +129
800"	1723x1077	2103 to 2950	-1283 to +206

4:3 Screen Size		①	②
		Minimum (Wide) to Maximum (Tele)	Vertical lens shift Bottom to Top
250"	508x381	1129 to 1822	-410 to +29
300"	610x457	1357 to 2188	-492 to +35
500"	1016x762	2267 to 3652	-820 to +58
800"	1626x1219	3632 to 5848	-1312 to +93
1000"	2032x1524	4542 to 7312	-1640 to +116

Unit: cm

ELPLM15/ELPLM09/ELPLS04

Unit: cm

4:3 Screen Size		①	②
		Minimum (Wide) to Maximum (Tele)	Vertical lens shift Bottom to Top
50"	102x76	219 to 358	-82 to +6
60"	122x91	265 to 431	-98 to +7
80"	163x122	356 to 578	-131 to +9
100"	203x152	447 to 724	-164 to +12
120"	244x183	538 to 870	-197 to +14
150"	305x229	674 to 1090	-246 to +17
200"	406x305	902 to 1456	-328 to +23

16:9 Screen Size		①	②
		Minimum (Wide) to Maximum (Tele)	Vertical lens shift Bottom to Top
46"	102x57	220 to 359	-73 to +15
50"	111x62	240 to 391	-79 to +17
60"	133x75	289 to 471	-95 to +20
80"	177x100	389 to 630	-126 to +27
100"	221x125	488 to 790	-158 to +33
120"	266x149	587 to 949	-189 to +40
150"	332x187	736 to 1188	-237 to +50
200"	443x249	983 to 1587	-316 to +67
250"	553x311	1231 to 1986	-395 to +83
300"	664x374	1479 to 2385	-474 to +100
500"	1107x623	2471 to 3980	-789 to +167
800"	1771x996	3958 to 6372	-1263 to +267



Unit: cm

16:10 Screen Size		①	②
		Minimum (Wide) to Maximum (Tele)	Vertical lens shift Bottom to Top
48"	103x65	223 to 364	-77 to +12
50"	108x67	233 to 380	-80 to +13
60"	130x81	281 to 458	-96 to +15
80"	172x108	378 to 613	-128 to +21
100"	215x135	474 to 768	-160 to +26
120"	258x162	571 to 923	-192 to +31
150"	323x202	715 to 1156	-241 to +39
200"	431x269	957 to 1544	-321 to +51
250"	538x337	1198 to 1932	-401 to +64
300"	646x404	1439 to 2320	-481 to +77
500"	1077x673	2403 to 3872	-802 to +129
800"	1723x1077	3850 to 6199	-1283 to +206

4:3 Screen Size		①	②
		Minimum (Wide) to Maximum (Tele)	Vertical lens shift Bottom to Top
200"	406x305	1393 to 2115	-328 to +23
250"	508x381	1744 to 2647	-410 to +29
300"	610x457	2096 to 3179	-492 to +35
500"	1016x762	3502 to 5307	-820 to +58
800"	1626x1219	5611 to 8499	-1312 to +93
1000"	2032x1524	7017 to 10627	-1640 to +116

Unit: cm

ELPLM10/ELPLM06

Unit: cm

4:3 Screen Size		①	②
		Minimum (Wide) to Maximum (Tele)	Vertical lens shift Bottom to Top
50"	102x76	338 to 519	-82 to +6
60"	122x91	409 to 625	-98 to +7
80"	163x122	549 to 838	-131 to +9
100"	203x152	690 to 1051	-164 to +12
120"	244x183	831 to 1264	-197 to +14
150"	305x229	1041 to 1583	-246 to +17

16:9 Screen Size		①	②
		Minimum (Wide) to Maximum (Tele)	Vertical lens shift Bottom to Top
46"	102x57	339 to 520	-73 to +15
50"	111x62	370 to 567	-79 to +17
60"	133x75	446 to 682	-95 to +20
80"	177x100	600 to 914	-126 to +27
100"	221x125	753 to 1146	-158 to +33
120"	266x149	906 to 1378	-189 to +40
150"	332x187	1136 to 1726	-237 to +50
200"	443x249	1519 to 2305	-316 to +67
250"	553x311	1902 to 2885	-395 to +83
300"	664x374	2285 to 3465	-474 to +100
500"	1107x623	3816 to 5783	-789 to +167
800"	1771x996	6114 to 9261	-1263 to +267

Unit: cm

16:10 Screen Size		①	②
		Minimum (Wide) to Maximum (Tele)	Vertical lens shift Bottom to Top
48"	103x65	345 to 528	-77 to +12
50"	108x67	360 to 551	-80 to +13
60"	130x81	434 to 664	-96 to +15
80"	172x108	583 to 889	-128 to +21
100"	215x135	732 to 1115	-160 to +26
120"	258x162	881 to 1340	-192 to +31
150"	323x202	1105 to 1679	-241 to +39
200"	431x269	1477 to 2243	-321 to +51
250"	538x337	1850 to 2807	-401 to +64
300"	646x404	2222 to 3370	-481 to +77
500"	1077x673	3713 to 5626	-802 to +129
800"	1723x1077	5948 to 9010	-1283 to +206

4:3 Screen Size		①	②
		Minimum (Wide) to Maximum (Tele)	Vertical lens shift Bottom to Top
200"	406x305	2038 to 3089	-328 to +23
250"	508x381	2554 to 3867	-410 to +29
300"	610x457	3069 to 4645	-492 to +35
500"	1016x762	5131 to 7757	-820 to +58
800"	1626x1219	8224 to 12425	-1312 to +93
1000"	2032x1524	10286 to 15537	-1640 to +116

Unit: cm

ELPLM11/ELPLM07

Unit: cm

4:3 Screen Size		①	②
		Minimum (Wide) to Maximum (Tele)	Vertical lens shift Bottom to Top
50"	102x76	492 to 755	-82 to +6
60"	122x91	595 to 910	-98 to +7
80"	163x122	801 to 1221	-131 to +9
100"	203x152	1007 to 1533	-164 to +12
120"	244x183	1213 to 1844	-197 to +14
150"	305x229	1523 to 2311	-246 to +17

16:9 Screen Size		①	②
		Minimum (Wide) to Maximum (Tele)	Vertical lens shift Bottom to Top
46"	102x57	493 to 756	-73 to +15
50"	111x62	538 to 824	-79 to +17
60"	133x75	650 to 994	-95 to +20
80"	177x100	875 to 1333	-126 to +27
100"	221x125	1100 to 1672	-158 to +33
120"	266x149	1324 to 2011	-189 to +40
150"	332x187	1661 to 2519	-237 to +50
200"	443x249	2223 to 3367	-316 to +67
250"	553x311	2784 to 4215	-395 to +83
300"	664x374	3346 to 5062	-474 to +100
500"	1107x623	5592 to 8453	-789 to +167
800"	1771x996	8962 to 13538	-1263 to +267



Unit: cm

16:10 Screen Size		①	②
		Minimum (Wide) to Maximum (Tele)	Vertical lens shift Bottom to Top
48"	103x65	501 to 768	-77 to +12
50"	108x67	523 to 801	-80 to +13
60"	130x81	632 to 966	-96 to +15
80"	172x108	851 to 1296	-128 to +21
100"	215x135	1069 to 1626	-160 to +26
120"	258x162	1288 to 1956	-192 to +31
150"	323x202	1616 to 2451	-241 to +39
200"	431x269	2162 to 3275	-321 to +51
250"	538x337	2708 to 4100	-401 to +64
300"	646x404	3255 to 4925	-481 to +77
500"	1077x673	5441 to 8223	-802 to +129
800"	1723x1077	8719 to 13171	-1283 to +206

4:3 Screen Size		①	②
		Minimum (Wide) to Maximum (Tele)	Vertical lens shift Bottom to Top
200"	406x305	3025 to 4232	-328 to +23
250"	508x381	3790 to 5298	-410 to +29
300"	610x457	4554 to 6364	-492 to +35
500"	1016x762	7611 to 10627	-820 to +58
800"	1626x1219	12197 to 17023	-1312 to +93
1000"	2032x1524	15255 to 21287	-1640 to +116

Unit: cm

ELPLL08/ELPLL07

Unit: cm

4:3 Screen Size		①	②
		Minimum (Wide) to Maximum (Tele)	Vertical lens shift Bottom to Top
50"	102x76	732 to 1034	-82 to +6
60"	122x91	885 to 1247	-98 to +7
80"	163x122	1191 to 1674	-131 to +9
100"	203x152	1497 to 2100	-164 to +12
120"	244x183	1802 to 2527	-197 to +14
150"	305x229	2261 to 3166	-246 to +17

16:9 Screen Size		①	②
		Minimum (Wide) to Maximum (Tele)	Vertical lens shift Bottom to Top
46"	102x57	734 to 1037	-73 to +15
50"	111x62	801 to 1130	-79 to +17
60"	133x75	967 to 1362	-95 to +20
80"	177x100	1300 to 1826	-126 to +27
100"	221x125	1633 to 2291	-158 to +33
120"	266x149	1967 to 2755	-189 to +40
150"	332x187	2466 to 3452	-237 to +50
200"	443x249	3299 to 4613	-316 to +67
250"	553x311	4132 to 5775	-395 to +83
300"	664x374	4964 to 6939	-474 to +100
500"	1107x623	8295 to 11581	-789 to +167
800"	1771x996	13292 to 18549	-1263 to +267



Unit: cm

16:10 Screen Size		①	②
		Minimum (Wide) to Maximum (Tele)	Vertical lens shift Bottom to Top
48"	103x65	746 to 1053	-77 to +12
50"	108x67	778 to 1098	-80 to +13
60"	130x81	940 to 1324	-96 to +15
80"	172x108	1264 to 1776	-128 to +21
100"	215x135	1588 to 2228	-160 to +26
120"	258x162	1913 to 2680	-192 to +31
150"	323x202	2399 to 3358	-241 to +39
200"	431x269	3209 to 4488	-321 to +51
250"	538x337	4019 to 5618	-401 to +64
300"	646x404	4829 to 6748	-481 to +77
500"	1077x673	8070 to 11267	-802 to +129
800"	1723x1077	12931 to 18046	-1283 to +206

ELPLR04

Zoom and lens shift are not supported.

Unit: cm

4:3 Screen Size		①	②
50"	102x76	96	-38
60"	122x91	116	-46
80"	163x122	157	-61
100"	203x152	198	-76
120"	244x183	239	-91
150"	305x229	300	-114

4:3 Screen Size		①	②
200"	406x305	402	-152
250"	508x381	504	-191
300"	610x457	606	-229
500"	1016x762	1015	-381
800"	1626x1219	1627	-610
1000"	2032x1524	2035	-762

Unit: cm

16:9 Screen Size		①	②
46"	102x57	96	-29
50"	111x62	105	-31
60"	133x75	127	-37
80"	177x100	172	-50
100"	221x125	216	-62
120"	266x149	261	-75
150"	332x187	327	-93
200"	443x249	439	-125
250"	553x311	550	-156
300"	664x374	661	-187
500"	1107x623	1106	-311
800"	1771x996	1773	-498

Unit: cm

16:10 Screen Size		①	②
48"	103x65	98	-32
50"	108x67	102	-34
60"	130x81	124	-40

16:10 Screen Size		①	②
80"	172x108	167	-54
100"	215x135	210	-67
120"	258x162	254	-81
150"	323x202	318	-101
200"	431x269	427	-135
250"	538x337	535	-168
300"	646x404	643	-202
500"	1077x673	1076	-337
800"	1723x1077	1725	-538

EB-L1075U/EB-L1070U/EB-L1065U/EB-L1060U/EB-L1050U

Units: mm

Lens type	①	
	②	③
ELPLM08	140	170
ELPLW06/ELPLW04	120	170
ELPLW08	100	130
ELPLM15/ELPLM09/ ELPLS04	180	240
ELPLM10/ELPLM06	260	340

Polarizer (ELPPL01) Installation Distance

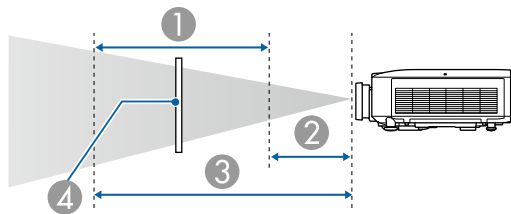

- ① Possible installation range of the polarizer
- ② Shortest distance from the projection lens to the polarizer
- ③ Longest distance from the projection lens to the polarizer
- ④ Polarizer (ELPPL01)

EB-L1070W/EB-L1060W

Units: mm

Lens type	①	
	②	③
ELPLM08	150	170
ELPLW06/ELPLW04	120	170
ELPLW08	100	130
ELPLM15/ELPLM09/ ELPLS04	200	240
ELPLM10/ELPLM06	300	340

EB-L1070

Units: mm

Lens type	①	
	②	③
ELPLM08	130	170
ELPLW06/ELPLW04	120	170



Lens type	①	
	②	③
ELPLW08	100	130
ELPLM15/ELPLM09/ ELPLS04	170	240
ELPLM10/ELPLM06	230	340

H/V-Keystone

☛ "H/V-Keystone" p.65

Lens type	Vertical	Horizontal
ELPLM08	-45° to 45°	-30° to 30°
ELPLX01/ELPLX01W	-16° to 16°	-16° to 16°
ELPLU03	-28° to 28°	-28° to 28°
ELPLU04/ELPLU02	-35° to 35°	-30° to 30°
ELPLR04	-34° to 34°	-30° to 30°
ELPLW05	-40° to 40°	-30° to 30°
ELPLW06/ELPLW04	-45° to 45°	-30° to 30°
ELPLW08	-40° to 40°	-30° to 30°
ELPLM15/ELPLM09/ ELPLS04	-45° to 45°	-30° to 30°
ELPLM10/ELPLM06	-45° to 45°	-30° to 30°
ELPLM11/ELPLM07	-45° to 45°	-30° to 30°
ELPLL08/ELPLL07	-45° to 45°	-30° to 30°

Curved Surface

☛ "Curved Surface" p.67

The values in the table are the minimum values for R/L in the illustration. (Approximate value when projecting at maximum zoom. ELPLR04 does not support lens shift.)

EB-L1075U/EB-L1070U/EB-L1065U/EB-L1060U/EB-L1050U/EB-L1070W/
EB-L1060W

Horizontally curved surface (concave)

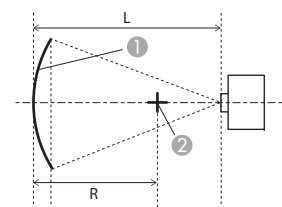

- ① Screen
- ② Center of the circle of which the curved surface is an arc
- L Projection distance
- R Radius of the circle of which the curved surface is an arc

Top view

Lens type	Vertical lens shift: Home position	Vertical lens shift: Top
	Side view	Side view
ELPLM08	0.29	0.30
ELPLX01/ELPLX01W	-	2.74
ELPLU03	0.45	0.56
ELPLU04/ELPLU02	0.39	0.40
ELPLR04	0.37	-
ELPLW05	0.35	0.37
ELPLW06/ELPLW04	0.26	0.27
ELPLW08	0.33	0.34
ELPLM15/ELPLM09/ ELPLS04	0.21	0.22
ELPLM10/ELPLM06	0.15	0.15

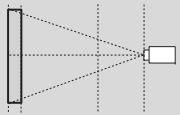
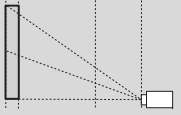
Lens type	Vertical lens shift: Home position	Vertical lens shift: Top
	 Side view	 Side view
ELPLM11/ELPLM07	0.11	0.11
ELPLL08/ELPLL07	0.08	0.08

Horizontally curved surface (convex)

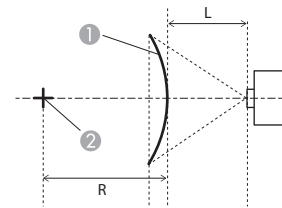

- ① Screen
- ② Center of the circle of which the curved surface is an arc
- L Projection distance
- R Radius of the circle of which the curved surface is an arc

Top view

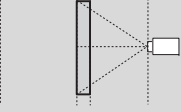
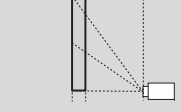
Lens type	Vertical lens shift: Home position	Vertical lens shift: Top
	 Side view	 Side view
ELPLM08	0.58	0.62
ELPLX01/ELPLX01W	-	3.52
ELPLU03	2.13	2.31
ELPLU04/ELPLU02	1.27	1.37
ELPLR04	1.10	-
ELPLW05	0.95	1.01
ELPLW06/ELPLW04	0.49	0.52
ELPLW08	0.79	0.84
ELPLM15/ELPLM09/ ELPLS04	0.33	0.35
ELPLM10/ELPLM06	0.20	0.20
ELPLM11/ELPLM07	0.13	0.13
ELPLL08/ELPLL07	0.09	0.09

Vertically curved surface (concave)

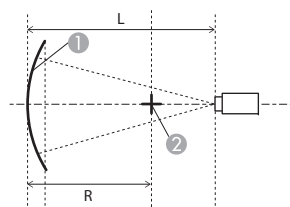

- ① Screen
 - ② Center of the circle of which the curved surface is an arc
- L Projection distance
 R Radius of the circle of which the curved surface is an arc

Side view

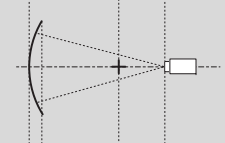
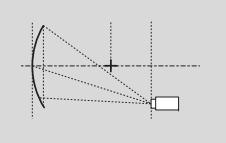
Lens type	Vertical lens shift: Home position	Vertical lens shift: Top
		
	Side view	Side view
ELPLL08/ELPLL07	0.06	0.06

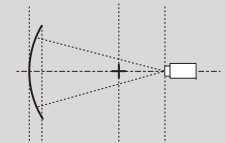
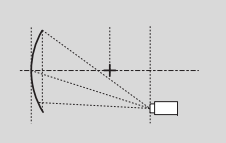
Lens type	Vertical lens shift: Home position	Vertical lens shift: Top
		
	Side view	Side view
ELPLM08	0.21	0.25
ELPLX01/ELPLX01W	-	1.98
ELPLU03	0.37	0.67
ELPLU04/ELPLU02	0.31	0.43
ELPLR04	0.29	-
ELPLW05	0.27	0.35
ELPLW06/ELPLW04	0.19	0.22
ELPLW08	0.25	0.31
ELPLM15/ELPLM09/ ELPLS04	0.15	0.17
ELPLM10/ELPLM06	0.11	0.11
ELPLM11/ELPLM07	0.08	0.08

Vertically curved surface (convex)

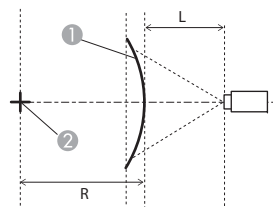

- ① Screen
- ② Center of the circle of which the curved surface is an arc
- L Projection distance
- R Radius of the circle of which the curved surface is an arc

Side view

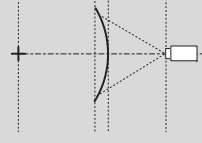
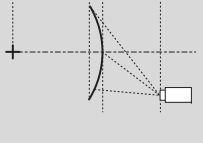
Lens type	Vertical lens shift: Home position	Vertical lens shift: Top
	 <p>Side view</p>	 <p>Side view</p>
ELPLL08/ELPLL07	0.06	0.06

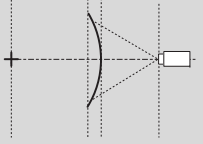
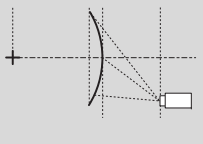
Lens type	Vertical lens shift: Home position	Vertical lens shift: Top
	 <p>Side view</p>	 <p>Side view</p>
ELPLM08	0.31	0.37
ELPLX01/ELPLX01W	-	3.52
ELPLU03	1.07	1.29
ELPLU04/ELPLU02	0.65	0.79
ELPLR04	0.57	-
ELPLW05	0.49	0.59
ELPLW06/ELPLW04	0.26	0.32
ELPLW08	0.42	0.50
ELPLM15/ELPLM09/ ELPLS04	0.18	0.22
ELPLM10/ELPLM06	0.12	0.13
ELPLM11/ELPLM07	0.08	0.09

EB-L1070

Horizontally curved surface (concave)

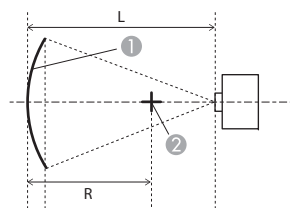

- ① Screen
- ② Center of the circle of which the curved surface is an arc
- L Projection distance
- R Radius of the circle of which the curved surface is an arc

Top view

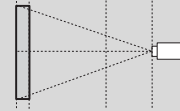
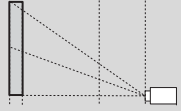
Lens type	Vertical lens shift: Home position  Side view	Vertical lens shift: Top  Side view
ELPLM08	0.27	0.27
ELPLX01/ELPLX01W	-	1.66
ELPLU03	0.44	0.60
ELPLU04/ELPLU02	0.37	0.40
ELPLR04	0.35	-
ELPLW05	0.33	0.34
ELPLW06/ELPLW04	0.25	0.25
ELPLW08	0.31	0.32
ELPLM15/ELPLM09/ ELPLS04	0.20	0.20
ELPLM10/ELPLM06	0.14	0.14
ELPLM11/ELPLM07	0.11	0.11

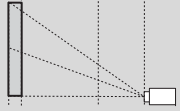
Lens type	Vertical lens shift: Home position  Side view	Vertical lens shift: Top  Side view
ELPLL08/ELPLL07	0.08	0.08

Horizontally curved surface (convex)

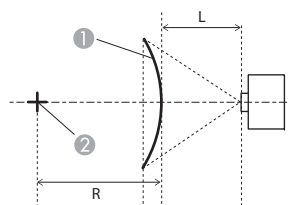

- ① Screen
- ② Center of the circle of which the curved surface is an arc
- L Projection distance
- R Radius of the circle of which the curved surface is an arc

Top view

Vertically curved surface (concave)

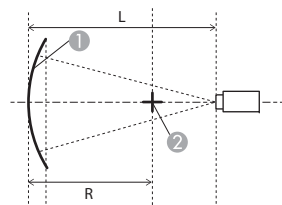

- ① Screen
- ② Center of the circle of which the curved surface is an arc
- L Projection distance
- R Radius of the circle of which the curved surface is an arc

Side view

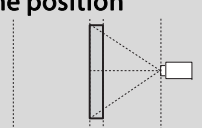
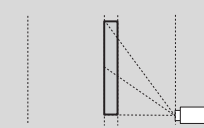
Lens type	Vertical lens shift: Home position	Vertical lens shift: Top
	 Side view	 Side view
ELPLM08	0.52	0.54
ELPLX01/ELPLX01W	-	3.52
ELPLU03	1.81	1.88
ELPLU04/ELPLU02	1.10	1.14
ELPLR04	0.95	-
ELPLW05	0.83	0.86
ELPLW06/ELPLW04	0.44	0.45
ELPLW08	0.70	0.72
ELPLM15/ELPLM09/ ELPLS04	0.31	0.31
ELPLM10/ELPLM06	0.19	0.19
ELPLM11/ELPLM07	0.13	0.13
ELPLL08/ELPLL07	0.09	0.09

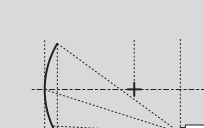
Lens type	Vertical lens shift: Home position	Vertical lens shift: Top
	 Side view	 Side view
ELPLM08	0.22	0.28
ELPLX01/ELPLX01W	-	1.73
ELPLU03	0.37	0.65
ELPLU04/ELPLU02	0.32	0.46
ELPLR04	-	0.30
ELPLW05	0.28	0.38
ELPLW06/ELPLW04	0.20	0.25
ELPLW08	0.26	0.34
ELPLM15/ELPLM09/ ELPLS04	0.16	0.19
ELPLM10/ELPLM06	0.11	0.13
ELPLM11/ELPLM07	0.08	0.09

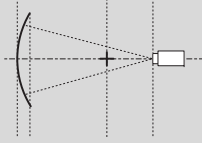
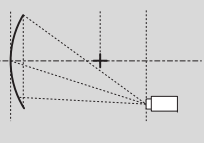
Lens type	Vertical lens shift: Home position	Vertical lens shift: Top
	 Side view	 Side view
ELPLL08/ELPLL07	0.06	0.07

Vertically curved surface (convex)

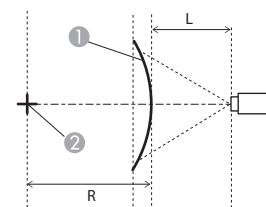

- ① Screen
- ② Center of the circle of which the curved surface is an arc
- L Projection distance
- R Radius of the circle of which the curved surface is an arc

Side view

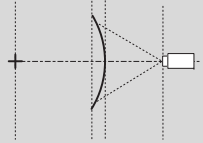
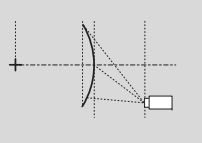
Lens type	Vertical lens shift: Home position	Vertical lens shift: Top
	 Side view	 Side view
ELPLM08	0.34	0.44
ELPLX01/ELPLX01W	-	3.52
ELPLU03	1.08	1.57
ELPLU04/ELPLU02	0.66	0.94
ELPLR04	0.57	-
ELPLW05	0.50	0.71
ELPLW06/ELPLW04	0.29	0.37
ELPLW08	0.43	0.59
ELPLM15/ELPLM09/ ELPLS04	0.21	0.26
ELPLM10/ELPLM06	0.14	0.15
ELPLM11/ELPLM07	0.10	0.10

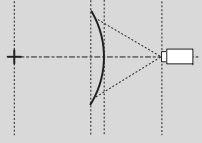
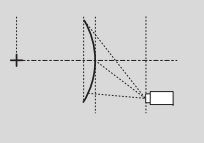
Lens type	Vertical lens shift: Home position	Vertical lens shift: Top
	 Side view	 Side view
ELPLL08/ELPLL07	0.07	0.07

EB-L1075U/EB-L1070U/EB-L1065U/EB-L1060U/EB-L1050U/EB-L1070W/EB-L1060W

Concave horizontal corner correction (correction to bilateral symmetry by using corners as the center line)

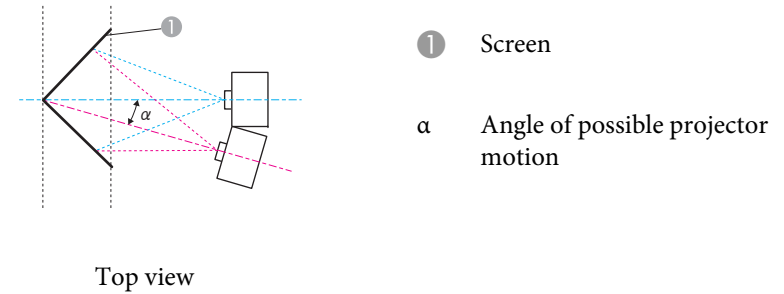

Corner Wall

☛ "Corner Wall" [p.71](#)

The α in the figure is the maximum angle in which the projector can move. See the table below for detailed values. (Approximate value when projecting at maximum zoom. ELPLR04 does not support lens shift.)

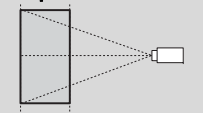
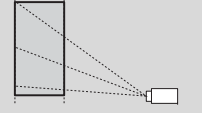
Lens type	Vertical lens shift: Home position	Vertical lens shift: Top
	 Side view	 Side view
ELPLM08	31°	23°
ELPLX01/ELPLX01W	-	-
ELPLU03	29°	9°
ELPLU04/ELPLU02	31°	14°
ELPLR04	32°	-
ELPLW05	33°	18°
ELPLW06/ELPLW04	31°	25°
ELPLW08	32°	20°
ELPLM15/ELPLM09/ ELPLS04	30°	29°
ELPLM10/ELPLM06	29°	29°

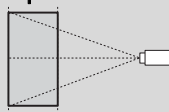
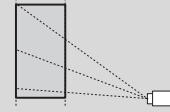
Lens type	Vertical lens shift: Home position	Vertical lens shift: Top
		
	Side view	Side view
ELPLM11/ELPLM07	29°	28°
ELPLL08/ELPLL07	28°	28°

Convex horizontal corner correction (correction to bilateral symmetry by using corners as the center line)

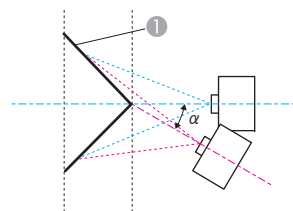

Top view

- ① Screen
- α Angle of possible projector motion

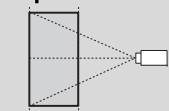
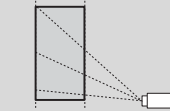
Lens type	Vertical lens shift: Home position	Vertical lens shift: Top
		
	Side view	Side view
ELPLM08	14°	13°
ELPLX01/ELPLX01W	-	-
ELPLU03	0°	*
ELPLU04/ELPLU02	6°	4°

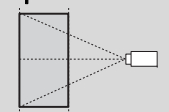
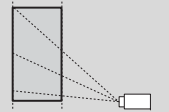
Lens type	Vertical lens shift: Home position	Vertical lens shift: Top
		
	Side view	Side view
ELPLR04	8°	-
ELPLW05	9°	8°
ELPLW06/ELPLW04	16°	15°
ELPLW08	11°	10°
ELPLM15/ELPLM09/ ELPLS04	18°	18°
ELPLM10/ELPLM06	22°	21°
ELPLM11/ELPLM07	23°	23°
ELPLL08/ELPLL07	24°	24°

*Cannot be corrected accurately. Move the lens position to the home position.

Concave vertical corner correction (correction to horizontal symmetry by using corners as the center line)

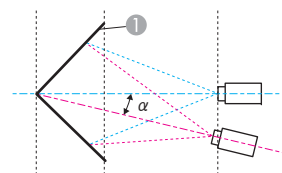

Side view

- ① Screen
- α Angle of possible projector motion

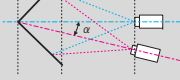
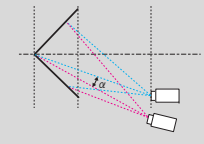
Lens type	Vertical lens shift: Home position	Vertical lens shift: Top
		
	Side view	Side view
ELPLM08	30°	12°
ELPLX01/ELPLX01W	-	-
ELPLU03	33°	*
ELPLU04/ELPLU02	31°	6°
ELPLR04	31°	-
ELPLW05	31°	10°
ELPLW06/ELPLW04	28°	13°
ELPLW08	31°	11°
ELPLM15/ELPLM09/ ELPLS04	26°	14°
ELPLM10/ELPLM06	24°	16°
ELPLM11/ELPLM07	23°	18°
ELPLL08/ELPLL07	23°	19°

*Cannot be corrected accurately. Move the lens position to the home position.

Convex vertical corner correction (correction to horizontal symmetry by using corners as the center line)

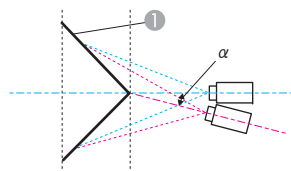

① Screen

α Angle of possible projector motion

Side view

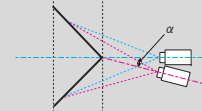
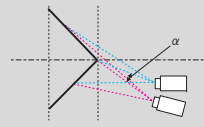
Lens type	Vertical lens shift: Home position	Vertical lens shift: Top
		
	Side view	Side view
ELPLM08	19°	5°
ELPLX01/ELPLX01W	-	-
ELPLU03	9°	*
ELPLU04/ELPLU02	14°	*
ELPLR04	15°	-
ELPLW05	16°	*
ELPLW06/ELPLW04	20°	7°
ELPLW08	17°	1°
ELPLM15/ELPLM09/ ELPLS04	22°	12°
ELPLM10/ELPLM06	22°	15°
ELPLM11/ELPLM07	22°	17°
ELPLL08/ELPLL07	22°	18°

*Cannot be corrected accurately. Move the lens position to the home position.

EB-L1070

Concave horizontal corner correction (correction to bilateral symmetry by using corners as the center line)

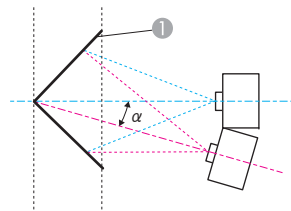

Top view

- ① Screen
- α Angle of possible projector motion

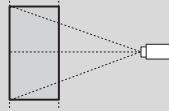
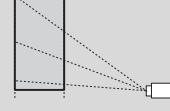
Lens type	Vertical lens shift: Home position  Side view	Vertical lens shift: Top  Side view
ELPLM08	31°	21°
ELPLX01/ELPLX01W	-	-
ELPLU03	26°	7°
ELPLU04/ELPLU02	29°	13°
ELPLR04	30°	-
ELPLW05	31°	16°
ELPLW06/ELPLW04	31°	23°
ELPLW08	32°	18°
ELPLM15/ELPLM09/ ELPLS04	30°	27°
ELPLM10/ELPLM06	29°	29°
ELPLM11/ELPLM07	29°	29°

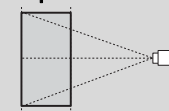
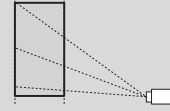
Lens type	Vertical lens shift: Home position  Side view	Vertical lens shift: Top  Side view
ELPLL08/ELPLL07	28°	28°

Convex horizontal corner correction (correction to bilateral symmetry by using corners as the center line)

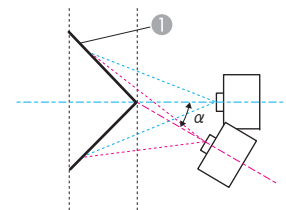

Top view

- ① Screen
- α Angle of possible projector motion

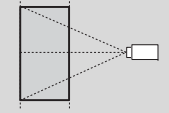
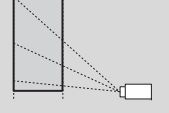
Lens type	Vertical lens shift: Home position  Side view	Vertical lens shift: Top  Side view
ELPLM08	14°	14°
ELPLX01/ELPLX01W	-	-
ELPLU03	0°	*
ELPLU04/ELPLU02	6°	2°
ELPLR04	8°	-

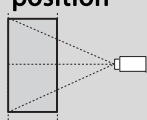
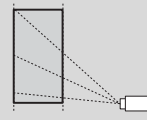
Lens type	Vertical lens shift: Home position  Side view	Vertical lens shift: Top  Side view
ELPLW05	10°	7°
ELPLW06/ELPLW04	16°	16°
ELPLW08	12°	10°
ELPLM15/ELPLM09/ ELPLS04	19°	18°
ELPLM10/ELPLM06	22°	21°
ELPLM11/ELPLM07	23°	23°
ELPLL08/ELPLL07	24°	24°

*Cannot be corrected accurately. Move the lens position to the home position.

Concave vertical corner correction (correction to horizontal symmetry by using corners as the center line)

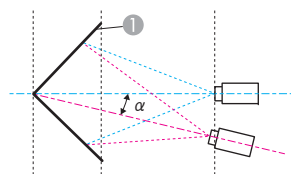

Side view

① Screen

α Angle of possible projector motion

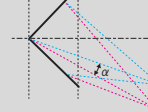
Lens type	Vertical lens shift: Home position  Side view	Vertical lens shift: Top  Side view
ELPLM08	31°	14°
ELPLX01/ELPLX01W	-	-
ELPLU03	33°	*
ELPLU04/ELPLU02	32°	7°
ELPLR04	32°	-
ELPLW05	31°	10°
ELPLW06/ELPLW04	30°	16°
ELPLW08	31°	12°
ELPLM15/ELPLM09/ ELPLS04	29°	17°
ELPLM10/ELPLM06	27°	19°
ELPLM11/ELPLM07	26°	21°
ELPLL08/ELPLL07	26°	22°

*Cannot be corrected accurately. Move the lens position to the home position.

Convex vertical corner correction (correction to horizontal symmetry by using corners as the center line)

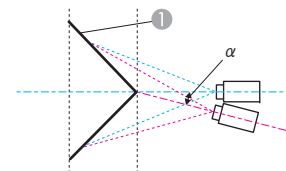

① Screen

α Angle of possible projector motion

Side view

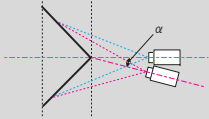
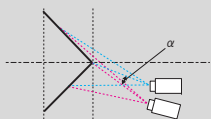
Lens type	Vertical lens shift: Home position  Side view	Vertical lens shift: Top  Side view
ELPLM08	18°	4°
ELPLX01/ELPLX01W	-	-
ELPLU03	6°	*
ELPLU04/ELPLU02	12°	*
ELPLR04	13°	-
ELPLW05	14°	*
ELPLW06/ELPLW04	19°	6°
ELPLW08	16°	0°
ELPLM15/ELPLM09/ ELPLS04	21°	11°
ELPLM10/ELPLM06	23°	16°
ELPLM11/ELPLM07	24°	19°
ELPLL08/ELPLL07	25°	21°

*Cannot be corrected accurately. Move the lens position to the home position.

Supported Monitor Displays

When the resolution of the input signals is larger than the projector's panel resolution, the image quality may decline.

Signals with a check mark are supported.

PC

Signal Format	Resolution (Dot)		V Sync (Hz)	Computer/BNC		HDMI/HDBaseT									DVI-D							
				RGB	YCbCr	RGB			YCbCr						RGB	YCbCr						
						8	10	12	4:4:4			4:2:2				4:2:0			8	4:4:4	4:2:2	
									8	10	12	8	10	12		8	10	12				
VGA	640	480	60	✓		✓												✓				
			72	✓																		
			75	✓																		
			85	✓																		
SVGA	800	600	60	✓		✓												✓				
			72	✓																		
			75	✓																		
			85	✓																		
XGA	1024	768	60	✓		✓												✓				
			70	✓																		
			75	✓																		
			85	✓																		
WXGA	1280	768	60	✓																		
			800	60	✓		✓												✓			
				75	✓																	
	1366	768	60	✓		✓												✓				

Signal Format	Resolution (Dot)		V Sync (Hz)	Computer/BNC		HDMI/HDBaseT											DVI-D					
						RGB	YCbCr	RGB			YCbCr						RGB	YCbCr				
											4:4:4			4:2:2				4:2:0			4:4:4	4:2:2
								8	10	12	8	10	12	8	10	12		8	10	12	8	8
HDTV (1080i)	1920	1080	59.94	✓	✓	✓	✓	✓	✓	✓	✓	✓	✓	✓	✓	✓	✓	✓	✓	✓		
			60	✓	✓	✓	✓	✓	✓	✓	✓	✓	✓	✓	✓	✓	✓	✓	✓	✓	✓	
			50		✓	✓	✓	✓	✓	✓	✓	✓	✓	✓	✓	✓	✓	✓	✓	✓	✓	✓
			59.94		✓	✓	✓	✓	✓	✓	✓	✓	✓	✓	✓	✓	✓	✓	✓	✓	✓	✓
			60		✓	✓	✓	✓	✓	✓	✓	✓	✓	✓	✓	✓	✓	✓	✓	✓	✓	✓
HDTV (1080p)	1920	1080	23.98			✓	✓	✓	✓	✓	✓	✓	✓	✓	✓	✓	✓	✓	✓	✓		
			24			✓	✓	✓	✓	✓	✓	✓	✓	✓	✓	✓	✓	✓	✓	✓	✓	
			25																			
			29.97			✓	✓	✓	✓	✓	✓	✓	✓	✓	✓	✓	✓	✓	✓	✓	✓	
			30			✓	✓	✓	✓	✓	✓	✓	✓	✓	✓	✓	✓	✓	✓	✓	✓	
			50	✓		✓	✓	✓	✓	✓	✓	✓	✓	✓	✓	✓	✓	✓	✓	✓	✓	
			59.94	✓		✓	✓	✓	✓	✓	✓	✓	✓	✓	✓	✓	✓	✓	✓	✓	✓	
			60	✓		✓	✓	✓	✓	✓	✓	✓	✓	✓	✓	✓	✓	✓	✓	✓	✓	

4K (EB-L1075U/EB-L1070U/EB-L1065U/EB-L1060U/EB-L1050U only)

Signal Format	Resolution (Dot)		V Sync (Hz)	Computer/BNC		HDMI/HDBaseT											DVI-D			
						RGB	YCbCr	RGB			YCbCr						RGB	YCbCr		
											4:4:4			4:2:2				4:2:0		
								8	10	12	8	10	12	8	10	12		8	10	12
3840x2160	3840	2160	23.98			✓			✓			✓	✓	✓						
			24			✓			✓			✓	✓	✓						
			25			✓			✓			✓	✓	✓						
			29.97			✓			✓			✓	✓	✓						

Projector General Specifications

Product name	EB-L1075U EB-L1070U	EB-L1065U EB-L1060U	EB-L1050U	EB-L1070W	EB-L1060W	EB-L1070
Dimensions	545 (W) x 164 (H) x 436 (D) mm (not including raised section)					
LCD panel size	0.76" Wide					0.79"
Display method	Polysilicon TFT active matrix					
Resolution	2,304,000 WUXGA (1920 (W) x 1200 (H) dots) x 3			1,024,000 WXGA (1280 (W) x 800 (H) dots) x 3		786,432 XGA (1024 (W) x 768 (H) dots) x 3
Focus adjustment	Automatic					
Zoom adjustment*1	Automatic (1-1.6)					
Lens shift*2	Automatic (Maximum vertical direction of approx. 67%, Maximum horizontal direction of approx. 30%)*3					Automatic (Maximum vertical direction of approx. 57%, Maximum horizontal direction of approx. 30%)*4
Light source	Laser diode					
Light source output power	125W	104.5W	104.5W	125W	104.5W	125W
Wavelength	449 - 461 nm					
Light source life expectancy*5	Approximately 20,000 hours (Light Source Mode: Normal, Medium, Quiet) Approximately 30,000 hours (Light Source Mode: Extended)					
Power supply	100-240V AC±10% 50/60Hz 4.4-2.0A	100-240V AC±10% 50/60Hz 3.7-1.7A	100-240V AC±10% 50/60Hz 3.7-1.7A	100-240V AC±10% 50/60Hz 4.4-2.0A	100-240V AC±10% 50/60Hz 3.7-1.7A	100-240V AC±10% 50/60Hz 4.4-2.0A

Power consumption	100 to 120 V area	Rated power consumption: 439 W Standby power consumption (Communication On): 2.0 W Standby power consumption (Communication Off): 0.5 W	Rated power consumption: 361 W Standby power consumption (Communication On): 2.0 W Standby power consumption (Communication Off): 0.5 W	Rated power consumption: 361 W Standby power consumption (Communication On): 2.0 W Standby power consumption (Communication Off): 0.5 W	Rated power consumption: 439 W Standby power consumption (Communication On): 2.0 W Standby power consumption (Communication Off): 0.5 W	Rated power consumption: 361 W Standby power consumption (Communication On): 2.0 W Standby power consumption (Communication Off): 0.5 W	Rated power consumption: 439 W Standby power consumption (Communication On): 2.0 W Standby power consumption (Communication Off): 0.5 W
	220 to 240 V area	Rated power consumption: 416 W Standby power consumption (Communication On): 2.0 W Standby power consumption (Communication Off): 0.5 W	Rated power consumption: 345 W Standby power consumption (Communication On): 2.0 W Standby power consumption (Communication Off): 0.5 W	Rated power consumption: 345 W Standby power consumption (Communication On): 2.0 W Standby power consumption (Communication Off): 0.5 W	Rated power consumption: 416 W Standby power consumption (Communication On): 2.0 W Standby power consumption (Communication Off): 0.5 W	Rated power consumption: 345 W Standby power consumption (Communication On): 2.0 W Standby power consumption (Communication Off): 0.5 W	Rated power consumption: 416 W Standby power consumption (Communication On): 2.0 W Standby power consumption (Communication Off): 0.5 W
Operating altitude	Altitude 0 to 3,048 m						
Operating temperature range	0 to +45°C*6 (Altitude of 0 to 2,286 m, no condensation) 0 to +40°C*6 (Altitude of 2,287 to 3,048 m, no condensation)						
Storage temperature	-10 to +60°C (No condensation)						
Mass*1	Approx. 16.9kg						

*1 The specifications are when ELPLM08 is attached.

*2 ELPLR04 does not support lens shift.

*3 ELPLX01/ELPLX01W has a maximum vertical direction of approx. 17% and a maximum horizontal direction of approx. 10%.

*4 ELPLX01/ELPLX01W has a maximum vertical direction of approx. 7% and a maximum horizontal direction of approx. 8%.

*5 Approximate time until light source brightness is reduced by half.

(Assuming the projector is being used in an environment containing airborne particles of 0.04 to 0.2 mg/m³. This is an approximate guide only and may change depending on the projector's usage and surroundings.)

*6 If the surrounding temperature gets too high, the brightness is automatically dimmed.

(Approximately 40°C at an altitude of 0 to 2,286 m, and approximately 35°C at an altitude of 2,287 to 3,048 m; however, this may vary depending on the surroundings and so on.)

Product name			EB-L1075U EB-L1070U	EB-L1065U EB-L1060U	EB-L1050U	EB-L1070W	EB-L1060W	EB-L1070
Conne- ctors	Computer Port	1	Mini D-Sub15-pin (female) blue					
	Audio1 port	1	Stereo mini jack (3.5Φ)					
	BNC port	1	5BNC (female)					
	Audio2 port	1	Stereo mini jack (3.5Φ)					
	DVI-D port	1	DVI-D 24pin Single link HDCP compatible					
	HDMI port	1	HDMI HDCP2.2 supported (Audio is only supported by PCM)			HDMI HDCP supported (Audio is only supported by PCM)		
	Audio3 port	1	Stereo mini jack (3.5Φ)					
	Audio Out port	1	Stereo mini jack (3.5Φ)					
	Monitor Out port	1	Mini D-Sub15-pin (female) black					
	HDBaseT port	1	RJ-45 (HDCP2.2 supported)			RJ-45 (HDCP supported)		
	LAN port	1	RJ-45					
	Service port*	1	USB connector (Type B)					
	RS-232C port	1	Mini D-Sub 9-pin (male)					
	Remote port	1	Stereo mini jack (3.5Φ)					
USB port*	1	USB connector (Type A)						

* Supports USB 2.0. However, USB ports are not guaranteed to operate all devices that support USB.



This product is also designed for IT power distribution system with phase-to-phase voltage 230V.

Supplier's DECLARATION of CONFORMITY

According to 47CFR, Part 2 and 15
Class B Personal Computers and Peripherals; and/or
CPU Boards and Power Supplies used with Class B Personal Computers

We: Epson America, Inc.
Located at: 3840 Kilroy Airport Way
Long Beach, CA 90806
Tel: 562-981-3840

Declare under sole responsibility that the product identified herein, complies with 47CFR Part 2 and 15 of the FCC rules as a Class B digital device. Each product marketed, is identical to the representative unit tested and found to be compliant with the standards. Records maintained continue to reflect the equipment being produced can be expected to be within the variation accepted, due to quantity production and testing on a statistical basis as required by 47CFR 2.906. Operation is subject to the following two conditions : (1) this device may not cause harmful interference, and (2) this device must accept any interference received, including interference that may cause undesired operation.

Trade Name: EPSON
Type of Product: LCD Projector
Model: H940C/H941C/H957C
Options: Product Name: Remote Controller
Model: 2173310 xx (x=0-9)

**FCC Compliance Statement
For United States Users**

This device complies with part 15 of the FCC Rules. Operation is subject to the following two conditions: (1) This device may not cause harmful interference, and (2) this device must accept any interference received, including interference that may cause undesired operation.

This equipment has been tested and found to comply with the limits for a Class B digital device, pursuant to Part 15 of the FCC Rules. These limits are designed to provide reasonable protection against harmful interference in a residential installation. This equipment generates, uses, and can radiate radio frequency energy and, if not installed and used in accordance with the instructions, may cause harmful interference to radio communications. However, there is no guarantee that interference will not occur in a particular installation. If this equipment does cause interference to radio or television reception, which can be determined by turning the equipment off and on, the user is encouraged to try to correct the interference by one or more of the following measures.

- Reorient or relocate the receiving antenna.
- Increase the separation between the equipment and receiver.
- Connect the equipment into an outlet on a circuit different from that to which the receiver is connected.
- Consult the dealer or an experienced radio/TV technician for help.

WARNING

The connection of a non-shielded equipment interface cable to this equipment will invalidate the FCC Certification or Declaration of this device and may cause interference levels which exceed the limits established by the FCC for this equipment. It is the responsibility of the user to obtain and use a shielded equipment interface cable with this device. If this equipment has more than one interface connector, do not leave cables connected to unused interfaces. Changes or modifications not expressly approved by the manufacturer could void the user's authority to operate the equipment.

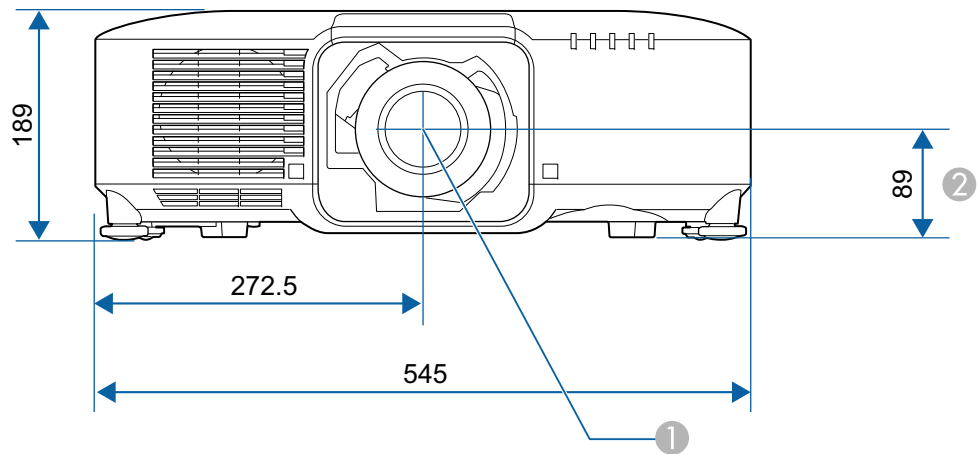

- ① Center of lens
- ② Distance from center of lens to suspension bracket fixing point

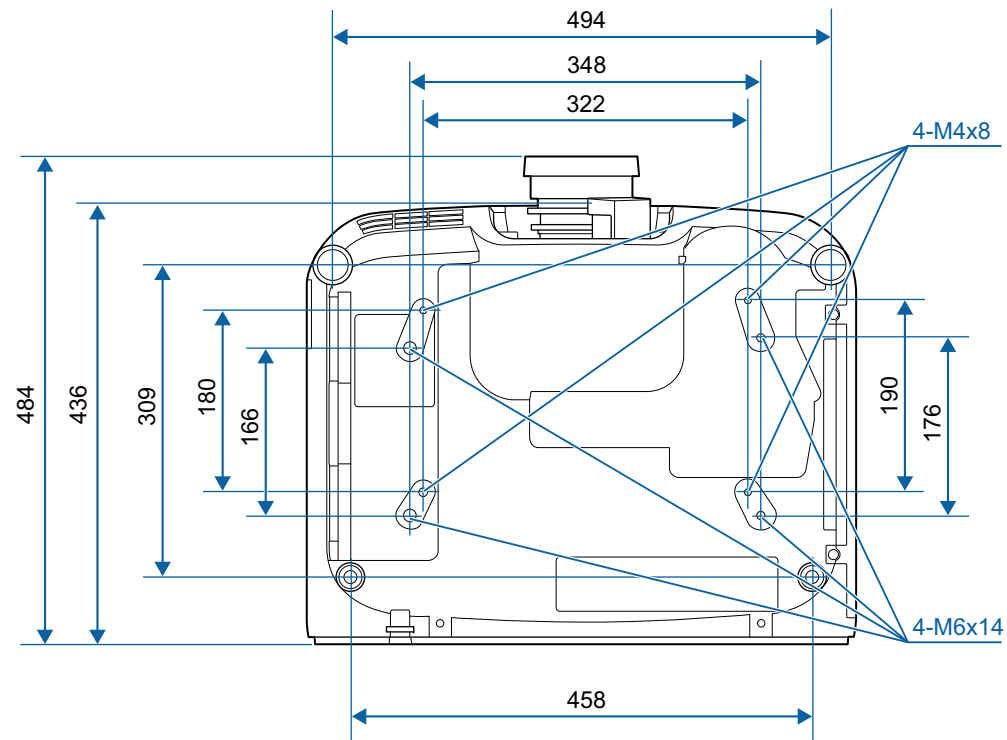

Units: mm

All rights reserved. No part of this publication may be reproduced, stored in a retrieval system, or transmitted in any form or by any means, electronic, mechanical, photocopying, recording, or otherwise, without the prior written permission of Seiko Epson Corporation. No patent liability is assumed with respect to the use of the information contained herein. Neither is any liability assumed for damages resulting from the use of the information contained herein.

Neither Seiko Epson Corporation nor its affiliates shall be liable to the purchaser of this product or third parties for damages, losses, costs, or expenses incurred by the purchaser or third parties as a result of: accident, misuse, or abuse of this product or unauthorized modifications, repairs, or alterations to this product, or (excluding the U.S.) failure to strictly comply with Seiko Epson Corporation's operating and maintenance instructions.

Seiko Epson Corporation shall not be liable against any damages or problems arising from the use of any options or any consumable products other than those designated as Original Epson Products or Epson Approved Products by Seiko Epson Corporation.

The contents of this guide may be changed or updated without further notice.

Illustrations in this guide and the actual projector may differ.

Restriction of Use

When this product is used for applications requiring high reliability/safety such as transportation devices related to aviation, rail, marine, automotive etc.; disaster prevention devices; various safety devices etc; or functional/precision devices etc, you should use this product only after giving consideration to including fail-safes and redundancies into your design to maintain safety and total system reliability. Because this product was not intended for use in applications requiring extremely high reliability/safety such as aerospace equipment, main communication equipment, nuclear power control equipment, or medical equipment related to direct medical care etc, please make your own judgment on this product's suitability after a full evaluation.

About Notations

Microsoft® Windows Vista® operating system
Microsoft® Windows® 7 operating system
Microsoft® Windows® 8 operating system
Microsoft® Windows® 8.1 operating system
Microsoft® Windows® 10 operating system

In this guide, the operating systems above are referred to as "Windows Vista", "Windows 7", "Windows 8", "Windows 8.1", and "Windows 10". Furthermore, these may be referred to as the collective term Windows, and multiple versions of Windows may be referred to as, for example, Windows Vista/7/8/8.1/10, with the Windows notation omitted.

OS X 10.7.x
OS X 10.8.x
OS X 10.9.x
OS X 10.10.x
OS X 10.11.x
macOS 10.12.x

In this guide, the operating systems above are referred to as "OS X 10.7.x", "OS X 10.8.x", "OS X 10.9.x", "OS X 10.10.x", "OS X 10.11.x", and "macOS 10.12.x". Furthermore, the collective term "Mac" is used to refer to them all.

Trademarks and Copyrights

"EPSON" is a registered trademark of Seiko Epson Corporation. "EXCEED YOUR VISION" is a trademark or registered trademark of Seiko Epson Corporation.

Mac, Mac OS, OS X, and iOS are trademarks of Apple Inc.

Microsoft, Windows, Windows Vista, Microsoft Edge, Windows Media, PowerPoint, and the Windows logo are trademarks or registered trademarks of Microsoft Corporation in the United States and/or other countries.

App Store is a service mark of Apple Inc.

Android, Chrome, Chromebook, and Google Play are trademarks of Google LLC.

HDMI, the HDMI Logo and High-Definition Multimedia Interface are trademarks or registered trademarks of HDMI Licensing Administrator, Inc. 

PJLink trademark is a trademark applied for registration or is already registered in Japan, the United States of America and other countries and areas.

WPA™ and WPA2™ are registered trademarks of the Wi-Fi Alliance.

"QR Code" is a registered trademark of DENSO WAVE INCORPORATED.

Crestron, Crestron Connected, Crestron RoomView, and Crestron Fusion are registered trademarks of Crestron Electronics, Inc.

Extron® and XTP® are registered trademarks of Extron Electronics.

HDBaseT™ and the HDBaseT Alliance logo are trademarks of the HDBaseT Alliance.

Other product names used herein are also for identification purposes only and may be trademarks of their respective owners. Epson disclaims any and all rights in those marks.

©SEIKO EPSON CORPORATION 2019. All rights reserved.

Indication of the manufacturer and the importer in accordance with requirements of directive 2011/65/EU (RoHS)

Manufacturer: SEIKO EPSON CORPORATION

Address: 3-5, Owa 3-chome, Suwa-shi, Nagano-ken 392-8502 Japan

Telephone: 81-266-52-3131

<https://epson.com/>

Importer: EPSON EUROPE B.V.









Address: Atlas Arena, Asia Building, Hoogoorddreef 5, 1101 BA Amsterdam









Zuidoost The Netherlands











Telephone: 31-20-314-5000

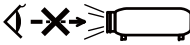

<https://www.epson.eu/>

The following table lists the meaning of the safety symbols labeled on the equipment.

No.	Symbol mark	Approved standards	Meaning
①		IEC60417 No. 5007	"ON" (power) To indicate connection to the mains.
②		IEC60417 No. 5008	"OFF" (power) To indicate disconnection from the mains.
③		IEC60417 No. 5009	Stand-by To identify the switch or switch position by means of which part of the equipment is switched on in order to bring it into the stand-by condition.
④		ISO7000 No.0434B IEC3864-B3.1	Caution To identify general caution when using the product.
⑤		IEC60417 No. 5041	Caution, hot surface To indicate that the marked item can be hot and should not be touched without taking care.
⑥		IEC60417 No.6042 ISO3864-B3.6	Caution, risk of electric shock To identify equipment that has risk of electric shock.
⑦		IEC60417 No. 5957	For indoor use only To identify electrical equipment designed primarily for indoor use.
⑧		IEC60417 No. 5926	Polarity of d.c. power connector To identify the positive and negative connections (the polarity) on a piece of equipment to which a d.c. power supply may be connected.
⑨		-	The same as No. 8

No.	Symbol mark	Approved standards	Meaning
⑩		IEC60417 No. 5001B	Battery, general On battery powered equipment. To identify a device for instance a cover for the battery compartment, or the connector terminals.
⑪		IEC60417 No. 5002	Positioning of cell To identify the battery holder itself and to identify the positioning of the cell(s) inside the battery holder.
⑫		-	The same as No. 11
⑬		IEC60417 No. 5019	Protective earth To identify any terminal which is intended for connection to an external conductor for protection against electric shock in case of a fault, or the terminal of a protective earth electrode.
⑭		IEC60417 No. 5017	Earth To identify an earth (ground) terminal in cases where symbol No. 13 is not explicitly required.
⑮		IEC60417 No. 5032	Alternating current To indicate on the rating plate that the equipment is suitable for alternating current only; to identify relevant terminals.
⑯		IEC60417 No. 5031	Direct current To indicate on the rating plate that the equipment is suitable for direct current only; to identify relevant terminals.
⑰		IEC60417 No. 5172	Class II equipment To identify equipment meeting the safety requirements specified for Class II equipment according to IEC 61140.

No.	Symbol mark	Approved standards	Meaning
18		ISO 3864	General prohibition To identify actions or operations that are prohibited.
19		ISO 3864	Contact prohibition To indicate injury that could occur due to touching a specific part of the equipment.
20		---	Never look into the projection lens while the projector is on.
21		---	To indicate that the marked item don't place anything on projector.
22		ISO3864 IEC60825-1	Caution, laser radiation To indicate the equipment has a laser radiation part.
23		ISO 3864	Disassembly prohibition To indicate a risk of injury, such as electric shock, if the equipment is disassembled.
24		IEC60417 No. 5266	Standby, partial standby To indicate that part of the equipment is in the ready status.
25		ISO3864 IEC60417 No.5057	Caution, movable parts To indicate that you must keep away from movable parts according to protection standards.
26		IEC 60417-6056	Caution (Moving Fan Blades) As a safety precaution, stay away from the moving fan blades.
27		IEC 60417-6043	Caution (Sharp Corners) To indicate sharp corners that should not be touched.
28		--	To indicate that looking into the lens while projecting is prohibited.

No.	Symbol mark	Approved standards	Meaning
29		ISO7010 No. W027 ISO 3864	Warning, light emission (UV, visible light, IR, etc.) When you are close to the light emissions, be careful not to injure your eyes or skin.
30		IEC60417 No. 5109	Usage prohibition in residential areas To indicate that this is an electrical device or a device that is not suitable for use in residential areas.

- A**
- A/V Mute 19, 102
 - A/V settings 149
 - Air exhaust vent 16
 - Air filter notice 147
 - Air filter replacement period 208
 - AMX Device Discovery 159
 - Aspect 80, 142
 - Audio Out port 17
 - Audio1 port 17
 - Audio2 port 17
 - Audio3 port 17
 - Auto setup 142
- B**
- Basic menu 153
 - Batch setup function 164
 - Beep 148
 - Black level 150
 - BNC port 17
 - Brightness 140
 - BT.709 76
- C**
- Ceiling mount 147
 - Ceiling mount fixing points 18
 - Cinema 76
 - Cleaning 204
 - Cleaning the air filter and air intake vent
..... 204
 - Cleaning the projector 204
 - Color adjustment 141
 - Color Mode 76, 140
 - Color saturation 140
 - Color Uniformity 147
 - Computer port 17
 - Configuration menu 136
 - Consumables 233
 - Contrast 140
 - Control panel 18
 - Corner wall 71
 - Crestron Connected 159, 228
 - Cross 104
- D**
- Date & Time 148
 - DHCP 155, 157
 - DICOM SIM 76
 - Direct Power On 148
 - Display 147
 - Display background 147
 - Document camera 233
 - DVI-D port 17
 - Dynamic 76
- E**
- Edge Blending 91, 150
 - EDID 143
 - Epson Projector Management 215
 - Epson Web Control 215
 - Esc 19
 - ESC/VP21 226
 - Event ID 161
 - Extended menu 146
 - Extron XTP 149
- F**
- E-Zoom 104
 - Filter indicator 175
 - Focus 38
 - Freeze 103
 - Front 147
 - Front feet 18
 - Full lock 117
- G**
- Gateway Address 155, 157
 - Geometry correction 144
- H**
- HDBaseT 149
 - HDBaseT port 17
 - HDBaseT signal quality 161
 - HDMI port 17
 - Help function 173
 - High altitude mode 148
 - Home Screen 59
- I**
- Image adjustment menu 140
 - Indicator 175
 - Info menu 161
 - Input signal 161
 - Installation requirements 31
 - Installation settings 31
 - IP address 155, 157

- K**
- Keystone distortion 144
- L**
- Language 150
 - Lens operation lock 118
 - Lens replacement cover 27
 - Lens Shift 34
 - Light Source Calibration 7, 112
- M**
- Mail notification 158, 225
 - Memory 145
 - Menu 18, 136
 - Message broadcasting 160
 - Messages 147
 - Monitor Out port 17
 - Multi-Projection 76, 150
 - Multi-Projection function 90
- N**
- Natural 76
 - Network configuration 152
 - Network information 151
 - Network menu 151
 - Notification email address 1/2/3 159
- O**
- Operating temperature 280
 - Operation 148
 - Optional accessories 233
 - Overheating 177
- Overscan** 142
- P**
- Panel alignment 147
 - Part names and functions 15
 - Password protect 115
 - PJLink 227
 - PJLink password 153
 - Port number 158
 - Position 142
 - Power inlet 16
 - Power on protection 115
 - Presentation 76
 - Priority gateway 159
 - Projection 147
 - Projection distance 234
 - Projection lens 27
 - Projector 58, 60
 - Projector ID 42
 - Projector Keyword 153
 - Projector name 153
- Q**
- Quick Corner 144
- R**
- Reading mail 225
 - Rear 147
 - Rear feet 18
 - Refresh Rate 161
 - Remote control 20
 - Remote control button lock 118
 - Remote control ID 43
- Remote port** 17
- Remote receiver** 15
- Replacing batteries** 23
- Replacing the air filter** 208
- Reset all config** 163
- Reset memory** 162
- Reset menu** 162
- Resolution** 142, 161
- Resolutions** 274
- RS-232C port** 17
- S**
- Scale 143, 150
 - Schedule 112
 - Schedule settings 150
 - Screen settings 32, 147
 - Screen Size 101, 234
 - Search access point 156
 - Serial number 161
 - Settings menu 143
 - Sharpness 140
 - Signal menu 142
 - SMTP server 158
 - SNMP 226
 - Soft keyboard 152
 - Source 100, 161
 - Source Search 18, 61
 - Specifications 279
 - Split screen 144
 - Split Screen Setup 100
 - Standby mode 149
 - Startup screen 147
 - Status 161

Status indicators	15
Storage temperature	280
Subnet mask	155, 157
Supported resolutions	274
Swap screens	101
Sync info	161
Sync.	142

T

Test Pattern	33, 145
Tint	140
Tracking	142
Trap IP address 1/2	159

U

User Button	145
User's Logo	104
User's logo protection	115

V

Volume	144
--------------	-----

W

WEB API	232
Web browser	215
Web control password	153
White Balance	140
Wired LAN menu	157
Wireless LAN menu	154

Free Manuals Download Website

<http://myh66.com>

<http://usermanuals.us>

<http://www.somanuals.com>

<http://www.4manuals.cc>

<http://www.manual-lib.com>

<http://www.404manual.com>

<http://www.luxmanual.com>

<http://aubethermostatmanual.com>

Golf course search by state

<http://golfingnear.com>

Email search by domain

<http://emailbydomain.com>

Auto manuals search

<http://auto.somanuals.com>

TV manuals search

<http://tv.somanuals.com>