



## **User's Guide**

# **Multimedia Projector**

<b>EB-L735U</b>	<b>EB-L630SU</b>
<b>EB-L730U</b>	<b>EB-L630U</b>
<b>EB-L720U</b>	<b>EB-L530U</b>
<b>EB-L635SU</b>	<b>EB-L520U</b>

## **Notations Used in This Guide 8**

### **Using the Manual to Search for Information ..... 9**

- Searching by Keyword ..... 9
- Jumping Directly from Bookmarks..... 9
- Printing Only the Pages You Need..... 9

### **Getting the Latest Version of the Documents..... 10**

## **Introduction to Your Projector 11**

### **Projector Features..... 12**

- Long-life Laser Light Source..... 12
- Quick and Easy Setup ..... 12
- Easy Wireless Projection ..... 12
- Managing over a Network ..... 13
- Projecting for Exhibitions..... 13

### **Projector Parts and Functions ..... 15**

- Projector Parts - Front/Top ..... 15
- Projector Parts - Rear..... 16
- Projector Parts - Base ..... 17
- Projector Parts - Interface Ports ..... 17
- Projector Parts - Control Panel ..... 18
- Projector Parts - Remote Control ..... 19

## **Setting Up the Projector 21**

### **Projector Placement ..... 22**

- Notes on Transporting ..... 23
- Projector Setup and Installation Options..... 24
  - Precautions on Installation ..... 24
- Projection Distance..... 26

### **Installing the Safety Wire..... 27**

- When Using the Ceiling Mount ELPMB22..... 27
- When Using the Ceiling Mount ELPMB30..... 28

### **Projector Connections ..... 30**

- Connecting to a Computer..... 30
  - Connecting to a Computer for VGA Video and Audio ..... 30
  - Connecting to a Computer for HDMI Video and Audio ..... 31
- Connecting to Video Sources ..... 31
  - Connecting to an HDMI Video Source ..... 31
- Connecting to External USB Devices ..... 32
  - USB Device Projection ..... 32
  - Connecting to a USB Device ..... 32
  - Disconnecting a USB Device ..... 33
- Connecting to a Document Camera ..... 33
- Connecting to a Streaming Media Player ..... 33
- Connecting to an HDBaseT Transmitter ..... 34
- Connecting to External Devices..... 34
  - Connecting to an External HDMI Monitor ..... 35
  - Connecting to a VGA Monitor ..... 35
  - Connecting to External Speakers ..... 35
- Connecting Multiple Projectors of the Same Model ..... 36
  - Menu Settings for Multiple Projector Connections..... 37

### **Attaching and Removing the Cable Cover ..... 38**

### **Installing Batteries in the Remote Control..... 39**

- Remote Control Operation ..... 40

## **Using Basic Projector Features 41**

### **Turning On the Projector ..... 42**

- Home Screen..... 43

### **Turning Off the Projector ..... 44**

### **Setting the Date and Time ..... 45**

### **Selecting the Language for the Projector Menus ..... 47**

- Projection Modes ..... 48**
  - Changing the Projection Mode Using the Remote Control..... 48
  - Changing the Projection Mode Using the Menus..... 48
- Setting the Screen Type ..... 50**
  - Adjusting the Image Position Using Screen Position..... 50
  - Changing the Horizontal Position of the Image Using Screen Shift..... 51
- Adjusting the Image Position Using Lens Shift..... 53**
- Displaying a Test Pattern ..... 55**
- Adjusting the Image Height..... 56**
- Image Shape ..... 57**
  - Correcting Image Shape with H/V Keystone ..... 57
  - Correcting the Image Shape with Quick Corner ..... 59
  - Correcting Image Shape with Arc Correction..... 61
  - Correcting Image Shape with Point Correction..... 63
  - Loading Image Shape Setting from Memory ..... 65
- Resizing the Image with the Zoom Ring..... 66**
- Reducing the Image Using Digital Zoom..... 67**
  - Adjusting the Image Position Using Image Shift..... 67
- Focusing the Image Using the Focus Ring..... 69**
- Selecting an Image Source ..... 70**
- Image Aspect Ratio ..... 72**
  - Changing the Image Aspect Ratio ..... 72
  - Available Image Aspect Ratios ..... 72
- Adjusting Image Quality (Color Mode) ..... 74**
  - Changing the Color Mode ..... 74
  - Available Color Modes..... 74
- Turning On Automatic Luminance Adjustment ..... 75**
- Adjusting the Image Color ..... 76**
  - Adjusting the Hue, Saturation, and Brightness..... 76
  - Adjusting the Gamma ..... 77

- Adjusting the Image Resolution ..... 79**
- Adjusting the Brightness..... 81**
  - Constant Brightness Usage Hours ..... 82
  - Light Source Operation Time..... 83
- Controlling the Volume with the Volume Buttons ..... 84**
- Adjusting Projector Features ..... 85**

---

- Projecting Multiple Images Simultaneously ..... 86**
  - Unsupported Input Source Combinations for Split Screen Projection..... 88
  - Split Screen Projection Restrictions..... 88
- Projecting a PC Free Presentation..... 89**
  - Supported PC Free File Types..... 89
  - Precautions on PC Free Projection ..... 90
  - Starting a PC Free Slide Show ..... 90
  - Starting a PC Free Movie Presentation ..... 92
  - PC Free Display Options ..... 93
- Projecting in Content Playback Mode ..... 94**
  - Supported Content Playback Mode File Types..... 94
  - Switching to Content Playback Mode..... 95
  - Projecting Your Playlists ..... 96
    - Creating Playlists Using Epson Web Control..... 96
  - Adding Effects to Your Projected Image..... 98
  - Content Playback Mode Restrictions..... 100
- Shutting Off the Image and Sound Temporarily ..... 101**
- Stopping Video Action Temporarily ..... 102**
- Zooming Images (E-Zoom)..... 103**
- Zooming In/Zooming Out of Images (E-Zoom)..... 104**
  - Zooming Into Images..... 104
  - Zooming Out of Images..... 104
- Saving a User's Logo Image ..... 106**

**Saving Settings to Memory and Using Saved Settings ..... 108**

**Using Advanced Image Adjustment Features ..... 109**

- Adjusting the Color Tone (Color Uniformity) ..... 109
- Running Light Source Calibration ..... 110

**Using Multiple Projectors ..... 112**

- Multiple Projector Adjustment Overview ..... 112
- Projector Identification System for Multiple Projector Control..... 113
  - Setting the Projector ID ..... 113
  - Selecting the Projector You want to Operate..... 114
- Tiling Images into One Image..... 115
  - Configuring Tiling ..... 115
- Blending the Image Edges ..... 116
  - Adjusting the Black Level..... 118
  - Modifying the Black Level Adjustment Area ..... 120
- Matching the Image Colors..... 120
- Scaling an Image..... 121

**Projector Security Features ..... 124**

- Password Security Types..... 124
  - Setting a Password ..... 124
  - Selecting Password Security Types ..... 125
  - Entering a Password to Use the Projector ..... 126
- Locking the Projector's Buttons ..... 126
  - Unlocking the Projector's Buttons ..... 127
- Locking the Remote Control Buttons..... 127
- Installing a Security Cable ..... 128

**Using the Projector on a Network ..... 129**

**Wired Network Projection..... 130**

- Connecting to a Wired Network ..... 130
- Selecting Wired Network Settings..... 130

**Wireless Network Projection ..... 133**

- Safety Instructions for Built-in Wireless LAN Module..... 133

Installing the Wireless LAN Module ..... 133

- Connection Methods for Wireless Network Projection ..... 134
- Selecting Wireless Network Settings Manually ..... 135
  - Selecting Wireless Network Settings in Windows ..... 138
  - Selecting Wireless Network Settings in Mac..... 139
- Setting Up Wireless Network Security for Simple AP Mode..... 139
- Setting Up Wireless Network Security for Infrastructure Mode..... 139
  - Supported Client and CA Certificates..... 141
- Using a QR Code to Connect a Mobile Device ..... 142
- Using a USB Key to Connect a Windows Computer..... 142
- Using the Wireless Presentation System to Connect Windows/Mac Computers ..... 143
  - Setting Up the Wireless Presentation System for the First Time ..... 143
  - Projecting with the Wireless Presentation System..... 144

**Wireless Network Projection from a Mobile Device (Screen Mirroring)..... 145**

- Selecting Screen Mirroring Settings ..... 145
- Connecting Using Screen Mirroring with the Miracast Function..... 147
- Connecting Using Screen Mirroring in Windows 10 ..... 148
- Connecting Using Screen Mirroring in Windows 8.1 ..... 148

**Secure HTTP..... 150**

- Importing a Web Server Certificate Using the Menus ..... 150
  - Supported Web Server Certificates ..... 151

**Screen Sharing ..... 152**

- Sharing the Screen ..... 152
  - Finishing the Screen Sharing..... 153
- Receiving Shared Screen Images..... 154

**Monitoring and Controlling the Projector ..... 155**

**Epson Projector Management ..... 156**

**Controlling a Networked Projector Using a Web Browser ..... 157**

- Web Control Options..... 158

- Registering Digital Certificates from a Web Browser..... 166**
- Setting Up Projector Network E-Mail Alerts ..... 168**
  - Network Projector E-mail Alert Messages ..... 168
- Setting Up Monitoring Using SNMP..... 169**
- Using ESC/VP21 Commands ..... 170**
  - ESC/VP21 Command List ..... 170
  - Cable Layouts ..... 170
- PJLink Support ..... 171**
- Crestron Connected Support ..... 172**
  - Setting Up Crestron Connected Support..... 172
- Operating the Projector Using Web API..... 173**
  - Enabling Web API ..... 173
- Setting Projector Event Schedules ..... 174**
- Adjusting the Menu Settings ..... 177**

---

- Using the Projector's Menus ..... 178**
- Using the Displayed Keyboard ..... 179**
  - Available Text Using the Displayed Keyboard..... 179
- Image Quality Settings - Image Menu ..... 180**
- Input Signal Settings - Signal I/O Menu..... 183**
- Projector Installation Settings - Installation Menu ..... 185**
- Projector Display Settings - Display Menu ..... 187**
- Projector Feature Settings - Operation Menu..... 189**
- Projector Administration Settings - Management Menu ..... 192**
  - Event ID Code List..... 193
- Projector Network Settings - Network Menu..... 195**
  - Network Menu - Network Settings Menu..... 196
  - Network Menu - Wireless LAN Menu..... 197

- Network Menu - Wired LAN Menu ..... 199
- Network Menu - Mail Notification Menu ..... 200
- Network Menu - Projector Control Menu ..... 200
- Network Menu - Network Projection Settings ..... 201
- Multiple Projector Operation Settings - Multi-Projection Menu ..... 203**
- Image Quality Memory Settings - Memory Menu..... 205**
- Projector Initial Settings and Reset Options - Initial/All Settings Menu ..... 206**
- Copying Menu Settings Between Projectors (Batch Setup) ..... 207**
  - Transferring Settings From a USB Flash Drive ..... 207
  - Transferring Settings From a Computer ..... 208
  - Batch Setup Error Notification ..... 209

## **Maintaining the Projector 210**

---

- Projector Maintenance ..... 211**
- Cleaning the Lens..... 212**
- Cleaning the Projector Case..... 213**
- Air Filter and Vent Maintenance ..... 214**
  - Cleaning the Air Filters and Intake Vents ..... 214
  - Replacing the Air Filter ..... 216
- Updating the Firmware ..... 218**
  - Updating Firmware Using a USB Storage Device..... 218
  - Updating Firmware Using a Computer and USB Cable ..... 219

## **Solving Problems 221**

---

- Projection Problems ..... 222**
- Projector Indicator Status ..... 223**

- Viewing the Status Display ..... 226**
  - Projector Status Display Messages..... 226
- Solving Image or Sound Problems..... 229**
  - Solutions When No Image Appears..... 229
  - Solutions When "No Signal" Message Appears..... 229
    - Displaying From a Windows Laptop..... 230
    - Displaying From a Mac Laptop..... 230
  - Solutions When "Not Supported" Message Appears ..... 230
  - Solutions When Only a Partial Image Appears..... 230
  - Solutions When the Image is not Rectangular..... 231
  - Solutions When the Image Contains Noise or Static..... 231
  - Solutions When the Image is Fuzzy or Blurry ..... 232
  - Solutions When the Image Brightness or Colors are Incorrect..... 233
  - Solutions When an Afterimage Remains on the Projected Image ..... 233
  - Solutions to Sound Problems..... 233
  - Solutions When Image File Names are not Displayed Correctly in PC Free..... 234
  - Solutions When You Cannot Project Images Using the PC Free Feature..... 234
- Solving Projector or Remote Control Operation Problems ..... 235**
  - Solutions to Projector Power or Shut-Off Problems..... 235
  - Solutions to Problems with the Remote Control..... 235
  - Solutions to Password Problems..... 236
  - Solution When "The Battery that Saves Your Clock Settings is Running Low" Message Appears ..... 236
- Solving Network Problems ..... 237**
  - Solutions When Wireless Authentication Fails ..... 237
  - Solutions When You Cannot Access the Projector Through the Web ..... 237
  - Solutions When Network Alert E-Mails are not Received..... 237
  - Solutions When the Image Contains Static During Network Projection..... 238
  - Solutions When You Cannot Connect Using Screen Mirroring..... 238
  - Solutions When You Cannot Use Two Screen Mirroring Sources..... 238
  - Solutions When the Image or Sound Contains Static During Screen Mirroring Connection ..... 239
  - Solutions When You Cannot Receive Shared Images..... 239
- Solutions to Problems in Content Playback Mode ..... 240**

- Solutions When HDMI Link does not Function ..... 241**

## **Appendix ..... 242**

---

- Optional Accessories and Replacement Parts..... 243**
  - Screens..... 243
  - Cables..... 243
  - Mounts..... 243
    - For Wireless Connection ..... 243
  - External Devices ..... 243
  - Replacement Parts..... 244
- Screen Size and Projection Distance..... 245**
  - EB-L735U/EB-L730U/EB-L635SU/EB-L630SU/EB-L630U/EB-L530U ..... 245
  - EB-L720U/EB-L520U ..... 248
- Supported Monitor Display Resolutions ..... 250**
- Projector Specifications ..... 254**
  - Connector Specifications ..... 255
- External Dimensions ..... 256**
- Supported Features for Epson Projector Content Manager..... 257**
- Supported Features for the Epson Projector Professional Tool 258**
- List of Safety Symbols and Instructions ..... 259**
- Laser Safety Information..... 261**
  - Laser Warning Labels..... 261
- Glossary ..... 263**
- Notices ..... 265**
  - FCC Compliance Statement..... 265
  - Indication of the manufacturer and the importer in accordance with requirements of EU directive..... 266
  - Restriction of Use ..... 266
  - Operating System References..... 266
  - Trademarks..... 266



Copyright Notice..... 267  
Copyright Attribution..... 267

# Notations Used in This Guide





## Safety Symbols

The projector and its manuals use graphical symbols and labels to indicate content that tells you how to use the projector safely.

Read and carefully follow the instructions that are marked with these symbols and labels to avoid injury to persons or damage to property.

 <b>Warning</b>	This symbol indicates information that, if ignored, could possibly result in personal injury or even death.
 <b>Caution</b>	This symbol indicates information that, if ignored, could possibly result in personal injury or physical damage due to incorrect handling.

## General Information Notations

<b>Attention</b>	This label indicates procedures that may result in damage or injury if sufficient care is not taken.
	This label indicates additional information that may be useful to know.
[Button name]	Indicates the name of the buttons on the remote control or the control panel. Example: [Esc] button
<b>Menu/Setting name</b>	Indicates projector menu and setting names. Example: Select the <b>Image</b> menu  <b>Image &gt; Color Mode</b>
	This label indicates links to the related pages.
	This label indicates the projector's current menu level.

## » Related Links

- "Using the Manual to Search for Information" [p.9](#)
- "Getting the Latest Version of the Documents" [p.10](#)



The PDF manual allows you to search for information you are looking for by keyword, or jump directly to specific sections using the bookmarks. You can also print only the pages you need. This section explains how to use a PDF manual that has been opened in Adobe Reader X on your computer.

### ► Related Links

- "Searching by Keyword" p.9
- "Jumping Directly from Bookmarks" p.9
- "Printing Only the Pages You Need" p.9

- Mac OS: Hold down the command key, and then press ←.

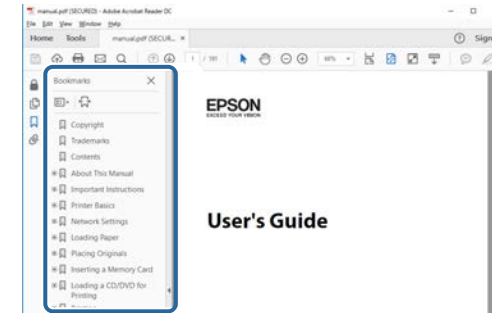

## Searching by Keyword

Click **Edit > Advanced Search**. Enter the keyword (text) for information you want to find in the search window, and then click **Search**. Hits are displayed as a list. Click one of the displayed hits to jump to that page.

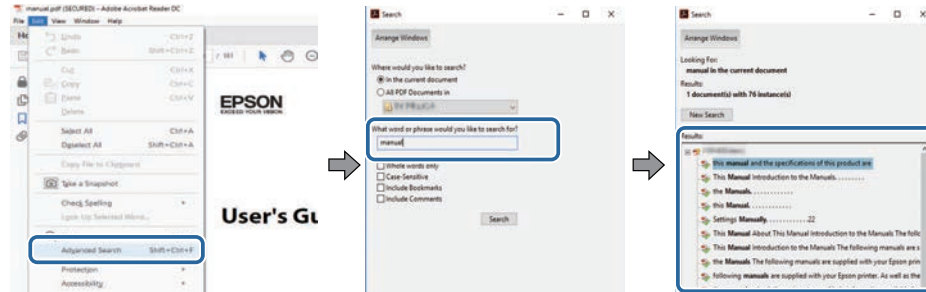

## Printing Only the Pages You Need

You can extract and print only the pages you need. Click **Print** in the **File** menu, and then specify the pages you want to print in **Pages in Pages to Print**.

- To specify a series of pages, enter a hyphen between the start page and the end page.  
Example: 20-25
- To specify pages that are not in series, divide the pages with commas.  
Example: 5, 10, 15

## Jumping Directly from Bookmarks

Click a title to jump to that page. Click + or > to view the lower level titles in that section. To return to the previous page, perform the following operation on your keyboard.

- Windows: Hold down **Alt**, and then press ←.

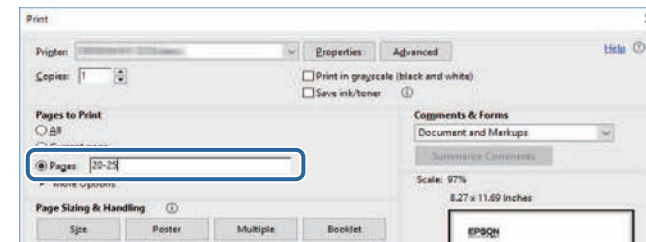

You can get the latest version of the manuals and specifications on the Epson Web site.

Visit [epson.sn](http://epson.sn), and enter your model name.

# Introduction to Your Projector

Refer to these sections to learn more about your projector's features and part names.

## ► **Related Links**

- "Projector Features" [p.12](#)
- "Projector Parts and Functions" [p.15](#)

This projector comes with these special features. Refer to these sections for more details.

## ► Related Links

- "Long-life Laser Light Source" [p.12](#)
- "Quick and Easy Setup" [p.12](#)
- "Easy Wireless Projection" [p.12](#)
- "Managing over a Network" [p.13](#)
- "Projecting for Exhibitions" [p.13](#)

---

## Long-life Laser Light Source

A solid-state laser light source provides virtually maintenance-free operation until light source brightness is reduced.

---

## Quick and Easy Setup

- Direct Power On feature to turn on the projector as soon as you plug it in.
- Auto Power On feature to turn on the projector when the projector detects an image signal from the port you specified as the **Auto Power On** source.
- Home screen feature to easily select an input source and useful functions.

## ► Related Links

- "Home Screen" [p.43](#)
- "Turning On the Projector" [p.42](#)

---

## Easy Wireless Projection

- Screen Mirroring to connect your projector and mobile device wirelessly using Miracast technology.



- Epson iProjection (Windows/Mac) to project up to four images at the same time by splitting the projected screen. You can project images from computers on the network, or from smartphones or tablet devices on which Epson iProjection is installed.

See the *Epson iProjection Operation Guide (Windows/Mac)* for details.

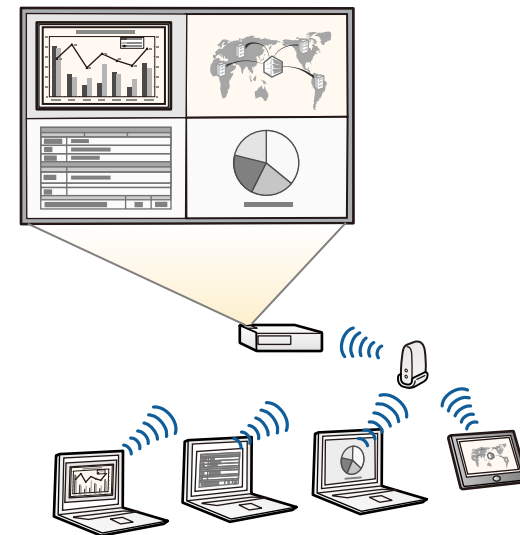



- When projecting images using a wireless LAN, you must install the Epson 802.11b/g/n wireless LAN module, and then set up your projector and computer for wireless projection (EB-L720U/EB-L520U). Depending on your projector model, you may need to purchase the optional wireless LAN module. See the *Quick Reference* for a list of items supplied with your projector.
- Some models have built-in wireless LAN modules (EB-L735U/EB-L730U/EB-L635SU/EB-L630SU/EB-L630U/EB-L530U).
- You can download the necessary software and manuals from the following Web site:  
[epson.sn](http://epson.sn)

- Epson iProjection (iOS/Android) to connect your projector and mobile device wirelessly using the app available on the App Store or Google Play.



Any fees incurred when communicating with the App Store or Google Play are the responsibility of the customer.

- Epson iProjection (Chromebook) to connect your projector and Chromebook device wirelessly using the app available on the Chrome Web Store.



Any fees incurred when communicating with the Chrome Web Store are the responsibility of the customer.

## » Related Links

- "Wired Network Projection" [p.130](#)
- "Wireless Network Projection" [p.133](#)
- "Wireless Network Projection from a Mobile Device (Screen Mirroring)" [p.145](#)

## Managing over a Network

Epson Projector Professional Tool to adjust the projected image or monitor the projector from your computer over a network.

See the *Epson Projector Professional Tool Operation Guide* for details.



You can download the necessary software and manuals from the following Web site:  
[epson.sn](http://epson.sn)

## » Related Links

- "Supported Features for the Epson Projector Professional Tool" [p.258](#)

## Projecting for Exhibitions

Your projector allows you to project your content for exhibitions as digital signage.



- Content Playback mode to play your playlists, and add color and shape effects to your projected image.
- You can use one of the following methods to create content played in Content Playback mode.
  - The Epson Projector Content Manager software allows you to create playlists and save them on an external storage device. You can also add color and shape effects to your projected image, and schedule playlists. See the *Epson Projector Content Manager Operation Guide* for details.
  - Epson Web Control allows you to create playlists using a Web browser and save them to an external storage device connected to a projector on a network. You can also add color and shape effects to your projected image.
  - The Epson Creative Projection app allows you to create content on iOS devices. You can also transfer content to the projector wirelessly. You can download Epson Creative Projection from the App Store. Any fees incurred when communicating with the App Store are the responsibility of the customer.



You can download the necessary software and manuals from the following Web site:

[epson.sn](http://epson.sn)

## ► Related Links

- "Projecting in Content Playback Mode" [p.94](#)
- "Supported Features for Epson Projector Content Manager" [p.257](#)

The following sections explain the projector parts and their functions.

All of the features in this guide are explained using illustrations of EB-L735U unless otherwise mentioned.

The shape of the projector part may vary depending on the model of your projector.

► **Related Links**

- "Projector Parts - Front/Top" [p.15](#)
- "Projector Parts - Rear" [p.16](#)
- "Projector Parts - Base" [p.17](#)
- "Projector Parts - Interface Ports" [p.17](#)
- "Projector Parts - Control Panel" [p.18](#)
- "Projector Parts - Remote Control" [p.19](#)

## Projector Parts - Front/Top

EB-L735U/EB-L730U/EB-L635SU/EB-L630SU/EB-L630U/EB-L530U

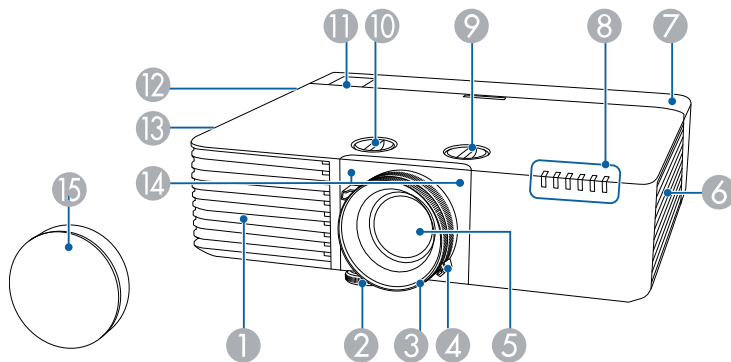

EB-L720U/EB-L520U

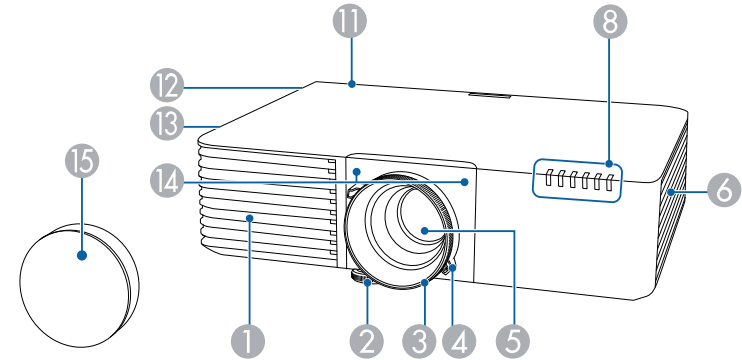

Name		Function
①	Air intake vent	Takes in air to cool the projector internally.
②	Front adjustable foot	When setup on a surface such as a desk, extend the foot to adjust the position of the image.
③	Focus ring	Adjusts the image focus.
④	Zoom ring (EB-L735U/EB-L730U /EB-L720U/EB-L630U /EB-L530U/EB-L520U )	Adjusts the image size.
⑤	Lens	Images are projected from here.
⑥	Air intake vent (air filter)	Takes in air to cool the projector internally.
⑦	Cable cover (EB-L735U/EB-L730U /EB-L635SU/EB-L630SU/EB-L630U/EB-L530U)	Cover for the rear interface ports section. Loosen the two screws and pull the cover off when connecting cables for external devices or installing the wireless LAN module.
⑧	Indicators	Indicates the projector's status.

Name	Function
9 Vertical lens shift dial (EB-L735U/EB-L730U /EB-L635SU/EB-L630SU/EB-L630U/EB-L530U)	Turn the dial to move the position of the projected image up or down.
10 Horizontal lens shift dial (EB-L735U/EB-L730U /EB-L635SU/EB-L630SU/EB-L630U/EB-L530U)	Turn the dial to move the position of the projected image left or right.
11 Remote receiver	Receives signals from the remote control.
12 Speaker	Outputs audio.
13 Air exhaust vent	Exhaust vent for air used to cool the projector internally.  <div style="border: 1px solid black; padding: 5px; background-color: #ffffcc;"> <p><b>⚠ Caution</b></p> <p>While projecting, do not put your face or hands near the air exhaust vent, and do not place objects that may become warped or damaged by heat near the vent. Hot air from the air exhaust vent could cause burns, warping, or accidents to occur.</p> </div>
14 Remote receiver	Receives signals from the remote control.
15 Lens cover	Attach when not using the projector to protect the lens.

► **Related Links**

- "Air Filter and Vent Maintenance" [p.214](#)
- "Projector Indicator Status" [p.223](#)
- "Remote Control Operation" [p.40](#)
- "Resizing the Image with the Zoom Ring" [p.66](#)
- "Focusing the Image Using the Focus Ring" [p.69](#)
- "Attaching and Removing the Cable Cover" [p.38](#)
- "Adjusting the Image Position Using Lens Shift" [p.53](#)

## Projector Parts - Rear

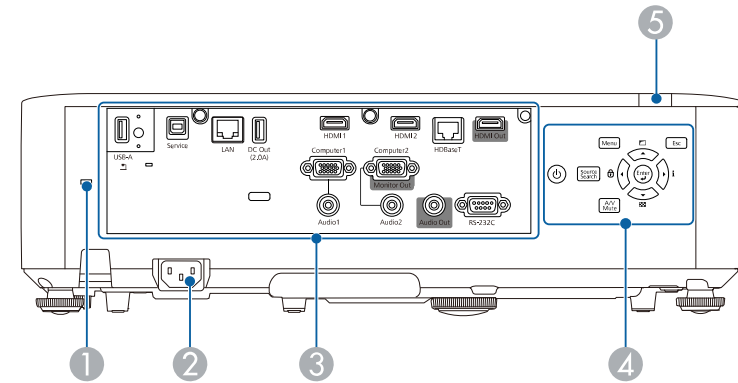

Name	Function
1 Security slot	The security slot is compatible with the Microsaver Security System manufactured by Kensington.
2 Power inlet	Connects the power cord to the projector.
3 Interface ports	Connects cables for external devices.
4 Control panel	Operates the projector.
5 Remote receiver	Receives signals from the remote control.

► **Related Links**

- "Projector Parts - Interface Ports" [p.17](#)
- "Installing a Security Cable" [p.128](#)



## Projector Parts - Base

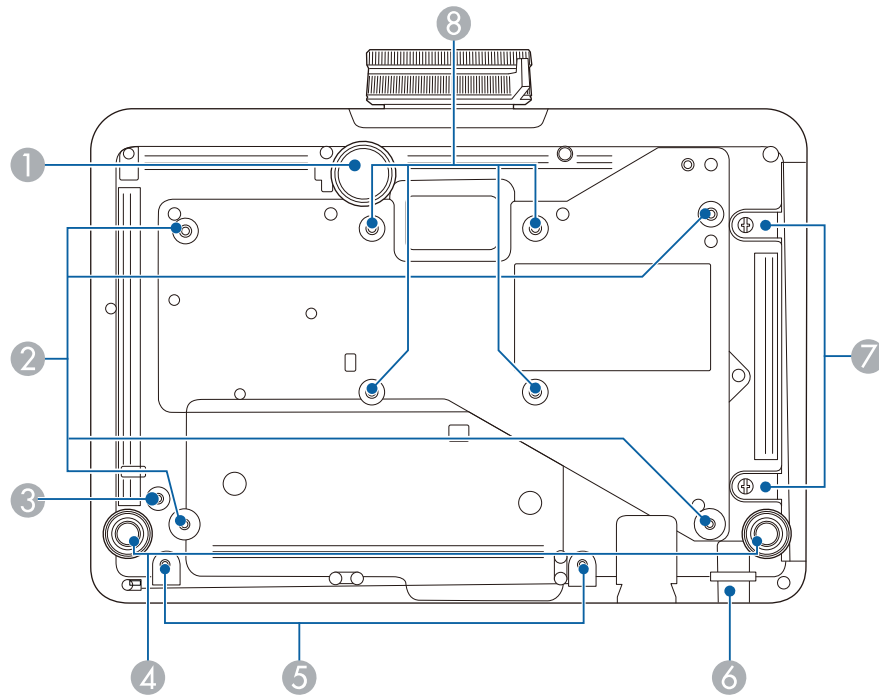

Name	Function	
5	Screw holes for cable cover (EB-L735U/EB-L730U/EB-L635SU/EB-L630SU/EB-L630U/EB-L530U)	Screw holes to fix the cable cover in place.
6	Security cable attachment point	Pass a commercially available wire lock through here and lock it in place. <b>Warning</b> Do not attach the safety wire to this point.
7	Air filter cover screws	Screws to fix the air filter cover in place.
8	Fixing points (four points)	Use these points to attach a commercially available mount compatible with the VESA Mounting Interface Standard (100 × 100 mm) when installing the projector on a wall, or suspending the projector from a ceiling.

### ► Related Links

- "Installing a Security Cable" p.128

Name	Function	
1	Front adjustable foot	When setup on a surface such as a desk, extend the foot to adjust the position of the image.
2	Ceiling mount fixing points (four points)	Attach the optional ceiling mount here when suspending the projector from a ceiling.
3	Wire clamp fixing point	When you use the optional ceiling mount, fix the carabiner here to attach the safety wire and prevent the projector from falling from the ceiling or wall.
4	Rear feet	When setup on a surface such as a desk, turn to extend and retract to adjust the horizontal tilt.

## Projector Parts - Interface Ports

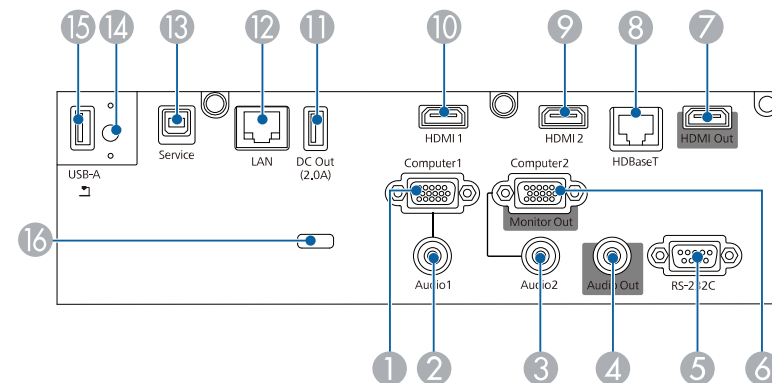

Name	Function
① Computer1 port	Inputs image signal from a computer.
② Audio1 port	Inputs audio from equipment connected to the Computer1 port.
③ Audio2 port	Inputs audio from equipment connected to the Computer2 port.
④ Audio Out port	Outputs audio from the current input source to an external speaker.
⑤ RS-232C port	Connects an RS-232C cable to control the projector from a computer. (You do not need to use this port normally.)
⑥ Computer2/Monitor Out port	When <b>Monitor Out Port</b> is set to <b>Monitor Out</b> in the projector's <b>Signal I/O</b> menu, analog RGB signals input from the Computer1 port are output to an external monitor. You cannot output signals input from other ports.  When <b>Monitor Out Port</b> is set to <b>Computer2</b> in the projector's <b>Signal I/O</b> menu, image signal from a computer is input.
⑦ HDMI Out port (EB-L735U/EB-L730U/EB-L635SU/EB-L630SU/EB-L630U/EB-L530U)	Outputs video signals to an external monitor. Connecting an HDMI cables from this port to the HDMI port of another projectors lets you create and project a single unified image. This port is compatible with HDCP2.3.
⑧ HDBaseT port	Connects a LAN cable to the optional HDBaseT Transmitter. This port is compatible with HDCP2.3.
⑨ HDMI2 port	Inputs video signals from HDMI compatible video equipment and computers.
⑩ HDMI1 port	This port is compatible with HDCP2.3.
⑪ DC Out port (EB-L735U/EB-L730U/EB-L635SU/EB-L630SU/EB-L630U/EB-L530U)	Provides a connection for an optional or commercially available streaming media player allowing you to power it. USB data transfer is not available.
⑫ LAN port	Connects a LAN cable to connect to a network.



Name	Function
⑬ Service port	This port is used for batch settings and firmware update.
⑭ Wireless LAN module fixing screw	Secures the wireless LAN module cover.
⑮ USB-A port	Connects a USB device and projects movies or images. Use to connect the optional document camera. Use to connect the wireless LAN module. Use to pair the optional wireless transmitter. Use to connect a USB memory device to save error and operation log files.
⑯ Cable holder	Pass a commercially available cable tie through here to secure cables.

» **Related Links**

- "Projector Connections" p.30
- "Wireless Network Projection" p.133

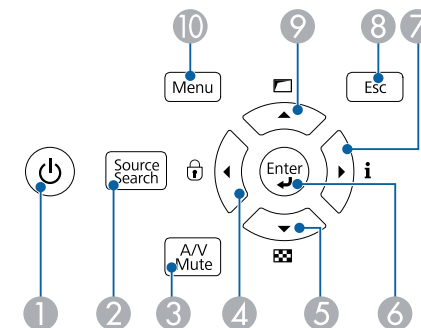
## Projector Parts - Control Panel



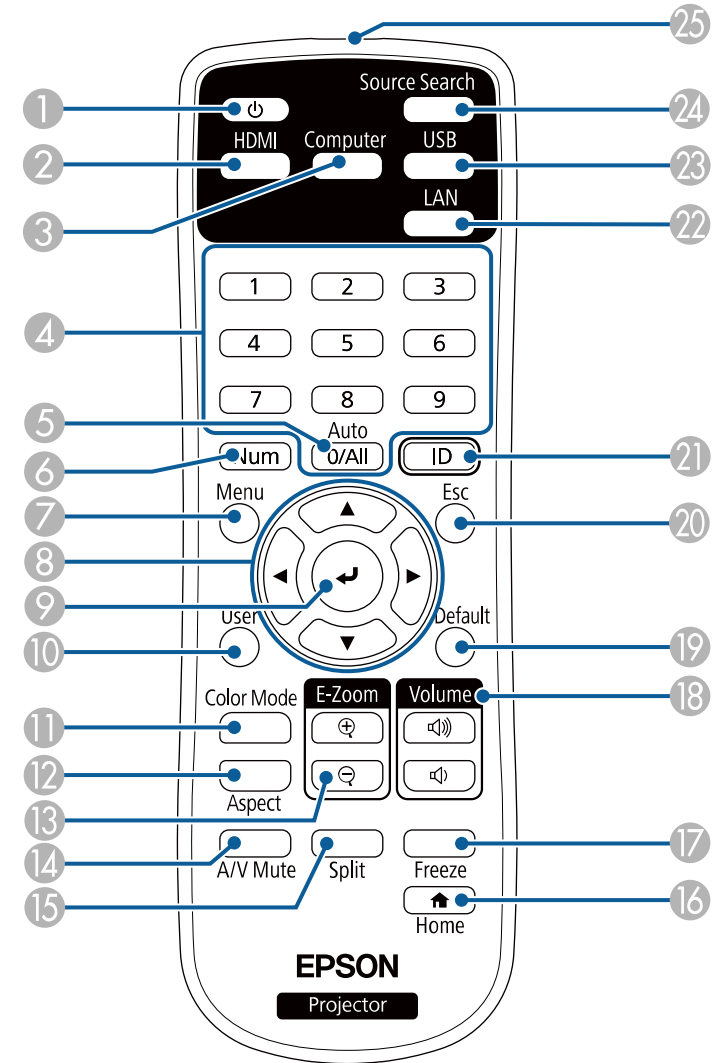

Name	Function
1 Power button (  )	Turns the projector on or off.
2 [Source Search] button	Changes to the next input source.
3 [A/V Mute] button	Turns the video and audio on or off temporarily.
4 Left arrow button	Displays the <b>Control Panel Lock</b> screen. Selects menu items while displaying the projector's menu or help.
5 Down arrow button	Displays a test pattern. Selects menu items while displaying the projector's menu or help.
6 [Enter] button (  )	Enters the current selection and moves to the next level while displaying the projector's menu or help. When projecting an analog RGB signal from the Computer port, optimizes the <b>Analog Signal Adjustment</b> settings ( <b>Tracking</b> , <b>Sync.</b> , and <b>Position</b> ).
7 Right arrow button	Displays the <b>Information</b> screen. Selects menu items while displaying the projector's menu or help.
8 [Esc] button	Stops the current function. Moves back to the previous menu level while displaying the projector's menu.
9 Up arrow button	Displays the <b>Geometry Correction</b> screen. Selects menu items while displaying the projector's menu or help.
10 [Menu] button	Displays and closes the projector's menu.

## Projector Parts - Remote Control



### » Related Links

- "Selecting an Image Source" [p.70](#)
- "Adjusting the Menu Settings" [p.177](#)

Name	Function
① Power button (  )	Turns the projector on or off.
② [HDMI] button	Switches the image source between the HDMI1 and HDMI2 ports.
③ [Computer] button	Switches the image source to the Computer1 and Computer2 ports.
④ Numeric buttons	Enters numbers in the projector's menu while holding down the [Num] button.
⑤ [Auto] button	When projecting an analog RGB signal from the Computer port, optimizes the <b>Analog Signal Adjustment</b> settings ( <b>Tracking, Sync., and Position</b> ).
⑥ [Num] button	Hold down this button to enter numbers using the numeric buttons.
⑦ [Menu] button	Displays and closes the projector's menu.
⑧ Arrow buttons	Selects menu items while displaying the projector's menu.
⑨ [Enter] button (  )	Enters the current selection and moves to the next level while displaying the projector's menu.
⑩ [User] button	Performs settings assigned in the <b>User Button</b> setting in the projector's <b>Management</b> menu.
⑪ [Color Mode] button	Changes the color mode.
⑫ [Aspect] button	Changes the aspect mode.
⑬ [E-Zoom] +/- buttons	Resizes the projected image.
⑭ [A/V Mute] button	Turns the video and audio on or off temporarily.
⑮ [Split] button	Projects up to four images from different image sources simultaneously by splitting the projected screen.
⑯ [Home] button	Displays and closes the Home screen.
⑰ [Freeze] button	Pauses or resumes images.
⑱ [Volume] up/down buttons	Adjusts the speaker volume.
⑲ [Default] button	Returns the selected setting to its default value.

Name	Function
⑳ [Esc] button	Stops the current function. Moves back to the previous menu level while displaying the projector's menu.
㉑ [ID] button	Hold down this button and press the numeric buttons to select the ID for the projector you want to operate using the remote control.
㉒ [LAN] button	Switches the image source to the network connected device.
㉓ [USB] button	Selects the USB-A port as the image source.
㉔ [Source Search] button	Switches to the next input source.
㉕ Remote control light emitting area	Outputs remote control signals.

### ► Related Links

- "Projecting in Content Playback Mode" [p.94](#)
- "Adjusting Image Quality (Color Mode)" [p.74](#)
- "Image Aspect Ratio" [p.72](#)
- "Zooming In/Zooming Out of Images (E-Zoom)" [p.104](#)
- "Home Screen" [p.43](#)
- "Selecting an Image Source" [p.70](#)
- "Zooming Images (E-Zoom)" [p.103](#)
- "Shutting Off the Image and Sound Temporarily" [p.101](#)
- "Projecting Multiple Images Simultaneously" [p.86](#)
- "Stopping Video Action Temporarily" [p.102](#)
- "Controlling the Volume with the Volume Buttons" [p.84](#)
- "Setting the Projector ID" [p.113](#)
- "Adjusting the Menu Settings" [p.177](#)

# Setting Up the Projector

Follow the instructions in these sections to set up your projector.

## ► Related Links

- "Projector Placement" [p.22](#)
- "Installing the Safety Wire" [p.27](#)
- "Projector Connections" [p.30](#)
- "Attaching and Removing the Cable Cover" [p.38](#)
- "Installing Batteries in the Remote Control" [p.39](#)

You can place the projector on almost any flat surface to project an image.

You can also install the projector in a ceiling mount if you want to use it in a fixed location. An optional ceiling mount is required when suspending the projector from a ceiling.

You can also use a commercially available mount compatible with the VESA Mounting Interface Standard (100 × 100 mm).

The projector can be installed at various angles. There is no vertical or horizontal limit to how the projector can be installed.

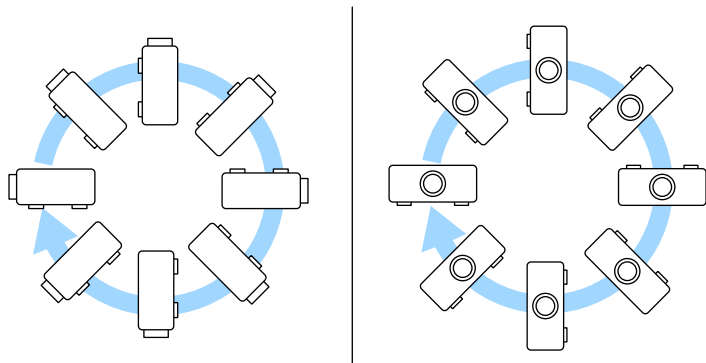

- Leave plenty of space around and under the projector for ventilation, and do not place it on top of or next to anything that could block the vents.
- Place the projector so it squarely faces the screen, not at an angle.

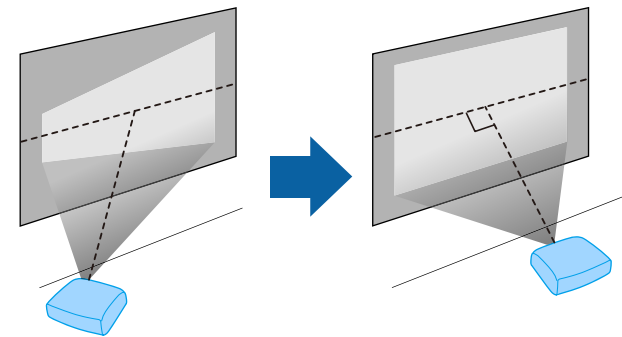

Note the following points when selecting a projector location:

- Place the projector on a sturdy, level surface or install it using a compatible mount.

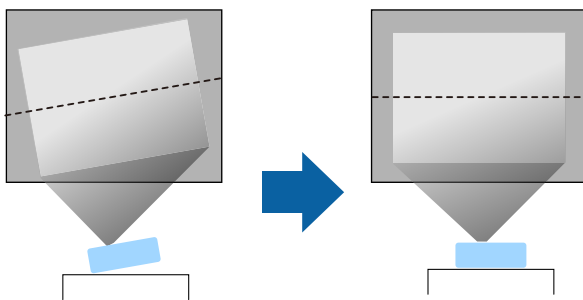

## Warning

- You must install a ceiling mount when suspending the projector from a ceiling. If you do not install the projector correctly, it could fall and cause damage or injury.
- Do not use adhesives on the ceiling mount fixing points to prevent the screws from loosening, or use lubricants, oils, or similar substances on the projector; the projector case may crack causing it to fall from its ceiling mount. This could cause serious injury to anyone under the ceiling mount and could damage the projector.
- Failure to install the ceiling mount and projector may cause the projector to fall. After installing the specific Epson mount that supports your projector, make sure you secure the mount to all of the projector's ceiling mount fixing points. Also, secure the projector and the mounts using wire that is strong enough to hold their weight.
- Do not install the projector in a location subject to high levels of dust or humidity, or in a location subject to smoke or steam. Otherwise, it could cause a fire or electric shock to occur. The projector's case could also deteriorate and be damaged causing the projector to fall from the mount.

### Examples of environments that could cause the projector to fall due to case deterioration

- Locations subject to excessive smoke or airborne oil particles, such as factories or kitchens
- Locations containing volatile solvents or chemicals, such as factories or laboratories
- Locations where the projector could be subjected to detergents or chemicals, such as factories or kitchens
- Locations in which aroma oils are often used, such as relaxation rooms
- Near devices that produce excessive smoke, airborne oil particles, or foam at events

## Warning

- Do not cover the projector's air intake or air exhaust vents. If the vents are covered, the internal temperature could rise and cause a fire.
- Do not use or store the projector in locations where it will be subject to dust or dirt. Otherwise, the quality of the projected image may decline. If the lens or air filter gets dusty, it may result in a malfunction or fire.
- Do not install the projector on an unstable surface or in a location beyond the weight specifications of the projector. Otherwise, it could fall or topple causing an accident and injury.
- When installing the projector in a high position, take measures to prevent falling by using wires to ensure safety in an emergency, such as an earthquake, and to prevent accidents. If it is not installed correctly, it could fall causing an accident and injury.
- Do not install in locations where salt damage could occur, or in locations subject to corrosive gas such as sulphuric gas from hot springs. Otherwise, corrosion could cause the projector to fall. It could also cause the projector to malfunction.

## Attention

- If you are using the projector at altitudes above 1,500 m, set the **High Altitude Mode** setting to **On** in the projector's **Installation** menu to ensure the projector's internal temperature is regulated properly.
- Try not to setup the projector in locations subject to high humidity and dust, or in locations subject to smoke from fires or tobacco smoke.

## » Related Links

- "Notes on Transporting" [p.23](#)
- "Projector Setup and Installation Options" [p.24](#)
- "Projection Distance" [p.26](#)

---

## Notes on Transporting

There are many glass parts and precision components inside the projector. To prevent damage due to impacts when transporting, handle the projector as follows.

- Remove any equipment connected to the projector.

- Center the lens position by turning the vertical and horizontal lens shift dials until they click.
- Attach the lens cover that was included with the projector.
- When transporting the projector a long distance or as checked luggage, pack it in a firm box with cushioning around it and mark the box "Fragile."
- When shipping the projector for repairs, place it in its original packing materials, if possible, or use equivalent materials with cushioning around the projector. Mark the box "Fragile."



Epson shall not be liable for any damages incurred during transportation.

## Projector Setup and Installation Options

You can set up or install your projector in the following ways:

Front/Rear

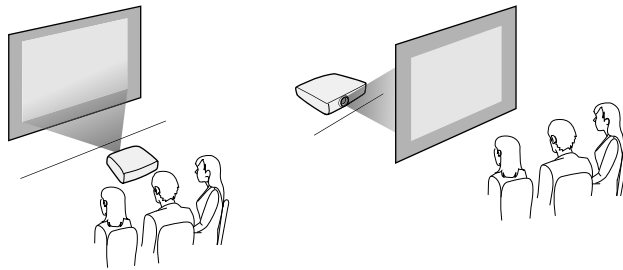

Front Ceiling/Rear Ceiling

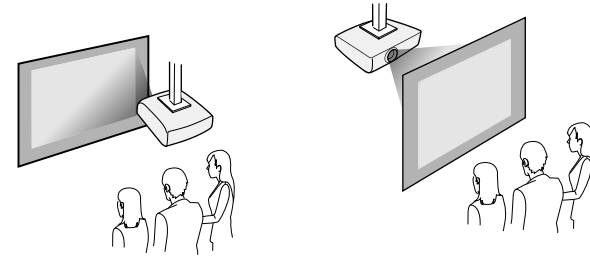

Select the correct **Projection** option in the projector's **Installation** menu according to the installation method being used. If necessary, turn on the **Inv Direction Button** setting in the projector's **Operation** menu and adjust the **Menu Rotation** setting in the projector's **Display** menu.

### ► Related Links

- "Precautions on Installation" [p.24](#)
- "Projection Modes" [p.48](#)

## Precautions on Installation

Note the following precautions when installing the projector.



## Attention

- If the projector is installed at an angle, it should be installed by qualified technicians using mounting hardware designed for use with this projector.
- Install the projector appropriately to prevent it from falling down.
- Use M4 screws (up to a depth of 9 mm) to fix the projector's ceiling mount fixing points and the mounting hardware at four points.

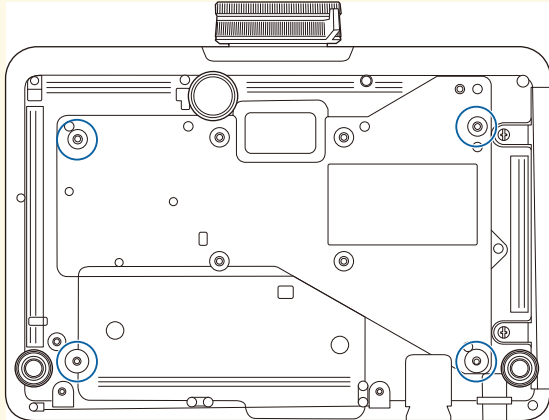

## Installation space

### Attention

Be sure to leave the following amount of space around the projector so as not to block the air exhaust and intake vents.

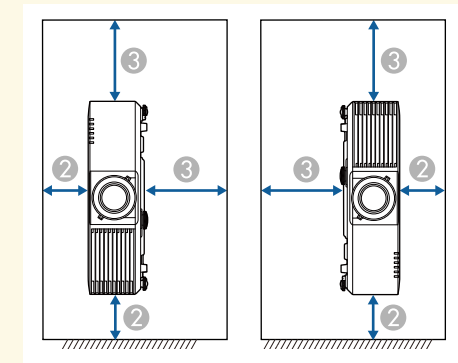
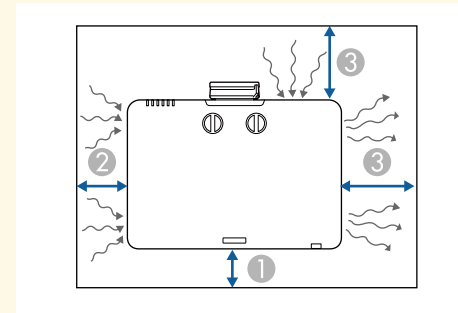

① 10 cm

② 20 cm

③ 40 cm

## Installation space (When installing multiple projectors side by side)

### Attention

- If you are installing multiple projectors next to each other, make sure hot air from the exhaust vent does not go into the air intake vent of another projector.

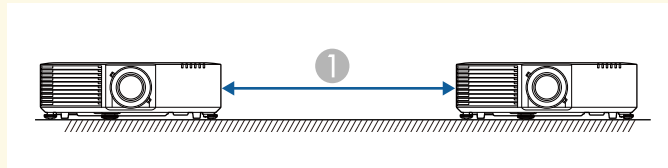

① 150 cm

- If you use a partition, you can narrow the space between the projectors.

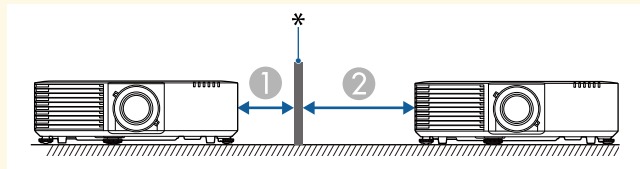

① 20 cm

② 40 cm

\* Partition

See the Appendix for details about how far to place the projector from the screen based on the size of the projected image.

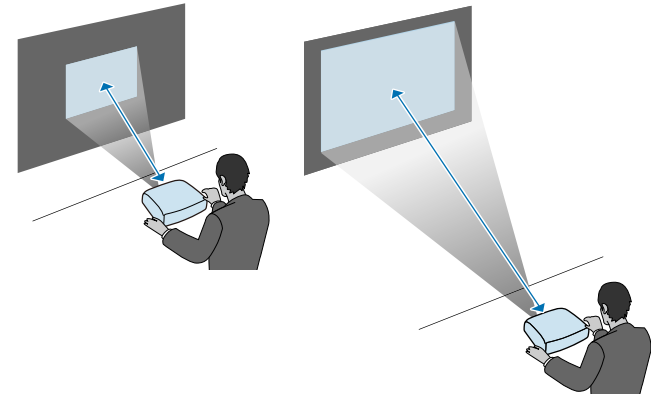

### ► Related Links

- "Screen Size and Projection Distance" [p.245](#)

## Projection Distance

The distance at which you place the projector from the screen determines the approximate size of the image. The image size increases the farther the projector is from the screen, but can vary depending on the zoom factor, aspect ratio, and other settings.

You can install the safety wire to prevent the projector from falling from the ceiling.

## Warning

Be sure to use the safety wire provided with the Epson ceiling mount. The safety wire is available as an optional Safety Wire Set ELPWR01.

### ▶ Related Links

- "When Using the Ceiling Mount ELPMB22" [p.27](#)
- "When Using the Ceiling Mount ELPMB30" [p.28](#)

## When Using the Ceiling Mount ELPMB22

You can attach a safety wire to your projector for increased safety as shown.

Before you start, make sure you have firmly installed the ELPMB22 ceiling mount on the projector and have the following items included in the safety wire set:

- Safety wire × 1
- Carabiner × 2
- Wire clamp × 1
- Attaching screw (M4 × 10 mm) × 1



For details on installing the ELPMB22, see the *Ceiling Mount ELPMB22/ELPMB23 Instruction Manual*.

- 1** Attach a carabiner to the hole on the ceiling mount, and tighten the carabiner lock.

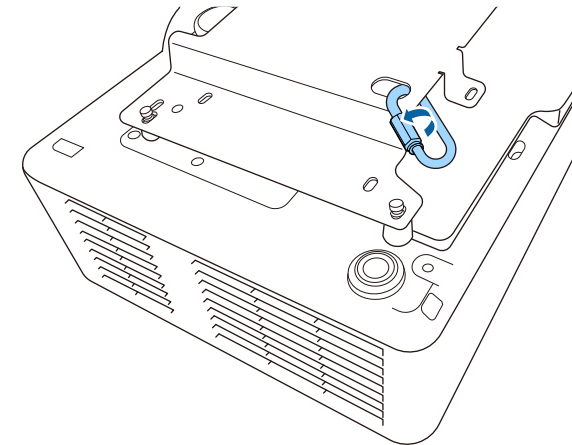

- 2** Attach the wire clamp to another carabiner, and then use the screw to fix the wire clamp to the wire clamp fixing point on the projector.

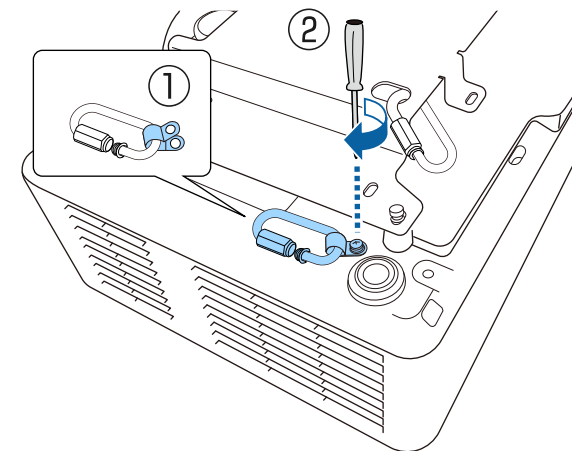

- 3** Loop the safety wire through the carabiner on the ceiling mount, and attach both ends to the carabiner on the projector.

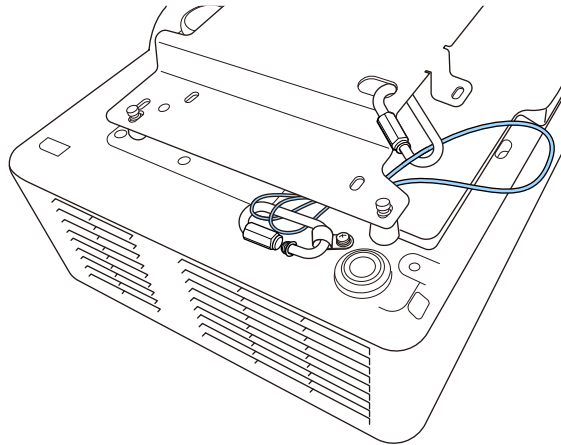

**Warning**

Do not attach the safety wire to the security cable attachment point.

- 4** Tighten the carabiner lock.

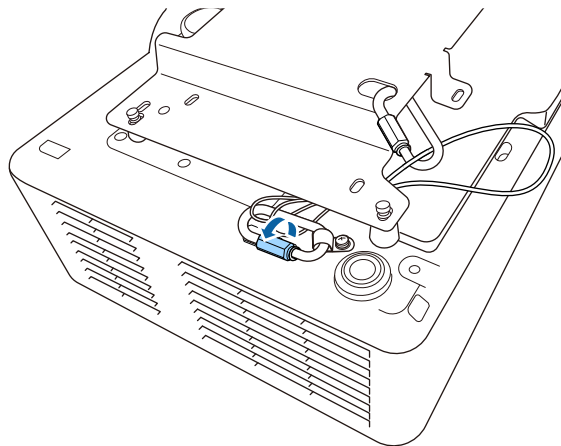

## When Using the Ceiling Mount ELPMB30

You can attach a safety wire to your projector for increased safety as shown. Before you start, make sure you have firmly installed the ELPMB30 ceiling mount on the projector and have the following items included in the safety wire set:

- Safety wire × 1
- Carabiner × 2 (Only one carabiner is used for the ELPMB30.)
- Wire clamp × 1
- Attaching screw (M4 × 10 mm) × 1



For details on installing the ELPMB30, see the *ELPMB30 User's Guide*.

- 1** Attach the wire clamp to the carabiner, and then use the screw to fix the wire clamp to the screw into the wire clamp fixing point on the projector.

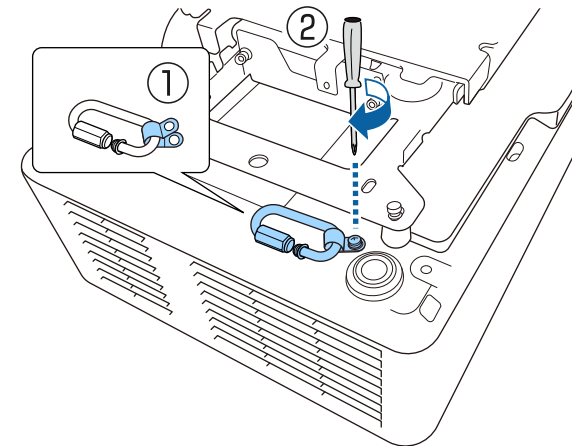

- 2** Loop the safety wire through the hole in the ceiling mount, and then attach both ends to the carabiner.

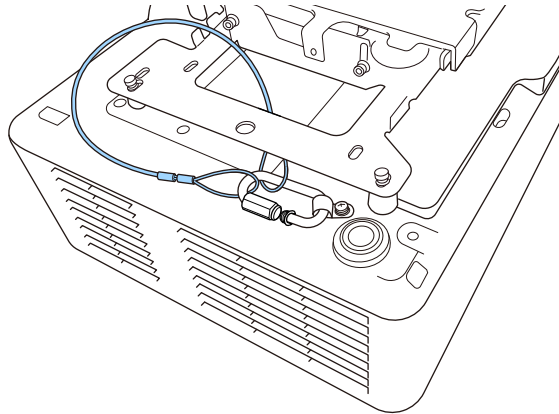

**⚠ Warning**

Do not attach the safety wire to the security cable attachment point.

- 3** Tighten the carabiner lock.

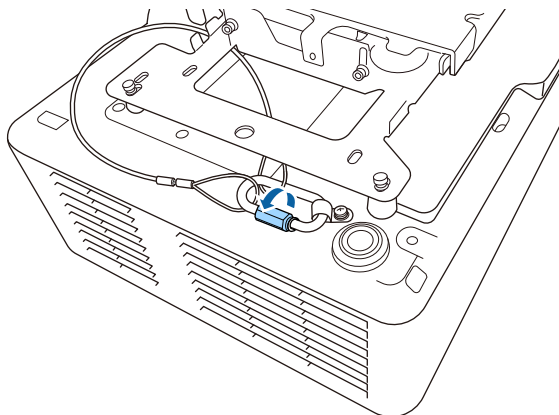

See these sections to connect the projector to a variety of projection sources.

## Attention

Check the shape and orientation of the connectors on any cable you plan to connect. Do not force a connector into a port if it does not fit. The device or your projector could be damaged or could malfunction.



See the *Quick Reference* for a list of cables supplied with your projector. Purchase optional or commercially available cables when necessary.

## ► Related Links

- "Connecting to a Computer" [p.30](#)
- "Connecting to Video Sources" [p.31](#)
- "Connecting to External USB Devices" [p.32](#)
- "Connecting to a Document Camera" [p.33](#)
- "Connecting to a Streaming Media Player" [p.33](#)
- "Connecting to an HDBaseT Transmitter" [p.34](#)
- "Connecting to External Devices" [p.34](#)
- "Connecting Multiple Projectors of the Same Model" [p.36](#)
- "Getting the Latest Version of the Documents" [p.10](#)

## Connecting to a Computer

Follow the instructions in these sections to connect a computer to the projector.

## ► Related Links

- "Connecting to a Computer for VGA Video and Audio" [p.30](#)
- "Connecting to a Computer for HDMI Video and Audio" [p.31](#)

## Connecting to a Computer for VGA Video and Audio

You can connect the projector to your computer using a VGA computer cable.

You can play sound through the projector's speaker system by connecting a commercially available 3.5 mm stereo mini-jack audio cable.



- To connect a computer that does not have a VGA video port, you need an adapter that allows you to connect to the projector's VGA video port.
- To project an image source connected to the Computer2/Monitor Out port, set **Monitor Out Port to Computer2** in the projector's **Signal I/O** menu.
- You can also set the port to input audio when projecting the computer source as the **Audio Output** setting in the projector's **Signal I/O** menu.
- Make sure the audio cable is labeled "No resistance".

- 1** Connect the VGA computer cable to your computer's monitor port.
- 2** Connect the other end to a Computer port on the projector.

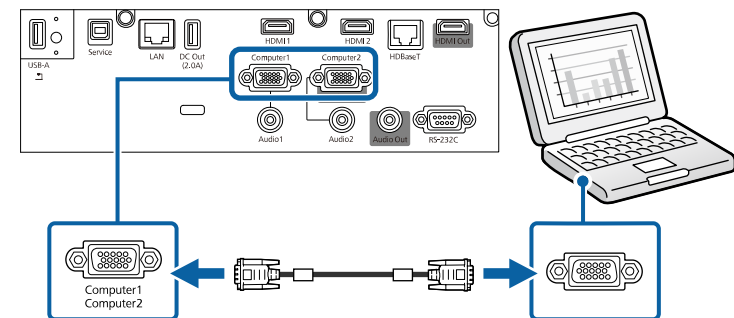

- 3** Tighten the screws on the VGA connector.
- 4** Connect the audio cable to your laptop's headphone or audio-out jack, or your desktop's speaker or audio-out port.

- 5 Connect the other end to the Audio port that corresponds to the Computer port you are using.

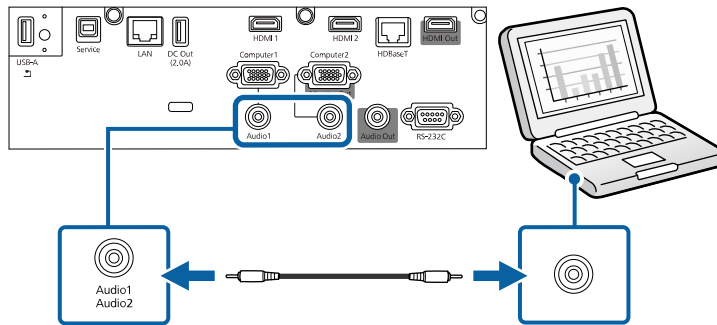

## Connecting to a Computer for HDMI Video and Audio

If your computer has an HDMI port, you can connect it to the projector using an HDMI cable and send the computer's audio with the projected image.

- 1 Connect the HDMI cable to your computer's HDMI output port.
- 2 Connect the other end to the projector's HDMI port.

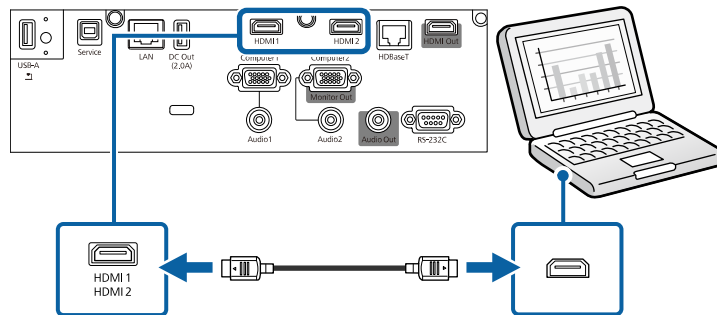

If you have problems hearing audio through the HDMI connection, connect one end of a commercially available 3.5 mm stereo mini-jack audio cable to the projector's Audio port and the other end to your computer's audio out port. Select the audio input port you connected to as the **HDMI Audio Output** setting in the projector's **Signal I/O** menu.

## Connecting to Video Sources

Follow the instructions in these sections to connect video devices to the projector.



- If the port on the device you connect has an unusual shape, use the cable supplied with the device or an optional cable to connect to the projector.
- The cable differs depending on the output signal from the connected video devices.
- Some video devices are capable of outputting different types of signals. See your video device manual to confirm what type of signals can be output.

### » Related Links

- "Connecting to an HDMI Video Source" [p.31](#)

## Connecting to an HDMI Video Source

If your video source has an HDMI port, you can connect it to the projector using an HDMI cable and send the image source's audio with the projected image.

### Attention

Do not turn on the video source before connecting it to the projector. Doing so could damage the projector.

- 1 Connect the HDMI cable to your video source's HDMI output port.

- 2** Connect the other end to the projector's HDMI port.

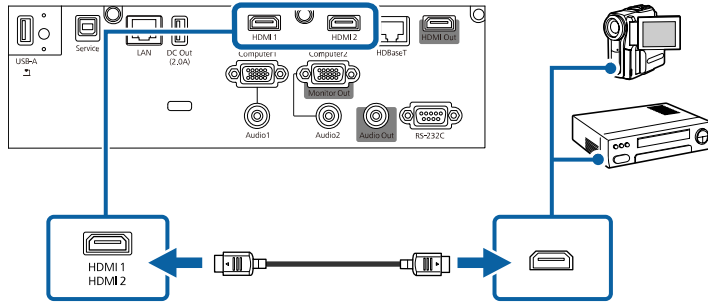

If you have problems hearing audio through the HDMI connection, connect one end of a commercially available 3.5 mm stereo mini-jack audio cable to the projector's Audio port and the other end to your video source's audio out port. Select the audio input port you connected to as the **HDMI Audio Output** setting in the projector's **Signal I/O** menu.

## Connecting to External USB Devices

Follow the instructions in these sections to connect external USB devices to the projector.

### » Related Links

- "USB Device Projection" [p.32](#)
- "Connecting to a USB Device" [p.32](#)
- "Disconnecting a USB Device" [p.33](#)

## USB Device Projection

You can project images and other content without using a computer or video device by connecting any of these devices to your projector:

- USB flash drive
- Digital camera or smartphone

- USB hard drive



- Digital cameras or smartphones must be USB-mounted devices, not TWAIN-compliant devices, and must be USB Mass Storage Class-compliant.
- USB hard drives must meet these requirements:
  - USB Mass Storage Class-compliant (not all USB Mass Storage Class devices are supported)
  - Formatted in FAT16/32
  - Self-powered by their own AC power supplies (bus-powered hard drives are not recommended)
  - Avoid using hard drives with multiple partitions

You can also project playlists that contain images and movies saved on a USB flash drive in Content Playback mode.

### » Related Links

- "Projecting in Content Playback Mode" [p.94](#)
- "Projecting a PC Free Presentation" [p.89](#)

## Connecting to a USB Device

You can connect your USB device to the projector's USB-A port and use it to project images and other content.



- 1** If your USB device came with a power adapter, plug the device into an electrical outlet.



- 2 Connect the USB cable or USB flash drive to the projector's USB-A port as shown.

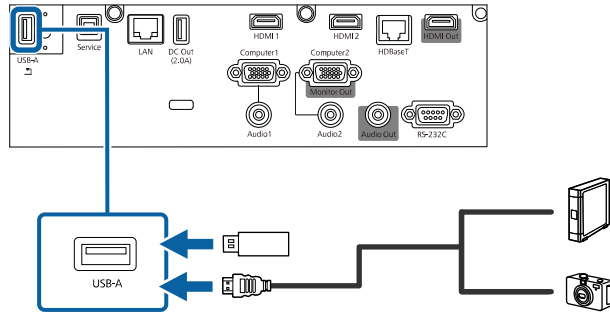

### Attention

- Use the USB cable supplied with or specified for use with the device.
- Do not connect a USB hub or a USB cable longer than 3 meters, or the device may not operate correctly.

- 3 Connect the other end to your device, if necessary.

## Disconnecting a USB Device

When you have finished projecting with a connected USB device, disconnect the device from the projector.

- 1 Turn off and unplug the device, if necessary.
- 2 Disconnect the USB device from the projector.

## Connecting to a Document Camera

You can connect a document camera to your projector to project images viewed by the camera.

The connection method varies depending on your Epson document camera model. See the document camera manual for details.

## Connecting to a Streaming Media Player

You can connect your streaming media player to the projector's HDMI port. By connecting the power supply USB cable, you can power the streaming media player from the projector (EB-L735U/EB-L730U/EB-L635SU/EB-L630SU/EB-L630U/EB-L530U).



To keep supplying power to the optional streaming media player when the projector is not projecting images, select **Always On** as the **USB Power** setting in the projector's **Operation** menu.

- 1 Connect your streaming media player to the projector's HDMI port.

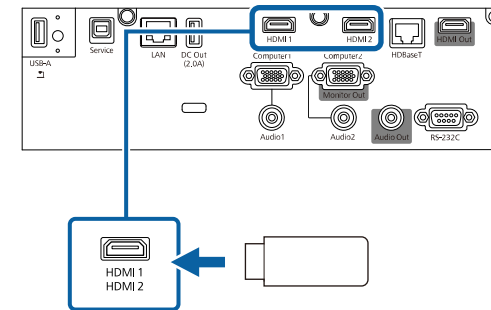

- 2 Connect the power supply USB cable to the projector's DC Out port.

- 3 Connect the other end to the streaming media player's USB port (Type-B).

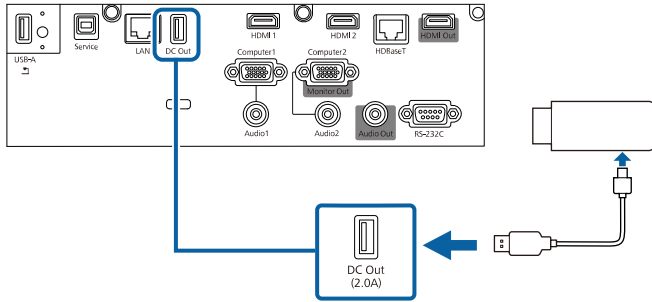

## Connecting to an HDBaseT Transmitter

To send an HDMI or RS-232C signal over a long distance, you can connect the projector to an optional HDBaseT transmitter using a 100Base-TX network cable. This is useful when you want to send a signal to or control the projector from a remote location, such as in a hall or event site, since you can use a network cable up to 100 m in length. To ensure proper data transmission, use a Category 5e STP cable or better. However, operation is not guaranteed for all input/output devices and environments.

- To enable communication from the Ethernet and serial ports on the transmitter, set the **Control Communications** setting to **On** in the projector's **Signal I/O** menu. Turning on this setting disables the projector's LAN and RS-232C ports.
  - ☛ **Signal I/O > HDBaseT > Control Communications**
- If you connected an Extron XTP transmitter or switcher to the projector's HDBaseT port, set the **Extron XTP** setting to **On** in the projector's **Signal I/O** menu.
  - ☛ **Signal I/O > HDBaseT > Extron XTP**
- If you want to control the projector when the projector does not project any images, set the **A/V Output** setting to **Always On** in the projector's **Signal I/O** menu.

- 1 Turn off the projector and HDBaseT transmitter.

Make sure the projector and HDBaseT transmitter are turned off when connecting or disconnecting a network cable between the two devices.

- 2 Connect one end of the network cable to the HDBaseT port on the transmitter.
- 3 Connect the other end to the projector's HDBaseT port.

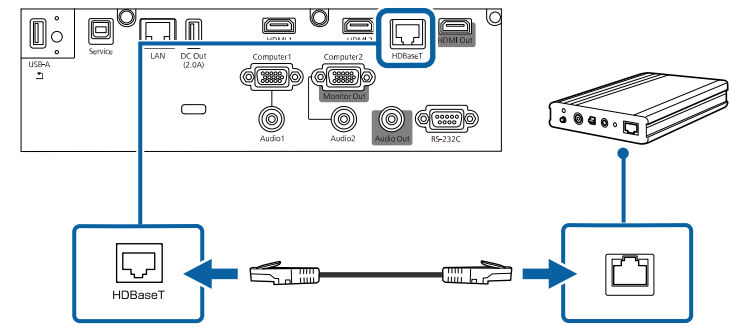

See the documentation that came with the HDBaseT transmitter for instructions on connecting it to your video device or computer.

- 4 Turn on the projector and HDBaseT transmitter.

## Connecting to External Devices

Follow the instructions in these sections to connect external devices to the projector.

- **Related Links**
- "Connecting to an External HDMI Monitor" [p.35](#)
  - "Connecting to a VGA Monitor" [p.35](#)
  - "Connecting to External Speakers" [p.35](#)

## Connecting to an External HDMI Monitor

You can connect an external HDMI monitor to the projector's HDMI Out port and use it to display images from the current input source (EB-L735U/EB-L730U/EB-L635SU/EB-L630SU/EB-L630U/EB-L530U).



- You cannot display the Home screen on an external HDMI monitor.
- You can only display images from a Screen Mirroring source when **HDMI Out Setting** is set to **Off** and **HDMI Out Image Output** is set to **On**.
  - Multi-Projection > HDMI Out Setting
  - Network > Network Settings > Network Projection > Screen Mirroring > HDMI Out Image Output
- When **HDMI Out Setting** is set to **Pass Through**, you can only display images from the HDMI1, HDMI2, and HDBaseT ports.

**1** Connect the HDMI cable to your monitor's HDMI input port.

**2** Connect the other end to the projector's HDMI Out port.

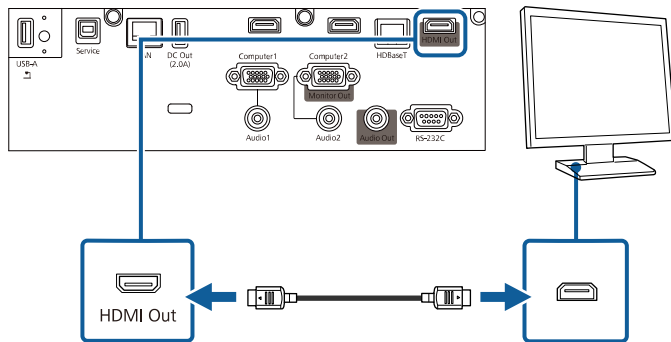

## Connecting to a VGA Monitor

If you connected the projector to a computer using a Computer port, you can also connect an external monitor to the projector. This lets you see your presentation on the external monitor even when the projected image is not visible.

To output images to an external monitor, set the **Monitor Out Port** setting to **Monitor Out** in the projector's **Signal I/O** menu.



- If you want to output images to an external monitor when the projector does not project any images, set the **A/V Output** setting to **Always On** in the projector's **Signal I/O** menu.
- Monitors that use a refresh rate of less than 60 Hz may not be able to display images correctly.

**1** Make sure your computer is connected to the projector's Computer port.



- If there are two computer ports, make sure you use the Computer1 port.
- Only analog RGB signals from the Computer1 port can be output to an external monitor. You cannot output signals input from other ports.

**2** Connect the external monitor's cable to your projector's Monitor Out port.

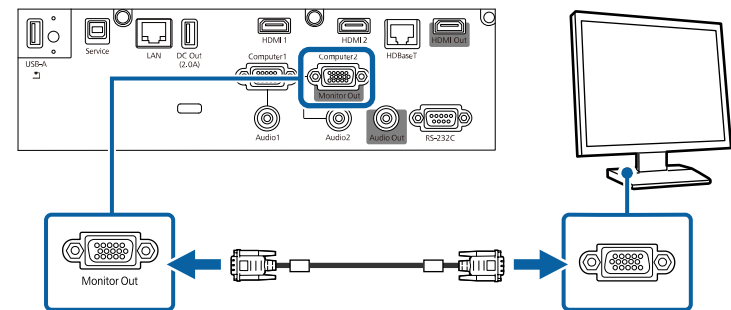

## Connecting to External Speakers

You can connect the projector to external self-powered speakers. You can control the volume using the projector's remote control.

To output audio from external speakers, set the **Audio Out Device** setting to **Projector** in the projector's **Signal I/O** menu. When an audio/video system is not connected to the projector, audio is output from the external speakers even if **Audio Out Device** is set to **AV System**.

☛ **Signal I/O > HDMI Link > Audio Out Device**

- If you want to output audio from the external speakers when the projector does not project any images, set the **A/V Output** setting to **Always On** in the projector's **Signal I/O** menu.
- You can also connect the projector to an amplifier with speakers.
- The projector's built-in speaker system is disabled when you connect external speakers.

- 1** Make sure your computer or video source is connected to the projector with both audio and video cables as necessary.
- 2** Locate the appropriate cable to connect your external speakers, such as a stereo mini-jack-to-pin-jack cable, or another type of cable or adapter.
- 3** Connect one end of the cable to your external speakers as necessary.
- 4** Connect the stereo mini-jack end of the cable to your projector's Audio Out port.

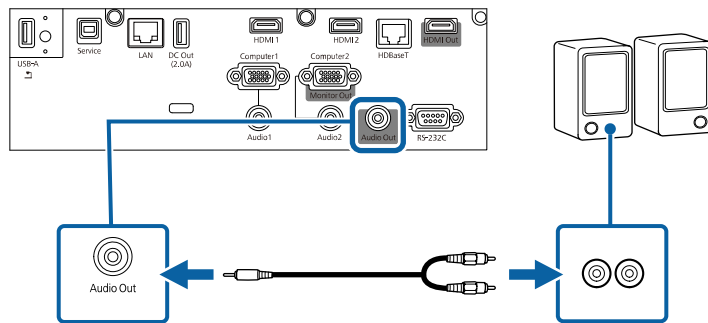

## Connecting Multiple Projectors of the Same Model

You can create a single unified image projected from multiple projectors (EB-L735U/EB-L730U/EB-L635SU/EB-L630SU/EB-L630U/EB-L530U). The image is unified horizontally.

- If you create one large image vertically or connect five or more projectors, you can use the **Tiling** setting in the projector's **Multi-Projection** menu.

- 1** Connect projector to the computer using the HDMI cable or the HDBaseT transmitter using the network cable and then connect the projectors using the HDMI cables as shown.

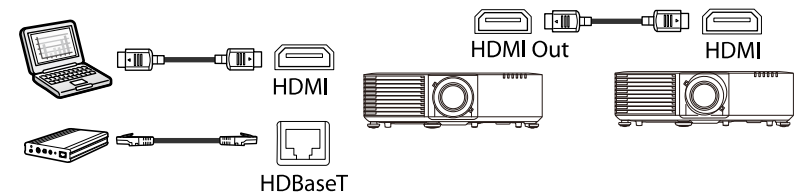

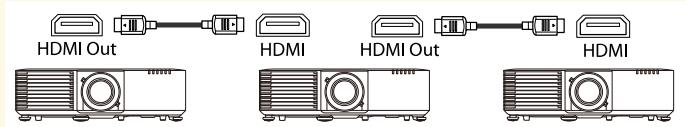
- If you are connecting three or more projectors, connect the projectors in a chain as shown.
- 
- When installing the projectors, make sure hot air from the exhaust vent does not go into the air intake vent of another projector.

- 2** Press the [Menu] button on the control panel or remote control.

- 3** Select the **Color Mode** setting to **Multi-Projection** in the projector's **Image** menu for all of the projectors.
- 4** Select the necessary **HDMI Out Setting** setting in the projector's **Multi-Projection** menu. See the list of settings for more details.
- 5** Select the necessary settings in the projector's **Multi-Projection** menu to create a seamless unified image area.
- 6** Press [Menu] or [Esc] to exit the menus.

» **Related Links**

- "Menu Settings for Multiple Projector Connections" [p.37](#)
- "Precautions on Installation" [p.24](#)
- "Using Multiple Projectors" [p.112](#)

## Menu Settings for Multiple Projector Connections

See the following tables for details on menu settings when you connect multiple projectors to create a horizontally wide screen. You can connect up to four projectors in a chain.

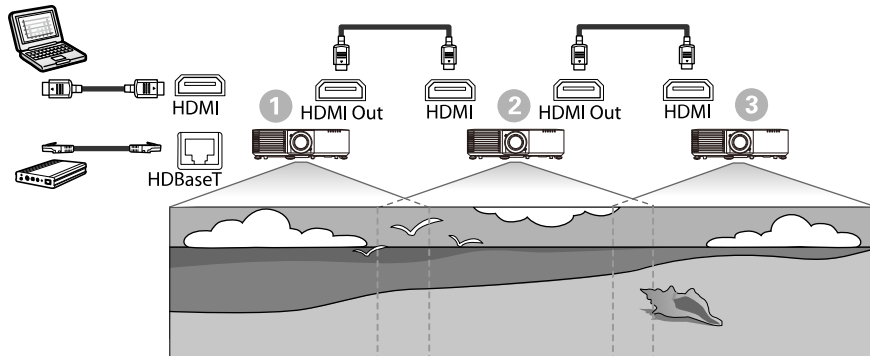

### Image Settings

Setting Item	①	②	③
		Projector on the left (connected to the device)	Projectors in the middle
Color Mode	Multi-Projection	Multi-Projection	Multi-Projection

### Multi-Projection Settings

Setting Item	①	②	③
		Projector on the left (connected to the device)	Projectors in the middle
HDMI Out Setting	Pass Through	Pass Through	Pass Through
Number of Projectors	Specifies the number of projectors connected in a chain		
Order	Specifies the position of this projector in number order from left to right		

When suspending the projector from a ceiling, you can attach the cable cover that came with your projector to hide the attached cables from view (EB-L735U/EB-L730U/EB-L635SU/EB-L630SU/EB-L630U/EB-L530U).

- 1** Pass a commercially available cable tie through the cable holder and tie the cables together.

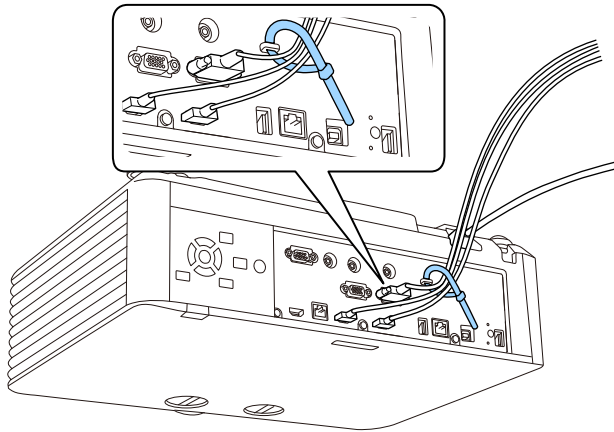

## **⚠ Caution**

Do not bundle the power cord to the other cables. Otherwise, a fire may occur.

- 2** Place the cable cover on the projector as shown, guiding the cables through the notch on the base of the cable cover.

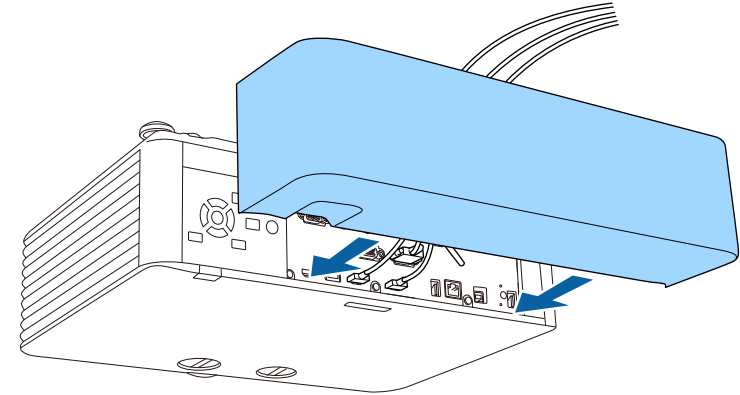

- 3** Tighten the cable cover screws.

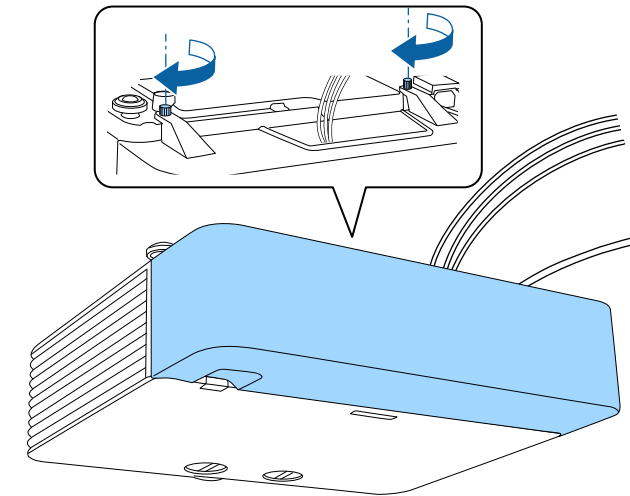

To remove the cover, loosen the cover screws and pull the cover off of the projector.

The remote control uses the two AA batteries that came with the projector.

## Attention

Make sure you read the *Safety Instructions* before handling the batteries.



Replace the batteries as soon as they run out. The remote control uses two AA manganese or alkaline batteries.

- 1** Remove the battery cover as shown.

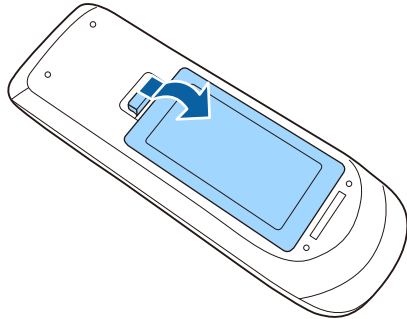

- 2** Remove the old batteries, if necessary.



Dispose of used batteries according to local regulations.

- 3** Insert the batteries with the + and – ends facing as shown.

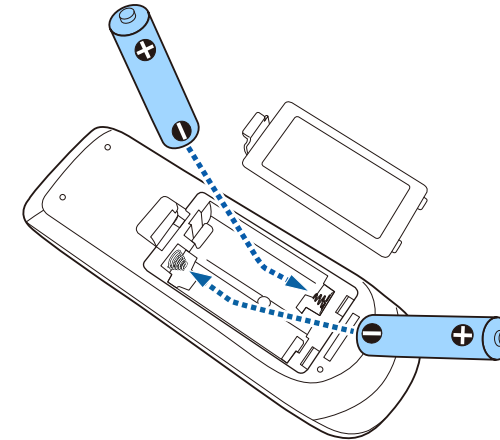

## Warning

Check the positions of the (+) and (–) marks inside the battery holder to ensure the batteries are inserted the correct way. If the batteries are not used correctly, they could explode or leak causing a fire, injury, or damage to the product.

- 4** Replace the battery cover and press it down until it clicks into place.

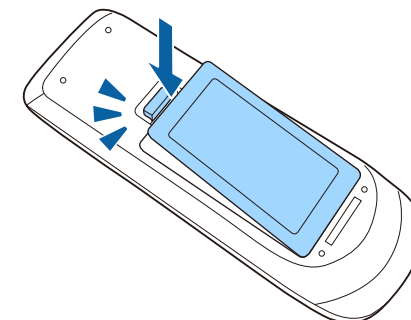

## » Related Links

- "Remote Control Operation" [p.40](#)

## Remote Control Operation

The remote control lets you control the projector from almost anywhere in the room.

Make sure that you aim the remote control at the projector's receivers within the distance and angles listed here.

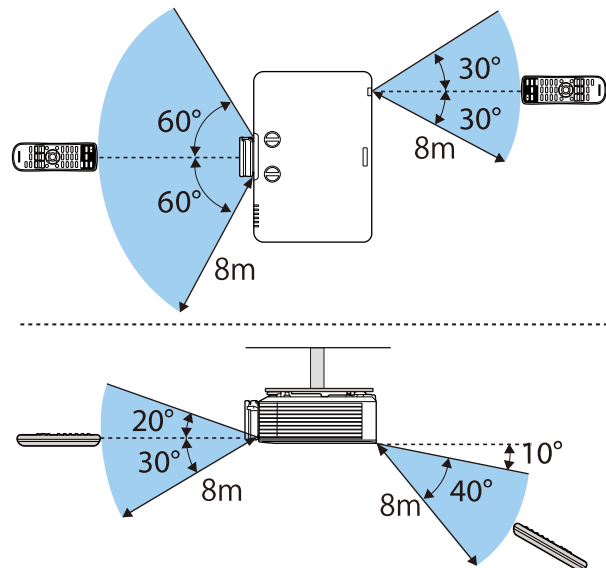

Avoid using the remote control in conditions with bright fluorescent lights or in direct sunlight, or the projector may not respond to commands. If you are not going to use the remote control for a long time, remove the batteries.



# Using Basic Projector Features

Follow the instructions in these sections to use your projector's basic features.

## ► Related Links

- "Turning On the Projector" [p.42](#)
- "Turning Off the Projector" [p.44](#)
- "Setting the Date and Time" [p.45](#)
- "Selecting the Language for the Projector Menus" [p.47](#)
- "Projection Modes" [p.48](#)
- "Setting the Screen Type" [p.50](#)
- "Adjusting the Image Position Using Lens Shift" [p.53](#)
- "Displaying a Test Pattern" [p.55](#)
- "Adjusting the Image Height" [p.56](#)
- "Image Shape" [p.57](#)
- "Resizing the Image with the Zoom Ring" [p.66](#)
- "Reducing the Image Using Digital Zoom" [p.67](#)
- "Focusing the Image Using the Focus Ring" [p.69](#)
- "Selecting an Image Source" [p.70](#)
- "Image Aspect Ratio" [p.72](#)
- "Adjusting Image Quality (Color Mode)" [p.74](#)
- "Turning On Automatic Luminance Adjustment" [p.75](#)
- "Adjusting the Image Color" [p.76](#)
- "Adjusting the Image Resolution" [p.79](#)
- "Adjusting the Brightness" [p.81](#)
- "Controlling the Volume with the Volume Buttons" [p.84](#)

Turn on the computer or video equipment you want to use after you turn on the projector.

- 1** Remove the lens cover.
- 2** Connect the power cord to the projector's power inlet and plug it into an electrical outlet.

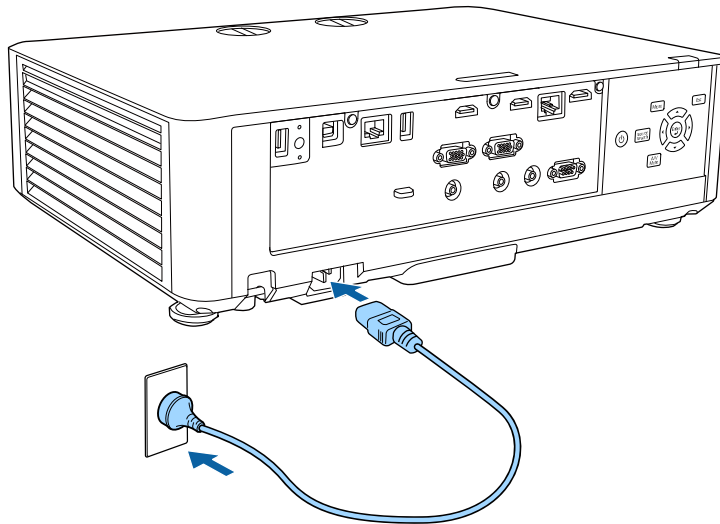

The projector's power indicator turns blue. This indicates that the projector is receiving power, but is not yet turned on (it is in standby mode).

- 3** Press the power button on the control panel or remote control to turn on the projector.

The projector beeps and the status indicator flashes blue as the projector warms up. Once the projector is warmed up, the status indicator stops flashing and turns blue.



- When **Quick Startup** is enabled in the projector's **Operation** menu, the projector becomes ready for use in several seconds the next time you press the power button.

Try the following if you do not see a projected image.

- Turn on the connected computer or video device.
- Change the screen output from the computer when using a laptop computer.
- Insert a DVD or other video media, and press play (if necessary).
- Press the [Source Search] button on the control panel or remote control to detect the source.
- Press the button for the desired video source on the remote control.
- If the Home screen is displayed, select the source you want to project.

## Warning

- Never look into the projector lens when the light source is on. This can damage your eyes and is especially dangerous for children.
- When turning on the projector at a distance using the remote control, make sure there is no one looking into the lens.
- During projection, do not block the light from the projector with a book or other objects. If the light from the projector is blocked, the area on which the light shines becomes hot which could cause it to melt, burn, or start a fire. Also, the lens may get hot due to the reflected light which could cause the projector to malfunction. To stop projection, use the A/V Mute function, or turn off the projector.



- When the **Direct Power On** setting is set to **On** in the projector's **Operation** menu, the projector turns on as soon as you plug it in. Note that the projector also turns on automatically in cases such as recovery from a power outage.
- If you select a specific port as the **Auto Power On** setting in the projector's **Operation** menu, the projector turns on as soon as it detects a signal or cable connection from that port.

## » Related Links

- "Home Screen" [p.43](#)
- "Projector Feature Settings - Operation Menu" [p.189](#)

## Home Screen

The Home screen feature allows you to easily select an image source and access useful functions. You can display the Home screen by pressing the [Home] button on the remote control.



- The Home screen is also displayed when you turn on the projector and no signal is being input.
- When **Connection Guide Display** is set to **On** in the projector's **Network** menu, the connection guide for the wireless transmitter (Epson Wireless Presentation) is displayed instead of the Home screen when no signal is being input.
  - **Network > Transmitter Settings > Connection Guide Display**

Press the arrow buttons on the control panel or remote control to select a menu item, and then press [Enter].

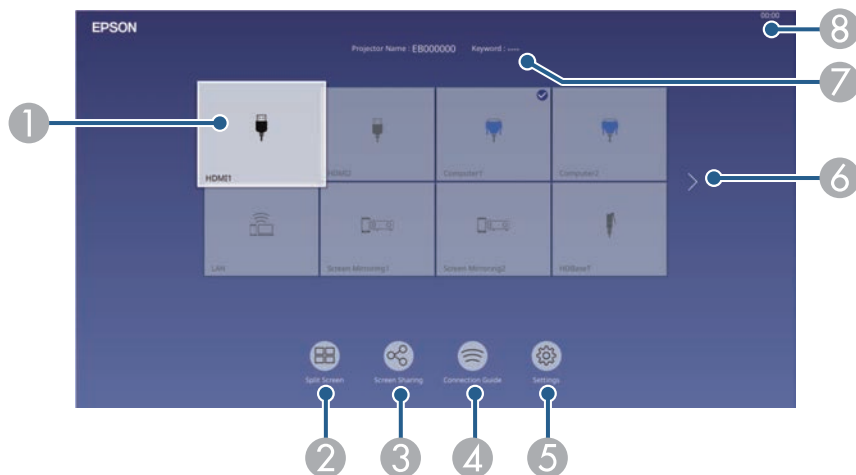

- 1 Selects the source you want to project.  
A check mark appears on the upper right of the current input source.  
You can check a preview of the current input image for most sources as a thumbnail (other than the USB input source in Content Playback mode).
- 2 Projects images from two or four different image sources simultaneously in a grid format.
- 3 Shares your projected screen image with other projectors connected to the same network.
- 4 Displays the connection guide. You can select the wireless connection methods according to the devices you are using, such as smartphones or computers.
- 5 Lets you select the following common projector settings (settings may vary depending on other selected settings):
  - **Color Mode**
  - **Brightness Level**
  - **Volume**
  - **E-Zoom** (EB-L720U/EB-L520U)
  - **Geometry Correction** (H/V-Keystone and Quick Corner are available.)
  - **Aspect**



The **Geometry Correction** setting is only displayed when **Fixed Installation** is set to **Off** and **Geometry Correction** is set to **H/V-Keystone** or **Quick Corner** in the projector's **Installation** menu.

- 6 Moves to the previous or next page if there are more than nine available input sources.
- 7 Displays the projector name and the projector keyword.
- 8 Displays the current time.



The Home screen disappears after 10 minutes of inactivity.

## » Related Links

- "Screen Sharing" [p.152](#)
- "Projecting Multiple Images Simultaneously" [p.86](#)

Turn off the projector after use.



- Turn off this product when it is not in use to prolong the life of the projector. Light source life varies depending on the mode selected, environmental conditions, and usage. Brightness decreases over time.
- If the **Light Source Calibration** setting is set to **Run Periodically** in the projector's **Management** menu, light source calibration starts automatically if you turn off the projector and the following conditions are present:
  - 100 hours have passed since the last light source calibration
  - You have used the projector continuously for more than 20 minutes
- Since the projector supports the direct shutdown feature, it can be turned off directly using the breaker.

- 1** Press the power button on the control panel or remote control.  
The projector displays a shutdown confirmation screen.

Power Off?

Yes: Press  button

No : Press any other button

- 2** Press the power button again. (To leave it on, press any other button.)  
The projector beeps twice, the light source turns off, and the status indicator turns off.
- 3** To transport or store the projector, make sure the power indicator is blue (but not flashing) and the status indicator is off, then unplug the power cord.
- 4** Attach the lens cover.

You can set the date and time for the projector.

- 1 Turn on the projector.
- 2 Press the [Menu] button on the control panel or remote control.
- 3 Select the **Management** setting and press [Enter].

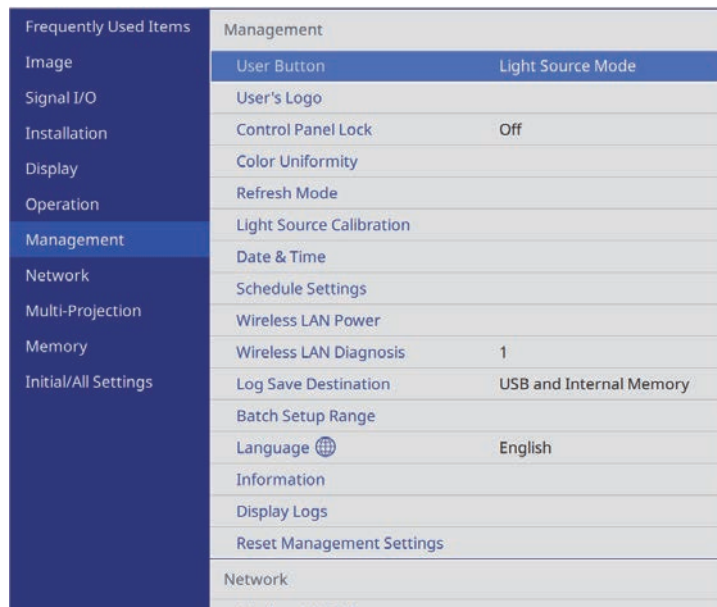

- 4 Select the **Date & Time** setting and press [Enter].
- 5 Select the **Date & Time** setting and press [Enter].

You see this screen:

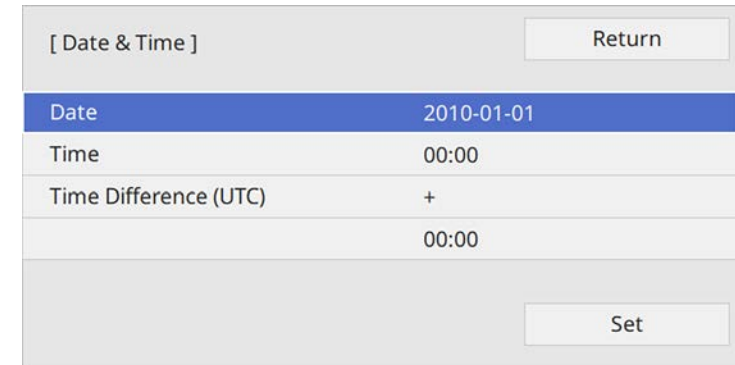

- 6 Select **Date**, press [Enter], and use the displayed keyboard to enter today's date.
- 7 Select **Time**, press [Enter], and use the displayed keyboard to enter the current time.
- 8 Select **Time Difference (UTC)**, press [Enter], and set the time difference from Coordinated Universal Time.
- 9 When you are finished, select **Set** and press [Enter].

- 10** To activate daylight saving time, select the **Daylight Saving Time** setting and set it to **On**. Then select settings.

[ Daylight Saving Time ]		Return
Daylight Saving Time	On	^
DST Adjustment (min)	0	
DST Start		
Month	1	
Week	1	
Day of the Week	Mon	
Time	00:00	
DST End		
Month	1	
Week	1	
Day of the Week	Mon	
Time	00:00	
		Set

- 11** When you are finished, select **Set** and press [Enter].

- 12** To update the time automatically through an Internet time server, select the **Internet Time** setting and set it to **On**. Then select settings.

[ Use Internet Time ]		Return
Use Internet Time	On	^
Internet Time Server	0.0.0.0	
		Set

- 13** When you are finished, select **Set** and press [Enter].

- 14** Press [Menu] or [Esc] to exit the menus.

If you want to view the projector's menus and messages in another language, you can change the **Language** setting.

- 1** Turn on the projector.
- 2** Press the [Menu] button on the control panel or remote control.
- 3** Select the **Management** setting and press [Enter].



Frequently Used Items	Management
Image	User Button Light Source Mode
Signal I/O	User's Logo
Installation	Control Panel Lock Off
Display	Color Uniformity
Operation	Refresh Mode
Management	Light Source Calibration
Network	Date & Time
Multi-Projection	Schedule Settings
Memory	Wireless LAN Power
Initial/All Settings	Wireless LAN Diagnosis 1
	Log Save Destination USB and Internal Memory
	Batch Setup Range
	Language 🌐 English
	Information
	Display Logs
	Reset Management Settings
	Network

- 4** Select the **Language** setting and press [Enter].
- 5** Select the language you want to use and press [Enter].
- 6** Press [Menu] or [Esc] to exit the menus.

Depending on how you positioned the projector, you may need to change the projection mode so your images project correctly.

- **Front** lets you project from a table in front of the screen.
- **Front/Ceiling** flips the image over top-to-bottom to project upside-down from a ceiling or wall mount.
- **Rear** flips the image horizontally to project from behind a translucent screen.
- **Rear/Ceiling** flips the image over top-to-bottom and horizontally to project from a ceiling or wall mount and behind a translucent screen.

» **Related Links**

- "Changing the Projection Mode Using the Remote Control" [p.48](#)
- "Changing the Projection Mode Using the Menu" [p.48](#)
- "Projector Setup and Installation Options" [p.24](#)

## Changing the Projection Mode Using the Remote Control

You can change the projection mode to flip the image over top-to-bottom.

- 1 Turn on the projector and display an image.
- 2 Hold down the [A/V Mute] button on the remote control for 5 seconds.

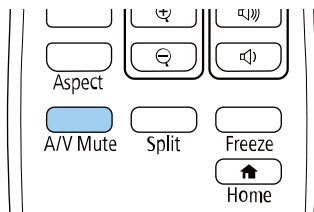

The image disappears briefly and reappears flipped top-to-bottom.

- 3 To change projection back to the original mode, hold down the [A/V Mute] button for 5 seconds again.

## Changing the Projection Mode Using the Menus

You can change the projection mode to flip the image over top-to-bottom and/or left-to-right using the projector menus.

- 1 Turn on the projector and display an image.
- 2 Press the [Menu] button on the control panel or remote control.
- 3 Select the **Installation** menu and press [Enter].

Frequently Used Items	Installation	
Image	Fixed Installation	Off
Signal I/O	Test Pattern	
Installation	Projection	Front/Ceiling
Display	Geometry Correction	Point Correction
Operation	Remote Receiver	Off
Management	Screen Type	16:9
Network	High Altitude Mode	Off
Multi-Projection	Source	Computer1
Memory	Blanking	
Initial/All Settings	Reset to Defaults	
	Reset Installation Settings	
	Display	
	No-signal Screen	Blue
	Startup Screen	On
	Home Screen Auto Disp.	On
	Sort Source Thumbnails	
	Messages	On

- 4 Select **Projection** and press [Enter].



- 5** Select a projection mode and press [Enter].

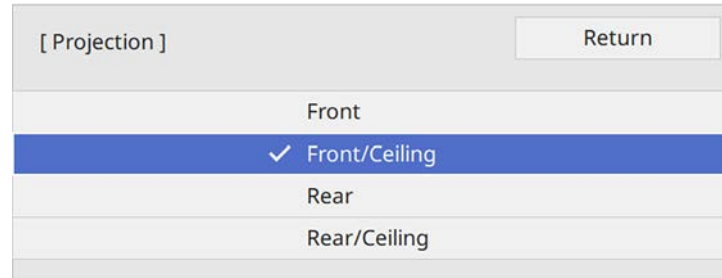

- 6** Press [Menu] or [Esc] to exit the menus.

You can use the **Screen Type** setting to match the aspect ratio of the displayed image to the screen you are using.

 This setting is unavailable when using one of the following input sources:

- USB
- LAN

You cannot change the **Screen Type** setting when the **Content Playback** setting is set to **On** in the projector's **Operation** menu.

If you change the **Screen Type** setting, the **Geometry Correction** settings are initialized.

- 1 Turn on the projector and display an image.
- 2 Press the [Menu] button on the control panel or remote control.
- 3 Select the **Installation** menu and press [Enter].

Frequently Used Items	Installation	
Image	Fixed Installation	Off
Signal I/O	Test Pattern	
Installation	Projection	Front/Ceiling
Display	Geometry Correction	Point Correction
Operation	Remote Receiver	Off
Management	Screen Type	16:9 
Network	High Altitude Mode	Off
Multi-Projection	Source	Computer1
Memory	Blanking	
Initial/All Settings	Reset to Defaults	
	Reset Installation Settings	
	Display	
	No-signal Screen	Blue
	Startup Screen	On
	Home Screen Auto Disp.	On
	Sort Source Thumbnails	
	Messages	On

- 4 Select **Screen Type** and press [Enter].
- 5 Select your screen's aspect ratio and press [Enter].

[ Screen Type ]	Return
4:3	
16:6	
✓ 16:9	
16:10	

- 6 Press [Menu] to exit the menus.

 You may need to restart the projector. Follow the on-screen instructions.

- 7 Adjust the aspect ratio for the projected image, if necessary.

 When the **Screen Type** setting changes, the **EDID** settings are automatically adjusted.

- » **Related Links**
- "Adjusting the Image Position Using Screen Position" [p.50](#)
  - "Changing the Horizontal Position of the Image Using Screen Shift" [p.51](#)

## Adjusting the Image Position Using Screen Position

You can adjust the image position if there are margins between the edge of the image and the projected screen frame.



You cannot adjust the screen position if the **Screen Type** setting is set to **16:10**.

- 1** Turn on the projector and display an image.
- 2** Press the [Menu] button on the control panel or remote control.
- 3** Select the **Installation** menu and press [Enter].

Frequently Used Items	Installation	
Image	Fixed Installation	Off
Signal I/O	Test Pattern	
Installation	Projection	Front/Ceiling
Display	Geometry Correction	Point Correction
Operation	Remote Receiver	Off
Management	Screen Type	16:9
Network	High Altitude Mode	Off
Multi-Projection	Source	Computer1
Memory	Blanking	
Initial/All Settings	Reset to Defaults	
	Reset Installation Settings	
	Display	
	No-signal Screen	Blue
	Startup Screen	On
	Home Screen Auto Disp.	On
	Sort Source Thumbnails	
	Messages	On

- 4** Select **Screen Position**, and press [Enter].

- 5** Use the arrow buttons on the control panel or remote control to adjust the position of the image.

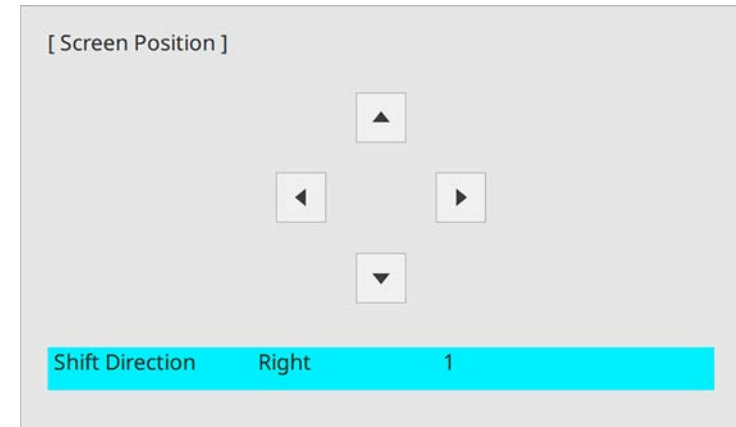

- 6** When you are finished, press [Menu].

## Changing the Horizontal Position of the Image Using Screen Shift

You can specify the horizontal position of the image inside the ultra-wide display when the **Screen Type** is set to **16:6**.

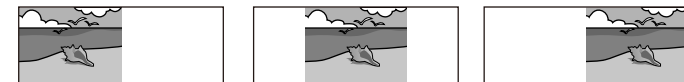

- Available only when **Aspect** is set to **Auto** for the HDMI, Computer, and HDBaseT sources in the projector's **Image** menu.
- Unavailable in the split screen projection.

- 1** Turn on the projector and display an image.

- 2** Press the [4], [5], or [6] button on the remote control.
- 3** Adjust the horizontal position of the projected image by pressing the following numeric buttons on the remote control:
  - [4] to project the image in the left position.
  - [5] to project the image in the center.
  - [6] to project the image in the right position.

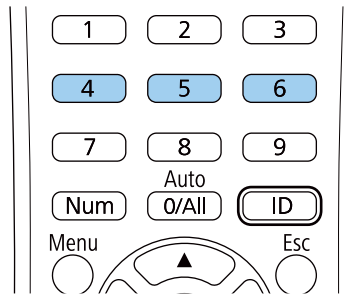

The setting is saved until the projector is turned off.

- 4** When you are finished, press [Esc].

If you cannot install the projector directly in front of the screen, you can adjust the position of the projected image using the lens shift feature (EB-L735U/EB-L730U/EB-L635SU/EB-L630SU/EB-L630U/EB-L530U).

### Attention

When adjusting the image position with the vertical lens shift, adjust it by moving the image from the bottom to the top. If you adjust it from the top to the bottom, the image position may move down slightly after adjusting.



- Wait 20 minutes after turning on the projector before setting the focus, zoom, and lens shift for maximum accuracy.
- Keep the vertical and horizontal lens shift dials in their center positions for the clearest picture.

**1** Turn on the projector and display an image.

**2** Turn the vertical and horizontal lens shift dials on the projector to adjust the position of the projected image as necessary.

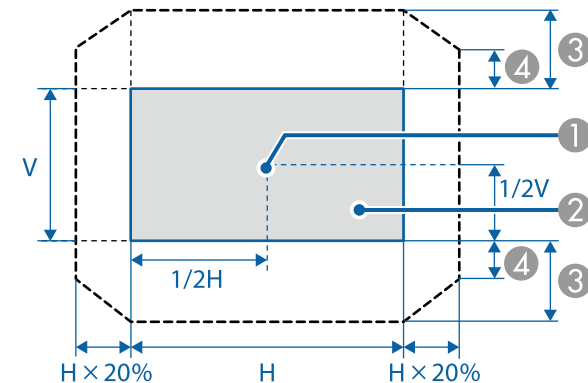
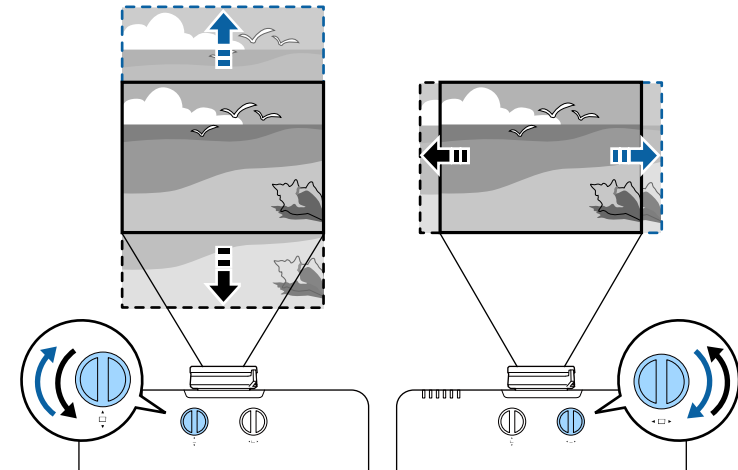

- 1 Center of lens
- 2 Projected image when the lens is set to the home position
- 3 Maximum range:  $V \times 50\%$
- 4 When the horizontal direction is at the maximum value:  $V \times 12\%$



You cannot move the image horizontally when the lens is shifted vertically all the way.

You can display a test pattern to adjust the projected image without connecting a computer or video device.



- The test pattern's shape is determined by the **Screen Type** setting. Be sure to set the correct screen type before adjusting with the test pattern.
- To set menu items that cannot be set while the test pattern is being displayed or to fine-tune the projected image, project an image from the connected device.

**1** Turn on the projector.

**2** Press the down arrow button on the control panel.

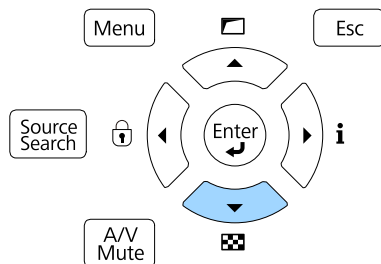

A test pattern is displayed.



You can also display a test pattern from the projector's **Installation** menu.

**3** Press the left or right arrow button on the remote control, or press [Enter] on the control panel to cycle through the available test patterns.

**4** Adjust the image as necessary.

**5** To remove the test pattern, press [Esc].

If you are projecting from a table or other flat surface and the image is too high or low, you can adjust the image height using the projector's adjustable feet.

The larger the angle of tilt, the harder it becomes to focus. Locate the projector so that it only needs to be tilted at a small angle.

- 1 Turn on the projector and display an image.
- 2 To adjust the image height, rotate the front foot to extend or retract it.

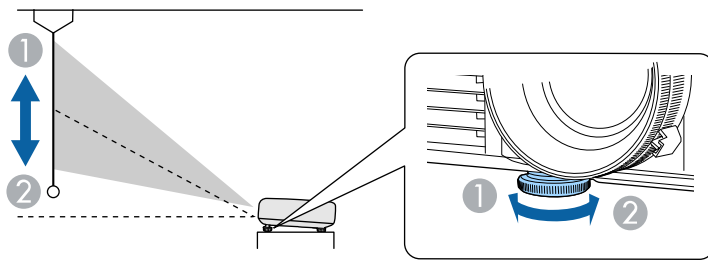

- 1 Extend the front foot
- 2 Retract the front foot

- 3 If the image is tilted, rotate the rear feet to adjust their height.

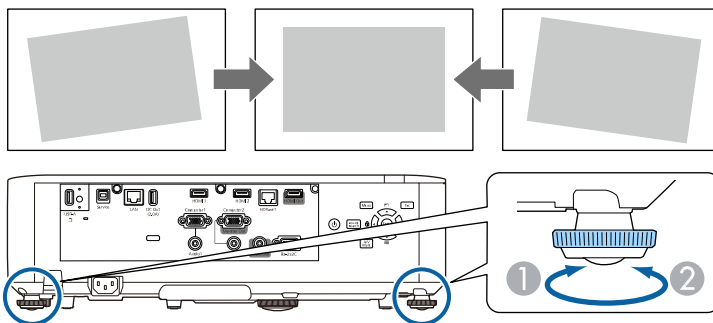

- 1 Extend the rear foot
- 2 Retract the rear foot

If the projected image is unevenly rectangular, you need to adjust the image shape.

## ► Related Links

- "Image Shape" [p.57](#)



You can project an even, rectangular image by placing the projector directly in front of the center of the screen and keeping it level. If you place the projector at an angle to the screen, or tilt it up or down, or off to the side, you may need to correct the image shape.

After correction, your image is slightly smaller.

For the best quality images, we recommend adjusting the installation position of the projector to achieve the correct image size and shape.

### ► Related Links

- "Correcting Image Shape with H/V Keystone" [p.57](#)
- "Correcting the Image Shape with Quick Corner" [p.59](#)
- "Correcting Image Shape with Arc Correction" [p.61](#)
- "Correcting Image Shape with Point Correction" [p.63](#)
- "Loading Image Shape Setting from Memory" [p.65](#)

## Correcting Image Shape with H/V Keystone

You can use the projector's **H/V-Keystone** setting to correct the shape of an image that is unevenly rectangular on the sides.

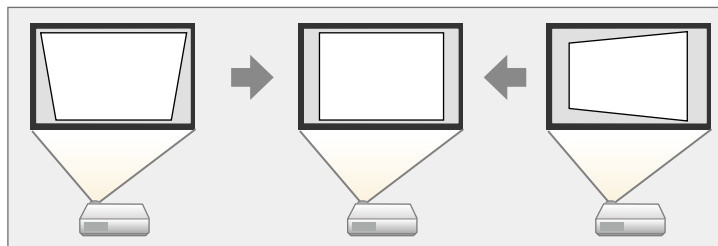

You can correct images up to 30° right, left, up, or down.



- If you need to change the **Screen Type** and **Screen Position** settings, change them first.
- You cannot combine with other correction methods.

- 1 Turn on the projector and display an image.
- 2 Press the [Menu] button on the control panel or remote control.
- 3 Select the **Installation** menu and press [Enter].

Frequently Used Items	Installation	
Image	Fixed Installation	Off
Signal I/O	Test Pattern	
Installation	Projection	Front/Ceiling
Display	Geometry Correction	Point Correction
Operation	Remote Receiver	Off
Management	Screen Type	16:9
Network	High Altitude Mode	Off
Multi-Projection	Source	Computer1
Memory	Blanking	
Initial/All Settings	Reset to Defaults	
	Reset Installation Settings	
	Display	
	No-signal Screen	Blue
	Startup Screen	On
	Home Screen Auto Disp.	On
	Sort Source Thumbnails	
	Messages	On

- 4 Select **Geometry Correction** and press [Enter].  
The **Geometry Correction** screen is displayed.



You can also access the **Geometry Correction** screen by pressing the up arrow button on the control panel.

- 5 Select **H/V-Keystone** and press [Enter]. Then press [Enter] again.

You see the **H/V-Keystone** adjustment screen:

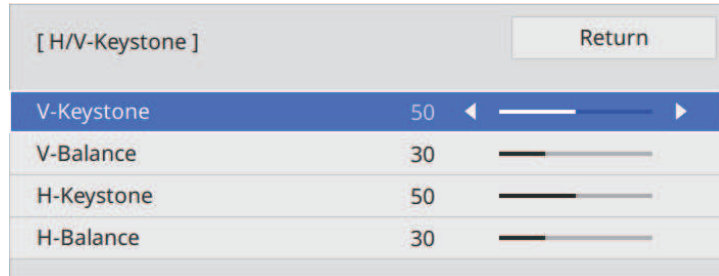

**6** Use the arrow buttons on the projector or the remote control to select between vertical and horizontal keystone correction and to adjust the image shape as necessary.

• **V-Keystone**

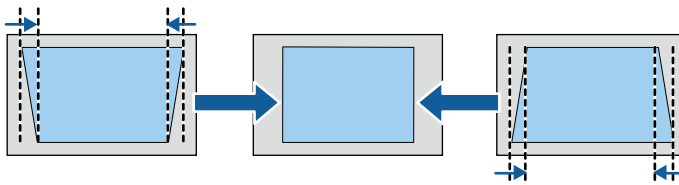

• **H-Keystone**

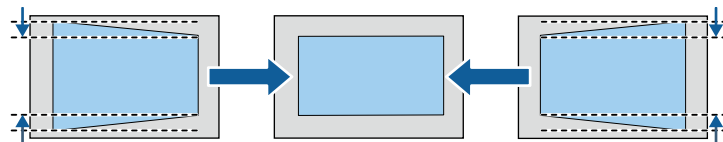

If you have adjusted the position of the projected image by using the lens shift feature, adjust the **V-Balance** and **H-Balance** settings as necessary (EB-L735U/EB-L730U/EB-L635SU/EB-L630SU/EB-L630U/EB-L530U).

• **V-Balance**

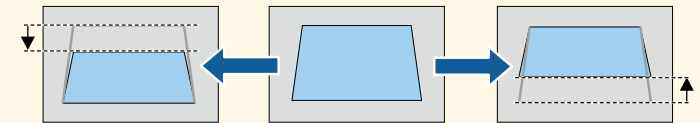

• **H-Balance**

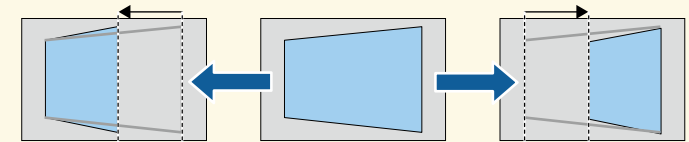

**7** When you are finished, press [Esc].

After correction, your image is slightly smaller.





To save the current shape of an image you have adjusted, select **Save Memory**. You can save up to three image shapes in the memory.

☛ **Installation > Geometry Correction > Memory > Save Memory**

## Correcting the Image Shape with Quick Corner

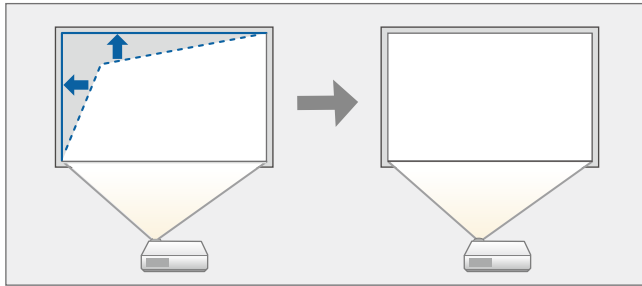
You can use the projector's **Quick Corner** setting to correct the shape and size of an image that is unevenly rectangular.



 If you change the **Screen Type** and **Screen Position** settings, the adjustments are reset.

- 1** Turn on the projector and display an image.
- 2** Press the [Menu] button on the control panel or remote control.

- 3** Select the **Installation** menu and press [Enter].



- 4** Select **Geometry Correction** and press [Enter].  
You see the **Geometry Correction** screen.

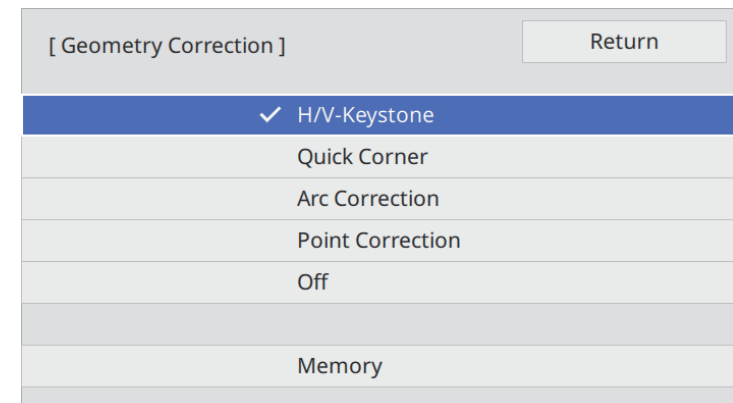

- 5 Select **Quick Corner** and press [Enter]. Then press [Enter] again if necessary.

You see the area selection screen.

- 6 Use the arrow buttons to select the area of the image you want to adjust. Then press [Enter].

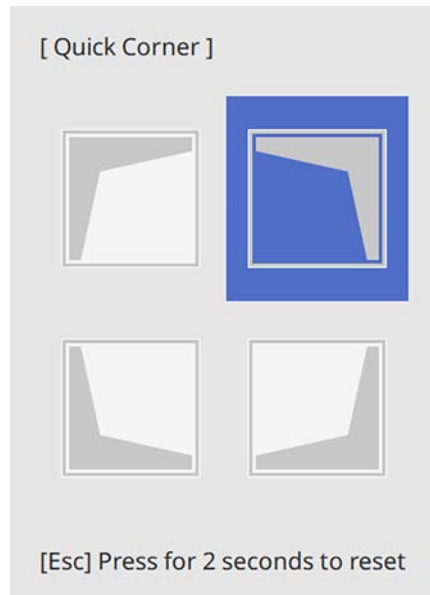

 To reset the **Quick Corner** corrections, hold down [Esc] for about 2 seconds while the area selection screen is displayed, and then select **Yes**.

- 7 Press the arrow buttons to adjust the image shape as necessary. To return to the area selection screen, press [Enter].



- You can also select the area by pressing the following numeric buttons on the remote control:
  - [1] selects the upper left area.
  - [3] selects the upper right area.
  - [7] selects the lower left area.
  - [9] selects the lower right area.
- If you see this screen, you cannot adjust the shape any further in the direction indicated by the gray triangle.

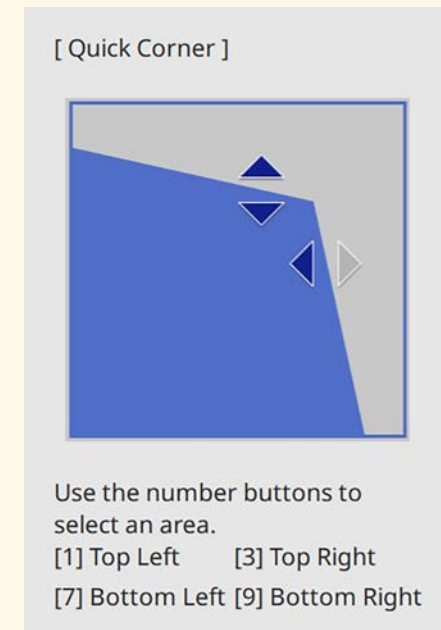

- 8 Repeat steps 6 and 7 as needed to adjust any remaining corners.

- 9 When you are finished, press [Esc].

The **Geometry Correction** setting is now set to **Quick Corner** in the projector's **Installation** menu.

The next time you press the up arrow button on the control panel, the area selection screen is displayed.

 To save the current shape of an image you have adjusted, select **Save Memory**. You can save up to three image shapes in the memory.  
**Installation > Geometry Correction > Memory > Save Memory**

## Correcting Image Shape with Arc Correction

You can use the projector's **Arc Correction** setting to adjust the shape of an image projected on a curved or spherical surface.

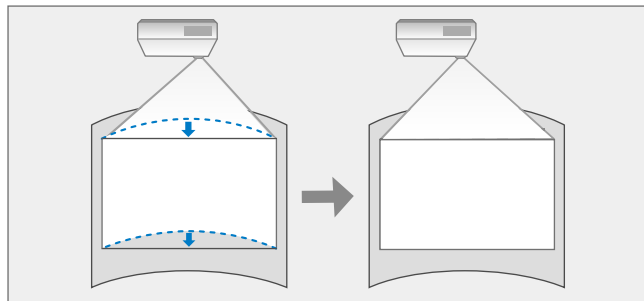

 If you change the **Screen Type** and **Screen Position** settings, the adjustments are reset.

- 1** Turn on the projector and display an image.
- 2** Press the [Menu] button on the control panel or remote control.

- 3** Select the **Installation** menu and press [Enter].

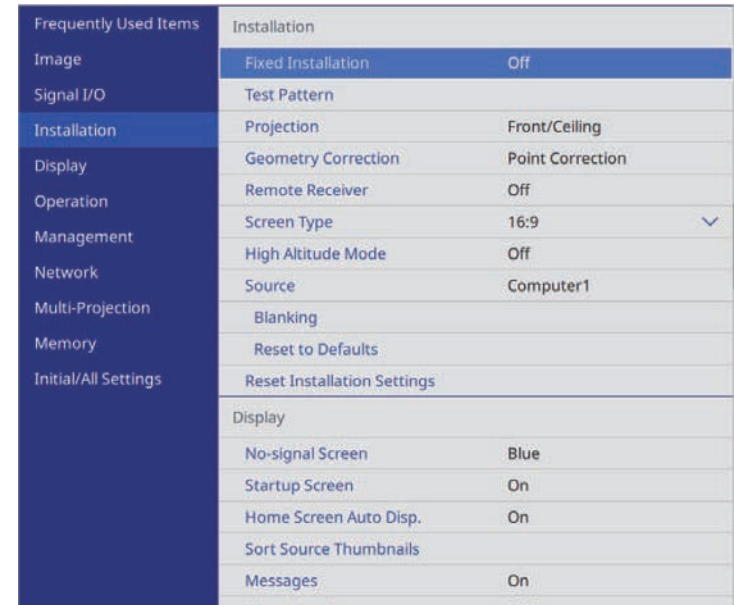

- 4** Select **Geometry Correction** and press [Enter]. You see the **Geometry Correction** screen.

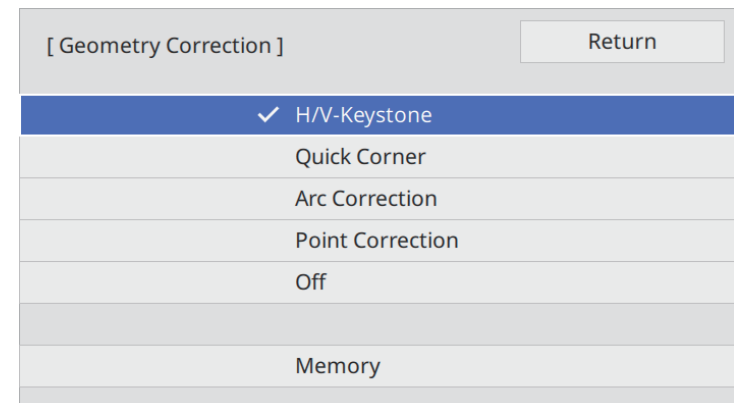

- 5 Select **Arc Correction** and press [Enter].  
You see the **Arc Correction** screen.

- 6 Select **Arc Correction** and press [Enter].

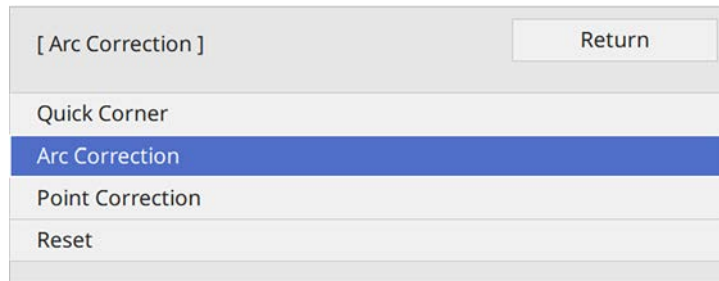

You see the area selection screen.

- 7 Use the arrow buttons to select the area of the image you want to adjust, then press [Enter].

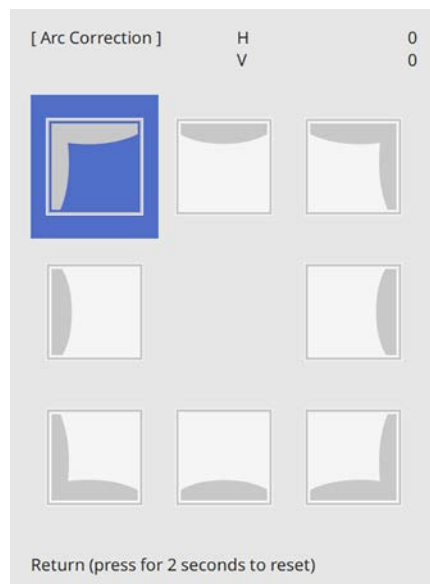

- 8 Press the arrow buttons to adjust the image shape of the selected area as necessary.

To return to the area selection screen, press [Enter].

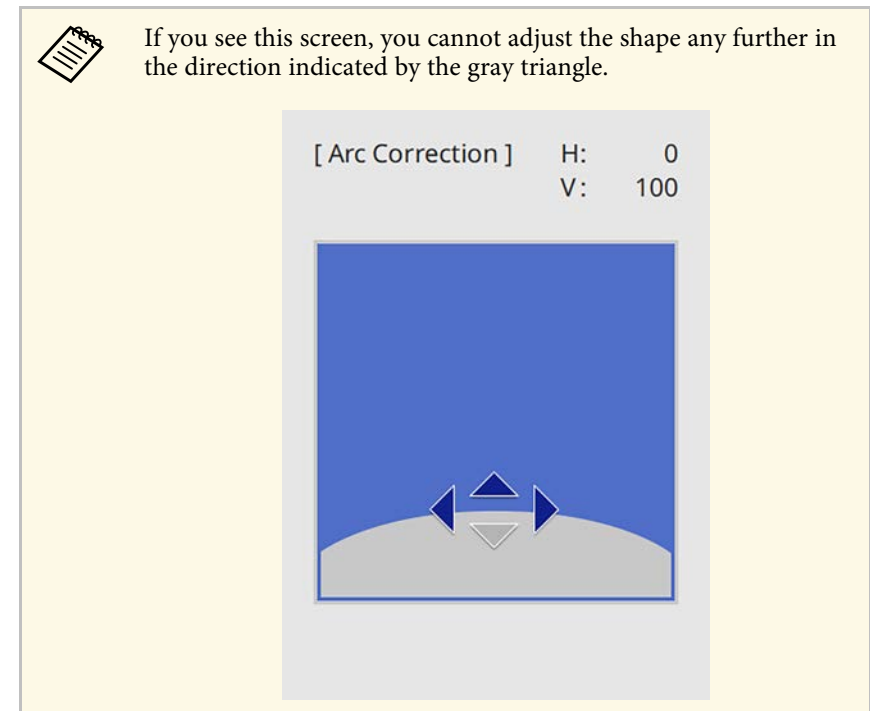

- 9 Repeat steps 7 and 8 as needed to adjust any remaining corners.

- 10 When you are finished, press [Esc].

- You can fine tune the corrected results. Use **Quick Corner** to adjust the tilt of the image, and then use **Point Correction** for fine tuning. Select **Quick Corner** or **Point Correction** on the screen in step 6.
- To save the current shape of an image you have adjusted, select **Save Memory**. You can save up to three image shapes in the memory.
  - ☛ **Installation > Geometry Correction > Memory > Save Memory**
- To reset the **Arc Correction** settings, hold down [Esc] for about 2 seconds while the area selection screen is displayed, and then select **Yes**.

» **Related Links**

- "Correcting the Image Shape with Quick Corner" [p.59](#)
- "Correcting Image Shape with Point Correction" [p.63](#)

## Correcting Image Shape with Point Correction

You can use the projector's **Point Correction** setting to fine-tune the image shape in portions of an image. The image is divided into a grid which allows you to move intersection points on the grid as necessary to correct distortion.

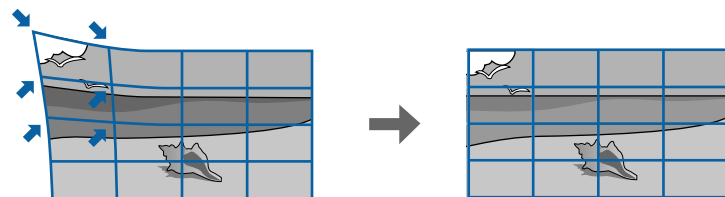

- ☛ If you change the **Screen Type** and **Screen Position** settings, the adjustments are reset.

- 1** Turn on the projector and display an image.
- 2** Press the [Menu] button on the control panel or remote control.

- 3** Select the **Installation** menu and press [Enter].

Frequently Used Items	Installation	
Image	Fixed Installation	Off
Signal I/O	Test Pattern	
Installation	Projection	Front/Ceiling
Display	Geometry Correction	Point Correction
Operation	Remote Receiver	Off
Management	Screen Type	16:9
Network	High Altitude Mode	Off
Multi-Projection	Source	Computer1
Memory	Blanking	
Initial/All Settings	Reset to Defaults	
	Reset Installation Settings	
	Display	
	No-signal Screen	Blue
	Startup Screen	On
	Home Screen Auto Disp.	On
	Sort Source Thumbnails	
	Messages	On

- 4** Select **Geometry Correction** and press [Enter].  
You see the **Geometry Correction** screen.

[ Geometry Correction ]	Return
✓ H/V-Keystone	
Quick Corner	
Arc Correction	
Point Correction	
Off	
Memory	

**5** Select **Point Correction** and press [Enter].

**6** Select **Point Correction** and press [Enter].



 For fine tuning, select **Quick Corner** to correct the shape and size of an image roughly, and then select **Point Correction** to adjust them precisely.

**7** Select the point number and press [Enter].  
You see the grid on the projected image.

 If you want to change the grid color for visibility, press [Esc], then select a different **Pattern Color** setting in the **Point Correction** menu.

**8** Use the arrow buttons to move to the point you want to correct, then press [Enter].

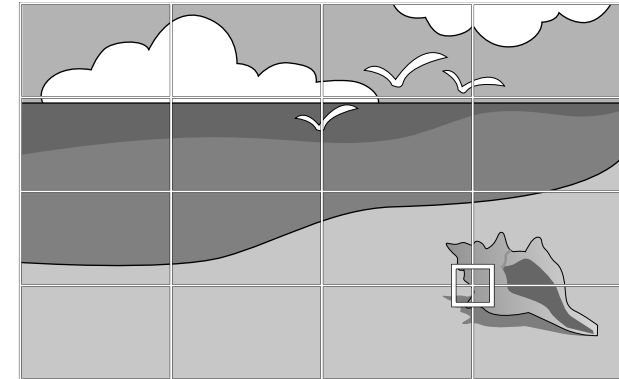

**9** Use the arrow buttons to correct distortion as necessary.

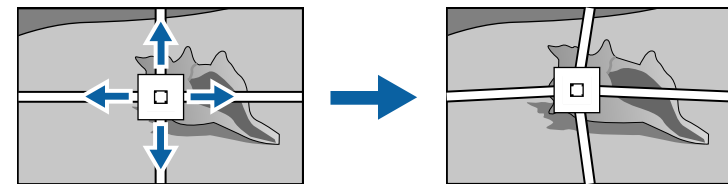

**10** To correct any remaining points, press [Esc] to return to the previous screen, then repeat steps 8 and 9.

**11** When you are finished, press [Esc].

 • To save the current shape of an image you have adjusted, select **Save Memory**. You can save up to three image shapes in the memory.  
 • **Installation > Geometry Correction > Memory > Save Memory**  
 • To reset the **Point Correction** settings to their original positions, select **Reset** on the **Point Correction** screen.



## » Related Links

- "Correcting the Image Shape with Quick Corner" [p.59](#)

## Loading Image Shape Setting from Memory

You can load the image shape settings you selected and saved to the projector's memory and apply them to the current image.

- 1** Turn on the projector and display an image.
- 2** Hold down the [Num] button on the remote control, and then press the numeric button (1, 2, or 3) that matches the number of the saved setting.

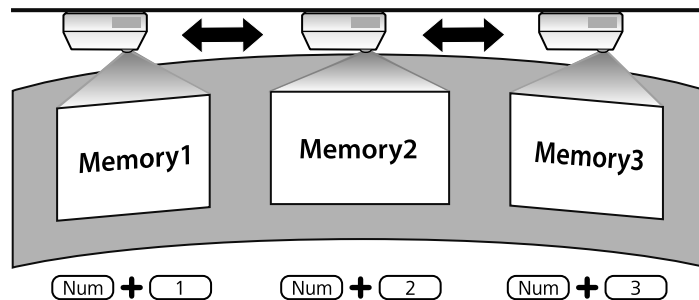

- The illustration above is only an example.
- You can also load the saved image shape settings by selecting **Load Memory** in the **Memory** menu.

- 3** When you have finished loading the settings, follow the on-screen instructions.

You can resize the image using the projector's zoom ring (EB-L735U/EB-L730U/EB-L720U/EB-L630U/EB-L530U/EB-L520U).



Wait 20 minutes after turning on the projector before setting the focus, zoom, and lens shift for maximum accuracy.

- 1** Turn on the projector and display an image.
- 2** Rotate the zoom ring to enlarge or reduce the image.

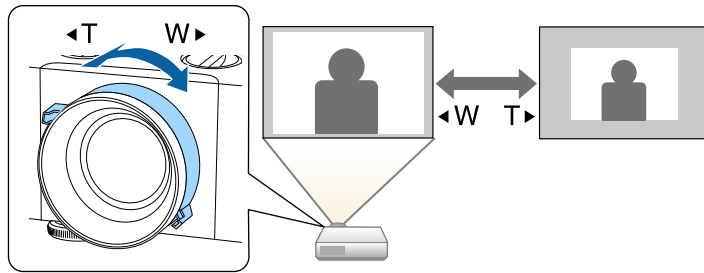

You can resize the image using the projector's **Digital Zoom** (EB-L635SU/EB-L630SU).



Wait 20 minutes after turning on the projector before setting for maximum accuracy.

- 1 Turn on the projector and display an image.
- 2 Press the [Menu] button on the control panel or remote control.
- 3 Select the **Installation** menu and press [Enter].

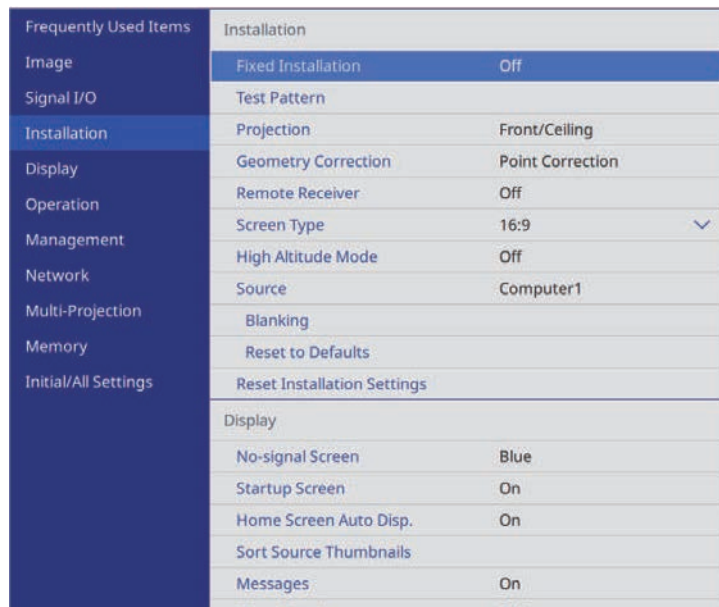

- 4 Select **Digital Zoom** and press [Enter].
- 5 Press the right and left arrow buttons on the remote control or the control panel to adjust the image size.

- 6 When you are finished, press [Esc].

## » Related Links

- "Adjusting the Image Position Using Image Shift" [p.67](#)

## Adjusting the Image Position Using Image Shift

You can use the **Image Shift** feature to adjust the image position without moving the projector (EB-L635SU/EB-L630SU).



- This feature is available when you reduce the image using the Digital Zoom setting.
- We recommend adjusting the image position at least 20 minutes after you start projecting, because images are not stable right after turning on the projector.

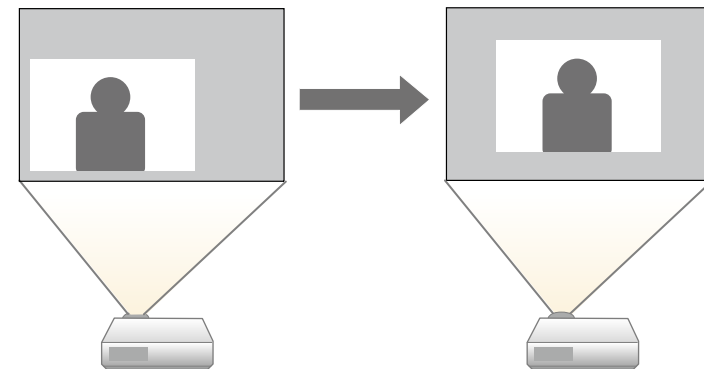

- 1 Turn on the projector and display an image.

- 2** Select the **Installation** menu and press [Enter].



- 3** Select **Image Shift** and press [Enter].

- 4** Use the arrow buttons to adjust the image position.

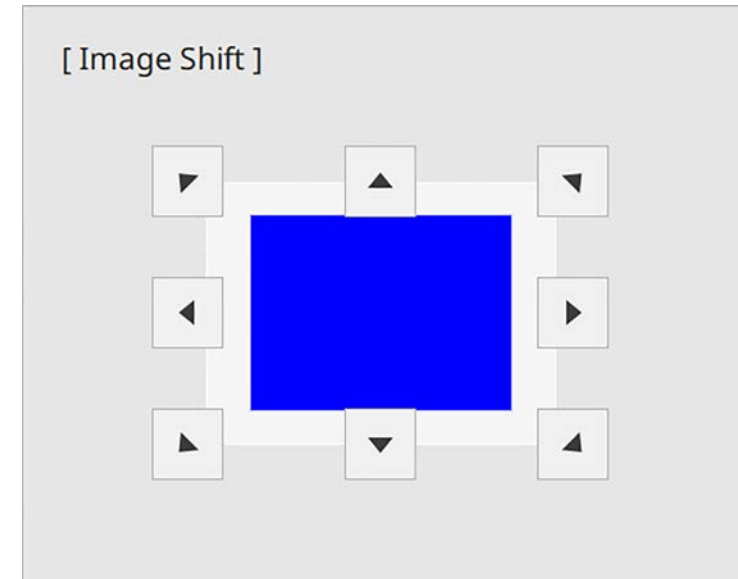

- 5** Press the [Esc] button to close the adjustment screen.  
The adjustment screen disappears if no operation is performed after approximately 10 seconds.



- The **Image Shift** setting is retained even if the projector is turned off. You need to re-adjust the position if you change the installation location or angle of the projector.

You can correct the focus using the focus ring.



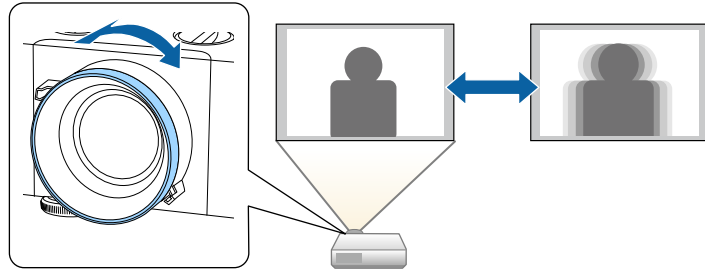

Wait 20 minutes after turning on the projector before setting the focus, zoom, and lens shift for maximum accuracy.

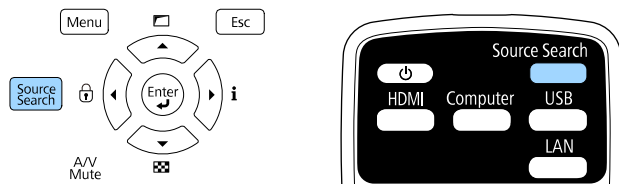

When multiple image sources are connected to the projector, such as a computer and DVD player, you can switch from one image source to the other.

- 1** Make sure the connected image source you want to use is turned on.
- 2** For video image sources, insert a DVD or other video media and press play.
- 3** Do one of the following:
  - Press the [Source Search] button on the control panel or remote control until you see the image from the source you want.



 This screen is displayed when no image signal is detected. Check the cable connections between the projector and image source.

[ Source Search ]	
	Signal Status
HDMI1	Off
HDMI2	Off
HDBaseT	
Computer1	Off
Computer2	Off
USB	Off
LAN	Off
Screen Mirroring1	Off
Screen Mirroring2	Off

Input an image signal.  
Press  to select the source.

- Press the button for the source you want on the remote control. If there is more than one port for that source, press the button again to cycle through the sources.

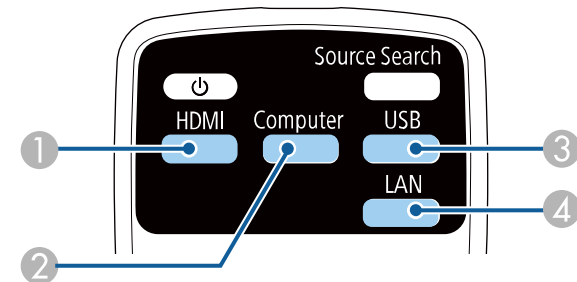

- ① HDMI and HDBaseT sources (HDMI1, HDMI2, and HDBaseT ports)
- ② Computer port source (Computer1 and Computer2 ports)

- ③ USB port source
  - ④ Network source (LAN and Screen Mirroring)
- Press the [Home] button on the remote control.

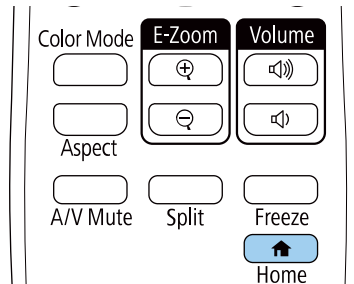

Then select the source you want to use from the screen displayed.

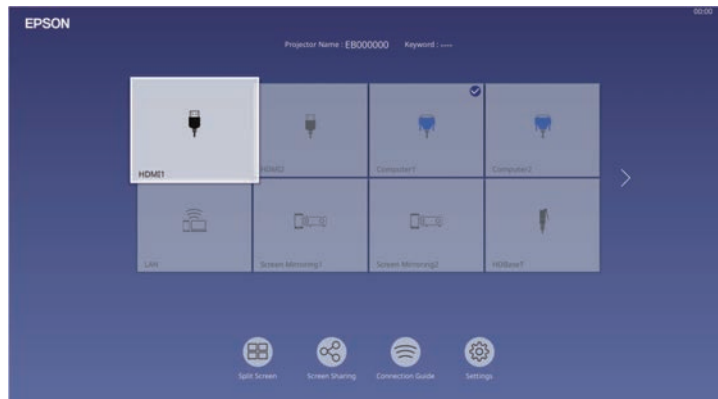

- The display order of the input sources changes when the projector detects an input signal. (The detected input source appears in the upper left position.)
- You can fix the display order of the input sources using the **Sort Source Thumbnails** setting in the projector's **Display** menu.
- A check mark appears on the image from the current input source. You can check a preview of the current input image for most sources as a thumbnail (other than the USB input source in Content Playback mode).
- If there are more than nine available input sources, your desired source may appear on the next page. Select the right arrow to move to the next page.

The projector can display images in different width-to-height ratios called aspect ratios. Normally, the input signal from your video source determines the image's aspect ratio. However, you can change the aspect ratio for certain images to fit your screen.

► **Related Links**

- "Changing the Image Aspect Ratio" [p.72](#)
- "Available Image Aspect Ratios" [p.72](#)

## Changing the Image Aspect Ratio

You can change the aspect ratio of the displayed image.



- Set the **Screen Type** setting in the projector's **Installation** menu before changing the aspect ratio.
- Available only when using one of the following input sources:
  - Computer
  - HDMI
  - HDBaseT
- Available only when the **Scale** setting is turned off or the **Scale Mode** setting is set to **Full Display**.
  - **Image > Scale > Scale Mode**

**1** Turn on the projector and switch to the image source you want to use.

**2** Press the [Aspect] button on the remote control.

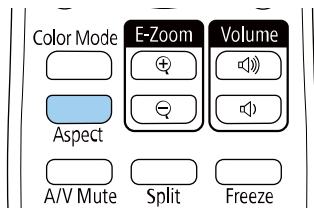

The shape and size of the displayed image changes, and the name of the aspect ratio appears briefly on the screen.

**3** To cycle through the available aspect ratios for your input signal, press the [Aspect] button repeatedly.



- The available aspect ratio setting varies depending on the input signal.
- To display images without black bars, set **Resolution** to **Wide** or **Normal** in the projector's **Image** menu according to the computer's resolution.
- If there are margins between the edge of the image and the projected screen frame, you can adjust the position of the image using the **Screen Position** setting in the projector's **Installation** menu.
  - **Installation > Screen Type > Screen Position**

## Available Image Aspect Ratios

You can select the following image aspect ratios, depending on the selected **Screen Type** setting and the input signal from your image source.



- Note that using the aspect ratio function of the projector to reduce, enlarge, or split the projected image for commercial purposes or for public viewing may infringe upon the rights of the copyright holder of that image based on copyright law.

Aspect mode	Description
Auto	Automatically sets the aspect ratio according to the input signal and the <b>Resolution</b> setting.
Full	Displays images using the full size of the projection area, but does not maintain the aspect ratio.



Aspect mode	Description
H-Zoom V-Zoom (Available when <b>Screen Type</b> is set to <b>4:3</b> , <b>16:9</b> or <b>16:10</b> )	Displays images using the full width (H-Zoom) or full height (V-Zoom) of the projection area and maintains the aspect ratio of the image. Areas that exceed the edges of the projected screen are not projected.
Native (Available when <b>Screen Type</b> is set to <b>4:3</b> , <b>16:9</b> or <b>16:10</b> )	Displays images as is (aspect ratio and resolution are maintained). Areas that exceed the edges of the projected screen are not projected.

The projector offers different color modes to provide optimum brightness, contrast, and color for a variety of viewing environments and image types. You can select the mode designed to match your image and environment, or experiment with the available modes.

## ► Related Links

- "Changing the Color Mode" p.74
- "Available Color Modes" p.74

## Changing the Color Mode

You can change the projector's Color Mode using the remote control to optimize the image for your viewing environment.

- 1** Turn on the projector and switch to the image source you want to use.
- 2** Press the [Color Mode] button on the remote control to change the Color Mode.

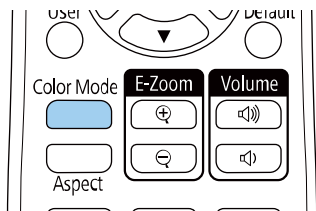

The name of the Color Mode appears briefly on the screen and then image appearance changes.

- 3** To cycle through all of the available color modes for your input signal, press the [Color Mode] button repeatedly.



You can also set the **Color Mode** setting in the projector's **Image** menu.

## Available Color Modes

You can set the projector to use these color modes, depending on the input source you are using:

Color mode	Description
Dynamic	This is the brightest mode. Best for prioritizing brightness.
Presentation	Best for projecting vivid images.
Cinema	Best for enjoying content such as movies.
sRGB	Best for faithfully reproducing the color of the source image.
DICOM SIM	Best for projecting X-ray photographs and other medical images. This mode is for reference purposes only and should not be used to make medical diagnoses.
Multi-Projection	Best for projecting from multiple projectors (reduces the color tone difference between images).

You can turn on Dynamic Contrast to automatically optimize the image luminance. This improves the image contrast based on the brightness of the content you project.

- 1** Turn on the projector and switch to the image source you want to use.
- 2** Press the [Menu] button on the control panel or remote control.
- 3** Select the **Image** menu and press [Enter].

Frequently Used Items	Image	
Image	Color Mode	Presentation
Signal I/O	Brightness	50
Installation	Contrast	50
Display	Color Saturation	50
Operation	Tint	50
Management	Sharpness	50
Network	White Balance	
Multi-Projection	Dynamic Contrast	Off
Memory	Image Enhancement	
Initial/All Settings	Scene Adaptive Gamma	5
	Gamma	0
	RGBCMY	
	Reset to Defaults	
	Source	Computer1
	Resolution	Auto
	Aspect	Auto
	Analog Signal Adjustment	
	Reset to Defaults	

- **High Speed** to adjust brightness as soon as the scene changes.

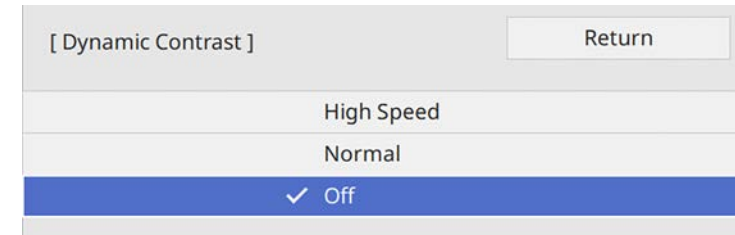

- 6** Press [Menu] or [Esc] to exit the menus.

- 4** Select **Dynamic Contrast** and press [Enter].
- 5** Choose one of the following options and press [Enter]:
  - **Normal** for standard brightness adjustment.

You can fine-tune various aspects of how colors are displayed in your projected images.

► **Related Links**

- "Adjusting the Hue, Saturation, and Brightness" [p.76](#)
- "Adjusting the Gamma" [p.77](#)

## Adjusting the Hue, Saturation, and Brightness

You can adjust the Hue, Saturation, and Brightness settings for individual image colors.

- 1 Turn on the projector and switch to the image source you want to use.
- 2 Press the [Menu] button on the control panel or remote control.
- 3 Select the **Image** menu and press [Enter].

Frequently Used Items	Image	
Image	Color Mode	Presentation
Signal I/O	Brightness	50
Installation	Contrast	50
Display	Color Saturation	50
Operation	Tint	50
Management	Sharpness	50
Network	White Balance	
Multi-Projection	Dynamic Contrast	Off
Memory	Image Enhancement	
Initial/All Settings	Scene Adaptive Gamma	5
	Gamma	0
	RGBCMY	
	Reset to Defaults	
	Source	Computer1
	Resolution	Auto
	Aspect	Auto
	Analog Signal Adjustment	
	Reset to Defaults	

- 4 Select **RGBCMY** and press [Enter].

- 5 Select the color to adjust, and press [Enter].

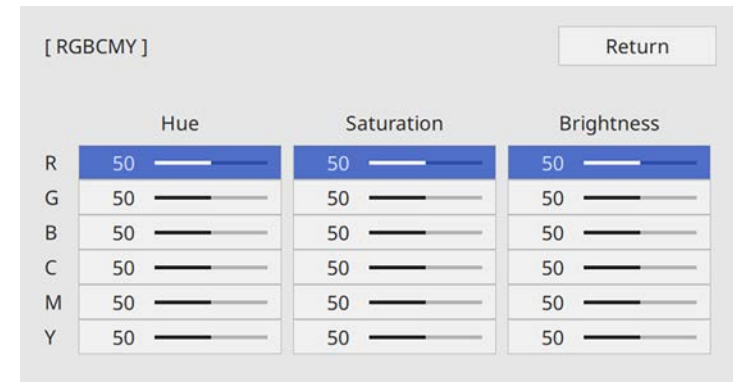

- 6 Do the following as necessary for each setting:
  - To adjust the overall hue of the color, bluish - greenish - reddish, adjust the **Hue** setting.
  - To adjust the overall vividness of the color, adjust the **Saturation** setting.
  - To adjust the overall color brightness of the color, adjust the **Brightness** setting.

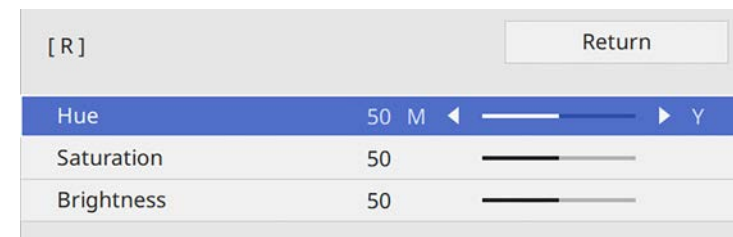

- 7 Press [Menu] or [Esc] to exit the menus.

## Adjusting the Gamma

You can correct differences in projected image colors that occur between different image sources by adjusting the Gamma setting.

 To optimize the color tone according to the scene, and to obtain a more vivid image, correct the image by adjusting the **Scene Adaptive Gamma** setting.

- 1** Turn on the projector and switch to the image source you want to use.
- 2** Press the [Menu] button on the control panel or remote control.
- 3** Select the **Image** menu and press [Enter].

Frequently Used Items	Image	
Image	Color Mode	Presentation
Signal I/O	Brightness	50
Installation	Contrast	50
Display	Color Saturation	50
Operation	Tint	50
Management	Sharpness	50
Network	White Balance	
Multi-Projection	Dynamic Contrast	Off
Memory	Image Enhancement	
Initial/All Settings	Scene Adaptive Gamma	5
	Gamma	0
	RGBCMY	
	Reset to Defaults	
	Source	Computer1
	Resolution	Auto
	Aspect	Auto
	Analog Signal Adjustment	
	Reset to Defaults	

- 4** Select **Gamma** and press [Enter].

- 5** Select and adjust the correction value.

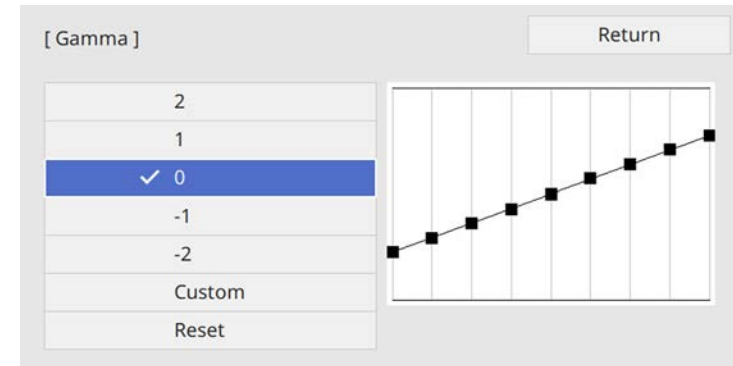

When you select a smaller value, you can reduce the overall brightness of the image to make the image sharper. When you select a larger value, the dark areas of images become brighter, but the color saturation for lighter areas may become weaker.

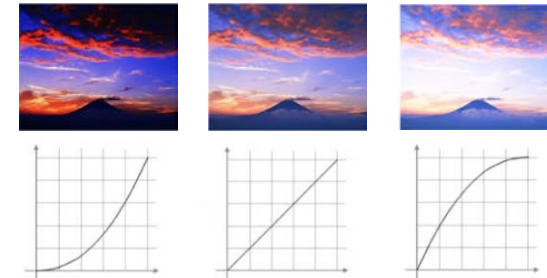



- If you set the **Color Mode** setting to **DICOM SIM** in the projector's **Image** menu, select the adjustment value according to the projection size.
- If the projection size is 120 inches or less, select a small value.
- If the projection size is 120 inches or more, select a large value.
- Medical images may not be reproduced correctly depending on your settings and screen specifications.

**6** If you want to make finer adjustments, select **Custom** and press [Enter].

**7** Press the left or right arrow buttons to select the color tone you want to adjust on the gamma adjustment graph. Then press the up or down arrow button to adjust the value and press [Enter].

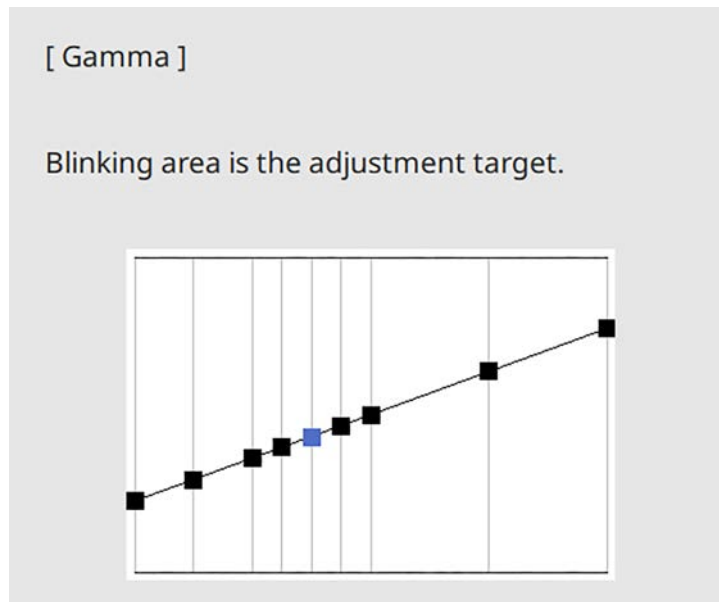

**8** Press [Menu] or [Esc] to exit the menus.

You can adjust the resolution of the image to reproduce a clear image with an emphatic texture and material feel.

- 1 Turn on the projector and switch to the image source you want to use.
- 2 Press the [Menu] button on the control panel or remote control.
- 3 Select the **Image** menu and press [Enter].

Frequently Used Items	Image	
Image	Color Mode	Presentation
Signal I/O	Brightness	50
Installation	Contrast	50
Display	Color Saturation	50
Operation	Tint	50
Management	Sharpness	50
Network	White Balance	
Multi-Projection	Dynamic Contrast	Off
Memory	Image Enhancement	
Initial/All Settings	Scene Adaptive Gamma	5
	Gamma	0
	RGBCMY	
	Reset to Defaults	
	Source	Computer1
	Resolution	Auto
	Aspect	Auto
	Analog Signal Adjustment	
	Reset to Defaults	

- 4 Select **Image Enhancement** and press [Enter].

- 5 Select **Image Preset Mode** and press [Enter].

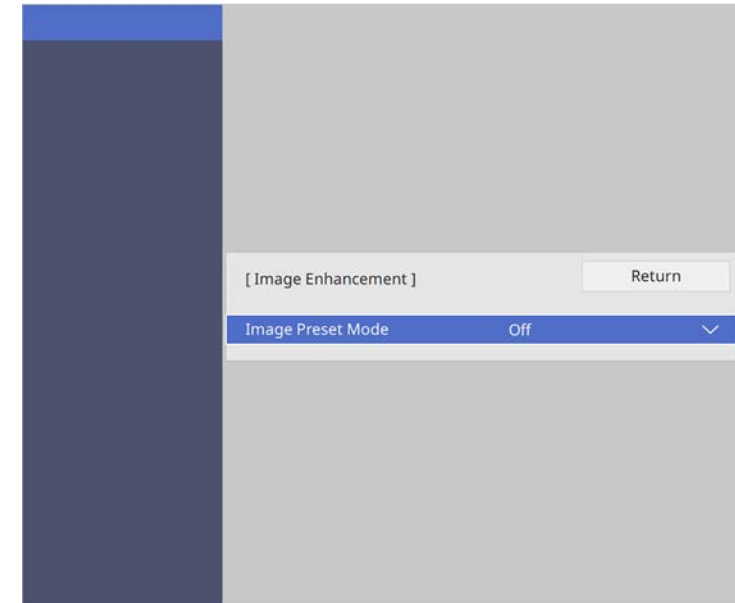

- 6 Select the preset option and press [Enter].

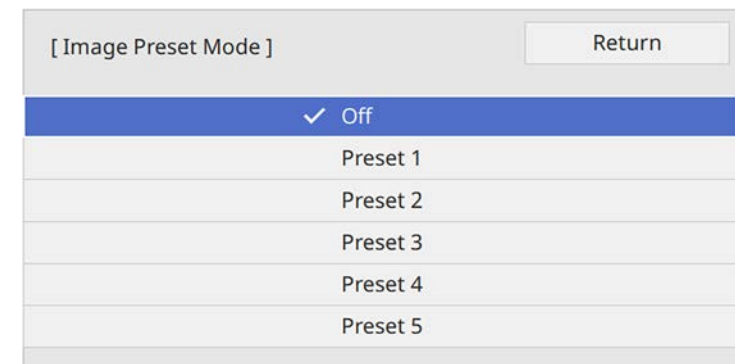

The following settings saved in the preset option are applied to the image.

- **Noise Reduction**
- **MPEG Noise Reduction**
- **Deinterlacing**
- **Super-resolution**
- **Detail Enhancement**

**7** Adjust each setting in the projector's **Image** menu individually as necessary.

- To reduce flickering in images, adjust the **Noise Reduction** setting.
- To reduce the noise or artifacts seen in MPEG video, adjust the **MPEG Noise Reduction** setting.
- To convert interlaced-to-progressive signals for certain video image types, adjust the **Deinterlacing** setting.
  - **Off**: for fast-moving video images.
  - **Video**: for most video images.
  - **Film/Auto**: for movies, computer graphics, and animation.



Setting is only displayed when the current signal is interlaced signal (480i/576i/1080i).

- To reduce blurring appeared when projecting low resolution image, adjust the **Super-resolution** setting.
- To create a more emphatic texture and material feel of the image, adjust the **Detail Enhancement** setting.



The settings value in the preset option are overwritten.

**8** Press [Menu] or [Esc] to exit the menus.



You can adjust the brightness of your projector's light source.

- 1 Turn on the projector and switch to the image source you want to use.
- 2 Press the [Menu] button on the control panel or remote control.
- 3 Select the **Operation** menu and press [Enter].

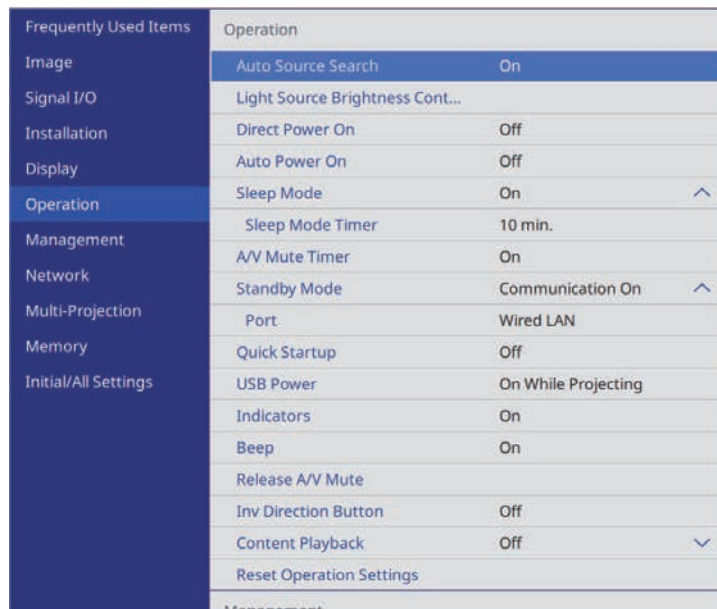

- 4 Select **Light Source Brightness Control** and press [Enter].

- 5 If you want to maintain the brightness at a specific level, select the **Maintain Brightness** setting and select **On**.

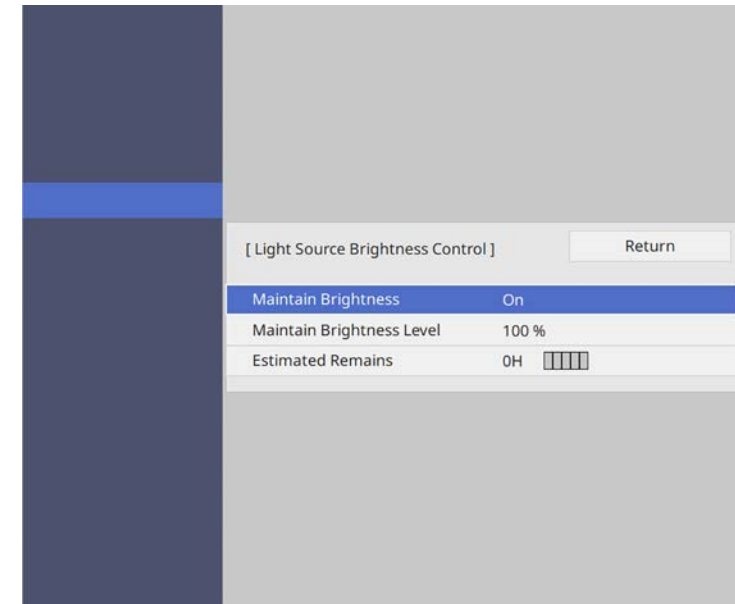

- 6 If you turn on **Maintain Brightness**, select the **Maintain Brightness Level** setting and check the **Estimated Remains** information.

- 7 If you turn off **Maintain Brightness**, select the **Light Source Mode** setting:

- **Normal** lets you set the brightness to the maximum level. This makes the light source operation time approximately 20,000 hours.
- **Quiet** lets you set the brightness to 70% and reduces fan noise. This makes the light source operation time approximately 20,000 hours.
- **Extended** lets you set the brightness to 70% and extends the life expectancy of the light source. This makes the light source operation time approximately 30,000 hours.

- **Custom** lets you to select a custom brightness level between 70 to 100%.

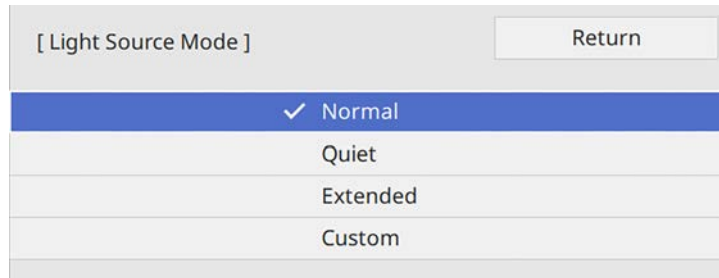

**8** If you set the **Light Source Mode** setting to **Custom**, select **Brightness Level** and use the left and right arrow buttons to select the brightness.

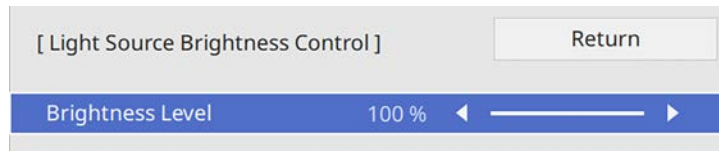

**9** Press [Menu] or [Esc] to exit the menus.

 For the best results in maintaining a constant brightness, set the **Light Source Calibration** setting to **Run Periodically** in the projector's **Management** menu.





» **Related Links**

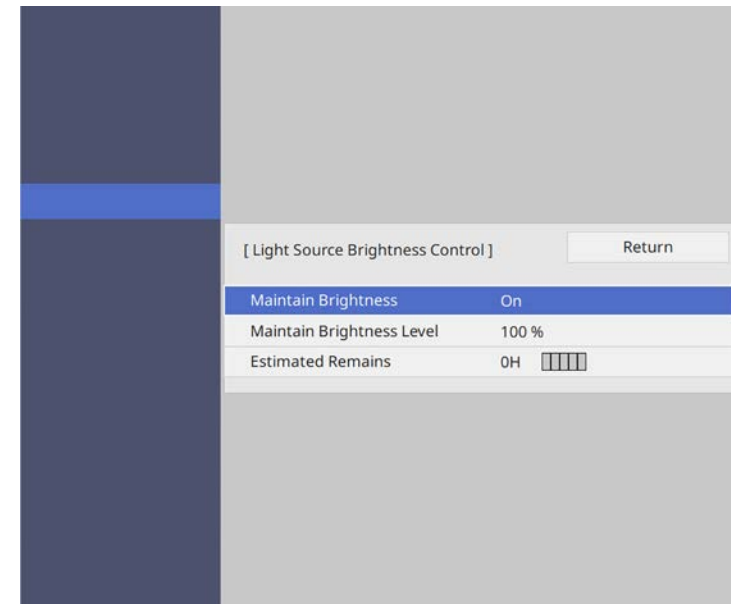

- "Constant Brightness Usage Hours" [p.82](#)
- "Light Source Operation Time" [p.83](#)
- "Projector Specifications" [p.254](#)

## Constant Brightness Usage Hours

If you turn on **Maintain Brightness**, the number of hours the projector can maintain constant brightness is displayed as **Estimated Remains**.



Display level	Estimated remaining hours
	10000 or more hours
	8000 to 9999 hours
	6000 to 7999 hours
	4000 to 5999 hours

Display level	Estimated remaining hours
	2000 to 3999 hours
	0 to 1999 hours

 The number of hours displayed as **Estimated Remains** is just a guide.

## Light Source Operation Time

The light source operation time varies depending on the **Brightness Level** setting and whether **Maintain Brightness** is on or off.

- 
- The light source operation time varies depending on the environmental conditions and usage.
  - The hours listed here are an approximate and are not guaranteed.
  - You may need to replace internal parts sooner than the estimated light source operation time.
  - If **Maintain Brightness** is turned on, and you have exceeded the usage hours listed here, you may not be able to select a high **Maintain Brightness Level** setting.

### Maintain Brightness off

Brightness Level setting	Time before the brightness of the light source is reduced by half (approximate)
100%	20,000 hours
90%	21,000 hours
80%	24,000 hours
70%	30,000 hours

### Maintain Brightness on

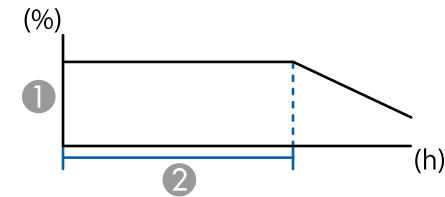

- ① Maintain brightness level
- ② Time the projector can maintain constant brightness (approximate)

Maintain Brightness Level setting	Hours
85%	6,000 hours
80%	10,000 hours
75%	14,000 hours
70%	19,000 hours

The volume buttons control the projector's internal speaker system.

You can also control the volume of any external speakers you connected to the projector.

You must adjust the volume separately for each connected input source.

- 1** Turn on the projector and start a presentation.
- 2** To lower or raise the volume, press the [Volume] buttons on the remote control as shown.

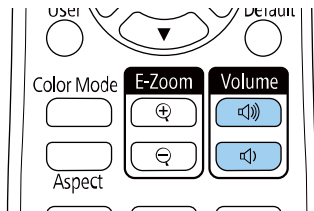

A volume gauge appears on the screen.

- 3** To set the volume to a specific level for an input source, select **Volume** in the projector's **Signal I/O** menu.

## **Caution**

Do not start a presentation at a high volume setting. Sudden loud noises may cause hearing loss.

Always lower the volume before powering off, so that you can power on and then gradually increase the volume.

# Adjusting Projector Features

Follow the instructions in these sections to use your projector's adjustment features.

## ► Related Links

- "Projecting Multiple Images Simultaneously" [p.86](#)
- "Projecting a PC Free Presentation" [p.89](#)
- "Projecting in Content Playback Mode" [p.94](#)
- "Shutting Off the Image and Sound Temporarily" [p.101](#)
- "Stopping Video Action Temporarily" [p.102](#)
- "Zooming Images (E-Zoom)" [p.103](#)
- "Zooming In/Zooming Out of Images (E-Zoom)" [p.104](#)
- "Saving a User's Logo Image" [p.106](#)
- "Saving Settings to Memory and Using Saved Settings" [p.108](#)
- "Using Advanced Image Adjustment Features" [p.109](#)
- "Using Multiple Projectors" [p.112](#)
- "Projector Security Features" [p.124](#)

You can use the split screen feature to simultaneously project two or four images from different image sources.

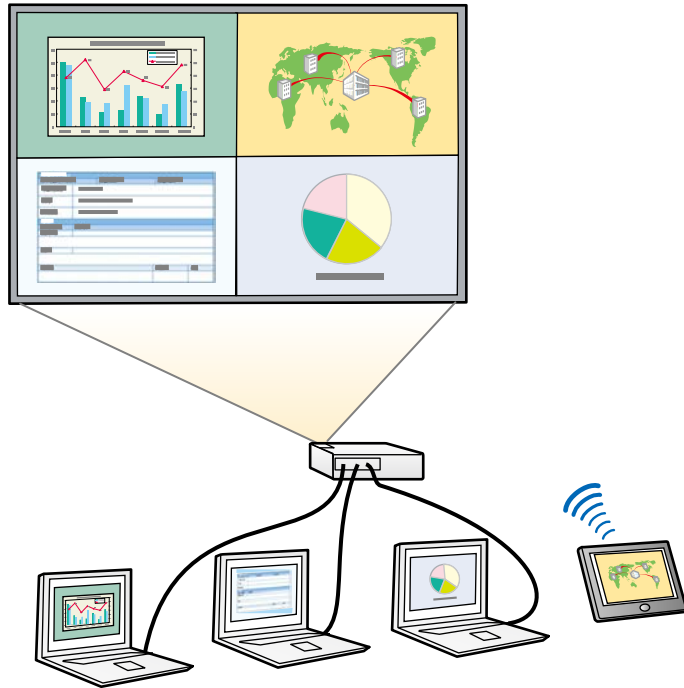

- While using the split screen feature, other projector features may not be available and some settings may be automatically applied to all images.
- You cannot perform split screen projection when the **Content Playback** setting is set to **On** in the projector's **Operation** menu.
- You may not be able to perform split screen projection when you use the **Scale** feature or the **Edge Blending** feature in the projector's **Multi-Projection** menu.

**1** Press the [Split] button on the remote control.

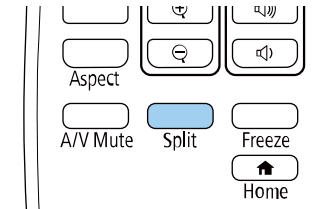

**2** Select **2 Screens** or **4 Screens**.

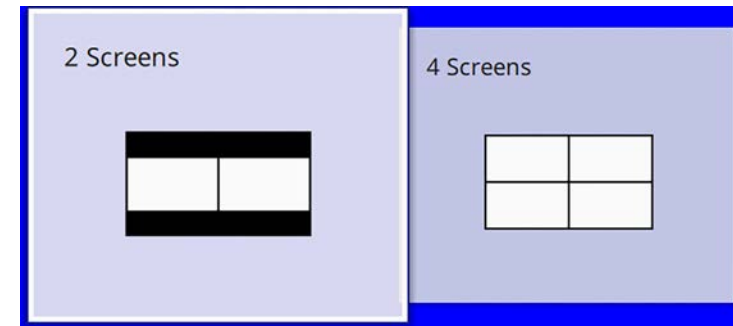

When splitting screen into halves, the currently selected input source moves to the left of the screen.

When you have split screen into quarters previously, the input sources of the previous split screen projection are selected and are projected at the same position.

**3** Press the [Menu] button.

**4** When splitting screen into halves, do the following as necessary:

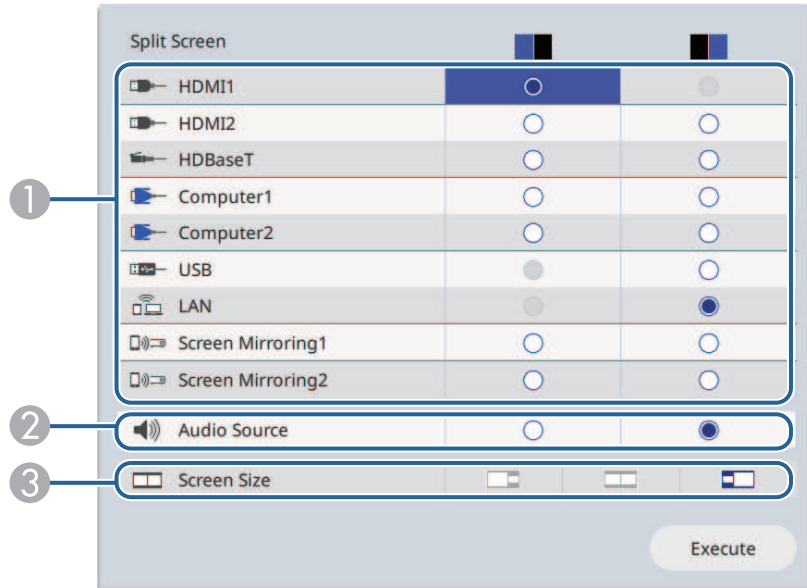

1 Select the input source.

 You can only select input sources that can be combined.

2 Select the screen from which you want to hear audio.

3 Select the screen size.

**5** When splitting screen into quarters, do the following as necessary:

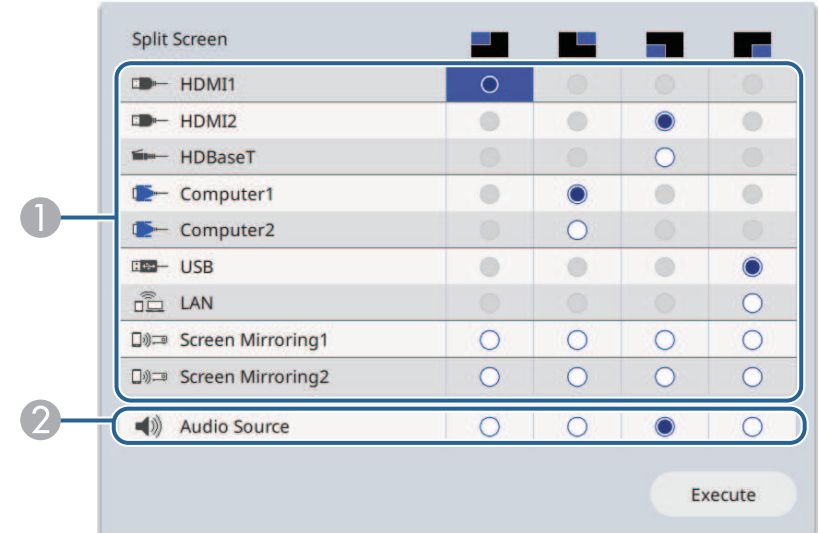

1 Select the input source.

 You can only select input sources that can be combined.

2 Select the screen from which you want to hear audio.

**6** Select **Execute** and press [Enter].

**7** To exit the split screen feature, press [Split] or [Esc].

» **Related Links**

- "Unsupported Input Source Combinations for Split Screen Projection" [p.88](#)
- "Split Screen Projection Restrictions" [p.88](#)

## Unsupported Input Source Combinations for Split Screen Projection

These input source combinations cannot be projected simultaneously.

- HDMI2 and HDBaseT
- Computer1 and Computer2
- USB and LAN



When you split the screen into quarters and select the USB and the Screen Mirroring input source at the same time, you can select only one Screen Mirroring source.

## Split Screen Projection Restrictions

### Operating restrictions

The following operations cannot be performed during split screen projection.

- Setting the projector's menu
- E-Zoom
- Switching the aspect mode (the aspect mode is set to **Auto**)
- Operations using the [User] button on the remote control, other than displaying the network information on the projected surface.
- Applying the **Dynamic Contrast** setting
- Applying the **Image Shift** setting
- Displaying the network information on the projected surface by a method other than pressing the [User] button.
- Displaying the Screen Mirroring information bar

### Image restrictions

- Even if you set **No-signal Screen** to **Logo** in the projector's **Display** menu, the blue screen appears when no image signal is being input.

- When you create a single unified image projected from multiple projectors and use the split screen feature, the second projector does not detect an image signal.

### » Related Links

- "Zooming In/Zooming Out of Images (E-Zoom)" [p.104](#)
- "Image Aspect Ratio" [p.72](#)
- "Zooming Images (E-Zoom)" [p.103](#)
- "Turning On Automatic Luminance Adjustment" [p.75](#)
- "Adjusting the Menu Settings" [p.177](#)



You can use your projector's PC Free feature whenever you connect a USB device that contains compatible presentation files. This lets you quickly and easily display a presentation and control it using the projector's remote control.

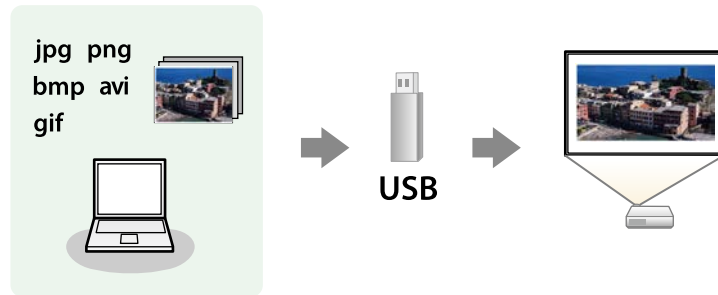

» **Related Links**

- "Supported PC Free File Types" [p.89](#)
- "Precautions on PC Free Projection" [p.90](#)
- "Starting a PC Free Slide Show" [p.90](#)
- "Starting a PC Free Movie Presentation" [p.92](#)
- "PC Free Display Options" [p.93](#)

## Supported PC Free File Types

You can project these types of files using the projector's PC Free feature.



- For best results, place your files on media that is formatted in FAT16/32.
- If you have trouble projecting from media formatted for non-Windows file systems, try formatting the media for Windows instead.

File contents	File type (extension)	Details
Image	.jpg	Make sure the file is not: <ul style="list-style-type: none"> <li>• CMYK format</li> <li>• Progressive format</li> <li>• Highly compressed</li> <li>• Above 8192 × 8192 resolution</li> </ul>
	.bmp	Make sure the file is not: <ul style="list-style-type: none"> <li>• Above 1280 × 800 resolution</li> </ul>
	.gif	Make sure the file is not: <ul style="list-style-type: none"> <li>• Above 1280 × 800 resolution</li> <li>• Animated</li> <li>• Interlaced</li> </ul>
	.png	Make sure the file is not: <ul style="list-style-type: none"> <li>• Above 1920 × 1200 resolution</li> <li>• Interlaced</li> </ul>

File contents	File type (extension)	Details
Movie	.avi (Motion JPEG)	<ul style="list-style-type: none"> <li>• Version: AVI 1.0 only</li> <li>• Resolution: 1280 × 720 or less</li> <li>• Size: 2 GB or less</li> <li>• Movie Codec: Motion JPEG</li> <li>• Frame Rate: up to 30 fps</li> <li>• Audio Codec: LPCM or IMA ADPCM</li> <li>• Audio Sampling Rate: 11.025 kHz, 16 kHz, 22.05 kHz, 24 kHz, 32 kHz, 44.1 kHz, or 48 kHz</li> </ul>

File contents	File type (extension)	Details
Movie	.mp4/.mov (H.264, H265)	<ul style="list-style-type: none"> <li>Resolution: 1920 × 1200 or less</li> <li>Size: 2 GB or less</li> <li>Movie Codec: H.264/MPEG-4 AVC or H.265/MPEG-H HEVC</li> <li>Frame Rate: up to 30 fps</li> <li>Profile:                             <ul style="list-style-type: none"> <li>H.264/MPEG-4 AVC: Baseline Profile, Main Profile, High Profile</li> <li>H.265/MPEG-H HEVC: Main Profile</li> </ul> </li> <li>Color Format: YUV420</li> <li>Single slice structure</li> <li>Audio Codec: MPEG-2 AAC-LC, MPEG-4 AAC-LC, or LPCM</li> <li>Audio Channel: up to 2ch (channel 2)</li> <li>Audio Bit: 8 bits or 16 bits</li> <li>Audio Sampling Rate:                             <ul style="list-style-type: none"> <li>MPEG-2 AAC-LC: 44.1 kHz, 48 kHz</li> <li>MPEG-4 AAC-LC: 44.1 kHz, 48 kHz</li> <li>LPCM: 11.025 kHz, 16 kHz, 22.05 kHz, 24 kHz, 32 kHz, 44.1 kHz, or 48 kHz</li> </ul> </li> </ul>

- When connecting a USB device that includes an AC adapter, connect the AC adapter to an electrical outlet when you use the device with your projector.
- Some commercially available USB card readers may not be compatible with the projector.
- The projector can recognize up to 5 cards inserted into the connected card reader at one time.
- You can use the following functions while projecting in PC Free.
  - Freeze
  - A/V Mute
  - E-Zoom

» **Related Links**

- "Zooming In/Zooming Out of Images (E-Zoom)" [p.104](#)
- "Stopping Video Action Temporarily" [p.102](#)
- "Shutting Off the Image and Sound Temporarily" [p.101](#)
- "Zooming Images (E-Zoom)" [p.103](#)

---

## Starting a PC Free Slide Show

After connecting a USB device to the projector, you can switch to the USB input source and start your slide show.



- You can change the PC Free operation options or add special effects by highlighting **Option** at the bottom of the screen and pressing [Enter].

---

## Precautions on PC Free Projection

Note the following precautions when using PC Free features.

- You cannot use a USB key for PC Free features.
- Do not disconnect the USB storage device while it is being accessed; otherwise, PC Free may not operate correctly.
- You may not be able to use the security features on certain USB storage devices with PC Free features.

- 1 Press the [USB] button on the remote control until the PC Free file list screen appears.



- If the Select Drive screen is displayed, press the arrow buttons to select the drive and press [Enter].
- To display images on the other USB drive, highlight **Select Drive** at the top of the file list screen and press [Enter].

- 2 Do one of the following to locate your files:
  - If you need to display files inside a subfolder on your device, press the arrow buttons to highlight the folder and press [Enter].
  - To move back up a folder level on your device, highlight **Back to Top** and press [Enter].
  - To view additional files in a folder, highlight **Next Page** or **Previous Page** and press [Enter].

- 3 Do one of the following:
  - To display an individual image, press the arrow buttons to highlight the image and press [Enter]. (Press the [Esc] button to return to the file list screen.)

- To display a slide show of all the images in a folder, press the arrow buttons to highlight the **Slideshow** option at the bottom of the screen and press [Enter].

- You can change the image switching time by highlighting **Option** at the bottom of the screen and pressing [Enter].
- If any file names are longer than the display area or include unsupported symbols, the file names may be shortened or changed only on the screen display.

- 4 While projecting, use the following commands to control the display:

- To rotate a displayed image, press the up or down arrow button.

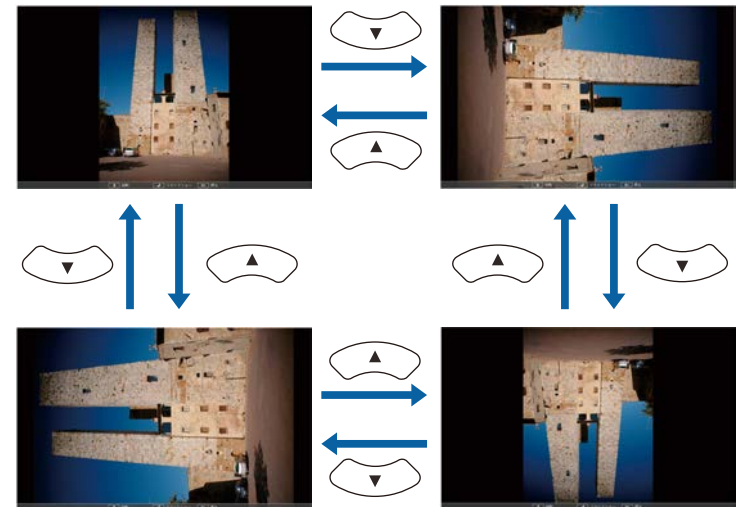

- To move to the next or previous image, press the left or right arrow button.

- 5 To stop the display, follow the on-screen instructions or press the [Esc] button. You return to the file list screen.

- 6 Turn off the USB device, if necessary, and then disconnect the device from the projector.

## ► Related Links

- "PC Free Display Options" [p.93](#)
- "Connecting to a USB Device" [p.32](#)

## Starting a PC Free Movie Presentation

After connecting a USB device to the projector, you can switch to the USB input source and start your movie.



- You can change the PC Free operation options by highlighting **Option** at the bottom of the screen and pressing [Enter].

- 1 Press the [USB] button on the remote control until the PC Free file list screen appears.



- If the Select Drive screen is displayed, press the arrow buttons to select the drive and press [Enter].
- To display images on the other USB drive, highlight **Select Drive** at the top of the file list screen and press [Enter].

- 2 Do one of the following to locate your files:
  - If you need to display files inside a subfolder on your device, press the arrow buttons to highlight the folder and press [Enter].
  - To move back up a folder level on your device, highlight **Back to Top** and press [Enter].
  - To view additional files in a folder, highlight **Next Page** or **Previous Page** and press [Enter].

- 3 To play back a movie, press the arrow buttons to highlight the file and press [Enter].



- If any file names are longer than the display area or include unsupported symbols, the file names may be shortened or changed only on the screen display.
- If you want to play back all the movies in a folder in sequence, select the **Slideshow** option at the bottom of the screen.

- 4 To stop movie playback, press the [Esc] button, highlight **Exit**, and press [Enter].

You return to the file list screen.

- 5 Turn off the USB device, if necessary, and then disconnect the device from the projector.

## ► Related Links

- "PC Free Display Options" [p.93](#)
- "Connecting to a USB Device" [p.32](#)

## PC Free Display Options

You can select these display options when using PC Free. To access this screen, highlight **Option** at the bottom of the PC Free file list screen and press [Enter].



Setting	Options	Description
Effect	No	No effect
	Wipe	Transitions between images using a wipe effect
	Dissolve	Transitions between images using a dissolve effect
	Random	Transitions between images using a random variety of effects

Setting	Options	Description
Display Order	Name Order	Displays files in name order
	Date Order	Displays files in date order
Sort Order	In Ascending	Sorts files in first-to-last order
	In Descending	Sorts files in last-to-first order
Continuous Play	On	Displays a slide show continuously
	Off	Displays a slide show once
Screen Switching Time	No	Does not display the next file automatically
	1 Second to 60 Seconds	Displays files for the selected time and switches to the next file automatically; high resolution images may switch at a slightly slower rate

Your projector's Content Playback feature allows you to project your digital signage content. You can easily project playlists that contain images and movies saved on an external storage device. You can also add color and shape effects to your projected image.



File contents	File type (extension)	Details
Image	.jpg	Make sure the file is not: <ul style="list-style-type: none"><li>• Progressive format</li><li>• Highly compressed</li><li>• Above 8192 × 8192 resolution</li></ul>
	.bmp	Make sure the file is not: <ul style="list-style-type: none"><li>• Above 1280 × 800 resolution</li></ul>
	.gif	Make sure the file is not: <ul style="list-style-type: none"><li>• Above 1280 × 800 resolution</li><li>• Animated</li><li>• Interlaced</li></ul>
	.png	Make sure the file is not: <ul style="list-style-type: none"><li>• Above 1280 × 800 resolution</li><li>• Interlaced</li></ul>

## ► Related Links

- "Supported Content Playback Mode File Types" [p.94](#)
- "Switching to Content Playback Mode" [p.95](#)
- "Projecting Your Playlists" [p.96](#)
- "Adding Effects to Your Projected Image" [p.98](#)
- "Content Playback Mode Restrictions" [p.100](#)

---

## Supported Content Playback Mode File Types

You can project these types of files using the projector's Content Playback feature.

File contents	File type (extension)	Details
Movie	.avi (Motion JPEG)	<ul style="list-style-type: none"> <li>• Version: AVI 1.0 only</li> <li>• Resolution: 1280 × 800 or less</li> <li>• Size: 2 GB or less</li> <li>• Movie Codec: Motion JPEG</li> <li>• Audio Codec: LPCM or IMA ADPCM</li> <li>• Audio Sampling Rate: 11.025 kHz, 22.05 kHz, 44.1 kHz, 16 kHz, 24 kHz, 32 kHz, or 48 kHz</li> </ul>
	.mp4/.mov (H.264/H.265)	<ul style="list-style-type: none"> <li>• Resolution: 1920 × 1200 or less</li> <li>• Size: 2 GB or less</li> <li>• Movie Codec: H.264/MPEG-4 AVC or H.265/MPEG-H HEVC</li> <li>• Profile:                             <ul style="list-style-type: none"> <li>• H.264/MPEG-4 AVC: Baseline Profile, Main Profile, High Profile</li> <li>• H.265/MPEG-H HEVC: Main Profile</li> </ul> </li> <li>• Color Format: YUV420</li> <li>• Audio Codec: MPEG-4 AAC-LC, or LPCM</li> <li>• Audio Sampling Rate:                             <ul style="list-style-type: none"> <li>• MPEG-2 AAC-LC: 44.1 kHz, 48 kHz</li> <li>• MPEG-4 AAC-LC: 44.1 kHz, 48 kHz</li> <li>• LPCM: 11.025 kHz, 16 kHz, 22.05 kHz, 24 kHz, 32 kHz, 44.1 kHz, or 48 kHz</li> </ul> </li> </ul>

**2** Press the [Menu] button, select the **Operation** menu, and then press [Enter].

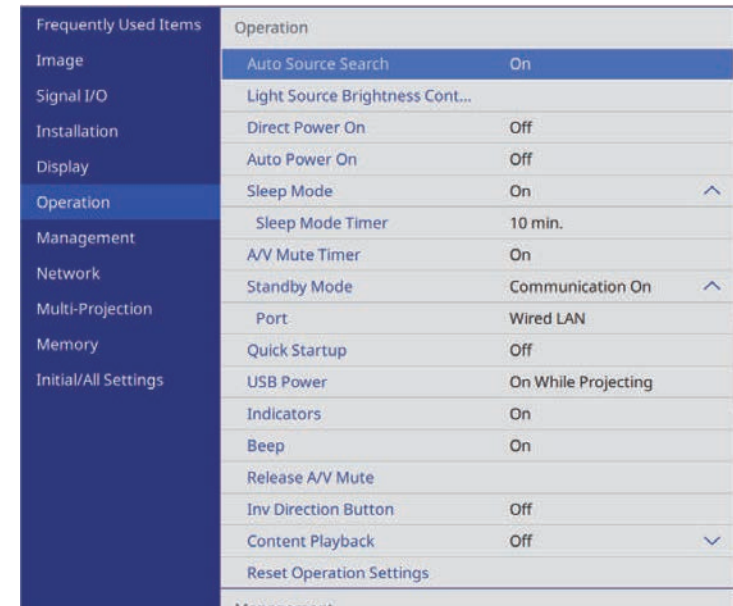

**3** Select the **Content Playback** setting and set it to **On**. You see a confirmation prompt.

**4** Turn off the projector, then turn it on again to enable Content Playback mode.

## Switching to Content Playback Mode

Before you project your playlists, you need to switch to Content Playback mode.

**1** Turn on the projector.

## Projecting Your Playlists

You can project playlists that contain images and movies in Content Playback mode.



**1** Create your playlists and export them to a USB flash drive using one of the following methods:

- The Epson Projector Content Manager software lets you create playlists and save them on an external storage device. You can also add color and shape effects to your projected image, and schedule playlists.

You can download and install Epson Projector Content Manager from the following Web site.

[epson.sn](http://epson.sn)

See the *Epson Projector Content Manager Operation Guide* for instructions.

- Epson Web Control allows you to create playlists using a Web browser and save them to an external storage device connected to a projector on a network. You can also add color and shape effects to your projected image.
- The Epson Creative Projection app lets you create content on iOS devices. You can also transfer content to the projector wirelessly.

You can download Epson Creative Projection from the App Store. Any fees incurred when communicating with the App Store are the responsibility of the customer.

**2** In Content Playback mode, connect the USB flash drive into the projector's USB-A port.

**3** Press the [USB] button on the remote control.

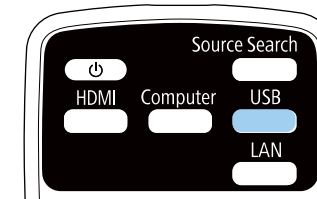

The playlist that was played last is projected. If there is a timetable assigned, the playlist will play back according to the schedule in the timetable.



- You can also hold down the [Num] and numeric buttons to project your favorite playlist. You can set a remote control shortcut key using the software you used to create the playlists.
- To select the target playlist from the list, select **USB Viewer** in the projector's **Operation** menu, and use the arrow buttons.

### » Related Links

- "Creating Playlists Using Epson Web Control" [p.96](#)
- "Getting the Latest Version of the Documents" [p.10](#)

## Creating Playlists Using Epson Web Control

In Content Playback mode, you can create playlists using a Web browser and save them to a USB flash drive connected to a projector on a network.

### Attention

Do not remove the USB flash drive from the projector or disconnect the projector's power cord while creating playlists. Data saved on the USB flash drive may be damaged.

**1** Make sure the projector is operating in Content Playback mode.



- 2 Make sure your computer or device is connected to the same network as the projector.
- 3 Make sure a USB flash drive is connected to the projector's USB-A port.
- 4 Start your Web browser on your computer or device.
- 5 Go to the Epson Web Control screen by entering the projector's IP address into the browser's address box. When entering an IPv6 address, wrap the address with [ and ].
- 6 Select **USB Memory Device**.

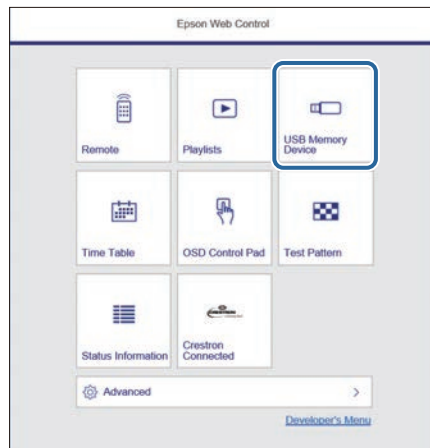

- 7 Select **Upload New Data**.

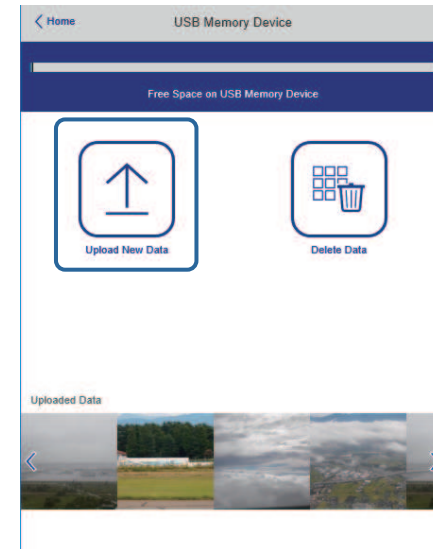

- 8 Select the images or movies you want to add to the playlist.



You can upload .avi, .jpeg (.jpg), .png, .bmp, or .gif files.  
If you want to add .mp4 or .mov files to the playlist, use the Epson Projector Content Manager software or the Epson Creative Projection app.

The selected files are copied to the connected USB flash drive.

- 9 Do one of the following:
  - To add them to the existing playlist, select **Add to Playlist** and select the playlist you want to add them to.
  - To create a new playlist and add them to it, select **Create New Playlist**.

## 10 Edit the playlist.

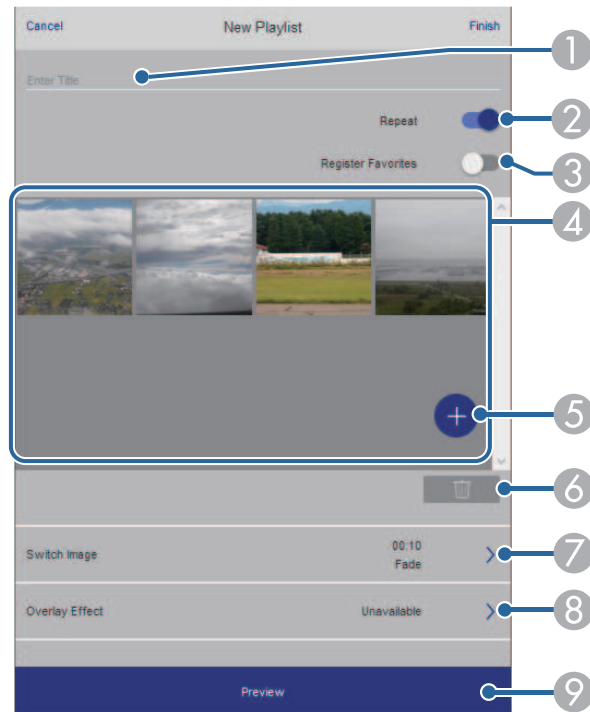

- 1 Edits the playlist name.
- 2 Selects whether to enable repeat playback or not.
- 3 Registers the playlist to your favorites.  
When a playlist has been registered as a favorite, you can start playback quickly using the **Remote** screen or the remote control.
- 4 Displays the images or movies you have added to the playlist. The playlist plays the images or movies in order.
- 5 Adds images or movies to the playlist.
- 6 Deletes images or movies from the playlist.

- 7 Opens the **Switch Image** screen.  
You can specify the time interval to switch to the next image file. You can also select a transition effect.
- 8 Opens the **Effects** screen.  
You can add predefined color and shape effect filters to a playlist. You can also create a customized effect.
- 9 Previews the playlist.

## 11 When you have finished editing the playlist, select **Finish**.



- You can play the playlist from the **Remote** or **Playlist** screen.
- When you want to specify when the playlist starts and finishes, schedule the playlist using the Epson Projector Content Manager software.

### » Related Links

- "Web Control Options" [p.158](#)

## Adding Effects to Your Projected Image

You can add color and shape effects to the projected image in Content Playback mode.





- To use the effect functions, make sure you perform **Refresh Mode** regularly.
  - Management > Refresh Mode
- This feature is not available when using the **Edge Blending** feature.

**1** In Content Playback mode, press the [Menu] button, select the **Operation** menu, and then press [Enter].

Frequently Used Items	Operation	
Image	Auto Source Search	On
Signal I/O	Light Source Brightness Cont...	
Installation	Direct Power On	Off
Display	Auto Power On	Off
Operation	Sleep Mode	On
Management	Sleep Mode Timer	10 min.
Network	A/V Mute Timer	On
Multi-Projection	Standby Mode	Communication On
Memory	Port	Wired LAN
Initial/All Settings	Quick Startup	Off
	USB Power	On While Projecting
	Indicators	On
	Beep	On
	Release A/V Mute	
	Inv Direction Button	Off
	Content Playback	Off
	Reset Operation Settings	

**2** Select **Overlay Effect** and press [Enter].

**3** Select **On** as the **Overlay Effect** setting and press [Enter].

[ Overlay Effect ]	Return
Overlay Effect	On
Shape Filter	Circle 1
Color Filter	Off
Lightness	100

**4** Select **Shape Filter** and press [Enter].

**5** Adjust each of the following options as necessary:

- Shape** to select the shape effect you want from circles, rectangles, or customized shapes.



You can add your images as customized shapes using the Epson Projector Content Manager software. See the *Epson Projector Content Manager Operation Guide* for details.

- Filter Effect** to select whether to mask inside or outside of the selected shape.
- Size** to set the shape size.
- Position** to set the shape position.



When you use a customized shape, you cannot change the **Size** and **Position** settings.

**6** Select **Color Filter** and press [Enter].

**7** Adjust each of the following options as necessary:

- Color Filter** to select the color.

- **Custom** to set a customized color by adjusting **Red**, **Green**, and **Blue** individually.

**8** Select **Lightness** to set the brightness level.

**9** When you are finished, press [Menu] to exit the menus.

---

## Content Playback Mode Restrictions

### Operating restrictions

The following operations cannot be performed in Content Playback mode.

- Changing the **Color Temp.** setting in the **Image** menu (when **Warm White** or **Cool White** is selected as **Color Filter**)
- Split Screen
- Log Save Destination
- Blanking
- Changing the **Screen Type** setting in the **Installation** menu
- Changing the **No-signal Screen** setting in the **Display** menu
- Detecting the input signal automatically
- Changing **Remote Password** in the **Network Settings** menu
- PC Free
- USB Document camera
- Screen delivery function using the Epson iProjection software
- Changing the **Connection Guide Display** setting in the **Network Settings** menu

### ► Related Links

- "Image Quality Settings - Image Menu" [p.180](#)
- "Network Menu - Network Settings Menu" [p.196](#)
- "Projecting Multiple Images Simultaneously" [p.86](#)
- "Setting the Screen Type" [p.50](#)
- "Projecting a PC Free Presentation" [p.89](#)

You can temporarily turn off the projected image and sound.

This is effective when you want to redirect your audience's attention during a presentation.

Any sound or video action continues to run, however, so you cannot resume projection at the point that you stopped it.

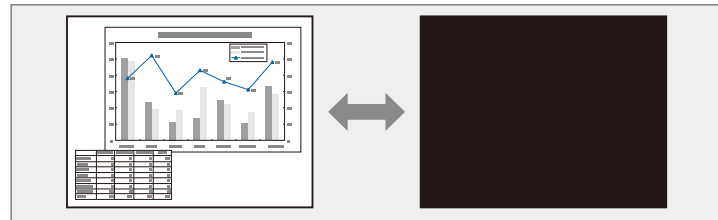

- 1 Press the [A/V Mute] button on the control panel or remote control.

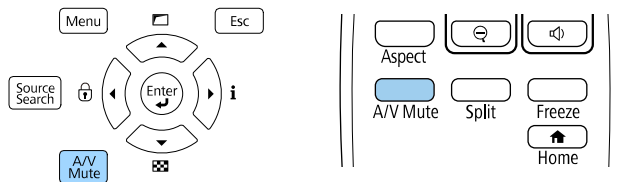

The light source turns off and the projected image and sound are interrupted.

- 2 To turn the image and sound back on, press [A/V Mute] again.



- The projector's power automatically turns off 30 minutes after A/V Mute is enabled. You can disable this feature.  
    ☛ **Operation > A/V Mute Timer**
- If you selected **A/V Mute** as the **Release A/V Mute** setting in the **Operation** menu, you can still control the projector while A/V Mute is enabled.

You can temporarily stop the action in a video or computer presentation and keep the current image on the screen. Any sound or video action continues to run, however, so you cannot resume projection at the point that you stopped it.

- 1** Press the [Freeze] button on the remote control to stop the video action.

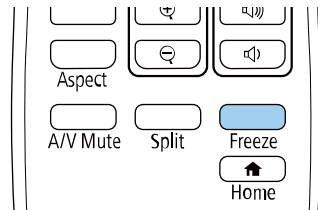

- 2** To restart the video action in progress, press [Freeze] again.

You can draw attention to parts of a presentation by zooming into a portion of the image and enlarging it on the screen (EB-L735U/EB-L730U/EB-L635SU/EB-L630SU/EB-L630U/EB-L530U).

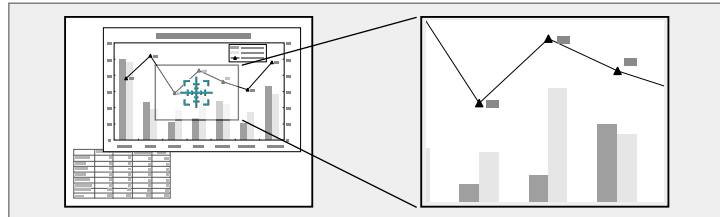

This feature is unavailable if the **Scale** setting in the projector's **Image** menu is enabled.

**1** Press the [E-Zoom] + button on the remote control.

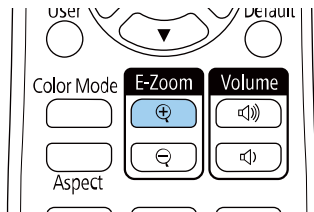

You see a crosshair on the screen indicating the center of the zoom area.

**2** Use the following buttons on the remote control to adjust the zoomed image:

- Use the arrow buttons to position the crosshair in the image area you want to zoom into. To move the crosshair diagonally, press any pair of adjacent arrow buttons at the same time.
- Press the [E-Zoom] + button repeatedly to zoom into the image area. Press and hold the [E-Zoom] + button to zoom in more quickly.

- To pan around the zoomed image area, use the arrow buttons.
- To zoom out of the image, press the [E-Zoom] – button.
- To return to the original image size, press [Esc].

The enlarged image is projected and the enlargement ratio is displayed on the screen.

You can enlarge the selected area to between one to four times in 25 incremental steps.

When projecting images from an Epson document camera using a USB connection, you can enlarge the selected area from one to eight times its size in 57 incremental steps.

You can zoom in or zoom out of the projected image using the [E-Zoom] button on the remote control (EB-L720U/EB-L520U).

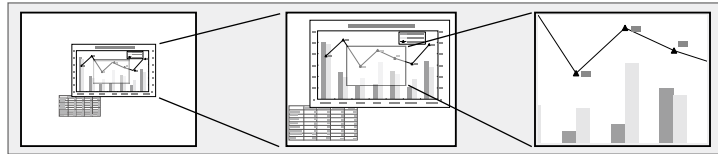

This feature is unavailable if the **Scale** setting in the projector's **Image** menu is enabled.

## » Related Links

- "Zooming Into Images" [p.104](#)
- "Zooming Out of Images" [p.104](#)

**2** Use the following buttons on the remote control to adjust the zoomed image:

- Press the [E-Zoom] + button repeatedly to zoom into the image.
- To pan around the zoomed image, use the arrow buttons.
- To zoom out of the image, press the [E-Zoom] - button.
- To return to the original image size, press the [Default] button.



- You can also use the [E-Zoom] + and - buttons of the document camera that you project image from.
- You can also set the **E-Zoom** setting in the projector's **Installation** menu.

## Zooming Into Images

**1** Press the [E-Zoom] + button on the remote control.

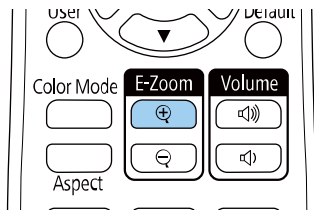

The projected image is enlarged focusing around the center of the image. You can enlarge the image between one to four times in 25 incremental steps.

## Zooming Out of Images

**1** Press the [E-Zoom] - button on the remote control.

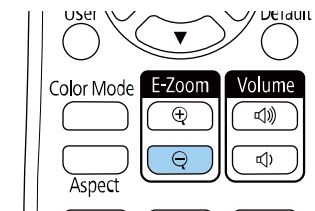

The projected image is reduced. You can reduce the image between 100% to 50% in incremental steps.

**2** Use the following buttons on the remote control to adjust the zoomed-out image:

- Press the [E-Zoom] - button repeatedly to zoom out of the projected image.



- To move the zoomed-out image in the projection area, use the arrow buttons.
- To zoom into the image, press the [E-Zoom] + button.
- To return to the original image size, press the [Default] button.



- You can also use the [E-Zoom] + and - buttons of the document camera that you project image from.
- You can also set the **E-Zoom** setting in the projector's **Installation** menu.

You can save an image on the projector and display it whenever the projector turns on. You can also display the image when the projector is not receiving an input signal. This image is called the user's logo screen.

You can select a photo, graphic, or company logo as the user's logo, which is useful in identifying the projector's owner to help deter theft. You can prevent changes to the user's logo by setting up password protection.



- If you turned on **Menu Protection** for the **User's Logo** setting, set it to **Off** before performing the steps here to save the user's logo.
- When you copy the menu settings from one projector to another using the batch setup feature, user's logo is also copied. Do not register the information that you do not want to share between multiple projectors as a user's logo.
- You cannot save content that is protected by HDCP.
- When **Content Playback** is set to **On**, you can display the user's logo only when the projector starts up.

**1** Display the image you want to project as the user's logo.

**2** Press the [Menu] button, select the **Management** menu, and press [Enter].

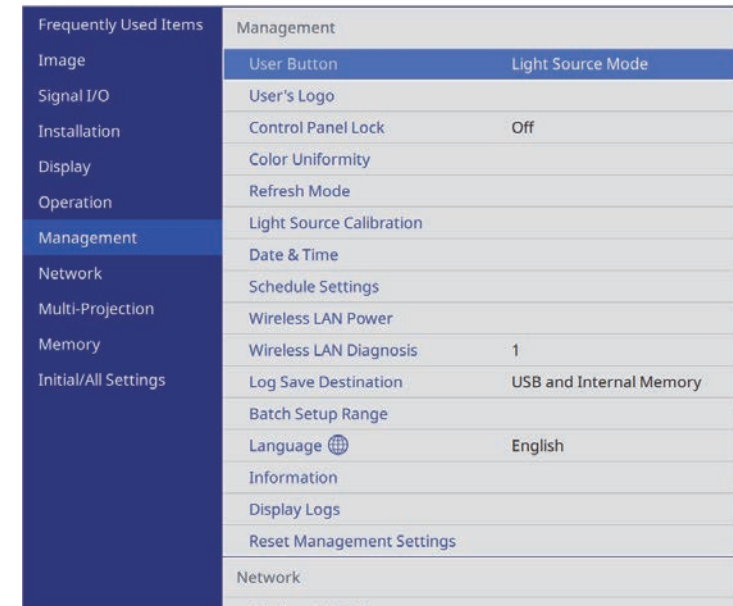

**3** Select **User's Logo > Start Setting** and press [Enter].

You see a prompt asking if you want to use the displayed image as a user's logo.



Adjustments such as **Geometry Correction**, **E-Zoom**, **Aspect**, **Scale**, or **Screen Type** are temporarily canceled when you select **User's Logo**.

**4** Select **Yes** and press [Enter].



Depending on the current image signal, the screen size may change to match the resolution of the image signal.

- 5** Check the displayed image, and then select **Yes** to save it as the user's logo.  
The user's logo is overwritten and a completion message is displayed.
- 6** Press [Esc] to exit the message screen.
- 7** Select the **Display** menu and press [Enter].

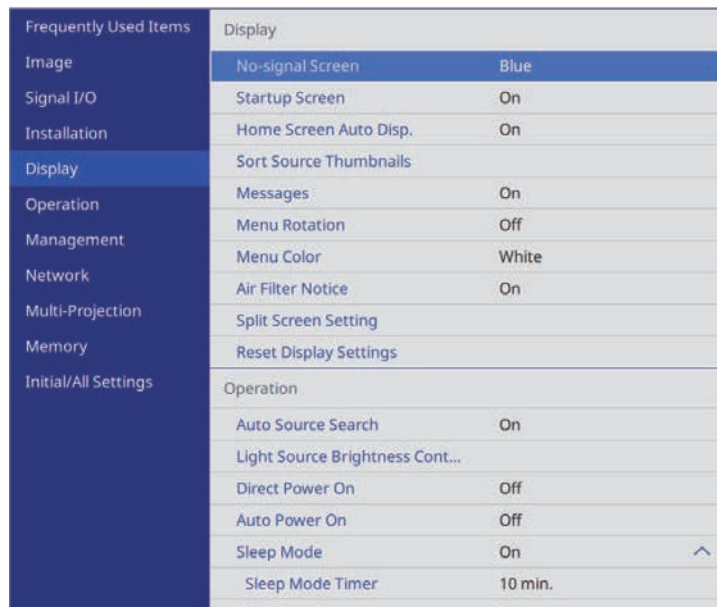

Frequently Used Items	Display
Image	No-signal Screen Blue
Signal I/O	Startup Screen On
Installation	Home Screen Auto Disp. On
Display	Sort Source Thumbnails
Operation	Messages On
Management	Menu Rotation Off
Network	Menu Color White
Multi-Projection	Air Filter Notice On
Memory	Split Screen Setting
Initial/All Settings	Reset Display Settings
	Operation
	Auto Source Search On
	Light Source Brightness Cont...
	Direct Power On Off
	Auto Power On Off
	Sleep Mode On
	Sleep Mode Timer 10 min.

- 8** Select when you want to display the User's Logo screen:
  - To display it whenever there is no input signal, select **No-signal Screen** and set it to **Logo**.
  - To display it whenever you turn the projector on, select **Startup Screen** and set it to **On**.



To prevent changes to the **User's Logo** settings, turn on **Menu Protection** for the **User's Logo** setting and set the password.

#### » Related Links

- "Selecting Password Security Types" [p.125](#)

You can save customized settings and then select the saved settings whenever you want to use them.

- 1 Turn on the projector and display an image.
- 2 Press the [Menu] button, select the **Memory** menu, and press [Enter].



- 3 Select one of the following options:
  - **Save Memory** lets you save your current settings to memory (10 memories with different names are available).



- You can save the following settings:
  - **Image** menu settings for each color mode
  - **Video Range** and **Overscan** in the **Signal I/O** menu
  - **Light Source Mode** and **Brightness Level** in the **Operation** menu
  - **Color Matching** in the **Multi-Projection** menu
  - A memory name that has already been used is indicated by a blue mark. Saving over a previously saved memory overwrites the settings with your current settings.

- **Load Memory** lets you overwrite your current settings with saved settings.
- **Rename Memory** lets you rename a saved memory.
- **Erase Memory** lets you erase the selected memory settings.

- 4 Press [Menu] or [Esc] to exit the menus.



- The saved Color Mode is displayed on the right of the memory name.
- To delete all saved memories, select **Reset Memory Settings**.

## » Related Links

- "Image Quality Settings - Image Menu" [p.180](#)
- "Input Signal Settings - Signal I/O Menu" [p.183](#)
- "Projector Feature Settings - Operation Menu" [p.189](#)
- "Multiple Projector Operation Settings - Multi-Projection Menu" [p.203](#)

Follow the instructions in these sections to use your projector's advanced image adjustments.

## ► Related Links

- "Adjusting the Color Tone (Color Uniformity)" [p.109](#)
- "Running Light Source Calibration" [p.110](#)

## Adjusting the Color Tone (Color Uniformity)

You can use the Color Uniformity feature to manually adjust the color tone balance in the projected image.



The color tone may not be uniform even after adjusting the color uniformity.

- 1** Press the [Menu] button, select the **Management** menu, and press [Enter].

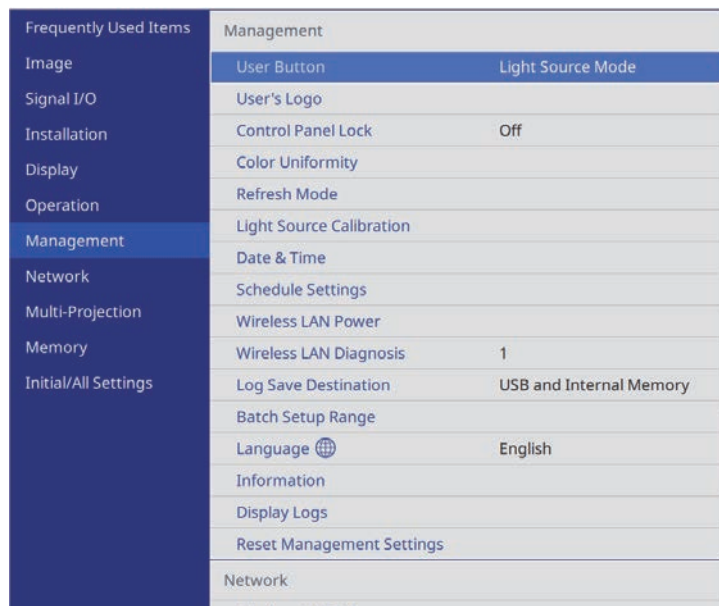

- 2** Select **Color Uniformity** and press [Enter].

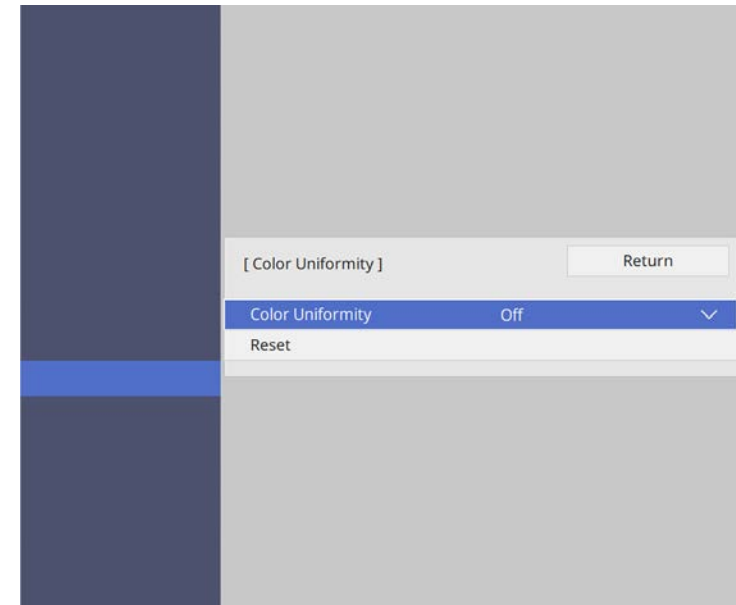

- 3** Select **Color Uniformity** again and press [Enter].

- 4** Select **On** and press [Enter]. Then press [Esc].

- 5** Select **Adjustment Level** and press [Enter].

- 6** Select the first adjustment level you want to adjust and press [Esc].





There are eight adjustment levels, from white to gray to black. You can adjust each level individually.



The adjustment screen changes each time you press [Enter].

**7** Select **Start Adjustments** and press [Enter].

**8** Select the area of the image you want to adjust and press [Enter].

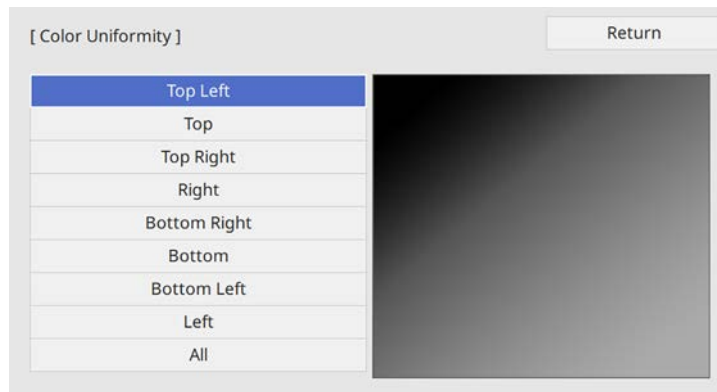

Adjust each area individually, then select **All** and adjust the entire screen.

**9** Select **Red**, **Green**, or **Blue** and adjust the color tone, if necessary.

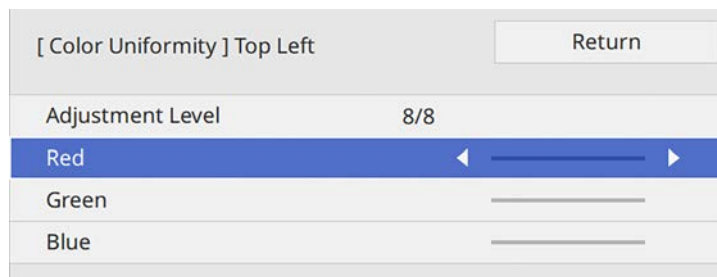

**10** Press [Esc] to return to the area selection screen.

**11** Repeat the color adjustments to each area.

**12** Return to step 5 and repeat all steps to adjust other levels.

**13** When you are finished, press [Menu] to exit.

## Running Light Source Calibration

Light source calibration automatically adjusts any difference between the white balance and the brightness level of the light source. You should perform light source calibration every 100 hours of projector usage. You can also schedule automatic calibration or run the light source calibration manually using the menus.

Automatic light source calibration may not start in the following conditions:

- Within 20 minutes of turning on the projector.
- When using direct shutdown.
- When you have used the projector continuously for over 24 hours.
- When the projector brightness is automatically dimmed due to high temperatures.

- 1 Press the [Menu] button, select the **Management** menu, and press [Enter].

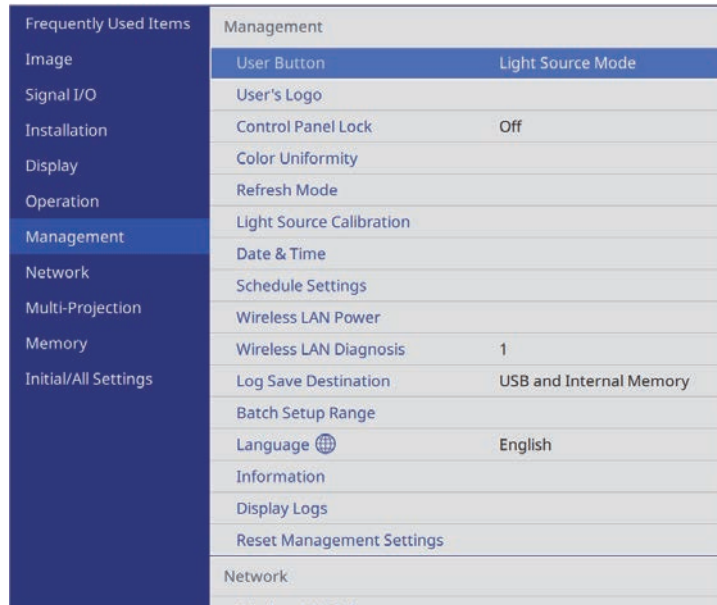

- 2 Select **Light Source Calibration** and press [Enter].
- 3 Select any of the following:
  - To run the light source calibration now, select **Run Now**.
  - To automatically run the light source calibration every 100 hours of projector usage, select **Run Periodically**.
  - To schedule automatic calibration, select **Schedule Settings**.
  - To check the last time the projector performed a calibration, see **Last Run**.



If you use the projector continuously for more than 24 hours or use direct shutdown regularly, select **Schedule Settings** to schedule calibration of the light source periodically.

- 4 When you are finished, press [Menu] to exit the menus.

#### » Related Links

- "Setting Projector Event Schedules" [p.174](#)

You can combine the projected images from two or more projectors to create one unified image area.

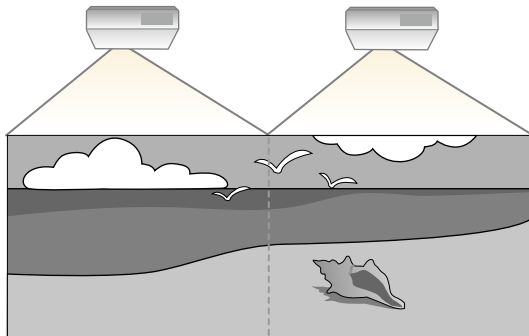

## » Related Links

- "Multiple Projector Adjustment Overview" [p.112](#)
- "Projector Identification System for Multiple Projector Control" [p.113](#)
- "Tiling Images into One Image" [p.115](#)
- "Blending the Image Edges" [p.116](#)
- "Matching the Image Colors" [p.120](#)
- "Scaling an Image" [p.121](#)

---

## Multiple Projector Adjustment Overview

The following steps provide an overview of image adjustment for multiple projectors. You can correct the brightness and color tone of each projector's image and create a seamless image from multiple projectors.



- We recommend adjusting the image at least 20 minutes after you start projecting, because images are not stable right after turning on the projector.
- In some cases the brightness and color tone may not match completely even after correction.
- If brightness and color tone differences become more noticeable over time, repeat the adjustments.
- When installing the projectors, make sure hot air from the exhaust vent of one projector does not go into the air intake vent of another projector.

- 1** Set IDs for all the remote controls and projectors.
- 2** Adjust each projector's physical position and angle to the screen.
- 3** Select **Multi-Projection** as the **Color Mode** setting in the projector's **Image** menu on each projector.
- 4** Adjust the arrangement of the images (tiling).
- 5** Adjust the image aspect ratio for each projector.
- 6** Adjust the position of the image for each projector using lens shift (EB-L735U/EB-L730U/EB-L635SU/EB-L630SU/EB-L630U/EB-L530U).
- 7** Adjust the zoom and focus for each projector.
- 8** Adjust small differences in the images using the **Point Correction** setting.
- 9** Adjust the edges of the images using the **Edge Blending** and **Black Level** settings.
- 10** Adjust the brightness and tint of the images using the **Color Matching** setting.



**11** Crop and combine each projector's image area using the **Scale** setting.

» **Related Links**

- "Adjusting Image Quality (Color Mode)" [p.74](#)
- "Image Aspect Ratio" [p.72](#)
- "Focusing the Image Using the Focus Ring" [p.69](#)
- "Correcting Image Shape with Point Correction" [p.63](#)
- "Precautions on Installation" [p.24](#)
- "Adjusting the Image Position Using Lens Shift" [p.53](#)
- "Resizing the Image with the Zoom Ring" [p.66](#)
- "Reducing the Image Using Digital Zoom" [p.67](#)

## Projector Identification System for Multiple Projector Control

When lining up multiple projectors to project images, you can correct the brightness and color tone of each projector's image so that the images match closely.

You can set a unique projector ID for each projector to operate them individually using a remote control, and then correct the brightness and color for each projector.

» **Related Links**

- "Setting the Projector ID" [p.113](#)
- "Selecting the Projector You want to Operate" [p.114](#)

### Setting the Projector ID

To control multiple projectors from a remote control, give each projector a unique ID.



To control more than nine projectors, use the Epson Projector Professional Tool.

**1** Press the [Menu] button, select the **Multi-Projection** menu, and press [Enter].

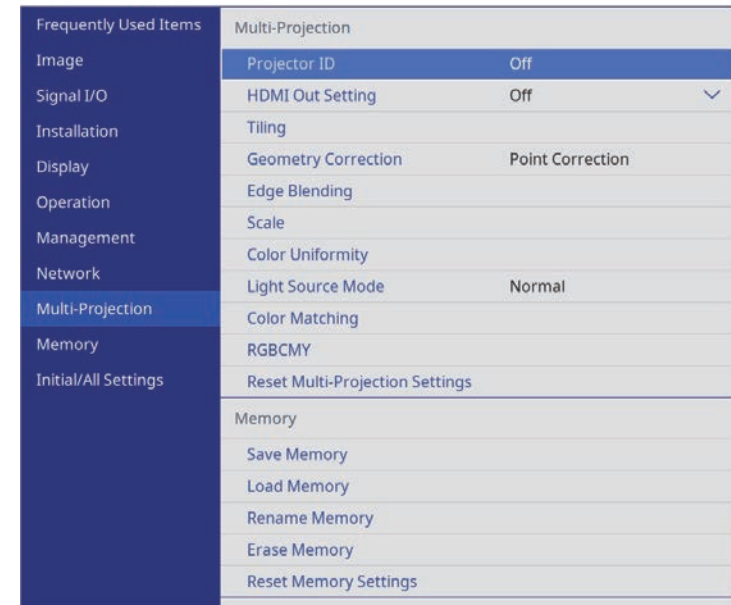

**2** Select **Projector ID** and press [Enter].

- Use the arrow buttons to select the identification number you want to use for the projector. Then press [Enter].

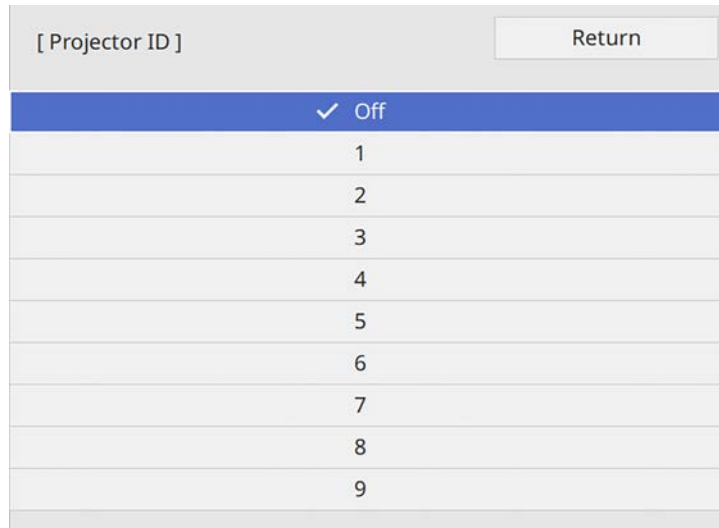

- Press [Menu] or [Esc] to exit the menus.
- Repeat these steps for all the other projectors you want to operate from one remote control.

## Selecting the Projector You want to Operate

After setting the projector's ID, select the ID for the projector you want to operate using the remote control.

- Aim the remote control at the target projector and press the [ID] button.

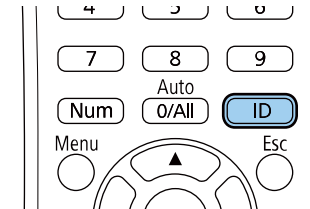

The current Projector ID is displayed on the projected screen. It disappears after about 3 seconds.

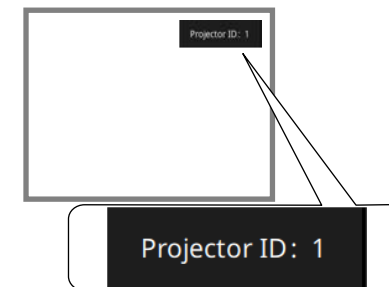

- While holding the [ID] button, press the number button that matches the ID of the projector you want to operate.

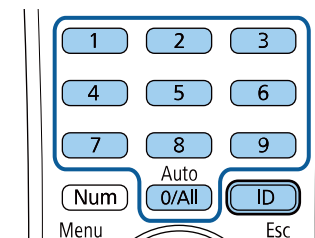

The projector you want to operate is selected.



- When you select [0/All] on the remote control, you can operate all projectors regardless the **Projector ID** setting.
- When you set the **Projector ID** setting to **Off**, you can operate the projector using the remote control whichever ID you select on the remote control.
- The projector ID setting is saved in the remote control. Even if the remote control batteries are removed to replace them and so on, the saved ID setting is retained. However, if the batteries are left out of the remote control for an extended period, the ID returns to its default setting (0/All).
- When you use multiple remote controls at the same time, you may not be able to operate projectors as intended due to infrared interference.

## » Related Links

- "Configuring Tiling" p.115

## Configuring Tiling

You can configure tiling manually.



Available only when the **HDMI Out Setting** is set to **Off** (EB-L735U/EB-L730U/EB-L635SU/EB-L630SU/EB-L630U/EB-L530U).

- 1 Turn on the projector.
- 2 Press the [Menu] button, select the **Multi-Projection** menu, and press [Enter].

## Tiling Images into One Image

You can project the same image from up to 15 projectors to create one large image using the Tiling feature.

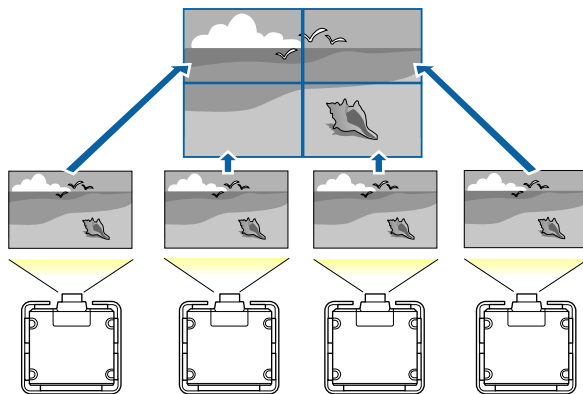

Before tiling, make sure the displayed images from your projectors are rectangular, correctly sized, and focused.

Frequently Used Items	Multi-Projection
Image	Projector ID Off
Signal I/O	HDMI Out Setting Off
Installation	Tiling
Display	Geometry Correction Point Correction
Operation	Edge Blending
Management	Scale
Network	Color Uniformity
Multi-Projection	Light Source Mode Normal
Memory	Color Matching
Initial/All Settings	RGBCMY
	Reset Multi-Projection Settings
	Memory
	Save Memory
	Load Memory
	Rename Memory
	Erase Memory
	Reset Memory Settings

- 3** Select **Tiling > Layout** and press [Enter].

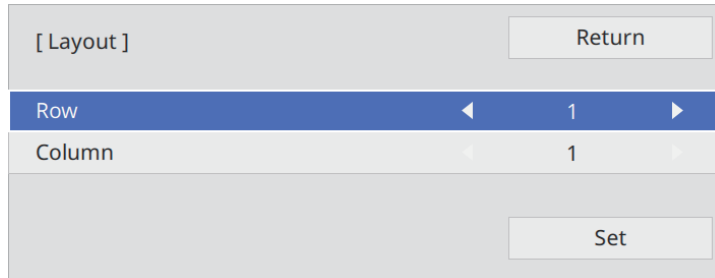

- 4** Select the number of rows and columns you are setting up as the **Row** and **Column** settings. Then select **Set** and press [Enter].

- 5** Repeat the previous steps with each projector you are setting up before continuing with the next step.

- 6** Select **Location Setup** and press [Enter].

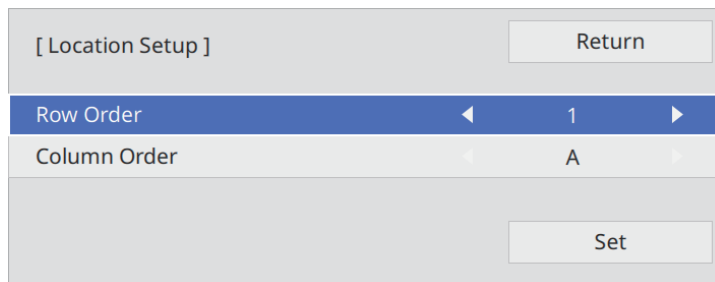

- 7** Select the position of each projected image as follows:
- **Row Order** to layout the screens from top to bottom in sequential order, starting with **1** at the top

- **Column Order** to layout the screens from left to right, starting with **A** on the left

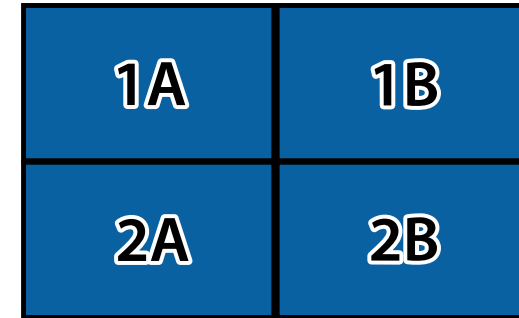

Select **Set** and press [Enter].

- 8** Repeat the previous step with each projector you are setting up before continuing with the next step.

- 9** Select the input signal to display an image.

After performing the steps here, adjust the images for any gaps and differences in color.

## Blending the Image Edges

You can use the projector's Edge Blending feature to create a seamless image from multiple projectors.

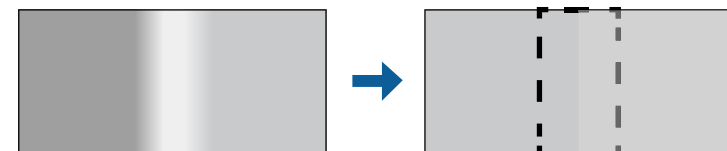

- 1 Press the [Menu] button, select the **Multi-Projection** menu, and press [Enter].

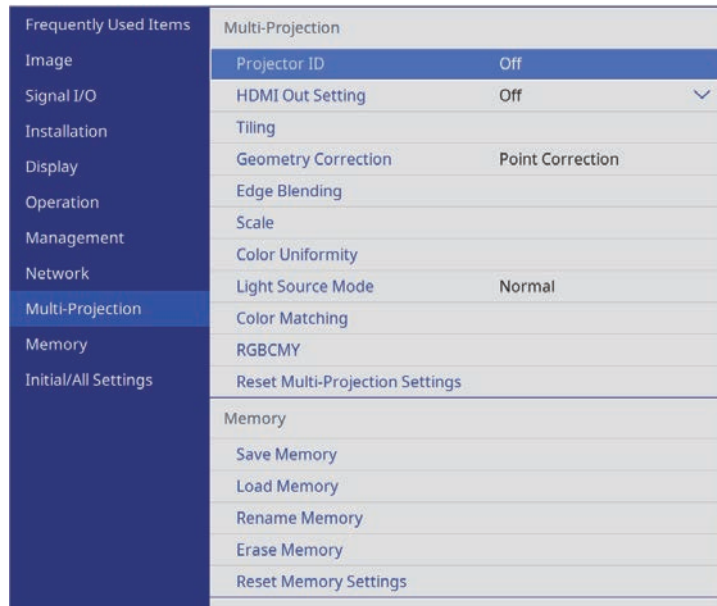

- 2 Select **Edge Blending** and press [Enter].
- 3 Turn on the **Edge Blending**, **Line Guide**, and **Pattern Guide** settings.

 Select the different **Guide Color** setting for each projector so that you can see the blended area clearly.

- 4 Select the edge you want to blend on each projector and press [Enter].

You see a screen like this:



- 5 Select the **Blending** setting and select **On**.
- 6 Select the **Blend Start Position** setting and adjust the blending start position



If you created a unified image area using the edge blending feature, set the **Blend Start Position** setting of the blended edge to **0**.

- 7 Select the **Blend Range** setting and use the arrow buttons to select the width of the blended area so that the displayed guides are at the edges of the overlapping area between the two images.

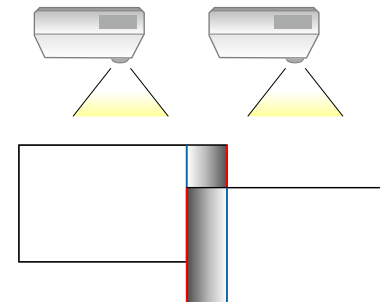

- 8 Press [Esc] to return to the previous screen.

**9** Select the **Blend Curve** setting and select a gradient for the shaded area on the projectors.

**10** When the edges are blended, turn off the **Line Guide** and **Pattern Guide** settings on each projector to check the final settings.

**11** When you are finished, press [Menu].

 If the blended area does not overlap exactly, correct the shape of the blended area using **Point Correction**.

» **Related Links**

- "Adjusting the Black Level" [p.118](#)
- "Modifying the Black Level Adjustment Area" [p.120](#)

## Adjusting the Black Level

You can adjust the brightness and color tone of the areas where the images do not overlap to create a seamless image.

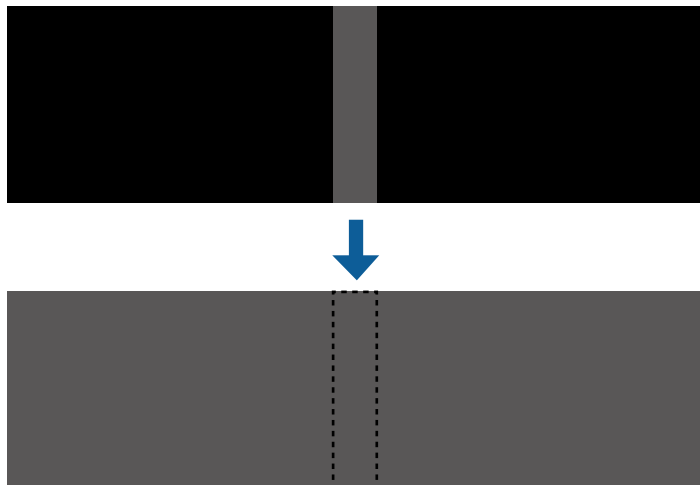

- You cannot adjust the **Black Level** setting when a test pattern is displayed.
- If the **Geometry Correction** value is very large, you may not be able to adjust the **Black Level** correctly.
- The brightness and tone may differ in areas where the images overlap as well as in other areas even after performing the **Black Level** adjustment.
- If you change the **Edge Blending** setting, the **Black Level** setting returns to its default value.
- Available only when at least one of **Top Edge**, **Bottom Edge**, **Left Edge**, and **Right Edge** are set to **On** in the **Edge Blending** settings.

**1** Press the [Menu] button, select the **Multi-Projection** menu, and press [Enter].

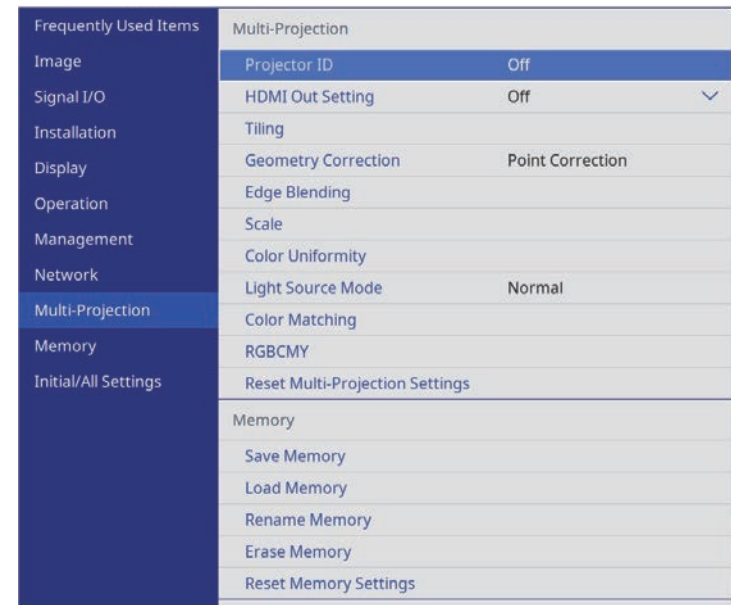

**2** Select **Black Level** and press [Enter].

- 3** Select **Color Adjustment** and press [Enter].  
The adjustment areas are displayed based on the **Edge Blending** setting.
- 4** Use the arrow buttons to select the area you want to adjust and press [Enter].  
The selected area is displayed in orange.

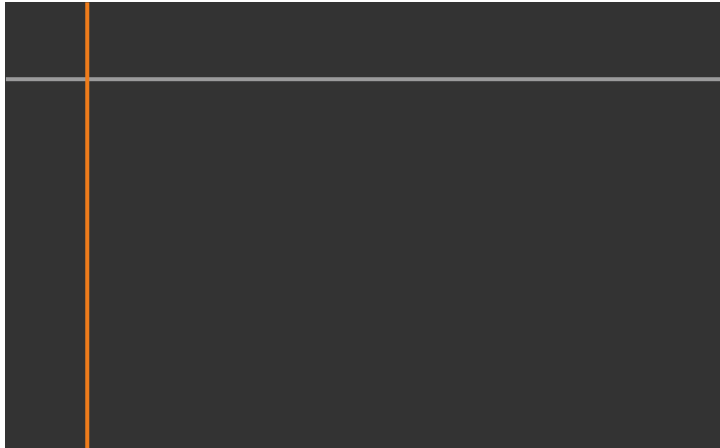

When multiple screens are overlapping, adjust based on the area with the most overlap (the brightest area). In the illustration below, first align (2) with (1), and then adjust so that (3) aligns with (2).

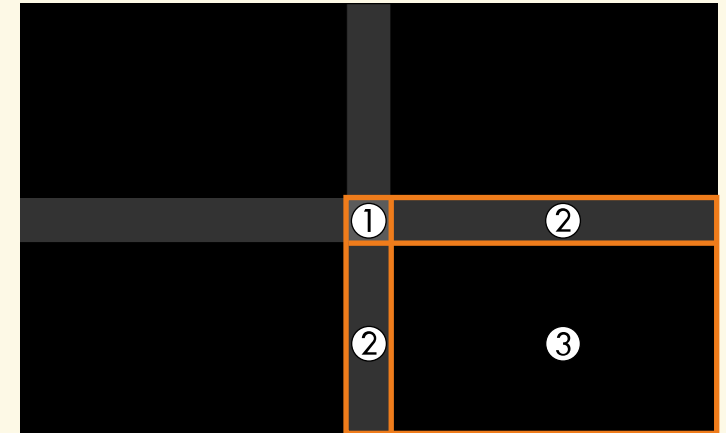

- 5** Adjust the black tone.

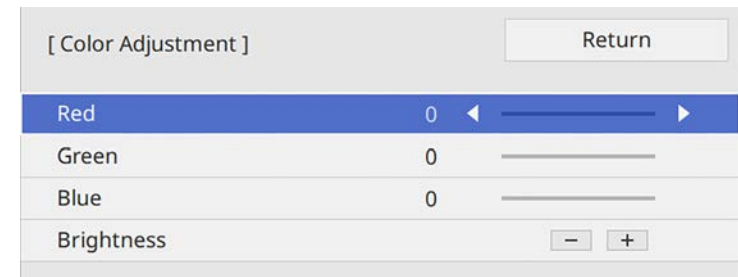

You can use the **Brightness** buttons to adjust the RGB values at the same time.

- 6** Repeat steps 4 and 5 as needed to adjust any remaining screen areas.
- 7** When you are finished, press [Menu].

## Modifying the Black Level Adjustment Area

If there are areas where the color does not match after adjusting the **Black Level** setting, you can adjust them individually.

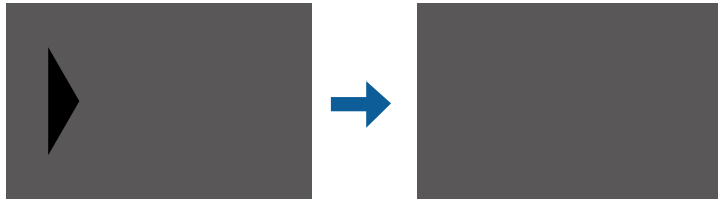

- 1** Select **Area Correction** in the **Black Level** setting and press [Enter].
- 2** Select **Start Adjustments** and press [Enter].  
Boundary lines indicating where images overlap are displayed. The lines are displayed based on the **Edge Blending** setting.
- 3** Use the arrow buttons to select the boundary line you want to adjust. Then press [Enter].  
The selected line is displayed in orange.



- 4** Use the arrow buttons to adjust the line position. Then press [Enter].
- 5** Use the arrow buttons to select the point you want to move. Then press [Enter].

The selected point is displayed in orange.

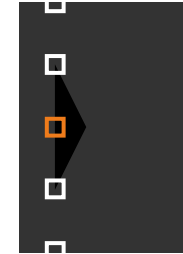

You can change the number of the displayed points using the **Points** setting.

- 6** Use the arrow buttons to move the point.
- 7** To continue to move another point, press [Esc] and then repeat steps 5 and 6.
- 8** To adjust another boundary line, press [Esc] until the screen shown in step 3 is displayed.
- 9** When you are finished, press [Menu].

---

## Matching the Image Colors

You can match the display quality of multiple projectors that will project next to each other.

Before you begin, turn on all the projectors so you can select image quality settings that match on the unified screen.



- 1 Press the [Menu] button, select the **Multi-Projection** menu, and press [Enter].

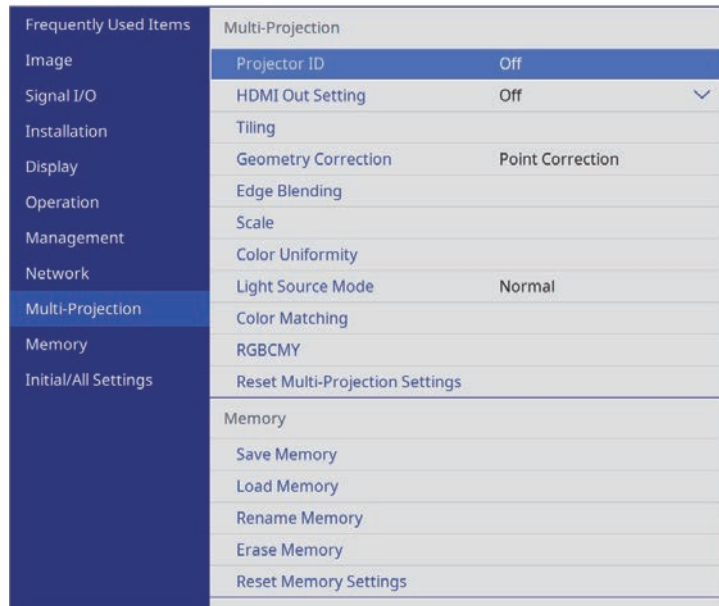

- 2 Select **Color Matching** and press [Enter].

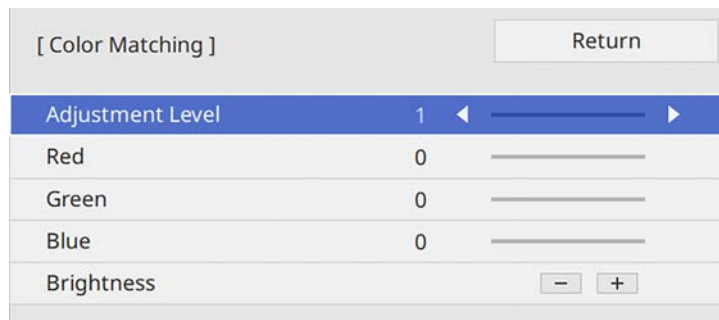

- 3 Set the **Adjustment Level** to 8.

- 4 Select **Brightness** and adjust the value.

- 5 Select **Red**, **Green**, or **Blue** and adjust the color tone, if necessary.

- 6 Go back to the top level menu and select the **Operation** menu and press [Enter].

- 7 Select **Light Source Brightness Control** and press [Enter].

- 8 Set the **Light Source Mode** to **Custom**.

- 9 Adjust the **Brightness Level**.

- 10 Repeat steps 1 through 5 multiple times, each time selecting to adjust levels 7 through 2 in the same way.

- 11 When you are finished, press [Menu].

## Scaling an Image

You can project the same image from multiple projectors and use the **Scale** feature to crop and combine them into one unified image area.

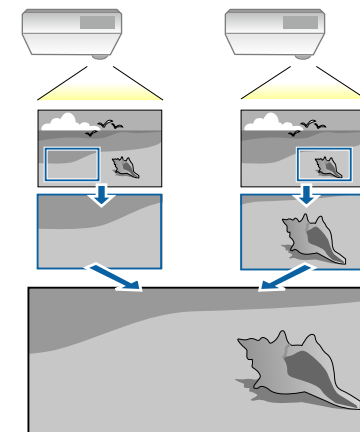

- 1** Input the image signal to display the image.
- 2** Press the [Menu] button, select the **Multi-Projection** menu, and press [Enter].

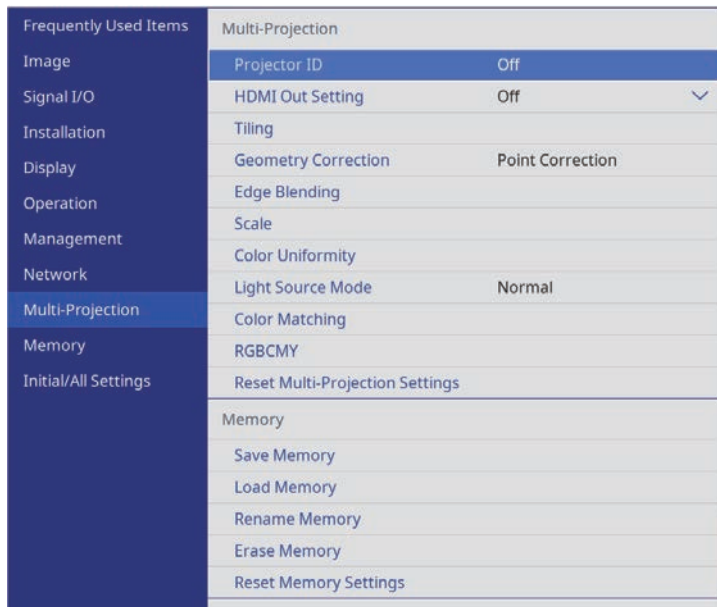

- 3** Select **Scale** and press [Enter].  
You see this screen:

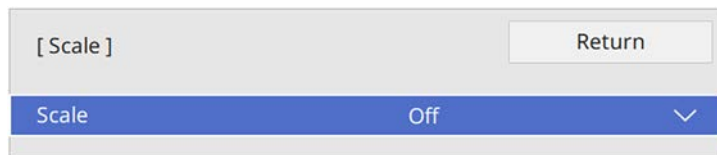

- 4** Choose one of the following options and press [Enter]:
  - **Auto** to set the clip position automatically depending on the **HDMI Out Setting** and **Edge Blending** settings.

- **Manual** to adjust clip ranges and position manually.

- 5** Select the **Scale Mode** setting and select one of these options:

- **Zoom Display** to maintain the image aspect ratio as you scale the image.

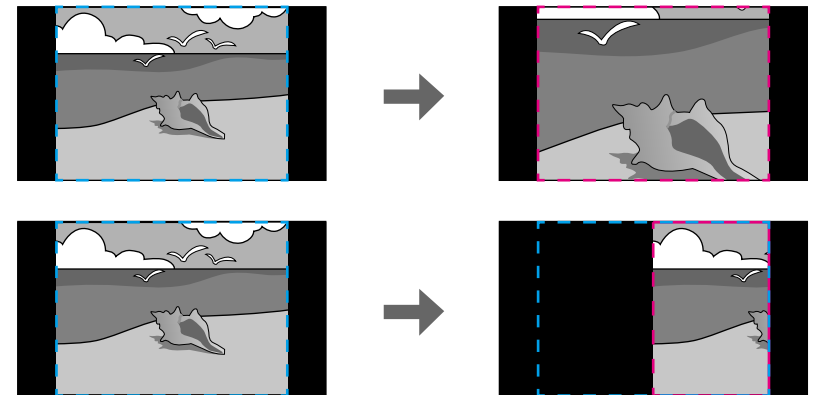

- **Full Display** to adjust the image to the projector's screen size as you scale the image.

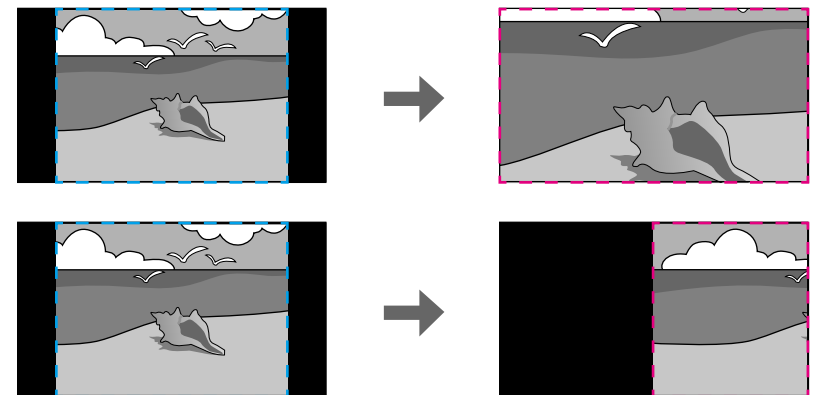

- 6** If you select **Manual**, select one or more of the following scaling options and adjust it as necessary:
  - - or + to scale the image horizontally and vertically at the same time.
  - **Scale Vertically** to scale the image vertically only.
  - **Scale Horizontally** to scale the image horizontally only.
- 7** Select the **Clip Adjustment** setting and use the arrow buttons to adjust the coordinates and size of each image as you view the screen.
- 8** Select **Clip Range** to preview the clipped area you selected.
- 9** When you are finished, press [Menu].

You can secure your projector to deter theft or prevent unintended use by setting up the following security features:

- Password security to prevent people who do not know the password from using the projector, and prevent changes to the startup screen and other settings.  
This acts as an anti-theft function as the projector cannot be used even if it is stolen, and you can limit who can use the projector.
- Button lock security to block operation of the projector using the buttons on the control panel.  
This is useful at events or shows when you want to deactivate all buttons during projection or at schools when you want to limit button operation.
- Security cabling to physically secure the projector in place.

#### » Related Links

- "Password Security Types" [p.124](#)
- "Locking the Projector's Buttons" [p.126](#)
- "Locking the Remote Control Buttons" [p.127](#)
- "Installing a Security Cable" [p.128](#)

## Password Security Types

You can set up the following types of password security using one shared password:

- **Power On Protection** prevents anyone from using the projector without first entering a password. When plugging the power cord and turning on the projector at first time, you must enter the correct password. This also applies to **Direct Power On** and **Auto Power On**.
- **Menu Protection of User's Logo** prevents anyone from changing the custom screen displayed when the projector turns on or receives an input signal. The custom screen deters theft by identifying the projector's owner.
- **Menu Protection of Schedule** prevents anyone from changing the projector's schedule settings.
- **Menu Protection of Network** prevents anyone from changing the projector's **Network** settings.

#### » Related Links

- "Setting a Password" [p.124](#)
- "Selecting Password Security Types" [p.125](#)
- "Entering a Password to Use the Projector" [p.126](#)

## Setting a Password

To use password security, you must set a password.



The default password is set to "0000". Change this to your own password.

**1**

Hold down the [Freeze] button on the remote control for about 5 seconds.

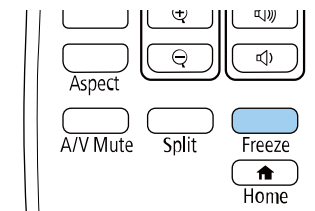

You see the Password Protection setting menu.



If Password Protection is already activated, you must enter the correct password to display the Password Protection setting menu.

- 2** Select **Password** and press [Enter].

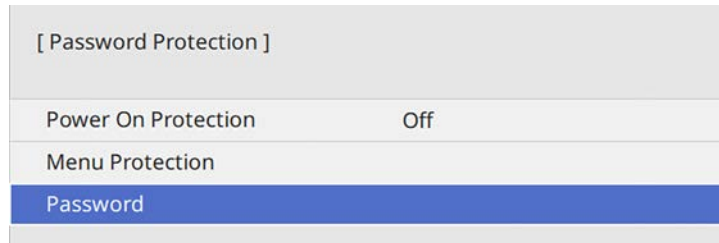

You see the prompt "Change the password?".

- 3** Select **Yes** and press [Enter].



If you select **No**, the Password Protection setting menu is displayed again.

- 4** Hold down the [Num] button on the remote control and use the numeric buttons to set a four-digit password.

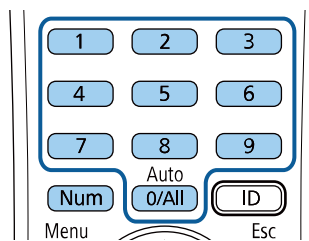

The password displays as \*\*\*\* as it is entered. A confirmation prompt is displayed when you enter the fourth digit.

- 5** Enter the password again.

You see the message "Password accepted". If you enter the password incorrectly, a message is displayed prompting you to re-enter the password.

- 6** Press [Esc] to return to the menu.

- 7** Make a note of the password and keep it in a safe place.

## Selecting Password Security Types

After setting a password, you see this menu, allowing you to select the password security types you want to use.



If you do not see this menu, hold down the [Freeze] button on the remote control for 5 seconds until the menu appears.

- To prevent unauthorized use of the projector, set the **Power On Protection** setting to **On**.
- To prevent changes to the projector's settings, select the **Menu Protection** setting, press [Enter], and select the options as necessary.
- To prevent changes to the User's Logo screen or related display settings, set the **User's Logo** setting to **On**.
- To prevent changes to the projector's schedule settings, set the **Schedule** setting to **On**.
- To prevent changes to projector's network settings, set the **Network** setting to **On**.

You can attach the password protect sticker to the projector as an additional theft deterrent.



Be sure to keep the remote control in a safe place; if you lose it, you will not be able to enter the password.

## Entering a Password to Use the Projector

When the password screen is displayed, enter the correct password.

[ Password ]

Enter the password.

See your documentation for more information.

- 1 Hold down the [Num] button on the remote control while you enter the password using the numeric buttons.

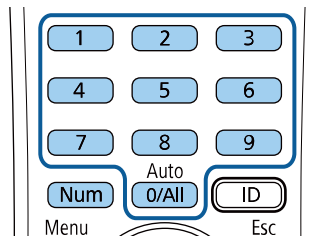

The password screen closes.

- 2 If the password is incorrect, you see a message and a prompt to try again. Enter the correct password to proceed.

### Attention

- If an incorrect password is entered three times in succession, the message "The projector's operation will be locked." is displayed for approximately 5 minutes, and the projector switches to standby mode. If this happens, disconnect the power plug from the electrical outlet, reinsert it, and turn the projector back on. The projector displays the password entry screen again so that you can enter the correct password.
- If you have forgotten the password, make a note of the "Request Code: xxxxx" number that appears on the screen and contact Epson for help.
- If you continue to repeat the above operation and input the wrong password 30 times in succession, the message "The projector's operation will be locked. Contact Epson as described in your documentation." is displayed and the projector does not accept any more password entries. Contact Epson for help.

## Locking the Projector's Buttons

You can lock the buttons on the control panel to prevent anyone from using the projector. The projector can still be operated using the remote control.

- 1 Press the [Menu] button, select the **Management** menu, and press [Enter].

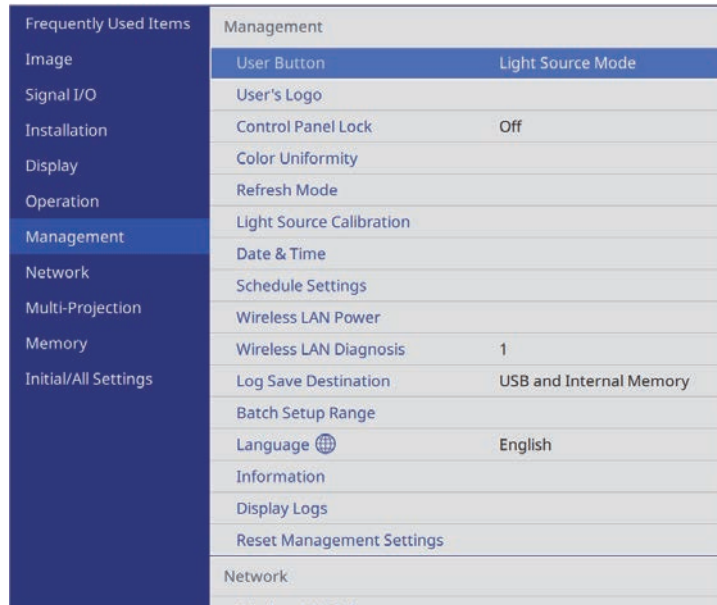

- 2 Select **Control Panel Lock** and press [Enter].
- 3 Select one of these lock types and press [Enter]:
  - To lock all of the projector's buttons, select **Full Lock**.
  - To lock all buttons except the power button, select **Except for Power**.

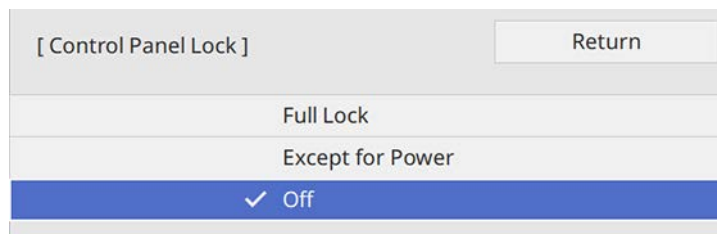

You see a confirmation prompt.

- 4 Select **Yes** and press [Enter].  
The **Control Panel Lock** setting takes effect.

## » Related Links

- "Unlocking the Projector's Buttons" [p.127](#)

## Unlocking the Projector's Buttons

If the projector's buttons have been locked, do one of the following to unlock them.

- Hold down the [Enter] button on the control panel for 7 seconds. A message is displayed and the lock is released.
- Set the **Control Panel Lock** setting to **Off** in the projector's **Management** menu.

---

## Locking the Remote Control Buttons

You can lock some of the buttons on the remote control.

To lock the remote control buttons shown here, press and hold the [Home] button on the remote control for approximately 5 seconds.

To unlock the buttons, press and hold the [Home] button again for approximately 5 seconds.

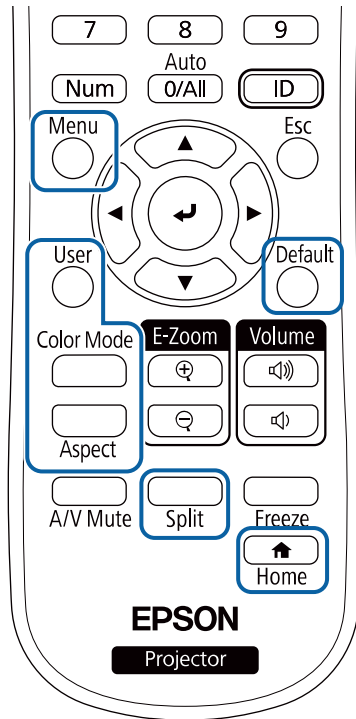

- Use the security cable attachment point on the projector to attach a wire cable and secure it to a room fixture or heavy furniture.

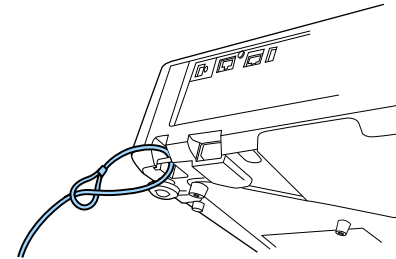

## Installing a Security Cable

You can install the security cable on the projector to deter theft.

- Use the security slot on the projector to attach a Kensington Microsaver Security system.



For more details on the Microsaver Security System, visit the Kensington Web site.

<https://www.kensington.com/>



# Using the Projector on a Network

Follow the instructions in these sections to set up your projector for use on a network.

## ► Related Links

- "Wired Network Projection" [p.130](#)
- "Wireless Network Projection" [p.133](#)
- "Wireless Network Projection from a Mobile Device (Screen Mirroring)" [p.145](#)
- "Secure HTTP" [p.150](#)
- "Screen Sharing" [p.152](#)

You can send images to your projector through a wired network. To do this, connect the projector to your network, and then set up your projector and computer for network projection.

After connecting and setting up the projector as described here, download and install Epson iProjection (Windows/Mac) from the following Web site.

[epson.sn](http://epson.sn)

Epson iProjection software sets up your computer for network projection. It also allows you to hold interactive meetings by projecting user's computer screens over a network. See the *Epson iProjection Operation Guide (Windows/Mac)* for instructions.

► **Related Links**

- "Connecting to a Wired Network" [p.130](#)
- "Selecting Wired Network Settings" [p.130](#)

## Connecting to a Wired Network

To connect the projector to a wired local area network (LAN), use a 100Base-TX or 10Base-T network cable. To ensure proper data transmission, use a Category 5 shielded cable or better.

- 1 Connect one end of the network cable to your network hub, switch, or router.
- 2 Connect the other end of the cable to the projector's LAN port.

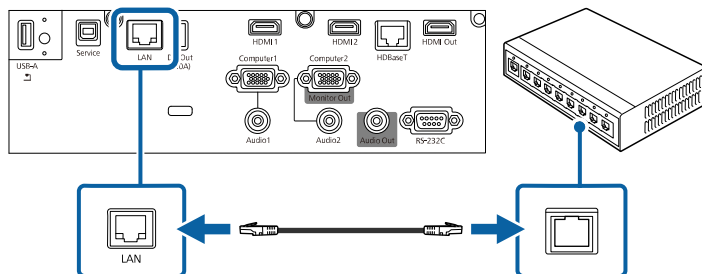

## Selecting Wired Network Settings

Before you can project from computers on your network, you need to select network settings on the projector.



Make sure you already connected the projector to your wired network using the LAN port.

- 1 Press the [Menu] button, select the **Network** menu, and press [Enter].

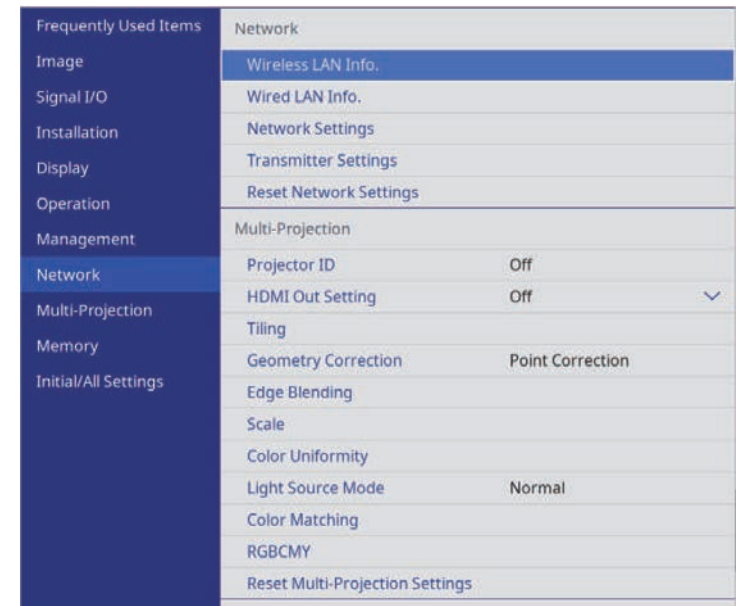

- 2 Select **Network Settings** and press [Enter].
- 3 To identify the projector over the network, select **Projector Name** and enter a name up to 16 alphanumeric characters long.
- 4 Set the **Priority Control Interface** setting to **Wired LAN**.

**5** Select the **Wired LAN** menu and press [Enter].

[ Wired LAN ]		Return
IP Settings		
DNS Server 1	0.0.0.0	
DNS Server 2	0.0.0.0	
IPv6	Off	▼
IP Address Display	On	

**6** Assign the IP settings for your network as necessary.

- If your network assigns addresses automatically, select **IP Settings** to set the **DHCP** setting to **On**.
- If you must set addresses manually, select **IP Settings** to set the **DHCP** setting to **Off**, and then enter the projector's **IP Address**, **Subnet Mask**, and **Gateway Address** as necessary.

**7** To prevent the IP address from being displayed on the network information screen, set the **IP Address Display** setting to **Off**.

**8** Select the **Network Projection** menu and press [Enter].

[ Network Projection ]		Return
Projector Keyword	Off	
Epson iProjection	On	^
SSID Display	On	
Display LAN Info.	Text & QR Code	
Moderator Password		
Keyword Interrupt Display	Off	
Screen Mirroring	On	^
Interrupt Connection	On	
Adjust Image Quality	1 (Fine)	
HDMI Out Image Output	Off	
Screen Mirroring Info.	On	
Message Broadcasting	Off	
Screen Sharing	On	^
Connection Mode	Keyword On	

**9** Turn on the **Projector Keyword** setting if you want to prevent access to the projector by anyone not in the room with it.



When you turn on this setting, you must enter a displayed, randomized keyword from a computer using Epson iProjection to access the projector and share the current screen.

- 10** Set the **Epson iProjection** setting to **On**.

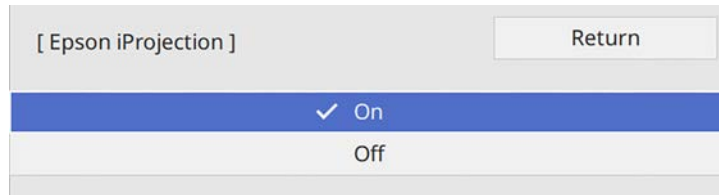

- 11** Select the options as necessary.

- **Display LAN Info.** lets you set the display format for the projector's network information.
- **Moderator Password** lets you enter a four-digit number password for accessing the projector as a moderator using Epson iProjection. (No password is set by default.)
- **Keyword Interrupt Display** lets you select whether to display a projector keyword on the projected image when accessing the projector using Epson iProjection.

- 12** When you finish selecting settings, go back to the **Network Settings** screen, select **Set**, and follow the on-screen instructions to save your settings and exit the menus.

- 13** Press the [LAN] button on the remote control.

The wired network settings complete when you see the correct IP address on the network information screen.

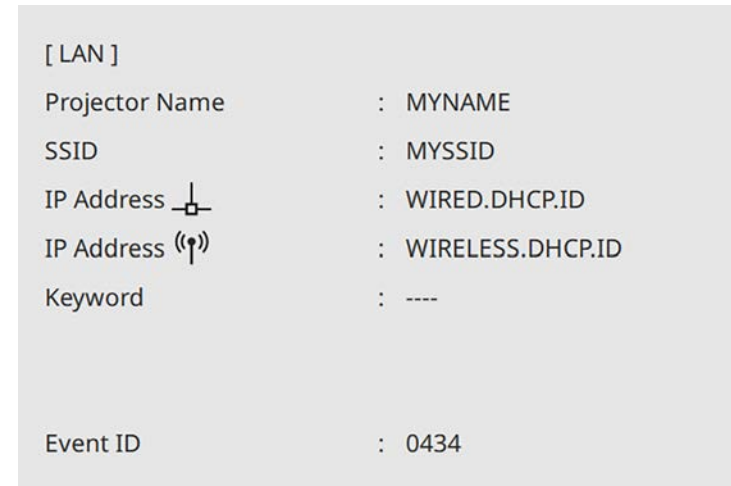

#### ► Related Links

- "Using the Displayed Keyboard" [p.179](#)

You can send images to your projector through a wireless network.

- To do this, you must install the Epson wireless LAN module, and then set up your projector and computer for wireless projection (EB-L720U/EB-L520U).
- Some models have built-in wireless LAN modules (EB-L735U/EB-L730U/EB-L635SU/EB-L630SU/EB-L630U/EB-L530U). You must set up your projector and computer for wireless projection.

You can connect the projector to your wireless network by configuring the connection manually using the projector's **Network** menus.

After setting up the projector, download and install the network software from the following Web site.

[epson.sn](http://epson.sn)

Use the following software and documentation to set up and control wireless projection:

- Epson iProjection (Windows/Mac) software allows you to hold interactive meetings by projecting the computer screens of users over a network. See the *Epson iProjection Operation Guide (Windows/Mac)* for instructions.
- Epson iProjection (iOS/Android) app allows you to project from iOS or Android devices.  
You can download Epson iProjection for free from the App Store or Google Play. Any fees incurred when communicating with the App Store or Google Play are the responsibility of the customer.
- Epson iProjection (Chromebook) app allows you to project from Chromebook devices.  
You can download Epson iProjection from the Chrome Web Store. Any fees incurred when communicating with the Chrome Web Store are the responsibility of the customer.

#### » Related Links

- "Safety Instructions for Built-in Wireless LAN Module" [p.133](#)
- "Installing the Wireless LAN Module" [p.133](#)
- "Connection Methods for Wireless Network Projection" [p.134](#)
- "Selecting Wireless Network Settings Manually" [p.135](#)
- "Setting Up Wireless Network Security for Simple AP Mode" [p.139](#)
- "Setting Up Wireless Network Security for Infrastructure Mode" [p.139](#)

- "Using a QR Code to Connect a Mobile Device" [p.142](#)
- "Using a USB Key to Connect a Windows Computer" [p.142](#)
- "Using the Wireless Presentation System to Connect Windows/Mac Computers" [p.143](#)

---

## Safety Instructions for Built-in Wireless LAN Module

This projector contains built-in wireless LAN modules (EB-L735U/EB-L730U/EB-L635SU/EB-L630SU/EB-L630U/EB-L530U). Be sure to follow these important guidelines when using a wireless LAN connection.

### Warning

- Do not use the device near medical equipment such as pace makers. Furthermore, when using the device, make sure there is no medical equipment such as pace makers, in the surrounding area. Electromagnetic interference may cause medical equipment to malfunction.
- Electromagnetic interference may cause automatically controlled equipment to malfunction which could cause an accident. Do not use the device near automatically controlled equipment such as automatic doors or fire alarms.

### Caution

Make sure you keep a distance of at least 20 cm between the device and your body. Otherwise, it could cause you to feel unwell.

---

## Installing the Wireless LAN Module

To use additional wireless connections (EB-L735U/EB-L730U/EB-L635SU/EB-L630SU/EB-L630U/EB-L530U) and to use the projector over a wireless network (EB-L720U/EB-L520U), install the Epson wireless LAN module. Do not install any other type of wireless LAN module.

## Attention

Never remove the module while its indicator is blue or flashing, or while you are projecting wirelessly. This could damage the module or lose data.



The indicator on the wireless LAN module does not operate. See the wireless LAN indicator on the projector to check the wireless LAN status.

- 1** Use a cross-head screwdriver to remove the screw that secures the wireless LAN module cover.

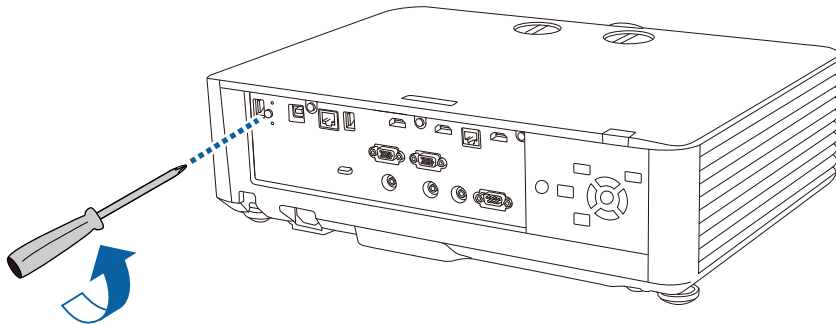

- 2** Connect the wireless LAN module to the USB-A port.

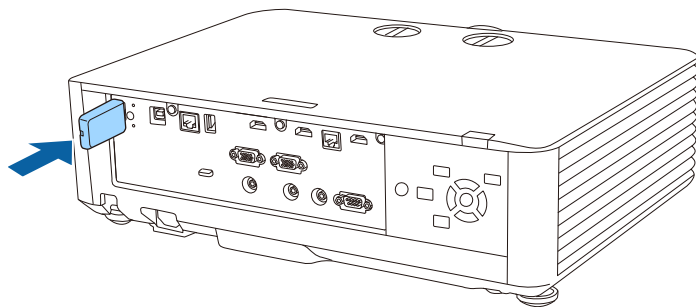

- 3** Attach the cover that comes with your wireless LAN module, and secure it in place with the screw.

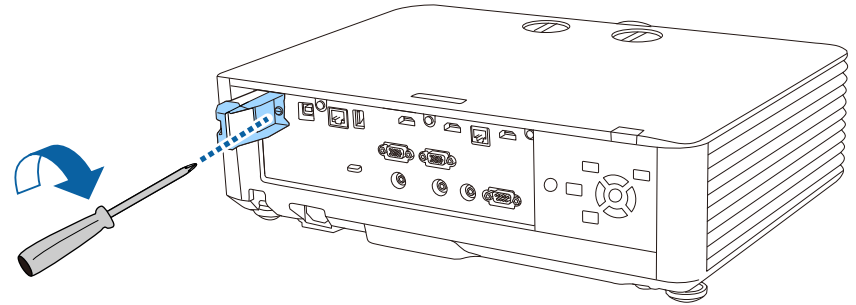

## Connection Methods for Wireless Network Projection

Choose a connection method for connecting your computer and projector over a network based on your network environment.

- Simple AP mode lets you directly connect to smartphones, tablets, or computers using your projector as an access point. When you use this method, connect the projector using **Quick Connection Mode** of the Epson

iProjection software, using Screen Mirroring, or using the optional wireless presentation system.



When monitoring or controlling the projector using wireless LAN in standby mode, connect your computer and projector with infrastructure mode.

Your projector has built-in wireless LAN modules (EB-L735U/EB-L730U/EB-L635SU/EB-L630SU/EB-L630U/EB-L530U). If you install an additional optional wireless LAN module, you can use both network connection methods at the same time. When you install the wireless LAN module, set the **Simple AP** setting to **On**.

☛ **Network > Network Settings > Simple AP**

## Selecting Wireless Network Settings Manually

Before you can project from your wireless network, you need to select network settings for the projector.

- Infrastructure mode lets you connect to smartphones, tablets, or computers over a wireless network access point. When you use this method, connect the projector using **Advanced Connection Mode** of the Epson iProjection software.

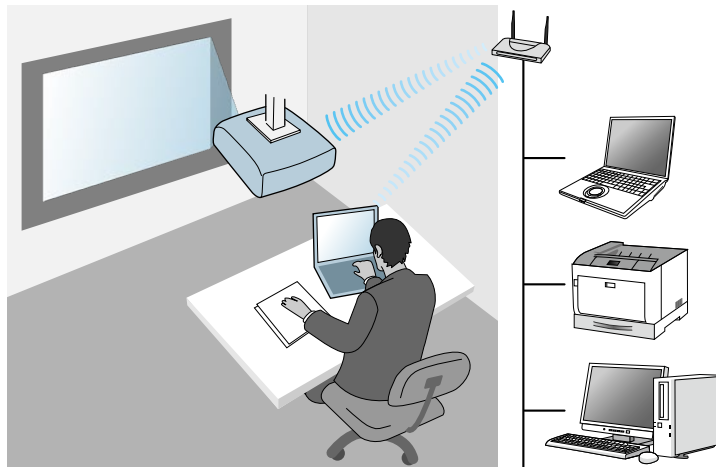

**1** Press the [Menu] button, select the **Management** menu, and press [Enter].



**2** Set the **Wireless LAN Power** setting to **On**.

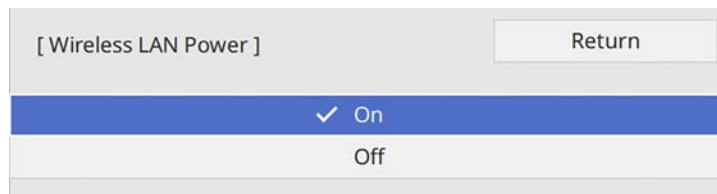

**3** Select the **Network** menu and press [Enter].

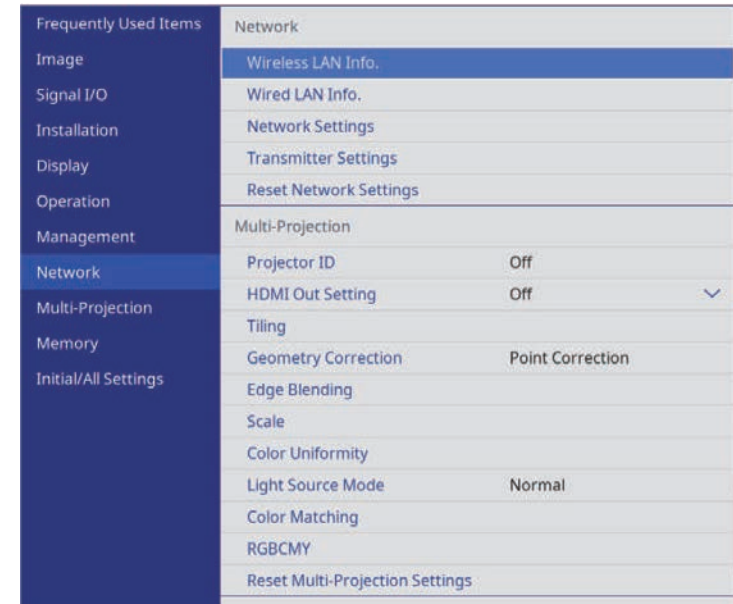

**4** Select **Network Settings** and press [Enter].

**5** To identify the projector over the network, select **Projector Name** and enter a name up to 16 alphanumeric characters long.

**6** Set the **Priority Control Interface** setting to **Wireless LAN**.

**7** Select the connection method.

- For simple AP mode, set the **Simple AP** setting to **On** and go to step 12.
- For infrastructure mode, set the **Simple AP** setting to **Off** and go to next step.
- If you installed the optional wireless LAN module and want to use both connection methods at the same time, set the **Simple AP** setting to **On** and go to next step



(EB-L735U/EB-L730U/EB-L635SU/EB-L630SU/EB-L630U/EB-L530U).

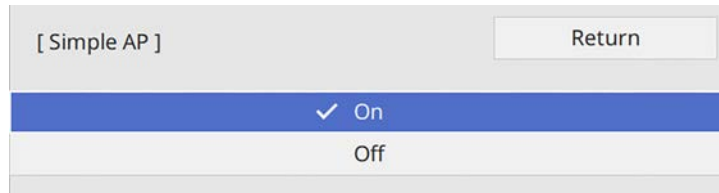

**8** Select the **Wireless LAN** menu and press [Enter].

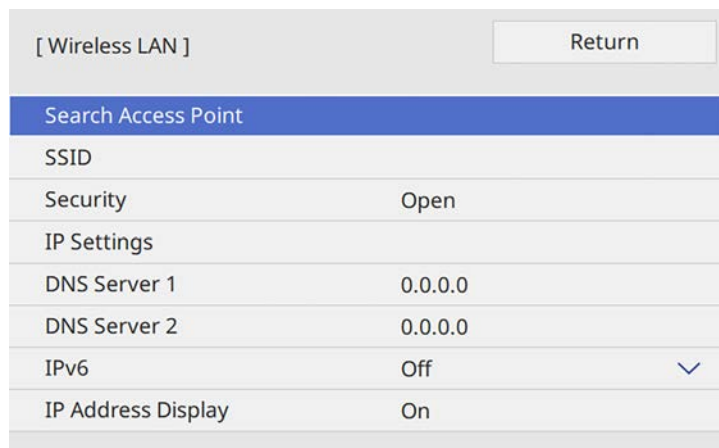

The projector starts searching for access points.

 You can also search for access points using the **Search Access Point** setting manually.

**9** Select the access point you want to connect to.



If you need to assign the SSID manually, select **SSID** to enter the SSID.

- 10** Assign the IP settings for your network as necessary.
- If your network assigns addresses automatically, select **IP Settings** to set the **DHCP** setting to **On**.
  - If you must set addresses manually, select **IP Settings** to set the **DHCP** setting to **Off**, and then enter the projector's **IP Address**, **Subnet Mask**, and **Gateway Address** as necessary.
- 11** To prevent the IP address from being displayed on the network information screen, set the **IP Address Display** setting to **Off**.
- 12** Select the **Network Projection** menu and press [Enter].

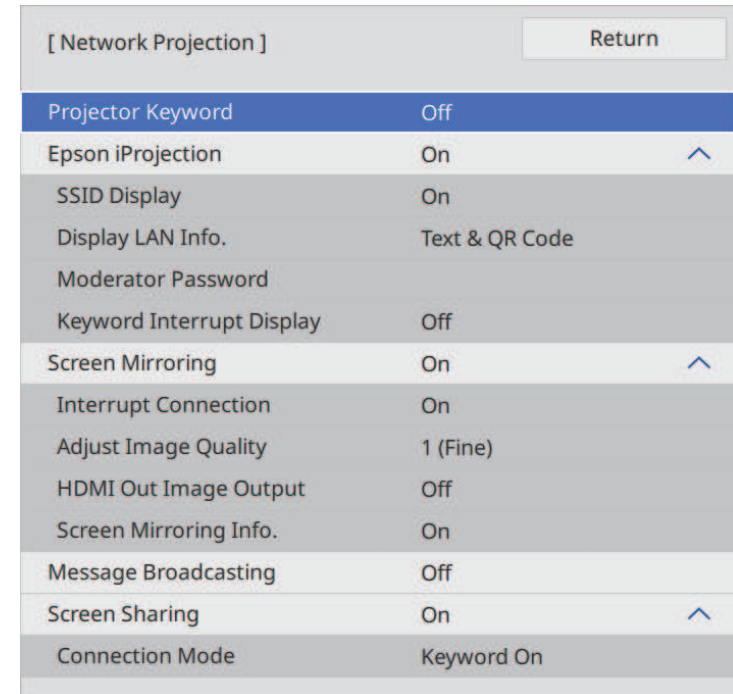

- 13** Turn on the **Projector Keyword** setting if you want to prevent access to the projector by anyone not in the room with it.

 When you turn on this setting, you must enter a displayed, randomized keyword from a computer using Epson iProjection to access the projector and share the current screen.

- 14** Set the **Epson iProjection** setting to **On**.

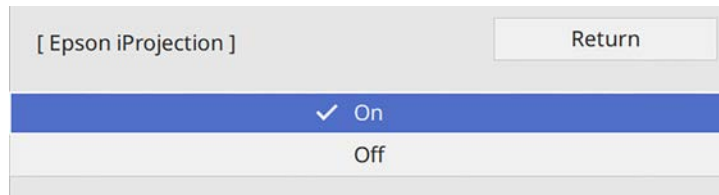

- 15** Select the options as necessary.
- **SSID Display** lets you select whether to display projector's SSID on the network information screen and Home screen.
  - **Display LAN Info.** lets you set the display format for the projector's network information.
  - **Moderator Password** lets you enter a four-digit number password for accessing the projector as a moderator using Epson iProjection. (No password is set by default.)
  - **Keyword Interrupt Display** lets you select whether to display a projector keyword on the projected image when accessing the projector using Epson iProjection.

- 16** When you finish selecting settings, go back to the **Network Settings** screen, select **Set**, and follow the on-screen instructions to save your settings and exit the menus.

- 17** Press the [LAN] button on the remote control.

The wireless network settings are complete when you see the correct IP address on the network information screen.

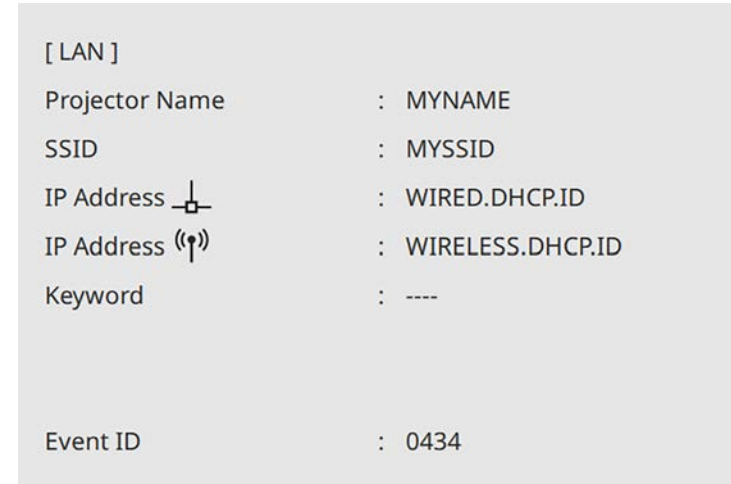

When you have finished making wireless settings for your projector, you need to select the wireless network on your computer. Then start the network software to send images to your projector through a wireless network.

» **Related Links**

- "Selecting Wireless Network Settings in Windows" [p.138](#)
- "Selecting Wireless Network Settings in Mac" [p.139](#)
- "Using the Displayed Keyboard" [p.179](#)

**Selecting Wireless Network Settings in Windows**

Before connecting to the projector, select the correct wireless network on your computer.

- 1** To access your wireless utility software, click the network icon on the Windows taskbar.

**2** When connecting to devices over a wireless network access point, make sure Wi-Fi is turned on and select the network name (SSID) of the network the projector is connecting to.

**3** Click **Connect**.

## Selecting Wireless Network Settings in Mac

Before connecting to the projector, select the correct wireless network in Mac.

**1** Click the Wi-Fi icon on the menu bar at the top of the screen.

**2** When connecting to devices over a wireless network access point, make sure Wi-Fi is turned on and select the network name (SSID) of the network the projector is connecting to.

## Setting Up Wireless Network Security for Simple AP Mode

You can set up security for your projector to use on a wireless network with simple AP mode. You can use WPA2-PSK security.



Contact your network administrator for guidance on entering the correct information.

**1** Press the [Menu] button, select the **Network** menu, and press [Enter].

**2** Select **Network Settings** and press [Enter].

**3** Select **Passphrase**, press [Enter], and enter a passphrase from 8 to 63 characters long.

[ Passphrase ]

1	2	3	4	5	6	7	8	9	0	!	"	#	\$
a	b	c	d	e	f	g	h	i	j	%	&	'	,
k	l	m	n	o	p	q	r	s	t	*	+	(	)
u	v	w	x	y	z	@	.	Space	/	:	SYM2		
A/a										←	→	⌫	

OK Cancel

**4** When you finish entering a passphrase, go back to the **Network Settings** screen, select **Set**, and follow the on-screen instructions to save your settings and exit the menus.

## Setting Up Wireless Network Security for Infrastructure Mode

You can set up security for your projector to use on a wireless network with infrastructure mode. Set up one of the following security types to match the settings used on your network:

- WPA3-PSK security
- WPA2/WPA3-PSK security
- WPA3-EAP security
- WPA2/WPA3-EAP security



Contact your network administrator for guidance on entering the correct information.

**1** If you want to set up WPA3-EAP or WPA2/WPA3-EAP security, make sure your digital certificate file is compatible with projector registration type and placed directly on a USB storage device.

**2** Press the [Menu] button, select the **Network** menu, and press [Enter].

**3** Select **Network Settings** and press [Enter].

**4** Select the **Wireless LAN** menu and press [Enter].

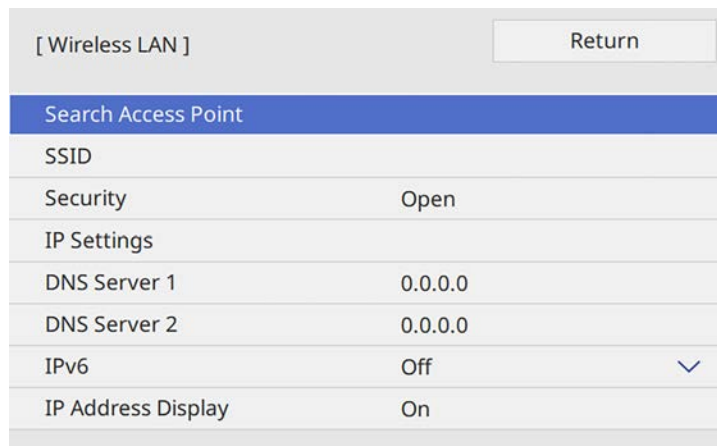

**5** Select the **Security** setting and press [Enter].

**6** Select the security settings to match your network settings.

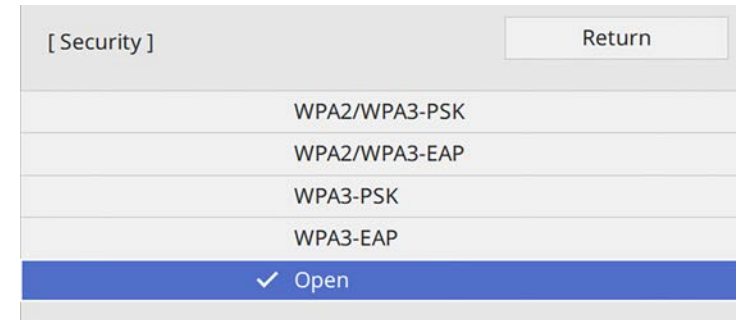

**7** Do one of the following according to the security you selected.

- **WPA3-PSK or WPA2/WPA3-PSK:** Select **Passphrase**, press [Enter], and enter a passphrase from 8 to 63 characters long. Then go to step 16.
- **WPA3-EAP or WPA2/WPA3-EAP:** Select **EAP Type** and press [Enter].

**8** Select the protocol for authentication as the **EAP Type** setting.

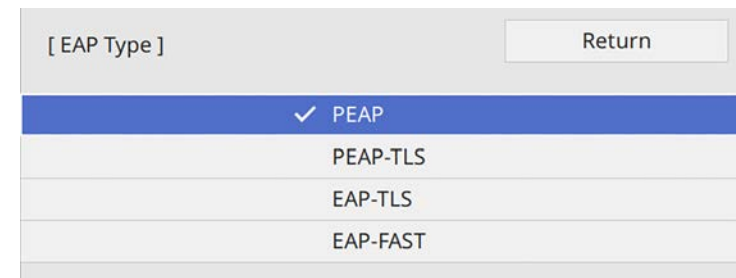

**9** To import your certificate, select the certificate type and press [Enter].

- **Client Certificate** for the **PEAP-TLS** or **EAP-TLS** type
- **CA certificate** for all EAP types



You can also register the digital certificates using your Web browser. However, be sure to register just once or the certificate may not install correctly.

- 10** Select **Save** and press [Enter].
- 11** Follow the on-screen instructions to connect a USB storage device to the projector's USB-A port.
- 12** Press [Enter] to display the certificate list.
- 13** Select the certificate to import using the displayed list.  
A message is displayed prompting you to enter the password for the certificate.
- 14** Enter a password and press [Enter].  
The certificate is imported and a completion message appears.
- 15** Select your EAP settings as necessary.
  - **User name** lets you enter a user name using up to 64 alphanumeric characters. When importing a client certificate, the name the certificate was issued to is automatically set.
  - **Password** lets you enter a password using up to 64 alphanumeric characters for authentication when using the **PEAP** or **EAP-FAST** type.
  - **Verify Server Certificate** lets you select whether or not to verify the server certificate when a CA certificate has been set.
  - **RADIUS Server Name** lets you enter the server name to be verified.
- 16** When you finish making settings, go back to the **Network Settings** screen, select **Set**, and follow the on-screen instructions to save your settings and exit the menus.

## » Related Links

- "Supported Client and CA Certificates" [p.141](#)
- "Registering Digital Certificates from a Web Browser" [p.166](#)

## Supported Client and CA Certificates

You can register these types of digital certificates.

### Client Certificate (PEAP-TLS/EAP-TLS)

Specification	Description
Format	PKCS#12
Extension	PFX, P12
Encryption	RSA
Hashes	MD5/SHA-1/SHA-256/SHA-384/SHA-512
Key length	512/1024/2048/4096 bit
Password	Up to 64 alphanumeric characters; required

### CA Certificate (PEAP/PEAP-TLS/EAP-TLS/EAP-FAST)

Specification	Description
Format	X509v3
Extension	DER/CER/PEM
Encryption	RSA
Hashes	MD5/SHA-1/SHA-256/SHA-384/SHA-512
Key length	512/1024/2048/4096 bit
Encoding	BASE64/Binary

## Using a QR Code to Connect a Mobile Device

After selecting the wireless network settings for your projector, you can display a QR code on the screen and use it to connect a mobile device using the Epson iProjection (iOS/Android) app.



- Make sure you have installed the latest version of Epson iProjection on your device.
- You can download Epson iProjection for free from the App Store or Google Play. Any fees incurred when communicating with the App Store or Google Play are the responsibility of the customer.
- When using Epson iProjection in Quick connection mode, we recommend making security settings.
- Set the **Connection Guide Display** setting to **Off** in the projector's **Network** menu.
  - ☛ **Network > Transmitter Settings > Connection Guide Display**

- 1** Press the [LAN] button on the remote control.  
The QR code is displayed on the projected surface.



- If you do not see the QR code, set the **Display LAN Info.** setting to **Text & QR Code** in the projector's **Network** menu.
  - ☛ **Network > Network Settings > Network Projection > Epson iProjection > Display LAN Info.**
- To hide the QR code, press [Esc].
- When the QR code is hidden, press [Enter] to display the code.

- 2** Start Epson iProjection on your mobile device.
- 3** Read the projected QR code using Epson iProjection to connect it to the projector.



To correctly read the QR code, make sure you face the screen squarely and closely enough so that the projected code fits into the guide of the mobile device's QR code reader. If you are too far from the screen, the code may not be read.

When a connection is established, select **Contents** menu from , and then select the file you want to project.

## Using a USB Key to Connect a Windows Computer

You can set up your USB flash drive as a USB key to quickly connect the projector to a wireless LAN supported Windows computer. After creating the USB key, you can quickly project images from the network projector.

- 1** Set up the USB key using **USB Key Setup Tool** of the Epson iProjection (Windows/Mac) software.



See the *Epson iProjection Operation Guide (Windows/Mac)* for instructions.

- 2** Make sure the wireless LAN module is installed or built into your projector.
- 3** Turn on the projector.
- 4** Press the [LAN] button on the remote control.  
You see the network information screen. Verify that an SSID and IP address are displayed.
- 5** Remove the wireless LAN module from the projector's USB-A port (if installed) and insert the USB key into the same port.  
You see a projected message that the network information update is complete.

**6** Remove the USB key.  
If your projector needs the wireless LAN module, reinsert the wireless LAN module into the projector.

**7** Connect the USB key to a USB port on your computer.

**8** Follow the on-screen instructions to install the necessary application.

 • If the Windows Firewall message is displayed, click **Yes** to disable the firewall.  
• You need administrator authority to install the software.  
• If it is not installed automatically, double-click **MPPLaunch.exe** in the USB key.

After a few minutes, your computer image is displayed by the projector.

**9** When you have finished projecting wirelessly, select the **Safely Remove Hardware** option in the Windows taskbar, and then remove the USB key from your computer.

 You may need to restart your computer to reactivate your wireless LAN connection.

» **Related Links**

- "Getting the Latest Version of the Documents" [p.10](#)

## Using the Wireless Presentation System to Connect Windows/Mac Computers

You can use the optional wireless presentation system to quickly connect the projector to computers wirelessly and project your image. Your wireless presentation system (ELPWP10) includes two wireless transmitters (ELPWT01) and one wireless LAN module (ELPAP11).

See the *Epson Wireless Presentation System User's Guide* for details.

» **Related Links**

- "Setting Up the Wireless Presentation System for the First Time" [p.143](#)
- "Projecting with the Wireless Presentation System" [p.144](#)

## Setting Up the Wireless Presentation System for the First Time

The first time you start using the wireless presentation system, you need to make preparations such as pairing the wireless transmitters with the projector.

 • Select network settings for the projector before pairing.  
• You need to pair the wireless transmitters again when you change **Projector Name** or **Passphrase** in the **Network Settings** menu.  
• You can also pair the wireless transmitters from your computer using the Epson Wireless Transmitter Settings software. See the *Epson Wireless Transmitter Settings Operation Guide* for details.  
• You can download the necessary software and manuals from the following Web site:  
[epson.sn](http://epson.sn)

- 1** Turn on the projector.
- 2** Connect the wireless transmitter to the projector's USB-A port.

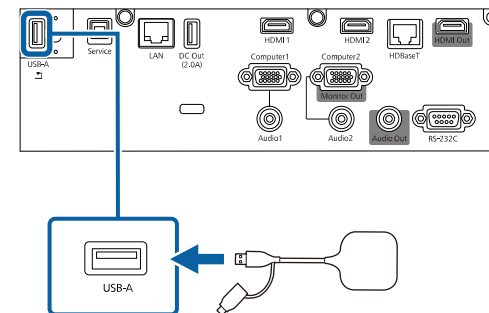

The network information is written and a completion message is displayed. It may take some time to finish pairing.

## Caution

Do not disconnect the power cord or the wireless transmitter from the projector while the network information is being written. If the power cord or wireless transmitter is disconnected, the projector may not start correctly. Make sure the completion message is displayed before disconnecting the wireless transmitter.

**3** Connect the other wireless transmitters if you want to continue pairing.

**4** Select **Yes** to set **Connection Guide Display** to **On** if necessary.



- We recommend selecting **Yes**. The next time you turn on the projector and no signal is being input, the connection guide for the wireless transmitter (Epson Wireless Presentation) is displayed.
- The message prompting you to set **Connection Guide Display** to **On** is displayed when **Connection Guide Display** is set to **Off** and **Content Playback** is set to **Off**.
- You can change the connection guide display from the projector's **Network** menu.  
☛ **Network > Transmitter Settings > Connection Guide Display**

**5** Remove the wireless transmitter from the projector and insert the wireless LAN module into the same port used for the wireless transmitter.

**6** Press the [Menu] button on the control panel or remote control.

**7** Make sure **Wireless LAN Power** is set to **On** in the projector's **Management** menu and **Simple AP** is set to **On** in the projector's **Network Settings** menu.

We recommend turning the projector off and then back on to enable the connection guide display.



If you set the **Auto Power On** setting to **On** in the projector's **Network** menu, you can start projection even if the projector is in standby mode (when the power is off).

☛ **Network > Transmitter Settings > Auto Power On**

## » Related Links

- "Projector Network Settings - Network Menu" [p.195](#)
- "Installing the Wireless LAN Module" [p.133](#)
- "Selecting Wireless Network Settings Manually" [p.135](#)
- "Setting Up Wireless Network Security for Simple AP Mode" [p.139](#)

## Projecting with the Wireless Presentation System

You can use the paired wireless transmitter to quickly establish direct connection between the projector (receiver) and Windows/Mac computers and easily project your images.



Make sure the wireless LAN module is installed into your projector.

- 1** Turn on the projector.
- 2** Connect the wireless transmitter to a USB port on your computer.
- 3** Project your content with the Epson Wireless Presentation software in the wireless transmitter. See the *Epson Wireless Presentation System User's Guide* for details.

## » Related Links

- "Installing the Wireless LAN Module" [p.133](#)



You can send image to your projector from mobile devices such as laptops, smartphones, and tablets using Miracast technology.

You can connect two devices that use Miracast technology at the same time. The projector detects the input sources as Screen Mirroring1 and Screen Mirroring2. You need to set the **Interrupt Connection** setting to **Off**.

☛ **Network > Network Settings > Network Projection > Screen Mirroring > Interrupt Connection**

If your device supports Miracast, you do not need to install any additional software. When using a Windows computer, make sure the necessary adapter for the Miracast connection is available.

Note the following limitations when using Screen Mirroring features.

- You cannot play an interlaced image.
- You cannot play multi-channel audio over 3ch (channel 3).
- You may not be able to project images depending the resolution and frame rate.
- You cannot play 3D video.
- You may not be able to view contents with copyright protection with a Miracast connection depending on your device.
- Do not change the projector's **Screen Mirroring** setting during Screen Mirroring projection. Doing so may cause the projector to disconnect and it may take a while to re-connect.

☛ **Network > Network Settings > Network Projection > Screen Mirroring**

- Do not turn off the projector directly by the breaker during Screen Mirroring projection.



Mobile devices with Android installed or Windows 8.1 or later installed mainly support Miracast.

Support for Miracast varies depending on the mobile device. See your mobile device manual for details.

## ► Related Links

- "Selecting Screen Mirroring Settings" [p.145](#)
- "Connecting Using Screen Mirroring with the Miracast Function" [p.147](#)

- "Connecting Using Screen Mirroring in Windows 10" [p.148](#)
- "Connecting Using Screen Mirroring in Windows 8.1" [p.148](#)

## Selecting Screen Mirroring Settings

You must select **Screen Mirroring** settings for your projector to project images from your mobile device.



If you use Windows 10, you can cast images using the following connections:

- Casting images from your device to the projector directly
- Casting images via local area network

When you cast images via local area network, the connection is more stable and secure. Do one of the following to connect your projector to a local area network:

- Connect a LAN cable.
- Select the **Wireless LAN** setting to connect to the wireless access point.

To connect to a wireless access point, you need to install the optional wireless LAN module.

**1** Press the [Menu] button, select the **Management** menu, and press [Enter].

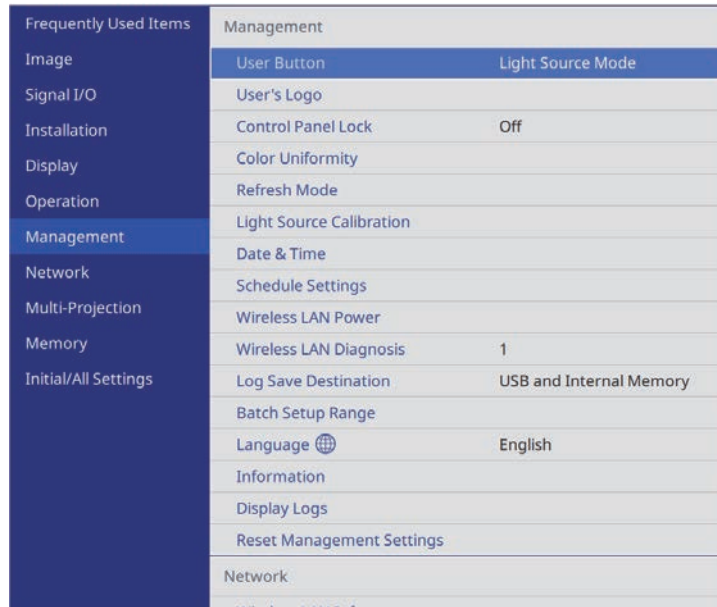

**2** Set the **Wireless LAN Power** setting to **On**.

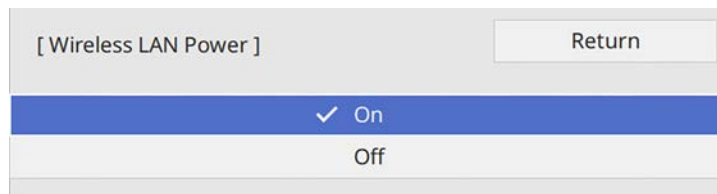

**3** Select the **Network** menu and press [Enter].

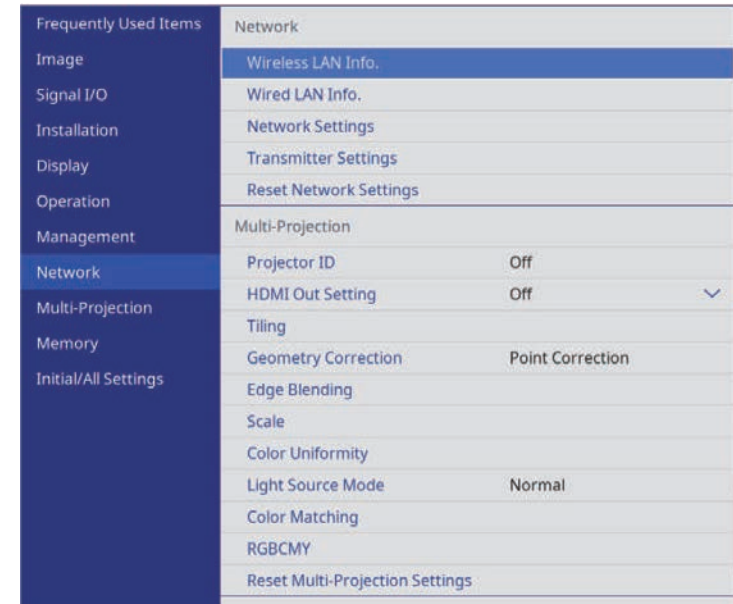

**4** Select **Network Settings** and press [Enter].

**5** Select **Priority Control Interface** and press [Enter].

**6** Choose one of the following options:

- If you cast the data via local area network using the wired LAN, select **Wired LAN**.
- If you cast the data directly or via wireless access point, select **Wireless LAN**.
- If your device only supports casting data directly, select **Wireless LAN**.

- 7** Set the **Simple AP** setting to **On**.

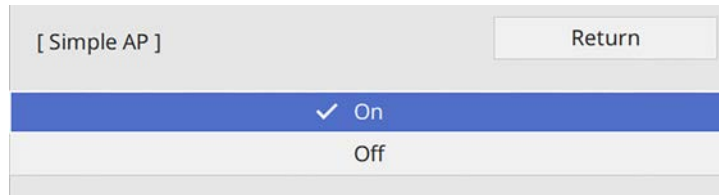

- 8** Go back to the **Network Settings** screen and select **Network Projection**.

- 9** Set the **Screen Mirroring** setting to **On**.

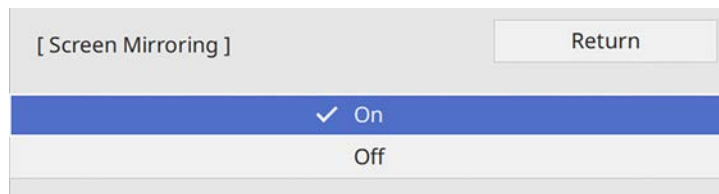

- 10** Select the options as necessary.

- **Interrupt Connection** lets you select to connect to another mobile device during Screen Mirroring projection or to exclusively connect to one device. If you want to use two Screen Mirroring sources, set this to **Off**.
- **Adjust Image Quality** lets you adjust the screen mirroring speed/quality. Select a small number to improve the quality and select large number to increase the speed.
- **HDMI Out Image Output** lets you select to output Screen Mirroring image to the HDMI Out port (EB-L735U/EB-L730U/EB-L635SU/EB-L630SU/EB-L630U/EB-L530U). HDCP and H.265 features are disabled and you may not be able to project content with them. If you want to project content with HDCP and H.265 features, select **Off**.

- **Screen Mirroring Info** displays connection information when projecting the Screen Mirroring source.

- 11** When you finish selecting settings, go back to the **Network Settings** screen, select **Set**, and follow the on-screen instructions to save your settings and exit the menus.

## Connecting Using Screen Mirroring with the Miracast Function

If your mobile device such as a smartphone supports Miracast, you can connect it to the projector wirelessly and project images. You can play audio through the projector's speaker system by connecting using Screen Mirroring.

- 1** Select the **Screen Mirroring** setting on your projector as necessary.
- 2** Press the [LAN] button on the remote control to switch to the Screen Mirroring source.  
You see the network information screen.
- 3** On your mobile device, use your Miracast function to search for the projector.  
You see a list of available devices.
- 4** Select the projector's Projector Name from the list.
- 5** If you see the PIN entry screen on your mobile device, enter the PIN code displayed on the network information screen or at the upper left of the projected image.  
The projector displays the image from your mobile device.



It may take some time until the connection is established. While connecting, do not disconnect the projector's power cord. Doing so may cause your device to freeze or malfunction.

Depending on the mobile device, you may need to delete a device when connecting. Follow the on-screen instructions on your device.

## Connecting Using Screen Mirroring in Windows 10

You can set up your computer for wireless projection and play audio through the projector's speaker system by connecting using Screen Mirroring.

- 1** Select the **Screen Mirroring** setting on your projector as necessary.
- 2** Press the [LAN] button on the remote control to switch to the Screen Mirroring source.  
You see the network information screen.
- 3** Hold down the Windows key and press **K** on your keyboard at the same time.  
You see a list of available devices.

- 4** Select the projector's Projector Name from the list.

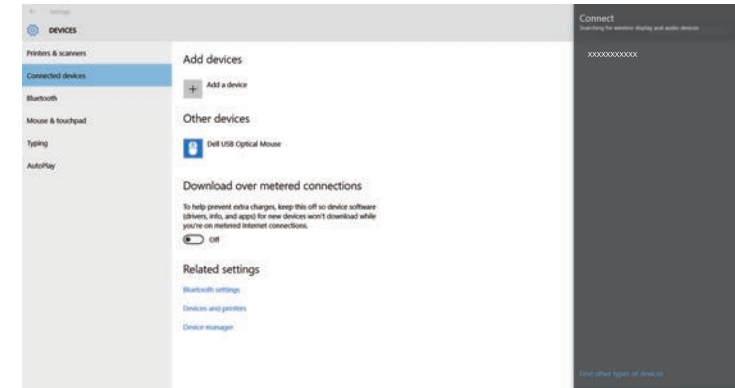

- 5** If you see the PIN entry screen on your computer, enter the PIN code displayed on the network information screen or at the bottom right of the projected image.  
The projector displays the image from your computer.



It may take some time until the connection is established. While connecting, do not disconnect the projector's power cord. Doing so may cause your device to freeze or malfunction.

## Connecting Using Screen Mirroring in Windows 8.1

You can set up your computer for wireless projection from Charms in Windows 8.1. You can play audio through the projector's speaker system by connecting using Screen Mirroring.

- 1** Select the **Screen Mirroring** setting on your projector as necessary.
- 2** Press the [LAN] button on the remote control to switch to the Screen Mirroring source.  
You see the network information screen.

**3** On your computer, select **Devices** from Charms and select **Project**.



**5** Select the projector's Projector Name from the list.

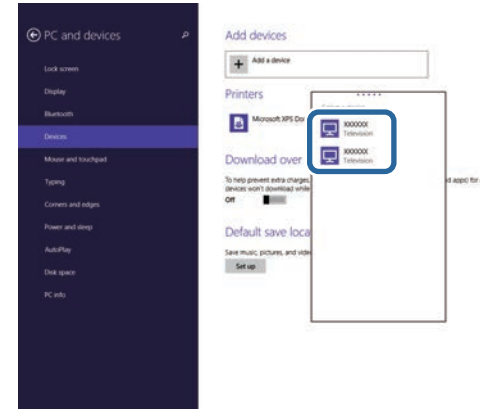

**4** Select **Add a wireless display**.

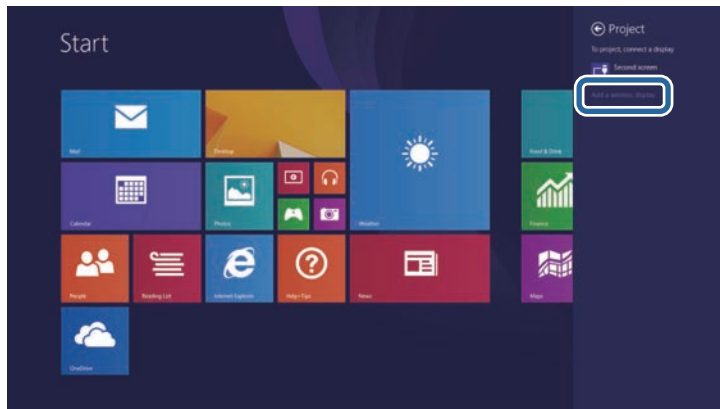

**6** If you see the PIN entry screen on your computer, enter the PIN code displayed on the network information screen or at the bottom right of the projected image.

The projector displays the image from your computer.

 It may take some time until the connection is established. While connecting, do not disconnect the projector's power cord. Doing so may cause your device to freeze or malfunction.

You see a list of available devices.

You can use the HTTPS protocol to increase security between the projector and a Web browser communicating with it. To do this, you create a server certificate, install it on the projector, and turn on the **Secure HTTP** setting in the projector menus to verify the reliability of the Web browser.

#### ☛ **Network > Network Settings > Projector Control > Secure HTTP**

Even if you do not install a server certificate, the projector automatically creates a self-signed certificate and allows communication. However, because the self-signed certificate cannot verify reliability from a Web browser, you see a warning about the server's reliability when you access the projector from a Web browser. This warning does not prevent communication.

#### » **Related Links**

- "Importing a Web Server Certificate Using the Menus" [p.150](#)

## Importing a Web Server Certificate Using the Menus

You can create your Web server certificate and import it using the projector menus and an external storage device.



- You can use a USB flash drive as an external storage device for this model.
- You can also register the digital certificates from your Web browser. However, be sure to register just once or the certificate may not install correctly.

- 1** Make sure your digital certificate file is compatible with projector registration and directly placed on the USB storage device.
- 2** Press the [Menu] button, select the **Network** menu, and press [Enter].
- 3** Select **Network Settings** and press [Enter].

- 4** Select the **Projector Control** menu and press [Enter].

[ Projector Control ]		Return
PJLink	Off	▼
SNMP	Off	▼
AMX Device Discovery	Off	
Crestron Connected	Off	
Control4 SDDP	Off	
Secure HTTP	On	▲
Web Server Certificate		

- 5** Set the **Secure HTTP** setting to **On**.
- 6** Select **Web Server Certificate** and press [Enter].
- 7** Select **Save** and press [Enter].
- 8** Follow the on-screen instructions to connect a USB storage device to the projector's USB-A port.
- 9** Press [Enter] to display the certificate list.
- 10** Select the certificate to import using the displayed list.  
A message is displayed prompting you to enter the password for the certificate.
- 11** Enter a password and press [Enter].  
The certificate is imported and a completion message appears.

#### » **Related Links**

- "Supported Web Server Certificates" [p.151](#)

- "Registering Digital Certificates from a Web Browser" [p.166](#)

### Supported Web Server Certificates

You can register these types of digital certificates.

#### Web Server Certificate (Secure HTTP)

Specification	Description
Format	PKCS#12
Extension	PFX, P12
Encryption	RSA
Hashes	MD5/SHA-1/SHA-256/SHA-384/SHA-512
Key length	512/1024/2048/4096 bit
Common name	Network host name
Organization	Optional
Password	Up to 64 alphanumeric characters; required

You can distribute the currently projected screen image to up to four projectors that are connected to the same network. This allows you to view the image at the same time from other projectors.

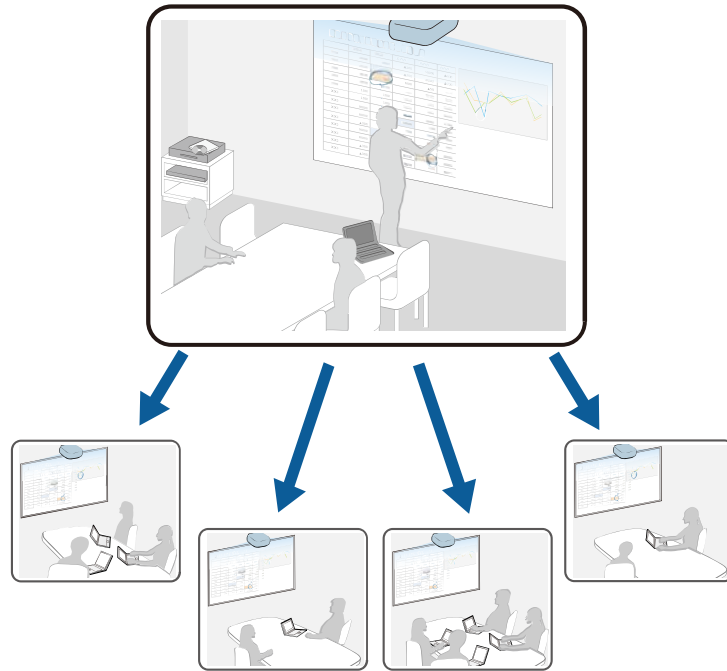

Note the following limitations when using the Screen Sharing function.

- You can share the screen with projectors that support the screen sharing feature.
- If the firmware version amongst the projectors sharing the screen is not the same, you may need to update the projector's firmware to share your screen.
- You cannot distribute images that are protected by HDCP.
- You cannot change the projector's **Network** settings during Screen Sharing.

### ► Related Links

- "Sharing the Screen" [p.152](#)
- "Receiving Shared Screen Images" [p.154](#)

## Sharing the Screen

Before sharing the screen, you need to select settings on your projector.

- Connect the projector to the network.
- Make sure the **Screen Sharing** setting is set to **On**.  
 ☛ **Network > Network Settings > Network Projection > Screen Sharing**
- If you want to skip authentication of keywords for other projectors so you can quickly connect to them, set the **Connection Mode** setting to **Keyword Off**.  
 ☛ **Network > Network Settings > Network Projection > Screen Sharing > Connection Mode**

- 1** Turn on the projector and display an image.
- 2** Press the [Home] button.
- 3** Select **Screen Sharing**.

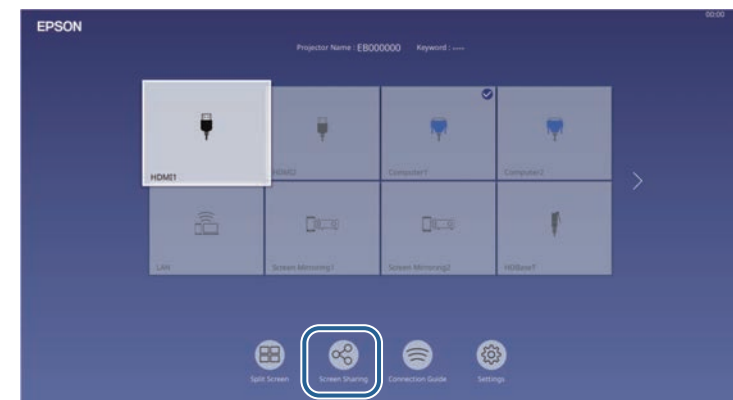



**4** Select **Start Screen Sharing**.

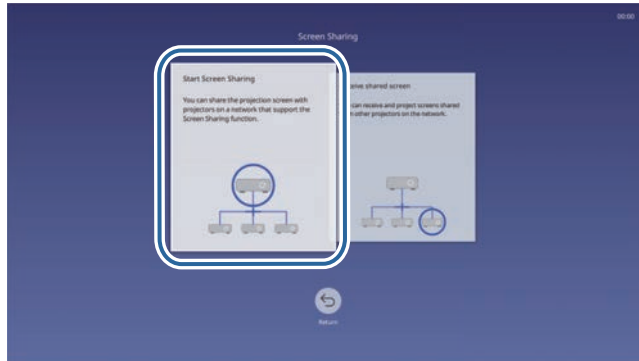

**5** Specify the projector you want to share your screen with.

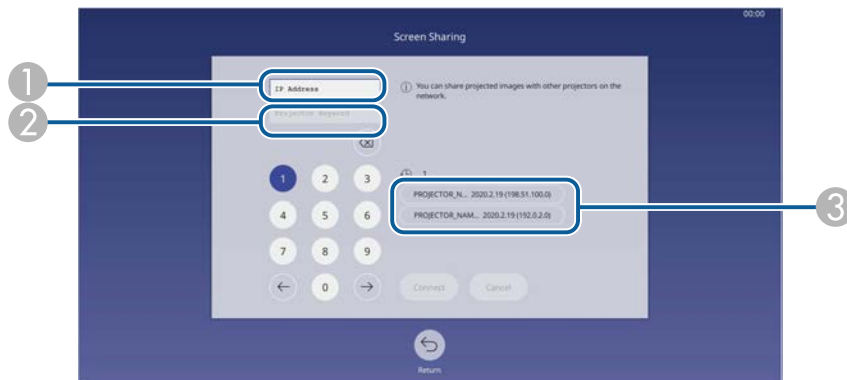

- 1 Enter the IP address using the numeric keypad.
- 2 Enter the projector keyword using the numeric keypad, if required. The projector keyword is displayed on the projected image of the receiving projector.
- 3 Displays the connection history. To connect to a projector that you have previously connected to, select the IP address from the displayed list.

**6** Select **Connect**.

When the connection is established, the bar indicating the shared status appears at the upper right of the screen. You can drag and drop the shared status bar position.

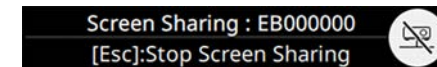

**7** Repeat steps 3 and 6 as needed to connect to more projectors.

**8** Select the input source to project images you want to share.

The image is distributed to the receiving projectors.

» **Related Links**

- "Finishing the Screen Sharing" [p.153](#)

## Finishing the Screen Sharing

To finish sharing, select the  icon on the shared status bar. This option disconnects all projectors at one time. If you want to disconnect specific projector, follow the steps below.

**1** Press the [Home] button.

## 2 Select Screen Sharing.

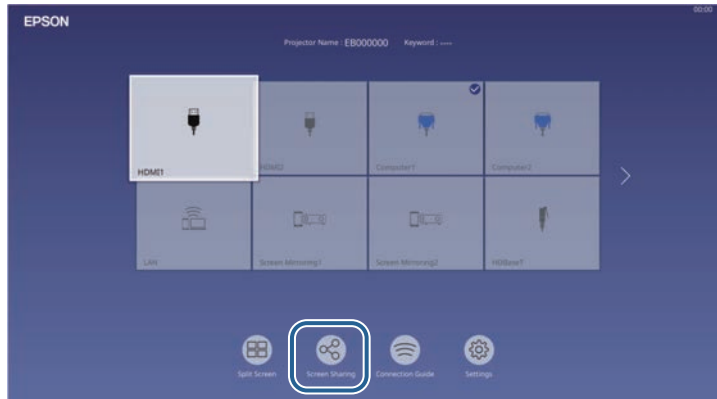

## 3 Select the projector you want to disconnect and select **Disconnect**.

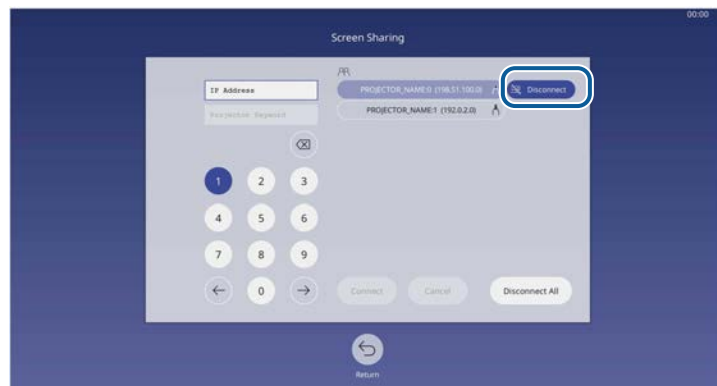

The selected projector is disconnected and screen sharing finishes to this projector.

## 4 Repeat step 3 as needed to disconnect to more projectors.



When you select **Disconnect All**, the button changes to **Confirm**. Select the button again to disconnect all projectors.

## Receiving Shared Screen Images

Before receiving the screen, you need to select settings on your projector.

- Connect the projectors to the same network as the projector that is sharing images.
- Make sure that no other device is connecting to the projector using the Epson iProjection software.
- Make sure the **Screen Sharing** setting is set to **On**.
  - **Network > Network Settings > Network Projection > Screen Sharing**

When the other projector starts sharing screen, the shared screen image is automatically displayed.

If not, press the [LAN] button on the remote control.

To remove the shared image during projection, press the [Esc] button.



If you do not have the IP address for your projector, press the [Home] button and select **Screen Sharing**. You can check the IP address displayed on the guide screen.

# Monitoring and Controlling the Projector

Follow the instructions in these sections to monitor and control the projector over a network.

## ► Related Links

- "Epson Projector Management" [p.156](#)
- "Controlling a Networked Projector Using a Web Browser" [p.157](#)
- "Registering Digital Certificates from a Web Browser" [p.166](#)
- "Setting Up Projector Network E-Mail Alerts" [p.168](#)
- "Setting Up Monitoring Using SNMP" [p.169](#)
- "Using ESC/VP21 Commands" [p.170](#)
- "PJLink Support" [p.171](#)
- "Crestron Connected Support" [p.172](#)
- "Operating the Projector Using Web API" [p.173](#)
- "Setting Projector Event Schedules" [p.174](#)

Epson Projector Management software (Windows only) lets you monitor and control your projector through the network. See the *Epson Projector Management Operation Guide* for instructions.

You can download Epson Projector Management from the following Web site.

[epson.sn](http://epson.sn)

Once you have connected your projector to your network, you can select projector settings and control projection using a compatible Web browser. This lets you access the projector remotely.

In Content Playback mode, you can also edit playlists.

## Attention

In Content Playback mode, do not remove the USB flash drive from the projector or disconnect the projector's power cord in the following situations. Data saved on the USB flash drive may be damaged.

- When the **Playlists** screen is displayed
- When the **USB Memory Device** screen is displayed



- Make sure the computer and projector are connected to the network. If you are connecting wirelessly, connect to devices over a wireless network access point.
- You can use the following Web browsers.
  - Internet Explorer 11 or later (Windows)
  - Microsoft Edge (Windows)
  - Safari (Mac, iOS)
  - Chrome (Android)
- While using the Web browser, do not connect using a proxy server. You cannot select all of the projector menu settings or control all projector functions using a Web browser.
- If you set the **Standby Mode** setting to **Communication On** in the projector's **Operation** menu, you can use a Web browser to select settings and control projection even if the projector is in standby mode (when the power is off).
- You can also control the projector using a Web browser through the Epson iProjection (iOS/Android) app.

- 1** Make sure the projector is turned on.
- 2** Make sure your computer or device is connected to the same network as the projector.
- 3** Start your Web browser on the computer or device.

- 4** Go to the **Epson Web Control** screen by entering the projector's IP address into the browser's address box. When entering an IPv6 address, wrap the address with [ and ].

You see the **Epson Web Control** screen.

- In normal mode

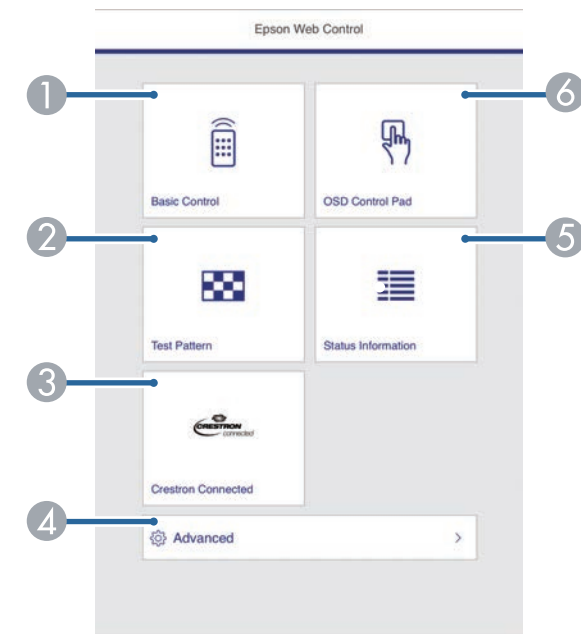

- 1** Controls the projector remotely.
- 2** Displays a test pattern.
- 3** Opens the Crestron Connected operation window. Available only when you set the Crestron Connected system.
- 4** Sets detailed projector settings.
- 5** Displays the projector's status.
- 6** Operates the projector's menu settings with your finger or mouse.



You can also check the projector's log files by entering "https://<projector's IP address>/logs/" into your browser's URL bar when you set **Log Save Destination** to **USB and Internal Memory** in the projector's **Management** menu.

- In Content Playback mode

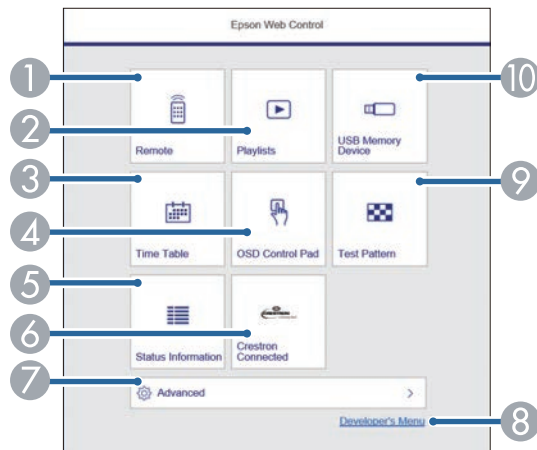

- 1 Controls the projector remotely.
- 2 Selects the playlist you want to play, and allows you to create or edit playlists.
- 3 Displays the **Time Table** screen.
- 4 Operates the projector's menu settings with your finger or mouse.
- 5 Displays the projector's status.
- 6 Opens the Crestron Connected operation window. Available only when you set the Crestron Connected system.
- 7 Sets detailed projector settings.
- 8 Displays the **Developer's Menu** screen.
- 9 Displays a test pattern.
- 10 Registers or deletes the data for a playlist on the USB flash drive.

- 5 Select the option corresponding to the projector function you want to control.



- You may need to log in to access some of the options on the **Epson Web Control** screen. If you see a log in window, enter your user name and password.
- When accessing the **Basic Control** option, the user name is **EPSONREMOTE** and the default password is **guest**.
- When accessing other options, the user name is **EPSONWEB** and the default password is **admin**.
- You can change the password in the projector's **Network** menu.
  - ☛ **Network > Network Settings > Remote Password**
  - ☛ **Network > Network Settings > Web Control Password**

## » Related Links

- "Web Control Options" p.158

## Web Control Options

### Basic Control

Options on the **Basic Control** screen allow you to select the input source and control the projector.



- If you see a log in window, enter your user name and password. (The user name is **EPSONREMOTE** and the default password is **guest**.)
- You can change the password in the projector's **Network** menu.  
 🖱️ **Network > Network Settings > Remote Password**

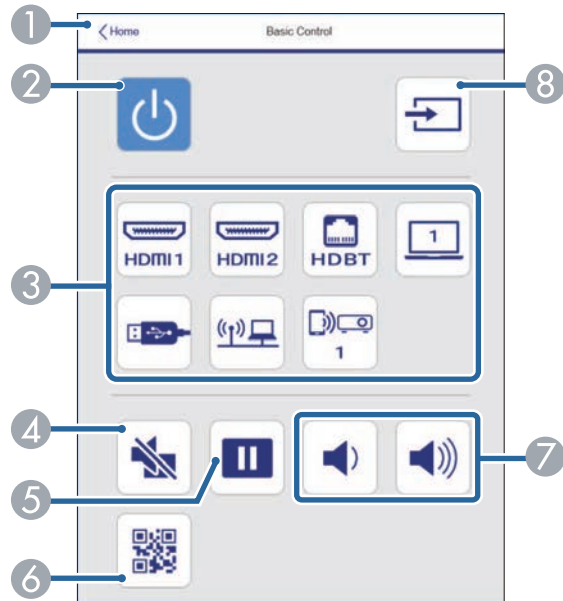

- 1 Returns to the **Epson Web Control** screen.
- 2 Turns the projector on or off.
- 3 Selects the input source. (The available sources vary depending on your projector model.)
- 4 Turns the video and audio on or off temporarily.
- 5 Pauses or resumes images.
- 6 Displays the QR code.
- 7 Adjusts the speaker volume.
- 8 Searches for sources.

## OSD Control Pad

Options on the **OSD Control Pad** screen allow you to display the projector's setting menus and select them moving your finger or mouse on the pad.

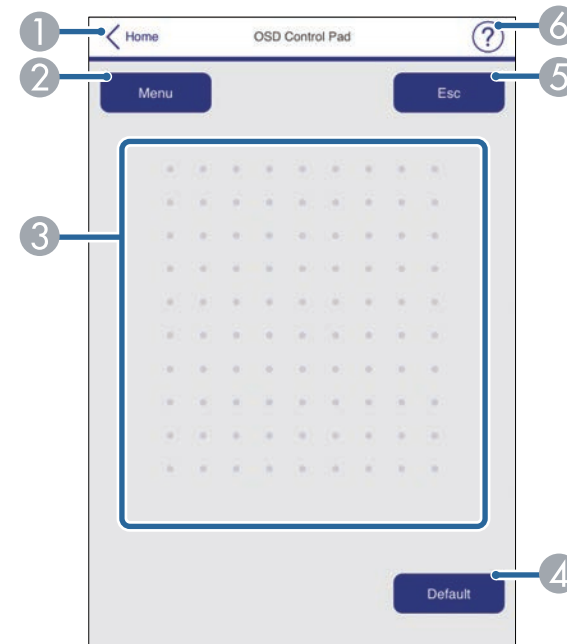

- 1 Returns to the **Epson Web Control** screen.
- 2 Displays the projector's setting menus.
- 3 Use your finger or mouse to navigate the menus.
- 4 Resets the selected setting to its default value.
- 5 Returns to the previous menu.
- 6 Displays help topics.

## Test Pattern

The **Test Pattern** screen displays the available test patterns and allow you to select to project it.

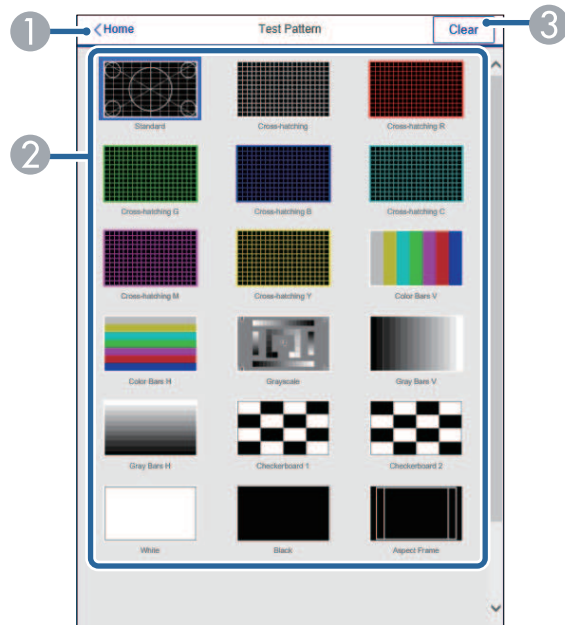

- ① Returns to the **Epson Web Control** screen.
- ② Displays available test patterns; select to project a test pattern.
- ③ Turns off test pattern display.

## Status Information

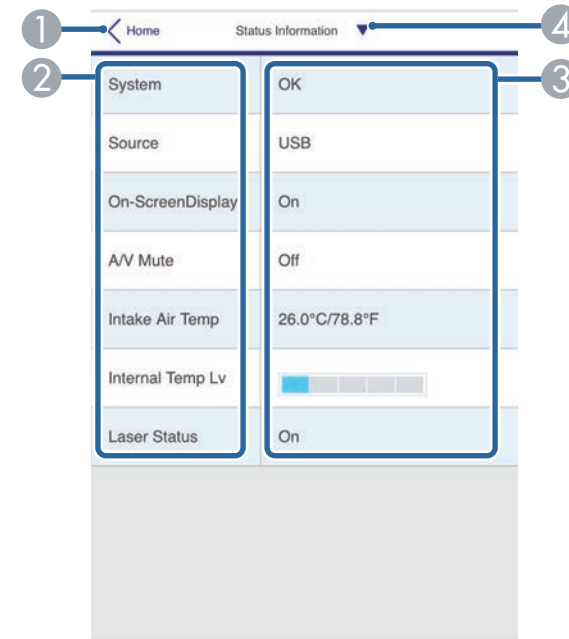

- ① Returns to the **Epson Web Control** screen.
- ② Displays a list of monitored settings.
- ③ Displays the setting status.
- ④ Select to view different status information.

## Advanced

The **Advanced** screen allow you to select the projector's settings.





If the default **Web Control Password** is set, a screen prompting to change the password appears before you can view the **Advanced** screen. Follow the on-screen instructions to change the password. It is strongly recommended to change password regularly to prevent an unauthorized access to your projector.

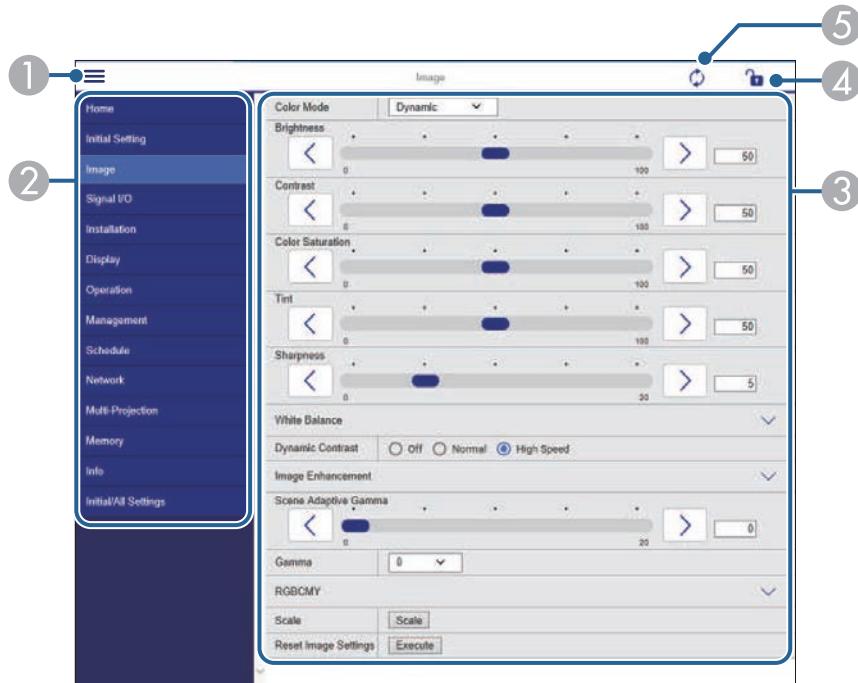

- 1 Opens the menus.
- 2 Displays the menu name you selected.
- 3 Specifies the projector settings. (The available settings vary depending on your projector model.)
- 4 Lock/unlock the projector settings.
- 5 Updates the projector settings.



You cannot change the following settings using Epson Web Control.

- EDID
- HDMI Link
- Fixed Installation
- Image Shift (EB-L635SU/EB-L630SU)
- Split Screen Setting
- Content Playback
- User Button
- User's Logo
- Wireless LAN Diagnosis
- Language
- Search Access Point
- Crestron Connected
- HDBaseT Signal Level
- Event ID
- HDBaseT Tx
- Antenna Level
- Start Pairing
- Reset Network Settings
- Firmware Update



You can select the following settings only with Epson Web Control.

- Monitor Password (up to 16 alphanumeric characters)
- IPv6 Settings (manual)
- HTTP port (port number used for Web Control except for 80 [default], 843, 3620, 3621, 3625, 3629, 4352, 4649, 5357, 10000, 10001, 41794)

## Remote (only in Content Playback mode)

Options on the **Remote** screen allow you to select the input source, control the projector, and start projecting playlists.



- 1 Returns to the **Epson Web Control** screen.
- 2 Turns the projector on or off.
- 3 Selects the input source. (The available sources vary depending on your projector model.)
- 4 Turns the video and audio on or off temporarily.
- 5 **Overlay Effect** option is displayed when the current source is anything other than USB.

Turns **Overlay Effect** on or off to add color and shape effects to a playlist.

When turning on, the **Effects** screen is displayed. You can add predefined color and shape effect filters to a playlist. You can also create a customized effect.

- 6 Specifies the screen settings.
- 7 Displays your favorite playlists. Select a playlist to start projecting.
- 8 Displays information for the playlist being projected.  
The icons indicate the playlist settings.  
  - : Overlay effects have been applied
  - : Repeat playback has been applied
  - : Length of the playlist
 Select the arrow at the bottom-left to display the following screen.
- 9 Adjusts the speaker volume.

## Screen displayed while projecting playlist (only in Content Playback mode)

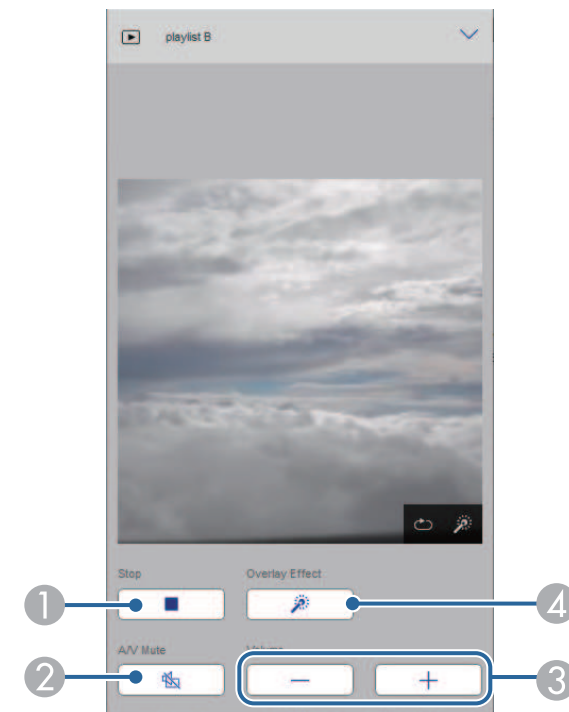

- ① Stops projection.
- ② Turns the video and audio on or off temporarily. However, the audio and video continue to run so you cannot resume projection at the point you activated this function.
- ③ Adjusts the speaker volume.
- ④ Opens the **Effects** screen. You can select preset effects or select individual brightness, color, and shape effect filters.

### Playlist (only in Content Playback mode)

Options on the **Playlist** screen allow you to select the playlist you want to play from the list, and create or edit playlists.

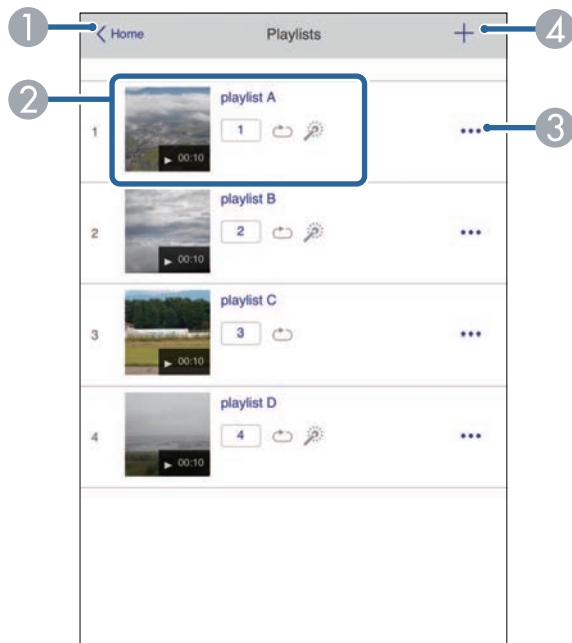

- ① Returns to the **Epson Web Control** screen.

- ② Starts projecting the playlist.  
The icons indicate the playlist settings.  
  - ①: Number assigned to your favorite playlists
  - 🔄: Repeat playback has been applied
  - ⚙️: Overlay effects have been applied
- ③ Opens the menu that allows you to edit, copy, register to your favorites, or delete the playlist.  
When you select **Edit** or **Duplicate**, the edit playlist screen is displayed.
- ④ Opens the create playlist screen where you can create a new playlist.

### Create or edit playlist screen (only in Content Playback mode)



- ① Edits the playlist name.

- ② Selects whether to enable repeat playback or not.
- ③ Registers the playlist as favorites.  
When registering favorites, you can quickly start playback of the favorite playlist using the **Remote** screen or the remote control.
- ④ Displays the images or movies you have added to the playlist. The playlist plays the images or movies in order.
- ⑤ Adds images or movies to the playlist.
- ⑥ Deletes images or movies from the list.
- ⑦ Opens the **Switch Image** screen.  
You can specify the time interval to switch to the next image file. You can also select a transition effect.
- ⑧ Opens the **Effects** screen.  
You can add predefined color and shape effect filters to a playlist. You can also create a customized effect.
- ⑨ Previews the playlist.

## USB Memory Device (only in Content Playback mode)

Options on the **USB Memory Device** screen allow you to upload data for a playlist to the USB flash drive or delete the data on the USB flash drive.



You can upload .avi, .jpeg (.jpg), .png, .bmp, or .gif files.

If you want to add the .mp4 and .mov files to the playlist, use the Epson Projector Content Manager software or the Epson Creative Projection app.

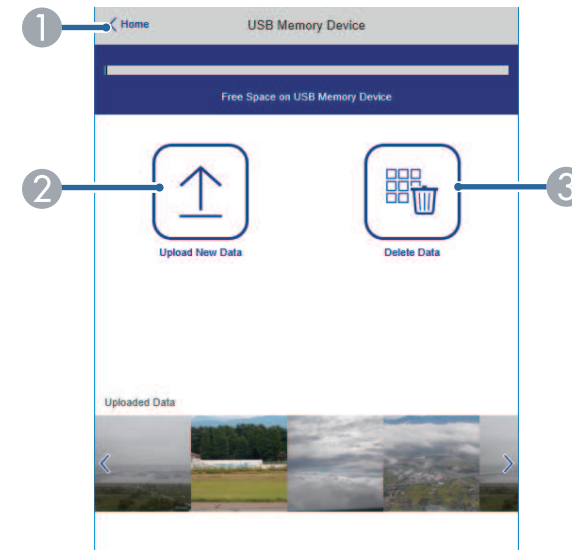

- ① Returns to the **Epson Web Control** screen.
- ② Copies images or movies you want to add to playlists to a USB flash drive.
- ③ Deletes images or movies on the USB flash drive.

## Time Table (only in Content Playback mode)

Options on the **Time Table** screen allow you to enable or disable the specified time table features.

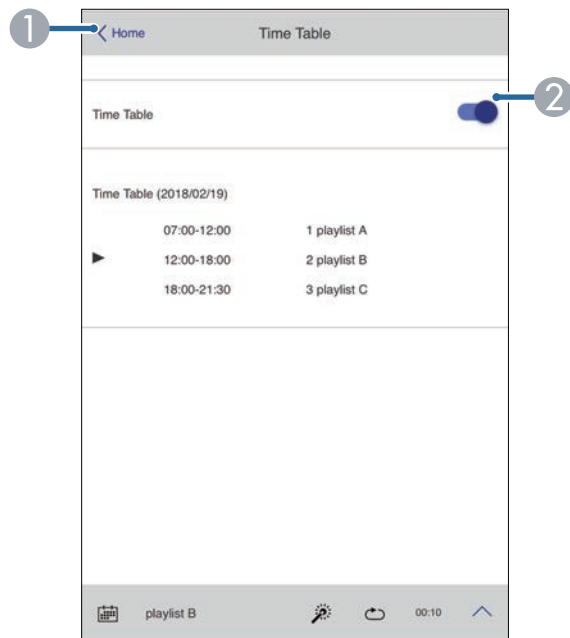

- 1 Returns to the **Epson Web Control** screen.
- 2 Turns the time table on or off.



You can specify when each playlist starts and finishes using the time table feature in the Epson Projector Content Manager software. For details, see the *Epson Projector Content Manager Operation Guide*.

You can register the digital certificates on the projector to provide security for your presentation files.



You can also register the digital certificates in the projector's **Network** menu. However, be sure to register just once or the certificate may not install correctly.

- ☛ **Network > Network Settings > Wireless LAN > Client Certificate**
- ☛ **Network > Network Settings > Wireless LAN > CA certificate**
- ☛ **Network > Network Settings > Projector Control > Secure HTTP > Web Server Certificate**

- 1** Make sure your digital certificate file is compatible with projector registration.
- 2** Make sure the projector is turned on.
- 3** Start your Web browser on a computer or device connected to the network.
- 4** Go to the Epson Web Control screen by entering the projector's IP address into the browser's address box.

You see the Epson Web Control screen.

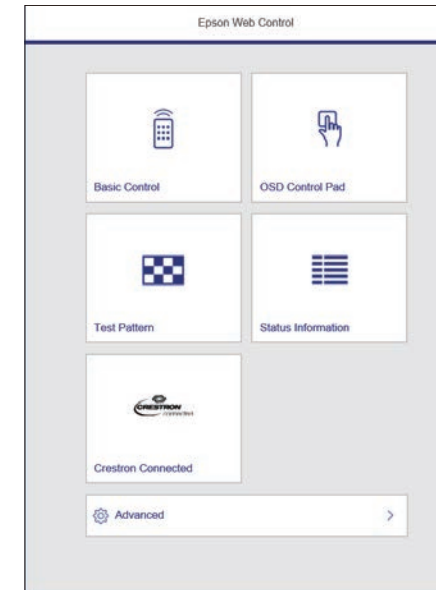

- 5** Select **Advanced**.



- You may need to log in before you see the Advanced screen. If you see a log in window, enter your user name and password. (The user name is **EPSONWEB** and the default password is **admin**.)
- You can change the password in the projector's **Network** menu.
  - ☛ **Network > Network Settings > Web Control Password**

- 6** Under **Network**, select **Certificate**.
- 7** Select the certificate file you want to register.
- 8** Enter the password in the **Password** box, and then click **Send**.

- 9 When you finish registering the certificate, click **Apply** to finalize your changes and complete the registration.

You can set up the projector to send you an e-mail alert over the network if there is a problem with the projector.

If you set the **Standby Mode** setting to **Communication On** in the projector's **Operation** menu, you can receive the e-mail alerts even if the projector is in standby mode (when the power is off).

- 1 Press the [Menu] button, select the **Network** menu, and press [Enter].
- 2 Select **Network Settings** and press [Enter].
- 3 Select the **Mail Notification** menu and press [Enter].

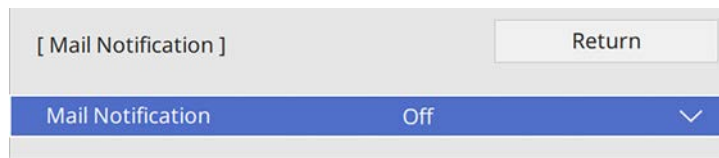

- 4 Set the **Mail Notification** setting to **On**.
- 5 Enter the IP address for the **SMTP Server** option.



Do not use "127.x.x.x" (where x is a number from 0 to 255) for the **SMTP Server**.

- 6 Select a type of **Authentication** of SMTP server.
- 7 Select a number for the SMTP server **Port Number**, from 0 to 65535 (default is 25).
- 8 Enter a **User Name** for the SMTP server.
- 9 Enter a **Password** for the SMTP server authentication.
- 10 Enter the e-mail address to be indicated as the sender in **From**.

- 11 Choose an address field, enter the e-mail address, and select the alerts you want to receive. Repeat for up to three addresses.



Your e-mail address can be up to 64 alphanumeric characters long.

- 12 When you finish selecting settings, go back to the **Network Settings** screen, select **Set**, and follow the on-screen instructions to save your settings and exit the menus.



If a critical problem causes a projector to shut down, you may not receive an e-mail alert.

## ► Related Links

- "Network Projector E-mail Alert Messages" [p.168](#)

---

## Network Projector E-mail Alert Messages

When a problem occurs with a projector on the network, and you selected to receive e-mail alerts, you receive an e-mail containing the following information:

- The email address set in **From** as the mail sender
- **Epson Projector** in the subject line
- The name of the projector experiencing a problem
- The IP address of the affected projector
- Detailed information about the problem



Network administrators can install SNMP (Simple Network Management Protocol) software on network computers so they can monitor projectors. If your network uses this software, you can set up the projector for SNMP monitoring.

- 1 Press the [Menu] button, select the **Network** menu, and press [Enter].
- 2 Select **Network Settings** and press [Enter].
- 3 Select the **Projector Control** menu and press [Enter].

[ Projector Control ]		Return
PJLink	Off	▼
SNMP	Off	▼
AMX Device Discovery	Off	
Crestron Connected	Off	
Control4 SDDP	Off	
Secure HTTP	On	▲
Web Server Certificate		

- 4 Set the **SNMP** setting to **On**.
- 5 Enter up to two IP addresses to receive SNMP notifications as the **Trap IP Address 1** and **Trap IP Address 2** settings, using 0 to 255 for each address field.



Do not use these addresses: 224.0.0.0 through 255.255.255.255.  
This projector supports SNMP agent version 1 (SNMPv1).

- 6 Enter the SNMP **Community Name** up to 32 alphanumeric characters long.

- 7 When you finish selecting settings, go back to the **Network Settings** screen, select **Set**, and follow the on-screen instructions to save your settings and exit the menus.

You can control the projector from an external device using ESC/VP21.

► **Related Links**

- "ESC/VP21 Command List" [p.170](#)
- "Cable Layouts" [p.170](#)

## ESC/VP21 Command List

When the power ON command is transmitted to the projector, the power turns on and it enters warm-up mode. When the projector's power has turned on, a colon ":" (3Ah) is returned.

When a command is input, the projector executes the command and returns a ":", and then accepts the next command.

If the command being processed terminates abnormally, an error message is output and a ":" is returned.

You can check the available commands in the projector's *Specifications*.

► **Related Links**

- "Getting the Latest Version of the Documents" [p.10](#)

## Cable Layouts

**Serial connection**

- Connector shape: D-Sub 9-pin (male)
- Projector input port name: RS-232C
- Cable type: Crossover (null modem) cable

In the following illustration, the projector side is shown on the left, and the computer side on the right:

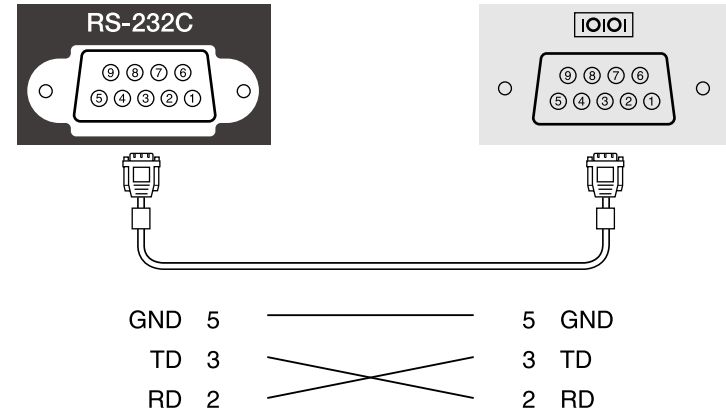

Signal name	Function
GND	Signal wire ground
TD	Transmit data
RD	Receive data

**Communications protocol**

- Default baud rate setting: 9600 bps
- Data length: 8 bit
- Parity: None
- Stop-bit: 1 bit
- Flow control: None

PJLink was established by the JBMIA (Japan Business Machine and Information System Industries Association) as a standard protocol for controlling network-compatible projector's as part of their efforts to standardize projector control protocols.

The projector complies with the PJLink Class2 standard established by the JBMIA.

The port number used for the PJLink search function is 4352 (UDP).

You need to make network settings before you can use PJLink.

It complies with all commands except for the following commands defined by PJLink Class2, and agreement was confirmed by the PJLink standard adaptability verification.

<http://pjlink.jbmia.or.jp/english/>

- Non-compatible commands  
You can check the non-compatible commands in the projector's *Specifications*.
- Input ports and corresponding input source number

Input port name	Input source number
Computer1	11
Computer2	12
HDMI1	32
HDMI2	33
USB	41
LAN	52
HDBaseT	56
Screen Mirroring1	57
Screen Mirroring2	58

- Manufacturer name displayed for "Manufacture name information query"  
**EPSON**
- Model name displayed for "Product name information query"

- EPSON L735U/L730U
- EPSON L720U
- EPSON L635SU/L630SU
- EPSON L630U
- EPSON L530U
- EPSON L520U

► **Related Links**

- "Getting the Latest Version of the Documents" [p.10](#)

If you are using the Crestron Connected network monitoring and control system, you can set up your projector for use on the system. Crestron Connected lets you control and monitor your projector using a Web browser.

 • You cannot use the Message Broadcasting feature in Epson Projector Management when you use Crestron Connected.

For additional information on Crestron Connected, visit the Crestron Web site.

<https://www.crestron.com/products/line/crestron-connected>

To monitor devices in the system, you can use Crestron RoomView Express or Crestron Fusion provided by Crestron. You can communicate with the help desk and send emergency messages. See the following Web site for details.

<http://www.crestron.com/getroomview>

This manual describes how to perform operations on your computer using a Web browser.

► **Related Links**

- "Setting Up Crestron Connected Support" p.172

## Setting Up Crestron Connected Support

To set up your projector for monitoring and control using a Crestron Connected system, make sure your computer and projector are connected to the network.

If you are connecting wirelessly, connect to devices over a wireless network access point.

 If you set the **Standby Mode** setting to **Communication On** in the projector's **Operation** menu, you can use a Web browser to select settings and control projection even if the projector is in standby mode (when the power is off).

**1** Press the [Menu] button, select the **Network** menu, and press [Enter].

**2** Select **Network Settings** and press [Enter].

**3** Select the **Projector Control** menu and press [Enter].

[ Projector Control ]		Return
PJLink	Off	▼
SNMP	Off	▼
AMX Device Discovery	Off	
Crestron Connected	Off	
Control4 SDDP	Off	
Secure HTTP	On	▲
Web Server Certificate		

**4** Set the **Crestron Connected** setting to **On** to allow the projector to be detected.

**5** When you finish selecting settings, go back to the **Network Settings** screen, select **Set**, and follow the on-screen instructions to save your settings and exit the menus.

**6** Turn off the projector, and then turn it on again to enable the setting.

**7** Start your Web browser on a computer or device connected to the network.

**8** Go to the Epson Web Control screen by entering the projector's IP address into the browser's address box.

**9** Select the **Crestron Connected** settings. See the Crestron Web site for details.

You can use Web API to operate the projector in Content Playback mode. See the *Web API Specifications for Projectors* for details.



- You can authenticate Web API communications using API authentication (Digest authentication).
- The user name for API authentication is **EPSONWEB**; use the password that is set for **Web Control Password**.
  - ☛ **Network > Network Settings > Web Control Password**

## » Related Links

- "Enabling Web API" [p.173](#)
- "Getting the Latest Version of the Documents" [p.10](#)

---

## Enabling Web API

You can enable Web API from a Web browser.

- 1** Select **Developer's Menu** on the **Epson Web Control** screen.
- 2** Set **Enable API** to **On**.

You can schedule up to 30 events to occur automatically on your projector, such as turning the projector on or off or switching the input source. The projector performs the selected events on the specified date and time in the schedule you set up.

## Warning

Do not place flammable objects in front of the lens. If you schedule the projector to turn on automatically, flammable objects in front of the lens could catch on a fire.



- If you set a **Menu Protection** of **Schedule** to **On**, turn it off first.

- 1** Set the date and time in the **Date & Time** menu in the projector's **Management** menu.
- 2** Press the [Menu] button, select the **Management** menu, and press [Enter].
- 3** Select **Schedule Settings** and press [Enter].
- 4** Select **Schedule** and press [Enter].

- 5** Select **Add New** and press [Enter].

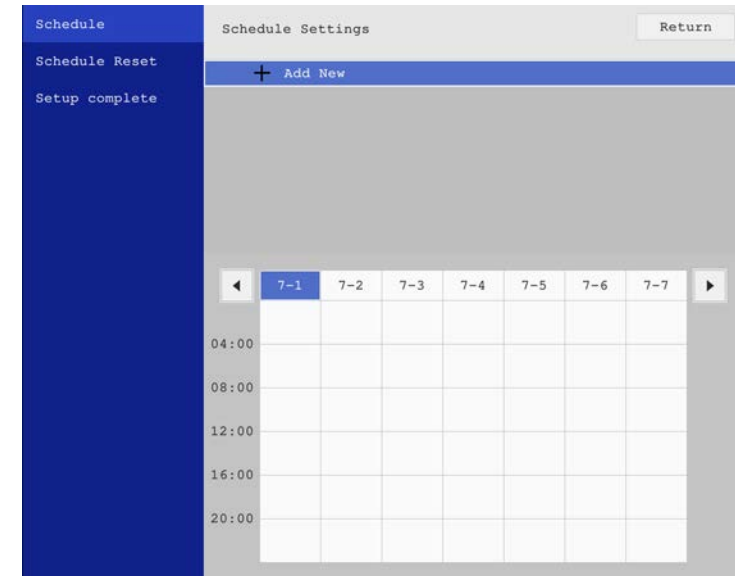

**6** Select the event details you want to perform.

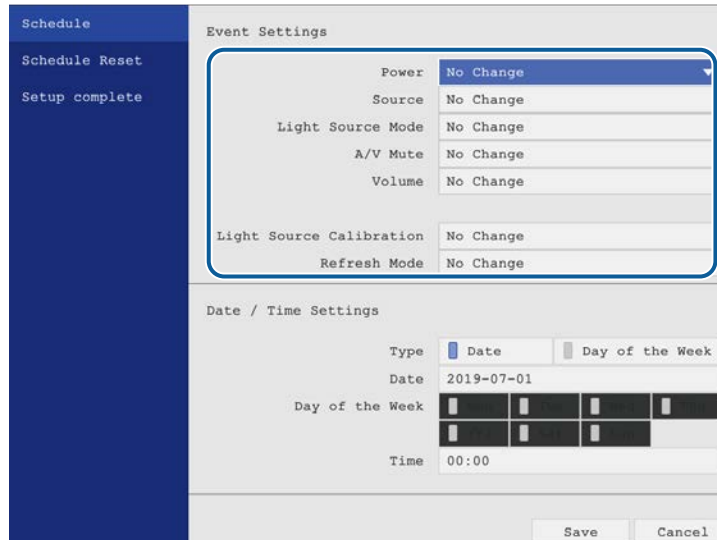

**7** Select the date and time at which you want the event to occur.

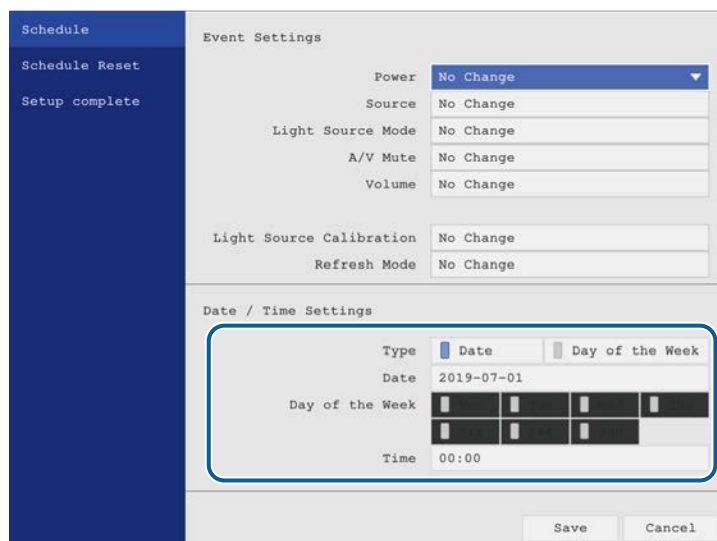

**8** Select **Save** and press [Enter].

The scheduled events are displayed on the screen with icons indicating the event status.

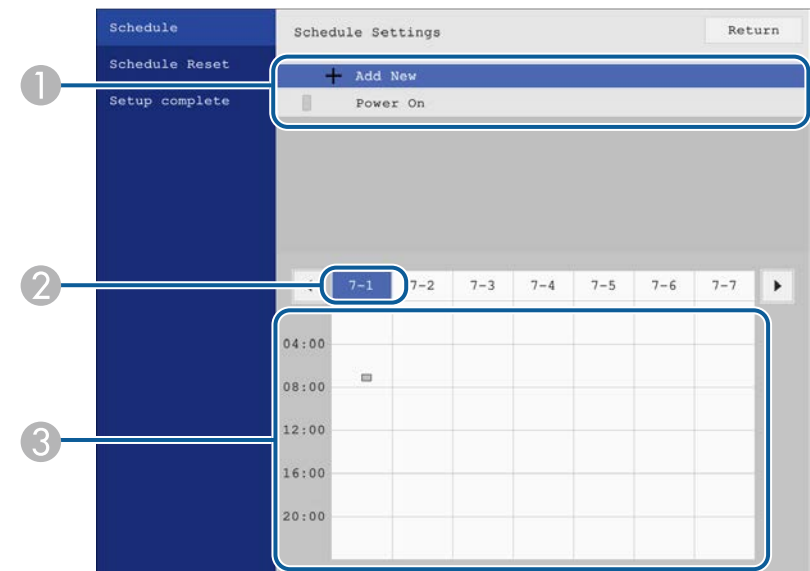

- ① : valid schedule
- : regular schedule
- : invalid schedule
- ② The date currently selected (highlighted)
- ③ : one time schedule
- : regular schedule
- : standby schedule (turns communication on or off during standby)
- : invalid schedule

**9** To edit a scheduled event, select the schedule and press [Esc].

- 10** Select an option from the menu displayed.
- **On** or **Off** lets you enable or disable the selected event.
  - **Edit** lets you change the event details or date and time.
  - **Clear** lets you remove the scheduled event from a list.

- 11** Select **Setup complete**, then select **Yes**.

To delete all scheduled events, select **Schedule Reset**.

» **Related Links**

- "Selecting Password Security Types" [p.125](#)
- "Setting the Date and Time" [p.45](#)



# Adjusting the Menu Settings

Follow the instructions in these sections to access the projector menu system and change projector settings.

## ► Related Links

- "Using the Projector's Menus" [p.178](#)
- "Using the Displayed Keyboard" [p.179](#)
- "Image Quality Settings - Image Menu" [p.180](#)
- "Input Signal Settings - Signal I/O Menu" [p.183](#)
- "Projector Installation Settings - Installation Menu" [p.185](#)
- "Projector Display Settings - Display Menu" [p.187](#)
- "Projector Feature Settings - Operation Menu" [p.189](#)
- "Projector Administration Settings - Management Menu" [p.192](#)
- "Projector Network Settings - Network Menu" [p.195](#)
- "Multiple Projector Operation Settings - Multi-Projection Menu" [p.203](#)
- "Image Quality Memory Settings - Memory Menu" [p.205](#)
- "Projector Initial Settings and Reset Options - Initial/All Settings Menu" [p.206](#)
- "Copying Menu Settings Between Projectors (Batch Setup)" [p.207](#)



You can use the projector's menus to adjust the settings that control how your projector works. The projector displays the menus on the screen.

- 1 Press the [Menu] button on the control panel or remote control. You see the menu screen.

Frequently Used Items	Image	
Image	Color Mode	Presentation
Signal I/O	Brightness	50
Installation	Contrast	50
Display	Color Saturation	50
Operation	Tint	50
Management	Sharpness	50
Network	White Balance	
Multi-Projection	Dynamic Contrast	Off
Memory	Image Enhancement	
Initial/All Settings	Scene Adaptive Gamma	5
	Gamma	0
	RGBCMY	
	Reset to Defaults	
	Source	Computer1
	Resolution	Auto
	Aspect	Auto
	Analog Signal Adjustment	
	Reset to Defaults	

- 2 Press the up or down arrow buttons to move through the menus listed on the left. The settings for each menu are displayed on the right.
- 3 To change settings in the displayed menu, press [Enter].
- 4 Press the up or down arrow button to move through the settings.
- 5 To return all the menu settings to their default values, select **Initial/All Settings**.
- 6 When you finish changing settings on a menu, press [Esc].

- 7 Press [Menu] or [Esc] to exit the menus.

 The  arrow indicates that the menu contains sub items. When you turn on a menu setting or select a specific value for it, the menu system displays the sub items.



You can use the displayed keyboard to enter numbers and characters.

- 1 Use the arrow buttons on the control panel or remote control to highlight the number or character you want to enter and press the [Enter] button.

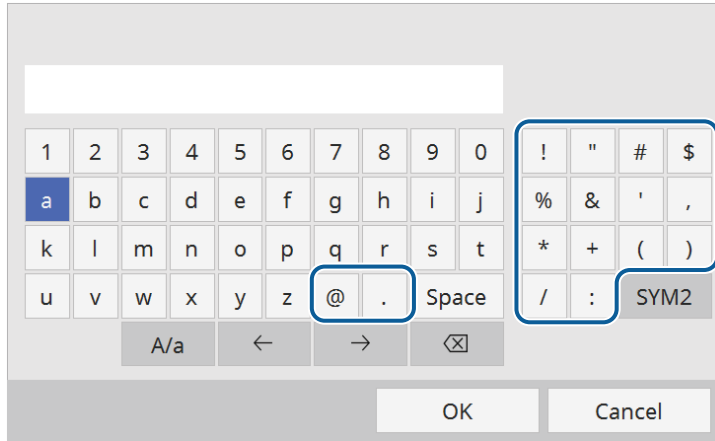

 Each time you select the **A/a** key, the characters change between upper case and lower case. Each time you select the **SYM1/2** key, the symbols enclosed by the frame change.

- 2 After entering the text, select **OK** on the keyboard to confirm your entries. Select **Cancel** to cancel entering text.

 You can select projector settings and control projection over a network using a Web browser from your computer. Some symbols cannot be entered using the displayed keyboard. Use your Web browser to enter the text.

## Available Text Using the Displayed Keyboard

You can enter the following text when using the displayed keyboard.

Text type	Details
Numbers	0123456789
Alphabet	ABCDEFGHIJKLMNOPQRSTUVWXYZ abcdefghijklmnopqrstuvwxyz
Symbols	!"#\$%&'()*+,-./:;<=>?@[ \ ] ^_`{ }~

### » Related Links

- "Available Text Using the Displayed Keyboard" [p.179](#)

Settings on the **Image** menu let you adjust the quality of your image. The available settings depend on the currently selected color mode and input source.

Frequently Used Items	Image	
Image	Color Mode	Presentation
Signal I/O	Brightness	50
Installation	Contrast	50
Display	Color Saturation	50
Operation	Tint	50
Management	Sharpness	50
Network	White Balance	
Multi-Projection	Dynamic Contrast	Off
Memory	Image Enhancement	
Initial/All Settings	Scene Adaptive Gamma	5
	Gamma	0
	RGBCMY	
	Reset to Defaults	
	Source	Computer1
	Resolution	Auto
	Aspect	Auto
	Analog Signal Adjustment	
	Reset to Defaults	

Setting	Options	Description
Color Mode	See the list of available color modes	Adjusts the vividness of image colors for various image types and environments.
Brightness	Various levels available	Lightens or darkens the overall image.
Contrast	Various levels available	Adjusts the difference between light and dark areas of the image.
Color Saturation	Various levels available	Adjusts the intensity of the image colors.
Tint	Various levels available	Adjusts the balance of green to magenta tones in the image.

Setting	Options	Description
Sharpness	Various levels available	Adjusts the sharpness or softness of image details.
White Balance	Color Temp.	Sets the color temperature according to the color mode you selected. Higher values tint the image blue and lower values tint the image red.  Setting is only displayed when <b>Color Filter</b> is not set to <b>Warm White</b> or <b>Cool White</b> . <b>☛ Operation &gt; Content Playback &gt; Overlay Effect &gt; Color Filter</b>
	G-M Correction	Makes fine adjustments to the color tone. Higher values tint the image green and lower values tint the image red.
	Custom	Adjusts the individual R (red), G (green), and B (blue) components of the offset and gain.
Dynamic Contrast	High Speed Normal Off	Adjusts the projected luminance based on the image brightness.
Image Enhancement	Image Preset Mode	Sets the <b>Image Enhancement</b> options as a batch using preset values.
	Noise Reduction	Reduces flickering in images.
	MPEG Noise Reduction	Reduces the noise or artifacts seen in MPEG video.
	Deinterlacing	Sets whether or not to convert interlaced-to-progressive signals for certain video image types.  <ul style="list-style-type: none"> <li>• <b>Off:</b> for fast-moving video images.</li> <li>• <b>Video:</b> for most video images.</li> <li>• <b>Film/Auto:</b> for movies, computer graphics, and animation.</li> </ul> Setting is only displayed when the current signal is interlaced signal (480i/576i/1080i).

Setting	Options	Description
	Super-resolution	Reduces blurring when projecting low resolution images.
	Detail Enhancement	Creates a more emphatic texture and material feel of the image.
	Reset	Resets all adjustment values on the <b>Image Enhancement</b> setting to their default settings.
Scene Adaptive Gamma	Various levels available	Adjusts the coloring according to the scene, and obtains a more vivid image. Select a large number to enhance contrast.  This setting is unavailable when using one of the following input sources: <ul style="list-style-type: none"> <li>• USB</li> <li>• LAN</li> <li>• Screen Mirroring</li> </ul>
Gamma	-2 to 2 Custom	Adjusts the coloring by selecting one of the gamma correction values, or referring to a gamma graph.
RGBCMY	Various levels available	Adjusts the hue, saturation, and brightness of each color R (red), G (green), B (blue), C (cyan), M (magenta), Y (yellow) individually.
Reset to Defaults	—	Resets all settings for the current color mode.
Source	—	Displays settings saved for each input source.  To change settings for an input source, make sure the source is connected and select that source.

Setting	Options	Description
Resolution	Auto Normal Wide Manual	Sets the input signal resolution if not detected automatically using the <b>Auto</b> option.  Select <b>Normal</b> for 4:3 or 5:4 screens, <b>Wide</b> for wide-screen, or <b>Manual</b> to specify a resolution.  Setting is only displayed when the current source is Computer.
Aspect	See the list of available aspect ratios	Sets the aspect ratio (width-to-height ratio) for the selected input source.  (Turn off the <b>Scale</b> setting or set the <b>Scale Mode</b> setting to <b>Full Display</b> first.)  Setting is only displayed when the current source is Computer, HDMI, or HDBaseT.
Analog Signal Adjustment	Auto Setup	Set to <b>On</b> to automatically optimize computer image quality.  Setting is only displayed when the current source is Computer.
	Tracking	Adjusts the signal to eliminate vertical stripes in computer images.  Setting is only displayed when the current source is Computer.
	Sync.	Adjusts the signal to eliminate fuzziness or flickering in computer images.  Setting is only displayed when the current source is Computer.
	Position	Adjusts the image location on the screen.  Setting is only displayed when the current source is Computer.
Reset to Defaults	—	Resets all settings for current input source.

Setting	Options	Description
Scale	Various scale options	Enlarges or reduces the image horizontally and vertically. Adjusts the scale of the image displayed by each projector when using multiple projectors to project one image.
Reset Image Settings	—	Resets all adjustment values on the <b>Image</b> menu to their default settings.



- The **Brightness** setting does not affect light source brightness. To change the light source brightness, select the **Light Source Brightness Control** setting in the projector's **Operation** menu.
- You can restore the default settings of the **Tracking**, **Sync.**, and **Position** settings by pressing the [Auto] button on the remote control.

## ► Related Links

- "Available Color Modes" [p.74](#)
- "Available Image Aspect Ratios" [p.72](#)
- "Turning On Automatic Luminance Adjustment" [p.75](#)
- "Adjusting the Image Resolution" [p.79](#)
- "Scaling an Image" [p.121](#)
- "Adjusting the Image Color" [p.76](#)

Normally the projector automatically detects and optimizes the input signal settings. If you need to customize the settings, you can use the **Signal I/O** menu. The available settings depend on the currently selected input source.

Frequently Used Items	Volume	
Image	Source	Computer1
Signal I/O	Overscan	Auto
Installation	Reset to Defaults	
Display	EDID	
Operation	HDMI IN EQ Level	
Management	HDMI Out Intensity	Off
Network	A/V Output	While Projecting
Multi-Projection	Audio Output	Auto
Memory	HDMI Audio Output	
Initial/All Settings	Monitor Out Port	Monitor Out
	HDMI Link	
	HDBaseT	
	Reset Signal I/O Settings	
	Installation	
	Fixed Installation	Off
	Test Pattern	
	Projection	Front/Ceiling
	GeometrV Correction	Point Correction

Setting	Options	Description
Volume	Various levels available for each source	Adjusts the volume of projector's speaker system. You can also adjust the volume of external speakers. Setting is only displayed when the audio is not output to AV system.
Source	—	Displays settings saved for each input source. To change settings for an input source, make sure the source is connected and select that source.

Setting	Options	Description
Signal Format	Video Range	Sets the video range to match the setting of input source. Setting is only displayed when the current source is HDMI or HDBaseT.
Overscan	Auto Off 4% 8%	Changes the projected image ratio to make the edges visible by a selectable percentage or automatically. Setting is only displayed when the input signal is component signal.
Reset to Defaults	—	Resets all settings for current input source.
EDID	HDMI1 HDMI2 HDBaseT	Describes the display capabilities of your projector. Change this setting as necessary according to the resolution of the image. Even in setups with multiple displays with different resolutions, you can switch the EDID of the current source and unify the EDID across the displays by setting the same EDID as the standard display.
HDMI IN EQ Level	HDMI1 HDMI2	Adjusts the HDMI input signal level depending on the devices connected to the HDMI port. If there is a lot of interference in the image, or if a problem such as no image being projected occurs, change the setting. You can select the settings for individual input sources without changing the input source.
HDMI Out Intensity (EB-L735U/EB-L730U/EB-L635SU/EB-L630SU/EB-L630U/EB-L530U)	Off Low Medium High	Adjusts the signal intensity input from the HDMI port. Change this setting when you cannot display the image output from the HDMI port correctly.

Setting	Options	Description
A/V Output	While Projecting Always On	Set to <b>Always On</b> to output audio and images to external devices when the projector does not project any images. Setting is only displayed in the following cases: <ul style="list-style-type: none"> <li>• <b>Quick Startup</b> is set to <b>Off</b> in the projector's <b>Operation</b> menu.</li> <li>• <b>Auto Power On</b> is set to <b>Off</b> in the projector's <b>Network</b> menu.                             <ul style="list-style-type: none"> <li>• <b>Network &gt; Transmitter Settings &gt; Auto Power On</b></li> </ul> </li> </ul>
Audio Output	Auto Audio1 Audio2	Sets the audio input port when projecting from any sources other than the HDBaseT, LAN, and Screen Mirroring.
HDMI Audio Output	HDMI1 Audio Output HDMI2 Audio Output	Sets the audio input port when projecting from HDMI ports.
Monitor Out Port	Monitor Out Computer2	Changes the input and output for the Computer2/Monitor Out port. When outputting images to an external monitor, select <b>Monitor Out</b> . When inputting image signals from a computer, select <b>Computer2</b> .
HDMI Link	Device Connections	Lists the devices connected to the HDMI ports. Setting is only displayed when <b>HDMI Link</b> is set to <b>On</b> .
	HDMI Link	Set to <b>On</b> to enable the HDMI Link features.
	Audio Out Device	Selects whether to output audio from the internal speakers or a connected audio/video system.

Setting	Options	Description
	Power On Link	Controls what happens when you turn on the projector or connected device. <ul style="list-style-type: none"> <li>• <b>Bidirectional</b>: automatically turns on the connected device when you turn on the projector, and vice versa.</li> <li>• <b>Device -&gt; PJ</b>: automatically turns on the projector when you turn on the connected device.</li> <li>• <b>PJ -&gt; Device</b>: automatically turns on the connected device when you turn on the projector.</li> </ul>
	Power Off Link	Controls whether connected devices are turned off when you turn off the projector.
HDBaseT	Control Communications	Enables or disables communication from the Ethernet and serial ports on the HDBaseT transmitter or switcher; turning on this setting disables the projector's LAN and RS-232C ports. Setting is only displayed when <b>Extron XTP</b> is set to <b>Off</b> .
	Extron XTP	Set to <b>On</b> when you connect an Extron XTP transmitter or switcher to the <b>HDBaseT</b> ports. See the following Extron Web site for more details on the XTP system. <a href="http://www.extron.com/">http://www.extron.com/</a>
Reset Signal I/O Settings	—	Resets all adjustment values on the <b>Signal I/O</b> menu to their default settings.



Settings on the **Installation** menu help you set up your projector in your installation environment.

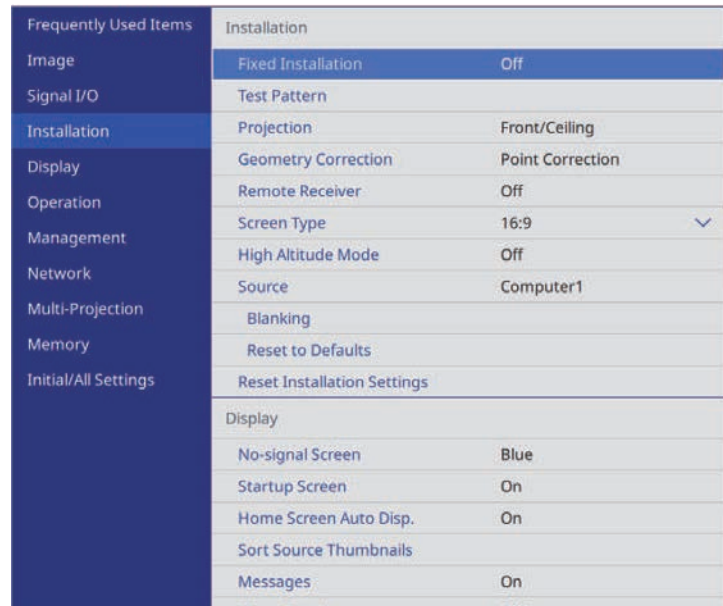

Setting	Options	Description
Fixed Installation	On Off	Set to <b>On</b> if you installed the projector in a fixed location.
Test Pattern	—	Displays a test pattern to assist in focusing and zooming the image and correcting image shape (press the [Esc] button to cancel pattern display).
Projection	Front Rear Front/Ceiling Rear/Ceiling	Sets the way the projector faces the screen so the image is oriented correctly.

Setting	Options	Description
Geometry Correction	H/V-Keystone	Manually corrects horizontal and vertical sides. <b>V-Keystone:</b> lets you manually correct vertical side. <b>V-Balance:</b> lets you manually correct vertical balance. <b>H-Keystone:</b> lets you manually correct horizontal side. <b>H-Balance:</b> lets you manually correct horizontal balance. <b>V-Balance and H-Balance</b> are available with EB-L735U/EB-L730U/EB-L635SU/EB-L630SU/EB-L630U/EB-L530U only.
	Quick Corner	Corrects image shape and alignment using an on-screen display.
	Arc Correction	Corrects the corners and sides of an image projected on a curved surface.
	Point Correction	Divides the projected image into a grid and corrects the distortion by moving the selected point of intersection from side to side and up and down.
	Off	Temporarily cancels the geometry correction.
	Memory	Save customized sets of settings to memory. <ul style="list-style-type: none"> <li>• <b>Save Memory:</b> saves the current shape of an image you have adjusted.</li> <li>• <b>Load Memory:</b> loads the settings you made and saved.</li> <li>• <b>Rename Memory:</b> changes the name of the memory settings.</li> <li>• <b>Erase Memory:</b> deletes a saved memory.</li> <li>• <b>Reset Memory:</b> Resets all saved memories.</li> </ul>

Setting	Options	Description
Digital Zoom (EB-L635SU/EB-L630SU)	Various levels available	Adjusts the size of the projected image.
Image Shift (EB-L635SU/EB-L630SU)	Various positions available	Shifts the image position horizontally and vertically.  This feature is not available if the <b>Digital Zoom</b> option is set to the widest setting.
E-Zoom (EB-L720U/EB-L520U)	Various levels available	Adjust the size of the image. Setting is only displayed when <b>Scale</b> is set to <b>Off</b> in the projector's <b>Image</b> menu.
Remote Receiver	Front/Rear Front Rear Off	Limits reception of remote control signals by the selected receiver; <b>Off</b> turns off all receivers.
Screen Type	4:3 16:6 16:9 16:10	Sets the aspect ratio of the screen to fit the image into the projection area.  This setting is unavailable when using one of the following input sources: <ul style="list-style-type: none"> <li>• USB</li> <li>• LAN</li> </ul> Setting is only displayed when <b>Content Playback</b> is set to <b>Off</b> in the projector's <b>Operation</b> menu.
Screen Position	Various positions available	Shifts the image position horizontally and vertically.  This feature is not available if you set the <b>Screen Type</b> setting to the same aspect ratio as the projector resolution.
High Altitude Mode	On Off	Regulates the projector's operating temperature at altitudes above 1500 m.
Source	—	Displays settings saved for each input source.  To change settings for an input source, make sure the source is connected and select that source.

Setting	Options	Description
Blanking	Top Bottom Left Right	Hides an area of the projected image that you select using the arrow buttons.  Setting is only displayed when <b>Content Playback</b> is set to <b>Off</b> in the projector's <b>Operation</b> menu.
Reset to Defaults	—	Resets all settings for current input source.  Setting is only displayed when <b>Content Playback</b> is set to <b>Off</b> in the projector's <b>Operation</b> menu.
Reset Installation Settings	—	Resets all adjustment values on the <b>Installation</b> menu to their default settings, except for the following: <ul style="list-style-type: none"> <li>• <b>Digital Zoom</b> (EB-L635SU/EB-L630SU)</li> <li>• <b>Image Shift</b> (EB-L635SU/EB-L630SU)</li> <li>• <b>E-Zoom</b> (EB-L720U/EB-L520U)</li> </ul>

» **Related Links**

- "Projection Modes" [p.48](#)
- "Image Shape" [p.57](#)
- "Projector Setup and Installation Options" [p.24](#)
- "Setting the Screen Type" [p.50](#)

Settings on the **Display** menu let you customize various projector display features.

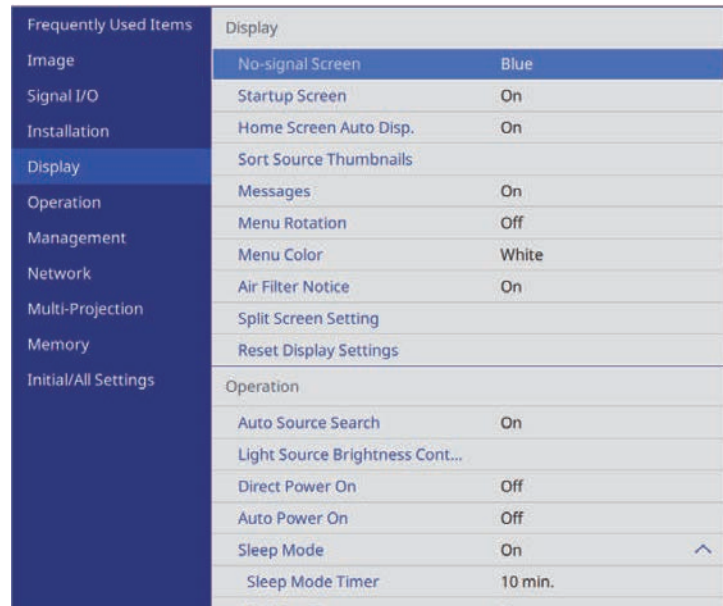

Setting	Options	Description
No-signal Screen	Black Blue Logo Gradation	Sets the screen color or logo to display when no signal is received. Setting is only displayed when <b>Content Playback</b> is set to <b>Off</b> in the projector's <b>Operation</b> menu.
Startup Screen	On Off	Set to <b>On</b> to display a logo when the projector starts up.

Setting	Options	Description
Home Screen Auto Disp.	On Off	Set to <b>On</b> to display the Home screen automatically when there is no input signal when turning on the projector. Setting is only displayed when <b>Connection Guide Display</b> is set to <b>Off</b> in the projector's <b>Network</b> menu. ☛ <b>Network &gt; Transmitter Settings &gt; Connection Guide Display</b>
Sort Source Thumbnails	On Off	Set to <b>On</b> to display the detected input source in the upper left position of the Home screen. The display order of the input sources changes when the projector detects an input signal.
Messages	On Off	Set to <b>On</b> to display messages such as input source name, color mode name, aspect ratio, no signal message, or high temperature warning on your projected image.
Menu Rotation	Right 90 Degree Left 90 Degree Off	Rotates the menu display 90°.
Menu Color	Black White	Sets the color theme of the Home screen and projector menu system.
Air Filter Notice	On Off	Set to <b>On</b> to display a message when a clog in the air filter is detected.
Split Screen Setting	Display Audio Output Source	Set to <b>On</b> to display an icon with the source providing audio output during split screen projection. Setting is only displayed when <b>Content Playback</b> is set to <b>Off</b> in the projector's <b>Operation</b> menu.

Setting	Options	Description
	Align	If you have split two screen images, select the position of the images to be aligned at the <b>Top</b> or <b>Middle</b> of the image area. Setting is only displayed when <b>Content Playback</b> is set to <b>Off</b> in the projector's <b>Operation</b> menu.
Reset Display Settings	—	Resets all adjustment values on the <b>Display</b> menu to their default settings.



If you turn on **Menu Protection of User's Logo**, you cannot change the following user's logo display settings; you must turn off **Menu Protection of User's Logo** first.

- **No-signal Screen**
- **Startup Screen**

## » Related Links

- "Projecting Multiple Images Simultaneously" [p.86](#)

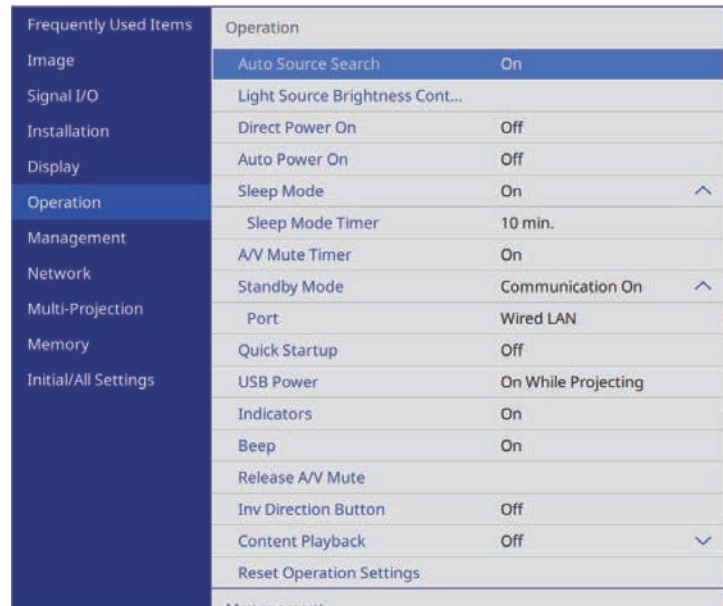

Settings on the **Operation** menu let you customize various projector features.



Setting	Options	Description
Auto Source Search	On Off	Set to <b>On</b> to detect the input signal automatically and project images when there is no input signal.  This function is disabled when you turn on the projector in the <b>Quick Startup</b> mode.  Setting is only displayed when <b>Content Playback</b> is set to <b>Off</b> .
Light Source Brightness Control	Maintain Brightness	Set to <b>On</b> to maintain a constant brightness for the light source.
	Maintain Brightness Level	Select the brightness level you want to maintain constantly.  Setting is only displayed when <b>Maintain Brightness</b> is set to <b>On</b> .

Setting	Options	Description
	Estimated Remains	Displays how long the projector can maintain constant brightness.  Setting is only displayed when <b>Maintain Brightness</b> is set to <b>On</b> .
	Light Source Mode	Select the brightness for the light source. <ul style="list-style-type: none"> <li>• <b>Normal</b>: maximum brightness.</li> <li>• <b>Quiet</b>: 70% brightness with reduced fan noise.</li> <li>• <b>Extended</b>: 70% brightness and extends the life expectancy of the light source.</li> <li>• <b>Custom</b>: select a custom brightness level.</li> </ul> Setting is only displayed when <b>Maintain Brightness</b> is set to <b>Off</b> .
	Brightness Level	Select the <b>Custom</b> brightness level you want.  Setting is only displayed when <b>Maintain Brightness</b> is set to <b>Off</b> .
Direct Power On	On Off	Set to <b>On</b> to turn on the projector by plugging it in without pressing the power button.
Auto Power On	HDMI1 Computer1 Off	Sets the image source from which you want to automatically start projection. <b>HDMI1</b> : Automatically turns on the projector when it detects power: <ul style="list-style-type: none"> <li>• When the image source turns on</li> <li>• When the cable is connected to the projector</li> </ul> <b>Computer1</b> : Automatically turns on the projector when it detects an input signal from the image source.
Sleep Mode	On Off	Set to <b>On</b> to automatically turns off the projector after an interval of inactivity.
Sleep Mode Timer	1 to 30 minutes	Sets the interval for <b>Sleep Mode</b> .

Setting	Options	Description
A/V Mute Timer	On Off	Turns off the projector automatically if <b>A/V Mute</b> is enabled and 30 minutes of inactivity has passed.
Standby Mode	Communication On Communication Off	Set to <b>Communication On</b> to allow monitoring and controlling the projector over a network when the projector is in standby mode. Setting is only displayed in the following cases: <ul style="list-style-type: none"> <li>• <b>A/V Output</b> is set to <b>While Projecting</b> in the projector's <b>Signal I/O</b> menu.</li> <li>• <b>USB Power</b> is set to <b>On While Projecting</b>.</li> <li>• <b>Auto Power On</b> is set to <b>Off</b> in the projector's <b>Network</b> menu.   <b>Network &gt; Transmitter Settings &gt; Auto Power On</b></li> </ul>
Port	Wired LAN Wireless LAN	Sets the port to use while the <b>Standby Mode</b> setting is set to <b>Communication On</b> .
Startup Source	Various input sources available	Select the image source you want to project when the projector is turned on in Content Playback mode.

Setting	Options	Description
Quick Startup	20min. 60min. 90min. Off	Sets the time period for Quick Startup mode. The projector enters this mode when you turn it off. You can start projecting in approximately 5 seconds by pressing the power button. However, it may take longer to become ready for use in the following situations: <ul style="list-style-type: none"> <li>• When projecting from the projector's USB port</li> <li>• When projecting from the projector's HDMI Out port</li> <li>• When projecting using the Screen Mirroring features</li> </ul> Setting is only displayed in the following cases: <ul style="list-style-type: none"> <li>• <b>A/V Output</b> is set to <b>While Projecting</b> in the projector's <b>Signal I/O</b> menu.</li> <li>• <b>Auto Power On</b> is set to <b>Off</b> in the projector's <b>Network</b> menu.   <b>Network &gt; Transmitter Settings &gt; Auto Power On</b></li> </ul>
USB Power (EB-L735U/EB-L730U/EB-L635SU/EB-L630SU/EB-L630U/EB-L530U)	On While Projecting Always On	Set to <b>Always On</b> to continue supplying power to the streaming media player when the projector is not projecting images. This lets the streaming media player start earlier, or perform its firmware updates automatically over a network if necessary. Setting is only displayed in the following cases: <ul style="list-style-type: none"> <li>• <b>A/V Output</b> is set to <b>While Projecting</b> in the projector's <b>Signal I/O</b> menu.</li> <li>• <b>Auto Power On</b> is set to <b>Off</b> in the projector's <b>Network</b> menu.   <b>Network &gt; Transmitter Settings &gt; Auto Power On</b></li> </ul>
Indicators	On Off	Set to <b>Off</b> to turn off the indicator lights on the projector except when an error or warning occurs.

Setting	Options	Description
Beep	On Off	Controls the beep that sounds when you turn the projector on or off.
Release A/V Mute	Any Button A/V Mute	Select <b>A/V Mute</b> if you want to use only the [A/V Mute] button to turn off A/V Mute, or select <b>Any Button</b> to use any button to turn it off.
Inv Direction Button	On Off	When suspending the projector from a ceiling, set to <b>On</b> to invert the operation direction of the control panel arrow buttons.
Content Playback	On Off	Set to <b>On</b> to play back a playlist.
Overlay Effect	Overlay Effect Shape Filter Color Filter Lightness	Adds color and shape effects to the projected image. Setting is only displayed in the following cases: <ul style="list-style-type: none"> <li>• <b>Edge Blending</b> is set to <b>Off</b> in the projector's <b>Multi-Projection</b> menu.</li> <li>• In Content Playback mode, the playlist can be played and no writable error has occurred.</li> </ul>
USB Viewer	—	Selects and plays back a playlist saved on the USB flash drive.
Reset Operation Settings	—	Resets all adjustment values on the <b>Operation</b> menu to their default settings.

» **Related Links**

- "Projecting in Content Playback Mode" [p.94](#)
- "Adjusting the Brightness" [p.81](#)

Settings on the **Management** menu let you customize various projector administrative features.

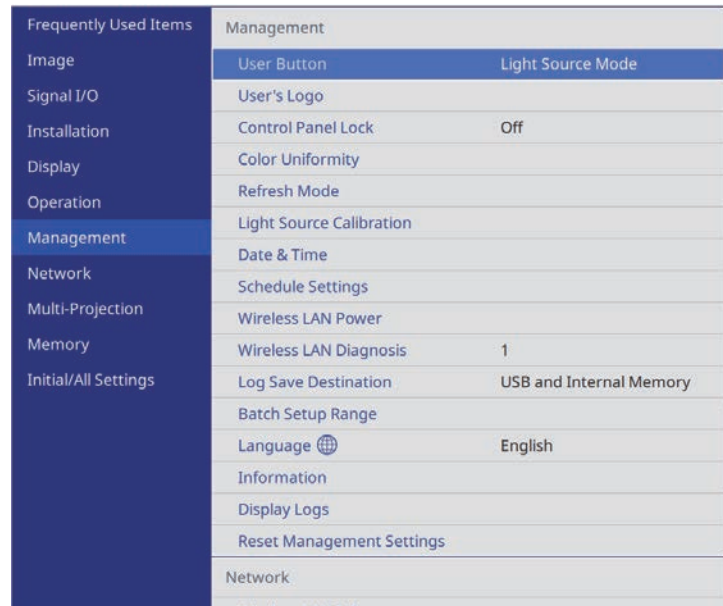

Setting	Options	Description
User Button	Various menu options available	Assigns a menu option to the [User] button on the remote control for one-touch access.
User's Logo	Start Setting Reset	Creates a screen that the projector displays to identify itself and enhance security.
Control Panel Lock	Full Lock Except for Power Off	Controls projector button locking to secure the projector: <ul style="list-style-type: none"> <li>• <b>Full Lock:</b> locks all buttons.</li> <li>• <b>Except for Power:</b> locks all buttons except the power button.</li> <li>• <b>Off:</b> no buttons locked.</li> </ul>

Setting	Options	Description
Color Uniformity	Color Uniformity	Set to <b>On</b> to adjust the color tone balance for the whole screen.
	Adjustment Level	Sets the adjustment level.
	Start Adjustments	Adjusts the red, green, and blue color tones individually for the selected area.
	Reset	Resets all adjustment values on the <b>Color Uniformity</b> menu to their default settings.
Refresh Mode	Timer	Sets a time period during which the projector displays the refresh image.
	Messages	Set to <b>On</b> to display a message informing you that the projector is in refresh mode.
	Start	Starts the refresh mode process to clear any projected afterimage and turn off the projector after a specified period of time. Press any button on the remote control to cancel this process.
Light Source Calibration	Run Now	Starts light source calibration to optimize the white balance of the currently projected image. You may not be able to start calibration if the projector's environmental temperature is out of range. (Wait 20 minutes after turning on the projector before starting calibration for the best results.)
	Run Periodically	Set to <b>On</b> to perform light source calibration periodically every 100 hours of usage.
	Last Run	Displays the date and time of the last light source calibration.
Date & Time	Date & Time Daylight Saving Time Internet Time	Adjusts the projector's system time and date settings. Select <b>Daylight Saving Time</b> to set daylight saving time settings for your region. Select <b>Internet Time</b> to automatically acquire the time from an Internet time server.



Setting	Options	Description
Schedule Settings	—	Schedules projector events to occur automatically at selected dates and times.
Wireless LAN Power	On Off	Set to <b>On</b> to project images via a wireless LAN. If you do not want to connect via wireless LAN, turn it off to prevent unauthorized access by others.
Wireless LAN Diagnosis	Ping IP Address Ping until stopped Start	Transmits Ping to confirm communication status.
Log Save Destination	Internal Memory USB and Internal Memory	Sets the location in which to save error and operation log files. Setting is only displayed when <b>Content Playback</b> is set to <b>Off</b> in the projector's <b>Operation</b> menu.
Batch Setup Range	All Limited	Select <b>All</b> to copy all of the projector menu settings using the batch setup feature. Select <b>Limited</b> , if you do not want to copy the following settings: <ul style="list-style-type: none"> <li>• <b>Password Protection</b> settings</li> <li>• <b>EDID</b> in the <b>Signal I/O</b> menu</li> <li>• <b>Network</b> menu settings</li> </ul>
Language	Various languages available	Select the language for projector menu and message displays.
Information	Various information	Displays information about the projector and input sources. The displayed items vary depending on the current input source.
Display Logs	Display Status Temp Warning Info Power On/Off History	Displays log data saved to the location specified in the <b>Log Save Destination</b> setting.

Setting	Options	Description
Reset Management Settings	—	Resets all adjustment values on the <b>Management</b> menu to their default settings, except for the following: <ul style="list-style-type: none"> <li>• <b>Language</b></li> </ul>

 When you set **Menu Protection** of **Schedule** to **On**, you cannot change settings on the **Schedule Settings**. Set **Menu Protection** of **Schedule** to **Off** first.

### ► Related Links

- "Event ID Code List" [p.193](#)
- "Saving a User's Logo Image" [p.106](#)
- "Locking the Projector's Buttons" [p.126](#)
- "Running Light Source Calibration" [p.110](#)
- "Adjusting the Color Tone (Color Uniformity)" [p.109](#)
- "Setting the Date and Time" [p.45](#)
- "Setting Projector Event Schedules" [p.174](#)
- "Selecting the Language for the Projector Menus" [p.47](#)

## Event ID Code List

If the **Event ID** option on the **Information** screen displays a code number, check this list of Event ID codes for the solution to the projector problem associated with the code.

If you cannot resolve the problem, contact your network administrator or Epson for technical support.

Event ID code	Cause and solution
0026 0032 0036 0037	A screen mirroring communication error has occurred. Turn the projector off and then on again, or restart the network software.

Event ID code	Cause and solution
0027 0028 0029 0030 0031 0035	Unstable screen mirroring communication. Check the network communication status, wait a few moments, and try connecting to the network again.
0023 0024 0025	Connection failed. If you see the PIN entry screen on your computer, enter the PIN code displayed on the network information screen or at the bottom right of the projected image. If this does not solve the problem, restart the projector and the connected devices, and then check the connection settings.
0043	The video format is not supported. Change the resolution of the mobile device, and then reconnect. Or change the <b>Adjust Image Quality</b> setting for the projector, and then reconnect.
0432 0435	The network software did not start. Turn the projector off and then on again.
0433	Cannot display the transferred images. Restart the network software.
0434 0481 0482 0485	Unstable network communication. Check the network communication status, wait a few moments, and try connecting to the network again.
0483 04FE	The network software quit unexpectedly. Check the network communication status, then turn the projector off and then on again.
0484	Communication with computer was disconnected. Restart the network software.
0479 04FF	A projector system error has occurred. Turn the projector off and then on again.
0891	Cannot find an access point with the same SSID. Set your computer, access point, and projector to the same SSID.
0892	The WPA/WPA2/WPA3 authentication type does not match. Make sure the wireless network security settings are correct.

Event ID code	Cause and solution
0893	The TKIP/AES encryption type does not match. Make sure the wireless network security settings are correct.
0894	Communication with an unauthorized access point was disconnected. Contact your network administrator.
0895	Communication with a connected device was disconnected. Check your device connection status.
0898	Failed to acquire DHCP. Make sure the DHCP server is operating correctly. If you are not using DHCP, set the <b>DHCP</b> setting to <b>Off</b> in the projector's <b>Network</b> menu. <ul style="list-style-type: none"> <li>☛ <b>Network &gt; Network Settings &gt; Wired LAN &gt; IP Settings &gt; DHCP</b></li> <li>☛ <b>Network &gt; Network Settings &gt; Wireless LAN &gt; IP Settings &gt; DHCP</b></li> </ul>
0899	Other communication errors.
089A	The EAP authentication type does not match the network. Check the wireless LAN security settings and make sure that the security certificate is installed correctly.
089B	EAP server authentication failed. Check the wireless LAN security settings and make sure that the security certificate is installed correctly.
089C	EAP client authentication failed. Check the wireless LAN security settings and make sure that the security certificate is installed correctly.
089D	Key exchange failed. Check the wireless LAN security settings and make sure that the security certificate is installed correctly.
0920	The internal battery that saves the projector's date and time settings is running low. Contact Epson for help.

Settings on the **Network** menu let you view network information and set up the projector for controlling over a network.

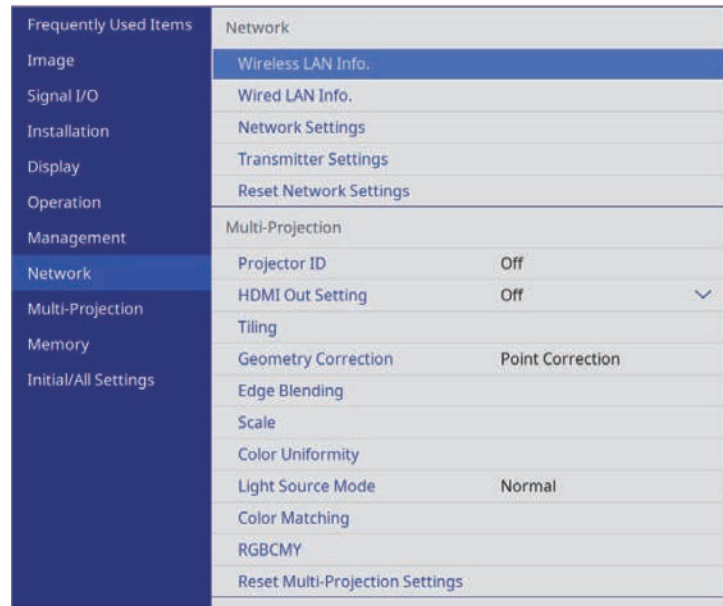

 When you set **Menu Protection** of **Network** to **On**, you cannot change the network settings. Set **Menu Protection** of **Network** to **Off** first.

Setting	Options	Description
Transmitter Settings	Start Pairing	Updates the network information of the wireless transmitter from your computer using the Epson Wireless Transmitter Settings software. See the <i>Epson Wireless Transmitter Settings Operation Guide</i> for details.  This setting is only displayed when the wireless LAN module is installed and <b>Simple AP</b> is set to <b>On</b> in the projector's <b>Network Settings</b> menu.
	Auto Power On	Set to <b>On</b> to turn on the projector automatically when you connect a computer using the optional wireless presentation systems.  This setting is only displayed in the following cases: <ul style="list-style-type: none"> <li>• When <b>A/V Output</b> is set to <b>While Projecting</b> in the projector's <b>Signal I/O</b> menu.</li> <li>• When <b>Quick Startup</b> is set to <b>Off</b> in the projector's <b>Operation</b> menu.</li> </ul>
	Connection Guide Display	Set to <b>On</b> to automatically display the connection guide for the wireless transmitter (Epson Wireless Presentation) instead of the Home screen when there is no input signal when you turn on the projector. The changed setting takes effect the next time you turn on the projector.  This setting is only displayed when <b>Content Playback</b> is set to <b>Off</b> in the projector's <b>Operation</b> menu.
Reset Network Settings	—	Resets all adjustment values on the <b>Network</b> menu to their default settings.

Setting	Options	Description
Wireless LAN Info.	Various information	Displays wireless network status and details.
Wired LAN Info.	Various information	Displays wired network status and details.
Network Settings	—	Configures your projector network settings. See the network menu table for details on the <b>Network Settings</b> .



Once you have connected your projector to your network, you can select projector settings and control projection using a compatible Web browser. This allows you to access the projector remotely.

► **Related Links**

- "Network Menu - Network Settings Menu" [p.196](#)
- "Using the Wireless Presentation System to Connect Windows/Mac Computers" [p.143](#)

## Network Menu - Network Settings Menu

Settings on the **Network Settings** menu let you select the basic network settings.



If you are connecting via wireless LAN, make sure the followings to enable wireless LAN settings:

- Install the wireless LAN module to your projector (EB-L720U/EB-L520U).
- Turn on the **Wireless LAN Power** setting in the projector's **Management** menu.

Setting	Options	Description
Projector Name	Up to 16 alphanumeric characters (do not use " * + , / ; < = > ? [ \ ] '   spaces)	Enter a name to identify the projector over the network.

Setting	Options	Description
Remote Password	Up to 8 alphanumeric characters (do not use * : spaces)	Enter a password for accessing the projector using the Basic Control of the Epson Web Control. (User name is <b>EPSONREMOTE</b> ; default password is <b>guest</b> .) Setting is only displayed when <b>Content Playback</b> is set to <b>Off</b> in the projector's <b>Operation</b> menu.
Web Control Password	Up to 8 alphanumeric characters (do not use * : spaces)	Enter a password for accessing the projector over the Web. (User name is <b>EPSONWEB</b> ; default password is <b>admin</b> .)
Priority Control Interface	Wired LAN Wireless LAN	Sets the priority gateway.
Simple AP	On Off	Set to <b>On</b> to enable simple access point mode for direct connection between your projector and input devices. Make sure you are also doing the following: <ul style="list-style-type: none"> <li>• Using <b>Quick Connection Mode</b> of Epson iProjection</li> <li>• Using Screen Mirroring connection</li> <li>• Using the optional wireless presentation system</li> </ul> Setting is only displayed when <b>Wireless LAN Power</b> is set to <b>On</b> in the projector's <b>Management</b> menu.
SSID	Automatically assigned SSID	Displays the SSID of the projector for selection on your device in simple AP connections.
Security	WPA2-PSK	Displays the security type for simple AP connections.
Passphrase	Various passphrases from 8 to 63 characters	Enter the passphrase of the projector for entry on your device in simple AP connections.

Setting	Options	Description
Wireless LAN Sys.	802.11ac (Wi-Fi 5) 802.11n (Wi-Fi 4)	Sets the communication method between the projector and the mobile device. The available methods vary depending on countries and regions.
Channel	Various channels available	Sets the frequency band (channel) using in simple AP connections.
Wireless LAN	—	See the <b>Wireless LAN</b> menu table for details.
Wired LAN	—	See the <b>Wired LAN</b> menu table for details.
Mail Notification	—	See the <b>Mail Notification</b> menu table for details.
Projector Control	—	See the <b>Projector Control</b> menu table for details.
Network Projection	—	See the <b>Network Projection</b> menu table for details.

### » Related Links

- "Network Menu - Wireless LAN Menu" [p.197](#)
- "Network Menu - Wired LAN Menu" [p.199](#)
- "Network Menu - Mail Notification Menu" [p.200](#)
- "Network Menu - Projector Control Menu" [p.200](#)
- "Network Menu - Network Projection Settings" [p.201](#)

## Network Menu - Wireless LAN Menu

Settings on the **Wireless LAN** menu let you select the wireless LAN settings.



- Turn on the **Wireless LAN Power** setting in the projector's **Management** menu.
- If you did not install an optional wireless LAN module, turn off the **Simple AP** setting to enable you to select wireless LAN settings (EB-L735U/EB-L730U/EB-L635SU/EB-L630SU/EB-L630U/EB-L530U).
- Install the optional wireless LAN module and turn off the **Simple AP** setting to enable you to select wireless LAN settings (EB-L720U/EB-L520U).

When connecting to a wireless network, it is strongly recommended that you set security. When setting security, follow the instructions from the administrator of the network system you want to connect to.

WPA is an encryption standard that improves the security for wireless networks. The projector supports AES encryption methods.



WPA2/WPA3-EAP and WPA3-EAP do not support WPA3 192-bit security.

Setting	Options	Description
Search Access Point	To Search View	Search for available wireless network access points. Depending on the access point settings, they may not be displayed in the list.
SSID	Up to 32 alphanumeric characters	Enter the SSID (network name) of the wireless LAN system the projector is connecting to.
Security	WPA2/WPA3-PSK	Connects in WPA2/WPA3 personal mode. Encryption method is selected automatically according to the access point settings. Set a passphrase which is the same for the access point.
	WPA2/WPA3-EAP	Connects in WPA2/WPA3 enterprise mode. Encryption method is selected automatically according to the access point settings.

Setting	Options	Description
	WPA3-PSK	Connects in WPA3 personal mode. Communication is performed using WPA3 security. Uses AES method for encryption. When establishing a connection from a computer to the projector, enter the value set in the passphrase.
	WPA3-EAP	Connects in WPA3 enterprise mode. Encryption method is selected automatically according to the access point settings.
	Open	Security is not set.
Passphrase (For WPA2/WPA3-PSK and WPA3-PSK security)	Various passphrases from 8 to 63 characters	Enter the pre-shared passphrase used on the network. When the passphrase is entered and the [Enter] button is pressed, the value is set and displayed as an asterisk (*). We recommend changing the passphrase periodically for security. If the network settings are initialized, it returns to the initial passphrase.
EAP Type (For WPA2/WPA3-EAP and WPA3-EAP security)	PEAP	Authentication protocol widely used in Windows Server.
	PEAP-TLS	Authentication protocol used in Windows Server. Select this when using a client certificate.
	EAP-TLS	Authentication protocol widely used to use a client certificate.
	EAP-FAST	Select this when these authentication protocols are used.

Setting	Options	Description
User name	Up to 64 alphanumeric characters	Enter a user name for the network. To include a domain name, add it before a backslash and the user name (domain\username). When importing a client certificate, the name the certificate was issued to is automatically set.
Password	Up to 64 alphanumeric characters	Enter a password for authentication. After you enter the password and select <b>Set</b> , the password is displayed as an asterisk (*). Setting is only displayed when <b>EAP Type</b> is set to <b>PEAP</b> or <b>EAP-FAST</b> .
Client Certificate	—	Imports the client certificate. Setting is only displayed when <b>EAP Type</b> is set to <b>PEAP-TLS</b> or <b>EAP-TLS</b> .
Verify Server Certificate	On Off	Set to <b>On</b> to verify the server certificate when a CA certificate has been set.
CA certificate	—	Imports the CA certificate.
RADIUS Server Name	Up to 64 alphanumeric characters	Enter the server name to verify.
IP Settings	DHCP IP Address Subnet Mask Gateway Address	Set <b>DHCP</b> to <b>On</b> if your network assigns addresses automatically; set to <b>Off</b> to manually enter the network's <b>IP Address</b> , <b>Subnet Mask</b> , and <b>Gateway Address</b> using 0 to 255 for each address field.  Do not use these addresses: 0.0.0.0, 127.x.x.x, 192.0.2.x or 224.0.0.0 through 255.255.255.255 (where x is a number from 0 to 255) for IP Address, 255.255.255.255 or 0.0.0.0 through 254.255.255.255 for Subnet Mask, and 0.0.0.0, 127.x.x.x or 224.0.0.0 through 255.255.255.255 for Gateway Address.

Setting	Options	Description
DNS Server 1 DNS Server 2	Various IP addresses	Enter the IP address for the DNS server, using 0 to 255 for each address field. The DNS server resolves the host name. Do not use the following IP addresses: 127.x.x.x (where x is a number from 0 to 255).  When these settings are not set and remain as 0.0.0.0, DNS server information is acquired using DHCP. After acquiring the information, the values remain as 0.0.0.0.
IPv6	On Off	Set to <b>On</b> if you want to connect the projector to the network using IPv6.  IPv6 is supported to monitor and control the projector over a network using Epson Web Control and PjLink.
Auto Configuration	On Off	Set to <b>On</b> to assign addresses automatically according to the Router Advertisement.
Use Temporary Address	On Off	Set to <b>On</b> if you want to use a temporary IPv6 address.
IP Address Display	On Off	Set to <b>On</b> to display the IP address on the network information screen and Home screen.

## Network Menu - Wired LAN Menu

Settings on the **Wired LAN** menu let you select the wired LAN settings.

Setting	Options	Description
IP Settings	DHCP IP Address Subnet Mask Gateway Address	Set <b>DHCP</b> to <b>On</b> if your network assigns addresses automatically; set to <b>Off</b> to manually enter the network's <b>IP Address</b> , <b>Subnet Mask</b> , and <b>Gateway Address</b> using 0 to 255 for each address field.  Do not use these addresses: 0.0.0.0, 127.x.x.x, 192.0.2.x or 224.0.0.0 through 255.255.255.255 (where x is a number from 0 to 255) for IP Address, 255.255.255.255 or 0.0.0.0 through 254.255.255.255 for Subnet Mask, and 0.0.0.0, 127.x.x.x or 224.0.0.0 through 255.255.255.255 for Gateway Address.
DNS Server 1 DNS Server 2	Various IP addresses	Enter the IP address for the DNS server, using 0 to 255 for each address field. The DNS server resolves the host name. You cannot use the following IP addresses: 127.x.x.x (where x is a number from 0 to 255).  When these settings are not set and remain as 0.0.0.0, DNS server information is acquired using DHCP. After acquiring the information, the values remain as 0.0.0.0.
IPv6	On Off	Set to <b>On</b> if you want to connect the projector to the network using IPv6.  IPv6 is supported to monitor and control the projector over a network using Epson Web Control and PjLink.
Auto Configuration	On Off	Set to <b>On</b> to assign addresses automatically according to the Router Advertisement.
Use Temporary Address	On Off	Set to <b>On</b> if you want to use a temporary IPv6 address.
IP Address Display	On Off	Set to <b>On</b> to display the IP address on the network information screen and Home screen.

## Network Menu - Mail Notification Menu

Settings on the **Mail Notification** menu let you receive an email notification if a problem or warning occurs in the projector.

Setting	Options	Description
Mail Notification	On Off	Set to <b>On</b> to send an email to the preset addresses when a problem or warning occurs with a projector.
SMTP Server	Various IP addresses	Enter the IP address for the projector's SMTP server using 0 to 255 for each address field.  Do not use these addresses: 127.x.x.x, 192.0.2.x or 224.0.0.0 through 255.255.255.255 (where x is a number from 0 to 255).
Authentication	Open Auth SSL TLS	Select the authentication type of the SMTP server.
Port Number	1 to 65535 (default is 25)	Enter a number for the SMTP server Port Number.
User Name	Up to 64 alphanumeric characters	Enter a user name for the SMTP server.
Password	Up to 64 alphanumeric characters	Enter a password for authentication on the SMTP server.
From	Up to 64 alphanumeric characters (do not use " ( ) , ; ; < > [ \ ] spaces)	Enter the email address of the sender.
Address 1 Setting		Enter the e-mail address, and select the alerts you want to receive.
Address 2 Setting		
Address 3 Setting		

## Network Menu - Projector Control Menu

Settings on the **Projector Control** menu let you select settings for controlling the projector over a network.

Setting	Options	Description
PJLink	On Off	Set to <b>On</b> to enable the PJLink notification function.
PJLink Password	Up to 32 alphanumeric characters (do not use spaces and any symbols other than @)	Enter a password for using the PJLink protocol for projector control.
Notified IP Address	Various IP addresses	Enter the IP address to receive the projector's operating status when the PJLink notification function is enabled. Enter the addresses using 0 to 255 for each address field.  Do not use these addresses: 127.x.x.x or 224.0.0.0 through 255.255.255.255 (where x is a number from 0 to 255).
SNMP	On Off	Set to <b>On</b> to monitor the projector using SNMP. To monitor the projector, you need to install the SNMP manager program on your computer. SNMP should be managed by a network administrator.
Trap IP Address 1 Trap IP Address 2	Various IP addresses	Enter up to two IP addresses to receive SNMP notifications, using 0 to 255 for each address field.  Do not use these addresses: 224.0.0.0 through 255.255.255.255 (where x is a number from 0 to 255).



Setting	Options	Description
Community Name	Up to 32 alphanumeric characters (do not use spaces and any symbols other than @)	Enter the SNMP community name.
AMX Device Discovery	On Off	Set to <b>On</b> when you want to allow the projector to be detected by AMX Device Discovery.
Crestron Connected	On Off	Set to <b>On</b> only when monitoring or controlling the projector over the network using Crestron Connected.  Enabling Crestron Connected disables the Epson Message Broadcasting feature in the Epson Projector Management software.
Control4 SDDP	On Off	Set to <b>On</b> to allow device information to be acquired using Control4 Simple Device Discovery Protocol (SDDP).
Secure HTTP	On Off	To strengthen security, communication between the projector and computer in Web control is encrypted. When setting security with Web control, it is recommended to set this to <b>On</b> .
Web Server Certificate	—	Imports the Web server certificate for secure HTTP.

Setting	Options	Description
Projector Keyword	On Off	Set to <b>On</b> to enable a security password to prevent access to the projector by anyone not in the same room as the projector. You must enter a displayed, randomized keyword from a computer using Epson iProjection to access the projector and share the current screen.
Epson iProjection	On Off	Set to <b>On</b> to use Epson iProjection.
SSID Display	On Off	Set to <b>On</b> to display the SSID on the network information screen and Home screen.
Display LAN Info.	Text & QR Code Text	Sets the display format for the projector's network information.  By simply reading the QR code with Epson iProjection, you can connect the mobile device to the projector through a network.
Moderator Password	Four-digit number	Enter a password for accessing the projector as a moderator using Epson iProjection. (No password is set by default.)
Keyword Interrupt Display	On Off	Set to <b>On</b> to display a projector keyword on the projected image when accessing the projector using Epson iProjection.  Available when <b>Projector Keyword</b> is set to <b>On</b> .
Screen Mirroring	On Off	Set to <b>On</b> to use the Screen Mirroring feature.
Interrupt Connection	On Off	Set to <b>On</b> to allows interruption of image projection by another user.
Adjust Image Quality	1 (Fine) 2 3 4 (Fast)	Adjusts the screen mirroring speed/quality.  1: increases image quality.  4: increases processing speed.

## Network Menu - Network Projection Settings

Settings on the **Network Projection** menu let you select the settings relates to network projection.

Setting	Options	Description
HDMI Out Image Output (EB-L735U/EB-L730U/EB-L635SU/EB-L630SU/EB-L630U/EB-L530U)	On Off	Set to <b>On</b> to output Screen Mirroring image to the HDMI Out port. HDCP and H.265 features are disabled and you may not be able to project content with them. If you want to project content with HDCP and H.265 features, select <b>Off</b> .
Screen Mirroring Info.	On Off	Set to <b>On</b> to display connection information when projecting from a Screen Mirroring source.
Message Broadcasting	On Off	Set to <b>On</b> to receive the message delivered by Epson Projector Management. See the <i>Epson Projector Management Operation Guide</i> for details. Setting is only displayed when <b>Crestron Connected</b> is set to <b>Off</b> in the projector's <b>Projector Control</b> menu.
Screen Sharing	On Off	Set to <b>On</b> to enable screen sharing between network projectors.
Connection Mode	Keyword On Keyword Off	Set to <b>Keyword Off</b> to skip authentication of keywords for other projectors so you can quickly connect to them.

» **Related Links**

- "Screen Sharing" [p.152](#)

Settings on the **Multi-Projection** menu let you set up multiple projectors to project a single unified image.

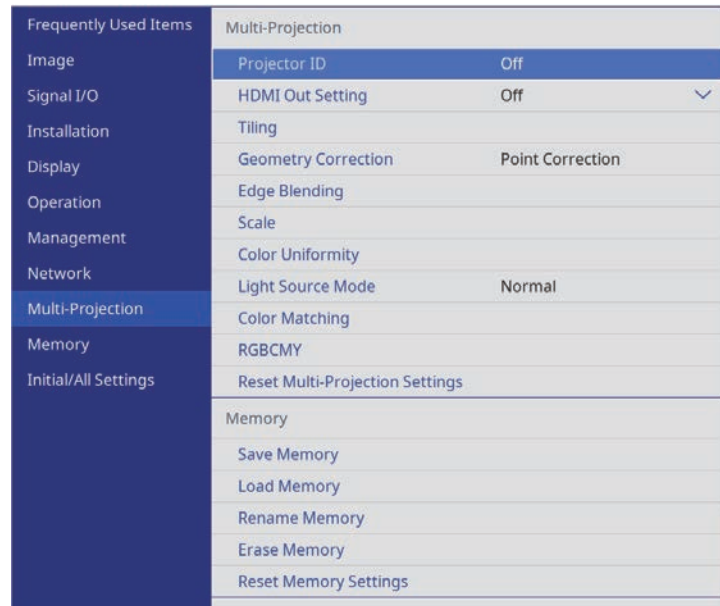

Setting	Options	Description
Order (EB-L735U/EB-L730U/EB-L635SU/EB-L630SU/EB-L630U/EB-L530U)	1 to 4	Sets the position of this projector in number order from left to right. Setting is only displayed when <b>HDMI Out Setting</b> is set to <b>Pass Through</b> .
Tiling	Layout Location Setup	Sets the number of split screens and the position of each image. Setting is only displayed when <b>HDMI Out Setting</b> is set to <b>Off</b> .
Geometry Correction	—	See the <b>Installation</b> menu table for details on the <b>Geometry Correction</b> settings.
Edge Blending	Edge Blending Top Edge Bottom Edge Left Edge Right Edge Line Guide Pattern Guide Guide Color	Blends the border between multiple images to create a seamless screen.
Black Level	Color Adjustment Area Correction Reset	Adjusts the black color of the overlapping image area. This setting is only displayed when <b>Blending</b> is set to <b>On</b> for the <b>Top Edge</b> , <b>Bottom Edge</b> , <b>Left Edge</b> , or <b>Right Edge</b> setting.
Scale	—	See the <b>Image</b> menu table for details on the <b>Scale</b> settings.
Color Uniformity	—	See the <b>Management</b> menu table for details on the <b>Color Uniformity</b> settings.
Light Source Mode	—	See the <b>Operation</b> menu table for details on the <b>Light Source Mode</b> settings.

Setting	Options	Description
Projector ID	Off 1 through 9	Assigns an ID for the projector when you use multiple projectors.
HDMI Out Setting (EB-L735U/EB-L730U/EB-L635SU/EB-L630SU/EB-L630U/EB-L530U)	Off Pass Through	Set to <b>Pass Through</b> to enable up to 4 projectors connected via HDMI cables to project a unified image. When you select <b>Pass Through</b> , you can project images only from HDMI1, HDMI2, or HDBaseT sources.
Number of Projectors (EB-L735U/EB-L730U/EB-L635SU/EB-L630SU/EB-L630U/EB-L530U)	2 to 4	Sets the number of projectors used to create a unified image area. Setting is only displayed when <b>HDMI Out Setting</b> is set to <b>Pass Through</b> .

Setting	Options	Description
Color Matching	Adjustment Level Red Green Blue Brightness	Corrects the difference between the tint and brightness of each projected image.
RGBCMY	—	See the <b>Image</b> menu table for details on the <b>RGBCMY</b> settings.
Reset Multi-Projection Settings	—	Resets all adjustment values on the <b>Multi-Projection</b> menu to their default settings.

## » Related Links

- "Using Multiple Projectors" [p.112](#)
- "Projector Installation Settings - Installation Menu" [p.185](#)
- "Image Quality Settings - Image Menu" [p.180](#)
- "Projector Administration Settings - Management Menu" [p.192](#)
- "Projector Feature Settings - Operation Menu" [p.189](#)
- "Blending the Image Edges" [p.116](#)
- "Adjusting the Black Level" [p.118](#)
- "Connecting Multiple Projectors of the Same Model" [p.36](#)

Settings on the **Memory** menu let you manage saving and loading of image quality settings in the projector's memory.

- "Saving Settings to Memory and Using Saved Settings" [p.108](#)

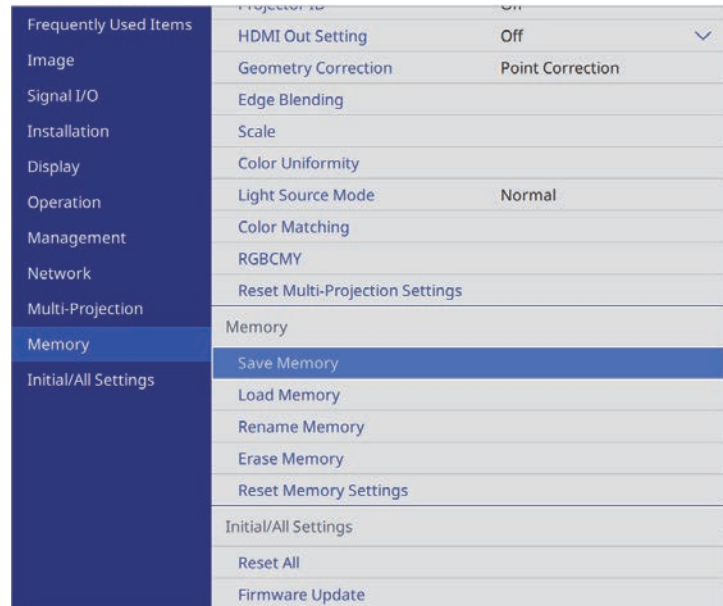

Setting	Options	Description
Save Memory	Memory 1 to 10	Saves customized sets of settings to memory.
Load Memory	Memory 1 to 10	Loads saved memory settings and applies them to the current image.
Rename Memory	Memory 1 to 10	Changes the name of the memory settings.
Erase Memory	Memory 1 to 10	Deletes a saved memory.
Reset Memory Settings	—	Resets all saved memories.

» **Related Links**

- "Loading Image Shape Setting from Memory" [p.65](#)

Settings on the **Initial/All Settings** menu let you reset certain projector settings to their default values and place the projector in firmware update mode so you can update the firmware.

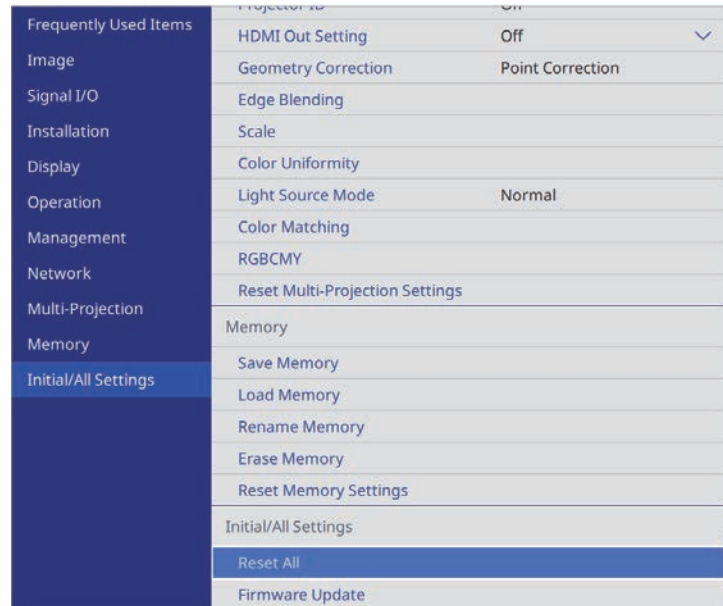

## Reset All options

When you select **Reset All**, you see the following screen.

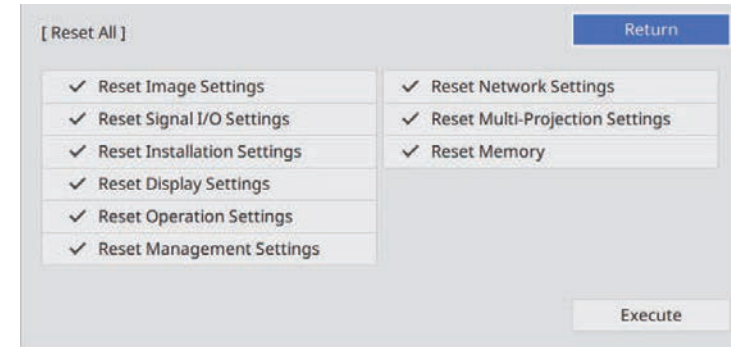

If you do not want to reset values in particular menus, deselect the check box next to the menu name. When you are ready to reset setting values, select **Execute**.

You cannot reset the following settings:

- **Digital Zoom** (EB-L635SU/EB-L630SU)
- **Image Shift** (EB-L635SU/EB-L630SU)
- **E-Zoom** (EB-L720U/EB-L520U)
- **Language**

### » Related Links

- "Updating the Firmware" [p.218](#)

Setting	Options	Description
Reset All	—	Lets you select menus for resetting the settings to default values.
Firmware Update	—	Enters the firmware update mode and ready to update firmware using the USB-A or Service port.

After selecting the projector's menu settings for one projector, you can use the following methods to copy the settings to other projectors, as long as they are the same model.

- by using a USB flash drive
- by connecting a computer and projector using a USB cable
- by using Epson Projector Management

You cannot copy any information unique to an individual projector, such as **Light Source Hours** or **Status**.



- Perform batch setup before adjusting the image settings such as keystone distortion correction. Since image adjustment values are also copied to another projector, the adjustments you made before performing the batch setup are overwritten and the projected screen you adjusted may change.
  - When copying the menu settings from one projector to another, user's logo is also copied. Do not register the information that you do not want to share between multiple projectors as a user's logo.
  - Make sure **Batch Setup Range** is set to **Limited** if you do not want to copy the following settings:
    - **Password Protection** settings
    - **EDID** in the **Signal I/O** menu
    - **Network** menu settings
- ☛ **Management > Batch Setup Range**

## Caution

Epson takes no responsibility for batch setup failures and associated repair costs due to power outages, communication errors, or other problems that may cause such failures.

### » Related Links

- "Transferring Settings From a USB Flash Drive" [p.207](#)
- "Transferring Settings From a Computer" [p.208](#)

## Transferring Settings From a USB Flash Drive

You can copy menu settings from one projector to another of the same model using a USB flash drive.



The USB flash drive must use a FAT format and not incorporate any security function. Delete any files on the drive before using it for batch setup or the settings may not be saved correctly.

- 1** Disconnect the power cord from the projector, and check that all of the projector's indicators have turned off.
- 2** Connect an empty USB flash drive directly to the projector's USB-A port.
- 3** Hold down the [Esc] button on the remote control or the control panel and connect the power cord to the projector.
- 4** When all of the projector's indicators turn on, release the [Esc] button. The indicators start flashing and the batch setup file is written to the USB flash drive. When writing is finished, the projector turns off.

## Caution

Do not disconnect the power cord or the USB flash drive from the projector while the file is being written. If the power cord or USB flash drive is disconnected, the projector may not start correctly.

- 5** Remove the USB flash drive.



The file name for the batch setup file is PJCONFDATA.bin. If you need to change the file name, add text after PJCONFDATA using only alphanumeric characters. If you change the PJCONFDATA section of the file name, the projector may not be able to recognize the file correctly.

- 6 Disconnect the power cord from the projector to which you want to copy settings, and check that all of the projector's indicators have turned off.
- 7 Connect the USB flash drive containing the saved batch setup file to the projector's USB-A port.
- 8 Hold down the [Menu] button on the remote control or the control panel and connect the power cord to the projector.
- 9 When all of the projector's indicators turn on, release the [Menu] button.

When all of the indicators start flashing, the settings are being written. When writing is finished, the projector turns off.

## Caution

Do not disconnect the power cord or the USB flash drive from the projector while the file is being written. If the power cord or USB flash drive is disconnected, the projector may not start correctly.

- 10 Remove the USB flash drive.

## Transferring Settings From a Computer

You can copy menu settings from one projector to another of the same model by connecting the computer and projector with a USB cable.



You can use this batch setup method with the following operating system versions:

- Windows 7 and later
- OS X 10.11.x and later

- 1 Disconnect the power cord from the projector, and check that all of the projector's indicators have turned off.

- 2 Connect a USB cable to the computer's USB port and to the projector's Service port.
- 3 Hold down the [Esc] button on the remote control or the control panel and connect the power cord to the projector.
- 4 When all of the projector's indicators turn on, release the [Esc] button. The computer recognizes the projector as a removable disk.
- 5 Open the removable disk icon or folder, and save the batch setup file to the computer.



The file name for the batch setup file is PJCONFDATA.bin. If you need to change the file name, add text after PJCONFDATA using only alphanumeric characters. If you change the PJCONFDATA section of the file name, the projector may not be able to recognize the file correctly.

- 6 Eject the USB device (Windows) or drag the removable disk icon to the Trash (Mac).
- 7 Disconnect the USB cable. The projector turns off.
- 8 Disconnect the power cord from the projector to which you want to copy settings, and check that all of the projector's indicators have turned off.
- 9 Connect the USB cable to the computer's USB port and to the projector's Service port.
- 10 Hold down the [Menu] button on the remote control or the control panel and connect the power cord to the projector.
- 11 When all of the projector's indicators turn on, release the [Menu] button.



The computer recognizes the projector as a removable disk.

- Copy the batch setup file (PJCONFDATA.bin) that you saved to your computer to the top level folder of the removable disk.

 Do not copy any files or folders other than the batch setup file to the removable disk.

- Eject the USB device (Windows) or drag the removable disk icon to the Trash (Mac).

- Disconnect the USB cable.  
When all of the indicators start flashing, the settings are being written. When writing is finished, the projector turns off.

 **Caution**  
Do not disconnect the power cord from the projector while the file is being written. If the power cord is disconnected, the projector may not start correctly.

» **Related Links**

- "Batch Setup Error Notification" [p.209](#)

## Batch Setup Error Notification

The projector's indicators notify you if an error occurs during a batch setup operation. Check the status of the projector's indicators and follow the instructions described in the table here.

Indicator status	Problem and solutions
<ul style="list-style-type: none"> <li>Power: Blue - flashing fast</li> <li>Status: Blue - flashing fast</li> <li>Laser: Orange - flashing fast</li> <li>Temp: Orange - flashing fast</li> </ul>	<p>Writing the settings may have failed and an error may have occurred in the projector's firmware.</p> <p>Stop using the projector, remove the power plug from the electrical outlet. Contact Epson for help.</p>

Indicator status	Problem and solutions
<ul style="list-style-type: none"> <li>Laser: Orange - flashing fast</li> <li>Temp: Orange - flashing fast</li> </ul>	<p>The batch setup file may be corrupt, or the USB flash drive may not be connected correctly.</p> <p>Disconnect the USB flash drive, unplug and then plug in the projector's power cord, and then try again.</p>

# Maintaining the Projector

Follow the instructions in these sections to maintain your projector.

## ► **Related Links**

- "Projector Maintenance" [p.211](#)
- "Cleaning the Lens" [p.212](#)
- "Cleaning the Projector Case" [p.213](#)
- "Air Filter and Vent Maintenance" [p.214](#)
- "Updating the Firmware" [p.218](#)

You may need to clean the projector's lens periodically, and clean the air filter and air vents to prevent the projector from overheating due to blocked ventilation.

The only parts you should replace are the air filter and remote control batteries. If any other part needs replacing, contact Epson or an authorized Epson servicer.

 **Warning**

Before cleaning any part of the projector, turn it off and unplug the power cord. Never open any cover on the projector, except as specifically explained in this manual. Dangerous electrical voltages in the projector can injure you severely.

Clean the projector's lens periodically, or whenever you notice dust or smudges on the surface.

- To remove dust or smudges, gently wipe the lens with lens-cleaning paper.
- To remove stubborn smudges, moisten a soft, lint-free cloth with lens cleaner and gently wipe the lens. Do not spray any liquid directly on the lens.

## **Warning**

Do not use a lens cleaner that contains flammable gas. The high heat generated by the projector may cause a fire.

## **Attention**

Do not use glass cleaner or any harsh materials to clean the lens and do not subject the lens to any impacts; otherwise, it could be damaged. Do not use canned air, or the gases may leave a flammable residue.

Before cleaning the projector case, turn off the projector and unplug the power cord.

- To remove dust or dirt, use a soft, dry, lint-free cloth.
- To remove stubborn dirt, use a soft cloth moistened with water and mild soap. Do not spray liquid directly on the projector.

**Attention**

Do not use wax, alcohol, benzene, paint thinner, or other chemicals to clean the projector case. These can damage the case. Do not use canned air, or the gases may leave a flammable residue.

Regular filter maintenance is important to maintain your projector. Clean the air filter when a message appears telling you the temperature inside the projector has reached a high level. It is recommended that you clean these parts over a 20000-hour period. Clean them more often than this if you use the projector in an environment that is dustier than expected. (Assuming the projector is used in an atmosphere in which airborne particulate matter is less than 0.04 to 0.2 mg/m<sup>3</sup>.)

## Attention

If regular maintenance is not performed, your Epson projector will notify you when the temperature inside the projector has reached a high level. Do not wait until this warning appears to maintain your projector filter as prolonged exposure to high temperatures may reduce the life of your projector.

### ► Related Links

- "Cleaning the Air Filters and Intake Vents" [p.214](#)
- "Replacing the Air Filter" [p.216](#)

## Cleaning the Air Filters and Intake Vents

You need to clean the projector's air filters in the following situations:

- The filter or vents get dusty.
- You see a message telling you to clean it.
- The projector's Filter indicator flashes orange.

**1** Turn off the projector and unplug the power cord.

**2** Carefully remove the dust using a vacuum cleaner or a brush.

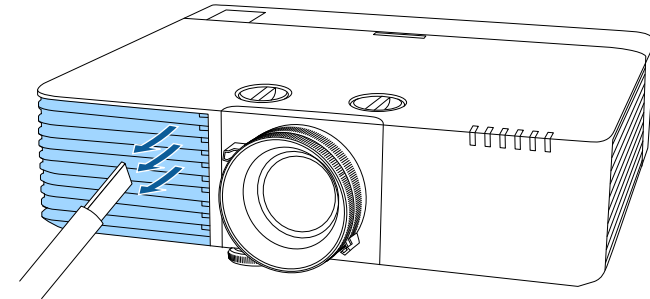

**3** Turn the projector upside down.

**4** Loosen the screws and open the air filter cover.

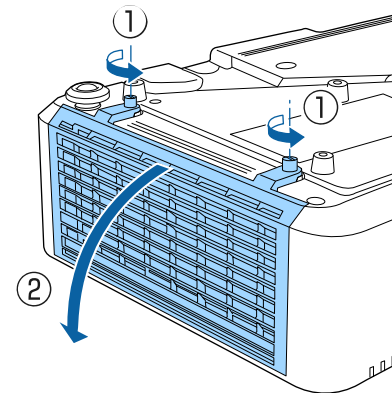

- 5** Pull the air filter out of the projector.

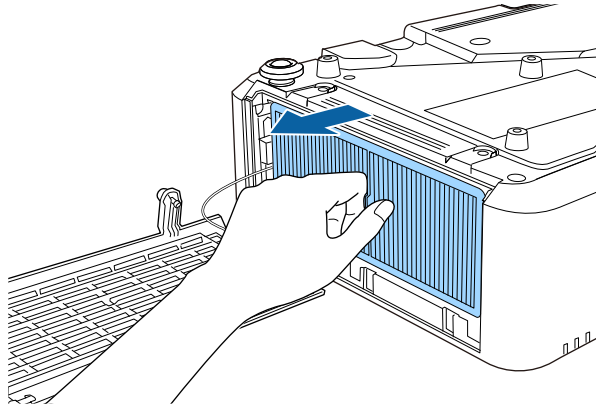

- 7** Vacuum the front of the air filter (the side with the tabs) to remove any remaining dust.

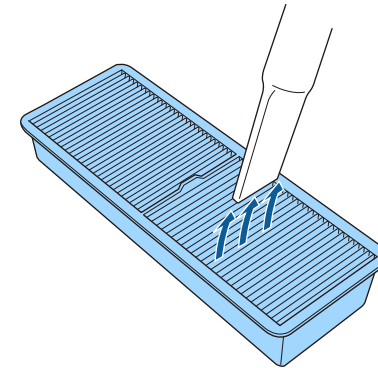

- 6** Tap each side of the air filter 4 to 5 times to shake off any excess dust.

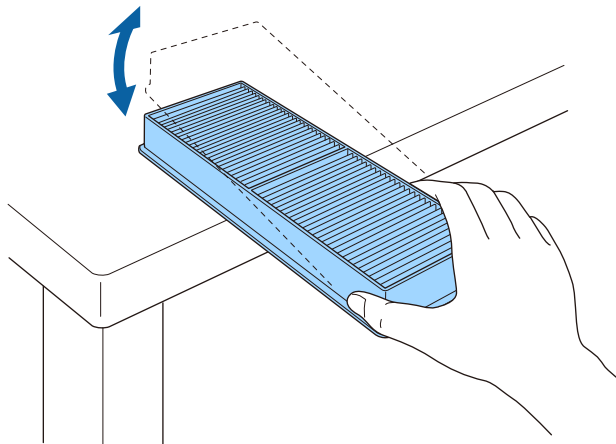

**Attention**

- Do not rinse the air filter in water, or use any detergent or solvent to clean it.
- Do not use canned air. The gases may leave a flammable residue or push dust and debris into the projector's optics or other sensitive areas.

**Attention**

Do not use excessive force when tapping the air filter, or it may crack and become unusable.

- 8** Place the air filter in the projector as shown.

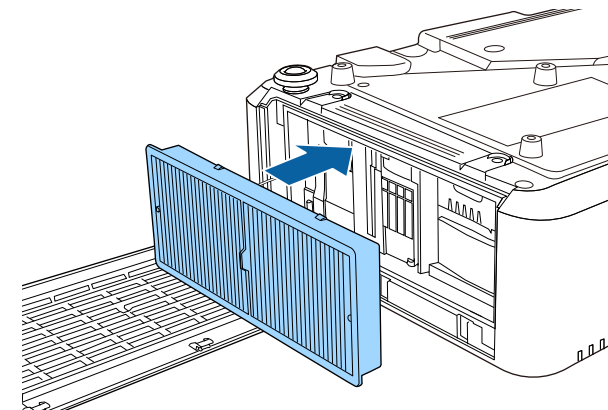

**9** Close the air filter cover and tighten the screws.

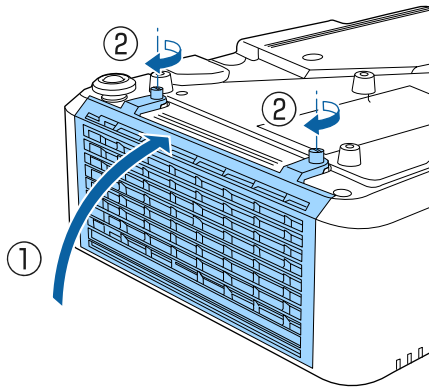

**3** Loosen the screws and open the air filter cover.

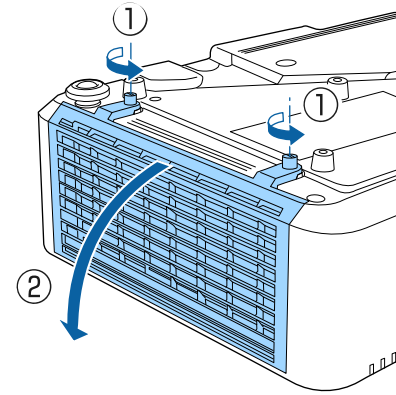

## Replacing the Air Filter

You need to replace the air filter in the following situations:

- After cleaning the air filter, you see a message telling you to clean or replace it.
- After cleaning the air filter, the projector's Filter indicator flashes orange.
- The air filter is torn or damaged.

You can replace the air filter while the projector is mounted to the ceiling or placed on a table.

**1** Turn off the projector and unplug the power cord.

**2** Turn the projector upside down.

**4** Pull the air filter out of the projector.

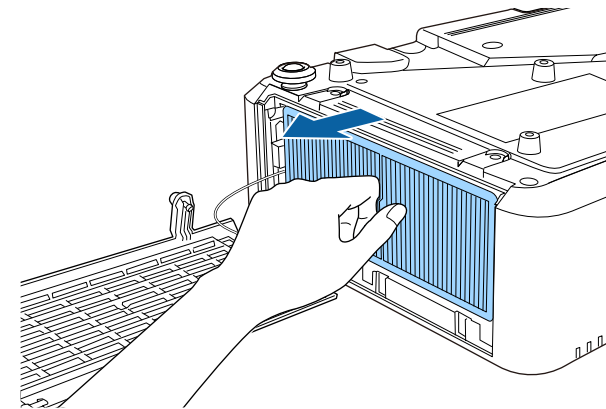

Dispose of used air filters according to local regulations.

- Filter frame: Polypropylene
- Filter: Polypropylene



- 5** Place the new air filter in the projector as shown.

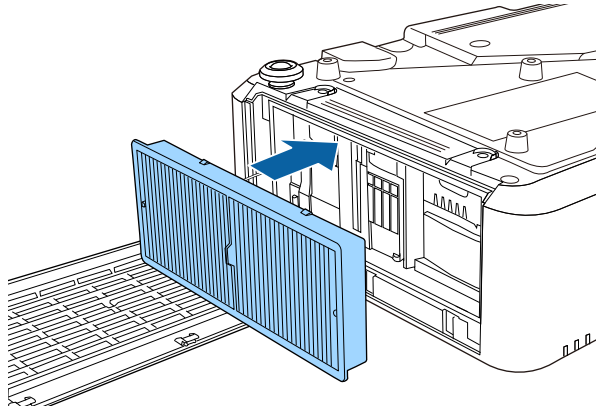

- 6** Close the air filter cover and tighten the screws.

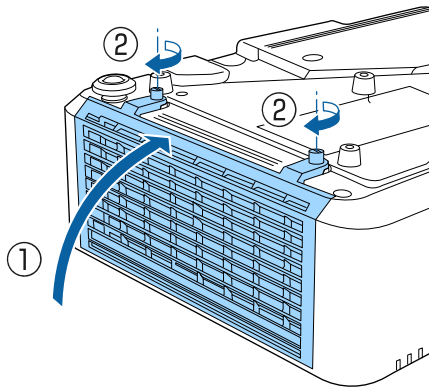

When you select the **Firmware Update** option in the projector's **Initial/All Settings** menu, the projector enters firmware update mode and is ready to perform a firmware update using the USB-A or Service port.

► **Related Links**

- "Updating Firmware Using a USB Storage Device" [p.218](#)
- "Updating Firmware Using a Computer and USB Cable" [p.219](#)

## Updating Firmware Using a USB Storage Device

You can update the projector's firmware using a USB storage device.

 Responsibility for updating the firmware lies with the customer. If a firmware update fails due to problems such as a power failure or communication problems, a fee will be charged for any necessary repairs.

- 1** Download the projector firmware file from the Epson Web site.
- 2** Copy the downloaded firmware file to the root folder (highest folder in the hierarchy) of the USB storage device.

- 
- The USB storage device must be formatted in FAT format.
  - Do not copy any other files to the USB storage device.
  - Do not change the firmware's file name. If the file name is changed, the firmware update will not start.
  - Check that the firmware file you copied is the correct file for your projector model. If the firmware file is not correct, the firmware update will not start.

- 3** Connect the USB storage device to the projector's USB-A port.

 Connect the USB storage device directly to the projector. If the USB storage device is connected using a USB hub, the firmware update may not be applied correctly.

- 4** Press the [Menu] button, select the **Initial/All Settings** menu, and press [Enter].

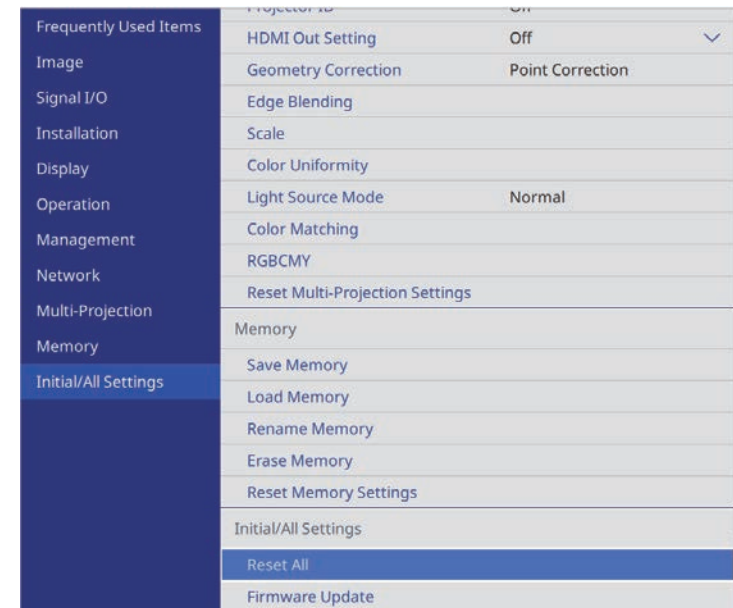

- 5** Select **Firmware Update** and press [Enter].
- 6** Select **Yes** to start the firmware update.

- 
- Do not disconnect the power cord from the projector while the firmware is updating. If the power cord is disconnected, the projector may not start correctly.
  - Do not disconnect the USB storage device from the projector while the firmware is updating. If the USB storage device is disconnected, the update may not be applied correctly.

All of the projector's indicators start flashing and the firmware update starts. When the update finishes normally, the projector enters standby status (only the power indicator is lit blue). If **Direct Power On** is set to **On** in the projector's **Operation** menu, the projector turns back on again.

When the update finishes, check the **Information** menu in the projector's **Management** menu to make sure that the **Version** information has been updated to the correct firmware version.



When all indicators flash rapidly, the firmware update may have failed. Disconnect the power cord from the projector, and then reconnect it to the projector. If the indicators continue to flash even after reconnecting the power cord, remove the power plug from the electrical outlet and contact Epson.

## Updating Firmware Using a Computer and USB Cable

You can update the projector's firmware using a computer and a USB cable.



- Responsibility for updating the firmware lies with the customer. If a firmware update fails due to problems such as a power failure or communication problems, a fee will be charged for any necessary repairs.
- Your computer must be running one of the following operating systems to update the firmware.
  - Windows 8.1 (32- and 64-bit)
  - Windows 10 (32- and 64-bit)
  - macOS 10.13.x (64-bit)
  - macOS 10.14.x (64-bit)
  - macOS 10.15.x (64-bit)

**1** Download the projector firmware file from the Epson Web site.



- Do not change the firmware's file name. If the file name is changed, the firmware update will not start.
- Check that the firmware file you copied is the correct file for your projector model. If the firmware file is not correct, the firmware update will not start.

**2** Connect the USB cable to the computer's USB port and to the projector's Service port.

**3** Press the [Menu] button, select the **Initial/All Settings** menu, and press [Enter].

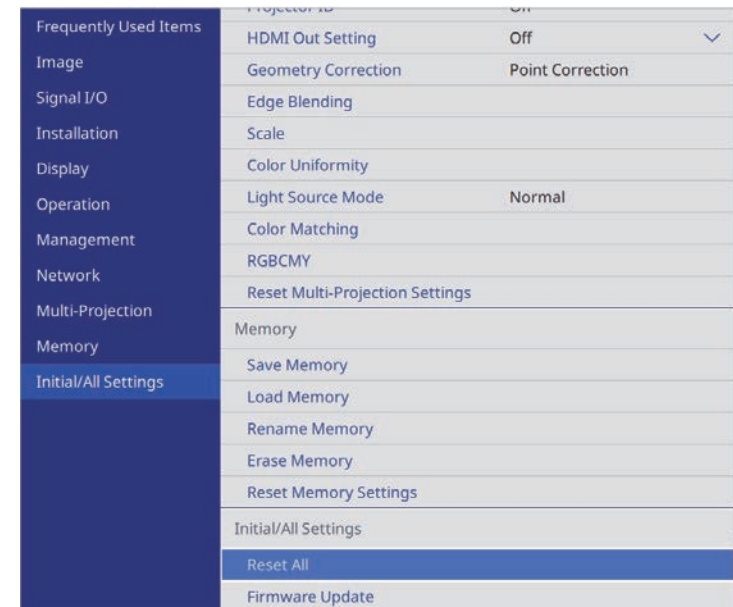

**4** Select **Firmware Update** and press [Enter].

**5** Select **Yes** to start the firmware update.



Do not disconnect the power cord from the projector while the firmware is updating. If the power cord is disconnected, the projector may not start correctly.

All of the projector's indicators turn on and the projector enters firmware update mode. The computer recognizes the projector as a removable disk.

- 6** On the computer, copy the firmware file to the root folder (highest folder in the hierarchy) of the removable disk.



- Do not copy any other files or folders to the removable disk. Otherwise, the files or folders may be lost.
- The projector turns off automatically if the USB cable or the power cord are disconnected before the firmware file can be copied to the removable disk. If this occurs, perform the procedure again.

- 7** Perform the steps to safely remove a USB device from the computer and disconnect the USB cable from the projector.

All of the projector's indicators start flashing and the firmware update starts. When the update finishes normally, the projector enters standby status (only the power indicator is lit blue). If **Direct Power On** is set to **On** in the projector's **Operation** menu, the projector turns back on again.

When the update finishes, check the **Information** menu in the projector's **Management** menu to make sure that the **Version** information has been updated to the correct firmware version.



- When all indicators flash rapidly, the firmware update may have failed. Disconnect the power cord from the projector, and then reconnect it to the projector. If the indicators continue to flash even after reconnecting the power cord, remove the power plug from the electrical outlet and contact Epson.
- If no operations are performed for 20 minutes in update mode, the projector turns off automatically. If this occurs, perform the procedure again.

# Solving Problems

Check the solutions in these sections if you have any problems using the projector.

## ► Related Links

- "Projection Problems" [p.222](#)
- "Projector Indicator Status" [p.223](#)
- "Viewing the Status Display" [p.226](#)
- "Solving Image or Sound Problems" [p.229](#)
- "Solving Projector or Remote Control Operation Problems" [p.235](#)
- "Solving Network Problems" [p.237](#)
- "Solutions to Problems in Content Playback Mode" [p.240](#)
- "Solutions When HDMI Link does not Function" [p.241](#)

If the projector is not working properly, turn it off, unplug it, and then plug it back in and turn it on.

If this does not solve the problem, check the following:

- The indicators on the projector may indicate the problem.
- The solutions in this manual can help you solve many problems.

If none of these solutions help, contact Epson for technical support.

The indicators on the projector indicate the projector status and let you know when a problem occurs. Check the status and color of the indicators and then refer to this table for a solution.



- If the indicators display a pattern not listed in the table below, turn the projector off, unplug it, and contact Epson for help.
- When the **Indicators** setting is set to **Off** in the projector's **Operation** menu, all indicators are off under normal projection conditions.

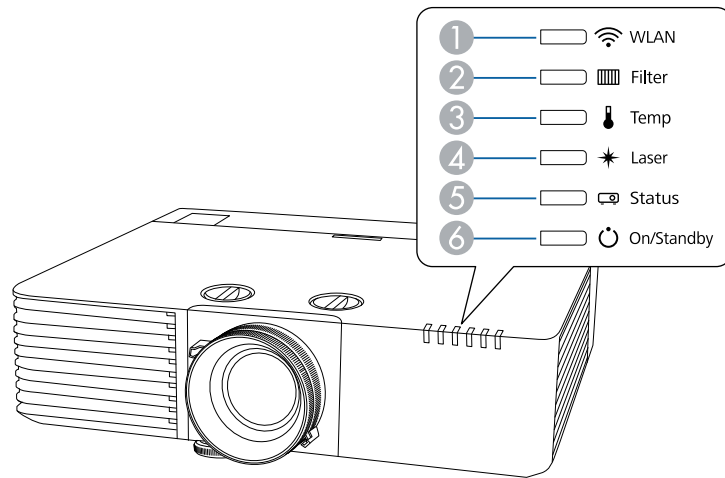

- ① WLAN (wireless LAN) indicator
- ② Filter indicator
- ③ Temp (temperature) indicator
- ④ Laser indicator
- ⑤ Status indicator
- ⑥ On/Standby (power) indicator

## Projector status

Indicator and status	Problem and solutions
Power: Lit blue Status: Lit blue Laser: Off Temp: Off Filter: Off	Normal operation.
Power: Lit blue Status: Flashing blue Laser: Off Temp: Off Filter: Off	Warming up, shutting down, or cooling down. When warming up, wait about 30 seconds for an image to appear. All buttons are disabled during warm-up, shutting down, and cooling down.
Power: Lit blue Status: Off Laser: Off Temp: Off Filter: Off	Standby, sleep mode, or monitoring. When you press the power button, projection starts.
Power: Flashing blue Status: Off Laser: Off Temp: Off Filter: Off	Preparing for monitoring or quick startup mode. All features are disabled.
Power: Indicator status varies Status: Flashing blue Laser: Flashing orange Temp: Indicator status varies Filter: Indicator status varies	Refresh Mode is in progress. ☛ <b>Management &gt; Refresh Mode</b>

Indicator and status	Problem and solutions
Power: Flashing blue Status: Indicator status varies Laser: Indicator status varies Temp: Flashing orange Filter: Indicator status varies	Projector is too hot. <ul style="list-style-type: none"> <li>• Make sure that the vents and air filter are not clogged with dust or obstructed by nearby objects.</li> <li>• Clean or replace the air filter.</li> <li>• Make sure the environmental temperature is not too hot.</li> </ul>
Power: Off Status: Flashing blue Laser: Off Temp: Lit orange Filter: Off	Projector has overheated and turned off. Leave it turned off to cool down for 5 minutes. <ul style="list-style-type: none"> <li>• Make sure that the vents and air filter are not clogged with dust or obstructed by nearby objects.</li> <li>• Make sure the environmental temperature is not too hot.</li> <li>• Clean or replace the air filter.</li> <li>• If operating the projector at high altitude, set the <b>High Altitude Mode</b> setting to <b>On</b> in the projector's <b>Installation</b> menu.</li> <li>• If the problem persists, unplug the projector and contact Epson for help.</li> </ul>
Power: Flashing blue Status: Indicator status varies Laser: Flashing orange Temp: Indicator status varies Filter: Indicator status varies	Laser warning. Turn the projector off, unplug it, and contact Epson for help.
Power: Off Status: Flashing blue Laser: Lit orange Temp: Off Filter: Off	Laser has a problem. Turn the projector off, unplug it, and contact Epson for help.

Indicator and status	Problem and solutions
Power: Off Status: Flashing blue Laser: Off Temp: Flashing orange Filter: Off	A fan or sensor has a problem. Turn the projector off, unplug it, and contact Epson for help.
Power: Off Status: Flashing blue Laser: Flashing orange Temp: Off Filter: Off	Internal projector error. Turn the projector off, unplug it, and contact Epson for help.
Power: Indicator status varies Status: Indicator status varies Laser: Indicator status varies Temp: Indicator status varies Filter: Flashing orange	It is time to clean the air filter.
Power: Flashing blue Status: Indicator status varies Laser: Indicator status varies Temp: Indicator status varies Filter: Lit orange	Low air flow through the air filter. <ul style="list-style-type: none"> <li>• Make sure that the vents and air filter are not clogged with dust or obstructed by nearby objects.</li> <li>• Clean or replace the air filter.</li> <li>• If the problem persists, unplug the projector and contact Epson for help.</li> </ul>
Power: Off Status: Flashing blue Laser: Off Temp: Off Filter: Lit orange	Low air flow through the projector. <ul style="list-style-type: none"> <li>• Make sure that the vents and air filter are not clogged with dust or obstructed by nearby objects.</li> <li>• Clean or replace the air filter.</li> <li>• If the problem persists, unplug the projector and contact Epson for help.</li> </ul>



Indicator and status	Problem and solutions
Power: Indicator status varies Status: Indicator status varies Laser: Flashing orange Temp: Indicator status varies Filter: Indicator status varies	The projector is unable to maintain constant brightness and the setting is disabled. <b>☛ Operation &gt; Light Source Brightness Control &gt; Maintain Brightness</b>

## Wireless LAN status

Wireless LAN indicator status	Problem and solutions
Lit blue	Wireless LAN is available or the projector is operating in simple AP mode.
Flashing blue (quickly)	Connecting to a device with infrastructure mode.
Flashing blue (slowly)	An error has occurred. Turn off the projector and then on again.
Off	Wireless LAN is not available. Make sure the wireless LAN settings are correct.

### » Related Links

- "Projector Administration Settings - Management Menu" [p.192](#)
- "Cleaning the Air Filters and Intake Vents" [p.214](#)
- "Replacing the Air Filter" [p.216](#)

You can monitor the projector's status and view error information from the status display.

- 1** Turn on the projector.
- 2** Press the [Menu] button on the control panel or remote control.
- 3** Select the **Management** setting and press [Enter].

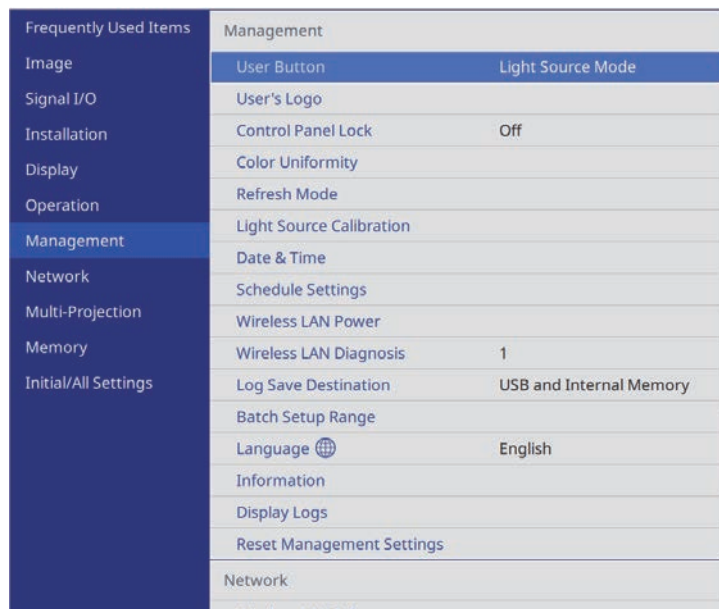

- 4** Select **Display Logs** and press [Enter].
- 5** Select **Display Status** and press [Enter].
- 6** Press the left or right arrow buttons to view different categories of information.
  - **Status Information:** The projector's operating status
  - **Source:** Input signal information

- **Signal Information:** Input digital signal information
- **Network Wired:** Wired LAN settings
- **Network Wireless:** Wireless LAN settings
- **Maintenance:** Operating time for the projector and light source
- **Version:** The projector's firmware version

► **Related Links**

- "Projector Status Display Messages" [p.226](#)

## Projector Status Display Messages

Categories on the status display let you view information about the projector and its operation.

Status messages are available only in English.

### Status Information category

Information	Description
System	See the <b>System</b> status information table.
Source	Displays the source currently being used.
On-ScreenDisplay	Displays the settings for on-screen displays. When turned off, menus or messages are not displayed on the projected images.
A/V Mute	Displays the A/V Mute status.
Intake Air Temp	Displays the air intake temperature.
Internal Temp Lv	Displays the projector's internal temperature.
Laser Status	Displays the operating status of the light source.

### Source category

Information	Description
Source	Displays the source currently being used.
Resolution	Displays the resolution of the current input signal.
Color Space	Displays the color space of the current input signal.
H-Frequency	Displays the horizontal frequency of the current input signal.
V-Frequency	Displays the vertical frequency of the current input signal.
Sync Polarity	Displays the sync polarity.
Sync Mode	Displays the sync type.
Detected Mode	Displays the detected mode of the current input signal.
Video Range	Displays the video level of the projector.

#### Signal Information category

Information	Description
5V Detect	Displays the detection results of 5V signals.
TMDS Clock	Displays the TMDS frequency of the current input signal.
H-Frequency	Displays the horizontal frequency of the current input signal.
V-Frequency	Displays the vertical frequency of the current input signal.
Stable Time	Displays the amount of operating time since the input source was determined.
HDCP Status	Displays the HDCP status.
HDCP Ver	Displays the HDCP version.
AVI VIC	Displays the VIC information (AVI) of the current input signal.
AVI Checksum	Displays the checksum result for AVI.
AVI Sampling Str	Displays color sampling for AVI.
Signal Mode	Displays the signal mode.
HDBaseT Level	Displays the image signal information from the HDBaseT port.

#### Network Wired category

Information	Description
Projector Name	Displays the name used to identify the projector when connected to a network.
Connection Mode	Displays the connection path for the LAN.
DHCP	Displays the DHCP settings.
IP Display	Displays the IP address display settings.
IP Address	Displays the IP address.
MAC Address	Displays the MAC address.

#### Network Wireless category

Information	Description
Projector Name	Displays the name used to identify the projector when connected to a network.
Connection Mode	Displays the connection mode to use when connecting the projector and a computer over a wireless LAN.
SSID	Displays the SSID.
DHCP	Displays the DHCP settings.
IP Display	Displays the IP address display settings.
IP Address	Displays the IP address.
MAC Address	Displays the MAC address.
Security	Displays the security settings.
Antenna Level	Displays the reception status for Wi-Fi.

#### Maintenance category

Information	Description
Operation Time	Displays the projector's total operation time.
Laser Op. Time	Displays the laser operating time for each <b>Light Source Mode</b> setting.

### Version category

Information	Description
Serial No.	Displays the projector's serial number.
Main	Display the projector's firmware version information.
HDBaseT	

### System status information

Status	Description
OK	The projector is in normal operating mode.
Warm-up	The projector is warming up.
Standby	The projector is in standby mode.
Cool Down	The projector is cooling down.
Temp Error	A high temperature error occurred.
Fan Error	A fan error occurred.
Sensor Error	A sensor error occurred.
Power Error	A power error occurred.
Internal Error	An internal error occurred.
Airflow Error	A filter airflow error occurred.
Temp Warning	A high temperature warning occurred.
Internal Warning	A warning regarding the internal system occurred.
Airflow Decline	A low airflow error occurred.
Power Warning	A power warning occurred.
Clean Filter	An air filter notice occurred; clean the air filter.
Laser Error	A laser error has occurred.
Laser Warning	A laser warning has occurred.
Temp Error FE	A laser error has occurred because the laser temperature is too high.

Status	Description
Temp Warning FE	A laser warning has occurred because the laser temperature is too high.

Check the solutions in these sections if you have any problems with projected images or sound.

## ► Related Links

- "Solutions When No Image Appears" [p.229](#)
- "Solutions When "No Signal" Message Appears" [p.229](#)
- "Solutions When "Not Supported" Message Appears" [p.230](#)
- "Solutions When Only a Partial Image Appears" [p.230](#)
- "Solutions When the Image is not Rectangular" [p.231](#)
- "Solutions When the Image Contains Noise or Static" [p.231](#)
- "Solutions When the Image is Fuzzy or Blurry" [p.232](#)
- "Solutions When the Image Brightness or Colors are Incorrect" [p.233](#)
- "Solutions When an Afterimage Remains on the Projected Image" [p.233](#)
- "Solutions to Sound Problems" [p.233](#)
- "Solutions When Image File Names are not Displayed Correctly in PC Free" [p.234](#)
- "Solutions When You Cannot Project Images Using the PC Free Feature" [p.234](#)

---

## Solutions When No Image Appears

If no image appears, try the following solutions:

- Press the [A/V Mute] button on the projector or remote control to see if the image was temporarily turned off.
- Make sure all necessary cables are securely connected and the power is on for the projector and connected video sources.
- Press the projector's power button to wake it from standby or sleep mode. Also, check if the connected computer is in sleep mode or displaying a blank screen saver.
- If the projector does not respond when you press the control panel buttons, the buttons may be locked for security. Unlock the buttons in the **Control Panel Lock** setting in the projector's **Management** menu or use the remote control to turn on the projector.

- If the projector does not respond when you press any buttons on the projector, an internal error may have occurred in the projector. Contact Epson for help.
- To project an image source connected to the Computer2/Monitor Out port, set the **Monitor Out Port** setting to **Computer2** in the projector's **Signal I/O** menu.
- Adjust the **Brightness** setting in the projector's **Image** menu for individual image colors.
- Adjust the brightness of your projector's light source.  
☛ **Operation > Light Source Brightness Control**
- Make sure the **Messages** setting is set to **On** in the projector's **Display** menu.
- The projector may not be able to project copyrighted videos that you play back on a computer. For more details, see the manual supplied with the computer.
- For images projected with Windows Media Center, reduce the screen size from full screen mode.
- For images projected from applications using Windows DirectX, turn off DirectX functions.

## ► Related Links

- "Projector Administration Settings - Management Menu" [p.192](#)
- "Input Signal Settings - Signal I/O Menu" [p.183](#)
- "Image Quality Settings - Image Menu" [p.180](#)
- "Projector Feature Settings - Operation Menu" [p.189](#)
- "Projector Display Settings - Display Menu" [p.187](#)
- "Unlocking the Projector's Buttons" [p.127](#)

---

## Solutions When "No Signal" Message Appears

If the "No Signal" message appears, try the following solutions:

- Press the [Source Search] button and wait a few seconds for an image to appear.

- Turn on the connected computer or video source, and press play to begin your presentation, if necessary.
- Check that all cables required for projection are securely connected.
- If you are projecting from a laptop computer, make sure it is set up to display on an external monitor.
- If necessary, turn off the projector and the connected computer or video source, and then turn them back on.
- If you are projecting from an HDMI source, replace the HDMI cable with the shorter one.

## » Related Links

- "Displaying From a Windows Laptop" [p.230](#)
- "Displaying From a Mac Laptop" [p.230](#)

## Displaying From a Windows Laptop

If the message "No Signal" is displayed when projecting from a laptop, you need to set up the Windows laptop to display on an external monitor.

- 1** Hold down the Windows key and press **P** on your keyboard at the same time, then click **Duplicate**.
- 2** If the same image is not displayed by the laptop and projector, check the Windows **Display** utility to make sure the external monitor port is enabled and extended desktop mode is disabled.
- 3** If necessary, check your video card settings and set the multiple display option to **Mirror** or **Duplicate**.

## Displaying From a Mac Laptop

If the message "No Signal" is displayed when projecting from a Mac laptop, you need to set up the laptop for mirrored display. (See your laptop manual for details.)

- 1** Open the **System Preferences** utility and select **Displays**.

- 2** Select the **Display** or **Color LCD** option, if necessary.

- 3** Click the **Arrange** or **Arrangement** tab.

- 4** Select **Mirror Displays**.

---

## Solutions When "Not Supported" Message Appears

If the message "Not supported" is displayed, try the following solutions:

- Make sure the correct input signal is selected in the projector's **Signal I/O** menu.
- Make sure the computer's display resolution does not exceed the projector's resolution and frequency limits. If necessary, select a different display resolution for your computer.
- If you are projecting from an HDMI source, change the **HDMI IN EQ Level** setting in the projector's **Signal I/O** menu. After changing the setting, you may need to restart the projector. Follow the on-screen instructions.
- If you are projecting using a thumb-sized media streaming device, set the **HDMI IN EQ Level** setting to **Auto** in the projector's **Signal I/O** menu. If a problem occurs, change the setting.

## » Related Links

- "Input Signal Settings - Signal I/O Menu" [p.183](#)
- "Supported Monitor Display Resolutions" [p.250](#)

---

## Solutions When Only a Partial Image Appears

If only a partial computer image appears, try the following solutions:

- If you are projecting from a computer using a VGA computer cable, press the [Auto] button on the remote control to optimize the image signal.
- Make sure you selected the correct **Screen Type** setting in the projector's **Installation** menu for the screen you are using.

If there are margins between the edge of the image and the projected screen frame, adjust the position of the image.

- Make sure the **Scale** setting is turned off in the projector's **Image** menu.
- Try adjusting the image position using the **Position** setting in the projector's **Image** menu.
  - ☛ **Image > Analog Signal Adjustment > Position**
- If you have adjusted the image size using the **Digital Zoom** setting in the projector's **Installation** menu, perform **Image Shift** to adjust the image position (EB-L635SU/EB-L630SU).
  - ☛ **Installation > Digital Zoom > Image Shift**
- Try adjusting the image position using the **Screen Position** setting.
  - ☛ **Installation > Screen Type > Screen Position**
- Press the [Aspect] button on the remote control to select a different image aspect ratio.
- Change the **Resolution** setting in the projector's **Image** menu according to the signal for the connected equipment.
- Change the **Blanking** setting in the projector's **Installation** menu so that the image appears as you expect.
- If you zoomed into or out of the image using the [E-Zoom] buttons, press the [Esc] button until the projector returns to a full display (EB-L735U/EB-L730U/EB-L635SU/EB-L630SU/EB-L630U/EB-L530U).
- If you zoomed into or out of the image using the [E-Zoom] buttons, press the [Default] button to return to the original image size (EB-L720U/EB-L520U).
- Check your computer display settings to disable dual display and set the resolution within the projector's limits.
- Check the resolution assigned to your presentation files to see if they are created for a different resolution.
- When projecting in Content Playback mode, make sure you are using the appropriate **Overlay Effect** settings.
  - ☛ **Operation > Content Playback > Overlay Effect**
- Make sure you selected the correct **Projection** setting in the projector's **Installation** menu.

## » Related Links

- "Projector Installation Settings - Installation Menu" [p.185](#)
- "Image Quality Settings - Image Menu" [p.180](#)
- "Supported Monitor Display Resolutions" [p.250](#)
- "Adjusting the Image Position Using Screen Position" [p.50](#)
- "Adding Effects to Your Projected Image" [p.98](#)

---

## Solutions When the Image is not Rectangular

If the projected image is not evenly rectangular, try the following solutions:

- Place the projector directly in front of the center of the screen, facing it squarely, if possible.
- Adjust the H/V-Keystone setting to correct the image shape.
  - ☛ **Installation > Geometry Correction > H/V-Keystone**
- Adjust the Quick Corner setting to correct the image shape.
  - ☛ **Installation > Geometry Correction > Quick Corner**
- Adjust the **Arc Correction** setting to correct the image shape projected on a curved surface.
  - ☛ **Installation > Geometry Correction > Arc Correction**
- Adjust the **Point Correction** setting to correct slight distortion which occurs partially.
  - ☛ **Installation > Geometry Correction > Point Correction**

## » Related Links

- "Correcting Image Shape with H/V Keystone" [p.57](#)
- "Correcting the Image Shape with Quick Corner" [p.59](#)
- "Correcting Image Shape with Arc Correction" [p.61](#)
- "Correcting Image Shape with Point Correction" [p.63](#)

---

## Solutions When the Image Contains Noise or Static

If the projected image contains electronic interference (noise) or static, try the following solutions:

- Check the cables connecting your computer or video source to the projector. They should be:
  - Separated from the power cord to prevent interference
  - Securely connected at both ends
  - Not connected to an extension cable
- Adjust the **Noise Reduction**, **MPEG Noise Reduction**, and **Deinterlacing** settings in the projector's **Image** menu.
  - ☛ **Image > Image Enhancement > Noise Reduction**
  - ☛ **Image > Image Enhancement > MPEG Noise Reduction**
  - ☛ **Image > Image Enhancement > Deinterlacing**
- Set the **Resolution** setting to **Auto** in the projector's **Image** menu.
- Select a computer video resolution and refresh rate that are compatible with the projector.
- If you are projecting from a computer using a VGA computer cable, press the [Auto] button on the remote control to automatically adjust the **Tracking** and **Sync.** settings. If the images are not adjusted correctly, manually adjust the **Tracking** and **Sync.** settings in the projector's **Image** menu.
  - ☛ **Image > Analog Signal Adjustment > Tracking**
  - ☛ **Image > Analog Signal Adjustment > Sync.**
- If you adjusted the image shape using the projector controls, try decreasing the **Sharpness** setting in the projector's **Image** menu to improve image quality.
- If you connected an extension power cable, try projecting without it to see if it caused interference in the signal.
- Make sure you selected the correct **Signal Format** or **EDID** setting in the projector's **Signal I/O** menu, if available for your image source.

## » Related Links

- "Image Quality Settings - Image Menu" [p.180](#)
- "Supported Monitor Display Resolutions" [p.250](#)
- "Input Signal Settings - Signal I/O Menu" [p.183](#)

## Solutions When the Image is Fuzzy or Blurry

If the projected image is fuzzy or blurry, try the following solutions:

- Display a test pattern and use it to adjust the image focus using the focus ring.
- Position the projector close enough to the screen.
- Position the projector so the keystone adjustment angle is not so wide that it distorts the image.
- Clean the projector lens.



To avoid condensation on the lens after bringing the projector in from a cold environment, let the projector warm up to room temperature before using it.

- Adjust the **Sharpness** setting in the projector's **Image** menu to improve image quality.
- If you are projecting from a computer using a VGA computer cable, press the [Auto] button on the remote control to automatically adjust the **Tracking** and **Sync.** settings. If any bands or overall blurriness remain, display a uniformly patterned image on the screen and manually adjust the **Tracking** and **Sync.** settings.
  - ☛ **Image > Analog Signal Adjustment > Tracking**
  - ☛ **Image > Analog Signal Adjustment > Sync.**
- If you are projecting from a computer, use a lower resolution or select a resolution that matches the projector's native resolution.

## » Related Links

- "Image Quality Settings - Image Menu" [p.180](#)
- "Input Signal Settings - Signal I/O Menu" [p.183](#)
- "Supported Monitor Display Resolutions" [p.250](#)
- "Focusing the Image Using the Focus Ring" [p.69](#)



---

## Solutions When the Image Brightness or Colors are Incorrect

If the projected image is too dark or light, or the colors are incorrect, try the following solutions:

- Press the [Color Mode] button on the remote control to try different color modes for the image and environment.
- Check your video source settings.
- Adjust the available settings in the projector's **Image** menu for the current input source, such as **Brightness**, **Contrast**, **Tint**, **Color Saturation**, and **RGBCMY**.
- Make sure you selected the correct **Signal Format** or **EDID** setting in the projector's **Signal I/O** menu, if available for your image source.
- Make sure all the cables are securely connected to the projector and your video device. If you connected long cables, try connecting shorter cables.
- Position the projector close enough to the screen.
- When using multiple projectors, make sure the **Light Source Calibration** setting in the projector's **Management** menu is set to the same option on all the projectors and that the projectors have been calibrated recently. If certain projectors are not calibrated recently, the white balance and brightness level may not match the other projectors.

### » Related Links

- "Image Quality Settings - Image Menu" [p.180](#)
- "Input Signal Settings - Signal I/O Menu" [p.183](#)
- "Projector Administration Settings - Management Menu" [p.192](#)
- "Adjusting Image Quality (Color Mode)" [p.74](#)

---

## Solutions When an Afterimage Remains on the Projected Image

If you see an afterimage in the projected image, use the **Refresh Mode** feature to clear it. Select **Refresh Mode** > **Start** in the projector's **Management** menu.

### » Related Links

- "Projector Administration Settings - Management Menu" [p.192](#)

---

## Solutions to Sound Problems

If there is no sound or the volume is too low or high, try the following solutions:

- Adjust the projector's volume settings.
- Press the [A/V Mute] button on the projector or remote control to resume video and audio if they were temporarily stopped.
- Check your computer or video source to make sure the volume is turned up and the audio output is set for the correct source.
- Check the audio cable connections between the projector and your video source.
- Make sure any connected audio cables are labeled "No Resistance".
- Select the correct audio output port.
  - **Signal I/O > Audio Output**
  - **Signal I/O > HDMI Audio Output**
- If you want to output audio from a connected audio source when the projector does not project any images, select these settings in the projector's menus:
  - Turn off **Quick Startup** in the **Operation** menu.
  - Set the **A/V Output** setting to **Always On** in the **Signal I/O** menu.
- If you do not hear sound from an HDMI source, set the connected device to PCM output.
- When you are connecting the projector to a Mac using an HDMI cable, make sure your Mac supports audio through the HDMI port. If not, you need to connect an audio cable.
- If the volume for the computer is set to the minimum while the projector is set to the maximum, the noise may be mixed. Turn up the computer's volume and turn down the projector's volume. (When you use Epson iProjection (Windows/Mac).)

## » Related Links

- "Projector Connections" [p.30](#)
- "Input Signal Settings - Signal I/O Menu" [p.183](#)
- "Controlling the Volume with the Volume Buttons" [p.84](#)

---

## Solutions When Image File Names are not Displayed Correctly in PC Free

If any file names are longer than the display area or include unsupported symbols, the file names are shortened or changed in PC Free. Shorten or change the file name.

---

## Solutions When You Cannot Project Images Using the PC Free Feature

If you cannot project images using the PC Free feature, try the following solutions:

- If you are using a USB device with a slow transfer speed, you may not be able to project movies correctly.
- You cannot play movies saved with a movie codec other than H.264 and H.265. (H.265 only supports Main Profile.)
- You cannot play audio saved with an audio codec other than LPCM and AAC-LC.

## » Related Links

- "Supported PC Free File Types" [p.89](#)

Check the solutions in these sections if you have problems operating the projector or remote control.

## » Related Links

- "Solutions to Projector Power or Shut-Off Problems" [p.235](#)
- "Solutions to Problems with the Remote Control" [p.235](#)
- "Solutions to Password Problems" [p.236](#)
- "Solution When "The Battery that Saves Your Clock Settings is Running Low" Message Appears" [p.236](#)

---

## Solutions to Projector Power or Shut-Off Problems

If the projector does not turn on when you press the power button or it turns off unexpectedly, try the following solutions:

- Make sure the power cord is securely connected to the projector and to a working electrical outlet.
- If the power button on the remote control does not turn on the projector, check its batteries and make sure at least one of the remote receivers are available in the **Remote Receiver** setting in the projector's **Installation** menu.
- The projector's buttons may be locked for security. Unlock the buttons in the **Control Panel Lock** setting in the projector's **Management** menu or use the remote control to turn on the projector.
- If the projector's light source turns off unexpectedly, it may have entered sleep mode after a period of inactivity. Perform any operation to wake the projector. To turn off sleep mode, set the **Sleep Mode** setting to **Off** in the projector's **Operation** menu.
- If the projector's light source turns off unexpectedly, the A/V mute timer may be enabled. Set the **A/V Mute Timer** setting to **Off** in the projector's **Operation** menu.
- If the projector's light source turns off, the status indicator is flashing, and the temp (temperature) indicator is lit, the projector has overheated and turned off.

- The cooling fans may run in standby status depending on the projector settings. Also, when the projector wakes from standby status, the fans may cause an unexpected noise. This is not a malfunction.
- The power cord may be defective. Disconnect the cord and contact Epson for help.

## » Related Links

- "Projector Administration Settings - Management Menu" [p.192](#)
- "Projector Feature Settings - Operation Menu" [p.189](#)
- "Projector Installation Settings - Installation Menu" [p.185](#)
- "Unlocking the Projector's Buttons" [p.127](#)

---

## Solutions to Problems with the Remote Control

If the projector does not respond to remote control commands, try the following solutions:

- Check that the remote control batteries are installed correctly and have power. If necessary, replace the batteries.
- Make sure you are operating the remote control within the reception angle and range of the projector.
- Make sure the projector is not warming up or shutting down.
- Check to see if a button on the remote control is stuck down, causing it to enter sleep mode. Release the button to wake the remote control up.
- Strong fluorescent lighting, direct sunlight, or infrared device signals may be interfering with the projector's remote receivers. Dim the lights or move the projector away from the sun or interfering equipment.
- Make sure at least one of the remote receivers are available in the **Remote Receiver** setting in the projector's **Installation** menu.
- If the **Remote Receiver** setting is disabled, hold down the [Menu] button on the remote control for at least 15 seconds to reset the setting to its default.
- If you assigned an ID number to the projector to operate multiple projectors from the remote control, you may need to check or change the ID setting.

- Press the 0 (zero) button on the remote control while holding down the [ID] button. By selecting 0 on the remote control, you can operate all of the projectors regardless of the projector ID settings.
- If you lose the remote control, you can order another one from Epson.

## ► Related Links

- "Remote Control Operation" [p.40](#)
- "Projector Installation Settings - Installation Menu" [p.185](#)
- "Installing Batteries in the Remote Control" [p.39](#)
- "Selecting the Projector You want to Operate" [p.114](#)

---

## Solutions to Password Problems

If you cannot enter or remember a password, try the following solutions:

- You may have turned on password protection without first setting a password. Try entering **0000** using the remote control.
- If you have entered an incorrect password too many times and see a message displaying a request code, write down the code and contact Epson for help. Provide the request code and proof of ownership for assistance in unlocking the projector.
- If you set an Epson Web Control password and forgot the user ID or password, try entering the following:
  - User ID: **EPSONWEB**
  - Default password: **admin**
- If you set a Remote password (in Epson Web Control) and forgot the user ID or password, try entering the following:
  - User ID: **EPSONREMOTE**
  - Default password: **guest**
- If you lose the remote control you cannot enter a password. Order a new one from Epson.

---

## Solution When "The Battery that Saves Your Clock Settings is Running Low" Message Appears

If the message "The battery that saves your clock settings is running low." is displayed, contact Epson for help.

Check the solutions in these sections if you have problems using the projector on a network.

## ► Related Links

- "Solutions When Wireless Authentication Fails" [p.237](#)
- "Solutions When You Cannot Access the Projector Through the Web" [p.237](#)
- "Solutions When Network Alert E-Mails are not Received" [p.237](#)
- "Solutions When the Image Contains Static During Network Projection" [p.238](#)
- "Solutions When You Cannot Connect Using Screen Mirroring" [p.238](#)
- "Solutions When You Cannot Use Two Screen Mirroring Sources" [p.238](#)
- "Solutions When the Image or Sound Contains Static During Screen Mirroring Connection" [p.239](#)
- "Solutions When You Cannot Receive Shared Images" [p.239](#)

---

## Solutions When Wireless Authentication Fails

If you are having trouble with the authentication, try the following solutions:

- If the wireless settings are correct, but authentication fails, you may need to update the **Date & Time** settings in the projector's **Management** menu.
- Check the **Security** settings in the projector's **Network** menu.
  - ☛ **Network > Network Settings > Wireless LAN > Security**
- If the access point security is WPA3-EAP, change the access point setting to WPA2/WPA3-EAP.

## ► Related Links

- "Projector Administration Settings - Management Menu" [p.192](#)
- "Network Menu - Wireless LAN Menu" [p.197](#)

---

## Solutions When You Cannot Access the Projector Through the Web

If you are unable to access the projector through a Web browser, make sure you are using the correct ID and password.

- For the user ID, enter **EPSONWEB**. (You cannot change the user ID.)
- For the password, enter the password set in the projector's **Network** menu. The default password is **admin**.
- For the infrastructure mode, make sure you have access to the network the projector is on.
- If your Web browser is set up to connect via a proxy server, the **Epson Web Control** screen cannot be displayed. Make settings for a connection without using a proxy server.
- If you set the **Standby Mode** setting to **Communication On** in the projector's **Operation** menu, make sure the network device is turned on. After turning on the network device, turn on the projector. If you are connecting wirelessly, connect to devices over a wireless network access point.



The user ID and password are case sensitive.

## ► Related Links

- "Network Menu - Network Settings Menu" [p.196](#)
- "Projector Feature Settings - Operation Menu" [p.189](#)

---

## Solutions When Network Alert E-Mails are not Received

If you do not receive an e-mail alerting you to problems with a projector over the network, try the following solutions:

- Make sure the projector is turned on and connected to the network correctly. (If an error shuts down the projector, the email may not be delivered.)
- Make sure you set up the projector e-mail alert settings correctly in the projector's network **Mail Notification** menu or in the network software.

- Set the **Standby Mode** setting to **Communication On** in the projector's **Operation** menu so that the network software can monitor the projector in standby mode.  
Change the **Port** setting according to your network environment. If you are connecting wirelessly, connect to devices over a wireless network access point.

#### » Related Links

- "Network Menu - Mail Notification Menu" [p.200](#)
- "Projector Feature Settings - Operation Menu" [p.189](#)

---

## Solutions When the Image Contains Static During Network Projection

If the projected image contains static during network projection, try the following solutions:

- Check for any obstacles between the access point, the computer, the mobile device, and the projector, and change their positions to improve communication.
- Make sure that the access point, the computer, the mobile device and the projector are not too far apart. Move them closer together and try to connect again.
- Check for interference from other equipment, such as a Bluetooth device or microwave. Move the interfering device farther away or expand your wireless bandwidth.
- Reduce the number of connected devices if the connection speed declines.

---

## Solutions When You Cannot Connect Using Screen Mirroring

If you are unable to connect to the projector using Screen Mirroring, try the following solutions:

- Check the projector's settings.

- Set the **Simple AP** setting to **On**.  
☛ **Network > Network Settings > Simple AP**
- Set the **Screen Mirroring** setting to **On**.  
☛ **Network > Network Settings > Network Projection > Screen Mirroring**
- Select the **Screen Mirroring** setting to **Off** and select **On** again.  
☛ **Network > Network Settings > Network Projection > Screen Mirroring**
- Check the mobile device's settings.
  - Make sure the settings on the mobile device are correct.
  - When connecting again immediately after disconnecting, it may take some time until the connection is established. Reconnect after waiting for a while.
  - Restart the mobile device.
  - Once you have connected using Screen Mirroring, the projector connection information may be recorded on the mobile device. However, you may not be able to reconnect to the projector from the recorded information. Select the projector from the list of available devices.

#### » Related Links

- "Network Menu - Network Settings Menu" [p.196](#)
- "Network Menu - Network Projection Settings" [p.201](#)

---

## Solutions When You Cannot Use Two Screen Mirroring Sources

If you are unable to use two Screen Mirroring sources at the same time, set the **Interrupt Connection** setting to **Off**.

☛ **Network > Network Settings > Network Projection > Screen Mirroring**

#### » Related Links

- "Network Menu - Network Projection Settings" [p.201](#)

---

## Solutions When the Image or Sound Contains Static During Screen Mirroring Connection

If the projected image or sound contains static when connecting using Screen Mirroring, try the following solutions:

- Avoid covering the Wi-Fi antenna of the mobile device.
- If you use a Screen Mirroring connection and an internet connection at the same time, the image may stop or contain noise. Disconnect the internet connection to expand your wireless bandwidth and improve the connection speed of the mobile device.
- Make sure the projection contents meet the Screen Mirroring requirements.
- Depending on the settings of the mobile device, the connection may be lost when the device enters power saving mode. Check the electrical power saving settings on the mobile device.
- Update to the latest version of the wireless driver or firmware on the mobile device.

---

## Solutions When You Cannot Receive Shared Images

If you cannot receive shared images from other projectors, try the following solutions:

- Connect the projector to the same network as the projector that is sharing images.
- Make sure the **Screen Sharing** setting is set to **On**.
  - ☛ **Network > Network Settings > Network Projection > Screen Sharing**
- Make sure that no other device is connecting to the projector using the Epson iProjection software.
- If the firmware version amongst the projectors sharing the screen is not the same, you may need to update the projector's firmware to share your screen.

### » Related Links

- "Network Menu - Network Projection Settings" [p.201](#)

If you cannot play back a playlist correctly, try the following solutions:

- Make sure **Content Playback** is set to **On**.
  - ☛ **Operation > Content Playback**
- Make sure the USB flash drive contains a playlist.
- Make sure the USB flash drive is directly connected to the projector. Do not use a multi-card reader or a USB hub to expand a USB port.
- If the USB flash drive is partitioned, you may not be able to play back playlists. Delete all of the partitions before saving the playlists on the USB flash drive.
- Do not share a playlist between projectors that are different in resolution. Color and shape effects added by using **Overlay Effect** may not be reproduced correctly.
  - ☛ **Operation > Content Playback > Overlay Effect**

## ▶ **Related Links**

- "Projector Feature Settings - Operation Menu" [p.189](#)



If you cannot operate the connected devices using the HDMI Link features, try the following solutions:

- Set the **HDMI Out Setting** setting to **Pass Through** in the projector's **Multi-Projection** menu (EB-L735U/EB-L730U/EB-L635SU/EB-L630SU/EB-L630U/EB-L530U).
- Make sure the cable meets the HDMI CEC standard.
- Make sure the connected device meets the HDMI CEC standard. See the documentation supplied with the device for more information.
- Check that all cables required for HDMI Link are securely connected.
- Make sure the connected devices are turned on and in standby status. See the documentation supplied with the device for more information.
- If you connected a speaker, set it to PCM output.
- If you connect a new device or change the connection, set the CEC function for the connected device again and restart the device.
- Do not connect 4 or more multi-media players. You can connect up to 3 multi-media players that meet the HDMI CEC standard at the same time.
- If the device does not appear in the Device Connections list, it does not meet the HDMI CEC standards. Connect a different device.

### » **Related Links**

- "Multiple Projector Operation Settings - Multi-Projection Menu" [p.203](#)

# Appendix

Check these sections for the technical specifications and important notices about your product.

## ► **Related Links**

- "Optional Accessories and Replacement Parts" [p.243](#)
- "Screen Size and Projection Distance" [p.245](#)
- "Supported Monitor Display Resolutions" [p.250](#)
- "Projector Specifications" [p.254](#)
- "External Dimensions" [p.256](#)
- "Supported Features for Epson Projector Content Manager" [p.257](#)
- "Supported Features for the Epson Projector Professional Tool" [p.258](#)
- "List of Safety Symbols and Instructions" [p.259](#)
- "Laser Safety Information" [p.261](#)
- "Glossary" [p.263](#)
- "Notices" [p.265](#)

The following optional accessories and replacement parts are available. Please purchase these products as and when needed.

The following list of optional accessories and replacement parts is current as of: February 2021.

Details of accessories are subject to change without notice and availability may vary depending on the country of purchase.

## ► Related Links

- "Screens" [p.243](#)
- "Cables" [p.243](#)
- "Mounts" [p.243](#)
- "For Wireless Connection" [p.243](#)
- "External Devices" [p.243](#)
- "Replacement Parts" [p.244](#)

---

## Screens

### 80" Mobile X-Type Screen ELPSC21

Portable X-type screens. (aspect ratio 16:9)

### Multi Aspect Screen ELPSC26

Portable multi-aspect screen.

---

## Cables

**Computer cable ELPKC02 (1.8 m - for mini D-sub 15-pin/mini D-Sub 15pin)**

**Computer cable ELPKC09 (3 m - for mini D-sub 15-pin/mini D-Sub 15pin)**

**Computer cable ELPKC10 (20 m - for mini D-sub 15-pin/mini D-Sub 15pin)**

Use when connecting to the Computer port.

---

## Mounts

### Ceiling mount ELPMB22

### Ceiling mount (Low profile) ELPMB30

Use when installing the projector on a ceiling.

### Safety Wire Set ELPWR01

Use when connecting the projector to the installation mount to prevent the projector from falling down.

### Ceiling pipe (450 mm) ELPFP13

### Ceiling pipe (700 mm) ELPFP14

Use when installing the projector on a high ceiling.



Special expertise is required to suspend the projector from a ceiling. Contact Epson for help.

---

## For Wireless Connection

### Wireless LAN module ELPAP11

Use this to project images from a computer via a wireless communication.

### Wireless Presentation System ELPWP10

Use when directly connecting to Windows/Mac computers and projecting images wirelessly. Includes two wireless transmitters (ELPWT01) and one wireless LAN module (ELPAP11).

### Wireless Transmitter ELPWT01

Additional wireless transmitter for wireless presentation system.

---

## External Devices

### Document Camera ELPDC21

### Document Camera ELPDC13

### Document Camera ELPDC07

Use when projecting image such as books, OHP documents, or slides.

**External Speaker ELPSP02**

External self-powered speaker.

**HDBaseT Transmitter ELPHD01**

Use when sending an HDMI signal over a long distance. (HDCP 2.2 is not supported)

**Android TV™ device ELPAP12**

(EB-L735U/EB-L730U/EB-L635SU/EB-L630SU/EB-L630U/EB-L530U)

Use this streaming media player to watch online content.

---

## Replacement Parts

**Air filter ELPAF56**

Use as a replacement for used air filters.

Check the tables in these sections to determine how far to place the projector from the screen based on the size of the projected image.

► **Related Links**

- "EB-L735U/EB-L730U/EB-L635SU/EB-L630SU/EB-L630U/EB-L530U" [p.245](#)
- "EB-L720U/EB-L520U" [p.248](#)

## EB-L735U/EB-L730U/EB-L635SU/EB-L630SU/EB-L630U /EB-L530U

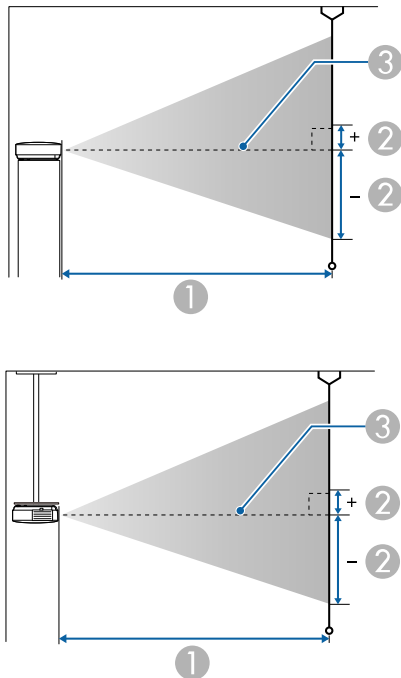

- ① Projection distance (cm)
- ② Distance from the center of the lens to the base of the screen (This changes depending on the setting for vertical lens shift.) (cm)

③ Center of lens

### WUXGA (EB-L735U/EB-L730U/EB-L630U/EB-L530U)

16:10 screen size		①	②
		Minimum (Wide) to Maximum (Tele)	Vertical Lens Shift Bottom to Top
50"	108 × 67	144 - 235	-67 - 0
60"	129 × 81	174 - 283	-81 - 0
70"	151 × 94	204 - 331	-94 - 0
80"	172 × 108	233 - 378	-108 - 0
100"	215 × 135	292 - 474	-135 - 0
120"	258 × 162	351 - 569	-162 - 0
150"	323 × 202	440 - 713	-202 - 0
200"	431 × 269	588 - 951	-269 - 0
300"	646 × 404	884 - 1429	-404 - 0
500"	1077 × 673	1476 - 2384	-673 - 0

4:3 screen size		①	②
		Minimum (Wide) to Maximum (Tele)	Vertical Lens Shift Bottom to Top
45"	91 × 69	147 - 240	-69 - 0
50"	102 × 76	164 - 267	-76 - 0
60"	122 × 91	197 - 321	-91 - 0
80"	163 × 122	264 - 429	-122 - 0
100"	203 × 152	331 - 537	-152 - 0
110"	224 × 168	365 - 591	-168 - 0
120"	244 × 183	398 - 645	-183 - 0
150"	305 × 229	499 - 807	-229 - 0
200"	406 × 305	666 - 1077	-305 - 0

4:3 screen size		①	②
		Minimum (Wide) to Maximum (Tele)	Vertical Lens Shift Bottom to Top
300"	610 × 457	1001 - 1618	-457 - 0
440"	894 × 671	1470 - 2375	-671 - 0

16:9 screen size		①	②
		Minimum (Wide) to Maximum (Tele)	Vertical Lens Shift Bottom to Top
49"	108 × 61	145 - 237	-64 - 3
50"	111 × 62	148 - 242	-66 - 3
60"	133 × 75	179 - 291	-79 - 4
80"	177 × 100	240 - 389	-105 - 6
100"	221 × 125	301 - 487	-131 - 7
110"	244 × 137	331 - 536	-145 - 8
120"	266 × 149	361 - 585	-158 - 8
150"	332 × 187	453 - 733	-197 - 10
200"	443 × 249	605 - 978	-263 - 14
300"	664 × 374	909 - 1469	-394 - 21
480"	1063 × 598	1456 - 2352	-631 - 33

16:6 screen size		①	②
		Minimum (Wide) to Maximum (Tele)	Vertical Lens Shift Bottom to Top
46"	109 × 41	147 - 239	-55 - 14
50"	119 × 45	160 - 260	-59 - 15
60"	143 × 54	192 - 313	-71 - 18
70"	166 × 62	225 - 366	-83 - 21
80"	190 × 71	258 - 418	-95 - 24

16:6 screen size		①	②
		Minimum (Wide) to Maximum (Tele)	Vertical Lens Shift Bottom to Top
100"	238 × 89	323 - 524	-119 - 30
120"	285 × 107	388 - 629	-143 - 36
150"	357 × 134	486 - 787	-178 - 45
200"	476 × 178	650 - 1051	-238 - 59
300"	713 × 268	976 - 1578	-357 - 89
452"	1075 × 403	1473 - 2379	-537 - 134

### WUXGA (EB-L635SU/EB-L630SU)

16:10 screen size		①	②
		Minimum (Wide) to Maximum (Tele) *	Vertical Lens Shift Bottom to Top
50"	108 × 67	85 - 115	-67 - 0
60"	129 × 81	103 - 139	-81 - 0
80"	172 × 108	138 - 186	-108 - 0
90"	194 × 121	156 - 210	-121 - 0
100"	215 × 135	173 - 234	-135 - 0
148"	319 × 199	258 - 348	-199 - 0
150"	323 × 202	261**	-202 - 0
180"	388 × 242	314**	-242 - 0
200"	431 × 269	349**	-269 - 0

4:3 screen size		①	②
		Minimum (Wide) to Maximum (Tele) *	Vertical Lens Shift Bottom to Top
45"	91 × 69	87 - 117	-69 - 0
50"	102 × 76	97 - 131	-76 - 0

4:3 screen size		①	②
		Minimum (Wide) to Maximum (Tele) *	Vertical Lens Shift Bottom to Top
60"	122 × 91	117 - 157	-91 - 0
80"	163 × 122	157 - 211	-122 - 0
90"	183 × 137	176 - 238	-137 - 0
100"	203 × 152	196 - 265	-152 - 0
120"	244 × 183	236 - 319	-183 - 0
130"	264 × 198	256 - 346	-198 - 0
150"	305 × 229	296**	-229 - 0
176"	358 × 268	348**	-268 - 0

16:9 screen size		①	②
		Minimum (Wide) to Maximum (Tele) *	Vertical Lens Shift Bottom to Top
49"	108 × 61	86 - 116	-64 - 3
50"	111 × 62	88 - 118	-66 - 3
60"	133 × 75	106 - 143	-79 - 4
80"	177 × 100	142 - 191	-105 - 6
100"	221 × 125	178 - 240	-131 - 7
120"	266 × 149	214 - 289	-158 - 8
144"	319 × 179	258 - 348	-189 - 10
150"	332 × 187	269**	-197 - 10
180"	398 × 224	323**	-237 - 12
194"	429 × 242	348**	-255 - 13

16:6 screen size		①	②
		Minimum (Wide) to Maximum (Tele) *	Vertical Lens Shift Bottom to Top
46"	109 × 41	86 - 117	-55 - 14
50"	119 × 45	94 - 127	-59 - 15
60"	143 × 54	114 - 153	-71 - 18
80"	190 × 71	153 - 206	-95 - 24
100"	238 × 89	191 - 259	-119 - 30
120"	285 × 107	230 - 311	-143 - 36
134"	319 × 120	258 - 348	-159 - 40
150"	357 × 134	289**	-178 - 45
180"	428 × 161	347**	-214 - 54
181"	430 × 161	349**	-215 - 54

\* Maximum (Tele): Digital zoom

\*\* Project using Wide (maximum zoom).

## EB-L720U/EB-L520U

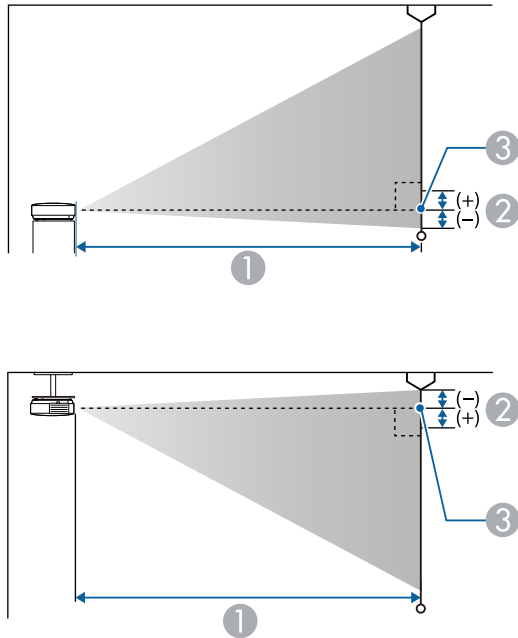

- ① Projection distance (cm)
- ② Distance from the center of the lens to the base of the screen (or to the top of the screen, if suspended from a ceiling) (cm)
- ③ Center of lens

### WUXGA

16:10 screen size		①	②
		Minimum (Wide) to Maximum (Tele)	
50"	108 × 67	144 - 235	-2
60"	129 × 81	174 - 283	-3

16:10 screen size		①	②
		Minimum (Wide) to Maximum (Tele)	
70"	151 × 94	204 - 331	-3
80"	172 × 108	233 - 378	-4
100"	215 × 135	292 - 474	-5
120"	258 × 162	351 - 569	-6
150"	323 × 202	440 - 713	-7
200"	431 × 269	588 - 951	-10
300"	646 × 404	884 - 1429	-14
500"	1077 × 673	1476 - 2384	-24

4:3 screen size		①	②
		Minimum (Wide) to Maximum (Tele)	
45"	91 × 69	147 - 240	-2
50"	102 × 76	164 - 267	-3
60"	122 × 91	197 - 321	-3
70"	142 × 107	231 - 375	-4
80"	163 × 122	264 - 429	-4
100"	203 × 152	331 - 537	-5
120"	244 × 183	398 - 645	-7
150"	305 × 229	499 - 807	-8
200"	406 × 305	666 - 1077	-11
300"	610 × 457	1001 - 1618	-16
440"	894 × 671	1470 - 2375	-24



16:9 screen size		①	②
		Minimum (Wide) to Maximum (Tele)	
49"	108 × 61	145 - 237	1
50"	111 × 62	148 - 242	1
60"	133 × 75	179 - 291	1
70"	155 × 87	209 - 340	1
80"	177 × 100	240 - 389	2
100"	221 × 125	301 - 487	2
120"	266 × 149	361 - 585	2
150"	332 × 187	453 - 733	3
200"	443 × 249	605 - 978	4
300"	664 × 374	909 - 1469	6
486"	1076 × 605	1474 - 2381	9

16:6 screen size		①	②
		Minimum (Wide) to Maximum (Tele)	
46"	109 × 41	147 - 239	11
50"	119 × 45	160 - 260	12
60"	143 × 54	192 - 313	15
70"	166 × 62	225 - 366	17
80"	190 × 71	258 - 418	20
100"	238 × 89	323 - 524	24
120"	285 × 107	388 - 629	29
150"	357 × 134	486 - 787	37
200"	476 × 178	650 - 1051	49
300"	713 × 268	976 - 1578	73
452"	1075 × 403	1473 - 2379	110

The table here lists the compatible refresh rate and resolution for each compatible video display format.

 The Computer port source does not support YCbCr signals.

## PC

### Compatible Mode

Mode	Resolution (dot)		Refresh Rate (Hz)	Computer	HDMI/HDBaseT				
					RGB HV	YCbCr(8bit)			RGB (8bit)
						4:2:0	4:2:2	4:4:4	
VGA60	640	480	60	✓				✓	
VGA72	640	480	72	✓					
VGA75	640	480	75	✓					
VGA85	640	480	85	✓					
SVGA60	800	600	60	✓				✓	
SVGA72	800	600	72	✓					
SVGA75	800	600	75	✓					
SVGA85	800	600	85	✓					
XGA60	1024	768	60	✓				✓	
XGA70	1024	768	70	✓					
XGA75	1024	768	75	✓					
XGA85	1024	768	85	✓					
WXGA60-1	1280	768	60	✓					
WXGA60	1280	800	60	✓				✓	
WXGA75	1280	800	75	✓					
WXGA85	1280	800	85	✓					
WXGA60-3	1366	768	60	✓				✓	

Mode	Resolution (dot)		Refresh Rate (Hz)	Computer	HDMI/HDBaseT				
					RGB HV	YCbCr(8bit)			RGB (8bit)
						4:2:0	4:2:2	4:4:4	
WXGA+60	1440	900	60	✓				✓	
WXGA+75	1440	900	75	✓					
WXGA+85	1440	900	85	✓					
WXGA++	1600	900	60	✓				✓	
SXGA1_70	1152	864	70	✓					
SXGA1_75	1152	864	75	✓					
SXGA1_85	1152	864	85	✓					
SXGA2_60	1280	960	60	✓				✓	
SXGA2_75	1280	960	75	✓					
SXGA2_85	1280	960	85	✓					
SXGA3_60	1280	1024	60	✓				✓	
SXGA3_75	1280	1024	75	✓					
SXGA3_85	1280	1024	85	✓					
SXGA+60	1400	1050	60	✓				✓	
SXGA+75	1400	1050	75	✓					
WSXGA+60	1680	1050	60	✓*				✓	
UXGA60	1600	1200	60	✓				✓	
1920×1080_50	1920	1080	50	✓				✓	
1920×1080_60	1920	1080	60	✓				✓	
WUXGA60 (Reduced Blanking)	1920	1200	60	✓				✓	
QXGA	2048	1536	60					✓	
WQHD	2560	1440	60					✓	

Mode	Resolution (dot)		Refresh Rate (Hz)	Computer	HDMI/HDBaseT				
					RGB HV	YCbCr(8bit)			RGB (8bit)
						4:2:0	4:2:2	4:4:4	
WQXGA (Reduced Blanking)	2560	1600	60					✓	

\* Only compatible when **Wide** is selected as the **Resolution** setting in the projector's **Image** menu.

### Unique Aspect

Compatible Mode

Mode	HDMI/HDBaseT											
	RGB			YCbCr								
				4:4:4			4:2:2			4:2:0		
	8	10	12	8	10	12	8	10	12	8	10	12
Unique aspect (16:6)	✓											

Mode Information

Mode	Resolution (dot)		H Sync (KHz)	Refresh Rate (Hz)	Dotclk (MHz)	Scan Type
Unique aspect (16:6)	1920	720	45.96	60	95.045	Progressive

If the image is not projected correctly, set the timing settings on your computer to match the values in the following tables. (You may not be able to change these settings, depending on your computer.)

Mode	Dotclk (MHz)	H Freq (KHz)	V Freq (Hz)	H active (dot)	H Front Porch (dot)	H Sync Width (dot)	H Back Porch (dot)
Unique aspect (16:6)	95.045	45.96	60	1920	42	32	74

Mode	V active (Line)	V Front Porch (Line)	V Sync Width (Line)	V Back Porch (Line)	H Sync Polarity	V Sync Polarity	Scan Type
Unique aspect (16:6)	720	20	8	18	P	N	Progressive

P: Positive

N: Negative

### SD

Compatible Mode

Mode	Resolution (dot)		Refresh Rate (Hz)	Computer	HDMI/HDBaseT				
					RGB HV	YCbCr(8bit)			RGB (8bit)
						4:2:0	4:2:2	4:4:4	
SDTV (480i)	720	480	59.94			✓	✓	✓	
SDTV (576i)	720	576	50			✓	✓	✓	
SDTV (480p)	720	480	59.94	✓		✓	✓	✓	
SDTV (576p)	720	576	50	✓		✓	✓	✓	

### HD

Compatible Mode

Mode	Resolution (dot)		Refresh Rate (Hz)	Computer	HDMI/HDBaseT				
					RGB HV	YCbCr(8bit)			RGB (8bit)
						4:2:0	4:2:2	4:4:4	
HDTV (720p)_50	1280	720	50	✓		✓	✓	✓	
HDTV (720p)_59.94	1280	720	59.94	✓		✓	✓	✓	
HDTV (720p)_60	1280	720	60	✓		✓	✓	✓	
HDTV (1080i)_50	1920	1080	50			✓	✓	✓	
HDTV (1080i)_59.94	1920	1080	59.94			✓	✓	✓	
HDTV (1080i)_60	1920	1080	60			✓	✓	✓	
HDTV (1080p)_23.98	1920	1080	23.98			✓	✓	✓	
HDTV (1080p)_24	1920	1080	24			✓	✓	✓	
HDTV (1080p)_29.97	1920	1080	29.97			✓	✓	✓	
HDTV (1080p)_30	1920	1080	30			✓	✓	✓	
HDTV (1080p)_50	1920	1080	50	✓		✓	✓	✓	
HDTV (1080p)_59.94	1920	1080	59.94	✓		✓	✓	✓	
HDTV (1080p)_60	1920	1080	60	✓		✓	✓	✓	

## 4K

### Compatible Mode

Mode	Resolution (dot)		Refresh Rate (Hz)	Computer	HDMI/HDBaseT				
					RGB HV	YCbCr(8bit)			RGB (8bit)
						4:2:0	4:2:2	4:4:4	
4K (3840×2160)	3840	2160	23.98			✓	✓	✓	
4K (3840×2160)	3840	2160	24			✓	✓	✓	
4K (3840×2160)	3840	2160	25			✓	✓	✓	
4K (3840×2160)	3840	2160	29.97			✓	✓	✓	
4K (3840×2160)	3840	2160	30			✓	✓	✓	
4K (3840×2160)	3840	2160	50		✓				
4K (3840×2160)	3840	2160	59.94		✓				
4K (3840×2160)	3840	2160	60		✓				
4K (4096×2160) (SMPTE)	4096	2160	23.98			✓	✓	✓	
4K (4096×2160) (SMPTE)	4096	2160	24			✓	✓	✓	
4K (4096×2160) (SMPTE)	4096	2160	50		✓				

Mode	Resolution (dot)		Refresh Rate (Hz)	Computer	HDMI/HDBaseT				
					RGB HV	YCbCr(8bit)			RGB (8bit)
						4:2:0	4:2:2	4:4:4	
4K (4096×2160) (SMPTE)	4096	2160	59.94		✓				
4K (4096×2160) (SMPTE)	4096	2160	60		✓				

Product name	EB-L735U/EB-L730U/EB-L720U/EB-L635SU/EB-L630SU/EB-L630U/EB-L530U/EB-L520U
Dimensions	440 (W) × 122 (H) × 304 (D) mm (not including raised section)
LCD panel size	0.67"
Display method	Poly-silicon TFT active matrix
Resolution	2,304,000 pixels WUXGA (1,920 (W) × 1,200 (H) dots) × 3
Focus adjustment	Manual
Zoom adjustment	<b>EB-L735U/EB-L730U/EB-L720U/EB-L630U/EB-L530U/EB-L520U:</b> 1.0 to 1.6 (Optical Zoom) <b>EB-L635SU/EB-L630SU:</b> 1.0 to 1.35 (Digital zoom)
Lens Shift	<b>EB-L735U/EB-L730U/EB-L635SU/EB-L630SU/EB-L630U/EB-L530U:</b> Manual Maximum vertical direction: Approx. ±50% Maximum horizontal direction: Approx. ±20%
Light source	Laser diode
Light source output power	<b>EB-L735U/EB-L730U/EB-L720U/EB-L635SU/EB-L630SU/EB-L630U:</b> Up to 115.5 W <b>EB-L530U/EB-L520U:</b> Up to 44 W
Wavelength	449 to 461 nm
Laser class	Class 4
Light source operation time *	Normal or Quiet Light Source Mode: Up to about 20,000 hours Extended Light Source Mode: Up to about 30,000 hours
Max. audio output	10 W
Speaker	1

Power supply	<b>EB-L735U/EB-L730U/EB-L720U/EB-L635SU/EB-L630SU/EB-L630U:</b> 100-240V AC±10% 50/60Hz 3.6 - 1.6 A <b>EB-L530U/EB-L520U:</b> 100-240V AC±10% 50/60Hz 3.1 - 1.4 A
Operating power consumption (100 to 120 V area)	<b>EB-L735U/EB-L730U/EB-L720U/EB-L635SU/EB-L630SU/EB-L630U:</b> 358 W <b>EB-L530U/EB-L520U:</b> 301 W
Operating power consumption (220 to 240 V area)	<b>EB-L735U/EB-L730U/EB-L720U/EB-L635SU/EB-L630SU/EB-L630U:</b> 345 W <b>EB-L530U/EB-L520U:</b> 293 W
Standby power consumption	Communication On: 2.0 W Communication Off: 0.3 W
Operating altitude	Altitude 0 to 3,048 m
Operating temperature (when using a single projector installation) **	Altitude of 0 to 2,286 m: 0 to +45°C (Humidity of 20 to 80%, No condensation) Altitude of 2,287 to 3,048 m: 0 to +40°C (Humidity of 20 to 80%, No condensation)
Operating temperature (when using a multiple projector installation) **	Altitude of 0 to 2,286 m: 0 to +40°C (Humidity of 20 to 80%, No condensation) Altitude of 2,287 to 3,048 m: 0 to +35°C (Humidity of 20 to 80%, No condensation)
Storage temperature	-10 to +60°C (No condensation)

Mass	<b>EB-L735U/EB-L730U/EB-L635SU/EB-L630SU/EB-L630U:</b> Approx. 8.4kg
	<b>EB-L720U:</b> Approx. 7.8kg
	<b>EB-L530U:</b> Approx. 8.2kg
	<b>EB-L520U:</b> Approx. 7.7kg

\* Approximate time until the light source brightness decreases to half of its original value. (Assuming the projector is being used in an environment containing airborne particles of 0.04 to 0.2 mg/m3. This is an approximate guide only and may change depending on the projector's usage and surroundings.)

\*\* Light source brightness automatically dims if the surrounding temperature gets too high. (Approximately 35°C at an altitude of 0 to 2,286 m, and approximately 30°C at an altitude of 2,287 to 3,048 m; however, this may vary depending on the surrounding environment.)

This product is also designed for IT power distribution system with phase-to-phase voltage 230V.

» **Related Links**

- "Connector Specifications" [p.255](#)

HDMI1 port	1	HDMI (Audio is only supported by PCM)
HDMI2 port	1	HDMI (Audio is only supported by PCM)
HDMI Out port (EB-L735U/EB-L730U/EB-L635SU/ EB-L630SU/EB-L630U/EB-L530U)	1	HDMI
USB-A port	1	USB connector (Type A)
DC Out port (for power supply) (EB-L735U/EB-L730U/EB-L635SU/ EB-L630SU/EB-L630U/EB-L530U)	1	USB connector (Type A)
Service port	1	USB connector (Type B)
LAN port	1	RJ-45
HDBaseT port	1	RJ-45
RS-232C port	1	Mini D-Sub 9-pin (male)



- USB-A and USB-B port supports USB 2.0. However, USB ports are not guaranteed to operate all devices that support USB.
- USB-B port does not support USB 1.1.

## Connector Specifications

Computer1 port	1	Mini D-Sub15-pin (female)
Computer2/Monitor Out port	1	Mini D-Sub15-pin (female)
Audio1 port	1	Stereo mini pin jack
Audio2 port	1	Stereo mini pin jack
Audio Out port	1	Stereo mini pin jack

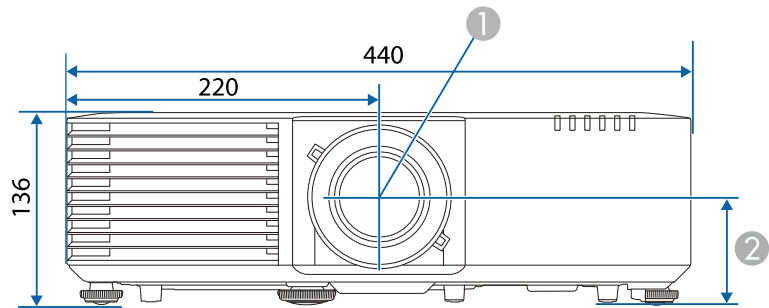

The unit in these illustrations is mm.

- ① Center of lens
- ② Distance from center of lens to suspension bracket fixing point: 74 mm
- ③ EB-L735U/EB-L730U/EB-L720U/EB-L630U/EB-L530U/EB-L520U: 339 mm  
EB-L635SU/EB-L630SU: 334 mm

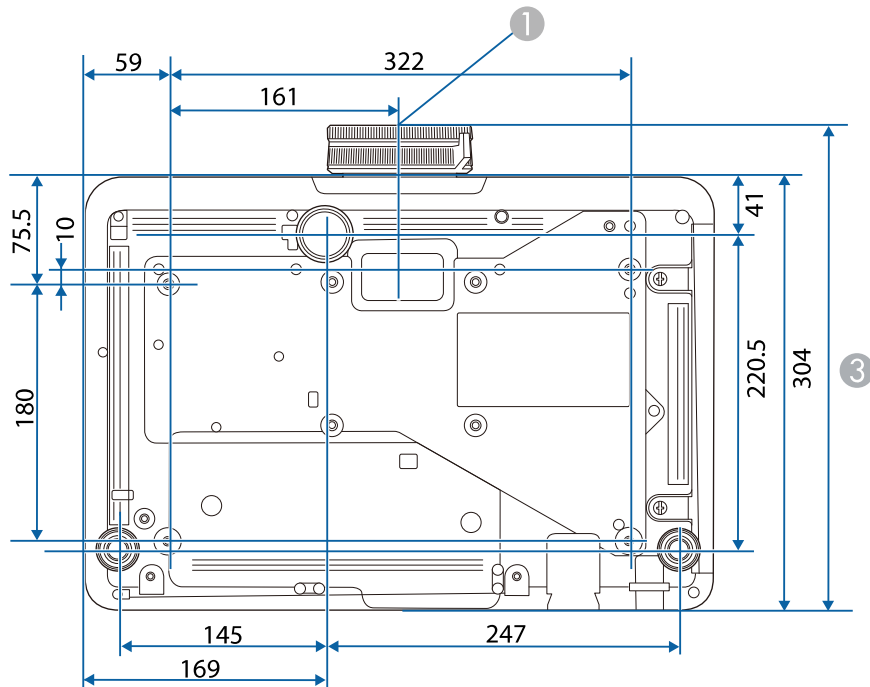



Your projector supports the following features and options of the Epson Projector Content Manager software.

Features/Options		EB-L735U/EB-L730U/EB-L720U/EB-L635SU/EB-L630SU/EB-L630U/EB-L530U/EB-L520U
Simultaneous playback		-
Save the playlist to the projector via a network		✓
<b>Settings &gt; Video Format</b>	Auto Select	✓
	AVI Format	✓
	MP4 Format	✓

Your projector supports the following features and options for the Epson Projector Professional Tool software.



















- The Epson Projector Professional Tool software does not support multiple projector connected in a chain using **HDMI Out Setting** in the projector's **Multi-Projection** menu and the HDMI Out ports.
- If you change the **Screen Type** and **Screen Position** settings, the **Geometry Correction** settings are reset.
- If you want to turn on the projector through the HDBaseT transmitter, set the **A/V Output** setting to **Always On** in the projector's **Signal I/O** menu.









Features/Options		EB-L735U/EB-L730U/EB-L720U/EB-L635SU/EB-L630SU/EB-L630U/EB-L530U/EB-L520U	
<b>Camera Assist</b> features		-	
<b>Layout/Monitoring</b> tab	<b>Input Voltage</b>	-	
<b>Setting</b> tab	<b>Lens Control</b> tab		
	<b>Initial Setting &gt; Basic 3</b> tab	<b>Startup (Shutter)/Standby (Shutter)</b>	-
		<b>Fade-in (seconds)/Fade-out (seconds)</b>	-
		<b>Shutter Timer</b>	You can set this as the projector's <b>A/V Mute Timer</b> setting.
		<b>Standby Confirmation</b>	-

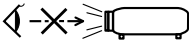

Features/Options		EB-L735U/EB-L730U/EB-L720U/EB-L635SU/EB-L630SU/EB-L630U/EB-L530U/EB-L520U	
		<b>Reset All Config</b>	The following settings are also reset: <ul style="list-style-type: none"> <li>• <b>Color Uniformity</b></li> <li>• <b>Color Matching</b></li> </ul>
		<b>Reset Screen Matching</b>	Only the following settings are reset: <ul style="list-style-type: none"> <li>• <b>Color Uniformity</b></li> <li>• <b>Color Matching</b></li> </ul>
	<b>Geometry Correction</b> tab	<b>Curved Surface</b>	-
		<b>Corner Wall</b>	-
		Marker display when dragging and dropping a point	-
		Adjustments outside the projection area	-
		An absolute coordinate value and a relative coordinate value	✓
	General menu	<b>Geometry Correction File</b>	-
		<b>Projector File</b>	-

The following table lists the meaning of the safety symbols labeled on the equipment.

No.	Symbol mark	Approved standards	Description
1		IEC60417 No. 5007	"ON" (power) To indicate connection to the mains.
2		IEC60417 No. 5008	"OFF" (power) To indicate disconnection from the mains.
3		IEC60417 No. 5009	Stand-by To identify the switch or switch position by means of which part of the equipment is switched on in order to bring it into the stand-by condition.
4		ISO7000 No. 0434B, IEC3864-B3.1	Caution To identify general caution when using the product.
5		IEC60417 No. 5041	Caution, hot surface To indicate that the marked item can be hot and should not be touched without taking care.
6		IEC60417 No. 6042 ISO3864-B3.6	Caution, risk of electric shock To identify equipment that has risk of electric shock.
7		IEC60417 No. 5957	For indoor use only To identify electrical equipment designed primarily for indoor use.
8		IEC60417 No. 5926	Polarity of d.c. power connector To identify the positive and negative connections (the polarity) on a piece of equipment to which a d.c. power supply may be connected.

No.	Symbol mark	Approved standards	Description
9		—	The same as No. 8.
10		IEC60417 No. 5001B	Battery, general On battery powered equipment. To identify a device for instance a cover for the battery compartment, or the connector terminals.
11		IEC60417 No. 5002	Positioning of cell To identify the battery holder itself and to identify the positioning of the cell(s) inside the battery holder.
12		—	The same as No. 11.
13		IEC60417 No. 5019	Protective earth To identify any terminal which is intended for connection to an external conductor for protection against electric shock in case of a fault, or the terminal of a protective earth electrode.
14		IEC60417 No. 5017	Earth To identify an earth (ground) terminal in cases where neither the symbol No. 13 is explicitly required.
15		IEC60417 No. 5032	Alternating current To indicate on the rating plate that the equipment is suitable for alternating current only; to identify relevant terminals.
16		IEC60417 No. 5031	Direct current To indicate on the rating plate that the equipment is suitable for direct current only; to identify relevant terminals.

No.	Symbol mark	Approved standards	Description
17		IEC60417 No. 5172	Class II equipment To identify equipment meeting the safety requirements specified for Class II equipment according to IEC 61140.
18		ISO 3864	General prohibition To identify actions or operations that are prohibited.
19		ISO 3864	Contact prohibition To indicate injury that could occur due to touching a specific part of the equipment.
20		—	Never look into the optical lens while the projector is on.
21		—	To indicate that the marked item don't place anything on projector.
22		ISO3864 IEC60825-1	Caution, laser radiation To indicate the equipment has a laser radiation part.
23		ISO 3864	Disassembly prohibition To indicate a risk of injury, such as electric shock, if the equipment is disassembled.
24		IEC60417 No. 5266	Standby, partial standby To indicate that part of the equipment is in the ready status.
25		ISO3864 IEC60417 No. 5057	Caution, movable parts To indicate that you must keep away from movable parts according to protection standards.
26		IEC60417 No. 6056	Caution (Moving Fan Blades) As a safety precaution, stay away from the moving fan blades.

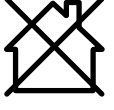
No.	Symbol mark	Approved standards	Description
27		IEC60417 No. 6043	Caution (Sharp Corners) To indicate sharp corners that should not be touched.
28		—	To indicate that looking into the lens while projecting is prohibited.
29		ISO7010 No. W027 ISO 3864	Warning, Optical radiation (such as UV, visible radiation, IR) Taking care to avoid injury to eyes and skin when in the vicinity of optical radiation.
30		IEC60417 No. 5109	Not to be used in residential areas. To identify electrical equipment which is not suitable for a residential area.

This projector is a Class 1 laser product that complies with the IEC/EN60825-1:2014 international standard for lasers.

Follow these safety instructions when using the projector.

## Warning

- Do not open the projector's case. The projector contains a high-powered laser.
- Possibly hazardous optical radiation emitted from this product. Do not look at operating light source. Eye injury may result.

## Caution

Do not disassemble the projector when disposing of it. Dispose according to your local or national laws and regulations.



The projector uses a laser as the light source. The laser has the following characteristics.

- Depending on the surroundings, the brightness of the light source may decline. The brightness declines a lot when the temperature gets too high.
- The brightness of the light source declines the longer it is used. You can change the relationship between usage time and decline in brightness settings.

### Related Links

- "Laser Warning Labels" [p.261](#)

## Laser Warning Labels

Laser warning labels are attached on the projector.

### Inside



### Top

As with any bright source, do not stare into the beam, RG2 IEC/EN 62471-5:2015.

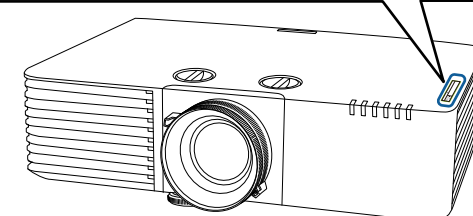
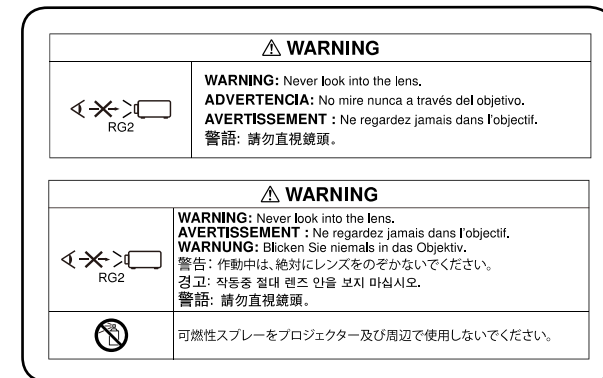

- Never look into the projector lens when the laser is on. This can damage your eyes and is especially dangerous for children and pets.
- When turning on the projector at a distance using the remote control, make sure no one is looking into the lens.
- Do not allow small children to operate the projector. Children must be accompanied by an adult.
- Do not look into the lens during projection. Also, do not look into the lens using optical devices, such as a magnifying glass or telescope. This could cause visual impairment.

## For North/South America

### **Warning**

MOUNT ABOVE THE HEADS OF CHILDREN. The use of a ceiling mount is recommended with this product to place it above the eyes of children.

Complies with FDA performance standards for laser products except for conformance as a Risk Group 2 LIP as defined in IEC 62471-5: Ed. 1.0. For more information see Laser Notice No. 57, dated May 8, 2019.

This section briefly explains the difficult terms that are not explained in the text of this guide. For details, refer to other commercially available publications.

AMX Device Discovery	AMX Device Discovery is a technology developed by AMX to facilitate AMX control systems for easy operation of the target equipment. Epson have implemented this protocol technology, and have provided a setting to enable the protocol function (ON). See the AMX Web site for more details. URL <a href="http://www.amx.com/">http://www.amx.com/</a>
Aspect Ratio	The ratio between an image's length and its height. Screens with a horizontal:vertical ratio of 16:9, such as HDTV screens, are known as wide screens. SDTV and general computer displays have an aspect ratio of 4:3.
Contrast	The relative brightness of the light and dark areas of an image can be increased or decreased to make text and graphics stand out more clearly, or to make them appear softer. Adjusting this particular property of an image is called contrast adjustment.
DHCP	An abbreviation of Dynamic Host Configuration Protocol, this protocol automatically assigns an IP address to equipment connected to a network.
DICOM	An acronym for Digital Imaging and Communications in Medicine. An international standard that defines image standards and a communications protocol for medical images.
Gateway Address	This is a server (router) for communicating across a network (subnet) divided according to subnet mask.

HDCP	HDCP is an abbreviation for High-bandwidth Digital Content Protection. It is used to prevent illegal copying and protect copyrights by encrypting digital signals sent over DVI and HDMI ports. Because the HDMI port on this projector supports HDCP, it can project digital images protected by HDCP technology. However, the projector may not be able to project images protected with updated or revised versions of HDCP encryption.
HDMI™	An abbreviation for High Definition Multimedia Interface. HDMI™ is a standard aimed at digital consumer electronics and computers. This is the standard by which HD images and multichannel audio signals are digitally transmitted. By not compressing the digital signal, the image can be transferred at the highest quality possible. It also provides an encryption function for the digital signal.
HDTV	An abbreviation for High-Definition Television that refers to high-definition systems which satisfy the following conditions: <ul style="list-style-type: none"> <li>• Vertical resolution of 720p or 1080i or greater (p = Progressive, i = Interlace)</li> <li>• Screen aspect ratio of 16:9</li> </ul>
Infrastructure mode	A method for wireless LAN connection in which devices communicate through access points.
Interlace	Transmits information needed to create one screen by sending every other line, starting from the top of the image and working down to the bottom. Images are more likely to flicker because one frame is displayed every other line.
IP Address	A number to identify a computer connected to a network.
Progressive	Projects information to create one screen at a time, displaying the image for one frame. Even though the number of scan lines is the same, the amount of flicker in images decreases because the volume of information has doubled compared with an interlace system.

Refresh Rate	<p>The light-emitting element of a display maintains the same luminosity and color for an extremely short time.</p> <p>Because of this, the image must be scanned many times per second to refresh the light-emitting element.</p> <p>The number of refresh operations per second is called the Refresh rate and is expressed in hertz (Hz).</p>
SDTV	An abbreviation for Standard Definition Television that refers to standard television systems which do not satisfy the conditions for HDTV High-Definition Television.
SNMP	An abbreviation for Simple Network Management Protocol, which is the protocol for monitoring and controlling devices such as routers and computers connected to a TCP/IP network.
sRGB	An international standard for color intervals that was formulated so that colors that are reproduced by video equipment can be handled easily by computer operating systems (OS) and the Internet. If the connected source has an sRGB mode, set both the projector and the connected signal source to sRGB.
SSID	SSID is identification data for connecting to another device on a wireless LAN. Wireless communication is possible between devices with the same SSID.
Subnet Mask	This is a numerical value that defines the number of bits used for the network address on a divided network (subnet) from the IP address.
SVGA	A screen size standard with a resolution of 800 (horizontal) × 600 (vertical) dots.
SXGA	A screen size standard with a resolution of 1,280 (horizontal) × 1,024 (vertical) dots.
Sync.	<p>The signals output from computers have a specific frequency.</p> <p>If the projector frequency does not match this frequency, the resulting images are not of a good quality.</p> <p>The process of matching the phases of these signals (the relative position of the crests and the troughs in the signal) is called Synchronization.</p> <p>If the signals are not synchronized, flickering, blurriness, and horizontal interference occur.</p>

Tracking	<p>The signals output from computers have a specific frequency.</p> <p>If the projector frequency does not match this frequency, the resulting images are not of a good quality.</p> <p>The process of matching the frequency of these signals (the number of crests in the signal) is called Tracking.</p> <p>If Tracking is not carried out correctly, wide vertical stripes appear in the signal.</p>
Trap IP Address	This is the IP address for the destination computer used for error notification in SNMP.
VGA	A screen size standard with a resolution of 640 (horizontal) × 480 (vertical) dots.
XGA	A screen size standard with a resolution of 1,024 (horizontal) × 768 (vertical) dots.
WXGA	A screen size standard with a resolution of 1,280 (horizontal) × 800 (vertical) dots.
WUXGA	A screen size standard with a resolution of 1,920 (horizontal) × 1,200 (vertical) dots.



Check these sections for important notices about your projector.

► **Related Links**

- "FCC Compliance Statement" [p.265](#)
- "Indication of the manufacturer and the importer in accordance with requirements of EU directive" [p.266](#)
- "Restriction of Use" [p.266](#)
- "Operating System References" [p.266](#)
- "Trademarks" [p.266](#)
- "Copyright Notice" [p.267](#)
- "Copyright Attribution" [p.267](#)

## FCC Compliance Statement

**Supplier's DECLARATION of CONFORMITY**

According to 47CFR, Part 2 and 15

Class B Personal Computers and Peripherals; and/or

CPU Boards and Power Supplies used with Class B Personal Computers

We: Epson America, Inc.

Located at: 3131 Katella Avenue, Los Alamitos, CA

Tel: 562-981-3840

Declare under sole responsibility that the product identified herein, complies with 47CFR Part 2 and 15 of the FCC rules as a Class B digital device. Each product marketed, is identical to the representative unit tested and found to be compliant with the standards. Records maintained continue to reflect the equipment being produced can be expected to be within the variation accepted, due to quantity production and testing on a statistical basis as required by 47CFR 2.906. Operation is subject to the following two conditions: (1) this device may not cause harmful interference, and (2) this device must accept any interference received, including interference that may cause undesired operation.

Trade Name: EPSON

Type of Product: LCD Projector

Model: HA25B/HA26B/HA27B/HA28B/HA29B/HA30B/HA44B

### FCC Compliance Statement For United States Users

This device complies with part 15 of the FCC Rules. Operation is subject to the following two conditions: (1) This device may not cause harmful interference, and (2) this device must accept any interference received, including interference that may cause undesired operation.

This equipment has been tested and found to comply with the limits for a Class B digital device, pursuant to Part 15 of the FCC Rules. These limits are designed to provide reasonable protection against harmful interference in a residential installation. This equipment generates, uses, and can radiate radio frequency energy and, if not installed and used in accordance with the instructions, may cause harmful interference to radio communications. However, there is no guarantee that interference will not occur in a particular installation. If this equipment does cause interference to radio and television reception, which can be determined by turning the equipment off and on, the user is encouraged to try to correct the interference by one or more of the following measures.

- Reorient or relocate the receiving antenna.
- Increase the separation between the equipment and receiver.
- Connect the equipment into an outlet on a circuit different from that to which the receiver is connected.
- Consult the dealer or an experienced radio/TV technician for help.

### WARNING

The connection of a non-shielded equipment interface cable to this equipment will invalidate the FCC Certification or Declaration of this device and may cause interference levels which exceed the limits established by the FCC for this equipment. It is the responsibility of the user to obtain and use a shielded equipment interface cable with this device. If this equipment has more than one interface connector, do not leave cables connected to unused interfaces. Changes or modifications not expressly approved by the manufacturer could void the user's authority to operate the equipment.

### Statement for Canadian EMC Rules

CAN ICES-3 (B) / NMB-3 (B)

## Indication of the manufacturer and the importer in accordance with requirements of EU directive

Manufacturer: SEIKO EPSON CORPORATION  
 Address: 3-5, Owa 3-chome, Suwa-shi, Nagano-ken 392-8502 Japan  
 Telephone: 81-266-52-3131  
<http://www.epson.com/>

Importer: EPSON EUROPE B.V.  
 Address: Atlas Arena, Asia Building, Hoogoorddreef 5,1101 BA Amsterdam  
 Zuidoost  
 The Netherlands  
 Telephone: 31-20-314-5000  
<http://www.epson.eu/>

## Restriction of Use

When this product is used for applications requiring high reliability/safety such as transportation devices related to aviation, rail, marine, automotive etc.; disaster prevention devices; various safety devices etc; or functional/precision devices etc, you should use this product only after giving consideration to including fail-safes and redundancies into your design to maintain safety and total system reliability. Because this product was not intended for use in applications requiring extremely high reliability/safety such as aerospace equipment, main communication equipment, nuclear power control equipment, or medical equipment related to direct medical care etc, please make your own judgment on this product's suitability after a full evaluation.

## Operating System References

- Microsoft® Windows® 7 operating system

- Microsoft® Windows® 8.1 operating system
- Microsoft® Windows® 10 operating system

In this guide, the operating systems above are referred to as "Windows 7", "Windows 8.1", and "Windows 10". Furthermore, the collective term "Windows" is used to refer to them all.

- OS X 10.11.x
- macOS 10.12.x
- macOS 10.13.x
- macOS 10.14.x
- macOS 10.15.x

In this guide, the operating systems above are referred to as "OS X 10.11.x", "macOS 10.12.x", "macOS 10.13.x", "macOS 10.14.x", and "macOS 10.15.x". Furthermore, the collective term "Mac" is used to refer to them all.

## Trademarks

EPSON is a registered trademark, EXCEED YOUR VISION and its logos are registered trademarks or trademarks of Seiko Epson Corporation.

Mac, OS X, and macOS are trademarks of Apple Inc.

Microsoft, Windows, and Windows Server are trademarks or registered trademarks of Microsoft Corporation in the United States and/or other countries.

Wi-Fi®, WPA2®, WPA3®, and Miracast® are trademarks of Wi-Fi Alliance®.

App Store is a service mark of Apple Inc.

Chrome, Chromebook, and Google Play are trademarks of Google LLC.

HDMI, the HDMI Logo and High-Definition Multimedia Interface are trademarks or registered trademarks of HDMI Licensing Administrator, Inc.



"QR Code" is a registered trademark of DENSO WAVE INCORPORATED.

PJLink trademark is a trademark applied for registration or is already registered in Japan, the United States of America and other countries and areas.

Crestron®, Crestron Connected®, Crestron Fusion®, Crestron Control®, and Crestron RoomView® are registered trademarks of Crestron Electronics, Inc.

Intel® is a registered trademark of Intel Corporation in the U.S. and/or other countries.

Extron® and XTP® are registered trademarks of RGB Systems. Incorporated.

HDBaseT™ and the HDBaseT Alliance logo are trademarks of the HDBaseT Alliance.

Android TV™ is a trademark of Google LLC.

Other product names used herein are also for identification purposes only and may be trademarks of their respective owners. Epson disclaims any and all rights in those marks.

The contents of this guide may be changed or updated without further notice. Illustrations in this guide and the actual projector may differ.

---

## Copyright Attribution

This information is subject to change without notice.

© 2021 Seiko Epson Corporation

2021.02 414103300EN

---

## Copyright Notice

All rights reserved. No part of this publication may be reproduced, stored in a retrieval system, or transmitted in any form or by any means, electronic, mechanical, photocopying, recording, or otherwise, without the prior written permission of Seiko Epson Corporation. No patent liability is assumed with respect to the use of the information contained herein. Neither is any liability assumed for damages resulting from the use of the information contained herein.

Neither Seiko Epson Corporation nor its affiliates shall be liable to the purchaser of this product or third parties for damages, losses, costs, or expenses incurred by the purchaser or third parties as a result of: accident, misuse, or abuse of this product or unauthorized modifications, repairs, or alterations to this product, or (excluding the U.S.) failure to strictly comply with Seiko Epson Corporation's operating and maintenance instructions.

Seiko Epson Corporation shall not be liable against any damages or problems arising from the use of any options or any consumable products other than those designated as Original Epson Products or Epson Approved Products by Seiko Epson Corporation.

## Free Manuals Download Website

<http://myh66.com>

<http://usermanuals.us>

<http://www.somanuals.com>

<http://www.4manuals.cc>

<http://www.manual-lib.com>

<http://www.404manual.com>

<http://www.luxmanual.com>

<http://aubethermostatmanual.com>

Golf course search by state

<http://golfingnear.com>

Email search by domain

<http://emailbydomain.com>

Auto manuals search

<http://auto.somanuals.com>

TV manuals search

<http://tv.somanuals.com>