



User's Guide

Multimedia Projector

VS260	EB-992F	EB-W51
EB-FH06	EB-982W	EB-X51
EB-W06	EB-972	EB-E10
EB-X06	EB-118	EB-E20
EB-E01	EB-W49	EB-FH52
EB-X500	EB-X49	EB-W52

IMPORTANT: Before using this product, make sure you read the safety instructions in the online *Notices*.

For information on contacting Epson, see the online *Notices*.

Notations Used in This Guide 7

Using the Manual to Search for Information 8

- Searching by Keyword 8
- Jumping Directly from Bookmarks..... 8
- Printing Only the Pages You Need..... 8

Getting the Latest Version of the Documents 9

List of Functions 10

Introduction to Your Projector 14

Projector Features..... 15

- Quick and Easy Setup 15
- Easy Wireless Projection 15

Projector Parts and Functions 17

- Projector Parts - Front..... 17
- Projector Parts - Rear..... 18
- Projector Parts - Base 19
- Projector Parts - Control Panel 20
- Projector Parts - Remote Control 21

Setting Up the Projector 23

Projector Placement 24

- Projector Setup and Installation Options..... 25
- Projection Distance..... 25

Projector Connections 27

- Connecting to a Computer..... 27
 - Connecting to a Computer for VGA Video and Audio 27
 - Connecting to a Computer for USB Video and Audio..... 28
 - Connecting to a Computer for HDMI Video and Audio 29

- Connecting to Video Sources 29
 - Connecting to an HDMI Video Source 30
 - Connecting to a Composite Video Source..... 30
- Connecting to External USB Devices 31
 - USB Device Projection 31
 - Connecting to a USB Device 31
 - Disconnecting a USB Device 32
- Connecting to a Document Camera 32
- Connecting to External Devices..... 32
 - Connecting to a VGA Monitor 32
 - Connecting to External Speakers 33
 - Connecting a Microphone 34

Installing Batteries in the Remote Control 35

Remote Control Operation 36

Opening the Lens Cover 37

Using Basic Projector Features 38

Turning On the Projector 39

- Home Screen..... 40

Turning Off the Projector 42

Setting the Date and Time 43

Selecting the Language for the Projector Menus 45

Projection Modes 46

- Changing the Projection Mode Using the Remote Control..... 46
- Changing the Projection Mode Using the Menus 46

Displaying a Test Pattern 48

Adjusting the Image Height..... 49

Image Shape 50

- Auto V-Keystone 50
- Correcting the Image Shape with the Horizontal Keystone Slider..... 50

- Correcting the Image Shape with the Keystone Buttons 51
- Correcting the Image Shape with Quick Corner 52
- Resizing the Image with the Zoom Ring 54**
- Focusing the Image Using the Focus Ring..... 55**
- Selecting an Image Source 56**
- Image Aspect Ratio 58**
 - Changing the Image Aspect Ratio 58
 - Available Image Aspect Ratios 58
 - Projected Image Appearance with Each Aspect Mode 59
- Adjusting Image Quality (Color Mode) 61**
 - Changing the Color Mode 61
 - Available Color Modes..... 61
 - Setting Auto Iris 61
- Controlling the Volume with the Volume Buttons 63**

Adjusting Projector Features 64

- Projecting Two Images Simultaneously 65**
 - Unsupported Input Source Combinations for Split Screen Projection..... 67
 - Split Screen Projection Restrictions..... 67
- Projecting a PC Free Presentation..... 68**
 - Supported PC Free File Types..... 68
 - Precautions on PC Free Projection 68
 - Starting a PC Free Slide Show 69
 - Starting a PC Free Movie Presentation 70
 - PC Free Display Options 71
- Shutting Off the Image and Sound Temporarily 73**
- Stopping Video Action Temporarily 74**
- Zooming In/Zooming Out of Images (E-Zoom) 75**
 - Zooming Into Images 75
 - Zooming Out of Images..... 75

- Saving a User's Logo Image 77**
- Saving a User Pattern 78**
- Color Difference Correction when Projecting from Multiple Projectors 79**
 - Setting the Projector ID 79
 - Selecting the Projector You want to Operate 79
 - Matching Multiple-Projector Display Quality 80
- Projector Security Features..... 82**
 - Password Security Types 82
 - Setting a Password..... 82
 - Selecting Password Security Types..... 83
 - Entering a Password to Use the Projector 84
 - Locking the Projector's Buttons..... 84
 - Unlocking the Projector's Buttons 85
 - Installing a Security Cable..... 85

Using the Projector on a Network 87

- Wired Network Projection..... 88**
 - Connecting to a Wired Network..... 88
 - Selecting Wired Network Settings 88
- Wireless Network Projection..... 91**
 - Installing the Wireless LAN Module 91
 - Selecting Wireless Network Settings Manually..... 92
 - Selecting Wireless Network Settings in Windows 94
 - Selecting Wireless Network Settings in Mac..... 95
 - Setting Up Wireless Network Security..... 95
 - Supported Client and CA Certificates 97
 - Using a QR Code to Connect a Mobile Device..... 97
 - Using a USB Key to Connect a Windows Computer 98
- Wireless Network Projection from a Mobile Device (Screen Mirroring)..... 99**

- Selecting Screen Mirroring Settings..... 99
- Connecting Using Screen Mirroring with the Miracast Function..... 101
 - Connecting Using Screen Mirroring in Windows 10 101
 - Connecting Using Screen Mirroring in Windows 8.1 102
- Secure HTTP..... 104**
 - Importing a Web Server Certificate Using the Menus 104
 - Supported Web Server Certificates 105

Monitoring and Controlling the Projector 106

- Epson Projector Management 107**
- Controlling a Networked Projector Using a Web Browser 108**
 - Web Control Options..... 109
- Registering Digital Certificates from a Web Browser..... 112**
- Setting Up Projector Network E-Mail Alerts 113**
 - Network Projector E-mail Alert Messages 113
- Setting Up Monitoring Using SNMP..... 115**
- Using ESC/VP21 Commands 116**
 - ESC/VP21 Command List 116
 - Cable Layouts..... 116
- PJLink Support 118**
- Crestron Connected Support 119**
 - Setting Up Crestron Connected Support..... 119
 - Controlling a Networked Projector Using Crestron Connected 119
 - Crestron Connected Operation Window 121
 - Crestron Connected Tools Window 122

Setting Projector Event Schedules 124

Adjusting the Menu Settings 127

- Using the Projector's Menus 128**

- Using the Displayed Keyboard 129**
 - Available Text Using the Displayed Keyboard..... 129
- Image Quality Settings - Image Menu 130**
- Input Signal Settings - Signal Menu..... 131**
- Projector Feature Settings - Settings Menu 132**
- Projector Setup Settings - Extended Menu 134**
- Projector Network Settings - Network Menu..... 137**
 - Network Menu - Screen Mirroring Settings..... 138
 - Network Menu - Basic Menu 139
 - Network Menu - Wireless LAN Menu 140
 - Network Menu - Wired LAN Menu..... 143
 - Network Menu - Notifications Menu..... 144
 - Network Menu - Others Menu 145
 - Network Menu - Reset Menu..... 146

Projector Setup Settings - ECO Menu 147

- Projector Information Display - Info Menu 149**
 - Info Menu - Projector Info Menu 149
 - Event ID Code List..... 150

Projector Reset Options - Reset Menu 152

- Copying Menu Settings Between Projectors (Batch Setup) 153**
 - Transferring Settings From a USB Flash Drive 153
 - Transferring Settings From a Computer 154
 - Batch Setup Error Notification 155

Maintaining the Projector 156

- Projector Maintenance 157**
- Cleaning the Lens..... 158**
- Cleaning the Projector Case..... 159**
- Air Filter and Vent Maintenance 160**

Cleaning the Air Filter and Vents	160
Replacing the Air Filter	160
Projector Lamp Maintenance	163
Replacing the Lamp	163
Resetting the Lamp Timer	166

Solving Problems 167

Projection Problems	168
Projector Indicator Status	169
Using the Projector Help Displays.....	172
Solving Image or Sound Problems.....	173
Solutions When No Image Appears.....	173
Solutions When Image is Incorrect Using the USB Display Function	173
Solutions When "No Signal" Message Appears.....	174
Displaying From a Laptop.....	174
Displaying From a Mac Laptop.....	174
Solutions When "Not Supported" Message Appears	174
Solutions When Only a Partial Image Appears.....	175
Solutions When the Image is not Rectangular.....	175
Solutions When the Image Contains Noise or Static.....	175
Solutions When the Image is Fuzzy or Blurry	176
Solutions When the Image Brightness or Colors are Incorrect	176
Solutions to Sound Problems.....	177
Solutions When Image File Names are not Displayed Correctly in PC Free.....	177
Solving Projector or Remote Control Operation Problems	178
Solutions to Projector Power or Shut-Off Problems.....	178
Solutions to Problems with the Remote Control.....	178
Solutions to Password Problems.....	179
Solution When "The Battery that Saves Your Clock Settings is Running Low" Message Appears	179
Solving Network Problems	180

Solutions When Wireless Authentication Fails	180
Solutions When You Cannot Access the Projector Through the Web	180
Solutions When Network Alert E-Mails are not Received.....	180
Solutions When the Image Contains Static During Network Projection.....	181
Solutions When You Cannot Connect Using Screen Mirroring.....	181
Solutions When the Image or Sound Contains Static During Screen Mirroring Connection	181

Appendix 183

Optional Accessories and Replacement Parts.....	184
Screens	184
Cables	184
Mounts	184
For Wireless Connection	184
External Devices	185
Replacement Parts.....	185
Screen Size and Projection Distance.....	186
Supported Monitor Display Resolutions	192
Projector Specifications	194
Connector Specifications	198
External Dimensions	199
USB Display System Requirements	203
List of Safety Symbols and Instructions	204
Glossary	206
Notices	208
FCC Compliance Statement.....	208
Indication of the manufacturer and the importer in accordance with requirements of EU directive.....	209
Restriction of Use	209
Operating System References.....	209
Trademarks.....	209



Copyright Notice..... 210
Copyright Attribution..... 210

Notations Used in This Guide





Safety Symbols

The projector and its manuals use graphical symbols and labels to indicate content that tells you how to use the projector safely.

Read and carefully follow the instructions that are marked with these symbols and labels to avoid injury to persons or damage to property.

 Warning	This symbol indicates information that, if ignored, could possibly result in personal injury or even death.
 Caution	This symbol indicates information that, if ignored, could possibly result in personal injury or physical damage due to incorrect handling.

General Information Notations

Attention	This label indicates procedures that may result in damage or injury if sufficient care is not taken.
	This label indicates additional information that may be useful to know.
[Button name]	Indicates the name of the buttons on the remote control or the projector. Example: [Esc] button
Menu/Setting name	Indicates projector menu and setting names. Example: Select the Image menu  Image > Advanced
	This label indicates links to the related pages.
	This label indicates the projector's current menu level.

» Related Links

- "Using the Manual to Search for Information" [p.8](#)
- "Getting the Latest Version of the Documents" [p.9](#)

The PDF manual allows you to search for information you are looking for by keyword, or jump directly to specific sections using the bookmarks. You can also print only the pages you need. This section explains how to use a PDF manual that has been opened in Adobe Reader X on your computer.

► Related Links

- "Searching by Keyword" p.8
- "Jumping Directly from Bookmarks" p.8
- "Printing Only the Pages You Need" p.8

- Mac OS: Hold down the command key, and then press ←.

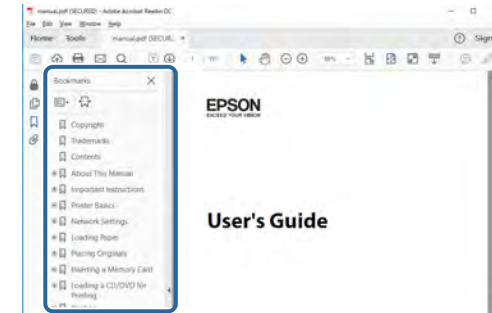

Searching by Keyword

Click **Edit > Advanced Search**. Enter the keyword (text) for information you want to find in the search window, and then click **Search**. Hits are displayed as a list. Click one of the displayed hits to jump to that page.

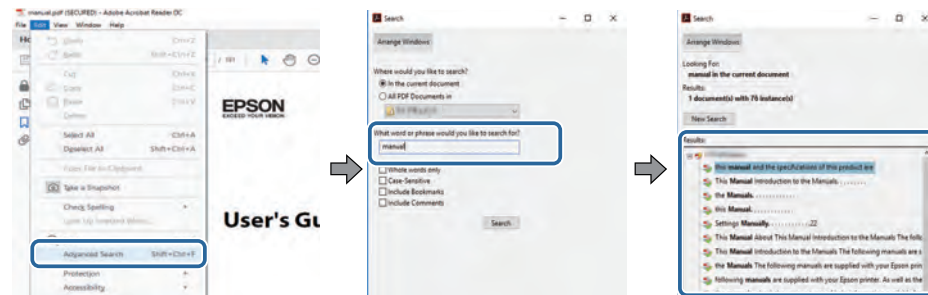

Printing Only the Pages You Need

You can extract and print only the pages you need. Click **Print** in the **File** menu, and then specify the pages you want to print in **Pages in Pages to Print**.

- To specify a series of pages, enter a hyphen between the start page and the end page.
Example: 20-25
- To specify pages that are not in series, divide the pages with commas.
Example: 5, 10, 15

Jumping Directly from Bookmarks

Click a title to jump to that page. Click + or > to view the lower level titles in that section. To return to the previous page, perform the following operation on your keyboard.

- Windows: Hold down **Alt**, and then press ←.

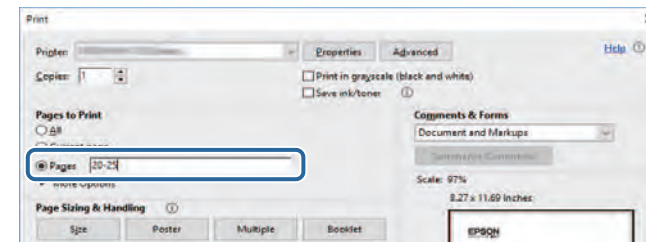

You can get the latest version of the manuals and specifications on the Epson Web site.

Visit [epson.com/support](https://www.epson.com/support), and enter your projector's name.

	EB-992F	EB-982W	EB-W49	EB-FH52	EB-W52	EB-W51	EB-FH06	EB-W06
Beep (Power on/Power off)	✓	✓	✓	✓	✓	✓	✓	✓
Date & Time setting	✓	-	-	✓	-	-	-	-
Schedule Settings	✓	-	-	✓	-	-	-	-
Auto V-Keystone	✓	✓	✓	✓	✓	✓	✓	✓
PC Free	✓	✓	✓	✓	✓	✓	✓	✓
Power Consumption (3 levels)	✓	✓	✓	-	-	-	-	-
Power Consumption (2 levels)	-	-	-	✓	✓	✓	✓	✓
Batch Setup (USB flash drive)	✓	✓	✓	✓	✓	✓	✓	✓
Batch Setup (USB cable)	✓	✓	✓	✓	✓	✓	✓	✓
User's Logo Protection	✓	✓	✓	✓	✓	✓	✓	✓
Network Protection	✓	✓	✓	✓	✓	✓	✓	✓
Schedule Protection	✓	-	-	✓	-	-	-	-
Screen Mirroring Protection	✓	-	-	✓	-	-	-	-
Epson iProjection	✓	✓	✓	✓	✓	✓	✓	✓
Epson Projector Management	✓	✓	✓	✓	✓	✓	✓	✓
Epson Web Control	✓	✓	✓	✓	✓	✓	✓	✓
Mail Notification	✓	✓	✓	✓	✓	✓	✓	✓
SNMP	✓	✓	✓	✓	✓	✓	✓	✓
Secure HTTP (HTTPS)	✓	-	-	✓	-	-	-	-
ESC/VP21 Commands	✓	✓	✓	✓	✓	✓	✓	✓
PJLink	✓	✓	✓	-	-	-	-	-
Crestron Connected	✓	✓	✓	-	-	-	-	-

EB-972/EB-118/EB-X49/EB-E20/EB-X51/EB-E10/EB-X06/EB-E01/EB-X500/VS260

The following table lists the functions supported by each projector model. Supported functions are indicated by a "✓" mark.

	EB-972	EB-118	EB-X49	EB-E20	EB-X51	EB-E10	EB-X06	EB-E01	EB-X500	VS260
Auto V-Keystone	✓	✓	✓	-	✓	-	✓	-	✓	-
PC Free	✓	✓	✓	-	✓	-	✓	-	✓	-
Power Consumption (3 levels)	✓	✓	-	-	-	-	-	-	-	-
Power Consumption (2 levels)	-	-	✓	✓	✓	✓	✓	✓	✓	✓
Batch Setup (USB flash drive)	✓	✓	✓	-	✓	-	✓	-	✓	-
Batch Setup (USB cable)	✓	✓	✓	✓	✓	✓	✓	✓	✓	✓
User's Logo Protection	✓	✓	✓	✓	✓	✓	✓	✓	✓	✓
Network Protection	✓	✓	✓	-	✓	-	✓	-	✓	-
Schedule Protection	-	-	-	-	-	-	-	-	-	-
Screen Mirroring Protection	-	-	-	-	-	-	-	-	-	-
Epson iProjection	✓	✓	✓	-	✓	-	✓	-	✓	-
Epson Projector Management	✓	✓	✓	-	✓	-	✓	-	✓	-
Epson Web Control	✓	✓	✓	-	✓	-	✓	-	✓	-
Mail Notification	✓	✓	✓	-	✓	-	✓	-	✓	-
SNMP	✓	✓	✓	-	✓	-	✓	-	✓	-
Secure HTTP (HTTPS)	-	-	-	-	-	-	-	-	-	-
ESC/VP21 Commands	✓	✓	✓	-	✓	-	✓	-	✓	-
PJLink	✓	✓	✓	-	-	-	-	-	-	-
Crestron Connected	✓	✓	✓	-	-	-	-	-	-	-

Introduction to Your Projector

Refer to these sections to learn more about your projector's features and part names.

► **Related Links**

- "Projector Features" [p.15](#)
- "Projector Parts and Functions" [p.17](#)

This projector comes with these special features. Refer to these sections for more details.

► Related Links

- "Quick and Easy Setup" [p.15](#)
- "Easy Wireless Projection" [p.15](#)

Quick and Easy Setup

- Direct Power On feature to turn on the projector as soon as you plug it in.
- Auto Power On feature to turn on the projector when the projector detects an image signal from the port you specified as the **Auto Power On** source.
- Home screen feature to easily select an input source and useful functions.
- Automatic vertical keystone correction always displays a rectangular screen (Auto V-Keystone).
- Horizontal keystone slider allows you to quickly correct horizontal distortion in the projected image.

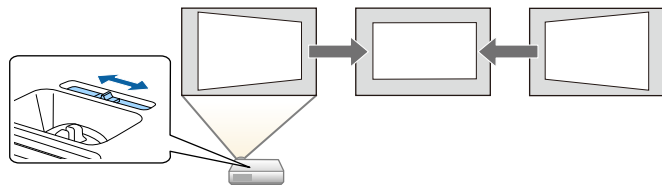

► Related Links

- "Auto V-Keystone" [p.50](#)
- "Projector Setup Settings - Extended Menu" [p.134](#)
- "List of Functions" [p.10](#)
- "Turning On the Projector" [p.39](#)
- "Correcting the Image Shape with the Horizontal Keystone Slider" [p.50](#)

Easy Wireless Projection

- Screen Mirroring to connect your projector and mobile device wirelessly using Miracast technology.



- Epson iProjection (Windows/Mac) to project up to four images at the same time by splitting the projected screen. You can project images from computers on the network, or from smartphones or tablet devices. See the *Epson iProjection Operation Guide (Windows/Mac)* for details.

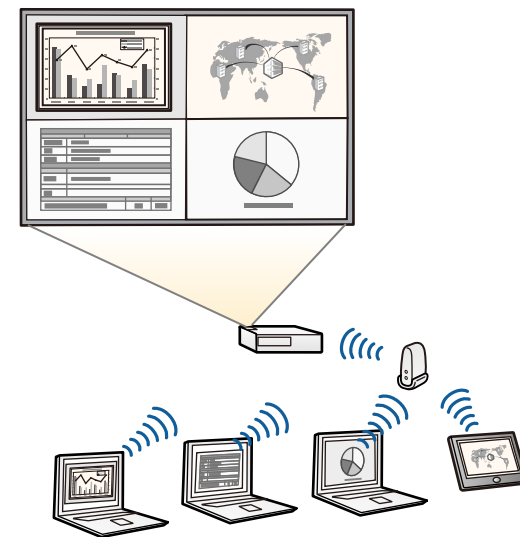



- You can download the necessary software and manuals from the following Web site:
<http://www.epson.com/support>

- Epson iProjection (iOS/Android) to connect your projector and mobile device wirelessly using the app available on the App Store or Google Play.



Any fees incurred when communicating with the App Store or Google Play are the responsibility of the customer.

- Epson iProjection (Chromebook) to connect your projector and Chromebook device wirelessly using the app available on the Chrome Web Store.



Any fees incurred when communicating with the Chrome Web Store are the responsibility of the customer.

» Related Links

- "List of Functions" [p.10](#)
- "Using the Projector on a Network" [p.87](#)

The following sections explain the projector parts and their functions.

All of the features in this guide are explained using illustrations of EB-992F unless otherwise mentioned.

► **Related Links**

- "Projector Parts - Front" [p.17](#)
- "Projector Parts - Rear" [p.18](#)
- "Projector Parts - Base" [p.19](#)
- "Projector Parts - Control Panel" [p.20](#)
- "Projector Parts - Remote Control" [p.21](#)
- "List of Functions" [p.10](#)

Projector Parts - Front

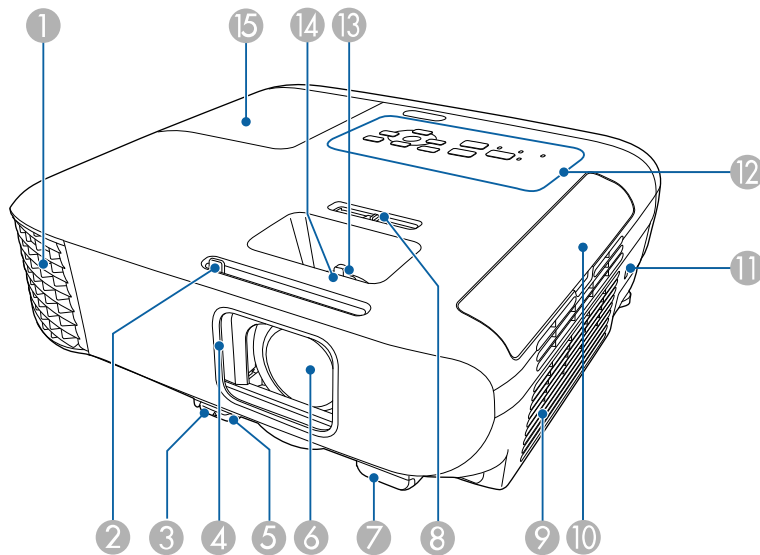

Name	Function
1 Air exhaust vent	Exhaust vent for air used to cool the projector internally.

Name	Function
	<p>Warning</p> <p>Do not look into the vents. If the lamp explodes, gases may escape and small fragments of glass may be scattered which could cause an injury. Contact a doctor if any fragments of broken glass are inhaled or get into the eyes or mouth.</p> <p>Caution</p> <p>While projecting, do not put your face or hands near the air exhaust vent, and do not place objects that may become warped or damaged by heat near the vent. Hot air from the air exhaust vent could cause burns, warping, or accidents to occur.</p>
2 A/V Mute slide lever	Slide the knob to open and close the lens cover.
3 Foot release lever	Press the foot release lever to extend and retract the front adjustable foot.
4 Lens cover	Close when not using the projector to protect the lens. By closing it during projection you can hide the image and the sound.
5 Front adjustable foot	When the projector is set up on a surface such as a desk, extend the foot to adjust the position of the image.
6 Lens	Images are projected from here.
7 Remote receiver	Receives signals from the remote control.
8 Horizontal keystone slider	Corrects horizontal distortion in the projected image.
9 Air intake vent (air filter)	Takes in air to cool the projector internally.
10 Air filter cover	Open to access the air filter.

Name	Function
① Security slot	The security slot is compatible with the Microsaver Security System manufactured by Kensington.
⑫ Control panel	Operates the projector.
⑬ Zoom ring	Adjusts the image size.
⑭ Focus ring	Adjusts the image focus. The shape may vary depending on the model of your projector.
⑮ Lamp cover	Open to access the projector's lamp.

» **Related Links**

- "Projector Indicator Status" [p.169](#)
- "List of Functions" [p.10](#)
- "Resizing the Image with the Zoom Ring" [p.54](#)
- "Focusing the Image Using the Focus Ring" [p.55](#)
- "Correcting the Image Shape with the Horizontal Keystone Slider" [p.50](#)

EB-E01/VS260

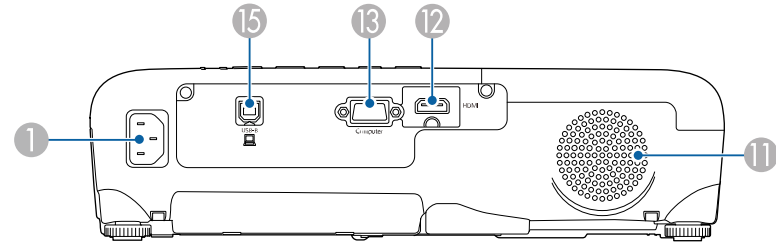

Name	Function
① Power inlet	Connects the power cord to the projector.
② RS-232C port	Connects an RS-232C cable to control the projector from a computer. (You do not need to use this port normally.)
③ Video port	Inputs composite video signals from video sources.
④ Mic port	Inputs audio from the microphone.
⑤ L-Audio-R ports	Inputs audio from equipment connected to the Video port.
⑥ Monitor Out port	Outputs analog RGB signals input from the Computer1 port to an external monitor. You cannot output signals input from other ports.
⑦ Audio 1 port	Inputs audio from equipment connected to the Computer1 port.
⑧ Audio Out port	Outputs audio from the current input source or Mic port to an external speaker.
⑨ Audio 2 port	Inputs audio from equipment connected to the Computer2 port.
⑩ Computer2 port	Inputs image signals from a computer.
⑪ Speaker	Outputs audio.
⑫ HDMI1, HDMI2 ports HDMI port	Inputs video signals from HDMI compatible video equipment and computers. This projector is compatible with HDCP.

Projector Parts - Rear

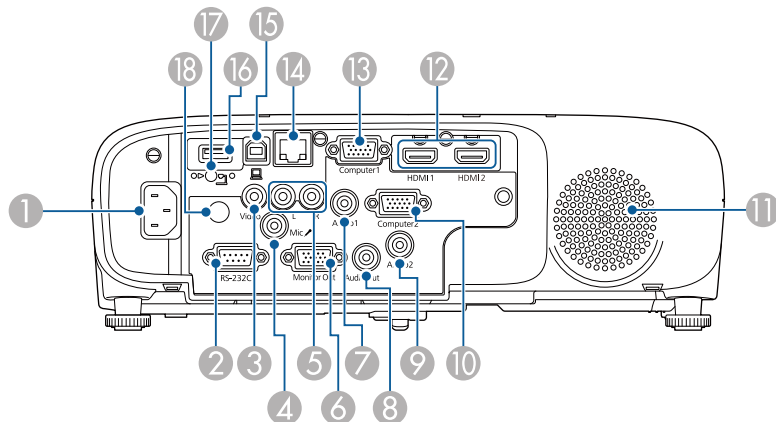

Name	Function
⑬ Computer port Computer1 port	Inputs image signals from a computer.
⑭ LAN port	Connects a LAN cable to connect to a network.
⑮ USB-B port	Connects a USB cable to the computer to project computer images.
⑯ USB-A port	Connects a USB memory device or a digital camera and projects movies or images using PC Free. Connects the optional document camera. Connects the wireless LAN module.
⑰ Wireless LAN module fixing screw	Secures the wireless LAN module cover.
⑱ Remote receiver	Receives signals from the remote control.

» **Related Links**

- "List of Functions" [p.10](#)

Projector Parts - Base

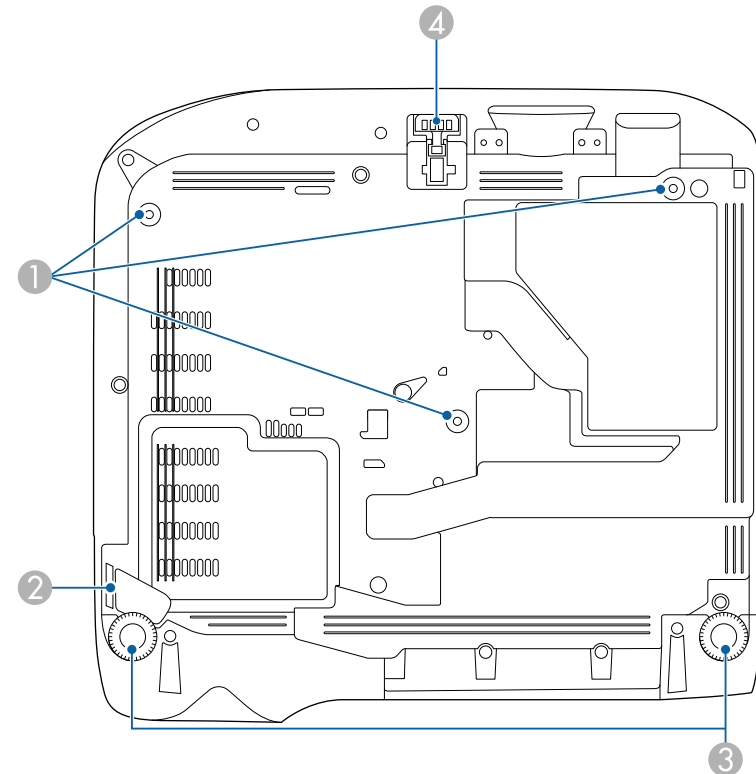

Name	Function
① Ceiling mount fixing points (three points)	Attach the optional ceiling mount here when suspending the projector from a ceiling.
② Security cable attachment point	Pass a commercially available wire lock through here and lock it in place. You can also attach the optional safety wire here to prevent the projector from falling from the ceiling or wall.

Name	Function
③ Rear feet	When the projector is set up on a surface such as a desk, turn to extend and retract the feet to adjust the horizontal tilt.
④ Front adjustable foot	When the projector is set up on a surface such as a desk, extend the foot to adjust the position of the image.

» **Related Links**

- "Installing a Security Cable" [p.85](#)

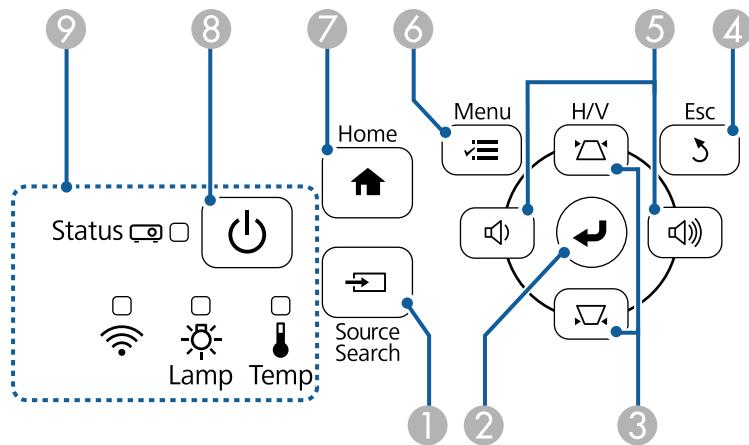

Projector Parts - Control Panel

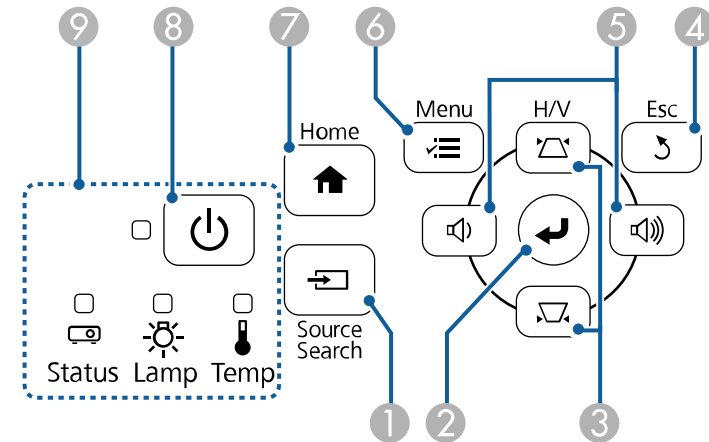

EB-E20/EB-E10/EB-E01/VS260



Name	Function
① [Source Search] button	Switches to the next input source.
② [Enter] button [↵]	Enters the current selection and moves to the next level while displaying the projector's menu or help. Optimizes Tracking , Sync. , and Position in the projector's Signal menu while projecting an analog RGB signal from the Computer port.
③ Keystone adjustment buttons and arrow buttons	Displays the Keystone screen allowing you to correct keystone distortion. Selects menu items while displaying the projector's menu or help.
④ [Esc] button	Stops the current function. Moves back to the previous menu level while displaying the projector's menu.



Name	Function
5	Volume buttons and arrow buttons  : Decreases the volume.  : Increases the volume. Corrects keystone distortion in the horizontal direction when the Keystone screen is displayed. Selects menu items while displaying the projector's menu or help.
6	[Menu] button Displays and closes the projector's menu.
7	[Home] button Displays and closes the Home screen.
8	Power button [] Turns the projector on or off.
9	Indicators Indicates the projector's status.

» **Related Links**

- "Input Signal Settings - Signal Menu" [p.131](#)
- "Home Screen" [p.40](#)
- "Projector Indicator Status" [p.169](#)
- "Correcting the Image Shape with the Keystone Buttons" [p.51](#)

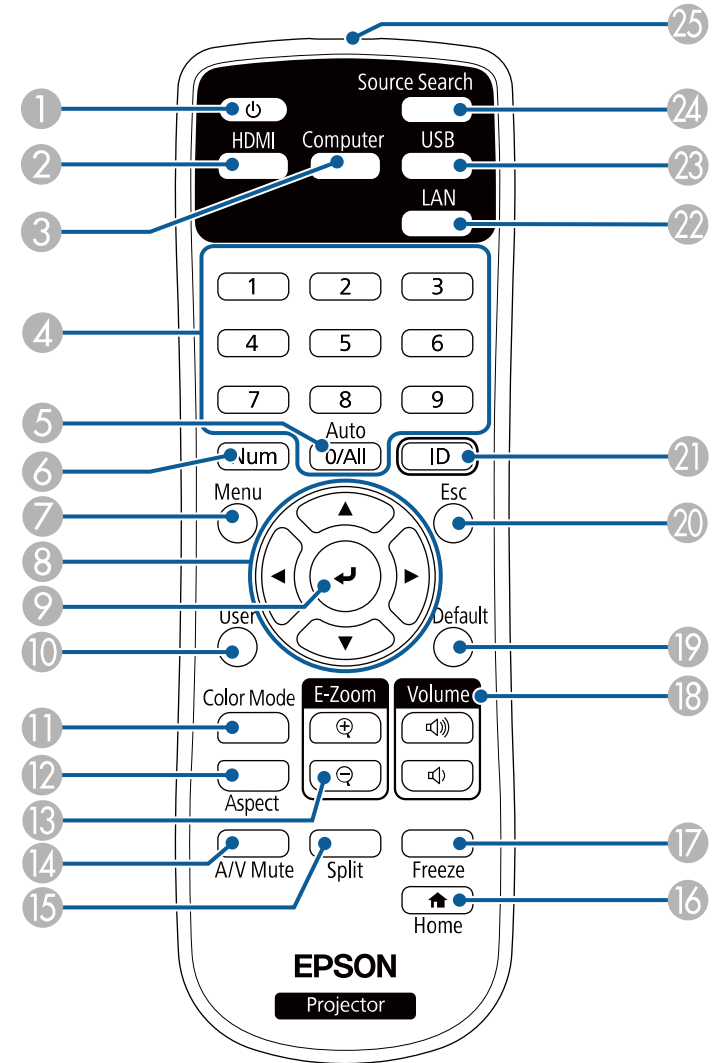
Projector Parts - Remote Control



Name	Function
① Power button []	Turns the projector on or off.
② [HDMI] button	Switches the image source between the HDMI ports.
③ [Computer] button	Switches the image source to the Computer ports.
④ Numeric buttons	Enters numbers in the projector's menu while holding down the [Num] button.
⑤ [Auto] button	Optimizes Tracking , Sync. , and Position in the projector's Signal menu while projecting an analog RGB signal from the Computer ports.
⑥ [Num] button	Hold down this button to enter numbers using the numeric buttons.
⑦ [Menu] button	Displays and closes the projector's menu.
⑧ Arrow buttons	Selects menu items while displaying the projector's menu.
⑨ [Enter] button []	Enters the current selection and moves to the next level while displaying the projector's menu.
⑩ [User] button	Performs settings assigned in the User Button setting in the projector's Settings menu.
⑪ [Color Mode] button	Changes the color mode.
⑫ [Aspect] button	Changes the aspect mode.
⑬ [E-Zoom] +/- buttons	Resizes the projected image.
⑭ [A/V Mute] button	Turns the video and audio on or off temporarily.
⑮ [Split] button	Projects two images from different image sources simultaneously by splitting the projected screen.
⑯ [Home] button	Displays and closes the Home screen.
⑰ [Freeze] button	Pauses or resumes images.
⑱ [Volume] up/down buttons	Adjusts the speaker volume.
⑲ [Default] button	Returns the selected setting to its default value.

Name	Function
⑳ [Esc] button	Stops the current function. Moves back to the previous menu level while displaying the projector's menu.
㉑ [ID] button	Hold down this button and press the numeric buttons to select the ID for the projector you want to operate using the remote control.
㉒ [LAN] button	Switches the image source between the network connected devices.
㉓ [USB] button	Switches the image source between the USB Display and USB-A port.
㉔ [Source Search] button	Switches to the next input source.
㉕ Remote control light emitting area	Outputs remote control signals.

► Related Links

- "Image Aspect Ratio" [p.58](#)
- "Adjusting Image Quality (Color Mode)" [p.61](#)
- "Input Signal Settings - Signal Menu" [p.131](#)
- "Projector Setup Settings - Extended Menu" [p.134](#)
- "Home Screen" [p.40](#)
- "Projecting Two Images Simultaneously" [p.65](#)
- "Connecting to a Computer for USB Video and Audio" [p.28](#)
- "Projecting a PC Free Presentation" [p.68](#)
- "Using the Projector on a Network" [p.87](#)

Setting Up the Projector

Follow the instructions in these sections to set up your projector.

► Related Links

- "Projector Placement" [p.24](#)
- "Projector Connections" [p.27](#)
- "Installing Batteries in the Remote Control" [p.35](#)
- "Remote Control Operation" [p.36](#)
- "Opening the Lens Cover" [p.37](#)

You can place the projector on almost any flat surface to project an image.

You can also install the projector in a ceiling mount if you want to use it in a fixed location. An optional ceiling mount is required when suspending the projector from a ceiling.

Note the following points when selecting a projector location:

- Place the projector on a sturdy, level surface or install it using a compatible mount.

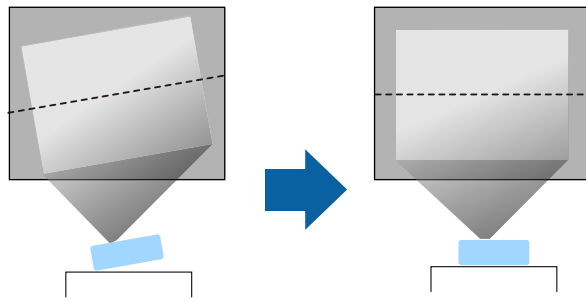

- Leave plenty of space around and under the projector for ventilation, and do not place it on top of or next to anything that could block the vents.
- Place the projector so it squarely faces the screen, not at an angle.

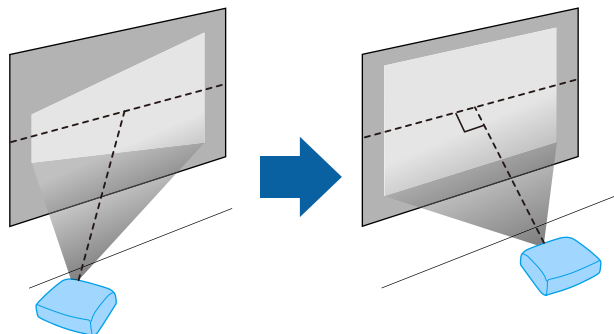

If you cannot install the projector squarely facing the screen, correct any resulting keystone distortion using the projector controls. For the best quality images, we recommend adjusting the installation position of the projector to achieve the correct image size and shape.

Warning

- You must install a ceiling mount when suspending the projector from a ceiling. If you do not install the projector correctly, it could fall and cause damage or injury.
- Do not use adhesives on the ceiling mount fixing points to prevent the screws from loosening, or use lubricants, oils, or similar substances on the projector; the projector case may crack causing it to fall from its ceiling mount. This could cause serious injury to anyone under the ceiling mount and could damage the projector.
- Failure to install the ceiling mount and projector may cause the projector to fall. After installing the specific Epson mount that supports your projector, make sure you secure the mount to all of the projector's ceiling mount fixing points. Also, secure the projector and the mounts using wire that is strong enough to hold their weight.
- Do not install the projector in a location subject to high levels of dust or humidity, or in a location subject to smoke or steam. Otherwise, it could cause a fire or electric shock to occur. The projector's case could also deteriorate and be damaged causing the projector to fall from the mount.

Examples of environments that could cause the projector to fall due to case deterioration

- Locations subject to excessive smoke or airborne oil particles, such as factories or kitchens
- Locations containing volatile solvents or chemicals, such as factories or laboratories
- Locations where the projector could be subjected to detergents or chemicals, such as factories or kitchens
- Locations in which aroma oils are often used, such as relaxation rooms
- Near devices that produce excessive smoke, airborne oil particles, or foam at events

⚠ Warning

- Do not cover the projector's air intake or air exhaust vents. If the vents are covered, the internal temperature could rise and cause a fire.
- Do not use or store the projector in locations where it will be subject to dust or dirt. Otherwise, the quality of the projected image may decline, or the air filter may become clogged, resulting in a malfunction or fire.
- Do not install the projector on an unstable surface or in a location beyond the weight specifications of the projector. Otherwise, it could fall or topple causing an accident and injury.
- When installing the projector in a high position, take measures to prevent falling by using wires to ensure safety in an emergency, such as an earthquake, and to prevent accidents. If it is not installed correctly, it could fall causing an accident and injury.
- Do not install in locations where salt damage could occur, or in locations subject to corrosive gas such as sulphuric gas from hot springs. Otherwise, corrosion could cause the projector to fall. It could also cause the projector to malfunction.

⚠ Attention

- Do not operate the projector on its side. This may cause the projector to malfunction.
- If you are using the projector at altitudes above 1,500 m, set the **High Altitude Mode** setting to **On** in the projector's menu to ensure the projector's internal temperature is regulated properly.
☛ **Extended > Operation > High Altitude Mode**
- Try not to setup the projector in locations subject to high humidity and dust, or in locations subject to smoke from fires or tobacco smoke.

» Related Links

- "Projector Setup and Installation Options" [p.25](#)
- "Projection Distance" [p.25](#)
- "Image Shape" [p.50](#)
- "Projector Setup Settings - Extended Menu" [p.134](#)

Projector Setup and Installation Options

You can set up or install your projector in the following ways:

Front/Rear

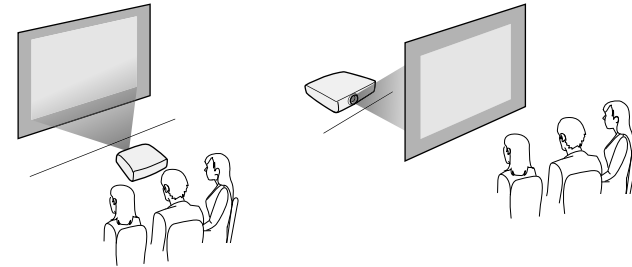

Front Ceiling/Rear Ceiling

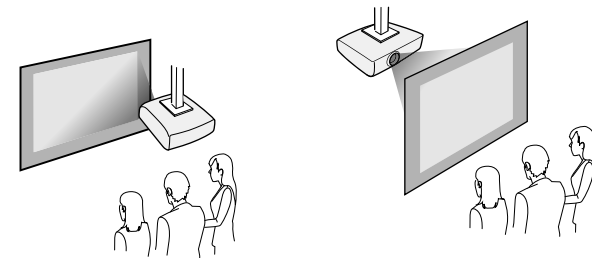

Make sure you select the correct **Projection** option in the projector's **Extended** menu according to the installation method being used.

» Related Links

- "Projection Modes" [p.46](#)

Projection Distance

The distance at which you place the projector from the screen determines the approximate size of the image. The image size increases the farther the

projector is from the screen, but can vary depending on the zoom factor, aspect ratio, and other settings.

See the Appendix for details about how far to place the projector from the screen based on the size of the projected image.



When correcting keystone distortion, your image is slightly smaller.

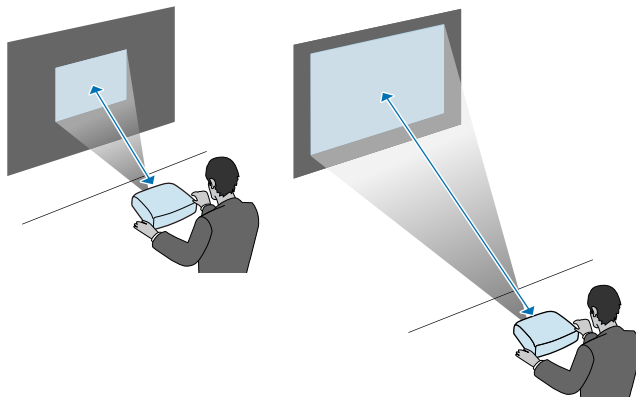

► Related Links

- "Screen Size and Projection Distance" [p.186](#)

See these sections to connect the projector to a variety of projection sources.

Attention

Check the shape and orientation of the connectors on any cable you plan to connect. Do not force a connector into a port if it does not fit. The device or your projector could be damaged or could malfunction.



See the *Quick Start Guide* for a list of cables supplied with your projector. Purchase optional or commercially available cables when necessary.

» Related Links

- "Connecting to a Computer" [p.27](#)
- "Connecting to Video Sources" [p.29](#)
- "Connecting to External USB Devices" [p.31](#)
- "Connecting to a Document Camera" [p.32](#)
- "Connecting to External Devices" [p.32](#)

Connecting to a Computer

Follow the instructions in these sections to connect a computer to the projector.

» Related Links

- "Connecting to a Computer for VGA Video and Audio" [p.27](#)
- "Connecting to a Computer for USB Video and Audio" [p.28](#)
- "Connecting to a Computer for HDMI Video and Audio" [p.29](#)

Connecting to a Computer for VGA Video and Audio

You can connect the projector to your computer using a VGA computer cable.

You can play sound through the projector's speaker system by connecting a commercially available 3.5 mm stereo mini-jack audio cable.



- To connect a computer that does not have a VGA video port, you need an adapter that allows you to connect to the projector's VGA video port.
- You can also set the port used for audio input in the projector's **Extended** menu.
 - **Extended > A/V Settings > Audio Settings > Audio Output**
- Make sure the audio cable is labeled "No resistance".

- 1** Connect the VGA computer cable to your computer's monitor port.
- 2** Connect the other end to a Computer port on the projector.

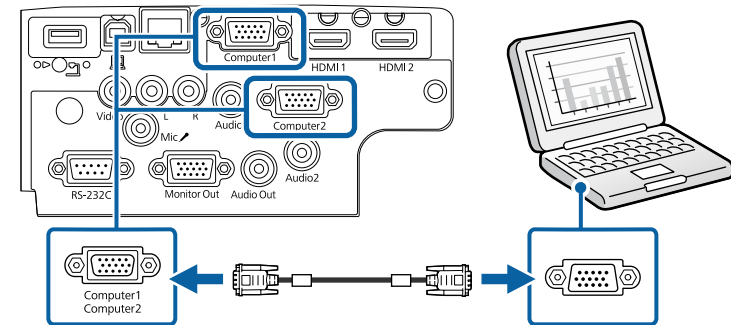

- 3** Tighten the screws on the VGA connector.
- 4** Connect the audio cable to your laptop's headphone or audio-out jack, or your desktop's speaker or audio-out port.

- 5 Connect the other end to the Audio port that corresponds to the Computer port you are using.

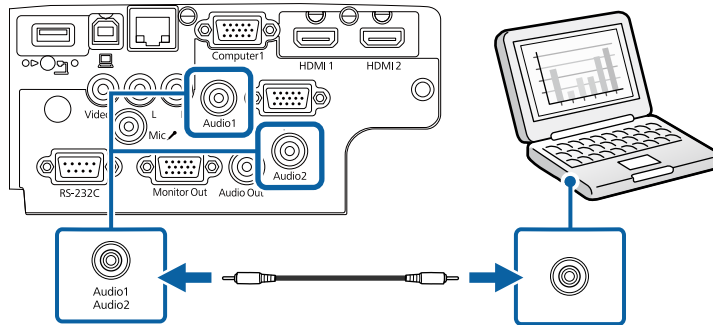

» **Related Links**

- "Projector Setup Settings - Extended Menu" [p.134](#)
- "List of Functions" [p.10](#)

Connecting to a Computer for USB Video and Audio

If your computer meets the system requirements, you can send video and audio output to the projector through the computer's USB port. This function is called USB Display. Connect the projector to your computer using a USB cable.

 • If you use a USB hub, the connection may not operate correctly. Connect the USB cable directly to the projector.

- 1 Connect the cable to your projector's USB-B port.

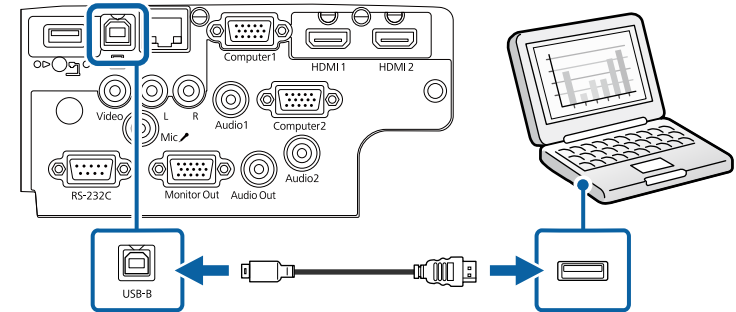

- 2 Connect the other end to any available USB port on your computer.
- 3 Turn on the projector and your computer.
- 4 Do one of the following to install the Epson USB Display software:

 You only need to install this software the first time you connect the projector to the computer.

- Windows: Select **Run EMP_UDSE.EXE** in the dialog box that is displayed to install the Epson USB Display software.
- Mac: The Epson USB Display setup folder is displayed on your screen. Select **USB Display Installer** and follow the on-screen instructions to install the Epson USB Display software. If the USB Display **Setup** folder is not displayed automatically, double-click **EPSON_PJ_UD > USB Display Installer**.

- 5 Follow any on-screen instructions.
Do not disconnect the USB cable or turn off the projector until the projector displays an image.

The projector displays the image from your computer's desktop and outputs sound if your presentation contains audio.



- If the projector does not project any images, do one of the following:
 - Windows: Click **All Programs > EPSON Projector > Epson USB Display > Epson USB Display Ver.x.xx**.
 - Mac: Double-click the **USB Display** icon in the **Application** folder.
- When you finish projection, do one of the following:
 - Windows: Disconnect the USB cable. You do not need to operate **Safely Remove Hardware**.
 - Mac: Select **Disconnect** from the **USB Display** icon menu on the menu bar or **Dock**, and then disconnect the USB cable.

» Related Links

- "USB Display System Requirements" [p.203](#)
- "List of Functions" [p.10](#)

Connecting to a Computer for HDMI Video and Audio

If your computer has an HDMI port, you can connect it to the projector using an HDMI cable and send the computer's audio with the projected image.



To connect a Mac that does not have an HDMI port, you need an adapter that allows you to connect to the projector's HDMI port. Contact Apple for compatible adapter options. Older Mac computers (2009 and earlier) may not support audio through the HDMI port.

- 1** Connect the HDMI cable to your computer's HDMI output port.

- 2** Connect the other end to the projector's HDMI port.

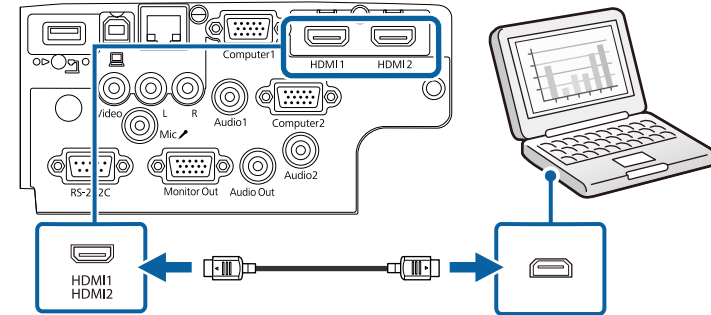

If you have problems hearing audio through the HDMI connection, connect one end of a commercially available 3.5 mm stereo mini-jack audio cable to the projector's Audio port and the other end to your computer's audio out port. Select the audio input port you connected to in the projector's **Extended** menu.

- **Extended > A/V Settings > Audio Settings > HDMI Audio Output**
- **Extended > A/V Settings > Audio Settings > HDMI1 Audio Output**
- **Extended > A/V Settings > Audio Settings > HDMI2 Audio Output**

» Related Links

- "Projector Setup Settings - Extended Menu" [p.134](#)
- "List of Functions" [p.10](#)

Connecting to Video Sources

Follow the instructions in these sections to connect video devices to the projector.



- If the port on the device you connect has an unusual shape, use the cable supplied with the device or an optional cable to connect to the projector.
- The cable differs depending on the output signal from the connected video devices.
- Some video devices are capable of outputting different types of signals. See your video device manual to confirm what type of signals can be output.

► Related Links

- "Connecting to an HDMI Video Source" [p.30](#)
- "Connecting to a Composite Video Source" [p.30](#)

Connecting to an HDMI Video Source

If your video source has an HDMI port, you can connect it to the projector using an HDMI cable and send the image source's audio with the projected image.

Attention

Do not turn on the video source before connecting it to the projector. Doing so could damage the projector.

- 1** Connect the HDMI cable to your video source's HDMI output port.
- 2** Connect the other end to the projector's HDMI port.

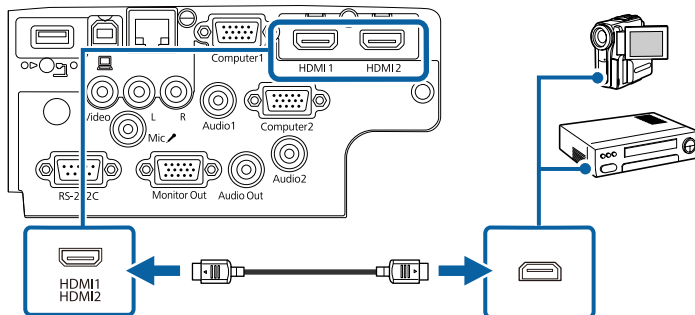

If you have problems hearing audio through the HDMI connection, connect one end of a commercially available 3.5 mm stereo mini-jack audio cable to the projector's Audio port and the other end to your video source's audio out port. Select the audio input port you connected to in the projector's **Extended** menu.

- ☛ **Extended** > A/V Settings > Audio Settings > HDMI Audio Output
- ☛ **Extended** > A/V Settings > Audio Settings > HDMI1 Audio Output
- ☛ **Extended** > A/V Settings > Audio Settings > HDMI2 Audio Output

► Related Links

- "Projector Setup Settings - Extended Menu" [p.134](#)
- "List of Functions" [p.10](#)

Connecting to a Composite Video Source

If your video source has a composite video port, you can connect it to the projector using a RCA-style video or A/V cable.

You can play sound through the projector's speaker system by connecting a commercially available RCA audio cable.



Make sure the audio cable is labeled "No resistance".

- 1** Connect the cable with the yellow connector to your video source's yellow video output port.

2 Connect the other end to the projector's Video port.

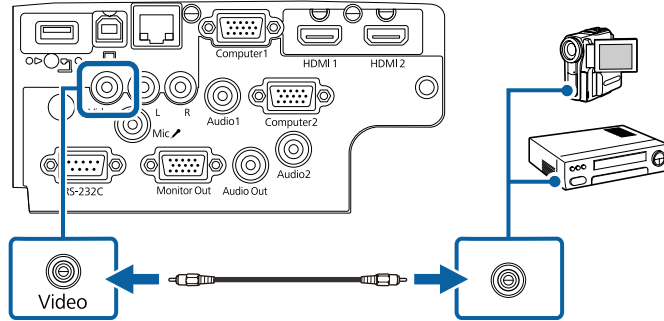

3 Connect the audio cable to your video source's audio-out ports.

4 Connect the other end to the projector's L-Audio-R ports.

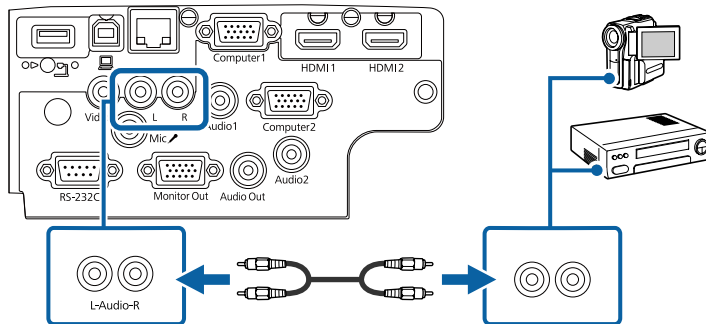

» **Related Links**

- "List of Functions" [p.10](#)

» **Related Links**

- "USB Device Projection" [p.31](#)
- "Connecting to a USB Device" [p.31](#)
- "Disconnecting a USB Device" [p.32](#)

USB Device Projection

You can project images and other content without using a computer or video device by connecting any of these devices to your projector:

- USB flash drive
- Digital camera or smartphone
- USB hard drive



- Digital cameras or smartphones must be USB-mounted devices, not TWAIN-compliant devices, and must be USB Mass Storage Class-compliant.
- USB hard drives must meet these requirements:
 - USB Mass Storage Class-compliant (not all USB Mass Storage Class devices are supported)
 - Formatted in FAT16/32
 - Self-powered by their own AC power supplies (bus-powered hard drives are not recommended)
 - Avoid using hard drives with multiple partitions

You can project slide shows from image files on a connected USB device.

» **Related Links**

- "List of Functions" [p.10](#)
- "Projecting a PC Free Presentation" [p.68](#)

Connecting to a USB Device

You can connect your USB device to the projector's USB-A port and use it to project images and other content.

1 If your USB device came with a power adapter, plug the device into an electrical outlet.

Connecting to External USB Devices

Follow the instructions in these sections to connect external USB devices to the projector.

- 2 Connect the USB cable or USB flash drive to the projector's USB-A port as shown.

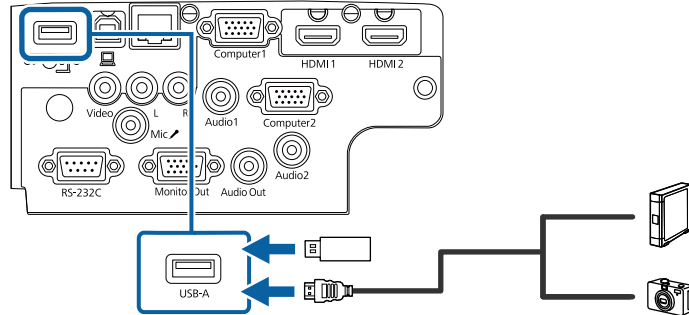

Attention

- Use the USB cable supplied with or specified for use with the device.
- Do not connect a USB hub or a USB cable longer than 3 meters, or the device may not operate correctly.

- 3 Connect the other end to your device, if necessary.

▶ Related Links

- "List of Functions" [p.10](#)

Disconnecting a USB Device

When you have finished presenting with a connected USB device, disconnect the device from the projector.

- 1 Turn off and unplug the device, if necessary.
- 2 Disconnect the USB device from the projector.

Connecting to a Document Camera

You can connect a document camera to your projector to project images viewed by the camera.

The connection method varies depending on your Epson document camera model. See the document camera manual for details.

▶ Related Links

- "List of Functions" [p.10](#)

Connecting to External Devices

Follow the instructions in these sections to connect external devices to the projector.

▶ Related Links

- "Connecting to a VGA Monitor" [p.32](#)
- "Connecting to External Speakers" [p.33](#)
- "Connecting a Microphone" [p.34](#)

Connecting to a VGA Monitor

If you connected the projector to a computer using a Computer port, you can also connect an external monitor to the projector. This lets you see your presentation on the external monitor even when the projected image is not visible.



- If you want to output images to an external monitor when the projector is turned off, select **Always On** as the **A/V Output** setting in the projector's **Extended** menu.
▶ **Extended > A/V Settings > A/V Output**
- Monitors that use a refresh rate of less than 60 Hz may not be able to display images correctly.

- 1 Make sure your computer is connected to the projector's Computer port.



- If there are two computer ports, make sure you use the Computer1 port.
- Only analog RGB signals from the Computer1 port can be output to an external monitor. You cannot output signals input from other ports.

2 Connect the external monitor's cable to your projector's Monitor Out port.

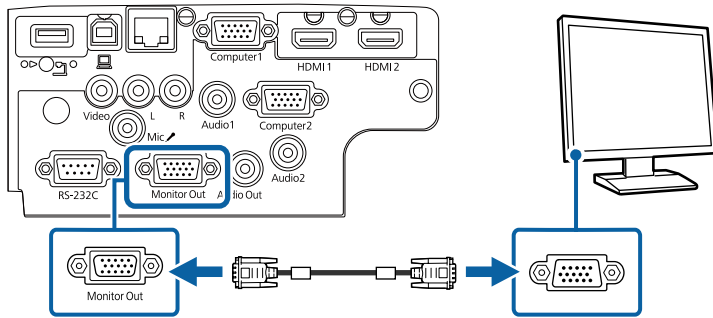

» Related Links

- "Projector Setup Settings - Extended Menu" [p.134](#)
- "List of Functions" [p.10](#)

Connecting to External Speakers

To enhance the sound from your presentation, you can connect the projector to external self-powered speakers. You can control the volume using the projector's remote control.



- If you want to output audio from the external speakers when the projector is turned off, select **Always On** as the **A/V Output** setting in the projector's **Extended** menu.
 ➤ **Extended > A/V Settings > A/V Output**
- You can also connect the projector to an amplifier with speakers.
- The projector's built-in speaker system is disabled when you connect external speakers.

- 1** Make sure your computer or video source is connected to the projector with both audio and video cables as necessary.
- 2** Locate the appropriate cable to connect your external speakers, such as a stereo mini-jack-to-pin-jack cable, or another type of cable or adapter.
- 3** Connect one end of the cable to your external speakers as necessary.
- 4** Connect the stereo mini-jack end of the cable to your projector's Audio Out port.

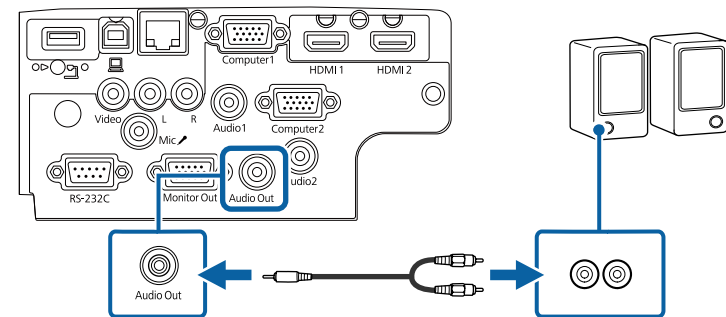

» Related Links

- "Projector Setup Settings - Extended Menu" [p.134](#)
- "List of Functions" [p.10](#)

Connecting a Microphone

You can connect a microphone to the projector's Mic port to provide audio support during presentations.



- Plug-in-power is not supported.
- If you want to output audio from a microphone when the projector is turned off, select **Always On** as the **A/V Output** setting in the projector's **Extended** menu.
 - **Extended > A/V Settings > A/V Output**
- Adjust **Mic Input Level** if the microphone audio is difficult to hear, or if it is too loud resulting in a crackling sound.
 - **Settings > Mic Input Level**

1 Connect the microphone cable to the projector's Mic port.

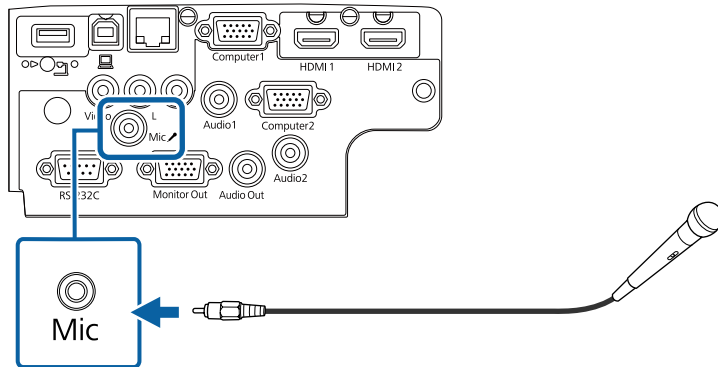

2 Turn on the microphone, if necessary.

» Related Links

- "Projector Setup Settings - Extended Menu" [p.134](#)
- "Projector Feature Settings - Settings Menu" [p.132](#)
- "List of Functions" [p.10](#)

The remote control uses the two AA batteries that came with the projector.

Attention

Make sure you read the safety instructions in the online *Notices* before handling the batteries.

- 1** Remove the battery cover as shown.

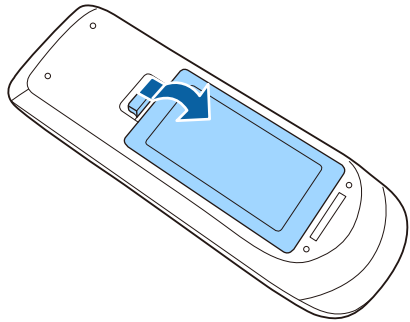

- 2** Remove the old batteries, if necessary.



Dispose of used batteries according to local regulations.

- 3** Insert the batteries with the + and – ends facing as shown.

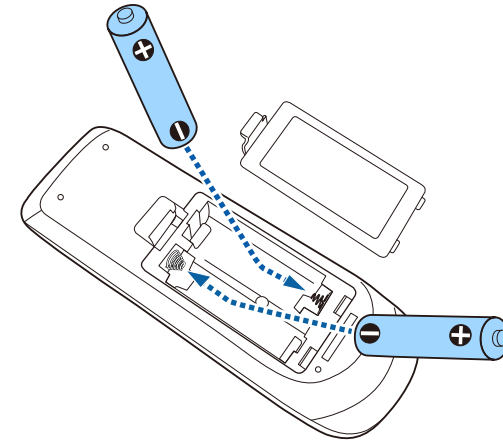

Warning

Check the positions of the (+) and (-) marks inside the battery holder to ensure the batteries are inserted the correct way. If the batteries are not used correctly, they could explode or leak causing a fire, injury, or damage to the product.

- 4** Replace the battery cover and press it down until it clicks into place.

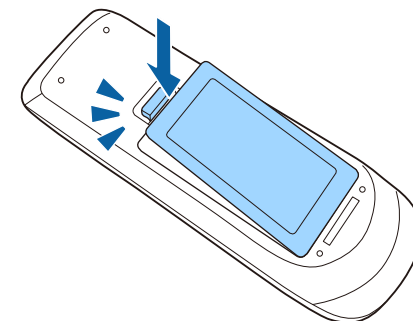

The remote control lets you control the projector from almost anywhere in the room.

Make sure that you aim the remote control at the projector's receivers within the distance and angles listed here.

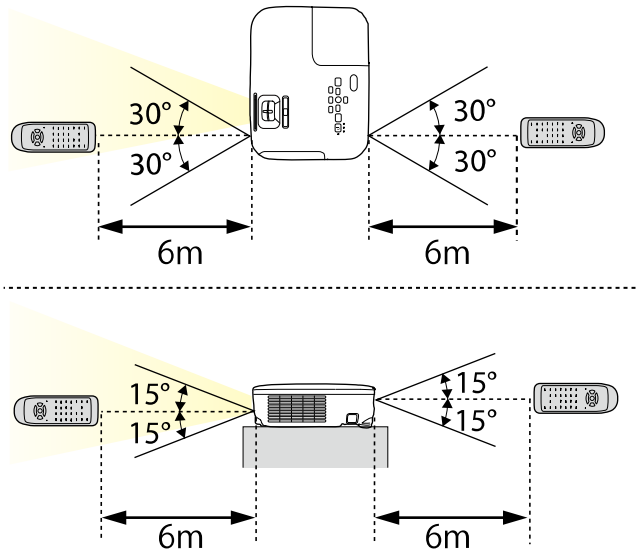

EB-E20/EB-E10/EB-E01/VS260

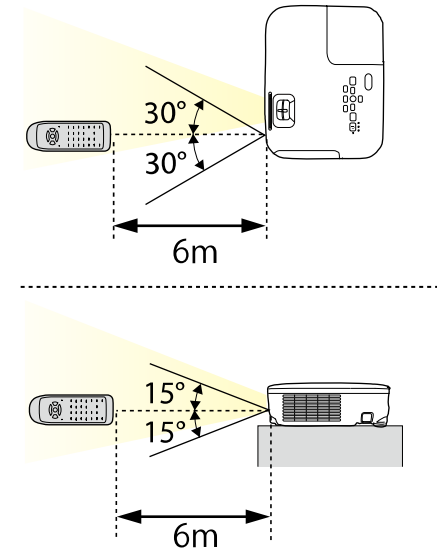

Avoid using the remote control in conditions with bright fluorescent lights or in direct sunlight, or the projector may not respond to commands. If you are not going to use the remote control for a long time, remove the batteries.

- 1** To open the projector's lens cover, slide the A/V Mute slide lever until it clicks.

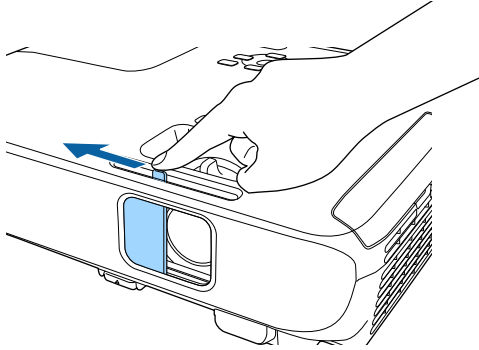

- 2** To cover the lens or temporarily turn off the projected image and sound, close the lens cover.



The projector's power automatically turns off 30 minutes after A/V Mute is enabled. You can disable this feature.

☛ **ECO > Lens Cover Timer**

» Related Links

- "List of Functions" [p.10](#)

Using Basic Projector Features

Follow the instructions in these sections to use your projector's basic features.

► Related Links

- "Turning On the Projector" [p.39](#)
- "Turning Off the Projector" [p.42](#)
- "Setting the Date and Time" [p.43](#)
- "Selecting the Language for the Projector Menus" [p.45](#)
- "Projection Modes" [p.46](#)
- "Displaying a Test Pattern" [p.48](#)
- "Adjusting the Image Height" [p.49](#)
- "Image Shape" [p.50](#)
- "Resizing the Image with the Zoom Ring" [p.54](#)
- "Focusing the Image Using the Focus Ring" [p.55](#)
- "Selecting an Image Source" [p.56](#)
- "Image Aspect Ratio" [p.58](#)
- "Adjusting Image Quality (Color Mode)" [p.61](#)
- "Controlling the Volume with the Volume Buttons" [p.63](#)

Turn on the computer or video equipment you want to use after you turn on the projector.

- 1** Connect the power cord to the projector's power inlet and plug it into an electrical outlet.

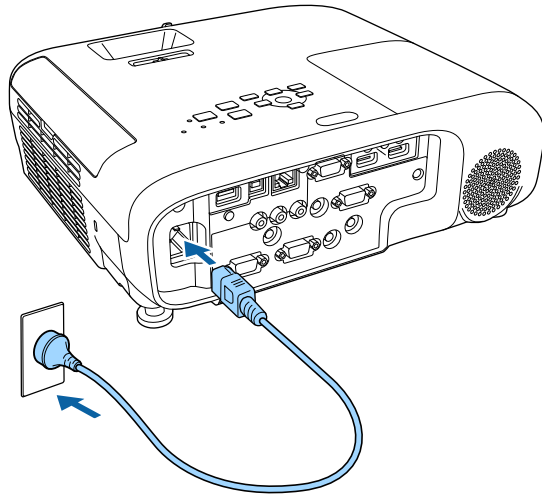

The projector's power indicator turns blue. This indicates that the projector is receiving power, but is not yet turned on (it is in standby mode).

- 2** Press the power button on the control panel or remote control to turn on the projector.

The projector beeps and the status indicator flashes blue as the projector warms up. Once the projector is warmed up, the status indicator stops flashing and turns blue.

- 3** Open the projector's lens cover.

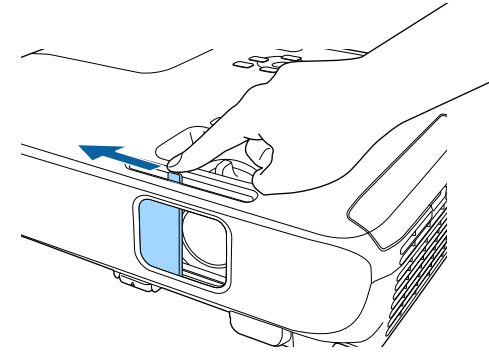

Try the following if you do not see a projected image.

- Verify the lens cover is open all the way.
- Turn on the connected computer or video device.
- Change the screen output from the computer when using a laptop computer.
- Insert a DVD or other video media, and press play (if necessary).
- Press the [Source Search] button on the control panel or remote control to detect the source.
- Press the button for the desired video source on the remote control.
- If the Home screen is displayed, select the source you want to project.

⚠ Warning

- Never look into the projector lens when the lamp is on. This can damage your eyes and is especially dangerous for children.
 - When turning on the projector at a distance using the remote control, make sure there is no one looking into the lens.
 - During projection, do not block the light from the projector with a book or other objects. If the light from the projector is blocked, the area on which the light shines becomes hot which could cause it to melt, burn, or start a fire. Also, the lens may get hot due to the reflected light which could cause the projector to malfunction. To stop projection, use the A/V Mute function, or turn off the projector.
 - A mercury lamp with high internal pressure is used as the projector's light source. If the lamp is subjected to vibrations or shocks, or if it is used for an overly extended length of time, the lamp may break or it may not turn on. If the lamp explodes, gases may escape and small fragments of glass may be scattered which could cause an injury. Be sure to observe the instructions below.
 - Do not disassemble or damage the lamp or subject it to any impacts.
 - Do not bring your face close to the projector while it is in use.
 - Particular care should be taken when the projector is installed to a ceiling, as small pieces of glass may fall down when the lamp cover is removed. When cleaning the projector or replacing the lamp yourself, be very careful not to allow such pieces of glass to get into the eyes or mouth.
- If the lamp breaks, ventilate the area immediately, and contact a doctor if any fragments of broken glass are inhaled or get into the eyes or mouth.



- When the **Direct Power On** setting is set to **On** in the projector's **Extended** menu, the projector turns on as soon as you plug it in. Note that the projector also turns on automatically in cases such as recovery from a power outage.
 - ☛ **Extended > Operation > Direct Power On**
- If you select a specific port as the **Auto Power On** setting in the projector's **Extended** menu, the projector turns on as soon as it detects a signal or cable connection from that port.
 - ☛ **Extended > Operation > Auto Power On**

- "Projector Setup Settings - Extended Menu" p.134
- "List of Functions" p.10

Home Screen

The Home screen feature allows you to easily select an image source and access useful functions. You can display the Home screen by pressing the [Home] button on the control panel or remote control. The Home screen is also displayed when you turn on the projector and no signal is being input.

Press the arrow buttons on the control panel or remote control to select a menu item, and then press [Enter].



- 1 Selects the source you want to project.
- 2 Displays the Connection Guide. You can select the wireless connection methods according to the devices you are using, such as smartphones or computers.
- 3 Displays the Help screen.
- 4 Displays the projector's menu.

» Related Links

- "Home Screen" p.40

- 5 Performs menu options assigned to **Home Screen** in the projector's **Extended** menu.
- 6 Projects two images from different image sources simultaneously by splitting the projected screen.
- 7 Corrects the shape of an image that is an uneven rectangle.



The Home screen disappears after 10 minutes of inactivity.

» Related Links

- "Image Shape" [p.50](#)
- "Projector Setup Settings - Extended Menu" [p.134](#)
- "List of Functions" [p.10](#)
- "Using the Projector's Menus" [p.128](#)
- "Using the Projector Help Displays" [p.172](#)
- "Projecting Two Images Simultaneously" [p.65](#)

Turn off the projector after use.



- Turn off this product when it is not in use to prolong the life of the projector. Lamp life varies depending on the mode selected, environmental conditions, and usage. Brightness decreases over time.
- Since the projector supports the direct shutdown feature, it can be turned off directly using the breaker.

- 1** Press the power button on the control panel or remote control.
The projector displays a shutdown confirmation screen.

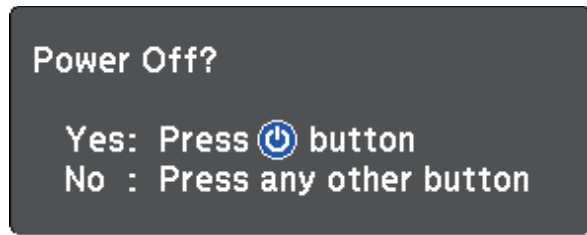

- 2** Press the power button again. (To leave it on, press any other button.)
The projected image disappears, the projector beeps twice, and the status indicator turns off.



With Epson's Instant Off technology, there is no cool-down period so you can pack up the projector for transport right away.

- 3** To transport or store the projector, make sure the power indicator is blue (but not flashing) and the status indicator is off, then unplug the power cord.
- 4** Close the projector's lens cover.

» Related Links

- ["List of Functions" p.10](#)

You can set the date and time for the projector.

- 1 Turn on the projector.
- 2 Press the [Menu] button on the control panel or remote control.
- 3 Select the **Extended** menu and press [Enter].
- 4 Select the **Operation** setting and press [Enter].
- 5 Select the **Date & Time** setting and press [Enter].

You see this screen:

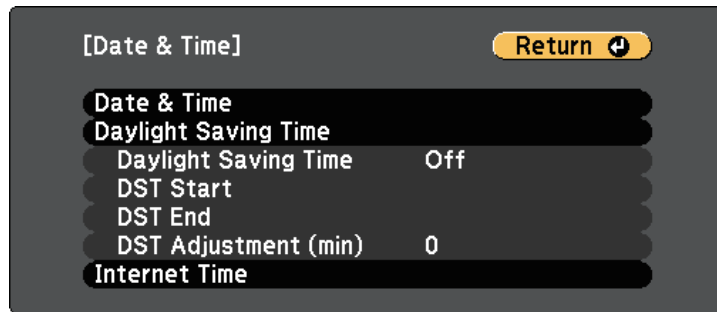

- 6 Select the **Date & Time** setting and press [Enter].

You see this screen:

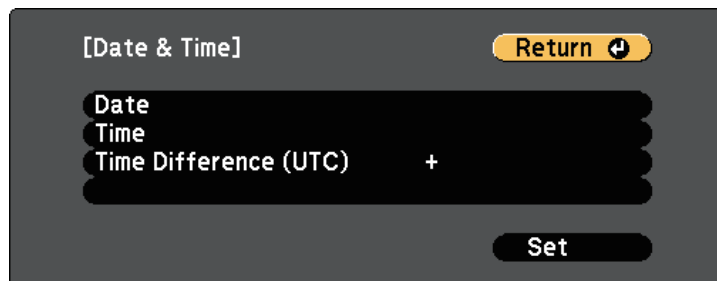

- 7 Select **Date**, press [Enter], and use the displayed keyboard to enter today's date.
- 8 Select **Time**, press [Enter], and use the displayed keyboard to enter the current time.
- 9 Select **Time Difference (UTC)**, press [Enter], and set the time difference from Coordinated Universal Time.
- 10 When you are finished, select **Set** and press [Enter].
- 11 To activate daylight saving time, select the **Daylight Saving Time** setting and press [Enter]. Then select settings.

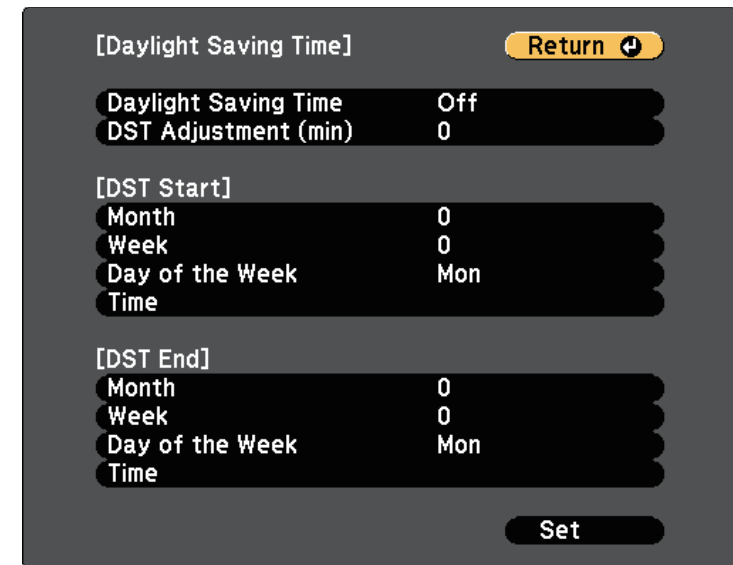

- 12 When you are finished, select **Set** and press [Enter].

- 13** To update the time automatically through an Internet time server, select the **Internet Time** setting and press [Enter]. Then select settings.

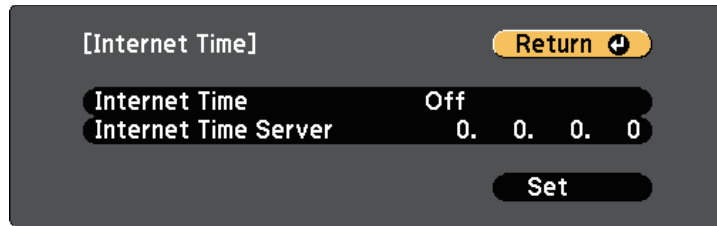

- 14** When you are finished, select **Set** and press [Enter].

- 15** Press [Menu] or [Esc] to exit the menus.

» Related Links

- ["List of Functions" p.10](#)

If you want to view the projector's menus and messages in another language, you can change the **Language** setting.

- 1** Turn on the projector.
- 2** Press the [Menu] button on the control panel or remote control.
- 3** Select the **Extended** menu and press [Enter].

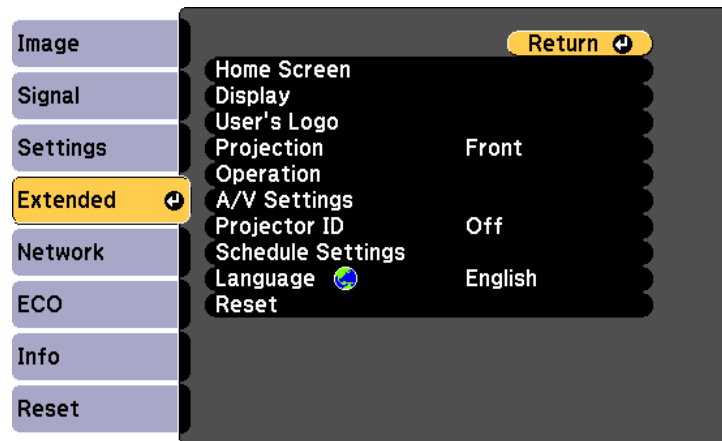

- 4** Select the **Language** setting and press [Enter].
- 5** Select the language you want to use and press [Enter].
- 6** Press [Menu] or [Esc] to exit the menus.

Depending on how you positioned the projector, you may need to change the projection mode so your images project correctly.

- **Front** lets you project from a table in front of the screen.
- **Front/Ceiling** flips the image over top-to-bottom to project upside-down from a ceiling or wall mount.
- **Rear** flips the image horizontally to project from behind a translucent screen.
- **Rear/Ceiling** flips the image over top-to-bottom and horizontally to project from a ceiling or wall mount and behind a translucent screen.

» **Related Links**

- "Changing the Projection Mode Using the Remote Control" [p.46](#)
- "Changing the Projection Mode Using the Menu" [p.46](#)
- "Projector Setup and Installation Options" [p.25](#)

Changing the Projection Mode Using the Remote Control

You can change the projection mode to flip the image over top-to-bottom.

- 1 Turn on the projector and display an image.
- 2 Hold down the [A/V Mute] button on the remote control for 5 seconds.

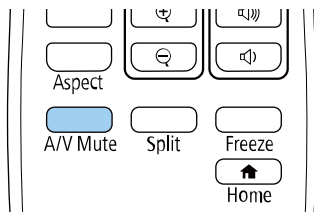

The image disappears briefly and reappears flipped top-to-bottom.

- 3 To change projection back to the original mode, hold down the [A/V Mute] button for 5 seconds again.

Changing the Projection Mode Using the Menus

You can change the projection mode to flip the image over top-to-bottom and/or left-to-right using the projector menus.

- 1 Turn on the projector and display an image.
- 2 Press the [Menu] button on the control panel or remote control.
- 3 Select the **Extended** menu and press [Enter].

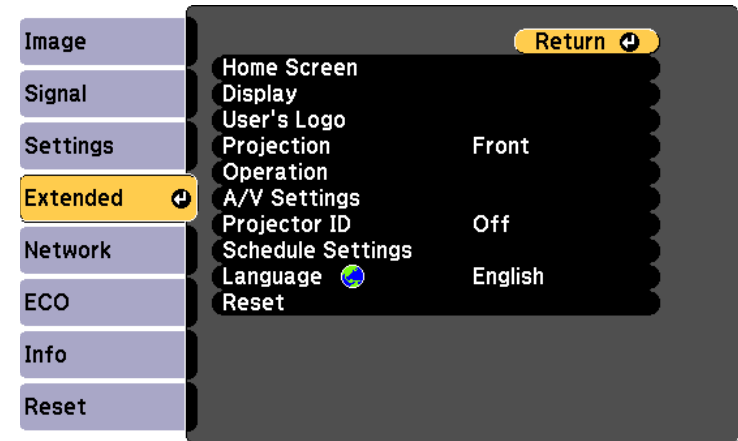

- 4 Select **Projection** and press [Enter].

- 5** Select a projection mode and press [Enter].

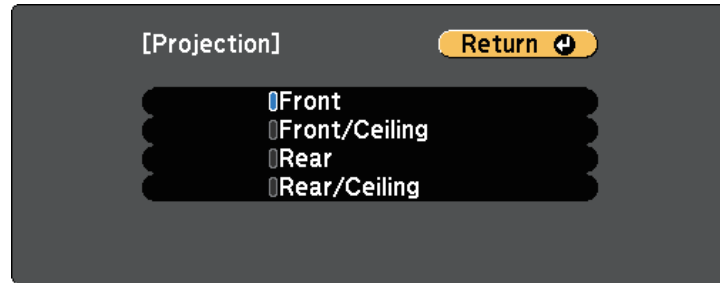

- 6** Press [Menu] or [Esc] to exit the menus.

You can display a test pattern to adjust the projected image without connecting a computer or video device.



To set menu items that cannot be set while the test pattern is being displayed or to fine-tune the projected image, project an image from the connected device.

- 1** Turn on the projector.
- 2** Press the [Menu] button on the control panel or remote control.
- 3** Select the **Settings** menu and press [Enter].

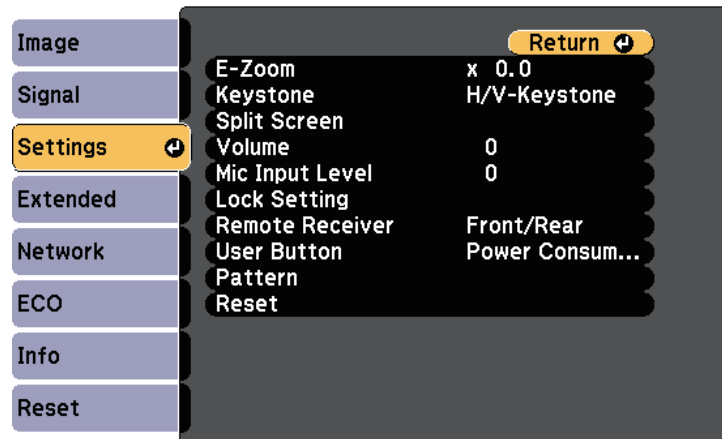

- 4** Select **Pattern > Test Pattern**, and press [Enter].
The test pattern is displayed.
- 5** Adjust the image as necessary.
- 6** Press [Esc] to clear the test pattern.

If you are projecting from a table or other flat surface and the image is too high or low, you can adjust the image height using the projector's adjustable feet.

The larger the angle of tilt, the harder it becomes to focus. Locate the projector so that it only needs to be tilted at a small angle.

- 1** Turn on the projector and display an image.
- 2** To adjust the front foot, pull up on the foot release lever and lift the front of the projector.

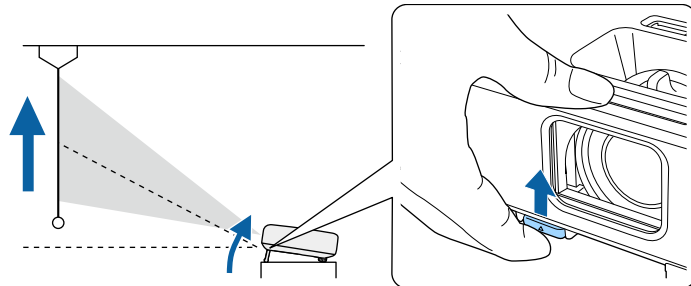

The foot extends from the projector.

You can adjust the position up to approximately 12 degrees.

- 3** Release the lever to lock the foot.

- 4** If the image is tilted, rotate the rear feet to adjust their height.

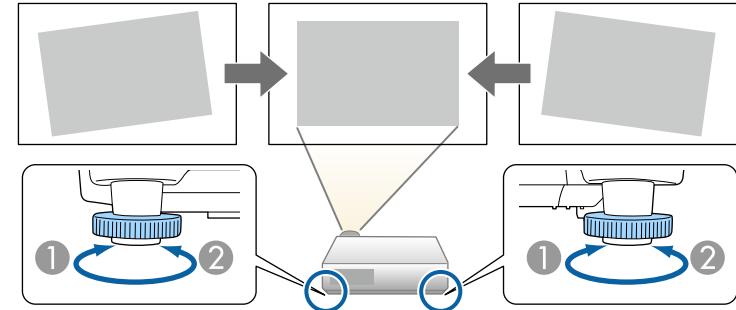

- 1** Extend the rear foot
- 2** Retract the rear foot

If the projected image is unevenly rectangular, you need to adjust the image shape.

» Related Links

- "Image Shape" [p.50](#)

You can project an even, rectangular image by placing the projector directly in front of the center of the screen and keeping it level. If you place the projector at an angle to the screen, or tilt it up or down, or off to the side, you may need to correct the image shape.

After correction, your image is slightly smaller.

For the best quality images, we recommend adjusting the installation position of the projector to achieve the correct image size and shape.

► Related Links

- "Auto V-Keystone" [p.50](#)
- "Correcting the Image Shape with the Horizontal Keystone Slider" [p.50](#)
- "Correcting the Image Shape with the Keystone Buttons" [p.51](#)
- "Correcting the Image Shape with Quick Corner" [p.52](#)

Auto V-Keystone

When the projector is moved or tilted, **Auto V-Keystone** automatically corrects any vertical keystone distortion.

Auto V-Keystone can correct the projected image distortion in these conditions:

- Projection angle is about 30° up or down
- The **Projection** setting is set to **Front** in the projector's **Extended** menu



- If you do not want to use the **Auto V-Keystone** function, set **Auto V-Keystone** to **Off** in the projector's menu.
 🖱️ **Settings > Keystone > H/V-Keystone > Auto V-Keystone**

► Related Links

- "Projection Modes" [p.46](#)
- "Projector Setup Settings - Extended Menu" [p.134](#)
- "Projector Feature Settings - Settings Menu" [p.132](#)
- "List of Functions" [p.10](#)

Correcting the Image Shape with the Horizontal Keystone Slider

You can use the projector's horizontal keystone slider to correct the shape of an image that is an uneven horizontal rectangle, such as when the projector is placed to the side of the projection area. (Available only for models that have the horizontal keystone slider.)

You can make effective corrections when the projection angle is about 30° right or left.

- 1 Turn on the projector and display an image.
- 2 Adjust the slider until the image is an even rectangle.

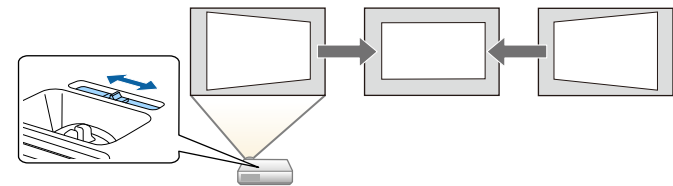

After correction, your image is slightly smaller.



- When you use the horizontal keystone slider, set **H-Keystone Adjuster** to **On** in the projector's **Settings** menu.
 🖱️ **Settings > Keystone > H/V-Keystone > H-Keystone Adjuster**
- You can also correct the shape of the image in the horizontal direction in the projector's **Settings** menu.
 🖱️ **Settings > Keystone > H/V-Keystone**

► Related Links

- "Projector Feature Settings - Settings Menu" [p.132](#)
- "List of Functions" [p.10](#)

Correcting the Image Shape with the Keystone Buttons

You can use the projector's keystone correction buttons to correct the shape of an image that is unevenly rectangular.

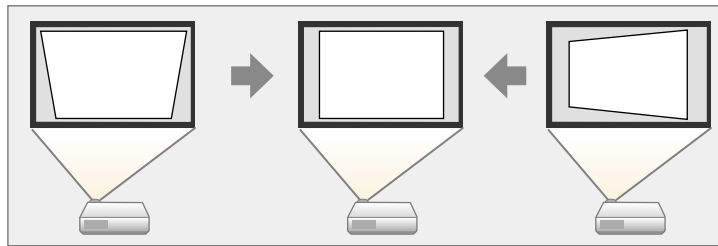

You can use keystone buttons to correct images up to 30° right, left, up, or down.

- 1** Turn on the projector and display an image.
- 2** Press one of the keystone adjustment buttons on the control panel to display the Keystone adjustment screen.

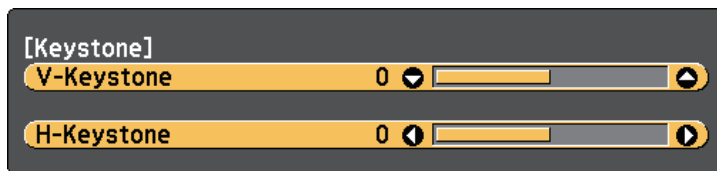

- 3** Press a keystone button to adjust the image shape.

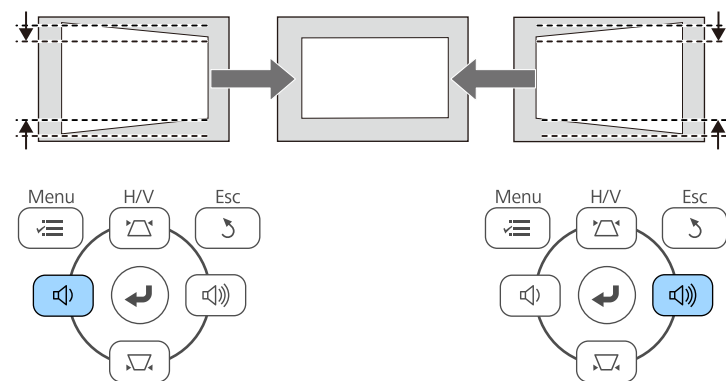
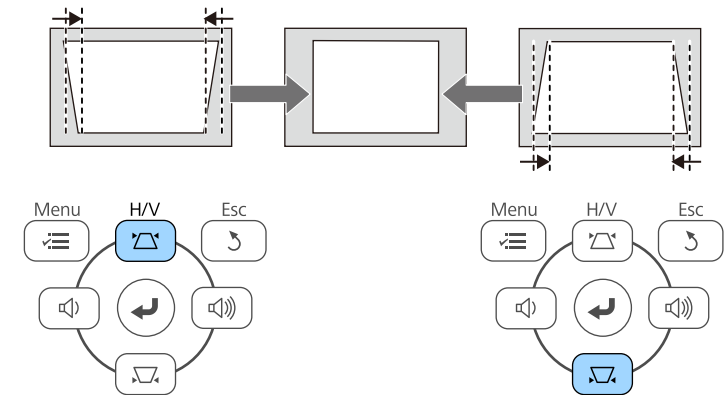

• If the projector is installed out of your reach, you can also correct the shape of the image using the remote control.
 Settings > Keystone > H/V-Keystone

» Related Links

- "Projector Feature Settings - Settings Menu" [p.132](#)

Correcting the Image Shape with Quick Corner

You can use the projector's **Quick Corner** setting to correct the shape and size of an image that is unevenly rectangular.

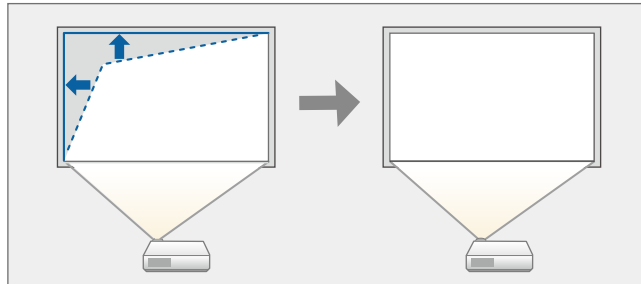

- 1** Turn on the projector and display an image.
- 2** Press the [Menu] button on the control panel or remote control.
- 3** Select the **Settings** menu and press [Enter].

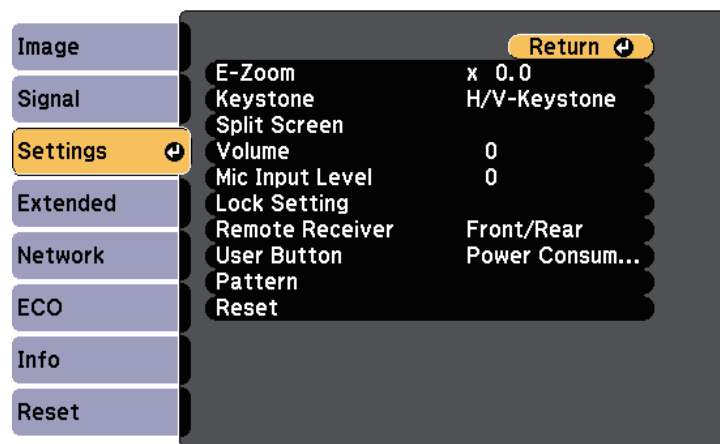

- 4** Select **Keystone** and press [Enter].

- 5** Select **Quick Corner** and press [Enter]. Then press [Enter] again if necessary.



You see the area selection screen.

- 6** Use the arrow buttons to select the corner of the image you want to adjust. Then press [Enter].

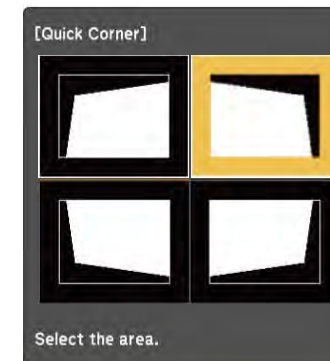

- 7** Press the arrow buttons to adjust the image shape as necessary. To return to the area selection screen, press [Enter].



- If you see this screen, you cannot adjust the shape any further in the direction indicated by the gray triangle.



- To reset the Quick Corner corrections, hold down [Esc] for about 2 seconds while the Quick Corner adjustment screen is displayed, and select **Reset Quick Corner**. Select **Switch to H/V-Keystone** to switch the image shape correction method to H/V-Keystone.

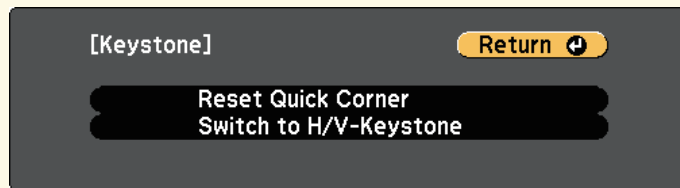

8 Repeat steps 6 and 7 as needed to adjust any remaining corners.

9 When you are finished, press [Esc].

The **Keystone** setting is now set to **Quick Corner** in the projector's **Settings** menu. The next time you press the keystone adjustment buttons on the control panel, the area selection screen is displayed.

» Related Links

- "Projector Feature Settings - Settings Menu" [p.132](#)

You can resize the image using the projector's zoom ring. (Available only for models that have the zoom ring.)

- 1** Turn on the projector and display an image.
- 2** Rotate the zoom ring to enlarge or reduce the image.

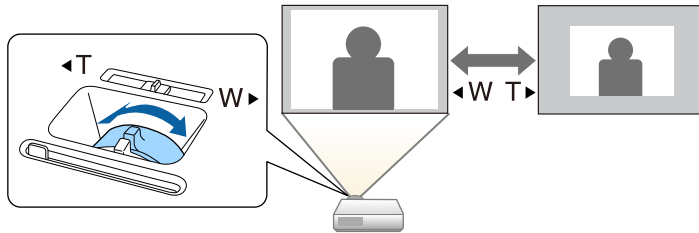

► Related Links

- ["List of Functions" p.10](#)

You can correct the focus using the focus ring.

- 1** Turn on the projector and display an image.
- 2** Rotate the focus ring to adjust the focus.

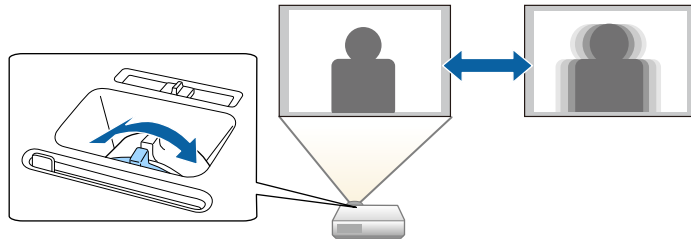

When multiple image sources are connected to the projector, such as a computer and DVD player, you can switch from one image source to the other.

Available sources vary depending on the projector model.

- 1** Make sure the connected image source you want to use is turned on.
- 2** For video image sources, insert a DVD or other video media and press play.
- 3** Do one of the following:
 - Press the [Source Search] button on the control panel or remote control until you see the image from the source you want.

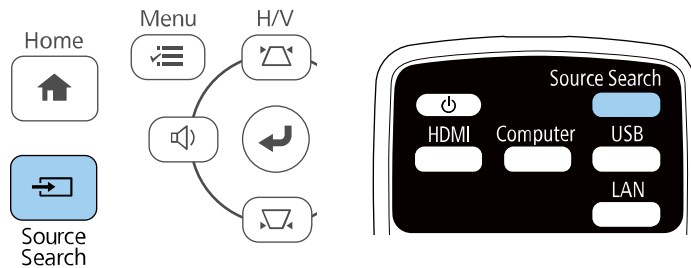

 This screen is displayed when no image signal is detected. Check the cable connections between the projector and image source.

[Source Search]

	Signal Status
HDMI1	Off
HDMI2	Off
Computer1	Off
Computer2	Off
Video	Off
USB Display	Off
USB	Off
LAN	Off
Screen Mirroring	Off

· Input an image signal.
· Press  to select the source.

- Press the button for the source you want on the remote control. If there is more than one port for that source, press the button again to cycle through the sources.
- Press the [Home] button on the control panel or remote control.

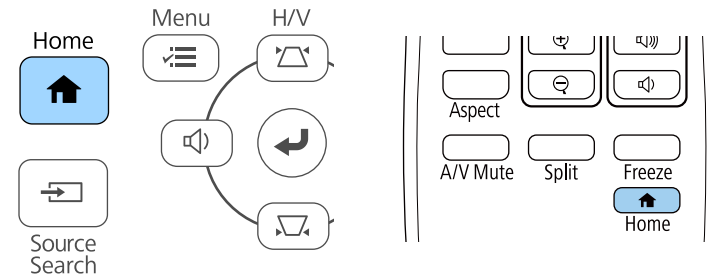

Then select the source you want to use from the screen displayed.



► Related Links

- "List of Functions" [p.10](#)

The projector can display images in different width-to-height ratios called aspect ratios. Normally, the input signal from your video source determines the image's aspect ratio. However, for certain images you can change the aspect ratio to fit your screen.

If you always want to use a particular aspect ratio for a certain video input source, you can select it using the projector's **Signal** menu.

► **Related Links**

- "Changing the Image Aspect Ratio" [p.58](#)
- "Available Image Aspect Ratios" [p.58](#)
- "Projected Image Appearance with Each Aspect Mode" [p.59](#)
- "Input Signal Settings - Signal Menu" [p.131](#)

Changing the Image Aspect Ratio

You can change the aspect ratio of the displayed image.

- 1 Turn on the projector and switch to the image source you want to use.
- 2 Press the [Aspect] button on the remote control.

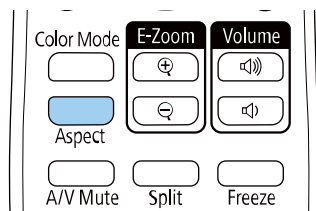

The shape and size of the displayed image changes, and the name of the aspect ratio appears briefly on the screen.

- 3 To cycle through the available aspect ratios for your input signal, press the [Aspect] button repeatedly.



To display images without black bars, set **Resolution** to **Wide** or **Normal** in the projector's **Signal** menu according to the computer's resolution.

► **Related Links**

- "Input Signal Settings - Signal Menu" [p.131](#)

Available Image Aspect Ratios

You can select the following image aspect ratios, depending on the input signal from your image source.



- The available aspect ratio setting varies depending on the input signal.
- Note that using the aspect ratio function of the projector to reduce, enlarge, or split the projected image for commercial purposes or for public viewing may infringe upon the rights of the copyright holder of that image based on copyright law.

For projectors with a resolution of Full HD (1920 × 1080) or WXGA (1280 × 800)

Aspect mode	Description
Auto	Automatically sets the aspect ratio according to the input signal and the Resolution setting.
Normal	Displays images using the full projection area and maintains the aspect ratio of the image.
16:9 *	Converts the aspect ratio of the image to 16:9.
Full	Displays images using the full size of the projection area, but does not maintain the aspect ratio.
Zoom	Displays images using the full width of the projection area and maintains the aspect ratio of the image.
Native	Displays images as is (aspect ratio and resolution are maintained).

* Available only for projectors with a resolution of WXGA (1280 × 800).

For projectors with a resolution of XGA (1024 × 768)

Aspect mode	Description
Auto	Automatically sets the aspect ratio according to the input signal and the Resolution setting.
Normal	Displays images using the full projection area and maintains the aspect ratio of the image.
4:3	Converts the aspect ratio of the image to 4:3.
16:9	Converts the aspect ratio of the image to 16:9.

► **Related Links**

- "List of Functions" [p.10](#)

Aspect mode	Aspect ratio for input signals		
	16:10	16:9	4:3
16:9 *			
Full			
Zoom			
Native			

Projected Image Appearance with Each Aspect Mode

Black bands and cropped images may project in certain aspect ratios, depending on the aspect ratio and resolution of your input signal. See the following table to confirm the position of black bands and cropped images.

 The image for **Native** varies depending on the input signal.

For projectors with a resolution of Full HD (1920 × 1080) or WXGA (1280 × 800)

Aspect mode	Aspect ratio for input signals		
	16:10	16:9	4:3
Normal Auto			

* Available only for projectors with a resolution of WXGA (1280 × 800).

For projectors with a resolution of XGA (1024 × 768)

Aspect mode	Aspect ratio for input signals		
	16:10	16:9	4:3
Normal Auto			
4:3			
16:9			

» Related Links

- "List of Functions" [p.10](#)

The projector offers different color modes to provide optimum brightness, contrast, and color for a variety of viewing environments and image types. You can select the mode designed to match your image and environment, or experiment with the available modes.

» **Related Links**

- "Changing the Color Mode" [p.61](#)
- "Available Color Modes" [p.61](#)
- "Setting Auto Iris" [p.61](#)

 You can also set the **Color Mode** setting in the projector's **Image** menu.

» **Related Links**

- "Image Quality Settings - Image Menu" [p.130](#)

Changing the Color Mode

You can change the projector's Color Mode using the remote control to optimize the image for your viewing environment.

- 1** Turn on the projector and switch to the image source you want to use.
- 2** Press the [Color Mode] button on the remote control to change the Color Mode.

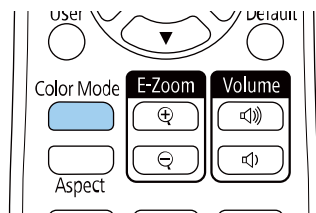

The name of the Color Mode appears briefly on the screen and then image appearance changes.

- 3** To cycle through all of the available color modes for your input signal, press the [Color Mode] button repeatedly.

Available Color Modes

You can set the projector to use these color modes, depending on the input source you are using:

Color mode	Description
Dynamic	This is the brightest mode. Best for prioritizing brightness.
Presentation	Best for projecting vivid images.
Cinema	Best for enjoying content such as movies.
sRGB	Best for faithfully reproducing the color of the source image.
Blackboard	Best for projecting images directly on a green chalkboard.

Setting Auto Iris

You can turn on **Auto Iris** to automatically optimize the image based on the brightness of the content.

This setting is available for **Dynamic** or **Cinema** color modes.

- 1** Turn on the projector and switch to the image source you want to use.
- 2** Press the [Menu] button on the control panel or remote control.

- 3** Select the **Image** menu and press [Enter].

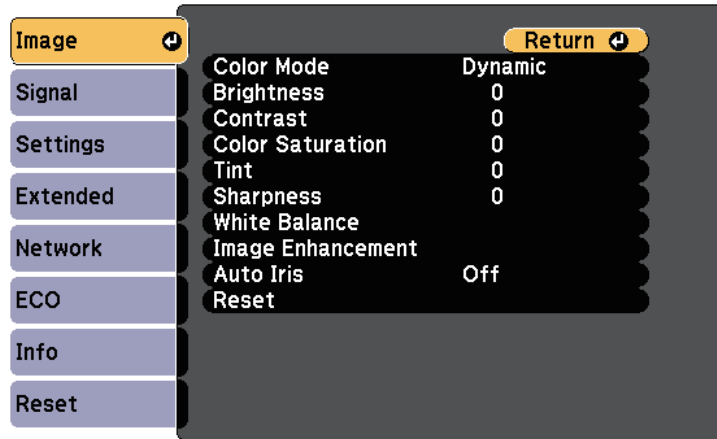

- 4** Select **Auto Iris** and press [Enter].

- 5** Choose one of the following options and press [Enter]:

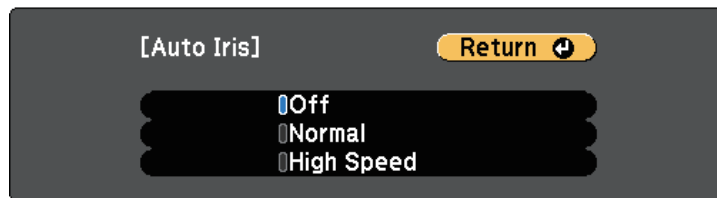

- **Normal** for standard brightness adjustment.
 - **High Speed** to adjust brightness as soon as the scene changes.
- 6** Press [Menu] or [Esc] to exit the menus.

The volume buttons control the projector's internal speaker system.

You can also control the volume of any external speakers you connected to the projector.

You must adjust the volume separately for each connected input source.

- 1** Turn on the projector and start a presentation.
- 2** To lower or raise the volume, press the [Volume] buttons on the control panel or remote control as shown.

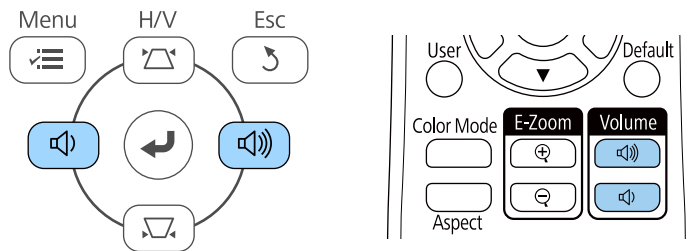

A volume gauge appears on the screen.

- 3** To set the volume to a specific level for an input source, select **Volume** in the projector's **Settings** menu.

Caution

Do not start a presentation at a high volume setting. Sudden loud noises may cause hearing loss.

Always lower the volume before powering off, so that you can power on and then gradually increase the volume.

» Related Links

- "Projector Feature Settings - Settings Menu" [p.132](#)

Adjusting Projector Features

Follow the instructions in these sections to use your projector's adjustment features.

► Related Links

- "Projecting Two Images Simultaneously" [p.65](#)
- "Projecting a PC Free Presentation" [p.68](#)
- "Shutting Off the Image and Sound Temporarily" [p.73](#)
- "Stopping Video Action Temporarily" [p.74](#)
- "Zooming In/Zooming Out of Images (E-Zoom)" [p.75](#)
- "Saving a User's Logo Image" [p.77](#)
- "Saving a User Pattern" [p.78](#)
- "Color Difference Correction when Projecting from Multiple Projectors" [p.79](#)
- "Projector Security Features" [p.82](#)

You can use the split screen feature to simultaneously project two images from different image sources. You can control the split screen feature using the remote control or the projector menus.

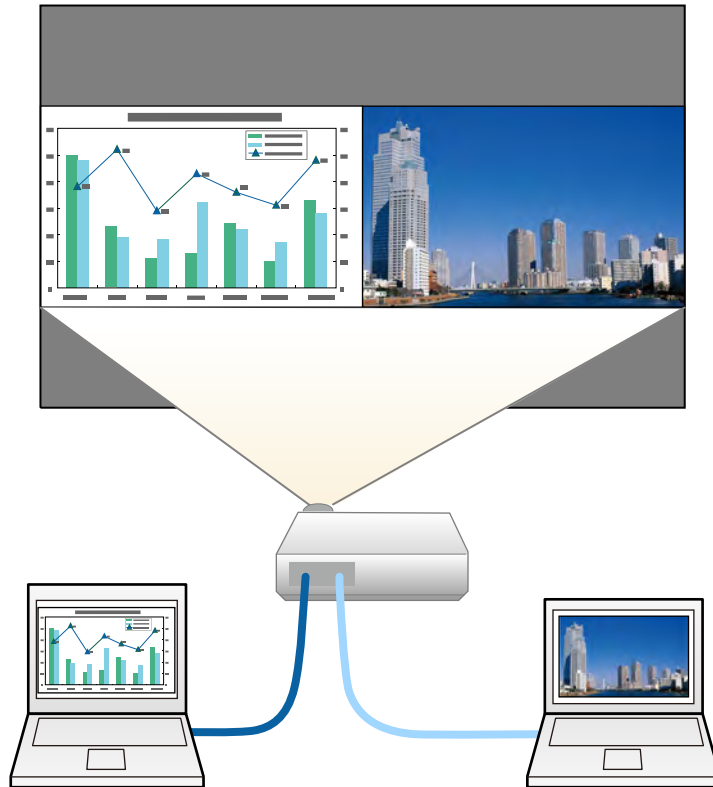

- While using the split screen feature, other projector features may not be available and some settings may be automatically applied to both images.

1 Press the [Split] button on the remote control.

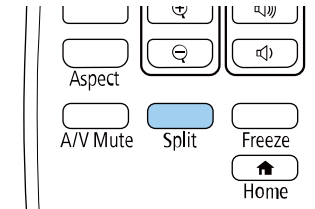

The currently selected input source moves to the left of the screen.



You can perform the same operations from **Split Screen** in the projector's **Settings** menu.

2 Press the [Menu] button.

You see this screen:

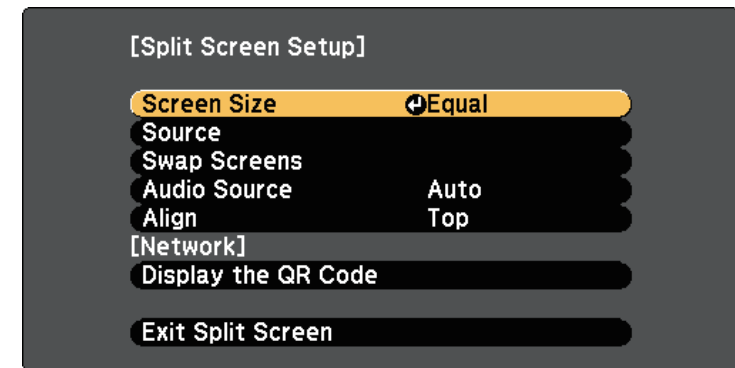

3 To select an input source for the other image, select the **Source** setting, press [Enter], select the input source, select **Execute**, and press [Enter].

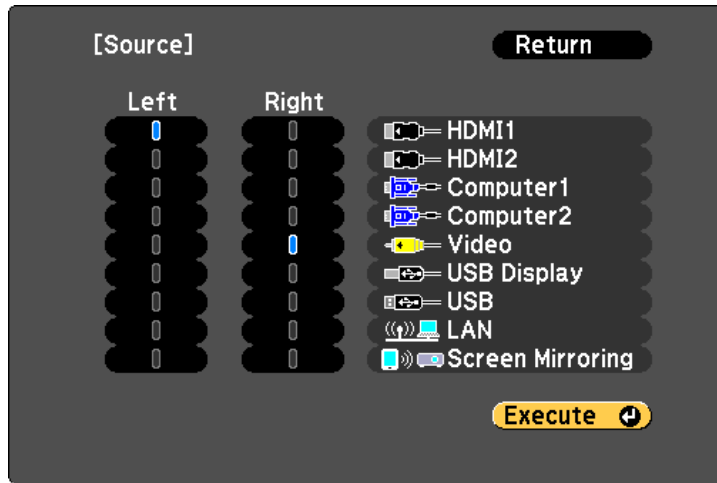

- You can only select input sources that can be combined.
- While using the split screen feature, the **Source** screen appears when you change the input source from the remote control.

4 To switch images, select **Swap Screens** and press [Enter]. The projected images on the left and right are swapped.



5 To enlarge one image while reducing the other image, select **Screen Size**, press [Enter], select a size, and press [Enter]. To exit the menu, press [Menu].



Depending on the video input signals, the images may not appear at the same size even if you select **Equal**.

6 To select the audio, select **Audio Source**, press [Enter], select an audio option, and press [Enter]. To exit the menu, press [Menu].

Select **Auto** to hear audio from the largest screen or the left screen.

7 To align the projected images, select **Align**, press [Enter], select the setting, and press [Enter] again. To exit the menu, press [Menu].

8 To exit the split screen feature, press [Split] or [Esc].

» Related Links

- "Unsupported Input Source Combinations for Split Screen Projection" [p.67](#)
- "Split Screen Projection Restrictions" [p.67](#)
- "List of Functions" [p.10](#)

Unsupported Input Source Combinations for Split Screen Projection

These input source combinations cannot be projected on a split screen.

- Computer1 and Computer2
- Computer1/Computer2 and Video
- HDMI1/HDMI2 and Screen Mirroring
- HDMI1 and HDMI2
- USB Display and USB/LAN
- USB and LAN

» Related Links

- "List of Functions" [p.10](#)

Split Screen Projection Restrictions

Operating restrictions

The following operations cannot be performed during split screen projection.

- Setting the projector's menu
- E-Zoom
- Switching the aspect mode (the aspect mode is set to **Normal**)
- Operations using the [User] button on the remote control
- Auto Iris

Image restrictions

- If you make adjustments such as **Brightness**, **Contrast**, **Color Saturation**, **Tint**, and **Sharpness** in the projector's **Image** menu, you can apply them only to the image on the left. Default adjustments are applied to the image on the right. Adjustments that affect the entire projected image such as **Color Mode** and **Color Temp.** are applied for both left and right images.

- Even if you make adjustments for **Noise Reduction** and **Deinterlacing** in the projector's **Image** menu, **Noise Reduction** is set to 0 and **Deinterlacing** is set to **Off** for the image on the right.

☛ **Image > Image Enhancement > Noise Reduction**

☛ **Image > Image Enhancement > Deinterlacing**

- Even if you set **Display Background** to **Logo** in the projector's **Extended** menu, the blue screen appears when no image signal is being input.

» Related Links

- "Image Aspect Ratio" [p.58](#)
- "Adjusting Image Quality (Color Mode)" [p.61](#)
- "Projector Feature Settings - Settings Menu" [p.132](#)
- "Projector Setup Settings - Extended Menu" [p.134](#)
- "Image Quality Settings - Image Menu" [p.130](#)
- "Zooming In/Zooming Out of Images (E-Zoom)" [p.75](#)
- "Setting Auto Iris" [p.61](#)

You can use your projector's PC Free feature whenever you connect a USB device that contains compatible presentation files. This lets you quickly and easily display a presentation and control it using the projector's remote control.

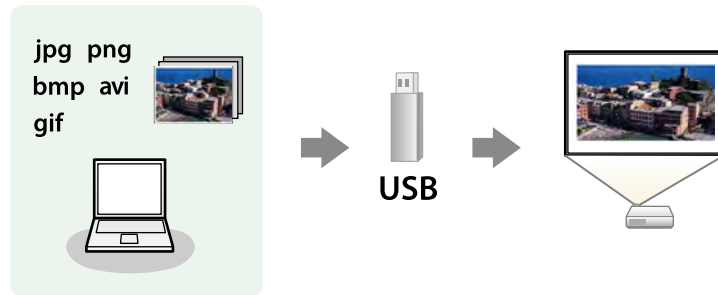

» **Related Links**

- "Supported PC Free File Types" [p.68](#)
- "Precautions on PC Free Projection" [p.68](#)
- "Starting a PC Free Slide Show" [p.69](#)
- "Starting a PC Free Movie Presentation" [p.70](#)
- "PC Free Display Options" [p.71](#)
- "List of Functions" [p.10](#)

Supported PC Free File Types

You can project these types of files using the projector's PC Free feature.



- For best results, place your files on media that is formatted in FAT16/32.
- If you have trouble projecting from media formatted for non-Windows file systems, try formatting the media for Windows instead.

File contents	File type (extension)	Details
Image	.jpg	Make sure the file is not: <ul style="list-style-type: none"> • CMYK format • Progressive format • Highly compressed • Above 8192 × 8192 resolution
	.bmp	Make sure the file is not: <ul style="list-style-type: none"> • Above 1280 × 800 resolution
	.gif	Make sure the file is not: <ul style="list-style-type: none"> • Above 1280 × 800 resolution • Animated • Interlaced
	.png	Make sure the file is not: <ul style="list-style-type: none"> • Above 1280 × 800 resolution * • Interlaced
Movie	.avi (Motion JPEG)	Supports only AVI 1.0. Make sure the file is not: <ul style="list-style-type: none"> • Saved with an audio codec other than PCM or ADPCM • Above 1280 × 720 resolution • Larger than 2 GB

* When you use a projector with a resolution of Full HD, you can project a file with a maximum resolution of 1920 × 1080.

Precautions on PC Free Projection

Note the following precautions when using PC Free features.

- You cannot use a USB key for PC Free features.
- Do not disconnect the USB storage device while it is being accessed; otherwise, PC Free may not operate correctly.

- You may not be able to use the security features on certain USB storage devices with PC Free features.
- When connecting a USB device that includes an AC adapter, connect the AC adapter to an electrical outlet when you use the device with your projector.
- Some commercially available USB card readers may not be compatible with the projector.
- The projector can recognize up to 5 cards inserted into the connected card reader at one time.
- You cannot correct keystone distortion while projecting in PC Free, so correct the image shape before you begin your presentation.
- You can use the following functions while projecting in PC Free.
 - Freeze
 - A/V Mute
 - E-Zoom

▶ Related Links

- "Stopping Video Action Temporarily" [p.74](#)
- "Shutting Off the Image and Sound Temporarily" [p.73](#)
- "Zooming In/Zooming Out of Images (E-Zoom)" [p.75](#)

Starting a PC Free Slide Show

After connecting a USB device to the projector, you can switch to the USB input source and start your slide show.



- You can change the PC Free operation options or add special effects by highlighting **Option** at the bottom of the screen and pressing [Enter].

- 1** Press the [USB] button on the remote control.

The PC Free file list screen is displayed.



- If the Select Drive screen is displayed, press the arrow buttons to select the drive and press [Enter].
- To display images on the other USB drive, highlight **Select Drive** at the top of the file list screen and press [Enter].

- 2** Do one of the following to locate your files:

- If you need to display files inside a subfolder on your device, press the arrow buttons to highlight the folder and press [Enter].
- To move back up a folder level on your device, highlight **Back to Top** and press [Enter].

- 3** Do one of the following:

- To display an individual image, press the arrow buttons to highlight the image and press [Enter]. (Press the [Esc] button to return to the file list screen.)
- To display a slide show of all the images in a folder, press the arrow buttons to highlight the **Slideshow** option at the bottom of the screen and press [Enter].



- You can change the image switching time by highlighting **Option** at the bottom of the screen and pressing [Enter].
- If any file names are longer than the display area or include unsupported symbols, the file names may be shortened or changed only on the screen display.

4 While projecting, use the following commands to control the display:

- To rotate a displayed image, press the up or down arrow button.

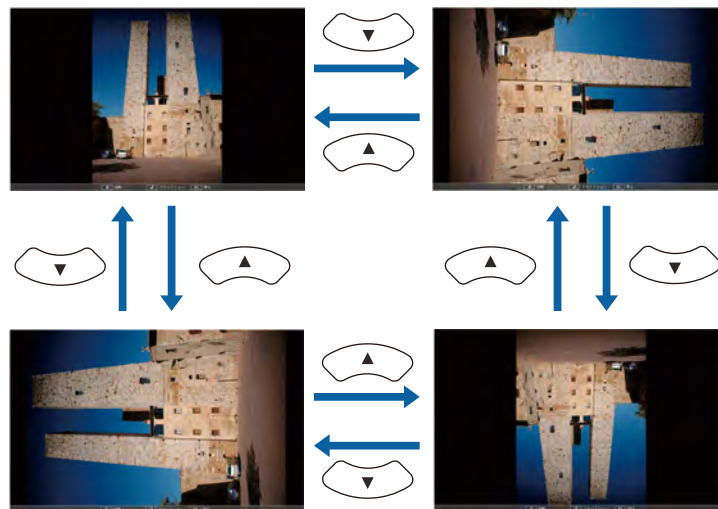

- To move to the next or previous image, press the left or right arrow button.

5 To stop the display, follow the on-screen instructions or press the [Esc] button.

You return to the file list screen.

6 Turn off the USB device, if necessary, and then disconnect the device from the projector.

» Related Links

- "PC Free Display Options" [p.71](#)
- "Connecting to a USB Device" [p.31](#)

Starting a PC Free Movie Presentation

After connecting a USB device to the projector, you can switch to the USB input source and start your movie.



- You can change the PC Free operation options by highlighting **Option** at the bottom of the screen and pressing [Enter].

1 Press the [USB] button on the remote control.

The PC Free file list screen is displayed.



- If the Select Drive screen is displayed, press the arrow buttons to select the drive and press [Enter].
- To display movie files on the other USB drive, highlight **Select Drive** at the top of the file list screen and press [Enter].

- 2** Do one of the following to locate your files:
- If you need to display files inside a subfolder on your device, press the arrow buttons to highlight the folder and press [Enter].
 - To move back up a folder level on your device, highlight **Back to Top** and press [Enter].

- 3** To play back a movie, press the arrow buttons to highlight the file and press [Enter].



- If any file names are longer than the display area or include unsupported symbols, the file names may be shortened or changed only on the screen display.
- If you want to play back all the movies in a folder in sequence, select the **Slideshow** option at the bottom of the screen.

- 4** To stop movie playback, press the [Esc] button, highlight **Exit**, and press [Enter].

You return to the file list screen.

- 5** Turn off the USB device, if necessary, and then disconnect the device from the projector.

» **Related Links**

- "PC Free Display Options" [p.71](#)
- "Connecting to a USB Device" [p.31](#)

PC Free Display Options

You can select these display options when using PC Free. To access this screen, highlight **Option** at the bottom of the PC Free file list screen and press [Enter].



Setting	Options	Description
Display Order	Name Order	Displays files in name order
	Date Order	Displays files in date order
Sort Order	In Ascending	Sorts files in first-to-last order
	In Descending	Sorts files in last-to-first order
Continuous Play	On	Displays a slide show continuously
	Off	Displays a slide show once
Screen Switching Time	No	Does not display the next file automatically
	1 Second to 60 Seconds	Displays files for the selected time and switches to the next file automatically; high resolution images may switch at a slightly slower rate

Setting	Options	Description
Effect	No	No effect
	Wipe	Transitions between images using a wipe effect
	Dissolve	Transitions between images using a dissolve effect
	Random	Transitions between images using a random variety of effects

You can temporarily turn off the projected image and sound if you want to redirect your audience's attention during a presentation. Any sound or video action continues to run, however, so you cannot resume projection at the point that you stopped it.

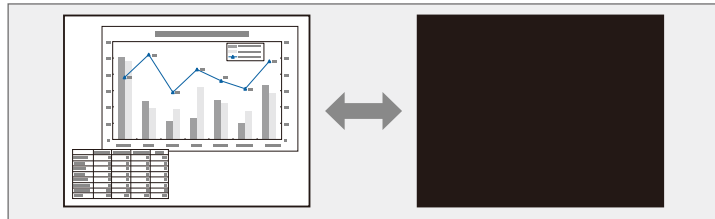

If you want to display an image such as a company logo or picture when the [A/V Mute] button is pressed, you can select the screen displayed in the **A/V Mute** setting in the projector's **Extended** menu.

☛ **Extended > Display > A/V Mute**

- 1** Press the [A/V Mute] button on the remote control to temporarily stop projection and mute any sound.

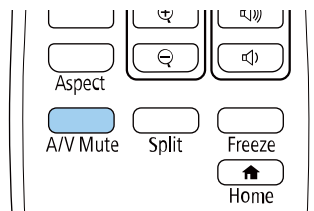

- 2** To turn the image and sound back on, press [A/V Mute] again.



- You can also stop projection using the A/V Mute slide lever on the projector.
- The projector's power automatically turns off 30 minutes after A/V Mute is enabled. You can disable this feature.
☛ **ECO > A/V Mute Timer**
- The lamp is still operating during A/V Mute, so the lamp hours continue to accumulate.

» Related Links

- "Projector Setup Settings - Extended Menu" [p.134](#)
- "Projector Setup Settings - ECO Menu" [p.147](#)

You can temporarily stop the action in a video or computer presentation and keep the current image on the screen. Any sound or video action continues to run, however, so you cannot resume projection at the point that you stopped it.

- 1** Press the [Freeze] button on the remote control to stop the video action.

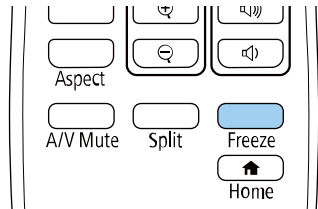

- 2** To restart the video action in progress, press [Freeze] again.

You can zoom in or zoom out of the projected image using the [E-Zoom] button on the remote control.

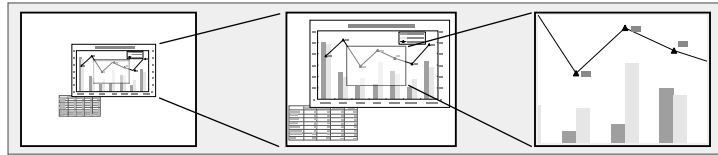

► Related Links

- "Zooming Into Images" [p.75](#)
- "Zooming Out of Images" [p.75](#)

Zooming Into Images

- 1 Press the [E-Zoom] + button on the remote control.

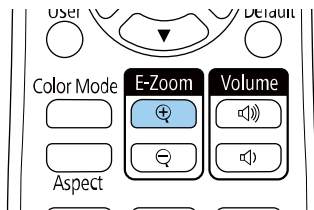

The projected image is enlarged focusing around the center of the image. You can enlarge the image between one to four times in 25 incremental steps.

- 2 Use the following buttons on the remote control to adjust the zoomed image:
 - Press the [E-Zoom] + button repeatedly to zoom into the image.
 - To pan around the zoomed image, use the arrow buttons.
 - To zoom out of the image, press the [E-Zoom] - button.

- To return to the original image size, press the [Default] button.



When projecting images from an Epson document camera, you can enlarge the image from one to eight times its size in 57 incremental steps using the [E-Zoom] + button on the document camera.

Zooming Out of Images

- 1 Press the [E-Zoom] - button on the remote control.

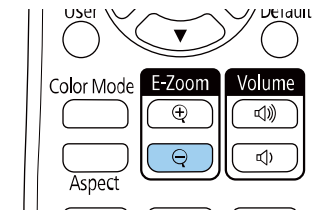

The projected image is reduced. You can reduce the image between 100% to 50% in incremental steps.

- 2 Use the following buttons on the remote control to adjust the zoomed-out image:
 - Press the [E-Zoom] - button repeatedly to zoom out of the projected image.
 - To move the zoomed-out image in the projection area, use the arrow buttons.
 - To zoom into the image, press the [E-Zoom] + button.
 - To return to the original image size, press the [Default] button.



When projecting image from an Epson document camera, you can also reduce the image using the [E-Zoom] - button on the document camera.

You can save an image on the projector and display it whenever the projector turns on. You can also display the image when the projector is not receiving an input signal. This image is called the user's logo screen.

You can select a photo, graphic, or company logo as the user's logo, which is useful in identifying the projector's owner to help deter theft. You can prevent changes to the user's logo by setting up password protection.



- If the **User's Logo Protection** setting in the **Password Protection** setting menu is set to **On**, set to **Off** before saving the user's logo.
- When you copy the menu settings from one projector to another using the batch setup feature, user's logo is also copied. Do not register the information that you do not want to share between multiple projectors as a user's logo.
- You cannot save content that is protected by HDCP.

- 1 Display the image you want to project as the user's logo.
- 2 Press the [Menu] button, select the **Extended** menu, and press [Enter].

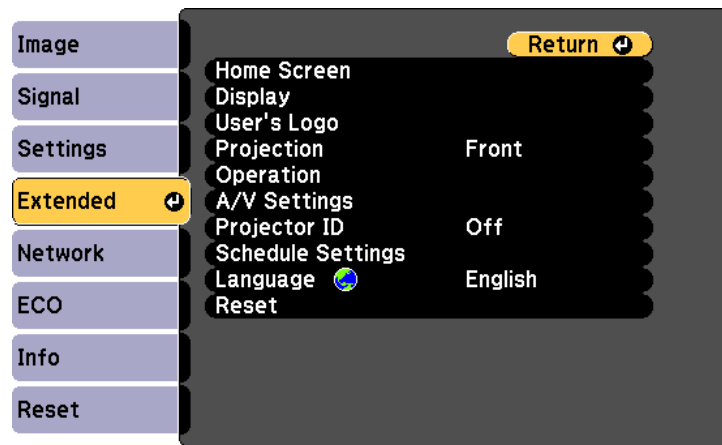

- 3 Select **User's Logo > Start Setting** and press [Enter].
You see a prompt asking if you want to use the displayed image as a user's logo.



Adjustments such as Keystone, E-Zoom, or Aspect are temporarily canceled when you select **User's Logo**.

- 4 Select **Yes** and press [Enter].
- 5 Check the displayed image, and then select **Yes** to save it as the user's logo.
The user's logo is overwritten and a completion message is displayed.
- 6 Press [Esc] to exit the message screen.
- 7 Select the **Extended** menu and press [Enter].
- 8 Select **Display** and press [Enter].
- 9 Select when you want to display the User's Logo screen:
 - To display it whenever there is no input signal, select **Display Background** and set it to **Logo**.
➤ **Extended > Display > Display Background**
 - To display it whenever you turn the projector on, select **Startup Screen** and set it to **On**.
➤ **Extended > Display > Startup Screen**
 - To display it whenever you press the [A/V Mute] button, select **A/V Mute** and set it to **Logo**.
➤ **Extended > Display > A/V Mute**

To prevent anyone from changing the User's Logo settings without first entering a password, set the **User's Logo Protection** setting to **On** in the **Password Protection** setting menu and set the password.

» Related Links

- "Shutting Off the Image and Sound Temporarily" [p.73](#)
- "Selecting Password Security Types" [p.83](#)

There are four types of patterns pre-registered in the projector, such as ruled lines and grid patterns. You can project these patterns to aid in presentations using the **Pattern Display** settings.

You can also save the image that is currently being projected as a User Pattern.



Once you save a User Pattern, the pattern cannot be returned to the factory default.

1 Project the image you want to save as the User Pattern, and then press the [Menu] button on the control panel or remote control.

2 Select the **Settings** menu and press [Enter].

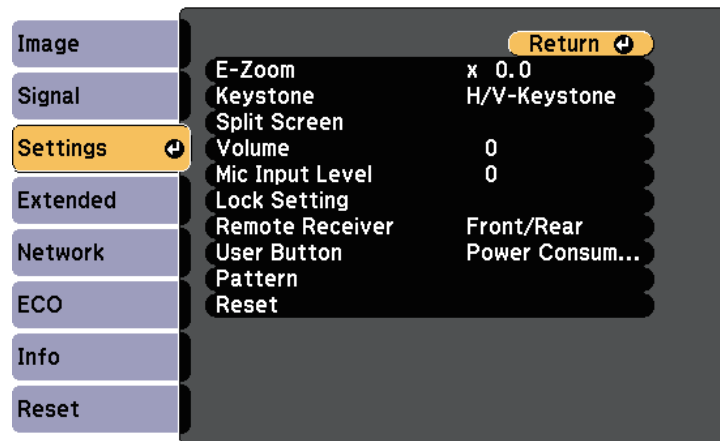

3 Select **Pattern > User Pattern** and press [Enter].

You see a prompt asking if you want to use the displayed image as a User Pattern.



- Adjustments such as Keystone, E-Zoom, or Aspect are temporarily cancelled when you select **User Pattern**.
- You cannot save digital images protected by HDCP technology as a User Pattern.

4 Select **Yes** and press [Enter].

You see a prompt asking if you want to save the image as the User Pattern.

5 Select **Yes** and press [Enter].

You see a completion message.

When lining up multiple projectors to project images, you can correct the brightness and color tone of each projector's image so that the images match closely.

You can set a unique projector ID for each projector to operate them individually using a remote control, and then correct the brightness and color for each projector.



- In some cases the brightness and color tone may not match completely even after correction.
- If brightness and color tone differences become more noticeable over time, repeat the adjustments.

► Related Links

- "Setting the Projector ID" [p.79](#)
- "Selecting the Projector You want to Operate" [p.79](#)
- "Matching Multiple-Projector Display Quality" [p.80](#)

Setting the Projector ID

To control multiple projectors from a remote control, give each projector a unique ID.

- 1** Press the [Menu] button, select the **Extended** menu, and press [Enter].
- 2** Select **Projector ID** and press [Enter].

- 3** Use the arrow buttons to select the identification number you want to use for the projector. Then press [Enter].

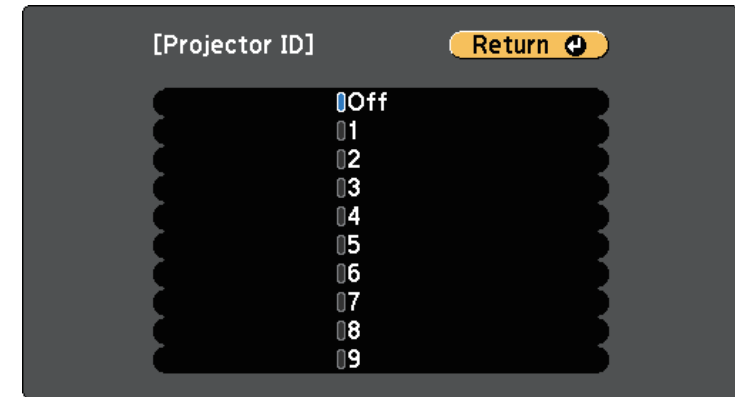

- 4** Press [Menu] or [Esc] to exit the menus.
- 5** Repeat these steps for all the other projectors you want to operate from one remote control.

Selecting the Projector You want to Operate

After setting the projector's ID, select the ID for the projector you want to operate using the remote control.

- 1** Aim the remote control at the target projector and press the [ID] button.

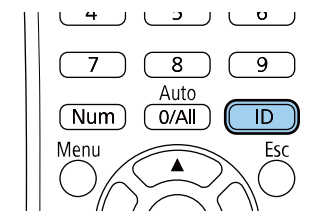

The current Projector ID is displayed on the projected screen. It disappears after about 3 seconds.

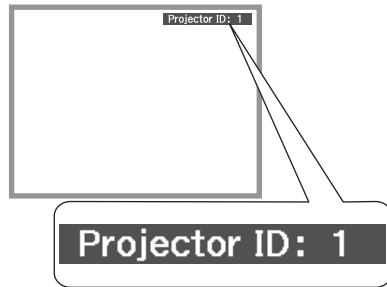

- When you select [0/All] on the remote control, you can operate all projectors regardless the **Projector ID** setting.
- When you set the **Projector ID** setting to **Off**, you can operate the projector using the remote control whichever ID you select on the remote control.
- The projector ID setting is saved in the remote control. Even if the remote control batteries are removed to replace them and so on, the saved ID setting is retained. However, if the batteries are left out of the remote control for an extended period, the ID returns to its default setting (0/All).
- When you use multiple remote controls at the same time, you may not be able to operate projectors as intended due to infrared interference.

- 2** While holding the [ID] button, press the number button that matches the ID of the projector you want to operate.

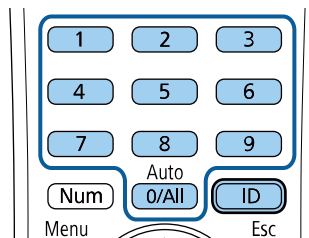

The projector you want to operate is selected.

Matching Multiple-Projector Display Quality

You can match the display quality of multiple projectors that will project next to each other.

- 1** Turn on all the projectors on which you want to match the display quality.
- 2** Set ID numbers on each projector.
- 3** Make sure all the projectors are using the same Color Mode setting.
- 4** Select the remote control ID to match the first projector.

- 5** Press the [Menu] button, select the **Image** menu, and press [Enter].

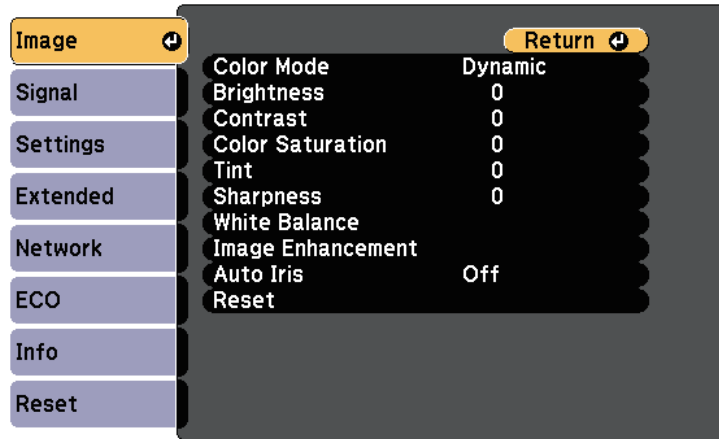

- 6** Select settings as necessary.
- 7** Select the remote control ID to match the next projector, then repeat Image menu adjustments as necessary to match the projectors' displays.

You can secure your projector to deter theft or prevent unintended use by setting up the following security features:

- **Password security** to prevent people who do not know the password from using the projector, and prevent changes to the startup screen and other settings.
This acts as an anti-theft function as the projector cannot be used even if it is stolen, and you can limit who can use the projector.
- **Button lock security** to block operation of the projector using the buttons on the control panel.
This is useful at events or shows when you want to deactivate all buttons during projection or at schools when you want to limit button operation.
- **Security cabling** to physically secure the projector in place.

► Related Links

- "Password Security Types" [p.82](#)
- "Locking the Projector's Buttons" [p.84](#)
- "Installing a Security Cable" [p.85](#)

Password Security Types

You can set up the following types of password security using one shared password:

- **Power On Protection** password prevents anyone from using the projector without first entering a password. When plugging the power cord and turning on the projector at first time, you must enter the correct password. This also applies to **Direct Power On** and **Auto Power On**.
- **User's Logo Protection** password prevents anyone from changing the custom screen displayed when the projector turns on, when no signal is being input, or when you use the A/V Mute feature. The custom screen discourages theft by identifying the projector's owner.
- **Network Protection** password prevents anyone from changing the projector's **Network** settings.
- **Schedule Protection** password prevents anyone from changing the projector's schedule settings.

- **Screen Mirroring Protec.** password prevents anyone from changing the projector's Screen Mirroring settings.

► Related Links

- "Setting a Password" [p.82](#)
- "Selecting Password Security Types" [p.83](#)
- "Entering a Password to Use the Projector" [p.84](#)
- "List of Functions" [p.10](#)

Setting a Password

To use password security, you must set a password.



The default password is set to "0000". Change this to your own password.

1

Hold down the [Freeze] button on the remote control for about 5 seconds.

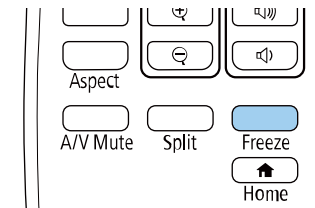

You see the Password Protection setting menu.



If Password Protection is already activated, you must enter the correct password to display the Password Protection setting menu.

- 2 Select **Password** and press [Enter].

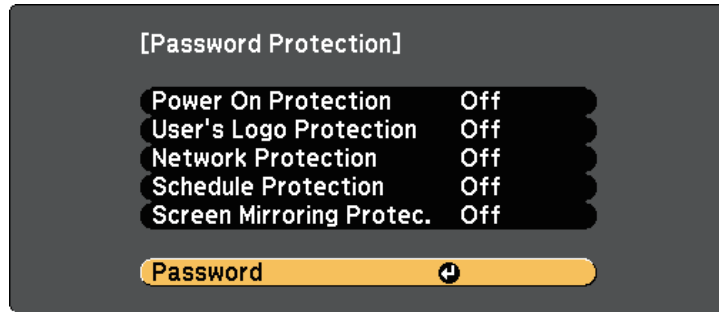

You see the prompt "Change the password?".

- 3 Select **Yes** and press [Enter].

 If you select **No**, the Password Protection setting menu is displayed again.

- 4 Hold down the [Num] button on the remote control and use the numeric buttons to set a four-digit password.

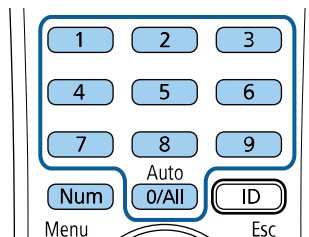

The password displays as **** as it is entered. A confirmation prompt is displayed when you enter the fourth digit.

- 5 Enter the password again.

You see the message "Password accepted". If you enter the password incorrectly, a message is displayed prompting you to re-enter the password.

- 6 Press [Esc] to return to the menu.
- 7 Make a note of the password and keep it in a safe place.

Selecting Password Security Types

After setting a password, you see this menu, allowing you to select the password security types you want to use.

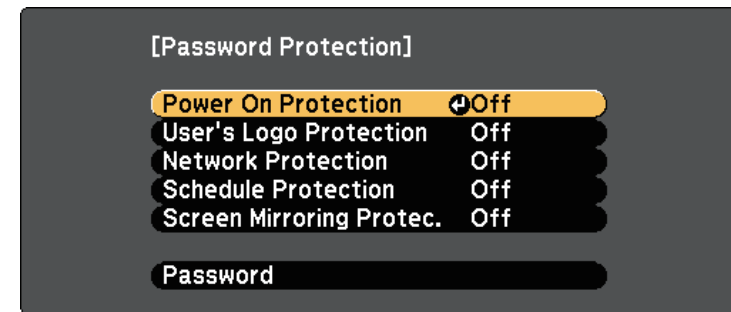

If you do not see this menu, hold down the [Freeze] button on the remote control for 5 seconds until the menu appears.

- To prevent unauthorized use of the projector, select **On** as the **Power On Protection** setting.
- To prevent changes to the User's Logo screen or related display settings, select **On** as the **User's Logo Protection** setting.
- To prevent changes to network settings, select **On** as the **Network Protection** setting.
- To prevent changes to the projector's schedule settings, select **On** as the **Schedule Protection** setting.
- To prevent changes to the projector's Screen Mirroring settings, select **On** as the **Screen Mirroring Protec.** setting.

You can attach the password protect sticker to the projector as an additional theft deterrent.



Be sure to keep the remote control in a safe place; if you lose it, you will not be able to enter the password.

Entering a Password to Use the Projector

When the password screen is displayed, enter the correct password.

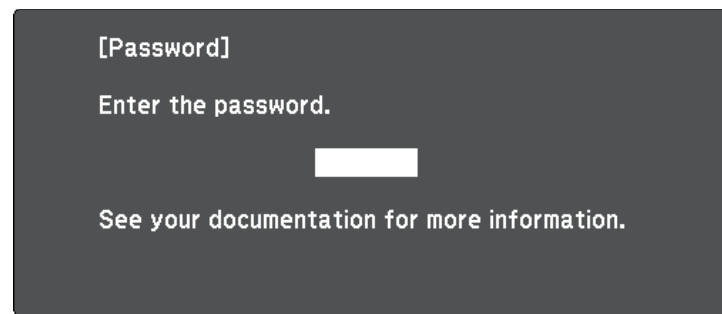

- 1 Hold down the [Num] button on the remote control while you enter the password using the numeric buttons.

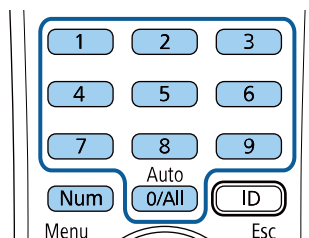

The password screen closes.

- 2 If the password is incorrect, you see a message and a prompt to try again. Enter the correct password to proceed.

Attention

- If an incorrect password is entered three times in succession, the message "The projector's operation will be locked." is displayed for approximately 5 minutes, and the projector switches to standby mode. If this happens, disconnect the power plug from the electrical outlet, reinsert it, and turn the projector back on. The projector displays the password entry screen again so that you can enter the correct password.
- If you have forgotten the password, make a note of the "Request Code: xxxxx" number that appears on the screen and contact Epson for help.
- If you continue to repeat the above operation and input the wrong password 30 times in succession, the message "The projector's operation will be locked. Contact Epson as described in your documentation." is displayed and the projector does not accept any more password entries. Contact Epson for help.

Locking the Projector's Buttons

You can lock the buttons on the control panel to prevent anyone from using the projector. The projector can still be operated using the remote control.

- 1 Press the [Menu] button on the control panel or remote control.

- 2 Select the **Settings** menu and press [Enter].

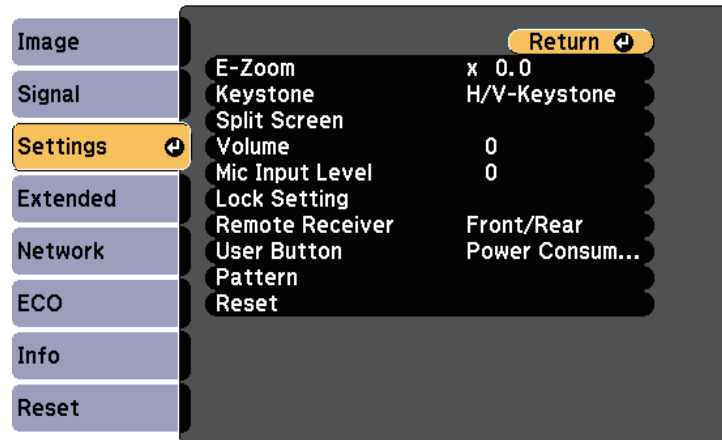

- 3 Select **Lock Setting > Control Panel Lock**, and press [Enter].

- 4 Select one of these lock types and press [Enter]:

- To lock all of the projector's buttons, select **Full Lock**.
- To lock all buttons except the power button, select **Partial Lock**.

You see a confirmation prompt.

- 5 Select **Yes** and press [Enter].

The **Control Panel Lock** setting takes effect.

» Related Links

- "Unlocking the Projector's Buttons" [p.85](#)

Unlocking the Projector's Buttons

If the projector's buttons have been locked, do one of the following to unlock them.

- Hold down the [Enter] button on the control panel for 7 seconds. A message is displayed and the lock is released.

- Select **Off** as the **Control Panel Lock** setting in the projector's **Settings** menu.

» **Settings > Lock Setting > Control Panel Lock**

» Related Links

- "Projector Feature Settings - Settings Menu" [p.132](#)

Installing a Security Cable

You can install the security cable on the projector to deter theft.

- Use the security slot on the projector to attach a Kensington Microsaver Security system.



For more details on the Microsaver Security System, visit the Kensington Web site.

<https://www.kensington.com/>

- Use the security cable attachment point on the projector to attach a wire cable and secure it to a room fixture or heavy furniture.

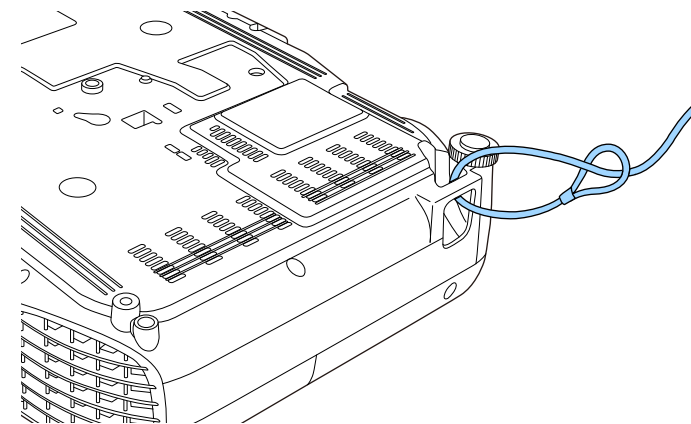



You can use a commercially available theft-prevention wire lock. See the documentation supplied with the wire lock for locking instructions.

Using the Projector on a Network

Follow the instructions in these sections to set up your projector for use on a network.

► Related Links

- "Wired Network Projection" [p.88](#)
- "Wireless Network Projection" [p.91](#)
- "Wireless Network Projection from a Mobile Device (Screen Mirroring)" [p.99](#)
- "Secure HTTP" [p.104](#)

You can send images to your projector through a wired network. To do this, connect the projector to your network, and then set up your projector and computer for network projection.

After connecting and setting up the projector as described here, download and install Epson iProjection (Windows/Mac) from the following Web site.

epson.com/support/

Epson iProjection software sets up your computer for network projection. It also allows you to hold interactive meetings by projecting user's computer screens over a network. See the *Epson iProjection Operation Guide (Windows/Mac)* for instructions.

► Related Links

- "Connecting to a Wired Network" [p.88](#)
- "Selecting Wired Network Settings" [p.88](#)
- "List of Functions" [p.10](#)

Connecting to a Wired Network

To connect the projector to a wired local area network (LAN), use a 100Base-TX or 10Base-T network cable. To ensure proper data transmission, use a Category 5 shielded cable or better.

- 1** Connect one end of the network cable to your network hub, switch, or router.

- 2** Connect the other end of the cable to the projector's LAN port.

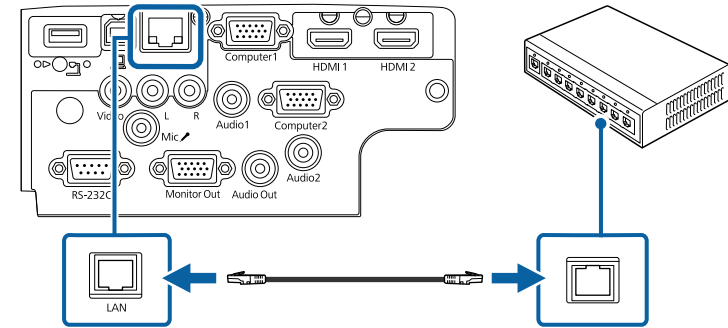

► Related Links

- "List of Functions" [p.10](#)

Selecting Wired Network Settings

Before you can project from computers on your network, you need to select network settings on the projector.



Make sure you already connected the projector to your wired network using the LAN port.

1 Press the [Menu] button, select the **Network** menu, and press [Enter].

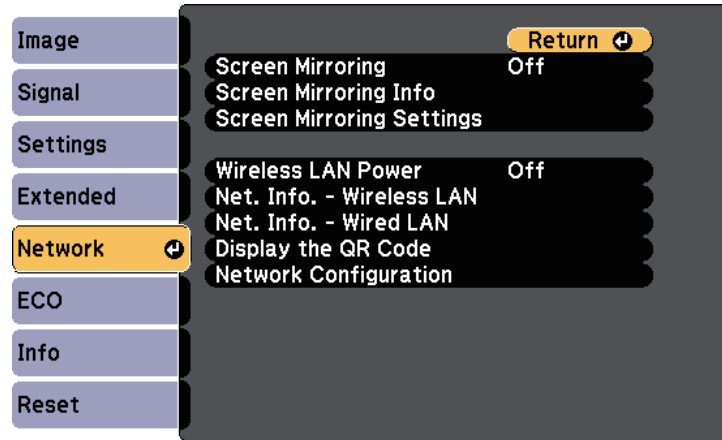

2 Select **Network Configuration** and press [Enter].

3 Select the **Basic** menu and press [Enter].

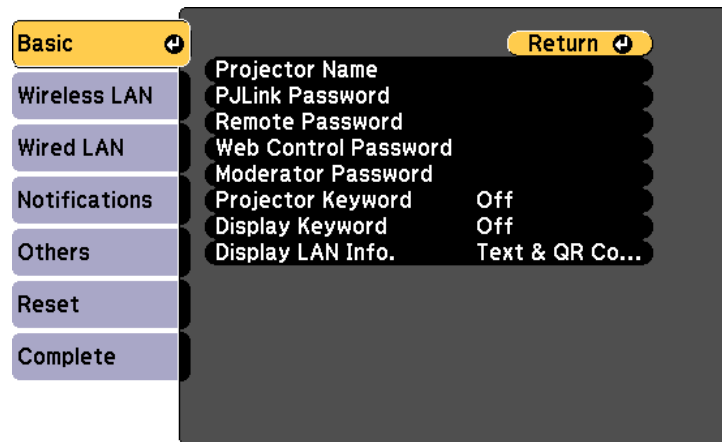

4 Select the basic options as necessary.

- **Projector Name** lets you enter a name up to 16 alphanumeric characters long to identify the projector over the network.
- **PJLink Password** lets you enter a password up to 32 alphanumeric characters long for using the PJLink protocol for projector control.
- **Remote Password** lets you enter a password up to 8 alphanumeric characters long for accessing the projector using the Basic Control. (User name is **EPSONREMOTE**; default password is **guest**.)
- **Web Control Password** lets you enter a password up to 8 alphanumeric characters long for accessing the projector over the Web. (User name is **EPSONWEB**; default password is **admin**.)
- **Moderator Password** lets you enter a four-digit number password for accessing the projector as a moderator using Epson iProjection. (No password is set by default.)
- **Projector Keyword** lets you turn on a security password to prevent access to the projector by anyone not in the room with it. You must enter a displayed, randomized keyword from a computer using Epson iProjection to access the projector and share the current screen.
- **Display Keyword** lets you select whether to display a projector keyword on the projected image when accessing the projector using Epson iProjection.
- **Display LAN Info.** lets you set the display format for the projector's network information.



Use the displayed keyboard to enter numbers and characters. Press the arrow buttons on the remote control to highlight characters and press [Enter] to select them.

5 Select the **Wired LAN** menu and press [Enter].

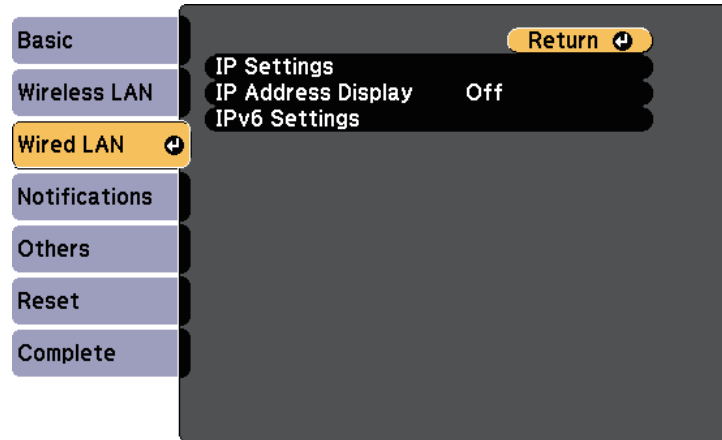

6 Assign the IP settings for your network as necessary.

- If your network assigns addresses automatically, select **IP Settings** to set the **DHCP** setting to **On**.
- If you must set addresses manually, select **IP Settings** to set the **DHCP** setting to **Off**, and then enter the projector's **IP Address**, **Subnet Mask**, and **Gateway Address** as necessary.
- If you want to connect the projector to the network using IPv6, select **IPv6 Settings** to set the **IPv6** setting to **On**, and then set the **Auto Configuration** and **Use Temporary Address** settings as necessary.



To highlight the numbers you want from the displayed keyboard, press the arrow buttons on the remote control. To select a highlighted number, press [Enter].

7 To prevent the IP address from being displayed on the LAN standby screen and Home screen, set the **IP Address Display** setting to **Off**.

8 When you finish selecting settings, select **Complete** and follow the on-screen instructions to save your settings and exit the menus.

9 Press the [LAN] button on the remote control.

The wired network settings complete when you see the correct IP address on the LAN standby screen.

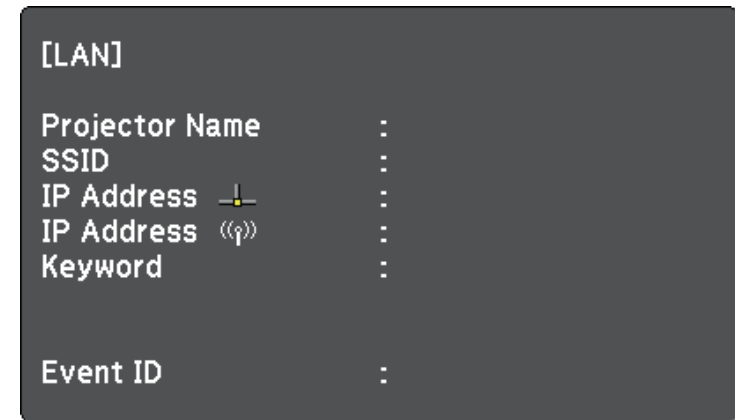

You can send images to your projector through a wireless network.

- To do this, you must install the Epson 802.11b/g/n wireless LAN module, and then set up your projector and computer for wireless projection.
- Some models have built-in wireless LAN modules. You don't need to install the Epson 802.11b/g/n wireless LAN module.

You can connect the projector to your wireless network by configuring the connection manually using the projector's **Network** menus.

After installing the wireless LAN module and setting up the projector, download and install the necessary network software. Use the following software and documentation to set up and control wireless projection.

- Epson iProjection (Windows/Mac) software allows you to hold interactive meetings by projecting the computer screens of users over a network. See the *Epson iProjection Operation Guide (Windows/Mac)* for instructions.
- Epson iProjection (iOS/Android) app allows you to project from iOS or Android devices.

You can download Epson iProjection from the App Store or Google Play. Any fees incurred when communicating with the App Store or Google Play are the responsibility of the customer.

- Epson iProjection (Chromebook) app allows you to project from Chromebook devices.

You can download Epson iProjection from the Chrome Web Store. Any fees incurred when communicating with the Chrome Web Store are the responsibility of the customer.

» Related Links

- "Installing the Wireless LAN Module" [p.91](#)
- "Selecting Wireless Network Settings Manually" [p.92](#)
- "Selecting Wireless Network Settings in Windows" [p.94](#)
- "Selecting Wireless Network Settings in Mac" [p.95](#)
- "Setting Up Wireless Network Security" [p.95](#)
- "Using a QR Code to Connect a Mobile Device" [p.97](#)
- "Using a USB Key to Connect a Windows Computer" [p.98](#)
- "List of Functions" [p.10](#)

Installing the Wireless LAN Module

To use the projector over a wireless network, install the Epson 802.11b/g/n wireless LAN module. Do not install any other type of wireless LAN module.

Attention

Never remove the module while its indicator is blue or flashing, or while you are projecting wirelessly. This could damage the module or lose data.

- 1 Use a cross-head screwdriver to remove the screw that secures the wireless LAN module cover.

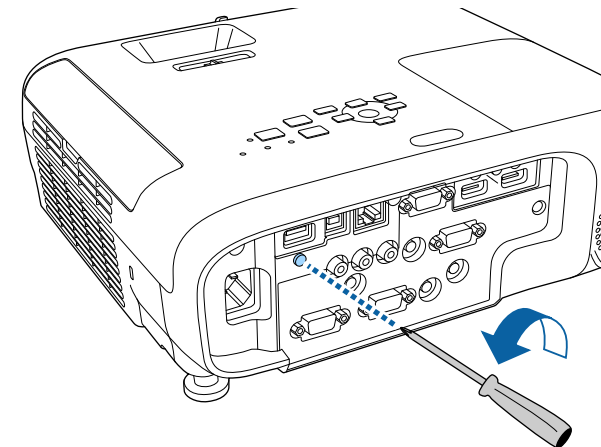

- 2 Connect the wireless LAN module to the USB-A port.

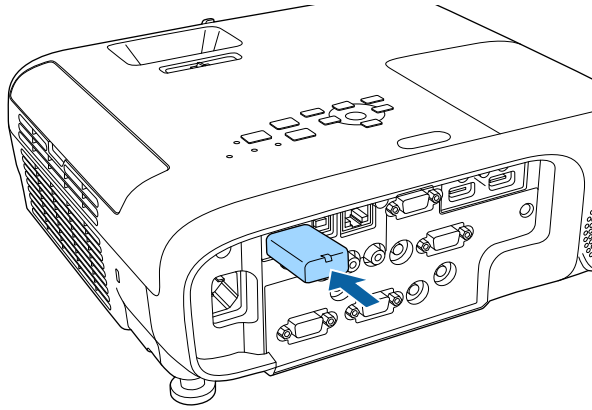

- 3 Attach the wireless LAN module cover, and secure it in place with the screw.

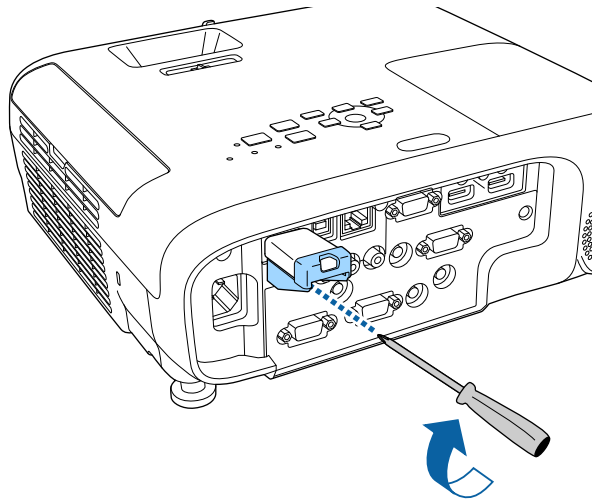

Selecting Wireless Network Settings Manually

Before you can project from your wireless network, you need to select network settings for the projector.

- 1 Press the [Menu] button, select the **Network** menu, and press [Enter].

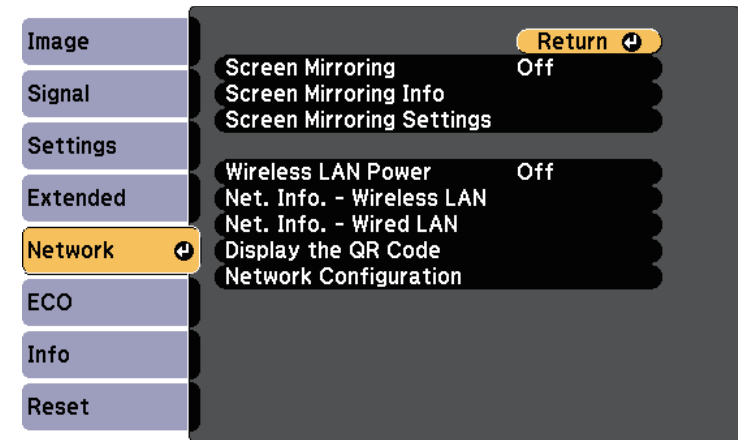

- 2 Select **On** as the **Wireless LAN Power** setting.
- 3 Select **Network Configuration** and press [Enter].

» Related Links

- "List of Functions" p.10

4 Select the **Basic** menu and press [Enter].

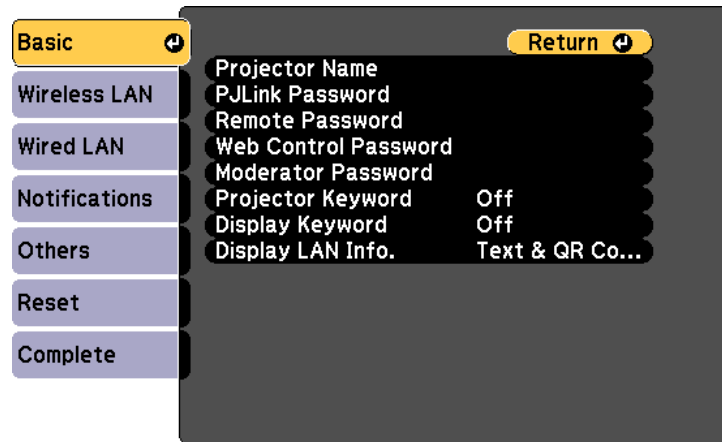

5 Select the basic options as necessary.

- **Projector Name** lets you enter a name up to 16 alphanumeric characters long to identify the projector over the network.
- **PjLink Password** lets you enter a password up to 32 alphanumeric characters long for using the PjLink protocol for projector control.
- **Remote Password** lets you enter a password up to 8 alphanumeric characters long for accessing the projector using the Basic Control. (User name is **EPSONREMOTE**; default password is **guest**.)
- **Web Control Password** lets you enter a password up to 8 alphanumeric characters long for accessing the projector over the Web. (User name is **EPSONWEB**; default password is **admin**.)
- **Moderator Password** lets you enter a four-digit number password for accessing the projector as a moderator using Epson iProjection. (No password is set by default.)
- **Projector Keyword** lets you turn on a security password to prevent access to the projector by anyone not in the room with it. You must enter a displayed, randomized keyword from a computer using Epson iProjection to access the projector and share the current screen.

- **Display Keyword** lets you select whether to display a projector keyword on the projected image when accessing the projector using Epson iProjection.
- **Display LAN Info.** lets you set the display format for the projector's network information.



Use the displayed keyboard to enter numbers and characters. Press the arrow buttons on the remote control to highlight characters and press [Enter] to select them.

6 Select the **Wireless LAN** menu and press [Enter].

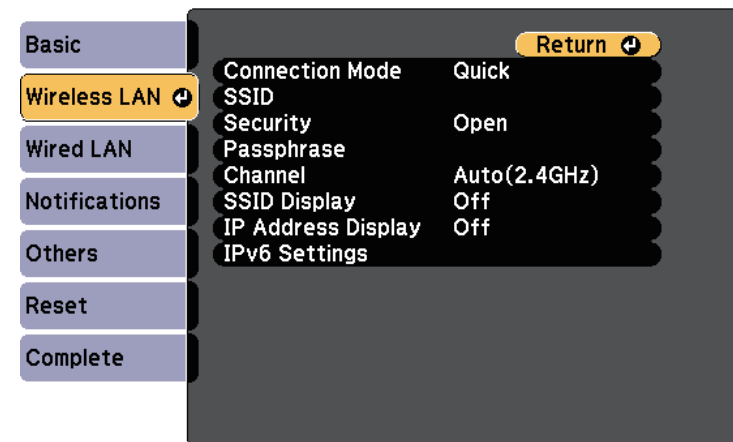

7 Select the **Connection Mode** setting.

- **Quick** lets you connect to multiple smartphones, tablets, or computers directly using wireless communication.
- **Advanced** lets you connect to smartphones, tablets, or computers over a wireless network access point.

8 If you selected the **Advanced** connection mode, select **Search Access Point** to select the access point you want to connect to.



If you need to assign the SSID manually, select **SSID** to enter the SSID.

- 9** For the **Advanced** connection mode, assign the IP settings for your network as necessary.
 - If your network assigns addresses automatically, select **IP Settings** to set the **DHCP** setting to **On**.
 - If you must set addresses manually, select **IP Settings** to set the **DHCP** setting to **Off**, and then enter the projector's **IP Address**, **Subnet Mask**, and **Gateway Address** as necessary.
 - If you want to connect the projector to the network using IPv6, select **IPv6 Settings** to set the **IPv6** setting to **On**, and then set the **Auto Configuration** and **Use Temporary Address** settings as necessary.
- 10** To prevent the SSID or IP address from being displayed on the LAN standby screen and Home screen, set the **SSID Display** setting or the **IP Address Display** setting to **Off**.
- 11** When you finish selecting settings, select **Complete** and follow the on-screen instructions to save your settings and exit the menus.
- 12** Press the [LAN] button on the remote control.

The wireless network settings are complete when you see the correct IP address on the LAN standby screen.

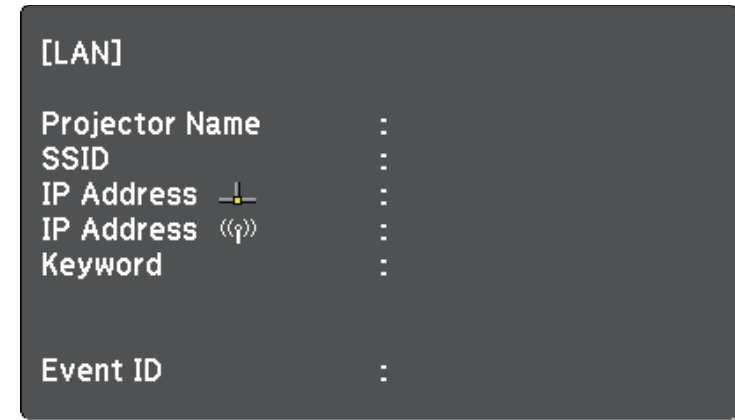

When you have finished making wireless settings for your projector, you need to select the wireless network on your computer. Then start the network software to send images to your projector through a wireless network.

Selecting Wireless Network Settings in Windows

Before connecting to the projector, select the correct wireless network on your computer.

- 1** To access your wireless utility software, click the network icon on the Windows taskbar.
- 2** When connecting in Advanced connection mode, select the network name (SSID) of the network the projector is connecting to.
- 3** Click **Connect**.

Selecting Wireless Network Settings in Mac

Before connecting to the projector, select the correct wireless network in Mac.

- 1** Click the Wi-Fi icon on the menu bar at the top of the screen.
- 2** When connecting in Advanced connection mode, make sure Wi-Fi is turned on and select the network name (SSID) of the network the projector is connecting to.

Setting Up Wireless Network Security

You can set up security for your projector to use on a wireless network. Set up one of the following security options to match the settings used on your network:

- WPA2-PSK security
- WPA3-PSK security *
- WPA2/WPA3-PSK security *
- WPA3-EAP security *
- WPA2/WPA3-EAP security *

* Available only for the Advanced connection mode.



Contact your network administrator for guidance on entering the correct information.

- 1** If you want to set up the WPA3-EAP or WPA2/WPA3-EAP security, make sure your digital certificate file is compatible with projector registration and placed directly on the USB storage device.
- 2** Press the [Menu] button, select the **Network** menu, and press [Enter].
- 3** Select **Network Configuration** and press [Enter].

- 4** Select the **Wireless LAN** menu and press [Enter].

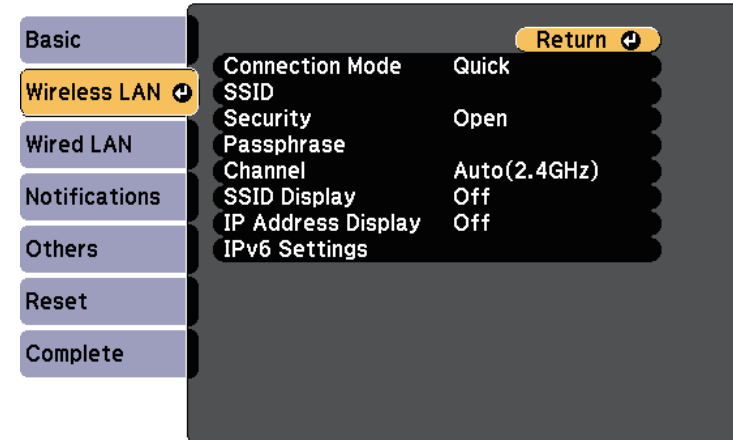

- 5** Select the **Security** setting and press [Enter].

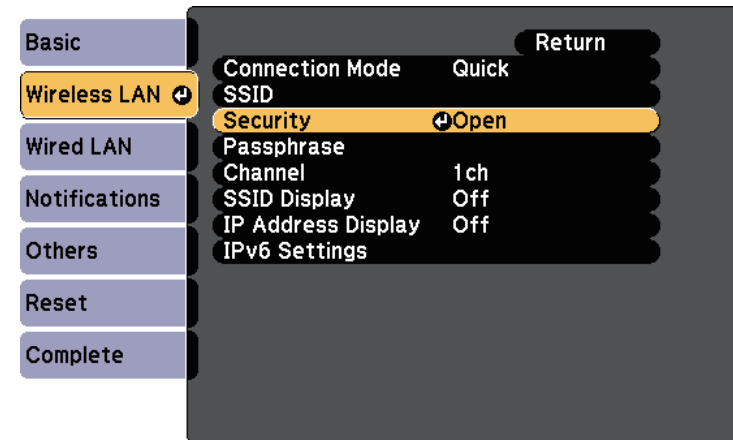

- 6** Select the security settings to match your network settings.

- 7** Do one of the following according to the security you selected.
- **WPA3-PSK** or **WPA2/WPA3-PSK**: Select **Passphrase**, press [Enter], and enter a passphrase from 8 to 63 characters long. To enter more than 32 characters, use your Web browser. Then go to step 16.
 - **WPA3-EAP** or **WPA2/WPA3-EAP**: Select **EAP Method** and press [Enter].

- 8** Select the protocol for authentication as the **EAP Type** setting.

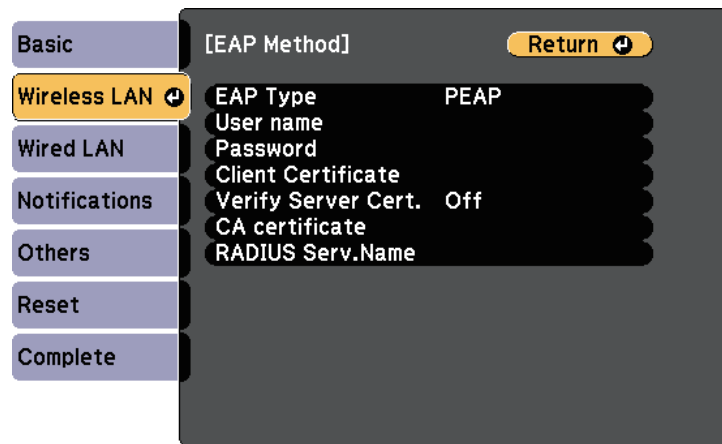

- 9** To import your certificate, select the certificate type and press [Enter].
- **Client Certificate** for the **PEAP-TLS** or **EAP-TLS** type
 - **CA certificate** for all EAP types

 You can also register the digital certificates from your Web browser. However, be sure to register just once or the certificate may not install correctly.

- 10** Select **Register** and press [Enter].
- 11** Follow the on-screen instructions to connect a USB storage device to the projector's USB-A port.

- 12** Press [Enter] to display the certificate list.

- 13** Select the certificate to import using the displayed list.
A message is displayed prompting you to enter the password for the certificate.

- 14** Enter a password and press [Enter].
The certificate is imported and a completion message appears.

- 15** Select your EAP settings as necessary.
- **User name** lets you enter a user name using up to 64 alphanumeric characters. To enter more than 32 characters, use your Web browser. When importing a client certificate, the name the certificate was issued to is automatically set.
 - **Password** lets you enter a password using up to 64 alphanumeric characters for authentication when using the **PEAP** or **EAP-FAST** type. To enter more than 32 characters, use your Web browser.
 - **Verify Server Cert.** lets you select whether or not to verify the server certificate when a CA certificate has been set.
 - **RADIUS Serv.Name** lets you enter the server name to be verified.

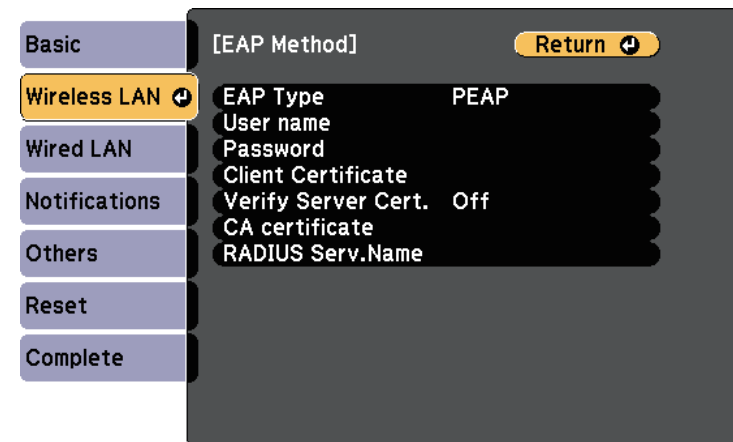

16 When you have finished making settings, select **Complete** and follow the on-screen instructions to save your settings and exit the menus.

» **Related Links**

- "Supported Client and CA Certificates" p.97
- "Network Menu - Wireless LAN Menu" p.140

Supported Client and CA Certificates

You can register these types of digital certificates.

Client Certificate (PEAP-TLS/EAP-TLS)

Specification	Description
Format	PKCS#12
Extension	PFX, P12
Encryption	RSA
Hashes	MD5/SHA-1/SHA-256/SHA-384/SHA-512
Key length	512/1024/2048/4096 bit
Password *	Up to 64 alphanumeric characters; required

CA Certificate (PEAP/PEAP-TLS/EAP-TLS/EAP-FAST)

Specification	Description
Format	X509v3
Extension	DER/CER/PEM
Encryption	RSA
Hashes	MD5/SHA-1/SHA-256/SHA-384/SHA-512
Key length	512/1024/2048/4096 bit
Encoding	BASE64/Binary

* You can set a password using up to 64 alphanumeric characters. However, you need to use your Web browser to enter more than 32 characters.

Using a QR Code to Connect a Mobile Device

After selecting the wireless network settings for your projector, you can display a QR code on the screen and use it to connect a mobile device using the Epson iProjection (iOS/Android) app.



- Make sure you have installed the latest version of Epson iProjection on your device.
- You can download Epson iProjection for free from the App Store or Google Play. Any fees incurred when communicating with the App Store or Google Play are the responsibility of the customer.
- When using Epson iProjection in Quick connection mode, we recommend making security settings.

1 Press the [LAN] button on the remote control.
The QR code is displayed on the projected surface.



- If you do not see the QR code, set the **Display LAN Info.** setting to **Text & QR Code** in the projector's **Network** menu.
 🖱️ **Network > Network Configuration > Basic > Display LAN Info.**
- To hide the QR code, press [Esc].
- When the QR code is hidden, press [Enter] to display the code.

2 Start Epson iProjection on your mobile device.

3 Read the projected QR code using Epson iProjection to connect it to the projector.



To correctly read the QR code, make sure you face the screen squarely and closely enough so that the projected code fits into the guide of the mobile device's QR code reader. If you are too far from the screen, the code may not be read.

When a connection is established, select **Contents** menu from , and then select the file you want to project.

Using a USB Key to Connect a Windows Computer

You can set up your USB flash drive as a USB key to quickly connect the projector to a wireless LAN supported Windows computer. After creating the USB key, you can quickly project images from the network projector.

- 1 Set up the USB key using Epson iProjection (Windows/Mac) software.



See the *Epson iProjection Operation Guide (Windows/Mac)* for instructions.

- 2 Make sure the wireless LAN module is installed or built into your projector.

- 3 Turn on the projector.

- 4 Press the [LAN] button on the remote control.

The LAN standby screen is displayed. Verify that an SSID and IP address are displayed.

- 5 Do one of the following to connect the USB key.

- Connect the USB key to the projector's USB-A port. (Models with a built-in wireless LAN module.)
- Remove the wireless LAN module from the projector and insert the USB key into the same port used for the wireless LAN module. (Models with the optional wireless LAN module installed.)

You see a projected message that the network information update is complete.

- 6 Remove the USB key.

If your projector needs the wireless LAN module, reinsert the wireless LAN module into the projector. (Models with the optional wireless LAN module installed.)

- 7 Connect the USB key to a USB port on your computer.

- 8 Follow the on-screen instructions to install the necessary application.



- If the Windows Firewall message is displayed, click **Yes** to disable the firewall.
- You need administrator authority to install the software.
- If it is not installed automatically, double-click **MPPLaunch.exe** in the USB key.

After a few minutes, your computer image is displayed by the projector.

- 9 When you have finished projecting wirelessly, select the **Safely Remove Hardware** option in the Windows taskbar, and then remove the USB key from your computer.



You may need to restart your computer to reactivate your wireless LAN connection.

You can send image to your projector from mobile devices such as laptops, smartphones, and tablets using Miracast technology.

If your device supports Miracast, you do not need to install any additional software. When using a Windows computer, make sure the necessary adapter for the Miracast connection is available.

Note the following limitations when using Screen Mirroring features.

- You cannot play an interlaced image.
- You cannot play multi-channel audio over 3ch (channel 3).
- You cannot project images with a resolution above 1920 × 1080 and a frame rate above 30 fps.
- You cannot play 3D video.
- You may not be able to view contents with copyright protection with a Miracast connection depending on your device.
- Do not change the projector's Screen Mirroring Settings during Screen Mirroring projection. Doing so may cause the projector to disconnect and it may take a while to re-connect.

☛ Network > Screen Mirroring Settings

- Do not turn off the projector directly by the breaker during Screen Mirroring projection.



Mobile devices with Android installed or Windows 8.1 or later installed mainly support Miracast.
Support for Miracast varies depending on the mobile device. See your mobile device manual for details.

» Related Links

- "Selecting Screen Mirroring Settings" [p.99](#)
- "Connecting Using Screen Mirroring with the Miracast Function" [p.101](#)
- "List of Functions" [p.10](#)

Selecting Screen Mirroring Settings

You must select Screen Mirroring settings for your projector to project images from your mobile device.



If you set a **Screen Mirroring Protec.** password, turn off your **Screen Mirroring Protec.** password first.

- 1 Press the [Menu] button, select the **Network** menu, and press [Enter].

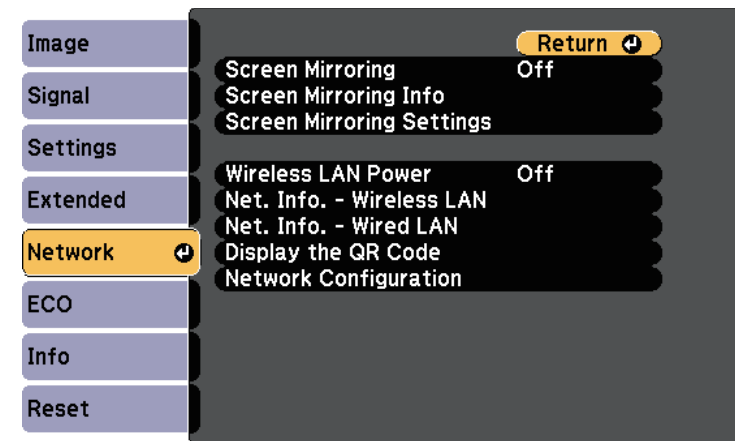

2 Select **On** as the **Screen Mirroring** setting.

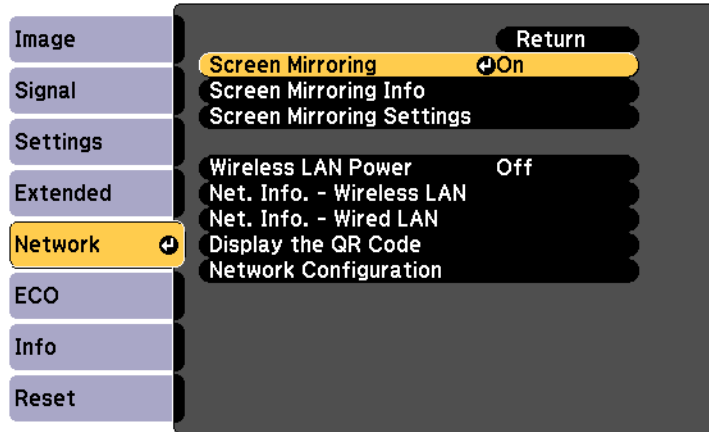

3 Select **Screen Mirroring Settings** and press [Enter].

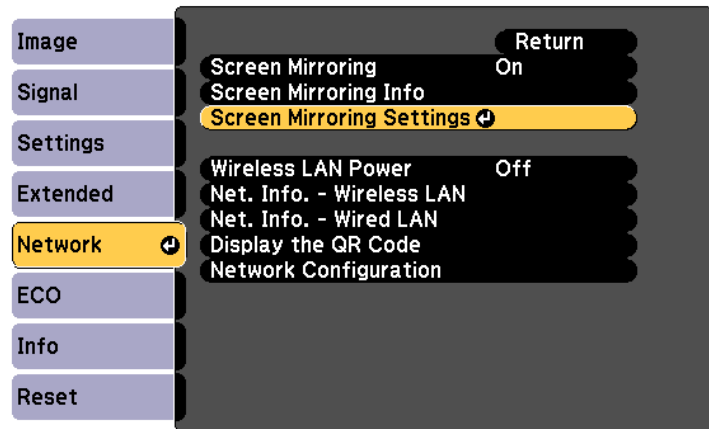

4 Set the **Display Name** setting as necessary.

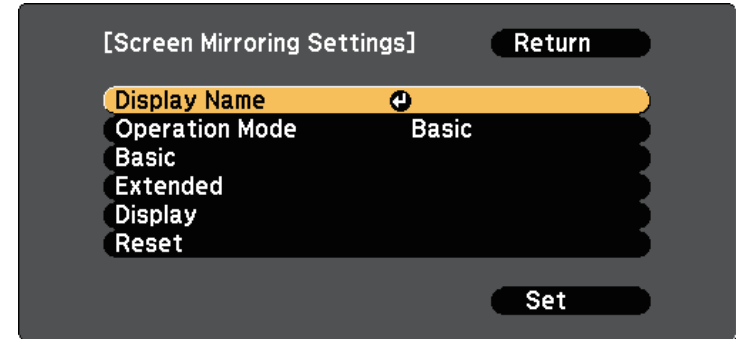

5 Select the **Operation Mode** setting.

- **Basic** lets you connect with basic options.
- **Extended** lets you connect with advanced options.

6 Select the **Basic** setting as necessary.

- **Wireless LAN Sys.** lets you select the type of wireless LAN system the projector is connecting to.
- **Adjust Image Quality** lets you adjust the screen mirroring speed/quality. Select a small number to improve the quality and select large number to increase the speed.
- **Connection Mode** lets you select the security type. Available only for the **Basic** operation mode.

7 For the **Extended** operation mode, select the **Extended** setting.

- **Meeting Mode** lets you select the type of meeting. Select **Interruptions OK** to connect to another mobile device during Screen Mirroring projection or **No Interruptions** to exclusively connect to one device.
- **Channel** lets you select the wireless channel used by Screen Mirroring.

- 8** Select the **Display** setting as necessary.
 - **Display PIN Code** lets you display the PIN code on the projected image while projecting input sources other than Screen Mirroring.
 - **Display Device Name** lets you display the newly connected device name on the projected image while projecting input sources other than Screen Mirroring.
- 9** When you finish selecting settings, select **Set** and follow the on-screen instructions to save your settings and exit the menus.
- 10** Press the [Home] button on the remote control. The settings are complete when you see the Display Name on the Home screen.

Connecting Using Screen Mirroring with the Miracast Function

If your mobile device such as a smartphone supports Miracast, you can connect it to the projector wirelessly and project images. You can play audio through the projector's speaker system by connecting using Screen Mirroring.

- 1** Select **Screen Mirroring Settings** on your projector as necessary.
- 2** Press the [LAN] button on the remote control to switch to the Screen Mirroring source.
You see the Screen Mirroring standby screen.
- 3** On your mobile device, use your Miracast function to search for the projector.
You see a list of available devices.
- 4** Select the projector's Display Name from the list.
- 5** If you see the PIN entry screen on your mobile device, enter the PIN code displayed on the Screen Mirroring standby screen or at the bottom right of the projected image.

The projector displays the image from your mobile device.



It may take some time until the connection is established. While connecting, do not disconnect the projector's power cord. Doing so may cause your device to freeze or malfunction.

Depending on the mobile device, you may need to delete a device when connecting. Follow the on-screen instructions on your device.

► Related Links

- "Connecting Using Screen Mirroring in Windows 10" [p.101](#)
- "Connecting Using Screen Mirroring in Windows 8.1" [p.102](#)

Connecting Using Screen Mirroring in Windows 10

You can set up your computer for wireless projection and play audio through the projector's speaker system by connecting using Screen Mirroring.

- 1** Select **Screen Mirroring Settings** on your projector as necessary.
- 2** Press the [LAN] button on the remote control to switch to the Screen Mirroring source.
You see the Screen Mirroring standby screen.

- 3 Display **Action Center**, and then select **Connect**.

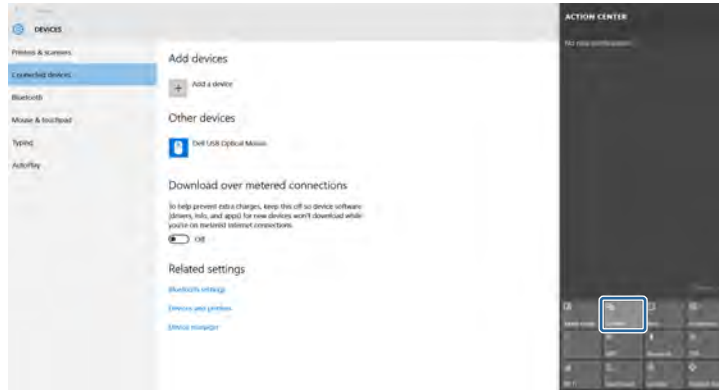

You see a list of available devices.

- 4 Select the projector's Display Name from the list.

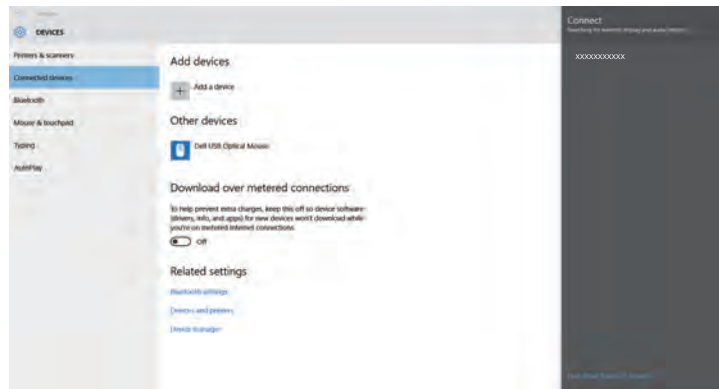

- 5 If you see the PIN entry screen on your computer, enter the PIN code displayed on the Screen Mirroring standby screen or at the bottom right of the projected image.

The projector displays the image from your computer.



It may take some time until the connection is established. While connecting, do not disconnect the projector's power cord. Doing so may cause your device to freeze or malfunction.

Connecting Using Screen Mirroring in Windows 8.1

You can set up your computer for wireless projection from Charms in Windows 8.1. You can play audio through the projector's speaker system by connecting using Screen Mirroring.

- 1 Select **Screen Mirroring Settings** on your projector as necessary.
- 2 Press the [LAN] button on the remote control to switch to the Screen Mirroring source.
You see the Screen Mirroring standby screen.
- 3 On your computer, select **Devices** from Charms and select **Project**.

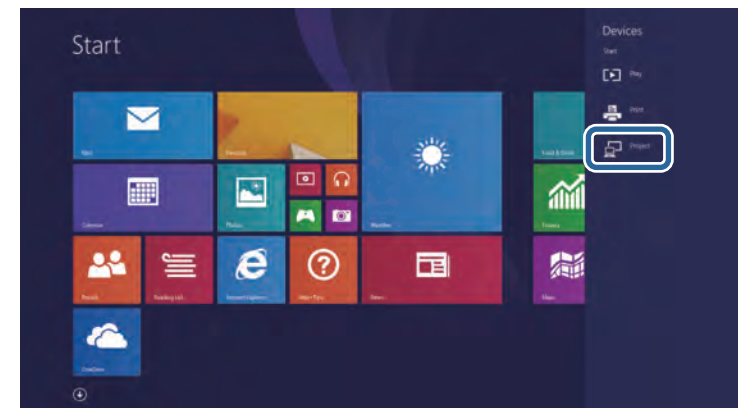

4 Select **Add a wireless display**.

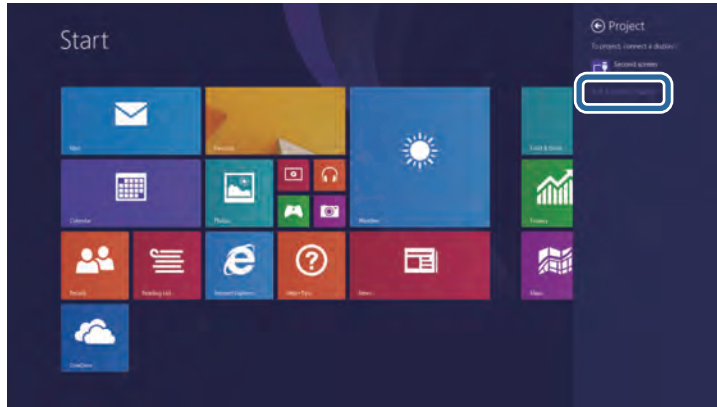

It may take some time until the connection is established. While connecting, do not disconnect the projector's power cord. Doing so may cause your device to freeze or malfunction.

You see a list of available devices.

5 Select the projector's Display Name from the list.

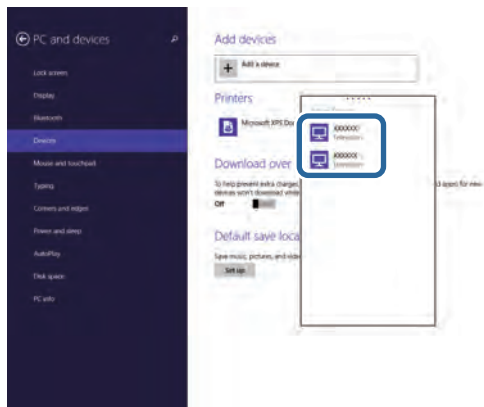

6 If you see the PIN entry screen on your computer, enter the PIN code displayed on the Screen Mirroring standby screen or at the bottom right of the projected image.

The projector displays the image from your computer.

You can use the HTTPS protocol to increase security between the projector and a Web browser communicating with it. To do this, you create a server certificate, install it on the projector, and turn on the **Secure HTTP** setting in the projector menus to verify the reliability of the Web browser.

☛ **Network > Network Configuration > Others > Secure HTTP**

Even if you do not install a server certificate, the projector automatically creates a self-signed certificate and allows communication. However, because the self-signed certificate cannot verify reliability from a Web browser, you see a warning about the server's reliability when you access the projector from a Web browser. This warning does not prevent communication.

» **Related Links**

- "Importing a Web Server Certificate Using the Menus" [p.104](#)
- "List of Functions" [p.10](#)

Importing a Web Server Certificate Using the Menus

You can create your Web server certificate, and import it using the projector menus and a USB flash drive.



You can also register the digital certificates from your Web browser. However, be sure to register just once or the certificate may not install correctly.

- 1** Make sure your digital certificate file is compatible with projector registration and directly placed on the USB storage device.
- 2** Press the [Menu] button, select the **Network** menu, and press [Enter].
- 3** Select **Network Configuration** and press [Enter].

- 4** Select the **Others** menu and press [Enter].

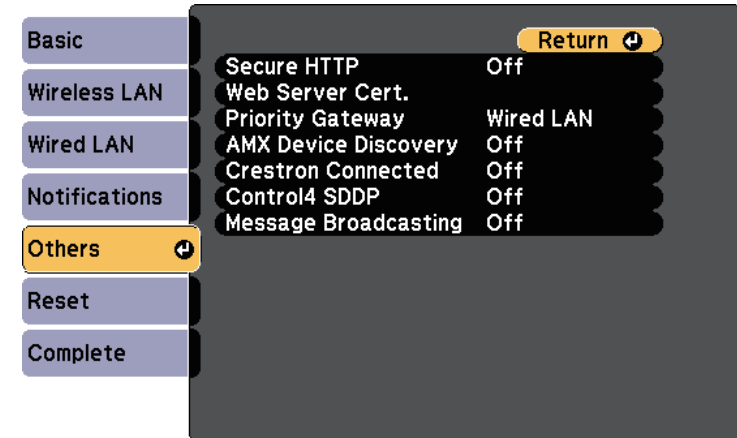

- 5** Set the **Secure HTTP** setting to **On**.
- 6** Select **Web Server Cert.** and press [Enter].
- 7** Select **Register** and press [Enter].
- 8** Follow the on-screen instructions to connect a USB storage device to the projector's USB-A port.
- 9** Press [Enter] to display the certificate list.
- 10** Select the certificate to import using the displayed list.
A message is displayed prompting you to enter the password for the certificate.
- 11** Enter a password and press [Enter].
The certificate is imported and a completion message appears.

» Related Links

- "Supported Web Server Certificates" [p.105](#)

Supported Web Server Certificates

You can register these types of digital certificates.

Web Server Certificate (Secure HTTP)

Specification	Description
Format	PKCS#12
Extension	PFX, P12
Encryption	RSA
Hashes	MD5/SHA-1/SHA-256/SHA-384/SHA-512
Key length	512/1024/2048/4096 bit
Common name	Network host name
Organization	Optional
Password *	Up to 64 alphanumeric characters; required

* You can set a password using up to 64 alphanumeric characters. However, you need to use your Web browser to enter more than 32 characters.

Monitoring and Controlling the Projector

Follow the instructions in these sections to monitor and control the projector over a network.

► Related Links

- "Epson Projector Management" [p.107](#)
- "Controlling a Networked Projector Using a Web Browser" [p.108](#)
- "Registering Digital Certificates from a Web Browser" [p.112](#)
- "Setting Up Projector Network E-Mail Alerts" [p.113](#)
- "Setting Up Monitoring Using SNMP" [p.115](#)
- "Using ESC/VP21 Commands" [p.116](#)
- "PJLink Support" [p.118](#)
- "Crestron Connected Support" [p.119](#)
- "Setting Projector Event Schedules" [p.124](#)

Epson Projector Management software (Windows only) lets you monitor and control your projector through the network. See the *Epson Projector Management Operation Guide* for instructions.

You can download Epson Projector Management from the following Web site.

epson.com/support/

► **Related Links**

- "List of Functions" [p.10](#)

Once you have connected your projector to your network, you can select projector settings and control projection using a compatible Web browser. This lets you access the projector remotely.



- Make sure the computer and projector are connected to the network. When projecting images using a wireless LAN, connect in **Advanced** connection mode.
- You can use the following Web browsers.
 - Internet Explorer 11 or later (Windows)
 - Microsoft Edge (Windows)
 - Safari (Mac, iOS)
 - Chrome (Android)
- While using the Web browser, do not connect using a proxy server. You cannot select all of the projector menu settings or control all projector functions using a Web browser.
- If you set **Standby Mode** to **Communication On**, you can use a Web browser to select settings and control projection even if the projector is in standby mode (when the power is off).
 - **ECO > Standby Mode > Standby Mode**

You see the Epson Web Control screen.

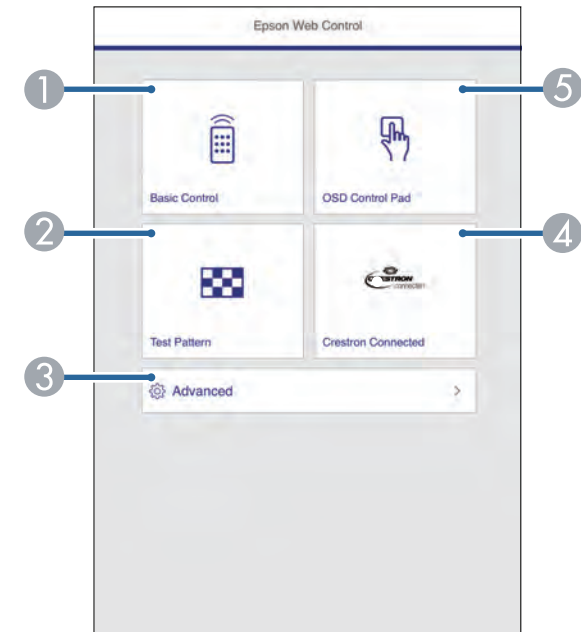

- 1** Make sure the projector is turned on.
- 2** Make sure your computer or device is connected to the same network as the projector.
- 3** Start your Web browser on the computer or device.
- 4** Go to the Epson Web Control screen by entering the projector's IP address into the browser's address box. When entering an IPv6 address, wrap the address with [and].

- 1** Controls the projector remotely.
- 2** Displays a test pattern.
- 3** Sets detailed projector settings.
- 4** Opens the Crestron Connected operation window. Available only when you set the Crestron Connected system.
- 5** Operates the projector's menu settings with your finger or mouse.

- 5** Select the option corresponding to the projector function you want to control.



- You may need to log in to access some of the options on the Epson Web Control screen. If you see a log in window, enter your user name and password.
- When accessing the **Basic Control** option, the user name is **EPSONREMOTE** and the default password is **guest**.
- When accessing other options, the user name is **EPSONWEB** and the default password is **admin**.
- You can change the password in **Web Control Password** in the projector's **Network** menu.
 - ☛ **Network > Network Configuration > Basic > Web Control Password**
- You can only select the following settings from **Advanced**.
 - Monitor Password (up to 16 alphanumeric characters)
 - IPv6 Settings (manual)
 - HTTP port (port number used for Web Control except for 80 [default], 843, 3620, 3621, 3625, 3629, 4352, 4649, 5357, 10000, 10001, 41794)

» Related Links

- "Web Control Options" [p.109](#)
- "Projector Setup Settings - ECO Menu" [p.147](#)
- "Network Menu - Basic Menu" [p.139](#)
- "List of Functions" [p.10](#)

Web Control Options

Basic Control



- If you see a log in window, enter your user name and password. (The user name is **EPSONREMOTE** and the default password is **guest**.)
- You can change the password in **Remote Password** in the projector's **Network** menu.
 - ☛ **Network > Network Configuration > Basic > Remote Password**

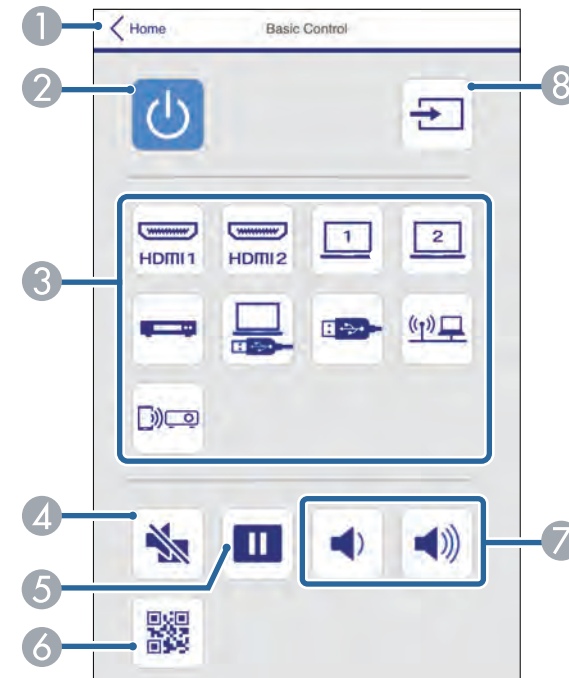

- 1 Returns to the Epson Web Control screen.
- 2 Turns the projector on or off.
- 3 Selects the input source.

- ④ Turns the video and audio on or off temporarily.
- ⑤ Pauses or resumes images.
- ⑥ Displays the QR code.
- ⑦ Adjusts the speaker volume.
- ⑧ Searches for sources.

OSD Control Pad

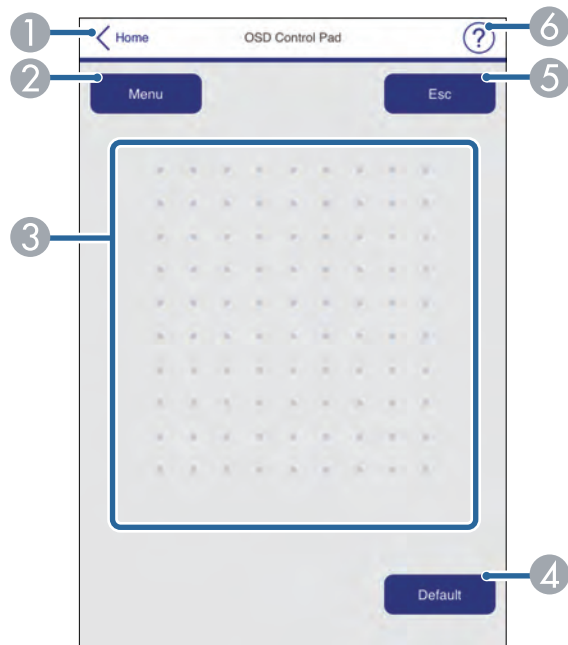

- ① Returns to the Epson Web Control screen.
- ② Displays the projector's setting menus.
- ③ Use your finger or mouse to navigate the menus.
- ④ Resets the selected setting to its default value.
- ⑤ Returns to the previous menu.

- ⑥ Displays help topics.

Test Pattern

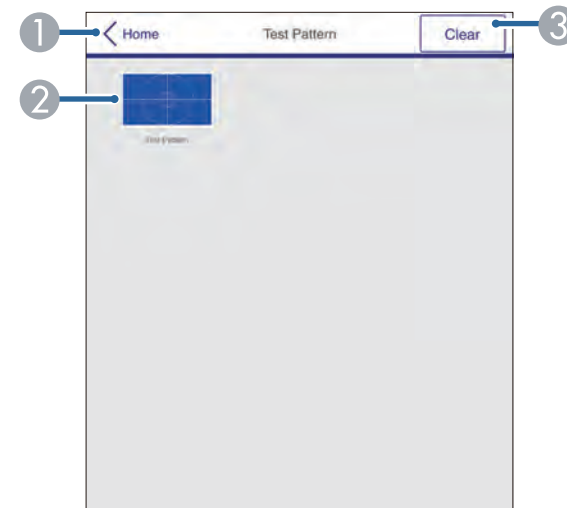

- ① Returns to the Epson Web Control screen.
- ② Displays available test patterns; select to project a test pattern.
- ③ Turns off test pattern display.

Advanced



If the default **Web Control Password** is set, a screen prompting to change the password appears before you can view the Advanced screen. Follow the on-screen instructions to change the password.



You cannot change the following settings using Epson Web Control.

- User Button
- User's Logo
- HDMI EQ Setting
- Language
- Reset Lamp Hours

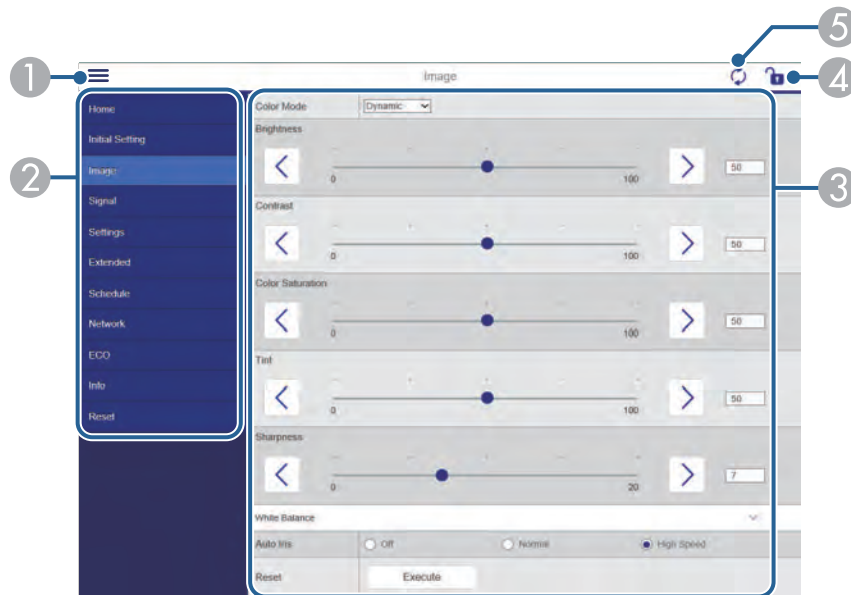

» Related Links

- "List of Functions" [p.10](#)

- 1 Opens the menus.
- 2 Displays the menu name you selected.
- 3 Specifies the projector settings.
- 4 Lock/unlock the projector settings.
- 5 Updates the projector settings.

You can register the digital certificates on the projector to provide security for your presentation files.



You can also register the digital certificates in the projector's **Network** menu. However, be sure to register just once or the certificate may not install correctly.

☛ **Network > Network Configuration > Wireless LAN > EAP Method > Client Certificate**

☛ **Network > Network Configuration > Wireless LAN > EAP Method > CA certificate**

☛ **Network > Network Configuration > Others > Web Server Certificate**

- 1** Make sure your digital certificate file is compatible with projector registration.
- 2** Make sure the projector is turned on.
- 3** Start your Web browser on a computer or device connected to the network.
- 4** Go to the Epson Web Control screen by entering the projector's IP address into the browser's address box.
You see the Epson Web Control screen.
- 5** Select **Advanced**.



- You may need to log in before you see the Advanced screen. If a login screen is displayed, enter your user name and password. (The user name is **EPSONWEB** and the default password is **admin**.)
- You can change the password in **Web Control Password** in the projector's **Network** menu.
☛ **Network > Network Configuration > Basic > Web Control Password**

- 6** Under **Network**, select **Certificate**.
- 7** Select the certificate file you want to register.
- 8** Enter the password in the **Password** box, and then click **Set**.
- 9** When you finish registering the certificate, click **Apply** to finalize your changes and complete the registration.

» Related Links

- "List of Functions" [p.10](#)

You can set up the projector to send you an e-mail alert over the network if there is a problem with the projector.

If you set the **Standby Mode** setting to **Communication On**, you can receive the e-mail alerts even if the projector is in standby mode (when the power is off).

ECO > Standby Mode > Standby Mode

- 1 Press the [Menu] button, select the **Network** menu, and press [Enter].
- 2 Select **Network Configuration** and press [Enter].
- 3 Select the **Notifications** menu and press [Enter].

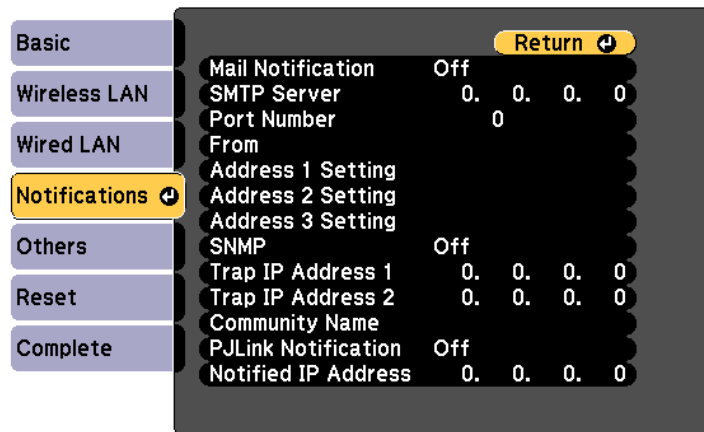

- 4 Set the **Mail Notification** setting to **On**.
- 5 Enter the IP address for the **SMTP Server** option.

 Do not use "127.x.x.x" (where x is a number from 0 to 255) for the **SMTP Server**.

- 6 Select a number for the SMTP server **Port Number**, from 0 to 65535 (default is 25).
- 7 Select a type of **Authentication** of SMTP server.
- 8 Enter a **User Name** for the SMTP server.
- 9 Enter a **Password** for the SMTP server authentication.
- 10 Enter the e-mail address to be indicated as the sender in **From**.
- 11 Choose an address field, enter the e-mail address, and select the alerts you want to receive. Repeat for up to three addresses.

 Your e-mail address can be up to 64 alphanumeric characters long. To enter more than 32 characters, use your Web browser.

- 12 When you finish selecting settings, select **Complete** and follow the on-screen instructions to save your settings and exit the menus.

 If a critical problem causes a projector to shut down, you may not receive an e-mail alert.

» Related Links

- "Network Projector E-mail Alert Messages" [p.113](#)
- "Projector Setup Settings - ECO Menu" [p.147](#)
- "List of Functions" [p.10](#)

Network Projector E-mail Alert Messages

When a problem occurs with a projector on the network, and you selected to receive e-mail alerts, you receive an e-mail containing the following information:

- The email address set in **From** as the mail sender
- **Epson Projector** in the subject line
- The name of the projector experiencing a problem
- The IP address of the affected projector
- Detailed information about the problem

Network administrators can install SNMP (Simple Network Management Protocol) software on network computers so they can monitor projectors. If your network uses this software, you can set up the projector for SNMP monitoring.

- 1 Press the [Menu] button, select the **Network** menu, and press [Enter].
- 2 Select **Network Configuration** and press [Enter].
- 3 Select the **Notifications** menu and press [Enter].

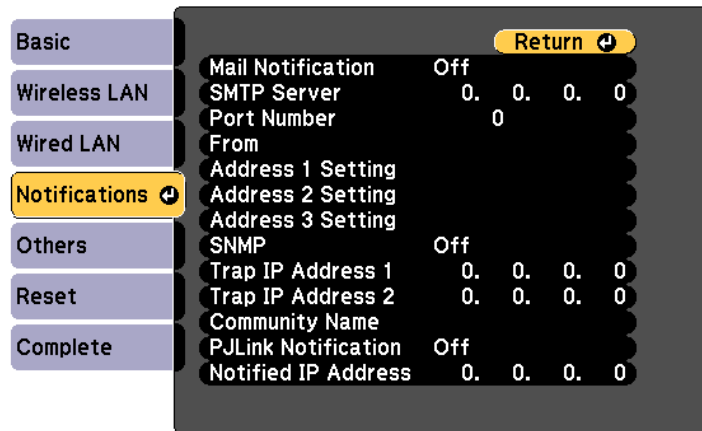

- 4 Set the **SNMP** setting to **On**.
- 5 Enter up to two IP addresses to receive SNMP notifications, using 0 to 255 for each address field.



Do not use these addresses: 224.0.0.0 through 255.255.255.255 (where x is a number from 0 to 255). This projector supports SNMP agent version 1 (SNMPv1).

- 6 Enter the SNMP **Community Name** up to 32 alphanumeric characters long.

- 7 When you finish selecting settings, select **Complete** and follow the on-screen instructions to save your settings and exit the menus.

» Related Links

- "List of Functions" [p.10](#)

You can control the projector from an external device using ESC/VP21.

► **Related Links**

- "ESC/VP21 Command List" [p.116](#)
- "Cable Layouts" [p.116](#)
- "List of Functions" [p.10](#)

ESC/VP21 Command List

When the power ON command is transmitted to the projector, the power turns on and it enters warm-up mode. When the projector's power has turned on, a colon ":" (3Ah) is returned.

When a command is input, the projector executes the command and returns a ":", and then accepts the next command.

If the command being processed terminates abnormally, an error message is output and a ":" is returned.

The following commands are available.

Item		Command
Power On/Off	On	PWR ON
	Off	PWR OFF

Item			Command
Signal selection	Computer1	Auto	SOURCE 1F
		RGB	SOURCE 11
	Computer2	Auto	SOURCE 2F
		RGB	SOURCE 21
	HDMI1		SOURCE 30
	HDMI2		SOURCE A0
	Video		SOURCE 41
	USB Display		SOURCE 51
	USB		SOURCE 52
	LAN		SOURCE 53
Screen Mirroring		SOURCE 56	
A/V Mute On/Off	On		MUTE ON
	Off		MUTE OFF

Add a Carriage Return (CR) code (0Dh) to the end of each command and transmit.

Contact Epson for more details.

Cable Layouts

Serial connection

- Connector shape: D-Sub 9-pin (male)
- Projector input port name: RS-232C
- Cable type: Crossover (null modem) cable

In the following illustration, the projector side is shown on the left, and the computer side on the right:

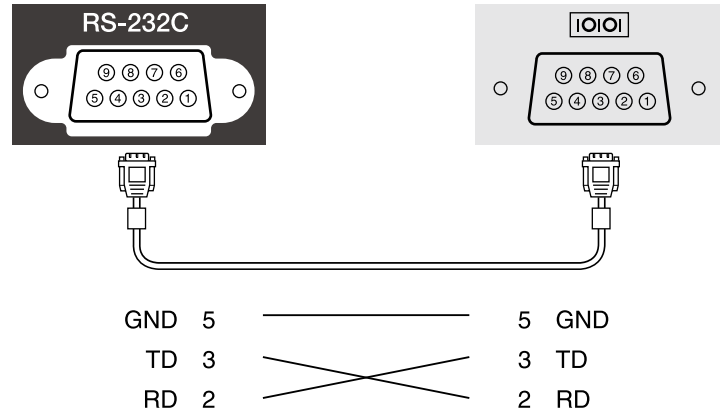

Signal name	Function
GND	Signal wire ground
TD	Transmit data
RD	Receive data

Communications protocol

- Default baud rate setting: 9600 bps
- Data length: 8 bit
- Parity: None
- Stop-bit: 1 bit
- Flow control: None

PJLink was established by the JBMIA (Japan Business Machine and Information System Industries Association) as a standard protocol for controlling network-compatible projector's as part of their efforts to standardize projector control protocols.

The projector complies with the PJLink Class2 standard established by the JBMIA.

The port number used for the PJLink search function is 4352 (UDP).

You need to make network settings before you can use PJLink.

It complies with all commands except for the following commands defined by PJLink Class2, and agreement was confirmed by the PJLink standard adaptability verification.

<http://pjlink.jbmia.or.jp/english/>

- Non-compatible commands

Function		PJLink command
Mute settings	Image muting set	AVMT 11
	Audio muting set	AVMT 21

- Input ports and corresponding input source number

Input port name	Input source number
Computer1	11
Computer2	12
Video	21
HDMI	32
HDMI1	32
HDMI2	33
USB	41
LAN	52
USB Display	53
Screen Mirroring	57

- Manufacturer name displayed for "Manufacture name information query"
EPSON

- Model name displayed for "Product name information query"
 - EPSON 992F
 - EPSON 982W
 - EPSON 972
 - EPSON 118
 - EPSON W49
 - EPSON X49

► **Related Links**

- "List of Functions" [p.10](#)
- "Using the Projector on a Network" [p.87](#)

If you are using the Crestron Connected network monitoring and control system, you can set up your projector for use on the system. Crestron Connected lets you control and monitor your projector using a Web browser.



- You cannot use the Message Broadcasting feature in Epson Projector Management when you use Crestron Connected.
- If you set the **Standby Mode** setting to **Communication On**, you can control the projector even if the projector is in standby mode (when the power is off).
 - ☛ **ECO > Standby Mode > Standby Mode**

For additional information on Crestron Connected, visit the Crestron Web site.

<https://www.crestron.com/products/line/crestron-connected>

To monitor devices in the system, you can use Crestron RoomView Express or Crestron Fusion provided by Crestron. You can communicate with the help desk and send emergency messages. See the following Web site for details.

<http://www.crestron.com/getroomview>

This manual describes how to perform operations on your computer using a Web browser.

» **Related Links**

- "Setting Up Crestron Connected Support" [p.119](#)
- "Controlling a Networked Projector Using Crestron Connected" [p.119](#)
- "Projector Setup Settings - ECO Menu" [p.147](#)
- "List of Functions" [p.10](#)

Setting Up Crestron Connected Support

To set up your projector for monitoring and control using a Crestron Connected system, make sure your computer and projector are connected to the network. If you are connecting wirelessly, set up the projector using the Advanced network connection mode.

1 Press the [Menu] button, select the **Network** menu, and press [Enter].

2 Select **Network Configuration** and press [Enter].

3 Select the **Others** menu and press [Enter].

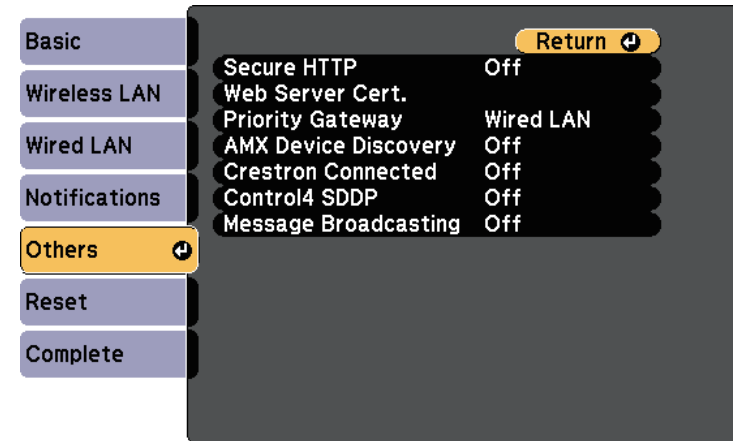

4 Set the **Crestron Connected** setting to **On** to allow the projector to be detected.

5 When you have finished selecting settings, select **Complete** and follow the on-screen instructions to save your settings and exit the menus.

6 Turn off the projector, and then turn it on again to enable the setting.

Controlling a Networked Projector Using Crestron Connected

Once you have set up your projector to use Crestron Connected, you can control and monitor projection using a compatible Web browser.

1 Start your Web browser on a computer connected to the network.

- 2 Type the projector's IP address into the browser's address box and press the computer's **Enter** key.

You see the Epson Web Control screen.

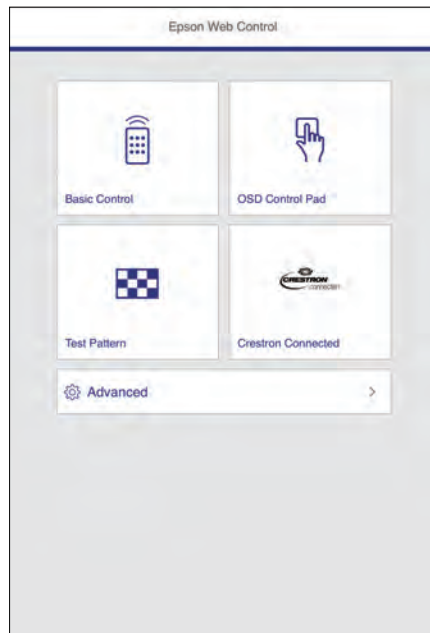

- 3 Select **Crestron Connected**.

You see this screen:



- 4 Select the input source that you want to control in the **Sources List** box. You can scroll through available sources using the up and down arrows in the box.
- 5 To control projection remotely, click the on-screen buttons that correspond to the projector's remote control buttons. You can scroll through button options at the bottom of the screen.



These on-screen buttons do not directly correspond to the projector's remote control buttons:

- **OK** acts as the [Enter] button
- **Menu** displays the projector's menu

- 6 To view information about the projector, click the **Info** tab.
- 7 To change the projector, Crestron Control, and password settings, click the **Tools** tab, select settings on the displayed screen, and then click **Send**.

8 When you finish selecting settings, click **Exit** to exit the program.

» **Related Links**

- "Crestron Connected Operation Window" p.121
- "Crestron Connected Tools Window" p.122

Crestron Connected Operation Window

Settings on the operation window let you control the projector and adjust the projection image.



1	Power	Turns the projector on or off.
	Vol-/Vol+	Adjusts the volume.
	A/V Mute	Turns the video and audio on or off.
2	Switches to the image from the selected input source. To display input sources that are not shown in Sources List , click (a) or (b) to scroll up or down. The current video signal input source is displayed in blue. You can change the source name if necessary.	

3	Freeze	Images are paused or released.
	Contrast	Adjusts the difference between light and shade in the images.
	Brightness	Adjusts the image brightness.
	Color	Adjusts the color saturation for the images.
	Sharpness	Adjusts the image sharpness.
	Zoom	Enlarges or reduces the image without changing the projection size. Click the arrow buttons to change the position of an enlarged image.
4	Arrow buttons	Performs the same operations as the arrow buttons on the remote control.
	OK	Performs the same operation as [Enter] on the remote control.
	Menu	Displays and closes the projector's menu.
	Auto	Optimizes Tracking , Sync. , and Position in the projector's Signal menu while projecting an analog RGB signal from Computer1 or Computer2 port.
	Search	Changes to the next input source that is sending an image.
	Esc	Performs the same operation as the [Esc] button on the remote control.
5	Tools	Changes settings in the projector that is currently connected.
	Info	Displays information on the projector that is currently connected.
	Help	Displays the Help Desk window. Used to send messages to, and receive messages from, the administrator using Crestron RoomView Express.

Crestron Connected Tools Window

Settings on the Tools window let you customize various projector setup features.

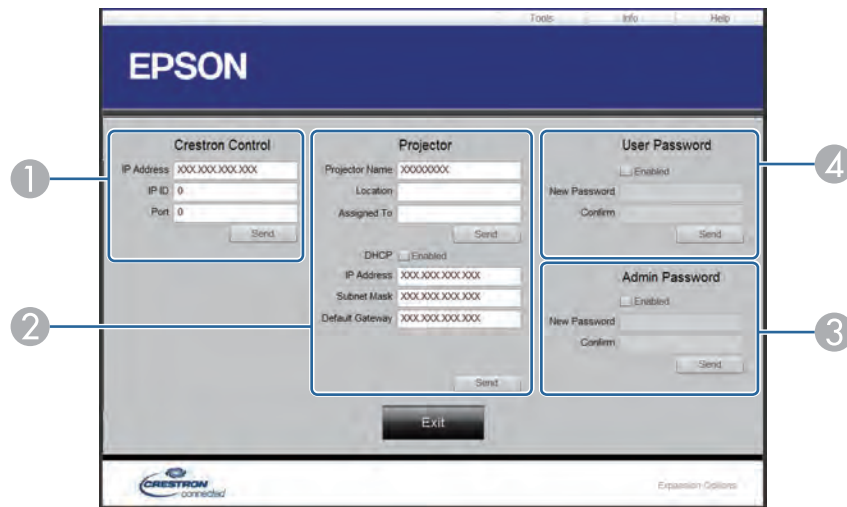

1 Make settings for Crestron central controllers.

2	Projector Name	Enter a name to differentiate the projector that is currently connected from other projectors on the network. (up to 16 alphanumeric characters)
	Location	Enter an installation location name for the projector that is currently connected on the network. (up to 32 alphanumeric characters and symbols)
	Assigned To	Enter a user name for the projector. (up to 32 alphanumeric characters and symbols)
	DHCP	Select to use DHCP. You cannot enter an IP address if DHCP is enabled.
	IP Address	Enter the IP address to assign to the currently connected projector.
	Subnet Mask	Enter a subnet mask for the currently connected projector.
	Default Gateway	Enter the gateway address for the currently connected projector.
	Send	Click to confirm the changes made to the Projector.
3	Enabled (Admin Password)	Select to require a password to open the Tools window.
	New Password	Enter the new password when changing the password to open the Tools window. (up to 26 alphanumeric characters)
	Confirm	Enter the same password as you entered in New Password . If the passwords are not the same, an error is displayed.
	Send	Click to confirm the changes made to the Admin Password .

4	Enabled (User Password)	Select to require a password to open the operation window on the computer.
	New Password	Enter the new password when changing the password to open the operation window. (up to 26 alphanumeric characters)
	Confirm	Enter the same password as you entered in New Password . If the passwords are not the same, an error is displayed.
	Send	Click to confirm the changes made to the User Password .

You can schedule up to 30 events to occur automatically on your projector, such as turning the projector on or off or switching the input source. The projector performs the selected events on the specified date and time in the schedule you set up.

Warning

Do not place flammable objects in front of the lens. If you schedule the projector to turn on automatically, flammable objects in front of the lens could catch on a fire.



- If you set a **Schedule Protection** password, turn off your **Schedule Protection** password first.

- 1** Set the date and time in the **Date & Time** menu.
 **Extended > Operation > Date & Time**
- 2** Press the [Menu] button, select the **Extended** menu, and press [Enter].
- 3** Select **Schedule Settings** and press [Enter].
- 4** Select **Schedule** and press [Enter].

- 5** Select **Add New** and press [Enter].

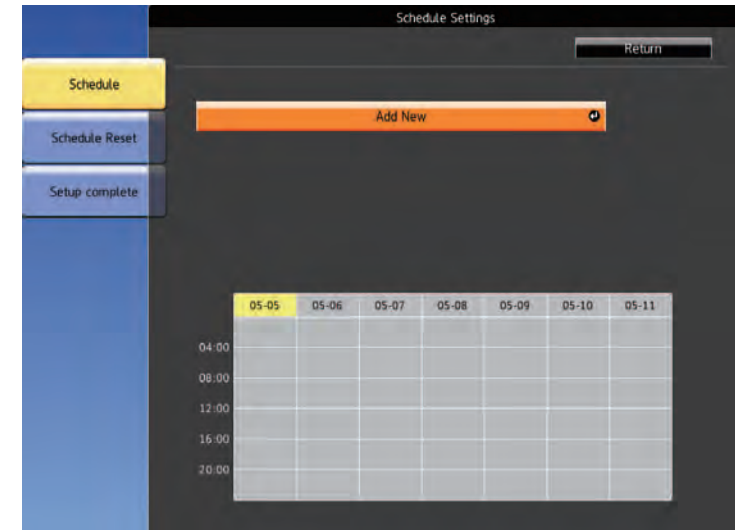

- 6** Select the event details you want to perform.



7 Select the date and time at which you want the event to occur.



8 Select **Save** and press [Enter].

The scheduled events are displayed on the screen with icons indicating the event status.



- ① : valid schedule
- : regular schedule
- : invalid schedule
- ② The date currently selected (highlighted in yellow)
- ③ : one time schedule
- : regular schedule
- : standby schedule (turns communication on or off during standby)
- : invalid schedule

9 To edit a scheduled event, select the schedule and press [Esc].

10 Select an option from the menu displayed.

- **On** or **Off** lets you enable or disable the selected event.

- **Edit** lets you change the event details or date and time.
- **Clear** lets you remove the scheduled event from a list.

11 Select **Complete**, then select **Yes**.

To delete all scheduled events, select **Schedule Reset**.

» **Related Links**

- "List of Functions" [p.10](#)
- "Setting the Date and Time" [p.43](#)
- "Setting a Password" [p.82](#)

Adjusting the Menu Settings

Follow the instructions in these sections to access the projector menu system and change projector settings.

► Related Links

- "Using the Projector's Menus" [p.128](#)
- "Using the Displayed Keyboard" [p.129](#)
- "Image Quality Settings - Image Menu" [p.130](#)
- "Input Signal Settings - Signal Menu" [p.131](#)
- "Projector Feature Settings - Settings Menu" [p.132](#)
- "Projector Setup Settings - Extended Menu" [p.134](#)
- "Projector Network Settings - Network Menu" [p.137](#)
- "Projector Setup Settings - ECO Menu" [p.147](#)
- "Projector Information Display - Info Menu" [p.149](#)
- "Projector Reset Options - Reset Menu" [p.152](#)
- "Copying Menu Settings Between Projectors (Batch Setup)" [p.153](#)

You can use the projector's menus to adjust the settings that control how your projector works. The projector displays the menus on the screen.

- 1 Press the [Menu] button on the control panel or remote control.
You see the menu screen displaying the **Image** menu settings.

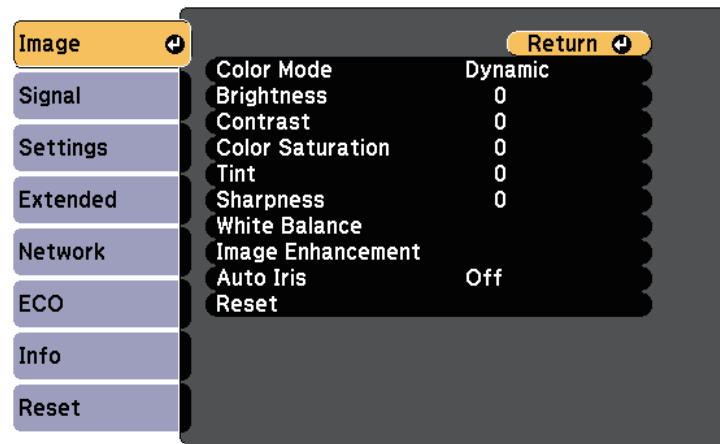

- 2 Press the up or down arrow buttons to move through the menus listed on the left. The settings for each menu are displayed on the right.



The available settings depend on the current input source.

- 3 To change settings in the displayed menu, press [Enter].
- 4 Press the up or down arrow button to move through the settings.
- 5 Change the settings using the buttons listed on the bottom of the menu screens.
- 6 To return all the menu settings to their default values, select **Reset**.

- 7 When you finish changing settings on a menu, press [Esc].

- 8 Press [Menu] or [Esc] to exit the menus.

You can use the displayed keyboard to enter numbers and characters.

- 1 Use the arrow buttons on the control panel or remote control to highlight the number or character you want to enter and press the [Enter] button.

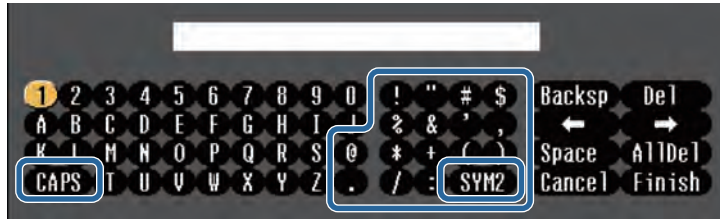

 Each time you select the **CAPS** key, the characters change between upper case and lower case. Each time you select the **SYM1/2** key, the symbols enclosed by the frame change.

- 2 After entering the text, select **Finish** on the keyboard to confirm your entries. Select **Cancel** to cancel entering text.

 You can select projector settings and control projection over a network using a Web browser from your computer.
Some symbols cannot be entered using the displayed keyboard. Use your Web browser to enter the text.

Text type	Details
Numbers	0123456789
Alphabet	ABCDEFGHIJKLMNOPQRSTUVWXYZ abcdefghijklmnopqrstuvwxyz
Symbols	!"#\$%&'()*+,-./:;<=>?@[\] ^_`{ }~

» **Related Links**

- "Available Text Using the Displayed Keyboard" [p.129](#)
- "Controlling a Networked Projector Using a Web Browser" [p.108](#)

Available Text Using the Displayed Keyboard

You can enter the following text when using the displayed keyboard.

Settings on the **Image** menu let you adjust the quality of your image for the input source you are currently using. The available settings depend on the currently selected input source.

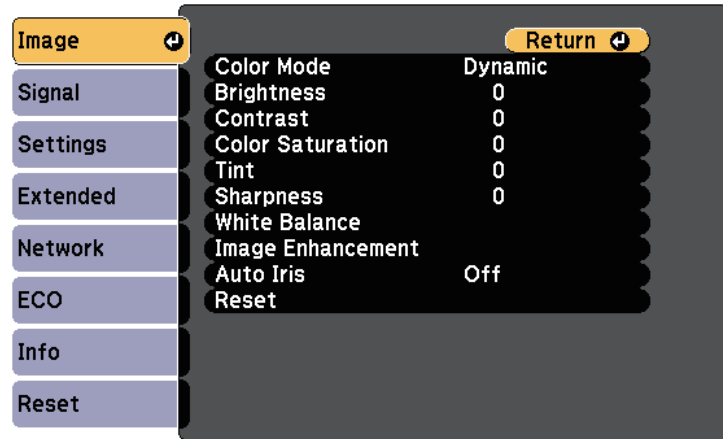

To change settings for an input source, make sure the source is connected and select that source.

Setting	Options	Description
Color Mode	See the list of available color modes	Adjusts the vividness of image colors for various image types and environments.
Brightness	Varying levels available	Lightens or darkens the overall image.
Contrast	Varying levels available	Adjusts the difference between light and dark areas of the image.
Color Saturation	Varying levels available	Adjusts the intensity of the image colors.
Tint	Varying levels available	Adjusts the balance of green to magenta tones in the image.
Sharpness	Varying levels available	Adjusts the sharpness or softness of image details.
White Balance		Adjusts the overall tint of the image.

Setting	Options	Description
	Color Temp.	Color Temp.: sets the color temperature according to the color mode you selected. Higher values tint the image blue and lower values tint the image red.
	Custom	Custom: adjusts the individual R (red), G (green), and B (blue) components of the offset and gain.
Image Enhancement		Adjusts the perceived resolution of the image:
	Noise Reduction	Noise Reduction: reduces flickering in analog images.
	Deinterlacing (For interlaced signal [480i/576i/1080i] input)	Deinterlacing: sets whether or not to convert interlaced-to-progressive signals for certain video image types. <ul style="list-style-type: none"> • Off: for fast-moving video images. • Video: for most video images. • Film/Auto: for movies, computer graphics, and animation.
Auto Iris	Off Normal High Speed	Adjusts the projected luminance based on the image brightness. Available when the Color Mode is set to Dynamic or Cinema .
Reset	—	Resets all adjustment values on the Image menu for the selected color mode to their default settings.

 • The **Brightness** setting does not affect lamp brightness. To change the lamp brightness mode, use the **Power Consumption** setting in the projector's **ECO** menu.

» **Related Links**

- "Available Color Modes" [p.61](#)

Normally the projector automatically detects and optimizes the input signal settings. If you need to customize the settings, you can use the **Signal** menu. The available settings depend on the currently selected input source.

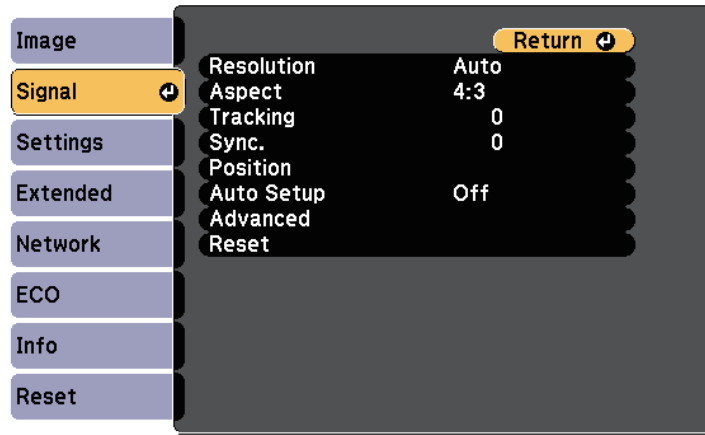

 You can restore the default settings of the **Tracking**, **Sync.**, and **Position** settings by pressing the [Auto] button on the remote control.

To change settings for an input source, make sure the source is connected and select that source.

Setting	Options	Description
Position	—	Adjusts the image location on the screen.
Auto Setup	On Off	Automatically optimizes computer image quality (when On).
Overscan	Auto Off 4% 8%	Changes the projected image ratio to make the edges visible by a selectable percentage or automatically.
Advanced	Video Range	Video Range: sets the video range to match the setting of the device connected to the HDMI port.
	Video Signal	Video Signal: specifies the signal type from the input sources connected to the Video ports. If interference appears or no image appears when set to Auto , select the appropriate signal according to the connected equipment.
Reset	—	Resets all adjustment values on the Signal menu to their default settings.

» **Related Links**

- "Available Image Aspect Ratios" [p.58](#)

Setting	Options	Description
Resolution	Auto Wide Normal	Sets the input signal resolution if not detected automatically using the Auto option.
Aspect	See the list of available aspect ratios.	Sets the aspect ratio (width-to-height ratio) for the selected input source.
Tracking	Varying levels available	Adjusts the signal to eliminate vertical stripes in computer images.
Sync.	Varying levels available	Adjusts the signal to eliminate fuzziness or flickering in computer images.

Options on the **Settings** menu let you customize various projector features.

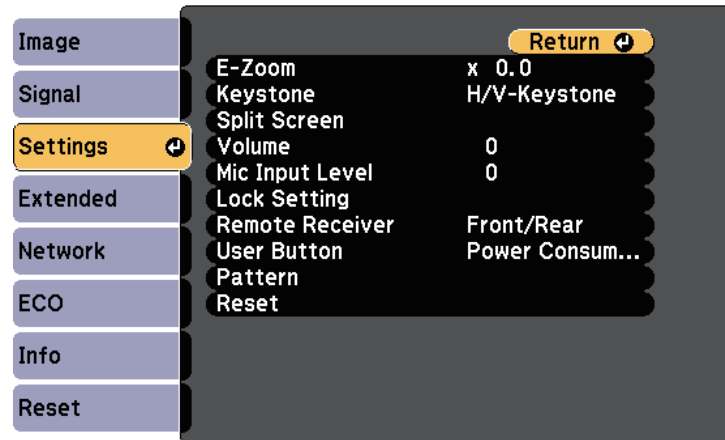

Setting	Options	Description
E-Zoom	Varying levels available	Adjusts the size of the projected image.
Keystone		Adjusts image shape to rectangular (horizontally and vertically).
	H/V-Keystone	H/V-Keystone: Select to manually correct horizontal and vertical sides. Auto V-Keystone: Turns automatic correction on or off. (Available only for models that support the Auto V-Keystone function.) H-Keystone Adjuster: Turns H-Keystone Adjuster on or off. (Available only for models that have the horizontal keystone slider.)
	Quick Corner	Quick Corner: Select to correct image shape and alignment using an on-screen display.

Setting	Options	Description
Split Screen	Screen Size Source Swap Screens Audio Source Align Display the QR Code Exit Split Screen	Divides the viewing area horizontally and displays two images side-by-side (press [Esc] to cancel split screen display).
Volume	Varying levels available	Adjusts the volume of projector's speaker system. You can also adjust the volume of external speakers. Setting values are saved for each source.
Mic Input Level	Varying levels available	Adjusts the input level from a microphone. When Mic Input Level is turned up, the volume of the other connected device is turned down; when it is turned down, the volume of the other connected device is turned up. (Available only for models that have the Mic port.)
Lock Setting	Control Panel Lock	Controls projector button locking to secure the projector: Full Lock: locks all buttons. Partial Lock: locks all buttons except the power button. Off: no buttons locked.
Remote Receiver	Front/Rear Front Rear Off	Limits reception of remote control signals by the selected receiver; Off turns off all receivers. Options vary depending on the number of remote receivers equipped on the projector.

Setting	Options	Description
User Button	Power Consumption Info Deinterlacing Test Pattern Resolution Mic Input Level Pattern Display Display the QR Code	Assigns a menu option to the [User] button on the remote control for one-touch access. Mic Input Level is available only for models that have the Mic port. Display the QR Code is available only for models that support network projection.
Pattern		Selects various pattern display options. <div style="border: 1px solid black; padding: 5px; background-color: #ffffcc;"> <p>Attention If a pattern is displayed for a long time, a residual image may be visible in projected images.</p> </div>
	Pattern Display	Pattern Display: lets you display the selected pattern type on the screen to aid in presentation.
	Pattern Type	Pattern Type: select from Patterns 1 to 4 or User Pattern . Patterns 1 to 4 display patterns pre-registered in the projector, such as ruled lines or grid patterns.
	User Pattern	User Pattern: captures a projected screen and saves it as a pattern for display.
	Test Pattern	Test Pattern: displays a test pattern to assist in focusing and zooming the image and correcting image shape (press the [Esc] button to cancel pattern display).
Reset	—	Resets all adjustment values on the Settings menu to their default settings, except for the following: <ul style="list-style-type: none"> • E-Zoom • User Button

» **Related Links**

- "List of Functions" [p.10](#)

Settings on the **Extended** menu let you customize various projector setup features.

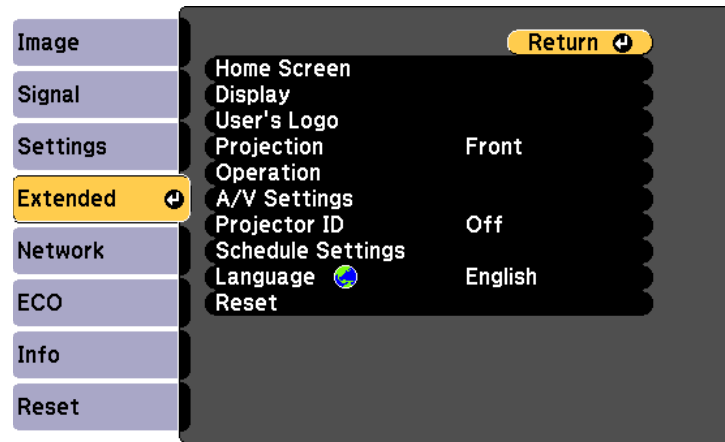

Setting	Options	Description
Home Screen		Selects the projector's Home screen display options:
	Home Screen Auto Disp.	Home Screen Auto Disp.: select whether or not to display the Home screen automatically when there is no input signal when turning on the projector.
	Custom Function 1 Custom Function 2	Custom Function 1/Custom Function 2: select to set functions and the display as the customized Home screen.
Display		Selects various display options:
	Messages	Messages: set to On to display messages such as input source name, color mode name, aspect ratio, no signal message, or high temperature warning on your projected image. Set to Off if you do not want to display messages.

Setting	Options	Description
	Display Background	Display Background: sets the screen color or logo to display when no signal is received.
	Startup Screen	Startup Screen: set to On to display a logo when the projector starts up.
	A/V Mute	A/V Mute: sets the screen color or logo to display when A/V Mute is turned on.
User's Logo	—	Creates a screen that the projector displays to identify itself and enhance security.
Projection	Front	Selects the way the projector faces the screen so the image is oriented correctly.
	Front/Ceiling	
	Rear	
	Rear/Ceiling	
Operation		Selects various operation options:
	Direct Power On	Direct Power On: lets you turn on the projector by plugging it in without pressing the power button.
	High Altitude Mode	High Altitude Mode: regulates the projector's operating temperature at altitudes above 1500 m.
	Auto Source Search	Auto Source Search: set to On to detect the input signal automatically and project images when there is no input signal.

Setting	Options	Description
	Auto Power On	<p>Auto Power On: select the image source from which you want to automatically start projection. When the projector detects the input signal from the selected image source, it projects automatically in standby mode.</p> <p>The following image sources are available for this feature:</p> <ul style="list-style-type: none"> • HDMI1 • HDMI • Computer1 • Computer • USB Display
	HDMI EQ Setting	<p>HDMI EQ Setting: Adjust the HDMI input signal level depending on the devices connected to the HDMI port. If there is a lot of interference in the image, or if a problem such as no image being projected occurs, change the setting.</p> <p>If no images are displayed using a thumb-sized media streaming device, select 1.</p>
	Advanced	<p>Log Save Destination: sets the location in which to save error and operation log files. (Available only for models that have a USB-A port.)</p> <p>Batch Setup Range: select All to copy all of the projector menu settings using the batch setup feature. Select Limited, if you do not want to copy the following settings:</p> <ul style="list-style-type: none"> • Password Protection settings • Network menu settings

Setting	Options	Description
	Date & Time	<p>Date & Time: adjusts the projector's system time and date settings. (Available only for models that support the Schedule function.)</p> <ul style="list-style-type: none"> • Daylight Saving Time: set to On to activate daylight saving time. • Internet Time: set to On to update the time automatically through an Internet time server.
A/V Settings		Selects various audio and video output settings:
	A/V Output	<p>A/V Output: set to Always On to output audio and images to external devices when the projector is in standby mode.</p>
	Audio Settings	<p>Audio Output: selects the audio input port when projecting images from anything except for HDMI ports. (Available only for models that have multiple audio input ports.)</p> <p>HDMI Audio Output/HDMI1 Audio Output/HDMI2 Audio Output: selects the audio input port when projecting images from HDMI ports. (Options vary depending on the number of HDMI ports on the projector.)</p>
Projector ID	Off 1 through 9	Assigns an ID for the projector when you use multiple projectors.
Schedule Settings	To Schedule Settings menu	Schedules projector events to occur automatically at selected dates and times. (Available only for models that support the Schedule function.)
Language	Various languages available	Select the language for projector menu and message displays.

Setting	Options	Description
Reset	—	Resets all adjustment values on the Extended menu to their default settings, except for the following: <ul style="list-style-type: none"> • User's Logo • Projection • High Altitude Mode • Auto Source Search • HDMI EQ Setting • Date & Time • A/V Output • Projector ID • Schedule Settings • Language

 When you set **User's Logo Protection** to **On** in the **Password Protection** screen, you cannot change settings related to user's logo display (**Display Background**, **Startup Screen**, **A/V Mute** in the **Display** setting). Set **User's Logo Protection** to **Off** first.

» **Related Links**

- "List of Functions" [p.10](#)
- "Selecting Password Security Types" [p.83](#)

Settings on the **Network** menu let you view network information and set up the projector for controlling over a network.

This menu is available only for models that support network projection.

When you set **Network Protection** to **On** in the **Password Protection** screen, you cannot change the network settings. Set **Network Protection** to **Off** first.

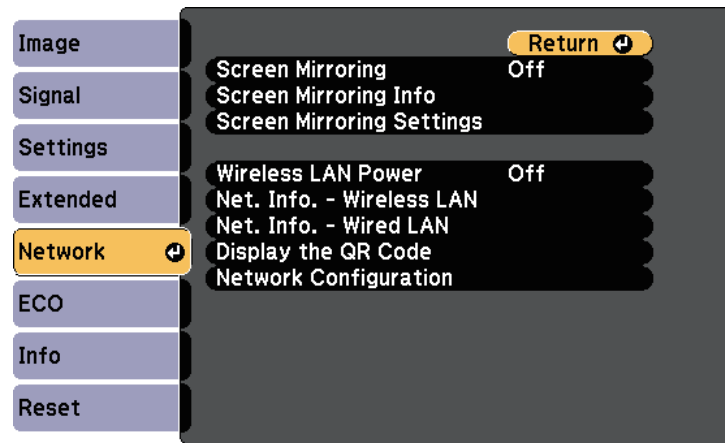

Setting	Options	Description
Wireless LAN Power	On Off	Configures your wireless LAN settings. Select On to project images via a wireless LAN. If you do not want to connect via wireless LAN, turn it off to prevent unauthorized access by others.
Net. Info. - Wireless LAN	Connection Mode Wireless LAN Sys. Antenna Level Projector Name SSID DHCP IP Address Subnet Mask Gateway Address MAC Address Region Code IPv6	Displays wireless network status and details. (Available only for models that support wireless LAN projection.) Available when you have set Wireless LAN Power to On . The following settings are displayed when you select the IPv6 option. <ul style="list-style-type: none"> • IPv6 Address (Manual) <ul style="list-style-type: none"> • IPv6 Address • Prefix Length • Gateway Address • IPv6 Address (Auto) <ul style="list-style-type: none"> • Temporary Address • Link-local Address • Stateless Address • Stateful Address

Setting	Options	Description
Screen Mirroring *	On Off	Configures your Screen Mirroring settings. Select On to project with the Screen Mirroring features.
Screen Mirroring Info *	Display Name MAC Address Region Code Channel Connected Device	Displays Screen Mirroring status and details. Available when you have set Screen Mirroring to On .
Screen Mirroring Settings *	To Screen Mirroring Settings menu	Configures your Screen Mirroring settings.

Setting	Options	Description
Net. Info. - Wired LAN	Projector Name DHCP IP Address Subnet Mask Gateway Address MAC Address IPv6 Address (Manual) IPv6 Address (Auto)	Displays wired network status and details. (Available only for models that support wired LAN projection.) The following settings are displayed when you select the IPv6 Address (Manual) or IPv6 Address (Auto) option. <ul style="list-style-type: none"> • IPv6 Address (Manual) <ul style="list-style-type: none"> • IPv6 Address • Prefix Length • Gateway Address • IPv6 Address (Auto) <ul style="list-style-type: none"> • Temporary Address • Link-local Address • Stateless Address • Stateful Address
Display the QR Code	—	Displays a QR code for connecting with iOS or Android devices using the Epson iProjection app.
Network Configuration	To additional network menus	Configures your network settings.

- "Network Menu - Reset Menu" [p.146](#)
- "List of Functions" [p.10](#)
- "Selecting Password Security Types" [p.83](#)

Network Menu - Screen Mirroring Settings

Settings on the **Screen Mirroring Settings** menu let you select the Screen Mirroring settings.

☛ Network > Screen Mirroring Settings

This menu is available only for models that support Screen Mirroring.

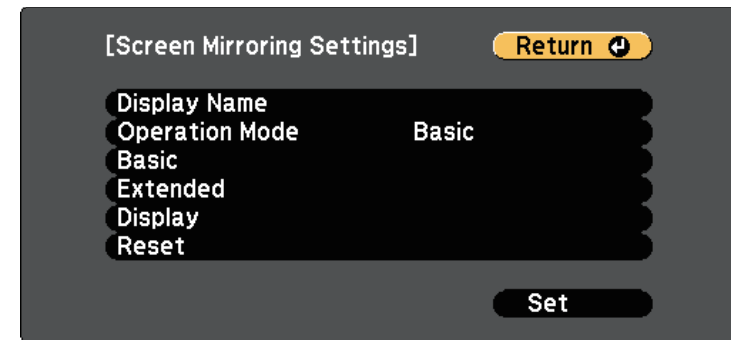

Setting	Options	Description
Display Name	Up to 32 alphanumeric characters	Enter a name to identify the projector when searching for the projector using the screen mirroring feature.
Operation Mode	Basic Extended	Select Extended to connect with advanced options.

* Available only for models that support Screen Mirroring.



Once you have connected your projector to your network, you can select projector settings and control projection using a compatible Web browser. This allows you to access the projector remotely.

» Related Links

- "Network Menu - Screen Mirroring Settings" [p.138](#)
- "Network Menu - Basic Menu" [p.139](#)
- "Network Menu - Wireless LAN Menu" [p.140](#)
- "Network Menu - Wired LAN Menu" [p.143](#)
- "Network Menu - Notifications Menu" [p.144](#)
- "Network Menu - Others Menu" [p.145](#)

Setting	Options	Description
Basic	Wireless LAN Sys.	Sets the communication method between the projector and the mobile device. You can select the following methods: <ul style="list-style-type: none"> • 802.11a/g/n/ac (Wi-Fi 5) • 802.11a/g/n (Wi-Fi 4) • 802.11g/n (Wi-Fi 4) The available methods vary depending on countries and regions.
	Adjust Image Quality	Adjusts the screen mirroring speed/quality. When you want to increase image quality, select a small number. When you want to increase processing speed, select a large number.
	Connection Mode	Selects the security type when you connect to the network wirelessly. Select PIN to improve the connection security. If your mobile device supports only the PBC connection, select PIN/PBC . Available when you have set Operation Mode to Basic .
Extended		Available when you have set Operation Mode to Extended .
	Meeting Mode	Selects the type of meeting. <ul style="list-style-type: none"> • Interruptions OK: lets you connect to another mobile device during Screen Mirroring projection. • No Interruptions: lets you exclusively connect to one device.
	Channel	Selects the wireless channel used by Screen Mirroring.
Display	Display PIN Code	Set to On to display the eight-digit PIN code on the projected image when projecting input sources other than Screen Mirroring.

Setting	Options	Description
	Display Device Name	Set to On to display the newly connected device name on the projected image when projecting input sources other than Screen Mirroring.
Reset	—	Resets all adjustment values on the Screen Mirroring Settings menu to their default settings.

- » **Related Links**
- "List of Functions" [p.10](#)

Network Menu - Basic Menu

Settings on the **Basic** menu let you select the basic network settings.

☛ **Network > Network Configuration > Basic**

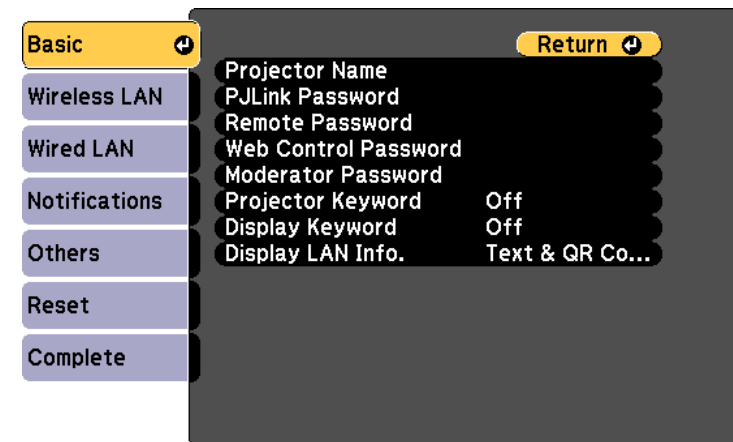

Setting	Options	Description
Projector Name	Up to 16 alphanumeric characters (do not use " * + , / ; < = > ? [\] ' ` spaces)	Enter a name to identify the projector over the network.
PJLink Password	Up to 32 alphanumeric characters	Enter a password for using the PJLink protocol for projector control.
Remote Password	Up to 8 alphanumeric characters (do not use * : spaces)	Enter a password for accessing the projector using the Basic Control. (User name is EPSONREMOTE ; default password is guest .)
Web Control Password	Up to 8 alphanumeric characters (do not use * : spaces)	Enter a password for accessing the projector over the Web. (User name is EPSONWEB ; default password is admin .)
Moderator Password	Four-digit number	Enter a password for accessing the projector as a moderator using Epson iProjection. (No password is set by default.)
Projector Keyword	On Off	Set to On to enable a security password to prevent access to the projector by anyone not in the same room as the projector. You must enter a displayed, randomized keyword from a computer using Epson iProjection to access the projector and share the current screen.
Display Keyword	On Off	Set to On to display a projector keyword on the projected image when accessing the projector using Epson iProjection. Available when Projector Keyword is set to On .

Setting	Options	Description
Display LAN Info.	Text & QR Code Text	Set the display format for the projector's network information. By simply reading the QR code with Epson iProjection, you can connect the mobile device to the projector through a network. The default value is Text & QR Code .

» **Related Links**

- "List of Functions" [p.10](#)

Network Menu - Wireless LAN Menu

Settings on the **Wireless LAN** menu let you select the wireless LAN settings.

☛ **Network > Network Configuration > Wireless LAN**

This menu is available only for models that support wireless LAN projection.

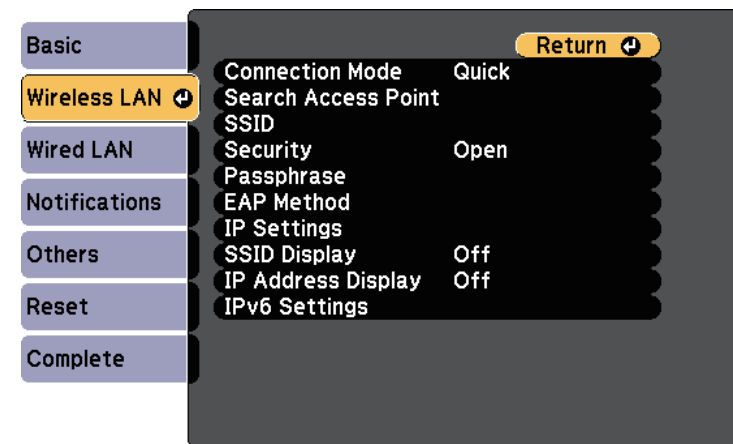

Setting	Options	Description
Connection Mode	Select the type of wireless connection:	
	Quick	Quick: lets you connect to multiple smartphones, tablets, or computers directly using wireless communication. When you select Quick connection mode, the projector acts as an easy access point. (We recommend limiting the number of devices to six or less to maintain the projection performance.)
	Advanced	Advanced: lets you connect to multiple smartphones, tablets, or computers over a wireless network access point.
Search Access Point	To Search View	Search for available wireless network access points in Advanced connection mode. Depending on the access point settings, they may not be displayed in the list.
SSID	Up to 32 alphanumeric characters	Sets the SSID (network name) of the wireless LAN system the projector is connecting to.
Security	Selects the type of security used on the wireless network. When setting security, follow the instructions from the administrator of the network system you want to connect to.	
	Open	Security is not set.
	WPA2-PSK	Communication is performed using WPA2 security. Uses AES method for encryption. When establishing a connection from a computer to the projector, enter the value set in the passphrase.

Setting	Options	Description
	WPA3-PSK	Communication is performed using WPA3 security. Uses AES method for encryption. When establishing a connection from a computer to the projector, enter the value set in the passphrase.
	WPA2/WPA3-PSK	Connects in WPA2/WPA3 personal mode. Encryption method is selected automatically according to the access point settings. Set a passphrase which is the same for the access point.
	WPA3-EAP	Connects in WPA3 enterprise mode. Encryption method is selected automatically according to the access point settings.
	WPA2/WPA3-EAP	Connects in WPA2/WPA3 enterprise mode. Encryption method is selected automatically according to the access point settings.
Passphrase	Various passphrases from 8 to 32 characters (when entering from a Web browser: various passphrases from 8 to 63 characters)	For WPA2-PSK, WPA3-PSK and WPA2/WPA3-PSK security, selects the pre-shared passphrase used on the network. When the passphrase is entered and the [Enter] button is pressed, the value is set and displayed as an asterisk (*). We recommend changing the passphrase periodically for security. If the network settings are initialized, it returns to the initial passphrase.
EAP Method	Set the EAP settings for WPA3-EAP and WPA2/WPA3-EAP security.	

Setting	Options	Description
	EAP Type	<p>EAP Type: selects the protocol for authentication.</p> <ul style="list-style-type: none"> • PEAP: authentication protocol widely used in Windows Server. • PEAP-TLS: authentication protocol used in Windows Server. Select this when using a client certificate. • EAP-TLS: authentication protocol widely used to use a client certificate. • EAP-FAST: select this when these authentication protocols are used.
	User name	<p>User name: Enter up to 64 alphanumeric characters. You can enter up to 32 alphanumeric characters in the projector menu. To enter more than 32 characters, use your Web browser. You can enter a domain name by adding it before the user name and separating them with a backslash (domain\username).</p> <p>When importing a client certificate, the name the certificate was issued to is automatically set.</p>
	Password	<p>Password: Enter a password up to 64 alphanumeric characters for authentication when EAP Type is set to PEAP or EAP-FAST. You can enter up to 32 alphanumeric characters in the projector menu. To enter more than 32 characters, use your Web browser. After you enter the password and select Set, the password is displayed as an asterisk (*).</p>
	Client Certificate	<p>Client Certificate: imports the client certificate when EAP Type is set to PEAP-TLS or EAP-TLS.</p>
	Verify Server Cert.	<p>Verify Server Cert.: Set to On to verify the server certificate when a CA certificate has been set.</p>

Setting	Options	Description
	CA certificate	<p>CA certificate: imports the CA certificate.</p>
	RADIUS Serv.Name	<p>RADIUS Serv.Name: Enter the server name you want to verify. You can enter up to 64 alphanumeric characters. To enter more than 32 characters, use your Web browser.</p>
Channel	Various channels available	<p>In Quick connection mode, selects the frequency band (channel) used by the wireless LAN.</p>
IP Settings	DHCP IP Address Subnet Mask Gateway Address	<p>DHCP: set to On if your network assigns addresses automatically; set to Off to manually enter the network's IP Address, Subnet Mask, and Gateway Address using 0 to 255 for each address field.</p> <p>Do not use these addresses: 0.0.0.0, 127.x.x.x, 192.0.2.x or 224.0.0.0 through 255.255.255.255 (where x is a number from 0 to 255) for IP Address, 255.255.255.255 or 0.0.0.0 through 254.255.255.255 for Subnet Mask, and 0.0.0.0, 127.x.x.x or 224.0.0.0 through 255.255.255.255 for Gateway Address.</p>
SSID Display	On Off	<p>Select whether to display the SSID on the network standby screen and Home screen.</p>
IP Address Display	On Off	<p>Select whether to display the IP address on the network standby screen and Home screen.</p>
IPv6 Settings		<p>Select the IPv6 settings if you want to connect the projector to the network using IPv6:</p>
	IPv6	<p>IPv6: set to On if you want to connect the projector to the network using IPv6. IPv6 is supported to monitor and control the projector over a network using Epson Web Control and PjLink.</p>

Setting	Options	Description
	Auto Configuration	Auto Configuration: set to On to assign addresses automatically according to the Router Advertisement.
	Use Temporary Address	Use Temporary Address: set to On if you want to use a temporary IPv6 address.

» **Related Links**

- "List of Functions" [p.10](#)

Network Menu - Wired LAN Menu

Settings on the **Wired LAN** menu let you select the wired LAN settings.

☛ **Network > Network Configuration > Wired LAN**

This menu is available only for models that support wired LAN projection.

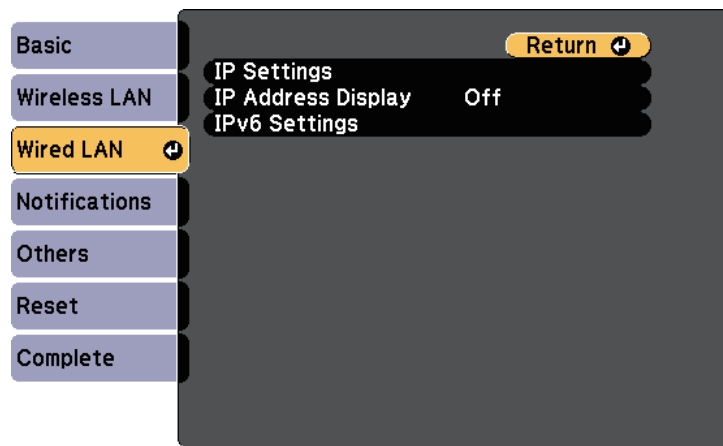

Setting	Options	Description
IP Settings	DHCP IP Address Subnet Mask Gateway Address	DHCP: set to On if your network assigns addresses automatically; set to Off to manually enter the network's IP Address, Subnet Mask, and Gateway Address using 0 to 255 for each address field. Do not use these addresses: 0.0.0.0, 127.x.x.x, 192.0.2.x or 224.0.0.0 through 255.255.255.255 (where x is a number from 0 to 255) for IP Address, 255.255.255.255 or 0.0.0.0 through 254.255.255.255 for Subnet Mask, and 0.0.0.0, 127.x.x.x or 224.0.0.0 through 255.255.255.255 for Gateway Address.
IP Address Display	On Off	Select whether to display the IP address on the network standby screen.
IPv6 Settings		Select the IPv6 settings if you want to connect the projector to the network using IPv6:
	IPv6	IPv6: set to On if you want to connect the projector to the network using IPv6. IPv6 is supported to monitor and control the projector over a network using Epson Web Control and PjLink.
	Auto Configuration	Auto Configuration: set to On to assign addresses automatically according to the Router Advertisement.
	Use Temporary Address	Use Temporary Address: set to On if you want to use a temporary IPv6 address.

» **Related Links**

- "List of Functions" [p.10](#)

Network Menu - Notifications Menu

Settings on the **Notifications** menu let you receive an email notification if a problem or warning occurs in the projector.

☛ **Network > Network Configuration > Notifications**

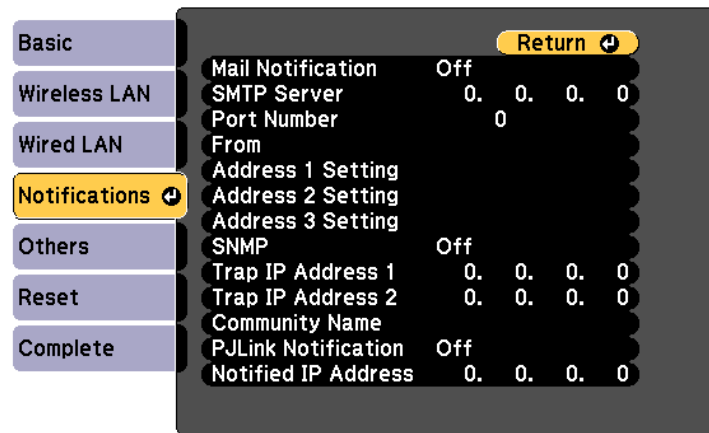

Setting	Options	Description
Mail Notification	On Off	Set to On to send an email to the preset addresses when a problem or warning occurs with a projector.
SMTP Server	IP address	Enter the IP address for the projector's SMTP server using 0 to 255 for each address field. Do not use these addresses: 127.x.x.x, 192.0.2.x or 224.0.0.0 through 255.255.255.255 (where x is a number from 0 to 255).
Port Number	0 to 65535 (default is 25)	Select a number for the SMTP server Port Number.

Setting	Options	Description
From	Up to 32 alphanumeric characters Up to 64 alphanumeric characters from the Web browser (do not use " () , ; < > [\] spaces)	Enter the email address of the sender.
Address 1 Setting		Enter the e-mail address, and select the alerts you want to receive. Repeat for up to three addresses.
Address 2 Setting		
Address 3 Setting		
SNMP	On Off	Set to On to monitor the projector using SNMP. To monitor the projector, you need to install the SNMP manager program on your computer. SNMP should be managed by a network administrator.
Trap IP Address 1 Trap IP Address 2	IP address	Enter up to two IP addresses to receive SNMP notifications, using 0 to 255 for each address field. Do not use these addresses: 127.x.x.x or 224.0.0.0 through 255.255.255.255 (where x is a number from 0 to 255).
Community Name	Up to 32 alphanumeric characters (do not use spaces and any symbols other than @)	Set the SNMP community name.
PJLink Notification	On Off	Enables or disables the PJLink notification function. Available only for models that support wired LAN projection.

Setting	Options	Description
Notified IP Address	IP address	Enter the IP address to receive the projector's operating status when the PjLink notification function is enabled. Enter the addresses using 0 to 255 for each address field. Do not use these addresses: 127.x.x.x or 224.0.0.0 through 255.255.255.255 (where x is a number from 0 to 255). Available only for models that support wired LAN projection.

► **Related Links**

- "List of Functions" [p.10](#)

Network Menu - Others Menu

Settings on the **Others** menu let you select other network settings.

☛ **Network > Network Configuration > Others**

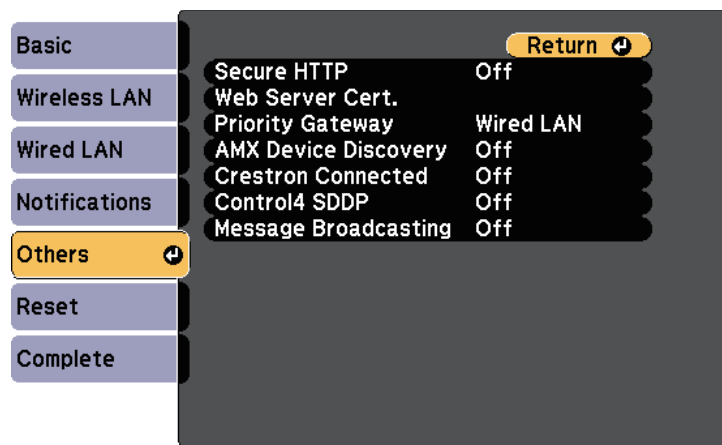

Setting	Options	Description
Secure HTTP	On Off	To strengthen security, communication between the projector and computer in Web control is encrypted. When setting security with Web control, it is recommended to set this to On .
Web Server Cert.	—	Imports the Web server certificate for secure HTTP.
Priority Gateway *	Wired LAN Wireless LAN	You can set the priority gateway.
AMX Device Discovery *	On Off	Set to On when you want to allow the projector to be detected by AMX Device Discovery.
Crestron Connected *	On Off	Set to On only when monitoring or controlling the projector over the network using Crestron Connected. Enabling Crestron Connected disables the Epson Message Broadcasting feature in the Epson Projector Management software.
Control4 SDDP *	On Off	Set to On to allow device information to be acquired using Control4 Simple Device Discovery Protocol (SDDP).
Message Broadcasting	On Off	Set to On to receive the message delivered by Epson Projector Management. See the <i>Epson Projector Management Operation Guide</i> for details. Available only when Crestron Connected is set to Off .

* Available only for models that support wired LAN projection.

► **Related Links**

- "Crestron Connected Support" [p.119](#)
- "List of Functions" [p.10](#)

Network Menu - Reset Menu

Settings on the **Reset** menu let you reset all of the network settings.

☛ **Network > Network Configuration > Reset**

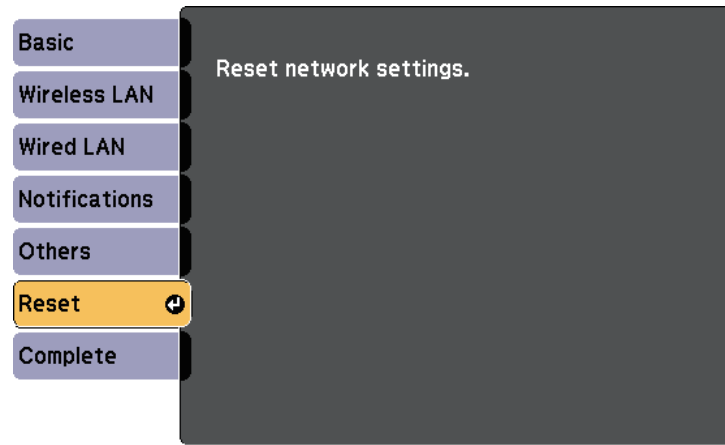

Setting	Options	Description
Reset network settings.	Yes No	Select Yes to reset all network settings.

Settings on the **ECO** menu let you customize projector functions to save power.

When you select a power-saving setting, a leaf icon appears next to the menu item.

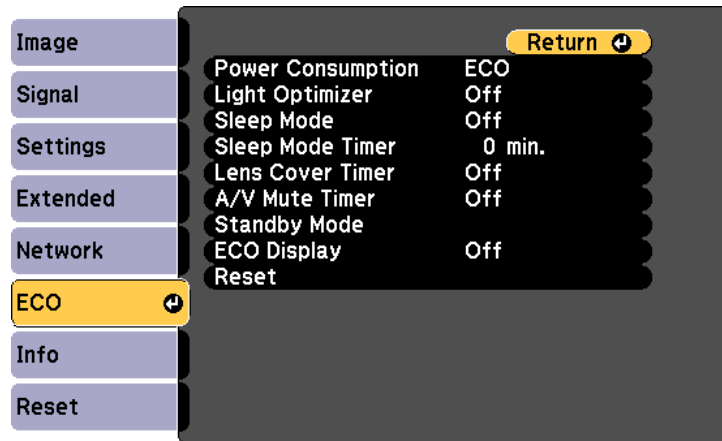

Setting	Options	Description
Power Consumption	High Medium ECO	Selects the brightness mode of the projector lamp. You cannot select settings when you use your projector at high altitude or in locations subject to high temperatures. Select ECO to reduce lamp brightness and fan noise, and to save power and lamp life. Options vary depending on the projector model.

Setting	Options	Description
Light Optimizer	On Off	When set to On , the lamp brightness is adjusted according to the projected image. This helps to reduce the power consumption by lowering the lamp brightness according to the scene being projected. The setting is stored for each Color Mode. This item is enabled when: <ul style="list-style-type: none"> • Power Consumption is set to High or Medium. • Auto Iris is set to Off. Image > Auto Iris
Sleep Mode	On Off	Automatically turns off the projector after an interval of inactivity (when On).
Sleep Mode Timer	1 to 30 minutes	Sets the interval for Sleep Mode.
Lens Cover Timer	On Off	Automatically turns off the projector after 30 minutes if the lens cover is closed (when On).
A/V Mute Timer	On Off	Automatically turns off the projector after 30 minutes if A/V Mute is enabled (when On).
Standby Mode *		Available when you have set A/V Output to While Projecting .

Setting	Options	Description
	Standby Mode	<p>Communication On indicates that the projector can be monitored over a network when the projector is in standby mode. Enable this setting to allow the following operations to occur when the projector is in standby mode:</p> <ul style="list-style-type: none"> • Monitor and control the projector over a network <p>Communication On is automatically selected when A/V Output is set to Always On.</p> <p>☛ Extended > A/V Settings > A/V Output</p>
	Port	Selects the port to use from Wired LAN or Wireless LAN while the Standby Mode setting is set to Communication On .
Standby Mode **	Communication On Communication Off	<p>Communication On indicates that the projector can be monitored over a network when the projector is in standby mode. Enable this setting to allow the following operations to occur when the projector is in standby mode:</p> <ul style="list-style-type: none"> • Monitor and control the projector over a network <p>Communication On is automatically selected when A/V Output is set to Always On.</p> <p>☛ Extended > A/V Settings > A/V Output</p>
ECO Display	On Off	Displays a leaf icon in the bottom left corner of the projected screen to indicate the power-saving status when the lamp brightness changes (when On).
Reset	—	Resets all adjustment values on the ECO menu to their default settings, except for Standby Mode .

* Available only for models that support wired LAN and wireless LAN projection.

** Available only for models that support wireless LAN projection.



- When the **Sleep Mode Timer** setting is enabled, the lamp dims for a short time before the timer limit is reached and the projector turns off.
- When the **Lens Cover Timer** or **A/V Mute Timer** settings are enabled, the lamp uses less power when the lens cover is closed or **A/V Mute** is activated.

» **Related Links**

- "Projector Setup Settings - Extended Menu" [p.134](#)
- "List of Functions" [p.10](#)

You can display information about the projector and version by viewing the **Info** menu. However, you cannot change any settings in the menu.

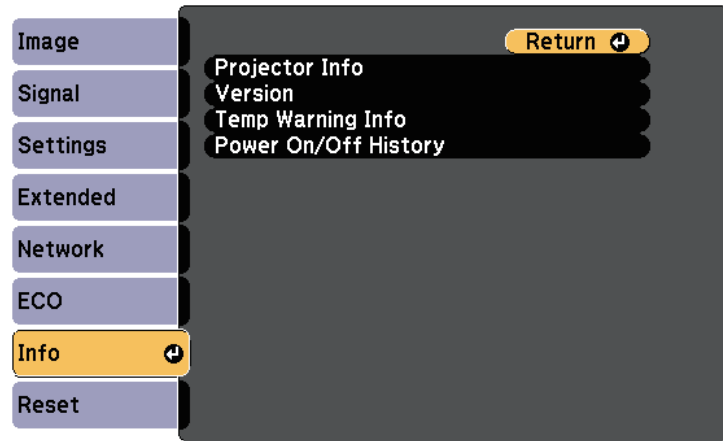

Information item	Description
Projector Info	Displays the projector information.
Version	Displays the projector's firmware version.
Temp Warning Info	Displays various high temperature warnings.
Power On/Off History	Displays the projector's power on and power off history. (Available only for models that support the Schedule function.)

» **Related Links**

- "Info Menu - Projector Info Menu" [p.149](#)
- "List of Functions" [p.10](#)

Info Menu - Projector Info Menu

You can display information about the projector and input sources by viewing the **Projector Info** menu in the projector's **Info** menu.

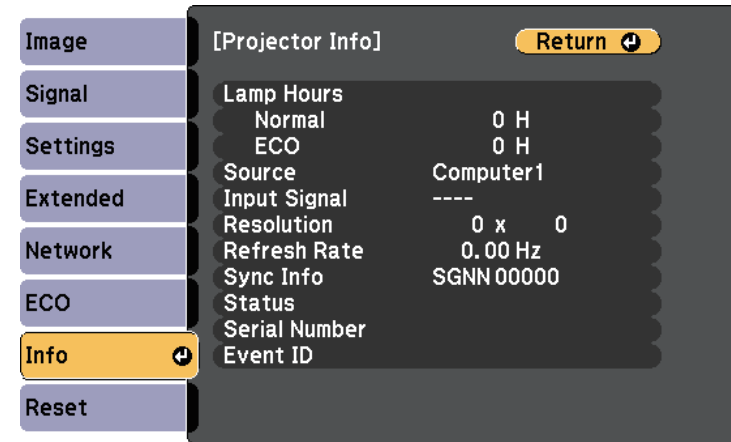

 The available settings depend on the current input source. The lamp usage timer does not register any hours until you have used the lamp for at least 10 hours.

Information item	Description
Lamp Hours	Displays the number of hours (H) the lamp has been used in each Power Consumption mode; if the information is displayed in yellow, obtain a genuine Epson replacement lamp soon. ☛ ECO > Power Consumption
Source	Displays the name of the port to which the current input source is connected.
Input Signal	Displays the input signal setting of the current input source.
Resolution	Displays the resolution of the current input source.

Information item	Description
Refresh Rate	Displays the refresh rate of the current input source.
Sync Info	Displays information that may be needed by a service technician.
Status	Displays information about projector problems that may be needed by a service technician.
Serial Number	Displays the projector's serial number.
Event ID	Displays the Event ID number corresponding to a network problem; see the list of Event ID codes. (Available only for models that support network projection.)

► **Related Links**

- "Event ID Code List" [p.150](#)
- "List of Functions" [p.10](#)

Event ID Code List

If the **Event ID** option on the **Projector Info** menu displays a code number, check this list of Event ID codes for the solution to the projector problem associated with the code.

If you cannot resolve the problem, contact your network administrator or Epson for technical support.

Event ID code	Cause and solution
0432 0435	The network software did not start. Turn the projector off and then on again.
0433	Cannot display the transferred images. Restart the network software.
0434 0481 0482 0485	Unstable network communication. Check the network communication status, wait a few moments, and try connecting to the network again.

Event ID code	Cause and solution
0483 04FE	The network software quit unexpectedly. Check the network communication status, then turn the projector off and then on again.
0484	Communication with computer was disconnected. Restart the network software.
0479 04FF	A projector system error has occurred. Turn the projector off and then on again.
0891	Cannot find an access point with the same SSID. Set your computer, access point, and projector to the same SSID.
0892	The WPA/WPA2/WPA3 authentication type does not match. Make sure the wireless network security settings are correct.
0893	The TKIP/AES encryption type does not match. Make sure the wireless network security settings are correct.
0894	Communication with an unauthorized access point was disconnected. Contact your network administrator.
0895	Communication with a connected device was disconnected. Check your device connection status.
0898	Failed to acquire DHCP. Make sure the DHCP server is operating correctly. If you are not using DHCP, set the DHCP setting to Off in the projector's Network menu. 🖱️ Network > Network Configuration > Wireless LAN > IP Settings > DHCP 🖱️ Network > Network Configuration > Wired LAN > IP Settings > DHCP
0899	Other communication errors.
089A	The EAP authentication type does not match the network. Check the wireless LAN security settings and make sure that the security certificate is installed correctly.
089B	EAP server authentication failed. Check the wireless LAN security settings and make sure that the security certificate is installed correctly.
089C	EAP client authentication failed. Check the wireless LAN security settings and make sure that the security certificate is installed correctly.

Event ID code	Cause and solution
089D	Key exchange failed. Check the wireless LAN security settings and make sure that the security certificate is installed correctly.

» Related Links

- "List of Functions" [p.10](#)

You can reset most of the projector settings to their default values using the **Reset** menu.

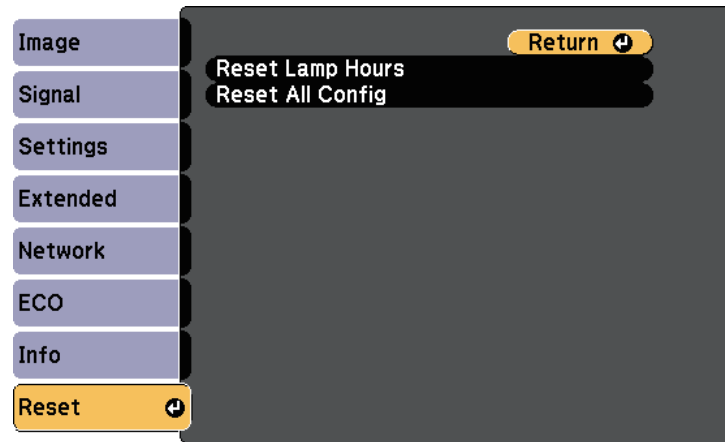

- Lamp Hours
- Password

* Only when you set the **User's Logo Protection** setting to **On** in the **Password Protection** setting menu.

Setting	Options	Description
Reset Lamp Hours	—	Reset the projector's lamp usage timer to zero when you replace the lamp.
Reset All Config	—	Resets most of the projector settings to their default values.

You cannot reset the following settings using the **Reset All Config** option:

- E-Zoom
- User's Logo
- Display Background *
- Startup Screen *
- A/V Mute *
- Schedule Settings
- Language
- Date & Time
- Network menu items

After selecting the projector's menu settings for one projector, you can use the following methods to copy the settings to other projectors, as long as they are the same model.

- by using a USB flash drive (Available only for models that have a USB-A port.)
- by connecting a computer and projector using a USB cable
- by using Epson Projector Management (Available only for models that have a LAN port.)

Menu settings such as the following are not copied to the other projector.

- **Network** menu settings (except for the **Notifications** menu and the **Others** menu)
- **Lamp Hours** and **Status** from the **Projector Info** menu



- Perform batch setup before adjusting the image settings such as keystone distortion correction. Since image adjustment values are also copied to another projector, the adjustments you made before performing the batch setup are overwritten and the projected screen you adjusted may change.
 - When copying the menu settings from one projector to another, user's logo is also copied. Do not register the information that you do not want to share between multiple projectors as a user's logo.
 - Make sure **Batch Setup Range** is set to **Limited** if you do not want to copy the following settings:
 - **Password Protection** settings
 - **Network** menu settings (except for the **Notifications** menu and the **Others** menu)
- ☛ **Extended > Operation > Advanced > Batch Setup Range**

Caution

Epson takes no responsibility for batch setup failures and associated repair costs due to power outages, communication errors, or other problems that may cause such failures.

» Related Links

- "Transferring Settings From a USB Flash Drive" [p.153](#)

- "Transferring Settings From a Computer" [p.154](#)
- "List of Functions" [p.10](#)

Transferring Settings From a USB Flash Drive

You can copy menu settings from one projector to another of the same model using a USB flash drive.



The USB flash drive must use a FAT format and not incorporate any security function. Delete any files on the drive before using it for batch setup or the settings may not be saved correctly.

- 1** Disconnect the power cord from the projector, and check that all of the projector's indicators have turned off.
- 2** Connect an empty USB flash drive directly to the projector's USB-A port.
- 3** Hold down the [Esc] button on the remote control or the control panel and connect the power cord to the projector.
- 4** When all of the projector's indicators turn on, release the [Esc] button. The indicators start flashing and the batch setup file is written to the USB flash drive. When writing is finished, the projector turns off.

Caution

Do not disconnect the power cord or the USB flash drive from the projector while the file is being written. If the power cord or USB flash drive is disconnected, the projector may not start correctly.

- 5** Remove the USB flash drive.



The file name for the batch setup file is PJCONFDATA.bin. If you need to change the file name, add text after PJCONFDATA using only alphanumeric characters. If you change the PJCONFDATA section of the file name, the projector may not be able to recognize the file correctly.



You can use this batch setup method with the following operating system versions:

- Windows 7 and later
- OS X 10.11.x and later

- 6** Disconnect the power cord from the projector to which you want to copy settings, and check that all of the projector's indicators have turned off.
- 7** Connect the USB flash drive containing the saved batch setup file to the projector's USB-A port.
- 8** Hold down the [Menu] button on the remote control or the control panel and connect the power cord to the projector.
- 9** When all of the projector's indicators turn on, release the [Menu] button.

When all of the indicators start flashing, the settings are being written. When writing is finished, the projector turns off.

Caution

Do not disconnect the power cord or the USB flash drive from the projector while the file is being written. If the power cord or USB flash drive is disconnected, the projector may not start correctly.

- 10** Remove the USB flash drive.

- 1** Disconnect the power cord from the projector, and check that all of the projector's indicators have turned off.
- 2** Connect a USB cable to the computer's USB port and to the projector's USB-B port.
- 3** Hold down the [Esc] button on the remote control or the control panel and connect the power cord to the projector.
- 4** When all of the projector's indicators turn on, release the [Esc] button. The computer recognizes the projector as a removable disk.
- 5** Open the removable disk icon or folder, and save the batch setup file to the computer.



The file name for the batch setup file is PJCONFDATA.bin. If you need to change the file name, add text after PJCONFDATA using only alphanumeric characters. If you change the PJCONFDATA section of the file name, the projector may not be able to recognize the file correctly.

- 6** Eject the USB device (Windows) or drag the removable disk icon to the Trash (Mac).
- 7** Disconnect the USB cable. The projector turns off.
- 8** Disconnect the power cord from the projector to which you want to copy settings, and check that all of the projector's indicators have turned off.

Transferring Settings From a Computer

You can copy menu settings from one projector to another of the same model by connecting the computer and projector with a USB cable.

- 9** Connect the USB cable to the computer's USB port and to the projector's USB-B port.
- 10** Hold down the [Menu] button on the remote control or the control panel and connect the power cord to the projector.
- 11** When all of the projector's indicators turn on, release the [Menu] button.
The computer recognizes the projector as a removable disk.
- 12** Copy the batch setup file (PJCONFDATA.bin) that you saved to your computer to the top level folder of the removable disk.

 Do not copy any files or folders other than the batch setup file to the removable disk.

- 13** Eject the USB device (Windows) or drag the removable disk icon to the Trash (Mac).
- 14** Disconnect the USB cable.
When all of the indicators start flashing, the settings are being written. When writing is finished, the projector turns off.

 **Caution**
Do not disconnect the power cord from the projector while the file is being written. If the power cord is disconnected, the projector may not start correctly.

» **Related Links**

- "Batch Setup Error Notification" [p.155](#)

Batch Setup Error Notification

The projector's indicators notify you if an error occurs during a batch setup operation. Check the status of the projector's indicators and follow the instructions described in the table here.

Indicator status	Problem and solutions
<ul style="list-style-type: none"> • Lamp: Orange - flashing fast • Temp: Orange - flashing fast 	<p>The batch setup file may be corrupt, or the USB flash drive or USB cable may not be connected correctly.</p> <p>Disconnect the USB flash drive or the USB cable, unplug and then plug in the projector's power cord, and then try again.</p>
<ul style="list-style-type: none"> • Power: Blue - flashing fast • Status: Blue - flashing fast • Lamp: Orange - flashing fast • Temp: Orange - flashing fast 	<p>Writing the settings may have failed and an error may have occurred in the projector's firmware.</p> <p>Stop using the projector, remove the power plug from the electrical outlet. Contact Epson for help.</p>

» **Related Links**

- "Projector Indicator Status" [p.169](#)

Maintaining the Projector

Follow the instructions in these sections to maintain your projector.

► **Related Links**

- "Projector Maintenance" [p.157](#)
- "Cleaning the Lens" [p.158](#)
- "Cleaning the Projector Case" [p.159](#)
- "Air Filter and Vent Maintenance" [p.160](#)
- "Projector Lamp Maintenance" [p.163](#)

You may need to clean the projector's lens periodically, and clean the air filter and air vents to prevent the projector from overheating due to blocked ventilation.

The only parts you should replace are the lamp, air filter, and remote control batteries. If any other part needs replacing, contact Epson or an authorized Epson servicer.

 **Warning**

Before cleaning any part of the projector, turn it off and unplug the power cord. Never open any cover on the projector, except as specifically explained in this manual. Dangerous electrical voltages in the projector can injure you severely.

Clean the projector's lens periodically, or whenever you notice dust or smudges on the surface.

- To remove dust or smudges, gently wipe the lens with lens-cleaning paper.
- To remove stubborn smudges, moisten a soft, lint-free cloth with lens cleaner and gently wipe the lens. Do not spray any liquid directly on the lens.

Warning

Do not use a lens cleaner that contains flammable gas. The high heat generated by the projector lamp may cause a fire.

Attention

Do not use glass cleaner or any harsh materials to clean the lens and do not subject the lens to any impacts; otherwise, it could be damaged. Do not use canned air, or the gases may leave a flammable residue.

Before cleaning the projector case, turn off the projector and unplug the power cord.

- To remove dust or dirt, use a soft, dry, lint-free cloth.
- To remove stubborn dirt, use a soft cloth moistened with water and mild soap. Do not spray liquid directly on the projector.

Attention

Do not use wax, alcohol, benzene, paint thinner, or other chemicals to clean the projector case. These can damage the case. Do not use canned air, or the gases may leave a flammable residue.

Regular filter maintenance is important to maintaining your projector. Clean the air filter when a message appears telling you the temperature inside the projector has reached a high level. It is recommended that you clean these parts over a 10,000-hour* or 6,000-hour* period. Clean them more often than this if you use the projector in a particularly dusty environment.

* See "Projector Specifications" in the Appendix for the air filter maintenance period by model.

Attention

If regular maintenance is not performed, your Epson projector will notify you when the temperature inside the projector has reached a high level. Do not wait until this warning appears to maintain your projector filter as prolonged exposure to high temperatures may reduce the life of your projector or lamp.

» Related Links

- "Cleaning the Air Filter and Vents" [p.160](#)
- "Replacing the Air Filter" [p.160](#)
- "List of Functions" [p.10](#)

Cleaning the Air Filter and Vents

Clean the projector's air filter or vents if they get dusty, or if you see a message telling you to clean them.

- 1** Turn off the projector and unplug the power cord.

- 2** Gently remove the dust using a small vacuum designed for computers or a very soft brush (such as a paintbrush).

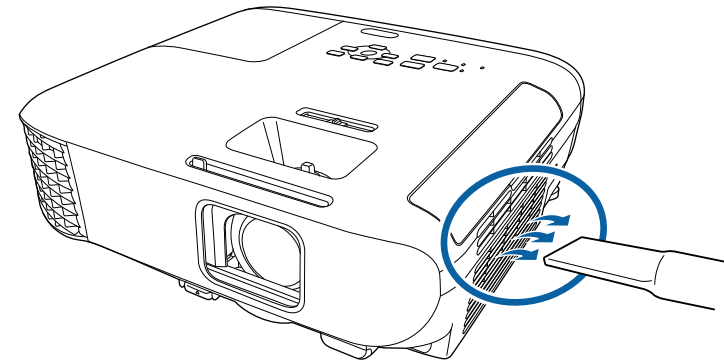

You can remove the air filter so that you can clean both sides. Do not rinse the air filter in water, or use any detergent or solvent to clean it.

Attention

Do not use canned air. The gases may leave a flammable residue or push dust and debris into the projector's optics or other sensitive areas.

- 3** If dust is difficult to remove or the air filter is damaged, replace the air filter.

Replacing the Air Filter

You need to replace the air filter in the following situations:

- After cleaning the air filter, you see a message telling you to clean or replace it.
- The air filter is torn or damaged.

You can replace the air filter while the projector is mounted to the ceiling or placed on a table.

1 Turn off the projector and unplug the power cord.

2 Open the air filter cover.

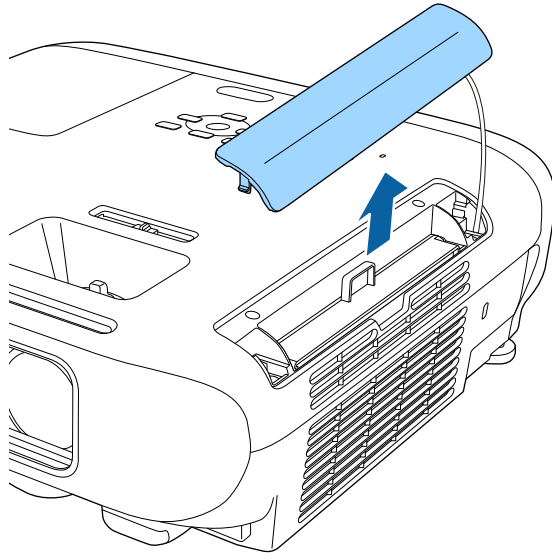

3 Pull the air filter out of the projector.

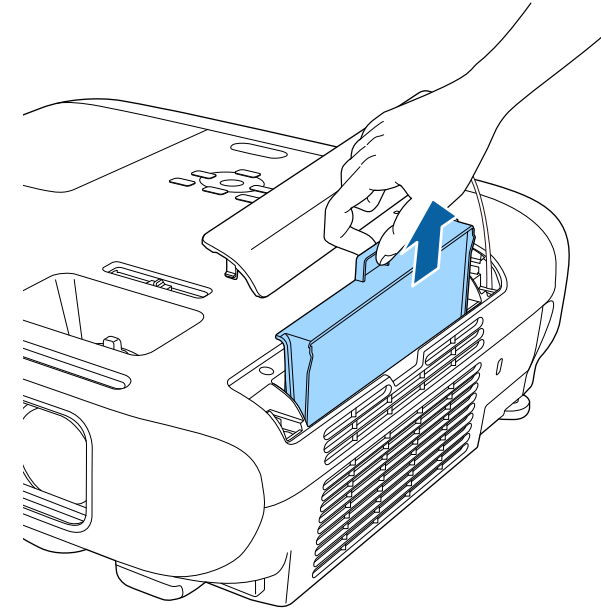

Dispose of used air filters according to local regulations.

- Filter frame: ABS
- Filter: Polyurethane foam

- 4** Place the new air filter in the projector as shown and push gently until it clicks into place.

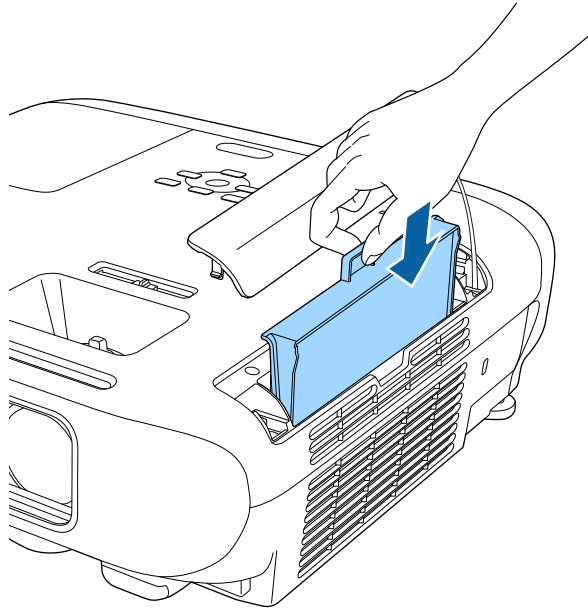

- 5** Close the air filter cover.

» **Related Links**

- "Replacement Parts" [p.185](#)

The projector monitors the number of hours the lamp is used and displays this information in the projector's menu system.

Replace the lamp as soon as possible when the following occurs:

- The projected image gets darker or quality declines
- A message is displayed when you turn on the projector telling you to replace the lamp (the message is displayed 100 hours before the expected end of the lamp life and appears for 30 seconds)

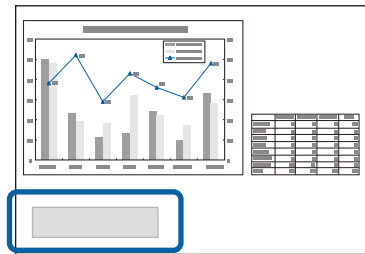

- The projector's power indicator is flashing blue and its lamp indicator is flashing orange.

Attention

- If you continue to use the lamp after the replacement period has passed, the possibility that the lamp may explode increases. When the lamp replacement message appears, replace the lamp with a new one as soon as possible, even if it is still working.
- Do not repeatedly turn off the power and then immediately turn it back on. Turning the power on and off frequently may shorten the lamp's operating life.
- Depending on the characteristics of the lamp and the way it has been used, the lamp may become darker or stop working before the lamp warning message appears. You should always have a spare lamp unit ready in case it is needed.
- We recommend the use of genuine Epson replacement lamps. The use of non-genuine lamps may affect projection quality and safety. Any damage or malfunction caused by the use of non-genuine lamps may not be covered by Epson's warranty.

» Related Links

- "Replacing the Lamp" [p.163](#)

- "Resetting the Lamp Timer" [p.166](#)
- "Projector Specifications" [p.194](#)
- "Projector Indicator Status" [p.169](#)

Replacing the Lamp

You can replace the lamp while the projector is placed on a table or mounted to the ceiling.

Warning

- Let the lamp fully cool before replacing it to avoid injury.
- Never disassemble or modify the lamp. If a modified or disassembled lamp is installed in the projector, it could cause a fire, electric shock, or other damage or injury.

- 1** Turn off the projector and unplug the power cord.
- 2** Allow the projector lamp to cool down for at least one hour.
- 3** Use the screwdriver included with the replacement lamp to loosen the screw securing the lamp cover.

Warning

When replacing the lamp, there is a possibility that the lamp may be broken. If replacing the lamp of a projector which has been installed on the ceiling, you should always assume that the lamp is cracked, and you should stand to the side of the lamp cover, not underneath it. Remove the lamp cover gently. Be careful when removing the lamp cover as shards of glass may fall out and could cause an injury. If any shards of glass get into your eyes or mouth, contact a doctor immediately.

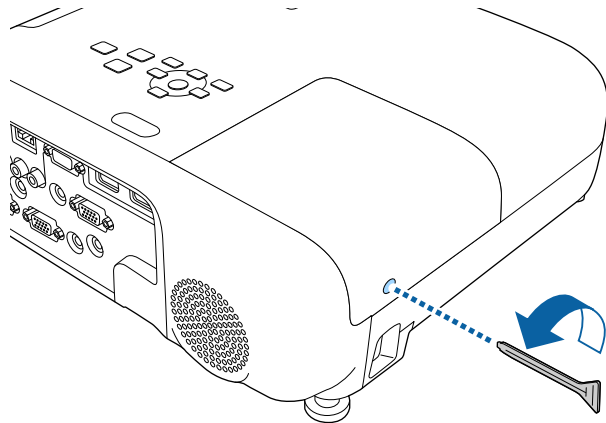

- 4** Slide the lamp cover out and lift it off.

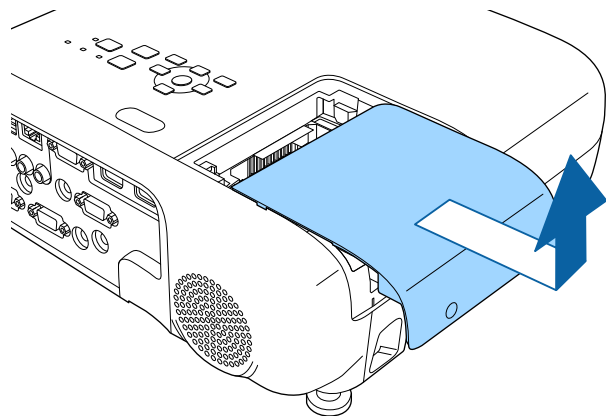

- 5** Loosen the screws securing the lamp to the projector. The screws do not come all the way out.

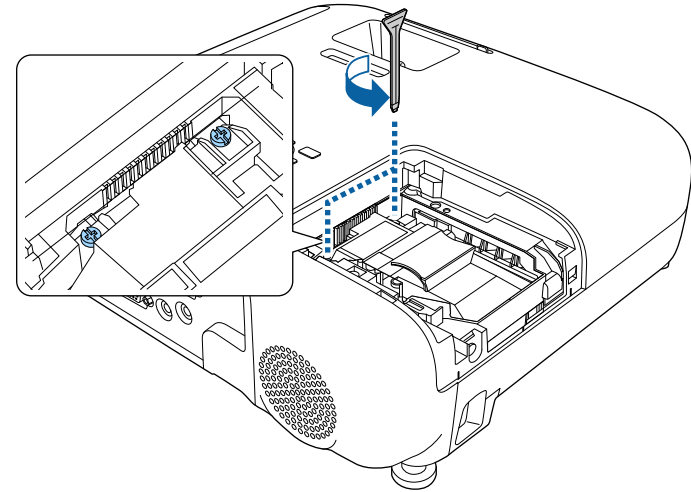

- 6** Grip the raised section of the lamp and remove it.

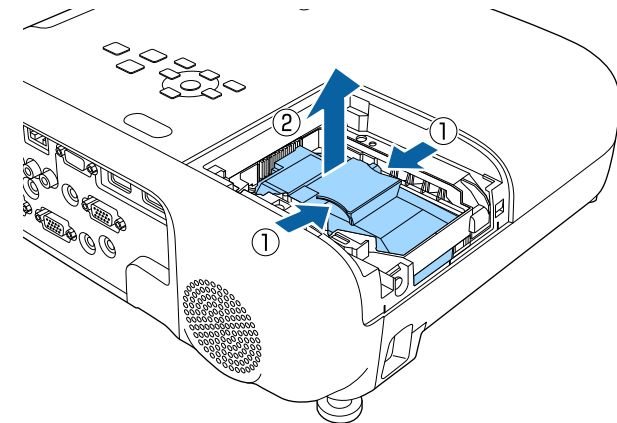



- If you notice the lamp is cracked when removing the lamp, contact Epson for help.
- The lamp(s) in this product contain mercury (Hg). Check your local laws and regulations regarding disposal or recycling. Do not put in the trash.

7 Gently insert the new lamp into the projector. If it does not fit easily, make sure it is facing the right way.

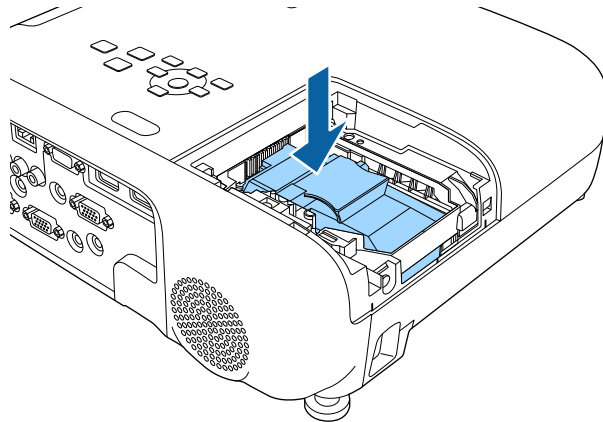

Attention

Do not touch any glass on the lamp assembly to avoid premature lamp failure.

8 Push in the lamp firmly and tighten the screws to secure it.

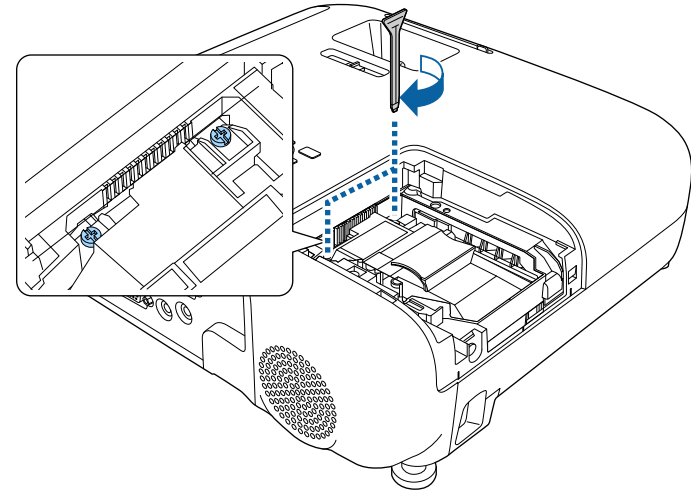

9 Replace the lamp cover and tighten the screw to secure it.

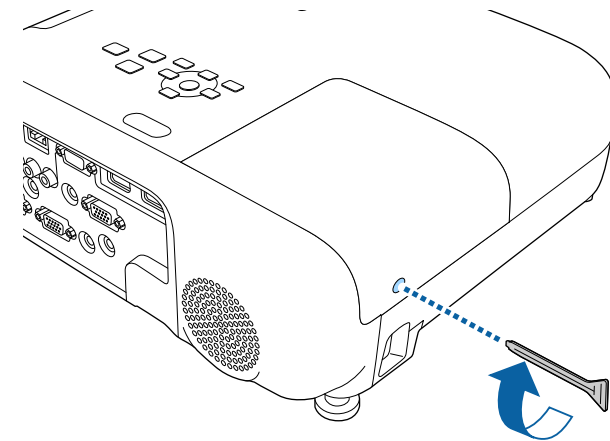



- Make sure the lamp cover is securely installed or the lamp will not turn on.
- Do not replace the lamp cover with too much force and make sure the lamp cover is not deformed.

Reset the lamp timer to zero to monitor the new lamp's usage.

» Related Links

- "Replacement Parts" [p.185](#)

Resetting the Lamp Timer

You must reset the lamp timer after replacing the projector's lamp to clear the lamp replacement message and to monitor lamp usage correctly.



Do not reset the lamp timer if you have not replaced the lamp to avoid inaccurate lamp usage information.

- 1** Turn on the projector.
- 2** Press the [Menu] button, select the **Reset** menu, and press [Enter].

- 3** Select **Reset Lamp Hours** and press [Enter].

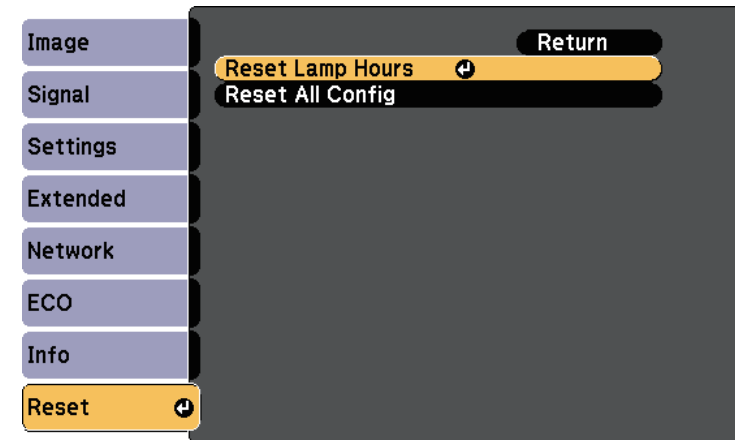

You see a prompt asking if you want to reset the lamp hours.

- 4** Select **Yes** and press [Enter].
- 5** Press [Menu] or [Esc] to exit the menus.

Solving Problems

Check the solutions in these sections if you have any problems using the projector.

► Related Links

- "Projection Problems" [p.168](#)
- "Projector Indicator Status" [p.169](#)
- "Using the Projector Help Displays" [p.172](#)
- "Solving Image or Sound Problems" [p.173](#)
- "Solving Projector or Remote Control Operation Problems" [p.178](#)
- "Solving Network Problems" [p.180](#)

If the projector is not working properly, turn it off, unplug it, and then plug it back in and turn it on.

If this does not solve the problem, check the following:

- The indicators on the projector may indicate the problem.
- The projector's Help system can display information about common problems.
- The solutions in this manual can help you solve many problems.

If none of these solutions help, contact Epson for technical support.

The indicators on the projector indicate the projector status and let you know when a problem occurs. Check the status and color of the indicators and then refer to this table for a solution.

 If the indicators display a pattern not listed in the table below, turn the projector off, unplug it, and contact Epson for help.

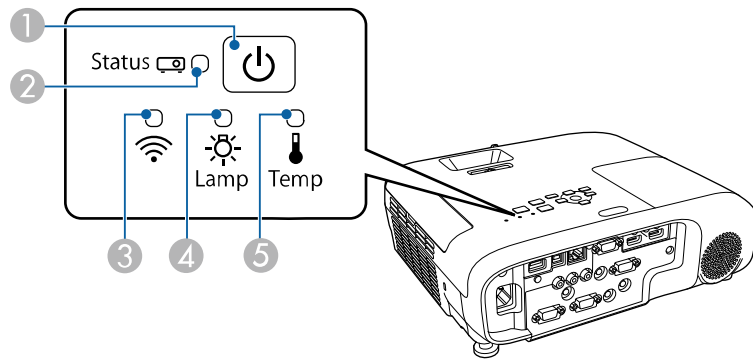

EB-E20/EB-E10/EB-E01/VS260

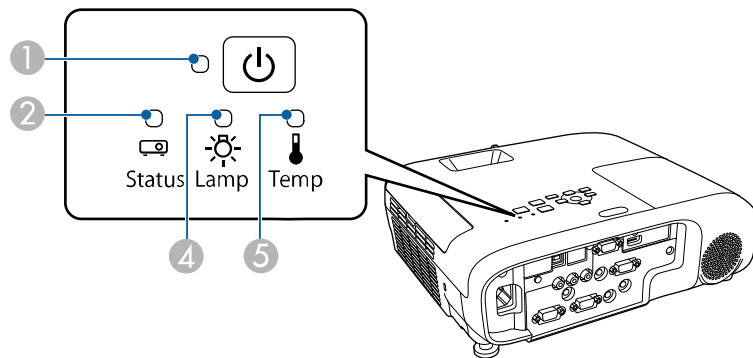

- 1 Power indicator
- 2 Status indicator

- 3 Wireless LAN indicator
- 4 Lamp indicator
- 5 Temp (temperature) indicator

Projector status

Indicator and status	Problem and solutions
Power: Lit blue Status: Lit blue Lamp: Off Temp: Off	Normal operation.
Power: Lit blue Status: Flashing blue Lamp: Off Temp: Off	Warming up, shutting down, or cooling down. When warming up, wait about 30 seconds for an image to appear. All buttons are disabled during warm-up, shutting down, and cooling down.
Power: Lit blue Status: Off Lamp: Off Temp: Off	Standby, sleep mode, or monitoring. When you press the power button, projection starts.
Power: Flashing blue Status: Off Lamp: Off Temp: Off	Preparing for monitoring and all features are disabled.
Power: Flashing blue Status: Indicator status varies Lamp: Indicator status varies Temp: Flashing orange	Projector is too hot. <ul style="list-style-type: none"> • Make sure that the vents and air filter are not clogged with dust or obstructed by nearby objects. • Clean or replace the air filter. • Make sure the environmental temperature is not too hot.

Indicator and status	Problem and solutions
Power: Off Status: Flashing blue Lamp: Off Temp: Lit orange	<p>Projector has overheated and turned off. Leave it turned off to cool down for 5 minutes.</p> <ul style="list-style-type: none"> • Make sure that the vents and air filter are not clogged with dust or obstructed by nearby objects. • Make sure the environmental temperature is not too hot. • Clean or replace the air filter. • If operating the projector at high altitude, set the High Altitude Mode setting to On in the projector's menu. ☛ Extended > Operation > High Altitude Mode • If the problem persists, unplug the projector and contact Epson for help.
Power: Off Status: Flashing blue Lamp: Lit orange Temp: Off	<p>Lamp has a problem.</p> <ul style="list-style-type: none"> • Check to see if the lamp is burned out, broken, or installed incorrectly. Reseat or replace the lamp as necessary. • Clean the air filter. • If operating the projector at high altitude, set the High Altitude Mode setting to On in the projector's menu. ☛ Extended > Operation > High Altitude Mode • If the problem persists, unplug the projector and contact Epson for help. <p>Lamp cover has a problem.</p> <ul style="list-style-type: none"> • Check that the lamp and the lamp cover are securely installed. The lamp does not turn on if the lamp and the lamp cover are not installed correctly.
Power: Flashing blue Status: Indicator status varies Lamp: Flashing orange Temp: Indicator status varies	<p>Replace the lamp soon to avoid damage. Do not continue using the projector.</p>

Indicator and status	Problem and solutions
Power: Off Status: Flashing blue Lamp: Off Temp: Flashing orange	<p>A fan or sensor has a problem.</p> <p>Turn the projector off, unplug it, and contact Epson for help.</p>
Power: Off Status: Flashing blue Lamp: Flashing orange Temp: Off	<p>Internal projector error.</p> <p>Turn the projector off, unplug it, and contact Epson for help.</p>
Power: Off Status: Flashing blue Lamp: Flashing orange Temp: Flashing orange	<p>Auto iris error. Turn the projector off, unplug it, and contact Epson for help.</p>
Power: Off Status: Flashing blue Lamp: Lit orange Temp: Lit orange	<p>Power error (Ballast). Turn the projector off, unplug it, and contact Epson for help.</p>

Wireless LAN status

Wireless LAN indicator status	Problem and solutions
Lit blue	Wireless LAN is available.
Flashing blue (quickly)	Connecting to a device.
Flashing blue (slowly)	An error has occurred. Turn off the projector and restart it.
Off	Wireless LAN is not available. Make sure the wireless LAN settings are correct.

» Related Links

- "List of Functions" [p.10](#)
- "Cleaning the Air Filter and Vents" [p.160](#)
- "Replacing the Air Filter" [p.160](#)

- "Replacing the Lamp" [p.163](#)

You can display information to help you solve common problems using the projector's Help system.

- 1** Turn on the projector.
- 2** Press the [Home] button on the control panel or remote control.

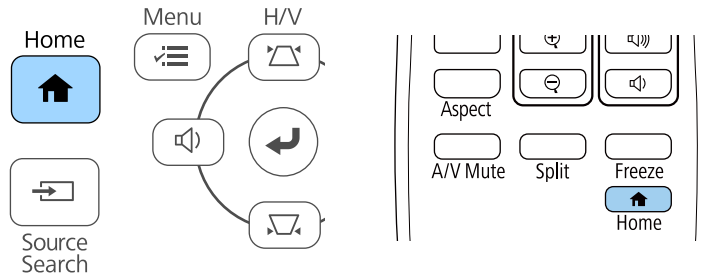

- 3** Select **Help** on the Home screen.



The Help menu is displayed.

- 4** Use the up and down arrow buttons to highlight the problem you want to solve.

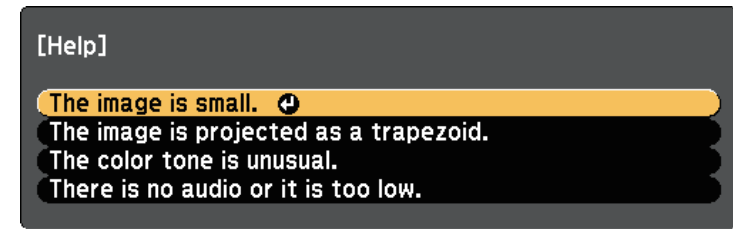

- 5** Press [Enter] to view the solutions.
- 6** Perform one of the following actions when you are finished.
 - To select another problem to solve, press [Esc].
 - To exit the help system, press [Menu].

Check the solutions in these sections if you have any problems with projected images or sound.

► Related Links

- "Solutions When No Image Appears" [p.173](#)
- "Solutions When Image is Incorrect Using the USB Display Function" [p.173](#)
- "Solutions When "No Signal" Message Appears" [p.174](#)
- "Solutions When "Not Supported" Message Appears" [p.174](#)
- "Solutions When Only a Partial Image Appears" [p.175](#)
- "Solutions When the Image is not Rectangular" [p.175](#)
- "Solutions When the Image Contains Noise or Static" [p.175](#)
- "Solutions When the Image is Fuzzy or Blurry" [p.176](#)
- "Solutions When the Image Brightness or Colors are Incorrect" [p.176](#)
- "Solutions to Sound Problems" [p.177](#)
- "Solutions When Image File Names are not Displayed Correctly in PC Free" [p.177](#)

Solutions When No Image Appears

If no image appears, try the following solutions:

- Make sure the lens cover is open all the way.
- Press the [A/V Mute] button on the remote control to see if the image was temporarily turned off.
- Make sure all necessary cables are securely connected and the power is on for the projector and connected video sources.
- Press the projector's power button to wake it from standby or sleep mode. Also, check if the connected computer is in sleep mode or displaying a blank screen saver.
- If the projector does not respond when you press the control panel buttons, the buttons may be locked for security. Unlock the buttons in the **Control Panel Lock** setting or use the remote control to turn on the projector.

☛ Settings > Lock Setting > Control Panel Lock

- Adjust the **Brightness** setting in the projector's **Image** menu.
- Select **High** or **Medium** as the **Power Consumption** setting.

☛ ECO > Power Consumption

- Check the **Display** setting in the projector's **Extended** menu to make sure **Messages** is set to **On**.
- The projector may not be able to project copyrighted videos that you play back on a computer. For more details, see the manual supplied with the computer.
- For images projected with Windows Media Center, reduce the screen size from full screen mode.
- For images projected from applications using Windows DirectX, turn off DirectX functions.

► Related Links

- "Input Signal Settings - Signal Menu" [p.131](#)
- "Image Quality Settings - Image Menu" [p.130](#)
- "Projector Setup Settings - ECO Menu" [p.147](#)
- "Projector Setup Settings - Extended Menu" [p.134](#)
- "Unlocking the Projector's Buttons" [p.85](#)

Solutions When Image is Incorrect Using the USB Display Function

If no image appears or if the image appears incorrectly using the USB Display function, try the following solutions:

- Press the [USB] button on the remote control.
- Disconnect the USB cable, and reconnect it.
- Make sure the Epson USB Display software has been installed correctly. Depending on your OS or computer settings, the software may not have been installed automatically. Download the latest software from the following Web site and install it.
epson.com/support/
- For Mac, select the **USB Display** icon in the **Dock** folder. If the icon does not appear on the **Dock**, double-click **USB Display** in the **Applications** folder.

If you select **Exit** from the **USB Display** icon menu on the **Dock**, USB Display does not start automatically when you connect the USB cable.

- If the mouse cursor flickers, select **Make the movement of the mouse pointer smooth** in the **Epson USB Display Settings** program on your computer.
- Turn off the **Transfer layered window** setting in the **Epson USB Display Settings** program on your computer.
- For images projected with Windows Media Center, reduce the screen size from full screen mode.
- For images projected from applications using Windows DirectX, turn off DirectX functions.

» Related Links

- "Connecting to a Computer for USB Video and Audio" [p.28](#)

Solutions When "No Signal" Message Appears

If the "No Signal" message appears, try the following solutions:

- Press the [Source Search] button and wait a few seconds for an image to appear.
- Turn on the connected computer or video source, and press play to begin your presentation, if necessary.
- Check that all cables required for projection are securely connected.
- If you are projecting from a laptop computer, make sure it is set up to display on an external monitor.
- If necessary, turn off the projector and the connected computer or video source, and then turn them back on.
- If you are projecting from an HDMI source, replace the HDMI cable with the shorter one.

» Related Links

- "Displaying From a Laptop" [p.174](#)
- "Displaying From a Mac Laptop" [p.174](#)

Displaying From a Laptop

If the message "No Signal" is displayed when projecting from a laptop, you need to set up the laptop to display on an external monitor.

- 1** Hold down the laptop's **Fn** key and press the key labeled with a monitor icon or **CRT/LCD**. Wait a few seconds for an image to appear.
- 2** To display on the laptop's monitor and the projector, try pressing the same keys again.
- 3** If the same image is not displayed by the laptop and projector, check the Windows **Display** utility to make sure the external monitor port is enabled and extended desktop mode is disabled.
- 4** If necessary, check your video card settings and set the multiple display option to **Clone** or **Mirror**.

Displaying From a Mac Laptop

If the message "No Signal" is displayed when projecting from a Mac laptop, you need to set up the laptop for mirrored display. (See your laptop manual for details.)

- 1** Open the **System Preferences** utility and select **Displays**.
- 2** Select the **Display** or **Color LCD** option, if necessary.
- 3** Click the **Arrange** or **Arrangement** tab.
- 4** Select **Mirror Displays**.

Solutions When "Not Supported" Message Appears

If the message "Not supported" is displayed, try the following solutions:

- Make sure the correct input signal is selected in the projector's **Signal** menu.
- Make sure the computer's display resolution does not exceed the projector's resolution and frequency limits. If necessary, select a different display resolution for your computer.

» Related Links

- "Input Signal Settings - Signal Menu" [p.131](#)
- "Supported Monitor Display Resolutions" [p.192](#)

Solutions When Only a Partial Image Appears

If only a partial computer image appears, try the following solutions:

- If you are projecting from a computer using a VGA computer cable, press the [Auto] button on the remote control to optimize the image signal.
- Try adjusting the image position using the **Position** setting in the projector's **Signal** menu.
- Press the [Aspect] button on the remote control to select a different image aspect ratio.
- Change the **Resolution** setting in the projector's **Signal** menu according to the signal for the connected equipment.
- If you zoomed into or out of the image using the [E-Zoom] buttons, press the [Default] button to return to the original image size.
- Check your computer display settings to disable dual display and set the resolution within the projector's limits.
- Check the resolution assigned to your presentation files to see if they are created for a different resolution.
- Make sure you selected the correct projection mode. You can select this using the **Projection** setting in the projector's **Extended** menu.

» Related Links

- "Input Signal Settings - Signal Menu" [p.131](#)
- "Projector Setup Settings - Extended Menu" [p.134](#)
- "Supported Monitor Display Resolutions" [p.192](#)

Solutions When the Image is not Rectangular

If the projected image is not evenly rectangular, try the following solutions:

- Place the projector directly in front of the center of the screen, facing it squarely, if possible.
- Set **Auto V-Keystone** to **On** in the projector's **Settings** menu. The projector automatically corrects the image every time you move the projector.
☛ **Settings > Keystone > H/V-Keystone > Auto V-Keystone**
- Set **H-Keystone Adjuster** to **On** in the projector's **Settings** menu. Then adjust the horizontal keystone slider until the image is evenly rectangular.
☛ **Settings > Keystone > H/V-Keystone > H-Keystone Adjuster**
- Press the keystone buttons on the projector to adjust the image shape.
- Adjust the Quick Corner setting to correct the image shape.
☛ **Settings > Keystone > Quick Corner**

» Related Links

- "Auto V-Keystone" [p.50](#)
- "Correcting the Image Shape with the Keystone Buttons" [p.51](#)
- "Correcting the Image Shape with Quick Corner" [p.52](#)
- "Correcting the Image Shape with the Horizontal Keystone Slider" [p.50](#)

Solutions When the Image Contains Noise or Static

If the projected image contains electronic interference (noise) or static, try the following solutions:

- Check the cables connecting your computer or video source to the projector. They should be:
 - Separated from the power cord to prevent interference
 - Securely connected at both ends
 - Not connected to an extension cable
- Check the settings in the projector's **Signal** menu to make sure they match the video source.

- If available for your video source, adjust the **Deinterlacing** and **Noise Reduction** settings in the projector's **Image** menu.
 - ☛ **Image > Image Enhancement > Noise Reduction**
 - ☛ **Image > Image Enhancement > Deinterlacing**
- Select **Auto** as the **Resolution** setting in the projector's **Signal** menu.
- Select a computer video resolution and refresh rate that are compatible with the projector.
- If you are projecting from a computer using a VGA computer cable, press the [Auto] button on the remote control to automatically adjust the **Tracking** and **Sync.** settings. If the images are not adjusted correctly, manually adjust the **Tracking** and **Sync.** settings in the projector's **Signal** menu.
- If you adjusted the image shape using the projector controls, try decreasing the **Sharpness** setting in the projector's **Image** menu to improve image quality.
- If you connected an extension power cable, try projecting without it to see if it caused interference in the signal.
- If you are using the USB Display function, turn off the **Transfer layered window** setting in the **Epson USB Display Settings** program on your computer.

» Related Links

- "Input Signal Settings - Signal Menu" [p.131](#)
- "Image Quality Settings - Image Menu" [p.130](#)
- "Supported Monitor Display Resolutions" [p.192](#)

Solutions When the Image is Fuzzy or Blurry

If the projected image is fuzzy or blurry, try the following solutions:

- Adjust the image focus.
- Position the projector close enough to the screen.
- Position the projector so the keystone adjustment angle is not so wide that it distorts the image.
- Clean the projector lens.



To avoid condensation on the lens after bringing the projector in from a cold environment, let the projector warm up to room temperature before using it.

- Adjust the **Sharpness** setting in the projector's **Image** menu to improve image quality.
- If you are projecting from a computer using a VGA computer cable, press the [Auto] button on the remote control to automatically adjust the tracking and sync. If any bands or overall blurriness remain, display a uniformly patterned image on the screen and manually adjust the **Tracking** and **Sync.** settings in the projector's **Signal** menu.
- If you are projecting from a computer, use a lower resolution or select a resolution that matches the projector's native resolution.

» Related Links

- "Auto V-Keystone" [p.50](#)
- "Input Signal Settings - Signal Menu" [p.131](#)
- "Image Quality Settings - Image Menu" [p.130](#)
- "Supported Monitor Display Resolutions" [p.192](#)
- "Focusing the Image Using the Focus Ring" [p.55](#)
- "Cleaning the Lens" [p.158](#)

Solutions When the Image Brightness or Colors are Incorrect

If the projected image is too dark or light, or the colors are incorrect, try the following solutions:

- Press the [Color Mode] button on the remote control to try different color modes for the image and environment.
- Check your video source settings.
- Adjust the available settings in the projector's **Image** menu for the current input source, such as **Brightness**, **Contrast**, **Tint**, and **Color Saturation**.
- Make sure you selected the correct **Video Signal** or **Video Range** setting in the projector's **Signal** menu, if available for your image source.

☛ **Signal > Advanced > Video Signal**

☛ **Signal > Advanced > Video Range**

- Make sure all the cables are securely connected to the projector and your video device. If you connected long cables, try connecting shorter cables.
- If you are using **ECO** as **Power Consumption**, try selecting **High** or **Medium**.

☛ **ECO > Power Consumption**



At high altitudes or locations subject to high temperatures, the image may become darker and you may not be able to adjust the **Power Consumption** setting.

- Position the projector close enough to the screen.
- If the image has been progressively darkening, you may need to replace the projector lamp soon.

» **Related Links**

- "Adjusting Image Quality (Color Mode)" [p.61](#)
- "Input Signal Settings - Signal Menu" [p.131](#)
- "Image Quality Settings - Image Menu" [p.130](#)
- "Projector Setup Settings - ECO Menu" [p.147](#)

Solutions to Sound Problems

If there is no sound or the volume is too low or high, try the following solutions:

- Adjust the projector's volume settings.
- Press the [A/V Mute] button on the remote control to resume video and audio if they were temporarily stopped.
- Check your computer or video source to make sure the volume is turned up and the audio output is set for the correct source.
- Check the audio cable connections between the projector and your video source.
- Make sure any connected audio cables are labeled "No Resistance".

- If you are using the USB Display function, turn on the **Output audio from the projector** setting in the **Epson USB Display Settings** program on your computer.
- Select the correct audio input in the **A/V Settings** setting in the projector's **Extended** menu.
- If you want to use a connected audio source when the projector is off, set the **Standby Mode** option to **Communication On** and make sure the **A/V Settings** options are set correctly in the projector's **Extended** menu.
 - ☛ **ECO > Standby Mode > Standby Mode**
- Check the **Mic Input Level** setting in the projector's **Settings** menu. If the setting is too high, the sound of other connected devices will be too low.
- If you do not hear sound from an HDMI source, set the connected device to PCM output.
- When you are connecting the projector to a Mac using an HDMI cable, make sure your Mac supports audio through the HDMI port. If not, you need to connect an audio cable.
- If the volume for the computer is set to the minimum while the projector is set to the maximum, the noise may be mixed. Turn up the computer's volume and turn down the projector's volume. (When you use Epson iProjection (Windows/Mac) or USB Display.)

» **Related Links**

- "Projector Connections" [p.27](#)
- "Projector Feature Settings - Settings Menu" [p.132](#)
- "Projector Setup Settings - Extended Menu" [p.134](#)
- "Projector Setup Settings - ECO Menu" [p.147](#)
- "Controlling the Volume with the Volume Buttons" [p.63](#)

Solutions When Image File Names are not Displayed Correctly in PC Free

If any file names are longer than the display area or include unsupported symbols, the file names are shortened or changed in PC Free. Shorten or change the file name.

Check the solutions in these sections if you have problems operating the projector or remote control.

► Related Links

- "Solutions to Projector Power or Shut-Off Problems" [p.178](#)
- "Solutions to Problems with the Remote Control" [p.178](#)
- "Solutions to Password Problems" [p.179](#)
- "Solution When "The Battery that Saves Your Clock Settings is Running Low" Message Appears" [p.179](#)

Solutions to Projector Power or Shut-Off Problems

If the projector does not turn on when you press the power button or it turns off unexpectedly, try the following solutions:

- Make sure the power cord is securely connected to the projector and to a working electrical outlet.
- If the power button on the remote control does not turn on the projector, check its batteries and make sure at least one of the remote receivers are available in the **Remote Receiver** setting in the projector's **Settings** menu.
- The projector's buttons may be locked for security. Unlock the buttons in the **Control Panel Lock** setting or use the remote control to turn on the projector.
☛ **Settings > Lock Setting > Control Panel Lock**
- If the projector's lamp turns off unexpectedly, it may have entered sleep mode after a period of inactivity. Perform any operation to wake the projector. To turn off sleep mode, select **Off** as the **Sleep Mode** setting in the projector's **ECO** menu.
- If the projector's lamp turns off unexpectedly, the A/V mute timer may be enabled. To turn off the A/V mute timer, select **Off** as the **A/V Mute Timer** setting in the projector's **ECO** menu.
- If the projector's lamp turns off unexpectedly, the lens cover timer may be enabled. To turn off the lens cover timer, select **Off** as the **Lens Cover Timer** setting in the projector's **ECO** menu.

- If the projector's lamp turns off, the status indicator is flashing, and the temp (temperature) indicator is lit, the projector has overheated and turned off.
- The cooling fans may run in standby status depending on the projector settings. Also, when the projector wakes from standby status, the fans may cause an unexpected noise. This is not a malfunction.
- The power cord may be defective. Disconnect the cord and contact Epson for help.

► Related Links

- "Projector Setup Settings - ECO Menu" [p.147](#)
- "Projector Indicator Status" [p.169](#)
- "Projector Feature Settings - Settings Menu" [p.132](#)
- "Unlocking the Projector's Buttons" [p.85](#)

Solutions to Problems with the Remote Control

If the projector does not respond to remote control commands, try the following solutions:

- Check that the remote control batteries are installed correctly and have power. If necessary, replace the batteries.
- Make sure you are operating the remote control within the reception angle and range of the projector.
- Make sure the projector is not warming up or shutting down.
- Check to see if a button on the remote control is stuck down, causing it to enter sleep mode. Release the button to wake the remote control up.
- Strong fluorescent lighting, direct sunlight, or infrared device signals may be interfering with the projector's remote receivers. Dim the lights or move the projector away from the sun or interfering equipment.
- Make sure at least one of the remote receivers are available in the **Remote Receiver** setting in the projector's **Settings** menu.
- If the **Remote Receiver** setting is disabled, hold down the [Menu] button on the remote control for at least 15 seconds to reset the setting to its default.

- If you assigned an ID number to the projector to operate multiple projectors from the remote control, you may need to check or change the ID setting.
- Press the 0 (zero) button on the remote control while holding down the [ID] button. By selecting 0 on the remote control, you can operate all of the projectors regardless of the projector ID settings.
- If you lose the remote control, you can order another one from Epson.

» Related Links

- "Remote Control Operation" [p.36](#)
- "Projector Feature Settings - Settings Menu" [p.132](#)
- "Selecting the Projector You want to Operate" [p.79](#)
- "Installing Batteries in the Remote Control" [p.35](#)

Solutions to Password Problems

If you cannot enter or remember a password, try the following solutions:

- You may have turned on password protection without first setting a password. Try entering **0000** using the remote control.
- If you have entered an incorrect password too many times and see a message displaying a request code, write down the code and contact Epson for help. Provide the request code and proof of ownership for assistance in unlocking the projector.
- If you set a Epson Web Control password and forgot the user ID or password, try entering the following:
 - User ID: **EPSONWEB**
 - Default password: **admin**
- If you set a Remote password (in Epson Web Control) and forgot the user ID or password, try entering the following:
 - User ID: **EPSONREMOTE**
 - Default password: **guest**
- If you lose the remote control you cannot enter a password. Order a new one from Epson.

Solution When "The Battery that Saves Your Clock Settings is Running Low" Message Appears

If the message "The battery that saves your clock settings is running low." is displayed, contact Epson for help.

Check the solutions in these sections if you have problems using the projector on a network.

► **Related Links**

- "Solutions When Wireless Authentication Fails" [p.180](#)
- "Solutions When You Cannot Access the Projector Through the Web" [p.180](#)
- "Solutions When Network Alert E-Mails are not Received" [p.180](#)
- "Solutions When the Image Contains Static During Network Projection" [p.181](#)
- "Solutions When You Cannot Connect Using Screen Mirroring" [p.181](#)
- "Solutions When the Image or Sound Contains Static During Screen Mirroring Connection" [p.181](#)

Solutions When Wireless Authentication Fails

If you are having trouble with the authentication, try the following solutions:

- If the wireless settings are correct, but authentication fails, you may need to update the **Date & Time** settings.
 - ☛ **Extended > Operation > Date & Time**
- Check the **Security** settings in the projector's **Network** menu.
 - ☛ **Network > Network Configuration > Wireless LAN**
- If the access point security is WPA3-EAP, change the access point setting to WPA2/WPA3-EAP.

► **Related Links**

- "Projector Setup Settings - Extended Menu" [p.134](#)
- "Network Menu - Wireless LAN Menu" [p.140](#)

Solutions When You Cannot Access the Projector Through the Web

If you are unable to access the projector through a Web browser, make sure you are using the correct ID and password.

- For the user ID, enter **EPSONWEB**. (You cannot change the user ID.)

- For the password, enter the password set in the projector's **Network** menu. The default password is **admin**.
- Make sure you have access to the network the projector is on.
- If your Web browser is set up to connect via a proxy server, the **Epson Web Control** screen cannot be displayed. Make settings for a connection without using a proxy server.
- If you set **Standby Mode** to **Communication On** in the projector's menu in standby mode, make sure the network device is turned on. After turning on the network device, turn on the projector.
 - ☛ **ECO > Standby Mode > Standby Mode**



The user ID and password are case sensitive.

► **Related Links**

- "Network Menu - Basic Menu" [p.139](#)

Solutions When Network Alert E-Mails are not Received

If you do not receive an e-mail alerting you to problems with a projector over the network, try the following solutions:

- Make sure the projector is turned on and connected to the network correctly. (If an error shuts down the projector, the email may not be delivered.)
- Make sure you set up the projector e-mail alert settings correctly in the projector's network **Notifications** menu or in the network software.
- Set the **Standby Mode** setting to **Communication On** so that the network software can monitor the projector in standby mode.
 - ☛ **ECO > Standby Mode > Standby Mode**
- Change the **Port** setting according to your network environment.
 - ☛ **ECO > Standby Mode > Port**

» Related Links

- "Network Menu - Notifications Menu" [p.144](#)
- "Projector Setup Settings - ECO Menu" [p.147](#)

Solutions When the Image Contains Static During Network Projection

If the projected image contains static during network projection, try the following solutions:

- Check for any obstacles between the access point, the computer, the mobile device, and the projector, and change their positions to improve communication.
- Make sure that the access point, the computer, the mobile device and the projector are not too far apart. Move them closer together and try to connect again.
- Check for interference from other equipment, such as a Bluetooth device or microwave. Move the interfering device farther away or expand your wireless bandwidth.
- Reduce the number of connected devices if the connection speed declines.

Solutions When You Cannot Connect Using Screen Mirroring

If you are unable to connect to the projector using Screen Mirroring, try the following solutions:

- Check the projector's settings.
 - Select **On** as the **Screen Mirroring** setting in the projector's **Network** menu.
 - Change the **Display Name** so that it does not include "-" in the projector's Screen Mirroring Settings setting menu or it may not be displayed correctly on your mobile device.
 - ☛ **Network > Screen Mirroring Settings > Display Name**

- Select **Off** as the **Screen Mirroring** setting in the projector's **Network** menu, and select **On** again.
- Change the **Operation Mode** setting and connect again.
 - ☛ **Network > Screen Mirroring Settings > Operation Mode**
- Make sure that the no other devices are connected to the projector with **No Interruptions** settings.
 - ☛ **Network > Screen Mirroring Settings > Extended > Meeting Mode**
- Change the **Channel** setting according to the wireless LAN environment.
 - ☛ **Network > Screen Mirroring Settings > Extended > Channel**
- Check the mobile device's settings.
 - Make sure the settings on the mobile device are correct.
 - When connecting again immediately after disconnecting, it may take some time until the connection is established. Reconnect after waiting for a while.
 - Restart the mobile device.
 - Once you have connected using Screen Mirroring, the projector connection information may be recorded on the mobile device. However, you may not be able to reconnect to the projector from the recorded information. Select the projector from the list of available devices.

» Related Links

- "Projector Network Settings - Network Menu" [p.137](#)
- "Network Menu - Screen Mirroring Settings" [p.138](#)

Solutions When the Image or Sound Contains Static During Screen Mirroring Connection

If the projected image or sound contains static when connecting using Screen Mirroring, try the following solutions:

- Avoid covering the Wi-Fi antenna of the mobile device.
- If you use a Screen Mirroring connection and an internet connection at the same time, the image may stop or contain noise. Disconnect the internet connection to expand your wireless bandwidth and improve the connection speed of the mobile device.

- Make sure the projection contents meet the Screen Mirroring requirements.
- Depending on the settings of the mobile device, the connection may be lost when the device enters power saving mode. Check the electrical power saving settings on the mobile device.
- Update to the latest version of the wireless driver or firmware on the mobile device.

» **Related Links**

- "Wireless Network Projection from a Mobile Device (Screen Mirroring)"
[p.99](#)

Appendix

Check these sections for the technical specifications and important notices about your projector.

► **Related Links**

- "Optional Accessories and Replacement Parts" [p.184](#)
- "Screen Size and Projection Distance" [p.186](#)
- "Supported Monitor Display Resolutions" [p.192](#)
- "Projector Specifications" [p.194](#)
- "External Dimensions" [p.199](#)
- "USB Display System Requirements" [p.203](#)
- "List of Safety Symbols and Instructions" [p.204](#)
- "Glossary" [p.206](#)
- "Notices" [p.208](#)

The following optional accessories and replacement parts are available. Please purchase these products as and when needed.

The following list of optional accessories and replacement parts is current as of: January 2020.

Details of accessories are subject to change without notice and availability may vary depending on the country of purchase.

► Related Links

- "Screens" [p.184](#)
- "Cables" [p.184](#)
- "Mounts" [p.184](#)
- "For Wireless Connection" [p.184](#)
- "External Devices" [p.185](#)
- "Replacement Parts" [p.185](#)

Screens

80" portable screen ELPSC24

Portable roll-type screens. (aspect ratio 16:10)

50" portable screen ELPSC32

A compact screen that can be carried easily. (aspect ratio 4:3)

80" Mobile X-Type Screen ELPSC21

Portable X-type screens. (aspect ratio 16:9)

Multi Aspect Screen ELPSC26

Portable multi-aspect screen.

Cables

Computer cable ELPKC02 (1.8 m - for mini D-sub 15-pin/mini D-Sub 15pin)

Computer cable ELPKC09 (3 m - for mini D-sub 15-pin/mini D-Sub 15pin)

Computer cable ELPKC10 (20 m - for mini D-sub 15-pin/mini D-Sub 15pin)

Use when connecting to the Computer port.

Mounts

Ceiling mount ELPMB23

Use when installing the projector on a ceiling.

Safety Wire Set ELPWR01

Use when connecting the projector to the installation mount to prevent the projector from falling down.

Ceiling pipe (450 mm) ELPFP13

Ceiling pipe (700 mm) ELPFP14

Use when installing the projector on a high ceiling.



Special expertise is required to suspend the projector from a ceiling.
Contact Epson for help.

For Wireless Connection

Wireless LAN module ELPAP11

Use this to project images from a computer via a wireless communication.
(Frequency band: 2.4 GHz/5 GHz)

External Devices

Document Camera ELPDC21/ELPDC13/ELPDC07

Use when projecting image such as books, OHP documents, or slides.

Soft carrying case ELPKS69

(VS260/EB-W52/EB-W51/EB-X51/EB-E10/EB-FH06/EB-W06/EB-X06/
EB-E01/EB-X500)

Use this to carry the projector by hand.

Soft carrying case ELPKS70

(EB-992F/EB-982W/EB-972/EB-118/EB-W49/EB-X49/EB-E20/EB-FH52)

Use this to carry the projector by hand.

Replacement Parts

Lamp unit ELPLP97

Use as a replacement for used lamps.

Air filter ELPAF54 (EB-992F/EB-982W/EB-972/EB-FH52)

Use as a replacement for used air filters.

Air filter ELPAF32

(VS260/EB-118/EB-W49/EB-X49/EB-E20/EB-W52/EB-W51/EB-X51/EB-
E10/EB-F H06/EB-W06/EB-X06/EB-E01/EB-X500)

Use as a replacement for used air filters.

Check the table here to determine how far to place the projector from the screen based on the size of the projected image.

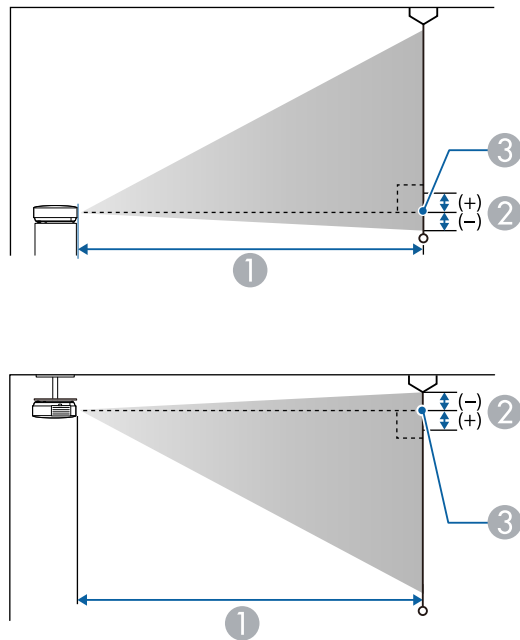

- ① Projection distance (cm)
- ② Distance from the center of the lens to the base of the screen (or to the top of the screen, if suspended from a ceiling) (cm)
- ③ Center of lens

EB-E20/EB-E10/EB-E01/VS260

4:3 screen size		①	②
		Minimum (Wide) to Maximum (Tele)	
30"	61 × 46	87 - 118	-5
50"	102 × 76	146 - 198	-8

4:3 screen size		①	②
		Minimum (Wide) to Maximum (Tele)	
60"	122 × 91	176 - 238	-10
70"	142 × 107	205 - 278	-12
80"	163 × 122	235 - 318	-14
100"	203 × 152	294 - 398	-17
150"	305 × 229	442 - 598	-25
200"	406 × 305	590 - 797	-34
300"	610 × 457	886	-51
350"	711 × 533	1034	-59

16:9 screen size		①	②
		Minimum (Wide) to Maximum (Tele)	
28"	62 × 35	88 - 120	1
30"	66 × 37	95 - 129	1
50"	111 × 62	159 - 216	1
60"	133 × 75	192 - 259	1
70"	155 × 87	224 - 303	2
80"	177 × 100	256 - 346	2
100"	221 × 125	321 - 433	2
150"	332 × 187	482 - 651	3
200"	443 × 249	643 - 869	5
300"	664 × 374	966	7
320"	708 × 398	1030	7

Note: You can also use the online [Projection Distance Calculator](#) to determine projector placement.

16:10 screen size		①	②
		Minimum (Wide) to Maximum (Tele)	
29"	62 × 39	89 - 121	-1
30"	65 × 40	92 - 125	-1
50"	108 × 67	155 - 210	-2
60"	129 × 81	186 - 252	-3
70"	151 × 94	218 - 295	-3
80"	172 × 108	249 - 337	-4
100"	215 × 135	312 - 422	-4
150"	323 × 202	469 - 633	-7
200"	431 × 269	626 - 845	-9
300"	646 × 404	939	-13
330"	711 × 444	1034	-15

16:9 screen size		①	②
		Minimum (Wide) to Maximum (Tele)	
28"	62 × 35	90 - 109	1
30"	66 × 37	97 - 117	1
40"	89 × 50	130 - 156	1
50"	111 × 62	163 - 196	1
60"	133 × 75	196 - 236	1
80"	177 × 100	263 - 316	2
100"	221 × 125	329 - 396	2
150"	332 × 187	495 - 595	3
200"	443 × 249	661 - 794	5
250"	553 × 311	827 - 994	6
275"	609 × 342	910 - 1093	6

EB-118/EB-X49/EB-X51/EB-X06/EB-X500

4:3 screen size		①	②
		Minimum (Wide) to Maximum (Tele)	
30"	61 × 46	89 - 107	-5
40"	81 × 61	119 - 143	-7
50"	102 × 76	150 - 180	-8
60"	122 × 91	180 - 217	-10
80"	163 × 122	241 - 290	-14
100"	203 × 152	302 - 363	-17
150"	305 × 229	454 - 546	-25
200"	406 × 305	607 - 729	-34
250"	508 × 381	759 - 912	-42
300"	610 × 457	912 - 1095	-51

16:10 screen size		①	②
		Minimum (Wide) to Maximum (Tele)	
29"	62 × 39	91 - 110	-1
30"	65 × 40	94 - 113	-1
40"	86 × 54	126 - 152	-2
50"	108 × 67	159 - 191	-2
60"	129 × 81	191 - 230	-3
80"	172 × 108	256 - 307	-4
100"	215 × 135	320 - 385	-4
150"	323 × 202	482 - 579	-7
200"	431 × 269	643 - 773	-9
250"	538 × 337	805 - 967	-11
280"	603 × 377	902 - 1083	-13

EB-W49/EB-W52/EB-W51/EB-W06

16:10 screen size		①	②
		Minimum (Wide) to Maximum (Tele)	
33"	71 × 44	91 - 110	-4
35"	75 × 47	97 - 117	-4
40"	86 × 54	111 - 134	-5
50"	108 × 67	139 - 168	-6
60"	129 × 81	168 - 202	-7
80"	172 × 108	225 - 270	-10
100"	215 × 135	281 - 338	-12
150"	323 × 202	424 - 509	-18
200"	431 × 269	566 - 680	-24
320"	689 × 431	907 - 1089	-39

4:3 screen size		①	②
		Minimum (Wide) to Maximum (Tele)	
29"	59 × 44	90 - 109	-4
30"	61 × 46	94 - 113	-4
40"	81 × 61	126 - 152	-5
50"	102 × 76	158 - 190	-7
60"	122 × 91	190 - 229	-8
70"	142 × 107	222 - 267	-10
80"	163 × 122	255 - 306	-11
100"	203 × 152	319 - 383	-14
150"	305 × 229	480 - 577	-20
200"	406 × 305	641 - 770	-27
280"	569 × 427	898 - 1079	-38

16:9 screen size		①	②
		Minimum (Wide) to Maximum (Tele)	
32"	71 × 40	91 - 109	-2
35"	77 × 44	99 - 120	-2
40"	89 × 50	114 - 137	-2
50"	111 × 62	143 - 172	-3
60"	133 × 75	172 - 208	-3
70"	155 × 87	202 - 243	-4
80"	177 × 100	231 - 278	-4
100"	221 × 125	289 - 348	-5
150"	332 × 187	435 - 523	-8
200"	443 × 249	582 - 699	-11
310"	686 × 386	903 - 1084	-17

EB-FH06

16:9 screen size		①	②
		Minimum (Wide) to Maximum (Tele)	
34"	75 × 42	91 - 109	-3
40"	89 × 50	107 - 129	-3
50"	111 × 62	135 - 162	-4
60"	133 × 75	162 - 195	-5
80"	177 × 100	217 - 261	-7
100"	221 × 125	272 - 327	-8
150"	332 × 187	410 - 492	-12
200"	443 × 249	547 - 658	-16
250"	553 × 311	685 - 823	-20
332"	735 × 413	911 - 1094	-27

4:3 screen size		①	②
		Minimum (Wide) to Maximum (Tele)	
28"	57 × 43	91 - 110	-3
30"	61 × 46	98 - 118	-3
40"	81 × 61	132 - 159	-4
50"	102 × 76	165 - 199	-5
60"	122 × 91	199 - 240	-6
80"	163 × 122	266 - 320	-8
100"	203 × 152	334 - 401	-10
150"	305 × 229	502 - 603	-15
200"	406 × 305	671 - 806	-20
250"	508 × 381	839 - 1008	-25

16:10 screen size		①	②
		Minimum (Wide) to Maximum (Tele)	
40"	86 × 54	116 - 140	-4
50"	108 × 67	146 - 176	-4
60"	129 × 81	175 - 211	-5
70"	151 × 94	205 - 247	-6
80"	172 × 108	235 - 283	-7
100"	215 × 135	294 - 354	-9
150"	323 × 202	443 - 533	-13
200"	431 × 269	592 - 711	-18
250"	538 × 337	741 - 890	-22
280"	603 × 377	830 - 997	-25

EB-972

4:3 screen size		①	②
		Minimum (Wide) to Maximum (Tele)	
27"	55 × 41	85 - 140	-2
40"	81 × 61	128 - 208	-3
50"	102 × 76	160 - 261	-4
60"	122 × 91	193 - 314	-4
80"	163 × 122	258 - 420	-6
100"	203 × 152	323 - 525	-7
150"	305 × 229	486 - 789	-11
200"	406 × 305	649 - 1054	-15
250"	508 × 381	812 - 1318	-19
262"	532 × 399	852 - 1381	-20

16:9 screen size		①	②
		Minimum (Wide) to Maximum (Tele)	
25"	55 × 31	86 - 141	3
30"	66 × 37	104 - 170	4
40"	89 × 50	139 - 227	5
50"	111 × 62	175 - 285	6
60"	133 × 75	210 - 342	8
80"	177 × 100	281 - 458	10
100"	221 × 125	352 - 573	13
120"	266 × 149	424 - 688	15
150"	332 × 187	530 - 860	19
200"	443 × 249	708 - 1148	25
241"	534 × 300	853 - 1384	30

16:10 screen size		①	②
		Minimum (Wide) to Maximum (Tele)	
25"	54 × 34	84 - 137	1
30"	65 × 40	101 - 165	2
40"	86 × 54	135 - 221	2
50"	108 × 67	170 - 277	3
60"	129 × 81	205 - 333	3
80"	172 × 108	274 - 445	4
100"	215 × 135	343 - 557	6
120"	258 × 162	412 - 669	7
150"	323 × 202	516 - 837	8
200"	431 × 269	689 - 1117	11
247"	532 × 333	851 - 1380	14

4:3 screen size		①	②
		Minimum (Wide) to Maximum (Tele)	
26"	53 × 40	86 - 142	-1
30"	61 × 46	100 - 164	-1
40"	81 × 61	134 - 219	-2
50"	102 × 76	169 - 275	-2
60"	122 × 91	203 - 331	-2
70"	142 × 107	237 - 386	-3
80"	163 × 122	271 - 442	-3
100"	203 × 152	340 - 553	-4
150"	305 × 229	511 - 831	-6
200"	406 × 305	682 - 1108	-8
240"	488 × 366	820 - 1330	-9

EB-982W

16:10 screen size		①	②
		Minimum (Wide) to Maximum (Tele)	
29"	62 × 39	85 - 140	-1
35"	75 × 47	103 - 169	-1
40"	86 × 54	118 - 193	-1
50"	108 × 67	149 - 243	-2
60"	129 × 81	179 - 292	-2
80"	172 × 108	239 - 390	-3
100"	215 × 135	300 - 488	-3
150"	323 × 202	451 - 733	-5
200"	431 × 269	603 - 979	-7
280"	603 × 377	845 - 1371	-9

16:9 screen size		①	②
		Minimum (Wide) to Maximum (Tele)	
29"	64 × 36	87 - 143	1
35"	77 × 44	106 - 174	1
40"	89 × 50	122 - 199	1
50"	111 × 62	153 - 249	2
60"	133 × 75	184 - 300	2
70"	155 × 87	215 - 350	2
80"	177 × 100	246 - 401	3
100"	221 × 125	308 - 502	3
150"	332 × 187	464 - 754	5
200"	443 × 249	619 - 1006	7
270"	598 × 336	837 - 1359	9

EB-992F/EB-FH52

16:9 screen size		①	②
		Minimum (Wide) to Maximum (Tele)	
30"	66 × 37	87 - 142	0
40"	89 × 50	116 - 190	0
50"	111 × 62	146 - 238	0
60"	133 × 75	176 - 286	0
80"	177 × 100	235 - 382	0
100"	221 × 125	295 - 478	0
150"	332 × 187	443 - 719	0
200"	443 × 249	591 - 959	1
250"	553 × 311	740 - 1200	1
300"	664 × 374	888 - 1441	1

4:3 screen size		①	②
		Minimum (Wide) to Maximum (Tele)	
25"	51 × 38	88 - 145	0
30"	61 × 46	107 - 174	0
40"	81 × 61	143 - 233	0
60"	122 × 91	216 - 351	0
80"	163 × 122	288 - 468	0
100"	203 × 152	361 - 586	0
120"	244 × 183	434 - 704	0
150"	305 × 229	543 - 880	1
200"	406 × 305	724 - 1175	1
220"	447 × 335	797 - 1293	1
245"	498 × 373	888 - 1440	1

16:10 screen size		①	②
		Minimum (Wide) to Maximum (Tele)	
28"	60 × 38	87 - 143	0
30"	65 × 40	94 - 153	0
40"	86 × 54	126 - 205	0
60"	129 × 81	190 - 309	0
80"	172 × 108	254 - 413	0
100"	215 × 135	319 - 517	0
120"	258 × 162	383 - 621	0
150"	323 × 202	479 - 777	1
200"	431 × 269	640 - 1037	1
250"	538 × 337	800 - 1297	1
277"	597 × 373	887 - 1438	1

The tables here list the compatible refresh rate and resolution for each compatible video display format.

Computer Signals (Analog RGB)

Signal	Refresh rate (Hz)	Resolution (dots)
VGA	60/72/75/85	640 × 480
SVGA	60/72/75/85	800 × 600
XGA	60/70/75/85	1024 × 768
WXGA	60	1280 × 768
	60	1366 × 768
	60/75/85	1280 × 800
WXGA+	60/75/85	1440 × 900
WXGA++	60	1600 × 900
SXGA	70/75/85	1152 × 864
	60/75/85	1280 × 960
	60/75/85	1280 × 1024
SXGA+	60/75	1400 × 1050
WSXGA+ *	60	1680 × 1050
UXGA	60	1600 × 1200
1920 × 1080 **	50/60	1920 × 1080

* Available only for projectors with a resolution of Full HD (1,920 × 1,080) or WXGA (1,280 × 800), and compatible only when **Wide** is selected as the **Resolution** setting in the projector's **Signal** menu.

** Available only for projectors with a resolution of Full HD (1,920 × 1,080).

Even when signals other than those mentioned above are input, it is likely that the image can be projected. However, not all functions may be supported.

Composite Video

Signal	Refresh rate (Hz)	Resolution (dots)
TV (NTSC)	60	720 × 480
TV (SECAM)	50	720 × 576
TV (PAL)	50/60	720 × 576

HDMI Port Input Signals

Signal	Refresh rate (Hz)	Resolution (dots)
VGA	60	640 × 480
SVGA	60	800 × 600
XGA	60	1024 × 768
WXGA	60	1280 × 800
	60	1366 × 768
WXGA+	60	1440 × 900
WXGA++	60	1600 × 900
SXGA	60	1280 × 960
	60	1280 × 1024
SXGA+	60	1400 × 1050
WSXGA+ *	60	1680 × 1050
UXGA	60	1600 × 1200
1920 × 1080	50/60	1920 × 1080
WUXGA (Reduced Blanking) **	60	1920 × 1200
SDTV (480i/480p)	59.94	720 × 480
SDTV (576i/576p)	50	720 × 576
HDTV (720p)	50/59.94/60	1280 × 720
HDTV (1080i)	50/59.94/60	1920 × 1080
HDTV (1080p)	23.98/24/29.97/30/50/59.94/60	1920 × 1080

* Available only for projectors with a resolution of Full HD (1,920 × 1,080) or WXGA (1,280 × 800).

** Available only for projectors with a resolution of Full HD (1,920 × 1,080).

EB-972/EB-118/EB-X49/EB-E20/EB-X51/EB-E10/EB-X06/EB-E01/EB-X500/VS260

Product name	EB-972/EB-118/EB-X49/EB-E20/EB-X51/EB-E10/EB-X06/EB-E01/EB-X500/VS260
Dimensions	<p>EB-972 309 (W) × 90 (H) × 282 (D) mm (not including raised section)</p> <p>EB-118/EB-X49/EB-E20 302 (W) × 87 (H) × 249 (D) mm (not including raised section)</p> <p>EB-X51/EB-E10/EB-X06/EB-E01/EB-X500/VS260 302 (W) × 77 (H) × 234 (D) mm (not including raised section)</p>
LCD panel size	0.55"
Display method	Poly-silicon TFT active matrix
Resolution	786,432 pixels XGA (1,024 (W) × 768 (H) dots) × 3
Focus adjustment	Manual
Zoom adjustment	<p>EB-972 1 to 1.6 (Optical Zoom)</p> <p>EB-118/EB-X49/EB-X51/EB-X06/EB-X500 1 to 1.2 (Optical Zoom)</p> <p>EB-E20/EB-E10/EB-E01/VS260 1 to 1.35 (Digital Zoom)</p>
Lamp	<p>EB-972 UHE lamp, 230 W Model No.: ELPLP97</p> <p>EB-118/EB-X49/EB-E20/EB-X51/EB-E10/EB-X06/EB-E01/EB-X500/VS260 UHE lamp, 210 W Model No.: ELPLP97</p>

Lamp life	<p>EB-972 High Power Consumption mode: Up to 6,500 hours Medium Power Consumption mode: Up to 10,000 hours ECO Power Consumption mode: Up to 17,000 hours</p> <p>EB-118 High Power Consumption mode: Up to 8,000 hours Medium Power Consumption mode: Up to 10,000 hours ECO Power Consumption mode: Up to 17,000 hours</p> <p>EB-X49/EB-E20/EB-X51/EB-E10/EB-X06/EB-E01/EB-X500/VS260 High Power Consumption mode: Up to 6,000 hours ECO Power Consumption mode: Up to 12,000 hours</p>
Air filter maintenance cycle	<p>EB-972 10,000 hours</p> <p>EB-118/EB-X49/EB-E20/EB-X51/EB-E10/EB-X06/EB-E01/EB-X500/VS260 6,000 hours</p>
Max. audio output	<p>EB-972/EB-118 16 W</p> <p>EB-X49/EB-E20 5 W</p> <p>EB-X51/EB-E10/EB-X06/EB-E01/EB-X500/VS260 2 W</p>
Speaker	1
Power supply	100-240V AC±10% 50/60Hz 3.5 - 1.6 A
Power consumption (100 to 120 V area)	Operating: 345 W
Power consumption (220 to 240 V area)	Operating: 327 W
Standby power consumption	Communication On: 2.0 W Communication Off: 0.3 W
Operating altitude	Altitude 0 to 3,048 m

Operating temperature *	Altitude of 0 to 2,286 m: +5 to +40°C (No condensation) Altitude of 2,287 to 3,048 m: +5 to +35°C (Humidity of 20 to 80%, No condensation)
Storage temperature	-10 to +60°C (Humidity of 10 to 90%, No condensation)
Mass	EB-972: Approx. 3.1 kg EB-118: Approx. 2.8 kg EB-X49/EB-E20: Approx. 2.7 kg EB-X51/EB-X06/EB-X500: Approx. 2.5 kg EB-E10/EB-E01/VS260: Approx. 2.4 kg

* Lamp brightness automatically dims if the surrounding temperature gets too high. (Approximately 35°C at an altitude of 0 to 2,286 m, and approximately 30°C at an altitude of 2,287 to 3,048 m; however, this may vary depending on the surrounding environment.)

This product is also designed for IT power distribution system with phase-to-phase voltage 230V.

EB-982W/EB-W49/EB-W52/EB-W51/EB-W06

Product name	EB-982W/EB-W49/EB-W52/EB-W51/EB-W06
--------------	-------------------------------------

Dimensions	EB-982W 309 (W) × 90 (H) × 282 (D) mm (not including raised section) EB-W49 302 (W) × 87 (H) × 249 (D) mm (not including raised section) EB-W52 302 (W) × 87 (H) × 234 (D) mm (not including raised section) EB-W51/EB-W06 302 (W) × 77 (H) × 234 (D) mm (not including raised section)
LCD panel size	0.59"
Display method	Poly-silicon TFT active matrix
Resolution	1,024,000 pixels WXGA (1,280 (W) × 800 (H) dots) × 3
Focus adjustment	Manual
Zoom adjustment	EB-982W 1 to 1.6 (Optical Zoom) EB-W49/EB-W52/EB-W51/EB-W06 1 to 1.2 (Optical Zoom)
Lamp	EB-982W UHE lamp, 230 W Model No.: ELPLP97 EB-W49/EB-W52/EB-W51/EB-W06 UHE lamp, 210 W Model No.: ELPLP97

Lamp life	EB-982W High Power Consumption mode: Up to 6,500 hours Medium Power Consumption mode: Up to 10,000 hours ECO Power Consumption mode: Up to 17,000 hours EB-W49 High Power Consumption mode: Up to 8,000 hours Medium Power Consumption mode: Up to 10,000 hours ECO Power Consumption mode: Up to 17,000 hours EB-W52/EB-W51/EB-W06 High Power Consumption mode: Up to 6,000 hours ECO Power Consumption mode: Up to 12,000 hours
Air filter maintenance cycle	EB-982W 10,000 hours EB-W49/EB-W52/EB-W51/EB-W06 6,000 hours
Max. audio output	EB-982W 16 W EB-W49 5 W EB-W52/EB-W51/EB-W06 2 W
Speaker	1
Power supply	100-240V AC±10% 50/60Hz 3.5 - 1.6 A
Power consumption (100 to 120 V area)	Operating: 345 W
Power consumption (220 to 240 V area)	Operating: 327 W
Standby power consumption	Communication On: 2.0 W Communication Off: 0.3 W
Operating altitude	Altitude 0 to 3,048 m
Operating temperature *	Altitude of 0 to 2,286 m: +5 to +40°C (No condensation) Altitude of 2,287 to 3,048 m: +5 to +35°C (Humidity of 20 to 80%, No condensation)

Storage temperature	-10 to +60°C (Humidity of 10 to 90%, No condensation)
Mass	EB-982W: Approx. 3.1 kg EB-W52: Approx. 2.6 kg EB-W49: Approx. 2.7 kg EB-W51/EB-W06: Approx. 2.5 kg

* Lamp brightness automatically dims if the surrounding temperature gets too high. (Approximately 35°C at an altitude of 0 to 2,286 m, and approximately 30°C at an altitude of 2,287 to 3,048 m; however, this may vary depending on the surrounding environment.)

This product is also designed for IT power distribution system with phase-to-phase voltage 230V.

EB-992F/EB-FH52/EB-FH06

Product name	EB-992F/EB-FH52/EB-FH06
Dimensions	EB-992F/EB-FH52 309 (W) × 90 (H) × 282 (D) mm (not including raised section) EB-FH06 302 (W) × 87 (H) × 249 (D) mm (not including raised section)
LCD panel size	0.61"
Display method	Poly-silicon TFT active matrix
Resolution	2,073,600 pixels Full HD (1,920 (W) × 1,080 (H) dots) × 3
Focus adjustment	Manual

Zoom adjustment	EB-992F/EB-FH52 1 to 1.6 (Optical Zoom) EB-FH06 1 to 1.2 (Optical Zoom)
Lamp	EB-992F/EB-FH52 UHE lamp, 230 W Model No.: ELPLP97 EB-FH06 UHE lamp, 210 W Model No.: ELPLP97
Lamp life	EB-992F High Power Consumption mode: Up to 6,500 hours Medium Power Consumption mode: Up to 10,000 hours ECO Power Consumption mode: Up to 17,000 hours EB-FH52 High Power Consumption mode: Up to 5,500 hours ECO Power Consumption mode: Up to 12,000 hours EB-FH06 High Power Consumption mode: Up to 6,000 hours ECO Power Consumption mode: Up to 12,000 hours
Air filter maintenance cycle	EB-992F/EB-FH52 10,000 hours EB-FH06 6,000 hours
Max. audio output	EB-992F/EB-FH52 16 W EB-FH06 2 W
Speaker	1
Power supply	100-240V AC±10% 50/60Hz 3.5 - 1.6 A
Power consumption (100 to 120 V area)	Operating: 345 W
Power consumption (220 to 240 V area)	Operating: 327 W

Standby power consumption	Communication On: 2.0 W Communication Off: 0.3 W
Operating altitude	Altitude 0 to 3,048 m
Operating temperature *	Altitude of 0 to 2,286 m: +5 to +40°C (No condensation) Altitude of 2,287 to 3,048 m: +5 to +35°C (Humidity of 20 to 80%, No condensation)
Storage temperature	-10 to +60°C (Humidity of 10 to 90%, No condensation)
Mass	EB-992F/EB-FH52: Approx. 3.1 kg EB-FH06: Approx. 2.7 kg

* Lamp brightness automatically dims if the surrounding temperature gets too high. (Approximately 35°C at an altitude of 0 to 2,286 m, and approximately 30°C at an altitude of 2,287 to 3,048 m; however, this may vary depending on the surrounding environment.)

This product is also designed for IT power distribution system with phase-to-phase voltage 230V.

Angle of tilt

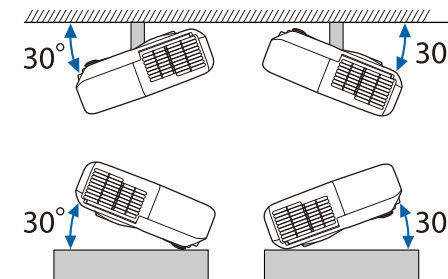

If you use the projector tilted at an angle of more than 30° it could be damaged and cause an accident.

► Related Links

- "Connector Specifications" [p.198](#)

Connector Specifications

See the List of Functions for details on the ports on your projector.

Computer port	Mini D-Sub15-pin (female)
Computer1 port	Mini D-Sub15-pin (female)
Computer2 port	Mini D-Sub15-pin (female)
Monitor Out port	Mini D-Sub15-pin (female)
Video port	RCA pin jack
Audio 1 port	Stereo mini pin jack
Audio 2 port	Stereo mini pin jack
L-Audio-R ports	RCA pin jack × 2 (L-R)
Mic port	Stereo mini pin jack
Audio Out port	Stereo mini pin jack
HDMI port	HDMI (Audio is only supported by PCM)
HDMI1 port	HDMI (Audio is only supported by PCM)
HDMI2 port	HDMI (Audio is only supported by PCM)
USB-A port	USB connector (Type A)
USB-B port	USB connector (Type B)
LAN port	RJ-45
RS-232C port	Mini D-Sub 9-pin (male)



- USB-A and USB-B port supports USB 2.0. However, USB ports are not guaranteed to operate all devices that support USB.
- USB-B port does not support USB 1.1.

» Related Links

- "List of Functions" [p.10](#)

EB-W51/EB-X51/EB-E10/EB-W06/EB-X06/EB-E01/EB-X500/VS260

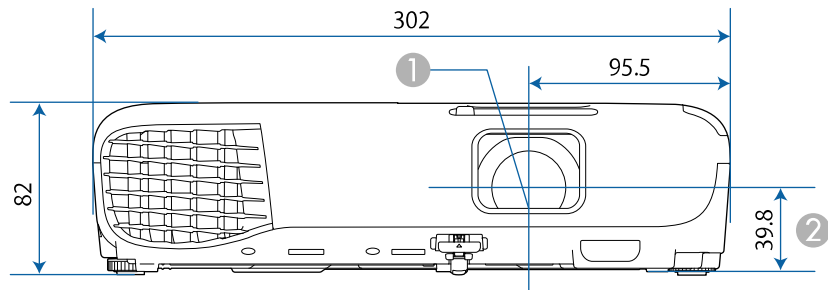

EB-118/EB-W49/EB-X49/EB-E20/EB-W52/EB-FH06

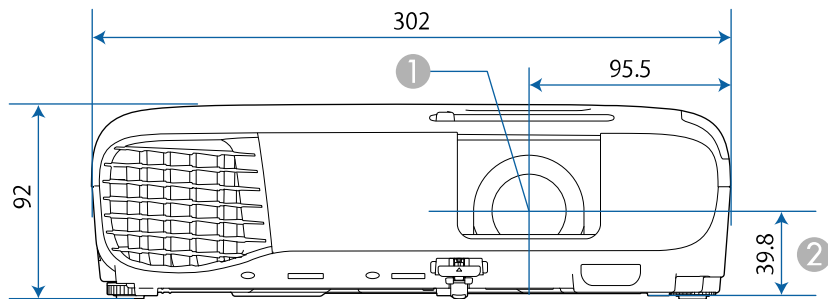

EB-992F/EB-982W/EB-972/EB-FH52

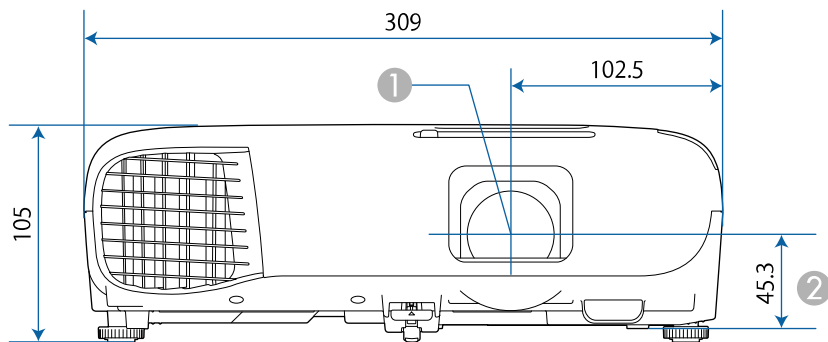

- ① Center of lens
- ② Distance from center of lens to suspension bracket fixing point

EB-W51/EB-X51/EB-E10/EB-W06/EB-X06/EB-E01/EB-X500/VS260

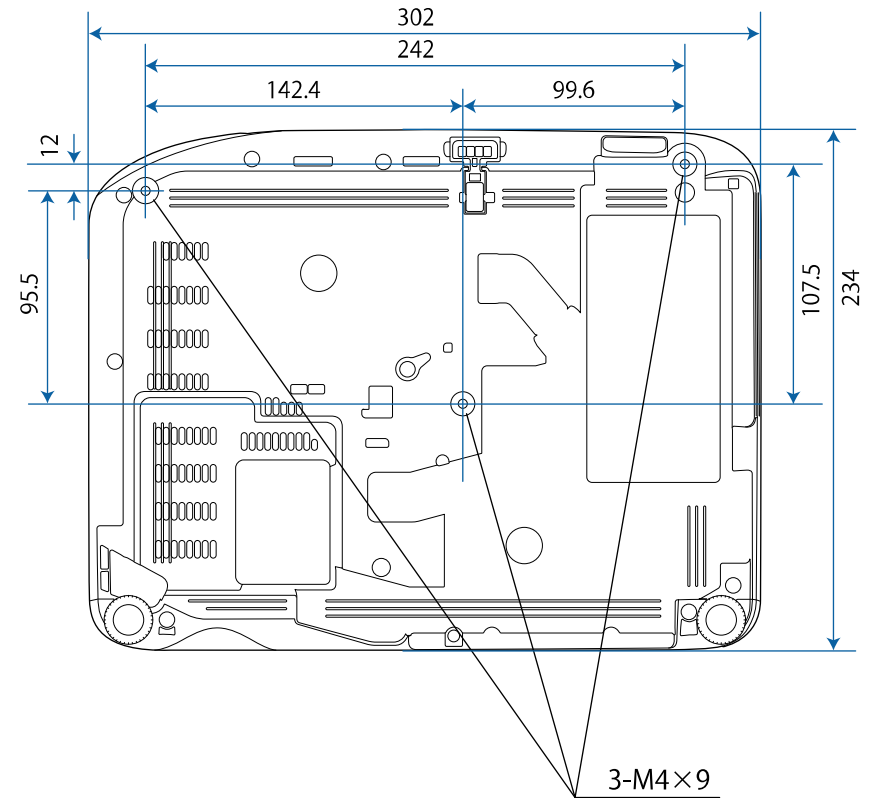

EB-W52

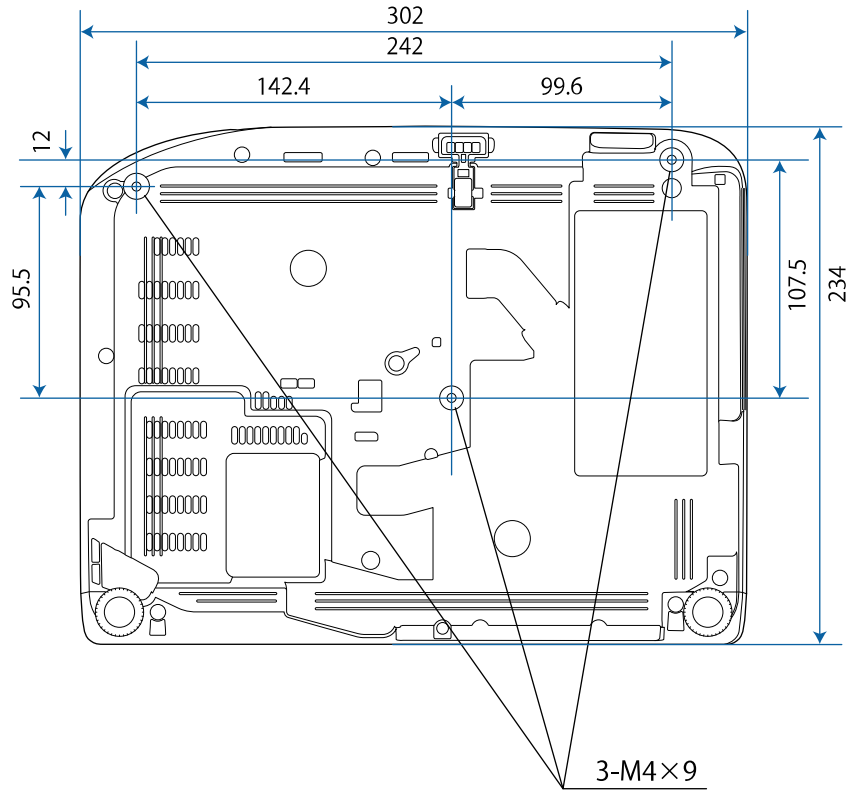

EB-FH06

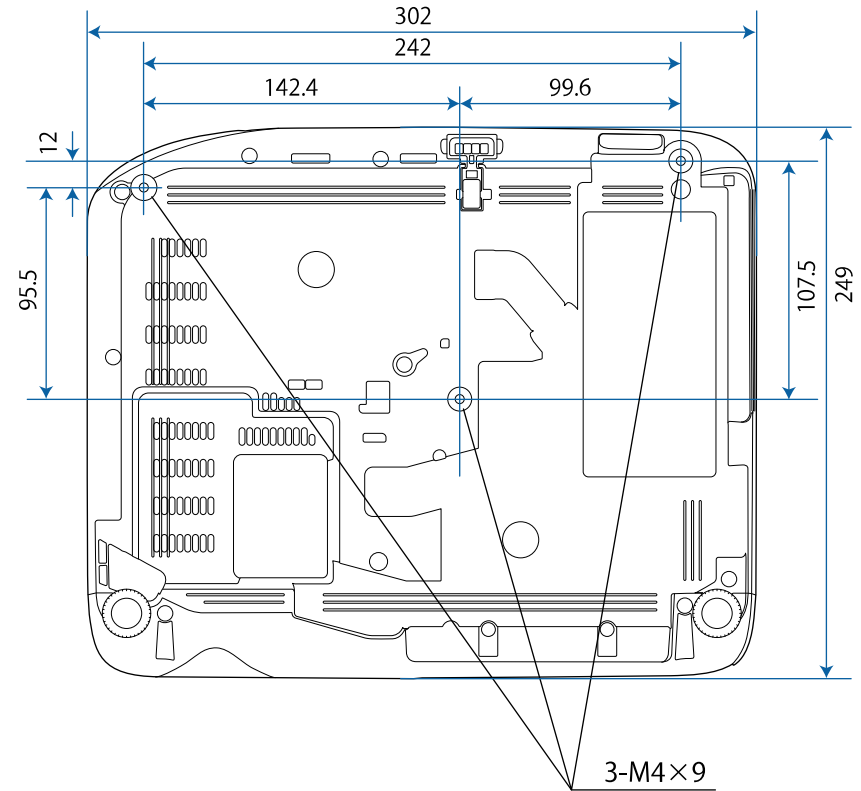

EB-W49/EB-X49/EB-E20

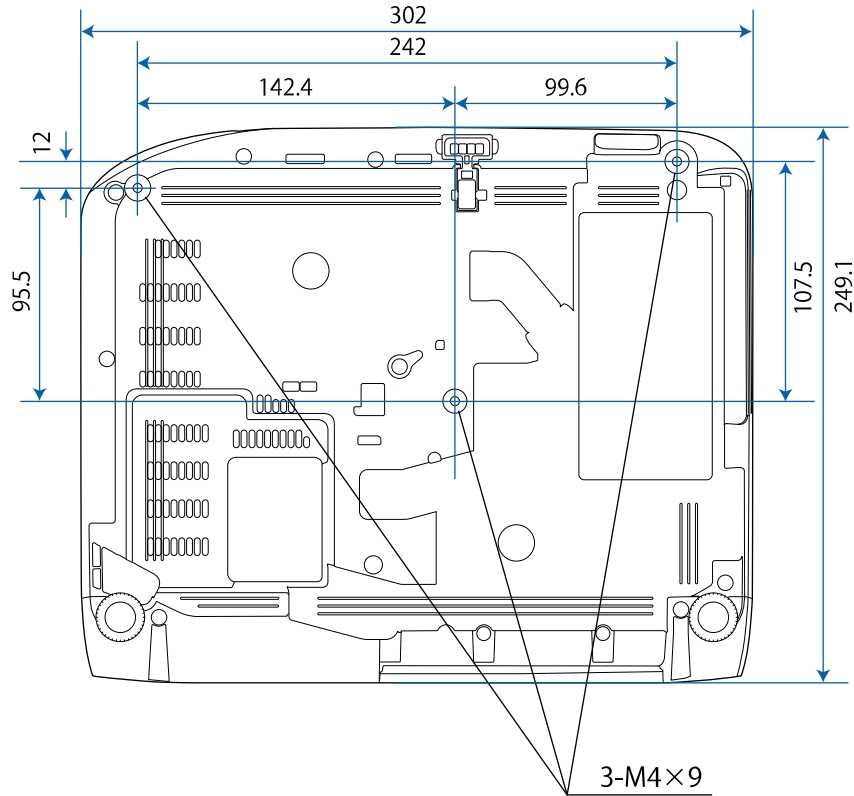

EB-118

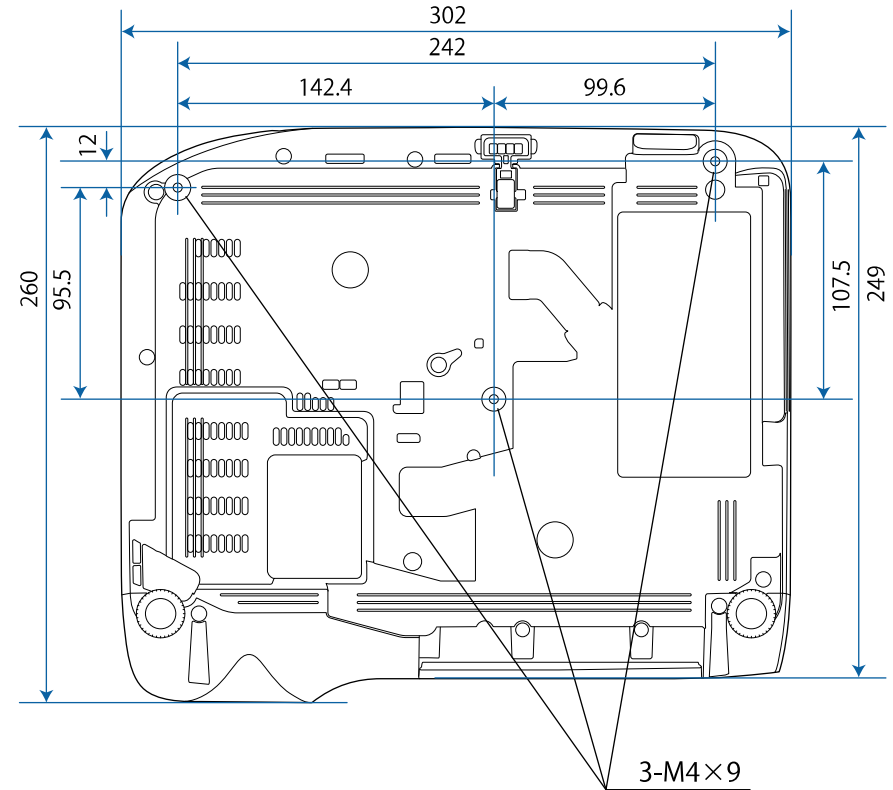

EB-992F/EB-982W/EB-972/EB-FH52

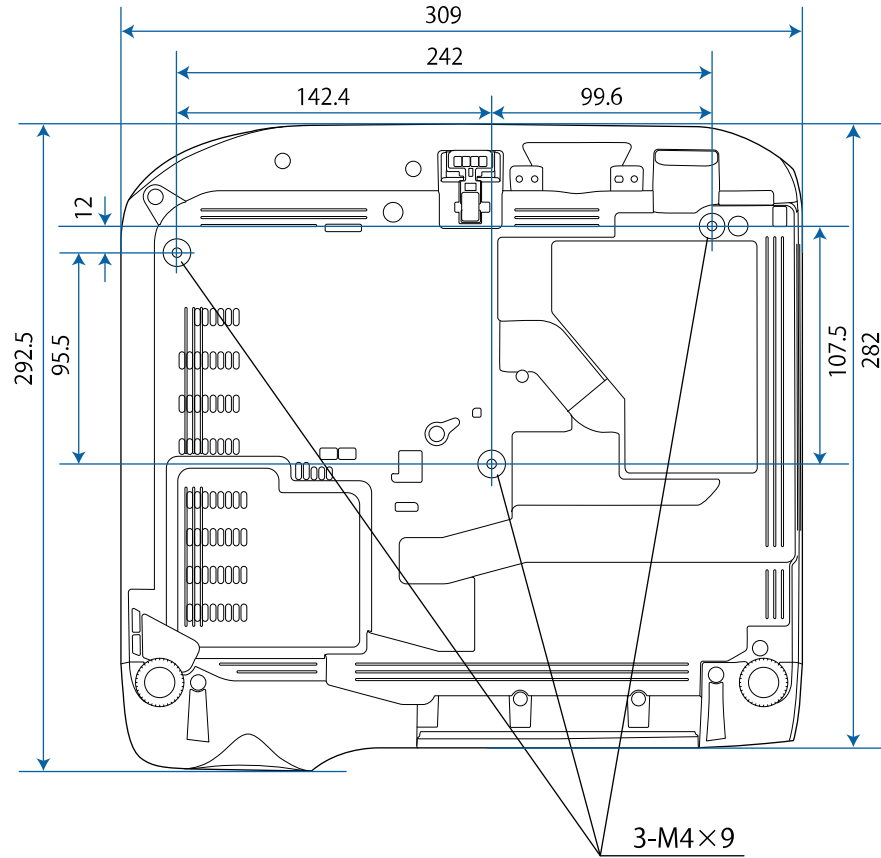

















The unit in these illustrations is mm.

To use the projector's Epson USB Display software, your computer must meet the following system requirements.

Requirement	Windows	Mac
Operating system	Windows 7 <ul style="list-style-type: none"> • Ultimate (32- and 64-bit) • Enterprise (32- and 64-bit) • Professional (32- and 64-bit) • Home Premium (32- and 64-bit) • Home Basic (32-bit) • Starter (32-bit) 	OS X <ul style="list-style-type: none"> • 10.8.x (64-bit) • 10.9.x (64-bit) • 10.10.x (64-bit) • 10.11.x (64-bit)
	Windows 8.1 <ul style="list-style-type: none"> • Windows 8.1 (32- and 64-bit) • Windows 8.1 Pro (32- and 64-bit) • Windows 8.1 Enterprise (32- and 64-bit) 	macOS <ul style="list-style-type: none"> • 10.12.x (64-bit) • 10.13.x (64-bit) • 10.14.x (64-bit)
	Windows 10 <ul style="list-style-type: none"> • Windows 10 Home (32- and 64-bit) • Windows 10 Pro (32- and 64-bit) • Windows 10 Enterprise (32- and 64-bit) 	
CPU	Intel Core2Duo or faster (Intel Core i3 or faster recommended)	Intel Core2Duo or faster (Intel Core i5 or faster recommended)
Memory	2 GB or more (4 GB or more recommended)	
Hard disk space	20 MB or more	
Display	Resolution between 640 × 480 and 1920 × 1200 16-bit color or greater	

The following table lists the meaning of the safety symbols labeled on the equipment.

No.	Symbol mark	Approved standards	Description
1		IEC60417 No. 5007	"ON" (power) To indicate connection to the mains.
2		IEC60417 No. 5008	"OFF" (power) To indicate disconnection from the mains.
3		IEC60417 No. 5009	Stand-by To identify the switch or switch position by means of which part of the equipment is switched on in order to bring it into the stand-by condition.
4		ISO7000 No. 0434B, IEC3864-B3.1	Caution To identify general caution when using the product.
5		IEC60417 No. 5041	Caution, hot surface To indicate that the marked item can be hot and should not be touched without taking care.
6		IEC60417 No. 6042 ISO3864-B3.6	Caution, risk of electric shock To identify equipment that has risk of electric shock.
7		IEC60417 No. 5957	For indoor use only To identify electrical equipment designed primarily for indoor use.
8		IEC60417 No. 5926	Polarity of d.c. power connector To identify the positive and negative connections (the polarity) on a piece of equipment to which a d.c. power supply may be connected.

No.	Symbol mark	Approved standards	Description
9		—	The same as No. 8.
10		IEC60417 No. 5001B	Battery, general On battery powered equipment. To identify a device for instance a cover for the battery compartment, or the connector terminals.
11		IEC60417 No. 5002	Positioning of cell To identify the battery holder itself and to identify the positioning of the cell(s) inside the battery holder.
12		—	The same as No. 11.
13		IEC60417 No. 5019	Protective earth To identify any terminal which is intended for connection to an external conductor for protection against electric shock in case of a fault, or the terminal of a protective earth electrode.
14		IEC60417 No. 5017	Earth To identify an earth (ground) terminal in cases where neither the symbol No. 13 is explicitly required.
15		IEC60417 No. 5032	Alternating current To indicate on the rating plate that the equipment is suitable for alternating current only; to identify relevant terminals.
16		IEC60417 No. 5031	Direct current To indicate on the rating plate that the equipment is suitable for direct current only; to identify relevant terminals.

No.	Symbol mark	Approved standards	Description
17		IEC60417 No. 5172	Class II equipment To identify equipment meeting the safety requirements specified for Class II equipment according to IEC 61140.
18		ISO 3864	General prohibition To identify actions or operations that are prohibited.
19		ISO 3864	Contact prohibition To indicate injury that could occur due to touching a specific part of the equipment.
20		—	Never look into the optical lens while the projector is on.
21		—	To indicate that the marked item don't place anything on projector.
22		ISO3864 IEC60825-1	Caution, laser radiation To indicate the equipment has a laser radiation part.
23		ISO 3864	Disassembly prohibition To indicate a risk of injury, such as electric shock, if the equipment is disassembled.
24		IEC60417 No. 5266	Standby, partial standby To indicate that part of the equipment is in the ready status.
25		ISO3864 IEC60417 No. 5057	Caution, movable parts To indicate that you must keep away from movable parts according to protection standards.
26		IEC60417 No. 6056	Caution (Moving Fan Blades) As a safety precaution, stay away from the moving fan blades.

No.	Symbol mark	Approved standards	Description
		IEC60417 No. 6043	Caution (Sharp Corners) To indicate sharp corners that should not be touched.
		—	To indicate that looking into the lens while projecting is prohibited.
		ISO7010 No. W027 ISO 3864	Warning, Optical radiation (such as UV, visible radiation, IR) Taking care to avoid injury to eyes and skin when in the vicinity of optical radiation.
		IEC60417 No. 5109	Not to be used in residential areas. To identify electrical equipment which is not suitable for a residential area.

This section briefly explains the difficult terms that are not explained in the text of this guide. For details, refer to other commercially available publications.

AMX Device Discovery	AMX Device Discovery is a technology developed by AMX to facilitate AMX control systems for easy operation of the target equipment. Epson have implemented this protocol technology, and have provided a setting to enable the protocol function (ON). See the AMX Web site for more details. URL http://www.amx.com/
Aspect Ratio	The ratio between an image's length and its height. Screens with a horizontal:vertical ratio of 16:9, such as HDTV screens, are known as wide screens. SDTV and general computer displays have an aspect ratio of 4:3.
Composite Video	A method that combines the video signal into a luminance component and a color component for transmission down a single cable.
Contrast	The relative brightness of the light and dark areas of an image can be increased or decreased to make text and graphics stand out more clearly, or to make them appear softer. Adjusting this particular property of an image is called contrast adjustment.
DHCP	An abbreviation of Dynamic Host Configuration Protocol, this protocol automatically assigns an IP address to equipment connected to a network.
Full HD	A screen size standard with a resolution of 1,280 (horizontal) × 1,080 (vertical) dots.
Gateway Address	This is a server (router) for communicating across a network (subnet) divided according to subnet mask.

HDCP	HDCP is an abbreviation for High-bandwidth Digital Content Protection. It is used to prevent illegal copying and protect copyrights by encrypting digital signals sent over DVI and HDMI ports. Because the HDMI port on this projector supports HDCP, it can project digital images protected by HDCP technology. However, the projector may not be able to project images protected with updated or revised versions of HDCP encryption.
HDMI™	An abbreviation for High Definition Multimedia Interface. HDMI™ is a standard aimed at digital consumer electronics and computers. This is the standard by which HD images and multichannel audio signals are digitally transmitted. By not compressing the digital signal, the image can be transferred at the highest quality possible. It also provides an encryption function for the digital signal.
HDTV	An abbreviation for High-Definition Television that refers to high-definition systems which satisfy the following conditions: <ul style="list-style-type: none"> • Vertical resolution of 720p or 1080i or greater (p = Progressive, i = Interlace) • Screen aspect ratio of 16:9
Interlace	Transmits information needed to create one screen by sending every other line, starting from the top of the image and working down to the bottom. Images are more likely to flicker because one frame is displayed every other line.
IP Address	A number to identify a computer connected to a network.
Progressive	Projects information to create one screen at a time, displaying the image for one frame. Even though the number of scan lines is the same, the amount of flicker in images decreases because the volume of information has doubled compared with an interlace system.

Refresh Rate	<p>The light-emitting element of a display maintains the same luminosity and color for an extremely short time.</p> <p>Because of this, the image must be scanned many times per second to refresh the light-emitting element.</p> <p>The number of refresh operations per second is called the Refresh rate and is expressed in hertz (Hz).</p>
SDTV	An abbreviation for Standard Definition Television that refers to standard television systems which do not satisfy the conditions for HDTV High-Definition Television.
SNMP	An abbreviation for Simple Network Management Protocol, which is the protocol for monitoring and controlling devices such as routers and computers connected to a TCP/IP network.
sRGB	An international standard for color intervals that was formulated so that colors that are reproduced by video equipment can be handled easily by computer operating systems (OS) and the Internet. If the connected source has an sRGB mode, set both the projector and the connected signal source to sRGB.
SSID	SSID is identification data for connecting to another device on a wireless LAN. Wireless communication is possible between devices with the same SSID.
Subnet Mask	This is a numerical value that defines the number of bits used for the network address on a divided network (subnet) from the IP address.
SVGA	A screen size standard with a resolution of 800 (horizontal) × 600 (vertical) dots.
SXGA	A screen size standard with a resolution of 1,280 (horizontal) × 1,024 (vertical) dots.
Sync.	<p>The signals output from computers have a specific frequency.</p> <p>If the projector frequency does not match this frequency, the resulting images are not of a good quality.</p> <p>The process of matching the phases of these signals (the relative position of the crests and the troughs in the signal) is called Synchronization.</p> <p>If the signals are not synchronized, flickering, blurriness, and horizontal interference occur.</p>

Tracking	<p>The signals output from computers have a specific frequency.</p> <p>If the projector frequency does not match this frequency, the resulting images are not of a good quality.</p> <p>The process of matching the frequency of these signals (the number of crests in the signal) is called Tracking.</p> <p>If Tracking is not carried out correctly, wide vertical stripes appear in the signal.</p>
Trap IP Address	This is the IP address for the destination computer used for error notification in SNMP.
VGA	A screen size standard with a resolution of 640 (horizontal) × 480 (vertical) dots.
XGA	A screen size standard with a resolution of 1,024 (horizontal) × 768 (vertical) dots.
WXGA	A screen size standard with a resolution of 1,280 (horizontal) × 800 (vertical) dots.
WUXGA	A screen size standard with a resolution of 1,920 (horizontal) × 1,200 (vertical) dots.

Check these sections for important notices about your projector.

► **Related Links**

- "FCC Compliance Statement" [p.208](#)
- "Indication of the manufacturer and the importer in accordance with requirements of EU directive" [p.209](#)
- "Restriction of Use" [p.209](#)
- "Operating System References" [p.209](#)
- "Trademarks" [p.209](#)
- "Copyright Notice" [p.210](#)
- "Copyright Attribution" [p.210](#)

FCC Compliance Statement

Supplier's DECLARATION of CONFORMITY

According to 47CFR, Part 2 and 15
 Class B Personal Computers and Peripherals; and/or
 CPU Boards and Power Supplies used with Class B Personal Computers

We: Epson America, Inc.

Located at: 3131 Katella Ave., Los Alamitos, CA 90720

Tel: 562-981-3840

Declare under sole responsibility that the product identified herein, complies with 47CFR Part 2 and 15 of the FCC rules as a Class B digital device. Each product marketed, is identical to the representative unit tested and found to be compliant with the standards. Records maintained continue to reflect the equipment being produced can be expected to be within the variation accepted, due to quantity production and testing on a statistical basis as required by 47CFR 2.906. Operation is subject to the following two conditions: (1) this device may not cause harmful interference, and (2) this device must accept any interface received, including interference that may cause undesired operation.

Trade Name: EPSON

Type of Product: LCD Projector

Model:

H971C/H972C/H973C/H974C/H975C/H976C/H977C/HA02C/H978C/H979C/H980C/H981C/H982C/H983C/HA03C/H985C/H986C/H987C/H988C

Options:

Product name	Model
Remote controller	2198635 xx (x=0-9)

FCC Compliance Statement For United States Users

This device complies with part 15 of the FCC Rules. Operation is subject to the following two conditions: (1) This device may not cause harmful interference, and (2) this device must accept any interference received, including interference that may cause undesired operation.

This equipment has been tested and found to comply with the limits for a Class B digital device, pursuant to Part 15 of the FCC Rules. These limits are designed to provide reasonable protection against harmful interference in a residential installation. This equipment generates, uses, and can radiate radio frequency energy and, if not installed and used in accordance with the instructions, may cause harmful interference to radio communications. However, there is no guarantee that interference will not occur in a particular installation. If this equipment does cause interference to radio and television reception, which can be determined by turning the equipment off and on, the user is encouraged to try to correct the interference by one or more of the following measures.

- Reorient or relocate the receiving antenna.
- Increase the separation between the equipment and receiver.
- Connect the equipment into an outlet on a circuit different from that to which the receiver is connected.
- Consult the dealer or an experienced radio/TV technician for help.

WARNING

The connection of a non-shielded equipment interface cable to this equipment will invalidate the FCC Certification or Declaration of this device and may cause interference levels which exceed the limits established by the FCC for this equipment. It is the responsibility of the user to obtain and use a shielded equipment interface cable with this device. If this equipment has

more than one interface connector, do not leave cables connected to unused interfaces. Changes or modifications not expressly approved by the manufacturer could void the user's authority to operate the equipment.

Statement for Canadian EMC Rules

CAN ICES-3 (B) / NMB-3 (B)

Indication of the manufacturer and the importer in accordance with requirements of EU directive

Manufacturer: SEIKO EPSON CORPORATION
Address: 3-5, Owa 3-chome, Suwa-shi, Nagano-ken 392-8502 Japan
Telephone: 81-266-52-3131
<http://www.epson.com/>

Importer: EPSON EUROPE B.V.
Address: Atlas Arena, Asia Building, Hoogoorddreef 5,1101 BA Amsterdam
Zuidoost
The Netherlands
Telephone: 31-20-314-5000
<http://www.epson.eu/>

Restriction of Use

When this product is used for applications requiring high reliability/safety such as transportation devices related to aviation, rail, marine, automotive etc.; disaster prevention devices; various safety devices etc; or functional/precision devices etc, you should use this product only after giving consideration to including fail-safes and redundancies into your design to maintain safety and total system reliability. Because this product was not intended for use in applications requiring extremely high reliability/safety such as aerospace equipment, main communication equipment, nuclear

power control equipment, or medical equipment related to direct medical care etc, please make your own judgment on this product's suitability after a full evaluation.

Operating System References

- Microsoft® Windows Vista® operating system
- Microsoft® Windows® 7 operating system
- Microsoft® Windows® 8 operating system
- Microsoft® Windows® 8.1 operating system
- Microsoft® Windows® 10 operating system

In this guide, the operating systems above are referred to as "Windows Vista", "Windows 7", "Windows 8", "Windows 8.1", and "Windows 10". Furthermore, the collective term "Windows" is used to refer to them all.

- OS X 10.7.x
- OS X 10.8.x
- OS X 10.9.x
- OS X 10.10.x
- OS X 10.11.x
- macOS 10.12.x
- macOS 10.13.x
- macOS 10.14.x

In this guide, the operating systems above are referred to as "OS X 10.7.x", "OS X 10.8.x", "OS X 10.9.x", "OS X 10.10.x", "OS X 10.11.x", "macOS 10.12.x", "macOS 10.13.x", and "macOS 10.14.x". Furthermore, the collective term "Mac" is used to refer to them all.

Trademarks

EPSON is a registered trademark, EXCEED YOUR VISION, ELPLP and their logos are registered trademarks or trademarks of Seiko Epson Corporation.

Mac, OS X, and macOS are trademarks of Apple Inc.

Microsoft, Windows, Windows Vista, and the Windows logo are trademarks or registered trademarks of Microsoft Corporation in the United States and/or other countries.

Wi-Fi™, WPA2™, WPA3™, and Miracast™ are trademarks of Wi-Fi Alliance®.

App Store is a service mark of Apple Inc.

Chrome, Chromebook, and Google Play are trademarks of Google LLC.

HDMI, the HDMI Logo and High-Definition Multimedia Interface are trademarks or registered trademarks of HDMI Licensing Administrator, Inc.



"QR Code" is a registered trademark of DENSO WAVE INCORPORATED.

PJLink trademark is a trademark applied for registration or is already registered in Japan, the United States of America and other countries and areas.

Crestron®, Crestron Connected®, Crestron Fusion®, Crestron Control®, and Crestron RoomView® are registered trademarks of Crestron Electronics, Inc.

Intel® is a registered trademark of Intel Corporation in the U.S. and/or other countries.

Other product names used herein are also for identification purposes only and may be trademarks of their respective owners. Epson disclaims any and all rights in those marks.

expenses incurred by the purchaser or third parties as a result of: accident, misuse, or abuse of this product or unauthorized modifications, repairs, or alterations to this product, or (excluding the U.S.) failure to strictly comply with Seiko Epson Corporation's operating and maintenance instructions.

Seiko Epson Corporation shall not be liable against any damages or problems arising from the use of any options or any consumable products other than those designated as Original Epson Products or Epson Approved Products by Seiko Epson Corporation.

The contents of this guide may be changed or updated without further notice.

Illustrations in this guide and the actual projector may differ.

Copyright Attribution

This information is subject to change without notice.

10/20

© 2020 Epson America, Inc.

CPD-60228R1

Copyright Notice

All rights reserved. No part of this publication may be reproduced, stored in a retrieval system, or transmitted in any form or by any means, electronic, mechanical, photocopying, recording, or otherwise, without the prior written permission of Seiko Epson Corporation. No patent liability is assumed with respect to the use of the information contained herein. Neither is any liability assumed for damages resulting from the use of the information contained herein.

Neither Seiko Epson Corporation nor its affiliates shall be liable to the purchaser of this product or third parties for damages, losses, costs, or

Free Manuals Download Website

<http://myh66.com>

<http://usermanuals.us>

<http://www.somanuals.com>

<http://www.4manuals.cc>

<http://www.manual-lib.com>

<http://www.404manual.com>

<http://www.luxmanual.com>

<http://aubethermostatmanual.com>

Golf course search by state

<http://golfingnear.com>

Email search by domain

<http://emailbydomain.com>

Auto manuals search

<http://auto.somanuals.com>

TV manuals search

<http://tv.somanuals.com>