

User's Guide



Multimedia Projector

EB-955WH	EB-W29
EB-950WH	EB-X30
EB-965H	EB-X29
EB-945H	EB-X27
EB-940H	EB-S29
EB-98H	EB-S27
EB-97H	





Notations Used in This Guide

- **Safety indications**

The documentation and the projector use graphical symbols to show how to use the projector safely. Please understand and respect these caution symbols in order to avoid injury to persons or property.

 Warning	This symbol indicates information that, if ignored, could possibly result in personal injury or even death due to incorrect handling.
 Caution	This symbol indicates information that, if ignored, could possibly result in personal injury or physical damage due to incorrect handling.

- **General information indications**

Attention	Indicates procedures which may result in damage or injury if sufficient care is not taken.
	Indicates additional information and points which may be useful to know regarding a topic.
	Indicates a page where detailed information regarding a topic can be found.
	Indicates that an explanation of the underlined word or words in front of this symbol appears in the glossary of terms. See the "Glossary" section of the "Appendix".  "Glossary" p.175
[Name]	Indicates the name of the buttons on the remote control or the control panel. Example: [Esc] button
Menu Name	Indicates Configuration menu items. Example: Select Brightness from Image . Image - Brightness

Notations Used in This Guide 2

Introduction

Projector Features 8

- Quick and Easy Set up, Projection, and Storage 8
 - Connecting with a USB cable and projecting (USB Display) 8
 - Detecting projector movements and automatically correcting image distortion . . . 8
 - Horizontal keystone adjuster 8
- Useful Functions for Projecting Images 8
 - Project two images simultaneously (Split Screen) 8
 - Increasing projection content in wide (WXGA) screen (EB-955WH/EB-950WH/EB-W29 only) 9
 - Connect a USB storage device and project movies or images (PC Free) 9
 - Flip the image horizontally and project (Flip Horizontal) 9
 - Various functions for excellent power saving 9
 - Making the most of the remote control 9
 - Enlarge and project your files with the Document Camera 9
 - Enhanced security functions 10
- Taking Full Advantage of a Network Connection 10
 - Connecting to a network and projecting images from the computer's screen . . . 10
 - Easy connection to a computer with Quick Wireless Connection (Windows only) 10
 - Projecting images from portable devices over a network 10
 - Projecting images from multiple computers simultaneously 11

Part Names and Functions 12

- Front/Top 12
- Rear 14
- Base 16
- Control Panel 17
- Remote Control 18
 - Replacing the remote control batteries 21
 - Remote control operating range 22

Preparing the Projector

Installing the Projector 24

- Installation Methods 24
 - Installation methods 24
- Screen Size and Approximate Projection Distance 25

Connecting Equipment 28

- Connecting a Computer 28
- Connecting Image Sources 29
- Connecting a Smartphone or Tablet Device 31
- Connecting USB Devices 32
- Connecting External Equipment 33
- Connecting a LAN Cable 34
- Installing the Wireless LAN Unit 36
 - Installing the Quick Wireless Connection USB Key 37

Basic Usage

Projecting Images 39

- Turning On the Projector 39
- Turning Off the Projector 40
- Automatically Detect Input Signals and Change the Projected Image (Source Search) 41
- Switching to the Target Image by Remote Control 42
- Projecting with USB Display 43
 - System requirements 43
 - Connecting for the first time 44
 - Uninstalling 46

Adjusting Projected Images 47

- Correcting Keystone Distortion 47
 - Correcting automatically 48
 - Correcting manually 48
- Adjusting the Image Size 51
- Adjusting the Image Position 52
- Adjusting the Horizontal Tilt 52



Correcting the Focus	52
Adjusting the Volume	53
Selecting the Projection Quality (Selecting Color Mode)	53
Setting Auto Iris	54
Changing the Aspect Ratio of the Projected Image	55
Changing methods	55
Changing the aspect mode	55

Useful Functions

Projection Functions	59
Projecting Two Images Simultaneously (Split Screen)	59
Input sources for split screen projection	59
Operating procedures	60
Restrictions during split screen projection	62
Projecting Without a Computer (PC Free)	63
Specifications for files that can be projected using PC Free	63
PC Free examples	63
PC Free operating methods	64
Projecting the selected image	66
Projecting image files in a folder in sequence (Slideshow)	67
Image file display settings and Slideshow operation settings	68
Flipping the Image Horizontally (Flip Horizontal)	68
Projecting Using a QR Code	69
Setting the display method for QR codes	69
Projecting data from a smartphone or tablet device	70
Hiding the Image and Sound Temporarily (A/V Mute)	71
Freezing the Image (Freeze)	72
Pointer Function (Pointer)	72
Enlarging Part of the Image (E-Zoom)	73
Using the Remote Control to Operate the Mouse Pointer (Wireless Mouse)	74
Correcting the Color Difference when Projecting from Multiple Projectors	75
Summary of correction procedure	75
Setting an ID and using the remote control	76
Correcting	78
Saving a User's Logo	78
Saving User Pattern	80

Security Functions	82
Managing Users (Password Protection)	82
Kinds of Password Protection	82
Setting Password Protection	82
Entering the Password	83
Restricting Operation (Control Panel Lock)	84
Anti-Theft Lock	86
Installing the wire lock	86

Monitoring and Controlling	87
About EasyMP Monitor	87
Message Broadcasting	87
Changing Settings Using a Web Browser (Web Control)	87
Projector setup	87
Displaying the Web Control screen	88
Displaying the Web Remote screen	88
Using the Mail Notification Function to Report Problems	89
Reading error notification mail	89
Management Using SNMP	90
ESC/VP21 Commands	90
Command list	90
Cable layouts	91
About PJLink (Except for EB-S29/EB-S27)	92
About Crestron RoomView® (Except for EB-S29/EB-S27)	93
Operating a projector from your computer	93

About Event ID	97
-----------------------	-----------

Configuration Menu

Using the Configuration Menu	99
List of Functions	100
Configuration Menu Table	100
Network menu	101
Image Menu	102
Signal Menu	103

Settings Menu	105
Extended Menu	106
Network Menu	108
Notes on operating the Network menu	109
Soft keyboard operations	109
Basic menu	110
Wireless LAN menu	111
Security menu	113
Wired LAN menu (except for EB-S29/EB-S27)	114
Mail menu	115
Others menu	116
Reset menu	117
ECO Menu	117
Info Menu (Display Only)	118
Reset Menu	119

Performing Batch Setup for Multiple Projectors 120

Setting Up Using a USB Storage Device	120
Saving settings to the USB storage device	120
Reflecting saved settings to other projectors	122
Setup by Connecting the Computer and Projector with a USB Cable	123
Saving settings to a computer	124
Reflecting saved settings to other projectors	125
When Setup Fails	126

Troubleshooting

Using the Help 128

Problem Solving 130

Reading the Indicators	130
When the Indicators Provide No Help	134
Problems Relating to Images	135
No images appear	135
Moving images are not displayed	136
Projection stops automatically	136
The message Not supported is displayed	136

The message No Signal is displayed	137
Images are fuzzy, out of focus, or distorted	137
Interference or distortion appear in images	138
The mouse cursor flickers (only when projecting USB Display)	139
The image is truncated (large) or small, the aspect is not suitable, or the image has been reversed	139
Image colors are not right	140
Images appear dark	140
Problems when Projection Starts	141
The projector does not turn on	141
Other Problems	142
No sound can be heard or the sound is faint	142
There is noise in the audio (when projecting EasyMP Network Projection, EasyMP MultiPC Projection, USB Display, or Quick Wireless Connection)	142
No sound can be heard from the microphone (EB-955WH/EB-950WH/EB-965H/EB-945H/EB-940H/EB-98H/EB-97H only)	143
The remote control does not work	143
I want to change the language for messages and menus	143
Mail is not received even if a problem occurs in the projector	144
Cannot change settings using a Web browser	144

Maintenance

Cleaning 146

Cleaning the Projector's Surface	146
Cleaning the Lens	146
Cleaning the Air Filter	146

Replacing Consumables 148

Replacing the Lamp	148
Lamp replacement period	148
How to replace the lamp	148
Resetting the lamp hours	151
Replacing the Air Filter	151
Air filter replacement period	151
How to replace the air filter	151

Appendix

Optional Accessories and Consumables	154
Optional Accessories	154
Consumables	154
Screen Size and Projection Distance	155
Projection Distance (For EB-X30)	155
Projection Distance (For EB-98H/EB-97H/EB-X29/EB-X27)	156
Projection Distance (For EB-W29)	157
Projection Distance (For EB-S29/EB-S27)	158
Projection Distance (For EB-965H/EB-945H)	159
Projection Distance (For EB-955WH)	160
Projection Distance (For EB-950WH)	162
Projection Distance (For EB-940H)	163
Supported Monitor Displays	165
Supported Resolutions	165
Computer signals (analog RGB)	165
Component video	165
Composite video	166
Input signal from the HDMI port	166
Input signal from the MHL port (EB-955WH/EB-950WH/EB-965H/EB-945H/ EB-940H/EB-98H/EB-97H only)	166
Specifications	167
Projector General Specifications	167
Appearance	172
Glossary	175
General Notes	177
About Notations	177
General Notice:	178
Index	179



Introduction

This chapter explains the projector's features and the part names.

Quick and Easy Set up, Projection, and Storage

- Turn the projector on and off by simply plugging in or unplugging.
- Project onto large screens from a short distance.
- Make easy height adjustments with one lever.
- No cool down delay makes it easy to put away.
- Turn on the projector by simply receiving an image signal.

Connecting with a USB cable and projecting (USB Display)

By simply connecting a USB cable, you can project images from a computer's screen without a computer cable.

☛ "Projecting with USB Display" [p.43](#)

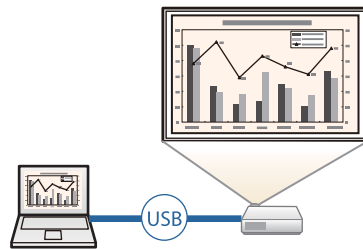

Detecting projector movements and automatically correcting image distortion

This projector automatically corrects vertical keystone distortion which occurs when positioning or moving the projector.

☛ "Correcting automatically" [p.48](#)

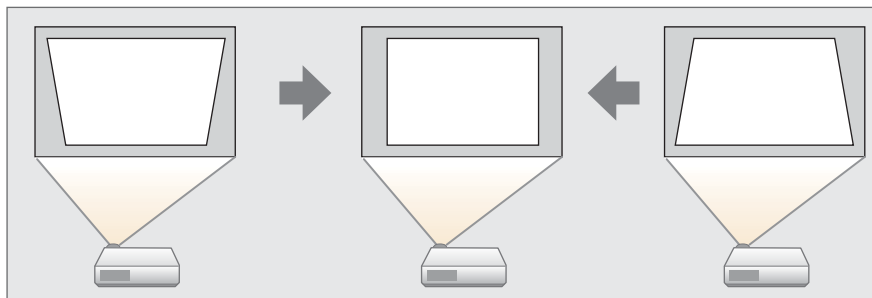

Horizontal keystone adjuster

This allows you to quickly correct horizontal distortion in the projected image. This is useful if you cannot install the projector parallel to the screen.

☛ "Correcting manually" [p.48](#)

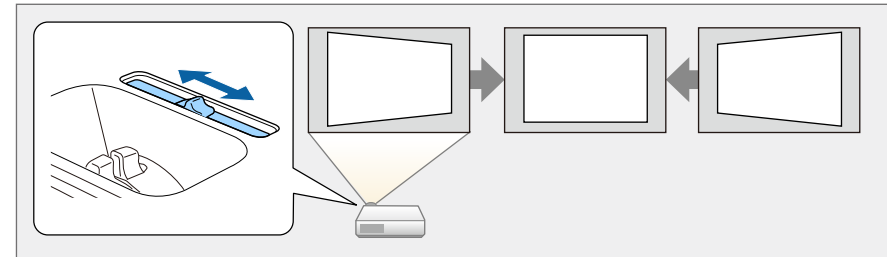

Useful Functions for Projecting Images

Project two images simultaneously (Split Screen)

This function divides the projected screen in two and projects two types of image side-by-side. By simultaneously projecting images from two sources on one screen, you can raise the impact of your message or proposition during video conferences or presentations.

☛ "Projecting Two Images Simultaneously (Split Screen)" [p.59](#)



Increasing projection content in wide (WXGA) screen (EB-955WH/EB-950WH/EB-W29 only)

With a computer that has a 16:10 WXGA wide LCD display, the image can be projected in the same aspect. You can use whiteboards and other landscape format screens.

☛ "Changing the Aspect Ratio of the Projected Image" [p.55](#)

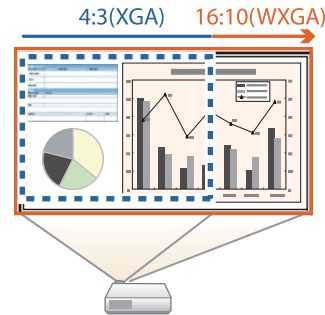

Connect a USB storage device and project movies or images (PC Free)

You can connect USB storage devices or digital cameras to the projector and project saved images.

A wide range of file formats are supported such as movies or images.

☛ "Projecting Without a Computer (PC Free)" [p.63](#)

Flip the image horizontally and project (Flip Horizontal)

You can temporarily flip the image horizontally and project. This is useful when projecting images for dance lessons and so on.

☛ "Flipping the Image Horizontally (Flip Horizontal)" [p.68](#)

Various functions for excellent power saving

- Various functions to prevent wasting electricity

The projector comes with a number of built-in functions to save power such as dimming the projected image, an auto power off timer, and adjusting power consumption while the projector is standing by.

☛ "ECO Menu" [p.117](#)

- Function for displaying the power-saving status on the projected screen
When ECO Display is set to **On** from the Configuration menu, leaf icons () that indicate the power-saving status are displayed at the bottom-left of the projected screen when the lamp brightness has switched to low brightness.

☛ ECO - ECO Display [p.117](#)

Making the most of the remote control

You can use the remote control to perform operations such as enlarging part of the image. You can also use the remote control as a pointer during presentations or as a mouse for the computer.

☛ "Pointer Function (Pointer)" [p.72](#)

☛ "Enlarging Part of the Image (E-Zoom)" [p.73](#)

☛ "Using the Remote Control to Operate the Mouse Pointer (Wireless Mouse)" [p.74](#)

Enlarge and project your files with the Document Camera

You can project paper documents and objects using the optional Document Camera.

By connecting to a computer and using the software supplied, you can make full use of the projector's capabilities.

☛ "Optional Accessories" [p.154](#)

Enhanced security functions

- **Password Protect to restrict and manage users**

By setting a Password you can restrict who can use the projector.

☛ "Managing Users (Password Protection)" [p.82](#)

- **Control Panel Lock to restrict button operation on the control panel**

You can use this to prevent people changing projector settings without permission at events, in schools, and so on.

☛ "Restricting Operation (Control Panel Lock)" [p.84](#)

- **Equipped with various anti-theft devices**

The projector is equipped with the following types of anti-theft security devices.

- Security slot
 - Security cable installation point
- ☛ "Anti-Theft Lock" [p.86](#)

Taking Full Advantage of a Network Connection

By connecting a LAN cable (except for EB-S29/EB-S27) or the optional Wireless LAN unit, you can connect to a network and access the following functions.

☛ "Connecting a LAN Cable" [p.34](#)

☛ "Installing the Wireless LAN Unit" [p.36](#)

Connecting to a network and projecting images from the computer's screen

You can project your computer's screen over a network by using EasyMP Network Projection. Sharing the projector over the network allows you to project data from different computers without changing the signal cable. Even if the projector is away from the computer, you can still project data over a network.



You can find EasyMP Network Projection on the EPSON Projector Software CD-ROM.

Easy connection to a computer with Quick Wireless Connection (Windows only)

By simply connecting the optional Quick Wireless Connection USB Key to a computer, you can automatically setup a wireless LAN connection.

☛ "Installing the Quick Wireless Connection USB Key" [p.37](#)

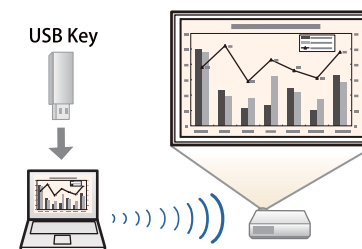

Projecting images from portable devices over a network

If Epson iProjection is installed on your smart phone or tablet device, you can wirelessly project data from the device. Because you can operate these devices from any location, you can vary the way in which conferences or presentations are made.



You can download Epson iProjection for free from the App Store or from Google play. Any fees incurred when communicating with the App Store or Google play are the responsibility of the customer.

Projecting images from multiple computers simultaneously

By using EasyMP Multi PC Projection, up to four screens from multiple computers connected to the network, or from smartphones or tablets with Epson iProjection installed, can be projected simultaneously adding a touch of dynamism to conferences that use projectors. By making yourself the host of a meeting, you can control the projected screens from other connected computers allowing you to advance the meeting smoothly.

You can also project the same screen from remote projectors on the network.

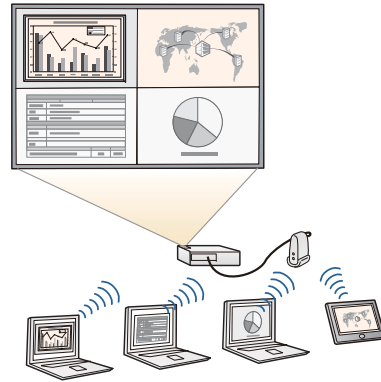







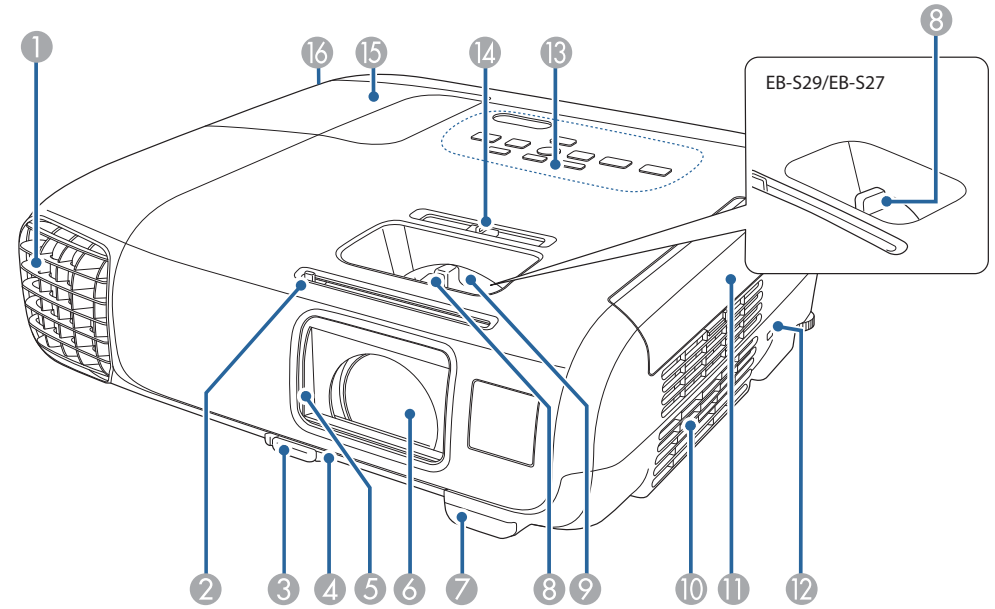





You can find EasyMP Multi PC Projection on the EPSON Projector Software CD-ROM.

All of the features in this guide are explained using illustrations of EB-965H unless otherwise mentioned.

Front/Top



Name	Function
① Air exhaust vent	<p>Exhaust vent for air used to cool the projector internally.</p> <div style="border: 1px solid black; padding: 5px; margin: 5px 0;"> <p> Warning</p> <p>Do not look into the vents. If the lamp explodes, gases may escape and small fragments of glass may be scattered which could cause an injury. Contact a doctor if any fragments of broken glass are inhaled or get into the eyes or mouth.</p> </div> <div style="border: 1px solid black; padding: 5px; margin: 5px 0;"> <p> Caution</p> <p>While projecting, do not put your face or hands near the air exhaust vent, and do not place objects that may become warped or damaged by heat near the vent. Hot air from the air exhaust vent could cause burns, warping, or accidents to occur.</p> </div>
② A/V mute slide knob	Slide the knob to open and close the A/V mute slide.
③ Foot adjust lever	<p>Press the foot adjust lever to extend and retract the front adjustable foot.</p> <p> "Adjusting the Image Position" p.52</p>
④ Front adjustable foot	<p>When setup on a surface such as a desk, extend the foot to adjust the position of the image.</p> <p> "Adjusting the Image Position" p.52</p>
⑤ A/V mute slide	<p>Close when not using the projector to protect the lens. By closing during projection you can hide the image and the sound.</p> <p> "Hiding the Image and Sound Temporarily (A/V Mute)" p.71</p>
⑥ Projection lens	Projects images.
⑦ Remote receiver	Receives signals from the remote control.

Name	Function
⑧ Focus ring	<p>Adjusts the image focus.</p> <p> "Correcting the Focus" p.52</p>
⑨ Zoom ring (Except for EB-S29/EB-S27)	<p>Adjusts the image size.</p> <p> "Adjusting the Image Size" p.51</p>
⑩ Air intake vent (air filter)	<p>Takes in air to cool the projector internally.</p> <p> "Cleaning the Air Filter" p.146</p>
⑪ Air filter cover	<p>Opens and closes the air filter cover.</p> <p> "Replacing the Air Filter" p.151</p>
⑫ Security slot	<p>The security slot is compatible with the Microsaver Security System manufactured by Kensington.</p> <p> "Anti-Theft Lock" p.86</p>
⑬ Control panel	<p>Operates the projector.</p> <p> "Control Panel" p.17</p>
⑭ Horizontal keystone adjuster	<p>Corrects horizontal distortion in the projected image.</p> <p> "Correcting manually" p.48</p>
⑮ Lamp cover	<p>Open when replacing the projector's lamp.</p> <p> "Replacing the Lamp" p.148</p>
⑯ Lamp Cover Fixing Screw	Screw to fix the lamp cover in place.

Rear

EB-955WH/EB-950WH/EB-965H/EB-945H/EB-940H/EB-98H/EB-97H

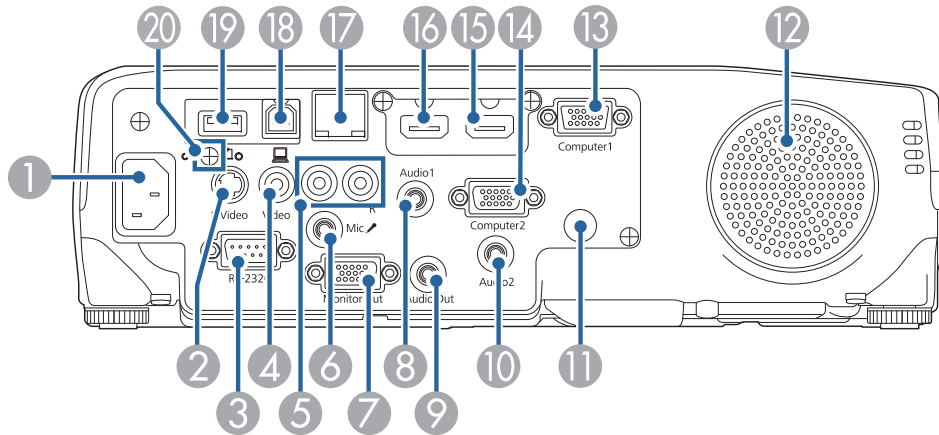

EB-W29/EB-X30/EB-X29/EB-X27

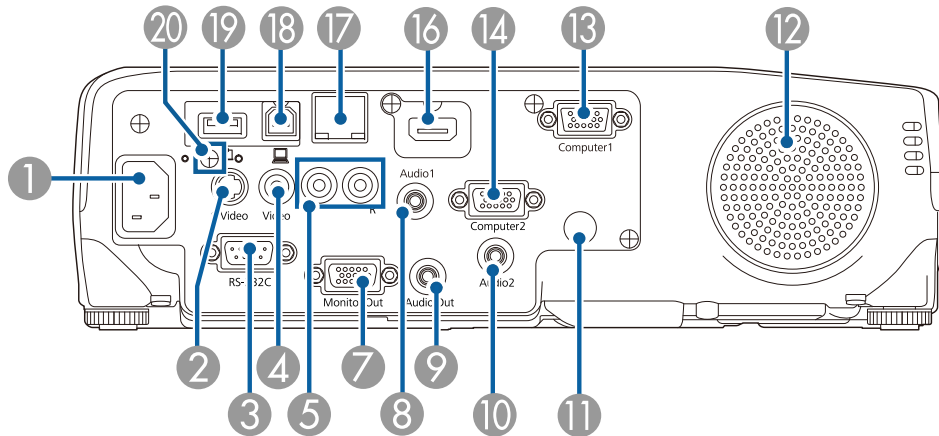

EB-S29/EB-S27

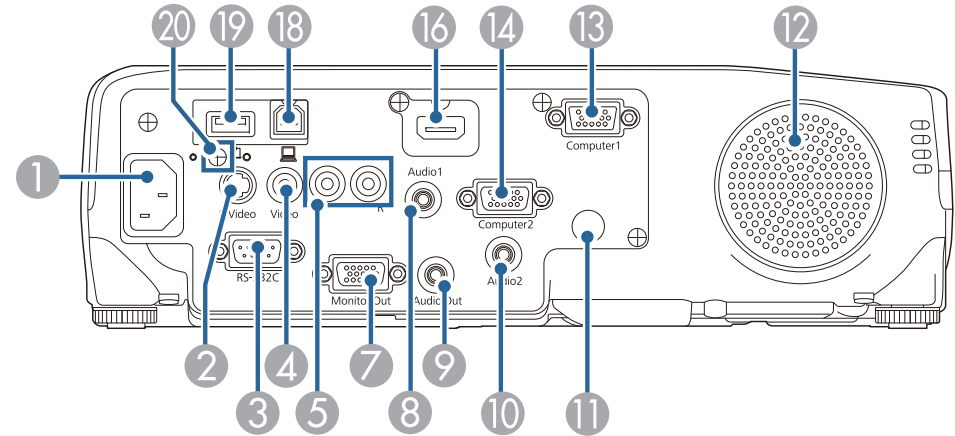

Name	Function
① Power inlet	Connects the power cord to the projector. ☛ "Turning On the Projector" p.39
② S-Video port	For S-video signals from video sources.
③ RS-232C port	When controlling the device from a computer, connect it to the computer with an RS-232C cable. This port is for control use and should not normally be used. ☛ "ESC/VP21 Commands" p.90
④ Video port	Inputs composite video signals from video sources.
⑤ Audio-L/R port	Inputs audio from equipment connected to the S-Video port or the Video port.
⑥ Mic port (EB-955WH/EB-950WH/EB-965H/EB-945H/EB-940H/EB-98H/EB-97H only)	Inputs audio from the microphone.
⑦ Monitor Out port	Outputs analog RGB signals input from the Computer1 port to an external monitor. You cannot output signals input from other ports or component video signals.

Name	Function
⑧ Audio1 port	Inputs audio from equipment connected to the Computer1 port.
⑨ Audio Out port	Outputs audio from the currently projected image to an external speaker.
⑩ Audio2 port	Inputs audio from equipment connected to the Computer2 port.
⑪ Remote receiver	Receives signals from the remote control.
⑫ Speaker	Outputs audio.
⑬ Computer1 port	Inputs image signals from a computer and component video signals from other video sources.
⑭ Computer2 port	
⑮ HDMI2/MHL port (EB-955WH/ EB-950WH/EB-965H/ EB-945H/EB-940H/ EB-98H/EB-97H only)	<ul style="list-style-type: none"> Inputs video signals from HDMI compatible video equipment and computers. This projector is compatible with <u>HDCP</u>▶▶. Inputs signals from smartphones and tablet devices that support <u>MHL</u>▶▶ (Mobile High-definition Link). ☛ "Connecting Equipment" p.28
⑯ HDMI1 port (EB-955WH/ EB-950WH/EB-965H/ EB-945H/EB-940H/ EB-98H/EB-97H only) HDMI port (EB-W29/EB-X30/EB- X29/EB-X27/EB-S29/ EB-S27 only)	Inputs video signals from HDMI compatible video equipment and computers. This projector is compatible with <u>HDCP</u> ▶▶.
⑰ LAN port (Except for EB-S29/EB-S27)	Connects a LAN cable to connect to a network.

Name	Function
⑱ USB-B port	<ul style="list-style-type: none"> Connects the projector to a computer using a USB cable, and projects the images on the computer. ☛ "Projecting with USB Display" p.43 Connects the projector to a computer using a USB cable to use the Wireless Mouse function. ☛ "Using the Remote Control to Operate the Mouse Pointer (Wireless Mouse)" p.74
⑲ USB-A port	<ul style="list-style-type: none"> Connects a USB storage device or a digital camera, and projects images using PC Free. ☛ "Projecting Without a Computer (PC Free)" p.63 Connects the optional Document Camera. Connects the optional Wireless LAN unit. ☛ "Installing the Wireless LAN Unit" p.36 Connects the optional Quick Wireless Connection USB Key. ☛ "Installing the Quick Wireless Connection USB Key" p.37
⑳ Wireless LAN unit fixing screw	This screw secures the wireless LAN unit cover.

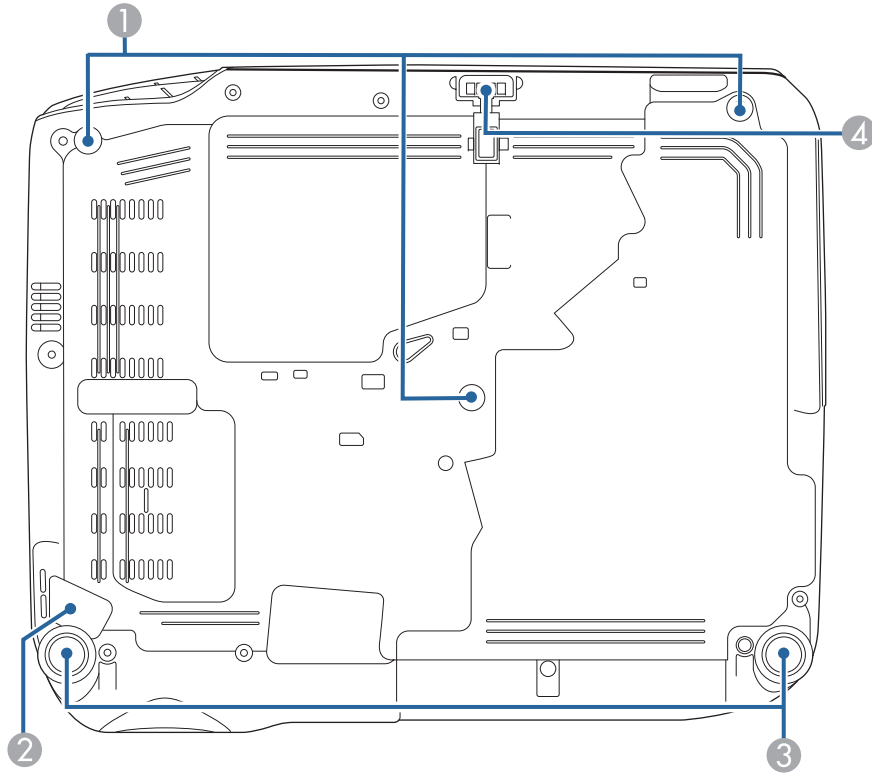

Base

EB-950WH/EB-940H/EB-98H/EB-97H/EB-W29/EB-X30/EB-X29/EB-X27/
EB-S29/EB-S27

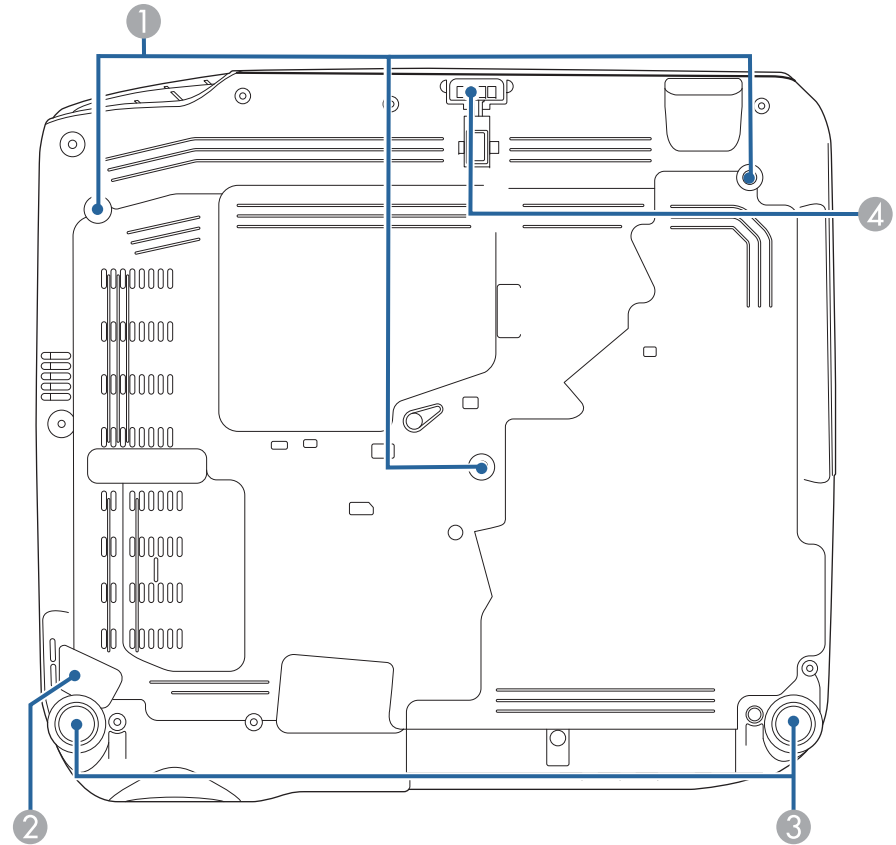

EB-955WH/EB-965H/EB-945H



	Name	Function
①	Ceiling mount fixing points (three points)	Attach the optional Ceiling Mount here when suspending the projector from a ceiling.  "Installing the Projector" p.24  "Optional Accessories" p.154
②	Security cable installation point	Pass a commercially available wire lock through here and lock it in place.  "Installing the wire lock" p.86

Name	Function
③ Rear feet	When setup on a surface such as a desk, turn to extend and retract to adjust the horizontal tilt. ☛ "Adjusting the Horizontal Tilt" p.52
④ Front adjustable foot	When setup on a surface such as a desk, extend the foot to adjust the position of the image. ☛ "Adjusting the Image Position" p.52

Control Panel

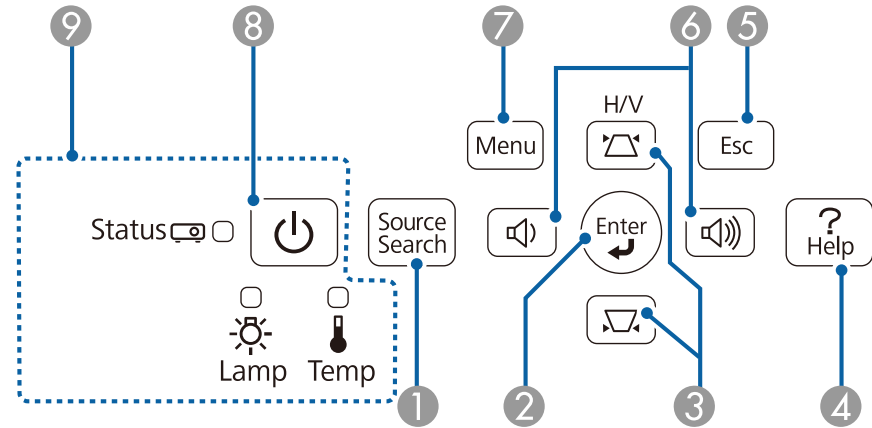



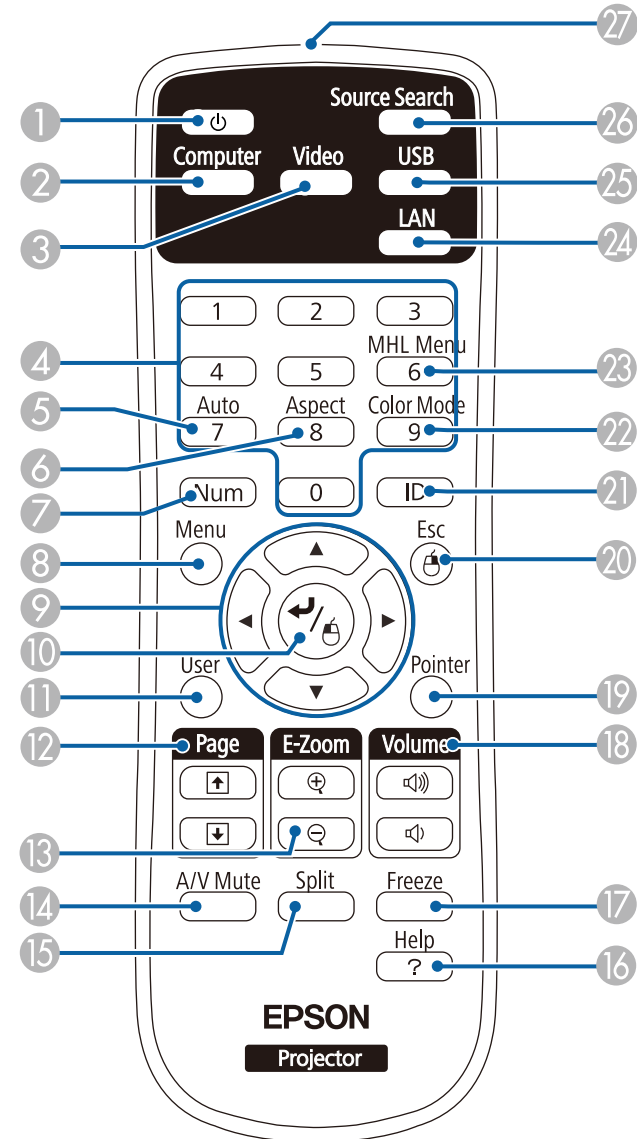

Name	Function
① [Source Search] button	Changes to the next input source that is sending an image. ☛ "Automatically Detect Input Signals and Change the Projected Image (Source Search)" p.41
② [Enter] button [↵]	<ul style="list-style-type: none"> • When the Configuration menu or the Help screen is displayed, it accepts and enters the current selection and moves to the next level. • If pressed while projecting analog RGB signals from the Computer port, you can automatically optimize Tracking, Sync., and Position.
③ [△][▽] buttons	<ul style="list-style-type: none"> • Displays the Keystone screen allowing you to correct keystone distortion in vertical and horizontal directions. ☛ "Correcting manually" p.48 • If pressed when the Configuration menu or the Help screen is displayed, these buttons select menu items and setting values. ☛ "Using the Configuration Menu" p.99 ☛ "Using the Help" p.128

Name	Function
4 [Help] button	Displays and closes the Help screen which shows you how to deal with problems if they occur. ☛ "Using the Help" p.128
5 [Esc] button	<ul style="list-style-type: none"> Stops the current function. If pressed when the Configuration menu is displayed, it moves to the previous menu level. ☛ "Using the Configuration Menu" p.99
6 [◀][▶] buttons or [Wide][Tele] buttons	<ul style="list-style-type: none"> For EB-955WH/EB-950WH/EB-965H/EB-945H/EB-940H/EB-98H/EB-97H/EB-W29/EB-X30/EB-X29/EB-X27 <ul style="list-style-type: none"> [◀] Decreases the volume. [▶] Increases the volume. ☛ "Adjusting the Volume" p.53 For EB-S29/EB-S27 <ul style="list-style-type: none"> [Wide]: Enlarges the size of the projected image. [Tele]: Reduces the size of the projected image. ☛ "Adjusting the Image Size" p.51 Corrects keystone distortion in the horizontal direction when the Keystone screen is displayed. ☛ "H/V-Keystone" p.49 If pressed when the Configuration menu or the Help screen is displayed, these buttons select menu items and setting values. ☛ "Using the Configuration Menu" p.99 ☛ "Using the Help" p.128
7 [Menu] button	Displays and closes the Configuration menu. ☛ "Using the Configuration Menu" p.99
8 [Power] button [⏻]	Turns the projector power on or off. ☛ "Turning On the Projector" p.39
9 Indicators	Indicates the projector's status. ☛ "Reading the Indicators" p.130

Remote Control



Name	Function
① [Power] button [⏻]	Turns the projector power on or off. ☛ "Turning On the Projector" p.39
② [Computer] button	Each time you press the button, the input changes between images from the Computer1 port and the Computer2 port.
③ [Video] button	Each time the button is pressed, the image cycles through the S-Video, Video, and HDMI ports.
④ Numeric buttons	Enter the Password. ☛ "Setting Password Protection" p.82
⑤ [Auto] button	If pressed while projecting analog RGB signals from the Computer port, you can automatically optimize Tracking, Sync., and Position.
⑥ [Aspect] button	Each time the button is pressed, the aspect mode changes. ☛ "Changing the Aspect Ratio of the Projected Image" p.55
⑦ [Num] button	Hold down this button and press the numeric buttons to enter passwords and numbers. ☛ "Setting Password Protection" p.82
⑧ [Menu] button	Displays and closes the Configuration menu. ☛ "Using the Configuration Menu" p.99
⑨  buttons	<ul style="list-style-type: none"> When the Configuration menu or the Help screen is displayed, pressing these buttons selects menu items and setting values. ☛ "Using the Configuration Menu" p.99 When projecting using PC Free, pressing these buttons displays the previous/next image, rotates the image, and so on. ☛ "PC Free operating methods" p.64 During Wireless Mouse function, the mouse pointer moves in the direction of the button that was pushed. ☛ "Using the Remote Control to Operate the Mouse Pointer (Wireless Mouse)" p.74

Name	Function
⑩  button	<ul style="list-style-type: none"> When the Configuration menu or the Help screen is displayed, it accepts and enters the current selection and moves to the next level. ☛ "Using the Configuration Menu" p.99 Acts as a mouse's left button when using the Wireless Mouse function. ☛ "Using the Remote Control to Operate the Mouse Pointer (Wireless Mouse)" p.74
⑪ [User] button	The function set in User Button from the Settings menu is performed. ☛ "Settings Menu" p.105
⑫ [Page] buttons 	<p>Changes pages in files such as PowerPoint files when using the following projection methods.</p> <ul style="list-style-type: none"> When using the Wireless Mouse function ☛ "Using the Remote Control to Operate the Mouse Pointer (Wireless Mouse)" p.74 When using USB Display ☛ "Projecting with USB Display" p.43 During a network connection <p>When projecting images using PC Free, pressing these buttons displays the previous/next screen.</p>
⑬ [E-Zoom] buttons 	Enlarges or reduces the image without changing the projection size. ☛ "Enlarging Part of the Image (E-Zoom)" p.73
⑭ [A/V Mute] button	<ul style="list-style-type: none"> Turns the video and audio on or off. ☛ "Hiding the Image and Sound Temporarily (A/V Mute)" p.71 You can change the Projection mode as follows by pressing the button for about five seconds. Front ↔ Front/Ceiling Rear ↔ Rear/Ceiling

Name	Function
15 [Split] button	Each time the button is pressed, the image changes between projecting two images simultaneously by splitting the projected screen, or projecting one image as normal. ☛ "Projecting Two Images Simultaneously (Split Screen)" p.59
16 [Help] button	Displays and closes the Help screen which shows you how to deal with problems if they occur. ☛ "Using the Help" p.128
17 [Freeze] button	Images are paused or unpaused. ☛ "Freezing the Image (Freeze)" p.72
18 [Volume] buttons [<] [<<]	[<] Decreases the volume. [<<] Increases the volume. ☛ "Adjusting the Volume" p.53
19 [Pointer] button	Displays the on-screen pointer. ☛ "Pointer Function (Pointer)" p.72
20 [Esc] button	<ul style="list-style-type: none"> Stops the current function. If pressed when the Configuration menu is displayed, it moves to the previous level. ☛ "Using the Configuration Menu" p.99 Acts as a mouse's right button when using the Wireless Mouse function. ☛ "Using the Remote Control to Operate the Mouse Pointer (Wireless Mouse)" p.74
21 [ID] button	Hold down this button and press the numeric buttons to select the ID for the projector you want to operate using the remote control. ☛ "Setting an ID and using the remote control" p.76
22 [Color Mode] button	Each time the button is pressed, the Color Mode changes. ☛ "Selecting the Projection Quality (Selecting Color Mode)" p.53

Name	Function
23 [MHL Menu] button	Displays the settings menu for the device linked to the projector's MHL port. (EB-955WH/EB-950WH/EB-965H/EB-945H/EB-940H/EB-98H/EB-97H only)
24 [LAN] button	Switches to the image from the network connected device.
25 [USB] button	Each time the button is pressed, it cycles through the following images: <ul style="list-style-type: none"> USB Display Images from the device connected to the USB-A port
26 [Source Search] button	Changes to the next input source that is sending an image. ☛ "Automatically Detect Input Signals and Change the Projected Image (Source Search)" p.41
27 Remote control light-emitting area	Outputs remote control signals.

Replacing the remote control batteries

If delays in the responsiveness of the remote control occur or if it does not operate after it has been used for some time, it probably means that the batteries are becoming flat. When this happens, replace them with new batteries. Have two AA size manganese or alkaline batteries ready. You cannot use other batteries except for the AA size manganese or alkaline.

Attention

Make sure you read the following manual before handling the batteries.

 [Safety Instructions](#)

1 Remove the battery cover.

While pushing the battery compartment cover catch, lift the cover up.

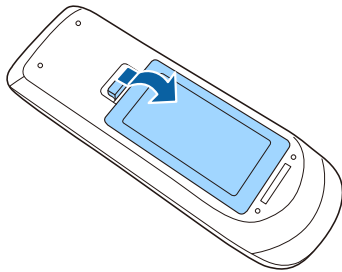

2 Replace the old batteries with new batteries.

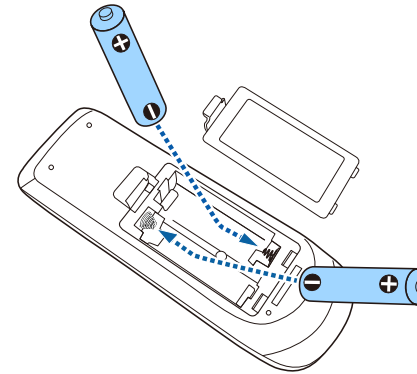

Caution

Check the positions of the (+) and (-) marks inside the battery holder to ensure the batteries are inserted the correct way.

If the batteries are not used correctly, they could explode or leak causing a fire, injury, or damage to the product.

3 Replace the battery cover.

Press the battery compartment cover until it clicks into place.

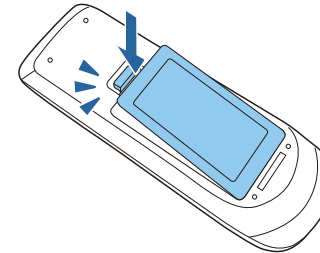

Remote control operating range

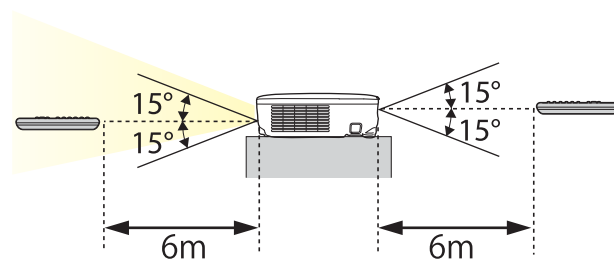
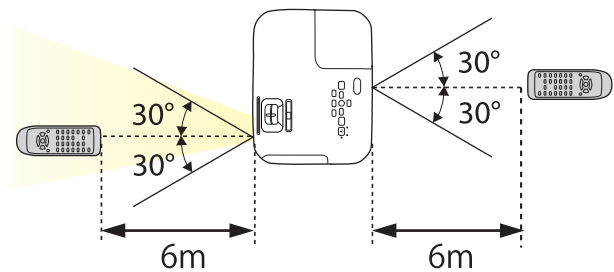



Preparing the Projector

This chapter explains how to install the projector and connect projection sources.

Installation Methods

The projector supports the following four different projection methods. Install the projector according to the conditions of the installation location.

- Project images from in front of the screen. (Front projection)

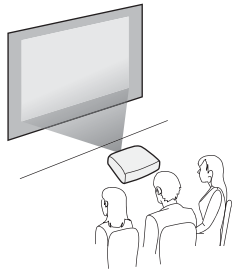

- Project images from behind a translucent screen. (Rear projection)

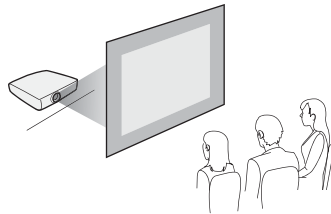

- Suspend the projector from the ceiling and project images from in front of a screen. (Front/Ceiling projection)

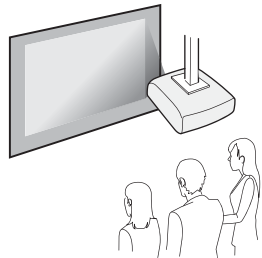

- Suspend the projector from the ceiling and project images from behind a translucent screen. (Rear/Ceiling projection)

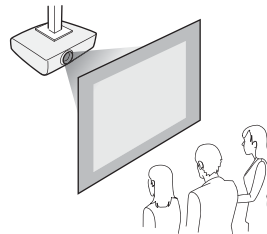

Warning

- A special method of installation is required when suspending the projector from a ceiling (ceiling mount). If it is not installed correctly, it could fall causing an accident and injury.
- If you use adhesives on the Ceiling mount fixing points to prevent the screws from loosening, or if you use things such as lubricants or oils on the projector, the projector case may crack causing it to fall from its ceiling mount. This could cause serious injury to anyone under the ceiling mount and could damage the projector. When installing or adjusting the ceiling mount, do not use adhesives to prevent the screws from loosening and do not use oils or lubricants and so on.
- Do not cover the projector's air intake vent or air exhaust vent. If either of the vents are covered, the internal temperature could rise and cause a fire.

Attention

Do not use the projector on its side. This may cause malfunctions to occur.



- An optional Ceiling mount is required when suspending the projector from a ceiling.
 - ☛ "Optional Accessories" [p.154](#)
- The default Projection setting is **Front**. You can change from **Front** to **Rear** from the Configuration menu.
 - ☛ **Extended - Projection** [p.106](#)
- You can change the Projection mode as follows by pressing down the [A/V Mute] button on the remote control for about five seconds.
 - Front ↔ Front/Ceiling**
 - Rear ↔ Rear/Ceiling**

Installation methods

Install the projector as follows.

- Install the projector so that it is parallel to the screen.
If the projector is installed at an angle to the screen, keystone distortion occurs in the projected image.

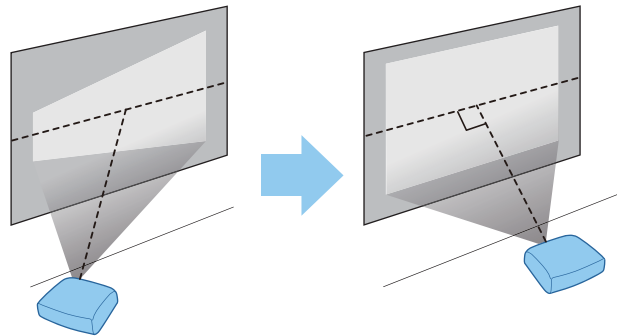

- Place the projector on a level surface.
If the projector is tilted the projected image is also tilted.

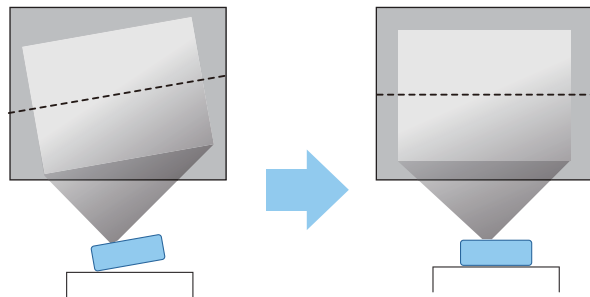

- See the following if you cannot install the projector parallel to the screen.
 - ☛ "Correcting Keystone Distortion" [p.47](#)
- See the following if you cannot install the projector on a level surface.
 - ☛ "Adjusting the Horizontal Tilt" [p.52](#)
 - ☛ "Correcting Keystone Distortion" [p.47](#)

Screen Size and Approximate Projection Distance

Projection size is determined by the distance from the projector to the screen. See the illustrations on the right to select the best position according to the screen size. The illustrations show the approximate shortest distance at maximum zoom. See the following for more information on the projection distance.

☛ "Screen Size and Projection Distance" [p.155](#)



When you correct keystone distortion, the projected image may be reduced.

16:10 Screen Size

For EB-W29

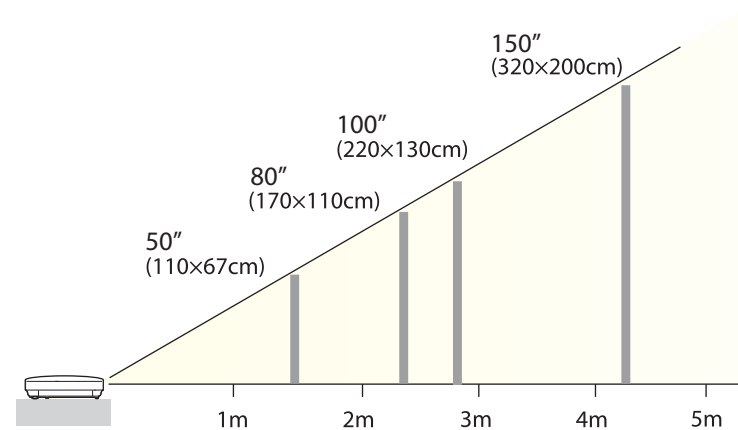

For EB-950WH

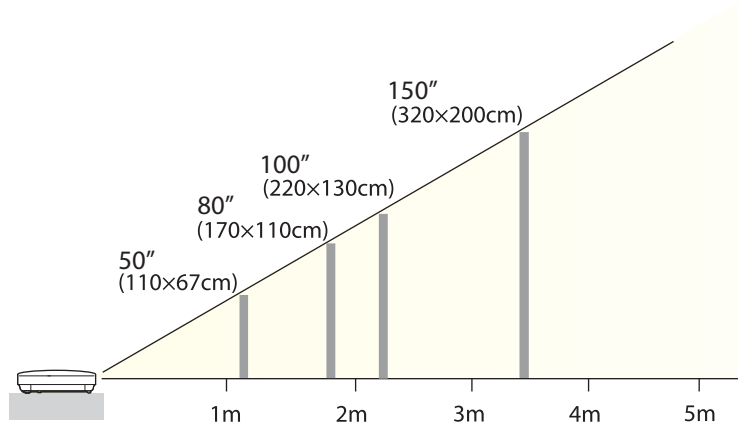

For EB-955WH

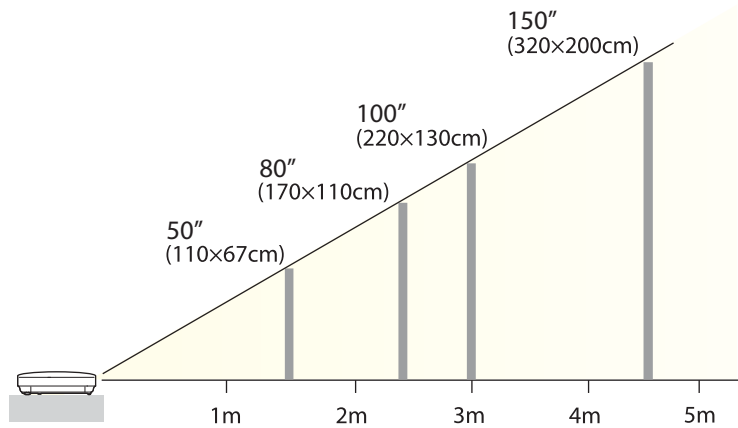

4:3 Screen Size

For EB-98H/EB-97H/EB-X29/EB-X27/EB-S29/EB-S27

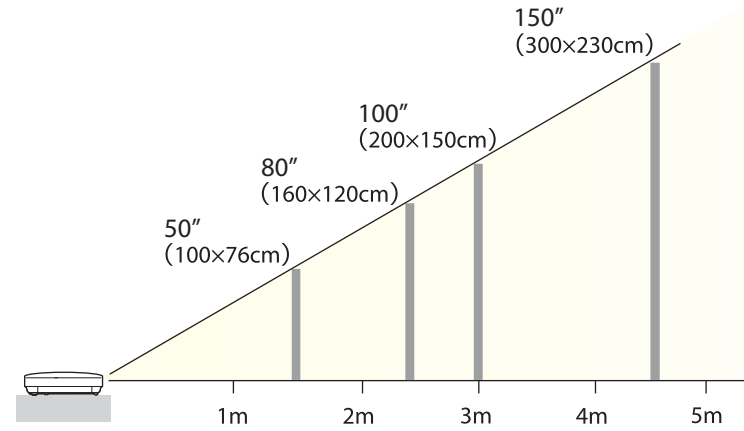

For EB-965H/EB-945H/EB-X30

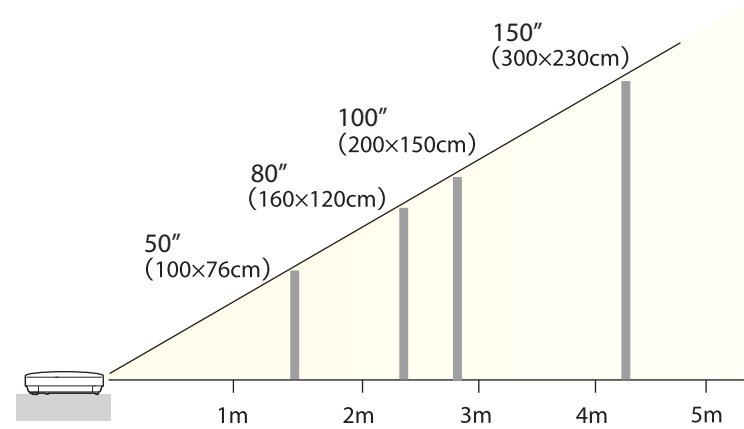

For EB-940H

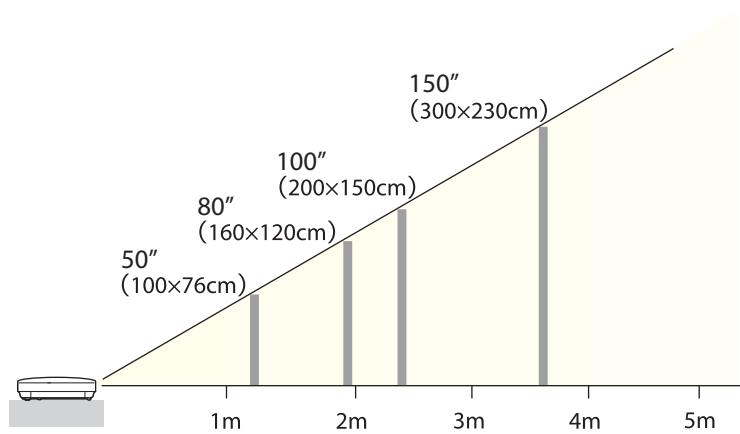

Illustrations in this section are of EB-965H.

The port name, number, location, and connector orientation differ depending on the source being connected.

Connecting a Computer

To project images from a computer, connect the computer using one of the following methods.

1 When using the supplied computer cable

Connect the computer's display output port to the projector's Computer port. You can output audio from the projector's speaker by connecting the audio output port on the computer to the projector's Audio port using a commercially available audio cable.

2 When using the supplied or commercially available USB cable

Connect the computer's USB port to the projector's USB-B port. You can send the computer's audio with the projected image.

3 When using a commercially available HDMI cable

Connect the computer's HDMI port to the projector's HDMI port. You can send the computer's audio with the projected image.

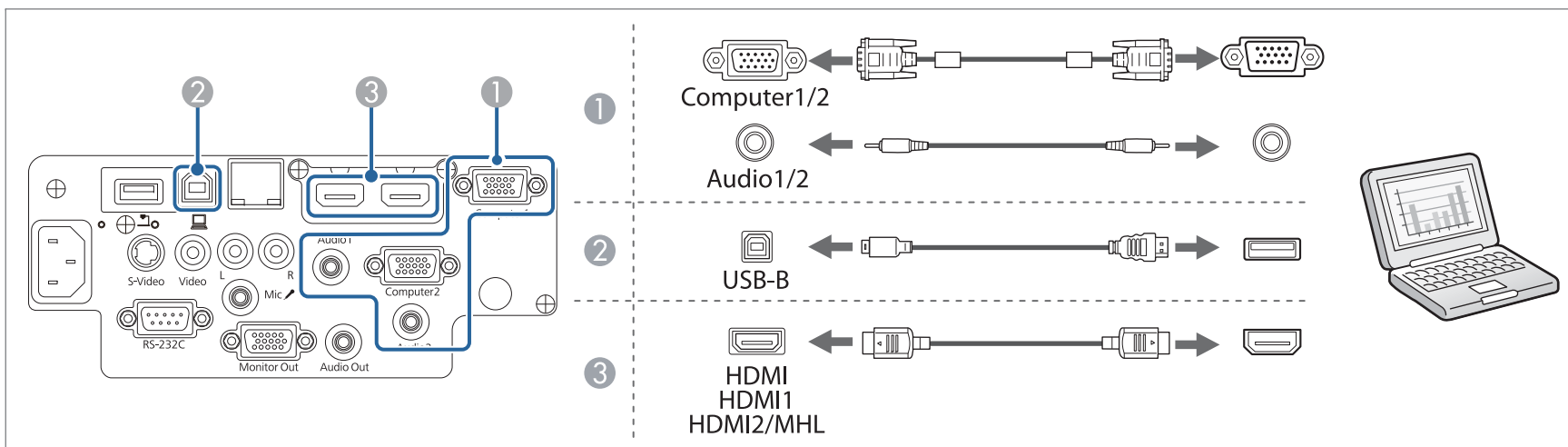



- You can change the audio input source in **Audio Output**.
 - ☛ **Extended - A/V Settings - Audio Output** [p.106](#)
- You can use a USB cable to connect the projector to a computer to project images from the computer. This function is called USB Display.
 - ☛ "Projecting with USB Display" [p.43](#)

Connecting Image Sources

To project images from DVD players or VHS video and so on, connect to the projector using one of the following methods.

① **When using a commercially available video or S-video cable**

Connect the video output port on the image source to the projector's Video port. Or, connect the S-video output port on the image source to the projector's S-Video port. You can output audio from the projector's speaker by connecting the audio output port on the image source to the projector's Audio-L/R port using a commercially available audio cable.

② **When using the optional component video cable**

☛ "Optional Accessories" [p.154](#)

Connect the component output port on the image source to the projector's Computer input port. You can output audio from the projector's speaker by connecting the audio output port on the image source to the projector's Audio port using a commercially available audio cable.

③ **When using a commercially available HDMI cable**

Connect the HDMI port on the image source to the projector's HDMI port. You can send the image source's audio with the projected image.

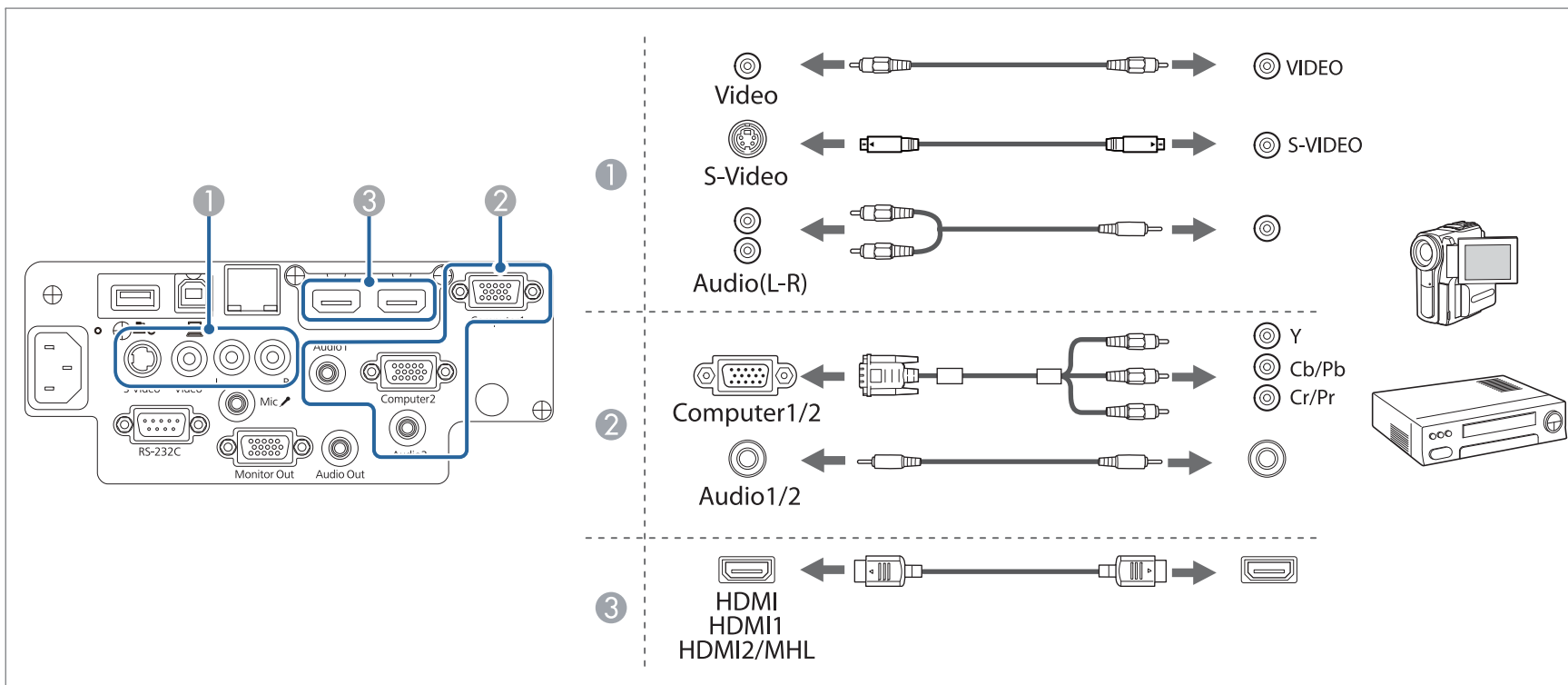

Attention

- Turn off the equipment you want to connect before connecting. If the input source is on when you connect it to the projector, it could cause a malfunction.
- If the orientation or shape of the plug differs, do not try to force it in. The device could be damaged or could malfunction.



- You can change the audio input source in **Audio Output**.

☛ **Extended - A/V Settings - Audio Output p.106**

- If the source you want to connect to has an unusually shaped port, use the cable supplied with the device or an optional cable to connect to the projectors.
- When using a commercially available 2RCA(L/R)/stereo mini-pin audio cable, make sure it is labeled "No resistance".

Connecting a Smartphone or Tablet Device

Only EB-955WH/EB-950WH/EB-965H/EB-945H/EB-940H/EB-98H/EB-97H are supported.

You can connect smartphones and tablet devices. By using a commercially available MHL cable, you can connect the MHL port on your device to the HDMI2/MHL port on the projector. You can send the audio with the projected image.

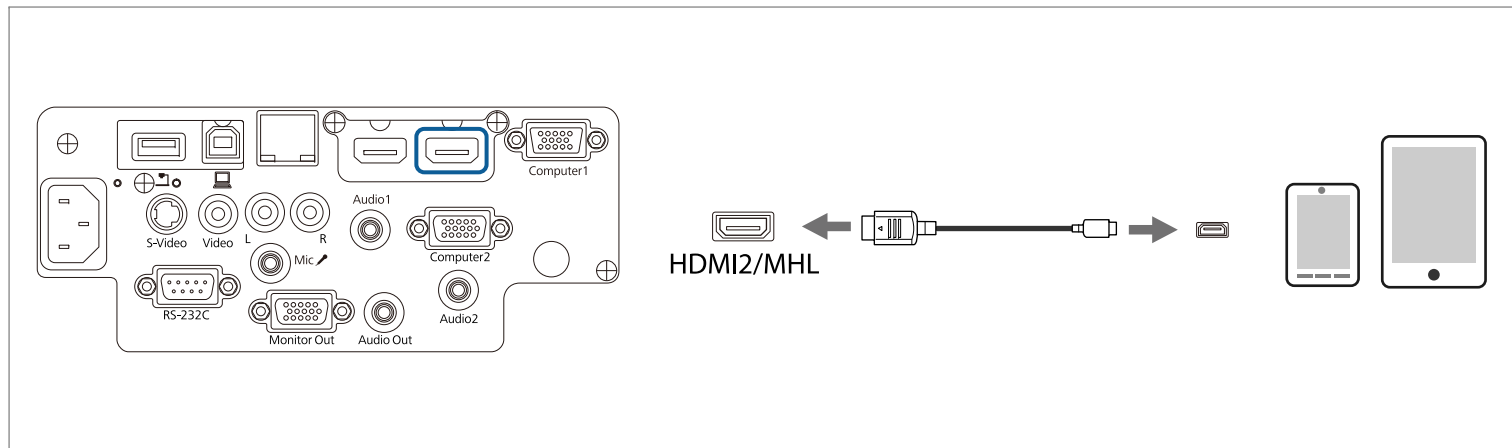

When you connect a smartphone or tablet device to the projector, the device starts charging when images are projected.

Attention

- You may not be able to connect an MHL cable to all devices.
- Make sure the connection cable supports the MHL standards. If you connect a cable that does not support the MHL standards, the smartphone or tablet device may become hot, leak, or explode.
- If you connect using an MHL-HDMI conversion adapter, charging the smartphone or tablet device may not work or you may not be able to perform operations from the projector's remote control.



- If images are not projected correctly, disconnect and then reconnect the MHL cable.
- You may not be able to project correctly depending on the model and settings of the smartphone or tablet device.

Connecting USB Devices

You can connect devices such as USB memory, the optional Document Camera, and USB compatible hard disks and digital cameras.

Using the USB cable supplied with the USB device, connect the USB device to the USB-A port on the projector.

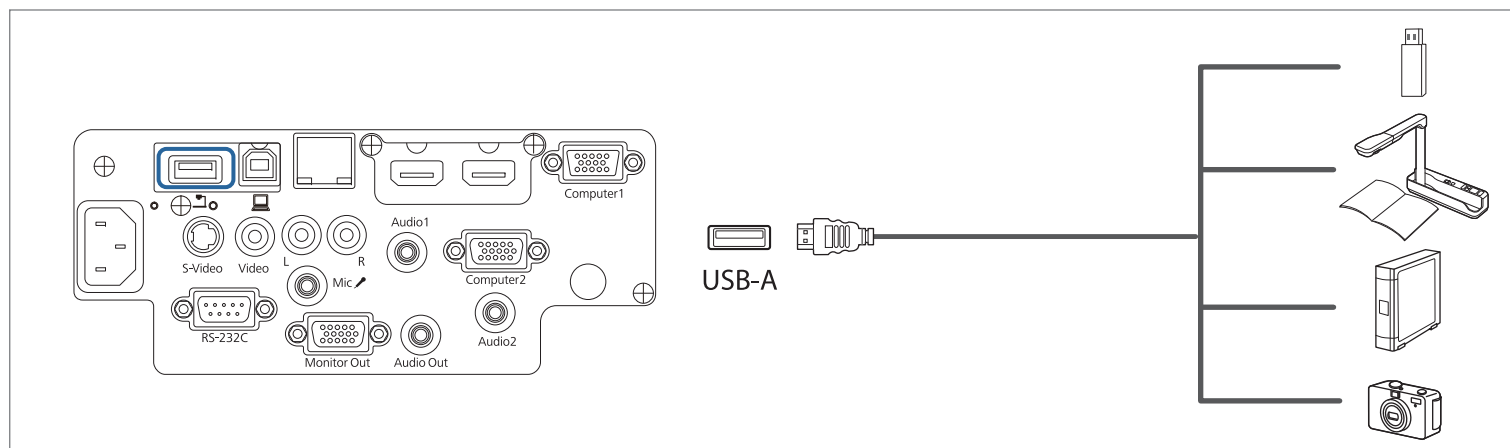

When the USB device is connected, you can project image files on the USB memory or digital camera using PC Free.

☛ "PC Free examples" [p.63](#)

Attention

- If you use a USB hub, the connection may not operate correctly. Devices such as digital cameras and USB devices should be connected to the projector directly.
- When connecting and using a USB-compatible hard disk, make sure you connect the AC adaptor supplied with the hard disk.
- Connect a digital camera or hard disk to the projector using the USB cable provided with the device.
- Use a USB cable less than three meters in length. If the cable exceeds three meters, PC Free may not function correctly.
- When the optional Wireless LAN unit is installed, you cannot connect USB devices.

Removing USB devices

After finishing projecting, remove USB devices from the projector. For devices such as digital cameras or hard disks, turn off the device and then remove it from the projector.

Connecting External Equipment

You can output images and audio by connecting an external monitor or speaker.

You can also output microphone audio from the projector's speaker by connecting a microphone.

① **When outputting images to an external monitor**

Connect the external monitor to the projector's Monitor Out port using the cable supplied with the external monitor.

② **When outputting audio to an external speaker**

Connect the external speaker to the projector's Audio Out port using a commercially available audio cable.

③ **When outputting microphone audio** (EB-955WH/EB-950WH/EB-965H/EB-945H/EB-940H/EB-98H/EB-97H only)

Connect the microphone to the projector's Mic port. When using a condenser microphone, set **Plug-in Power** to **On**.

☛ **Extended - A/V Settings - Plug-in Power** p.106

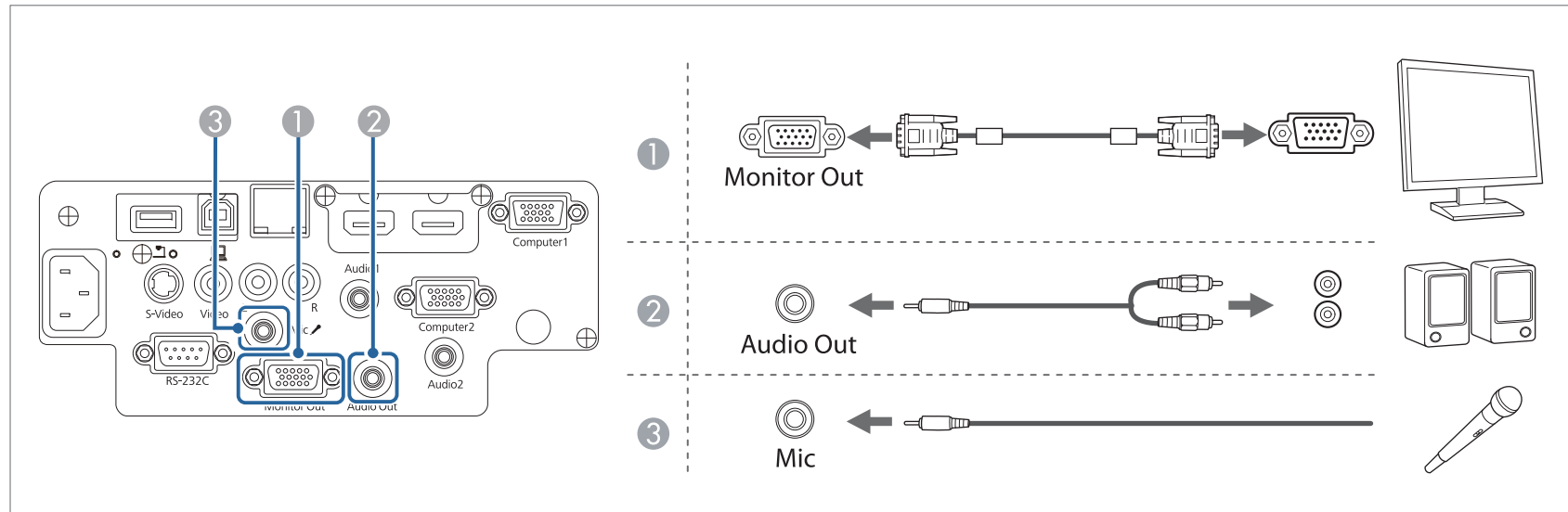



• If you set **Standby Mode** to **Communication On**, you can perform the following operations even if the projector is off.

- Outputting images to an external monitor (only when **A/V Output** is set to **Always On**).
- Outputting microphone audio from the projector's speaker (only when **A/V Output** is set to **Always On**).
- Outputting audio from an externally connected speaker (audio from USB or LAN cannot be output).

☛ **ECO - Standby Mode** p.117

☛ **Extended - A/V Settings** p.106

- Only analog RGB signals from the Computer1 port can be output to an external monitor. You cannot output signals input from other ports or component video signals.
- Setting gauges for functions such as Keystone, Configuration Menu, or Help screens are not output to the external monitor.
- When the audio cable jack is inserted into the Audio Out port, audio stops being output from the projector's built-in speakers and switches to external output.

Connecting a LAN Cable

Only EB-955WH/EB-950WH/EB-965H/EB-945H/EB-940H/EB-98H/EB-97H/EB-W29/EB-X30/EB-X29/EB-X27 are supported.

Connect a LAN port on network hubs or other equipment to the projector's LAN port with a commercially available 100BASE-TX or 10BASE-T LAN cable.

By connecting a computer to the projector over a network, you can project images and check the status of the projector.

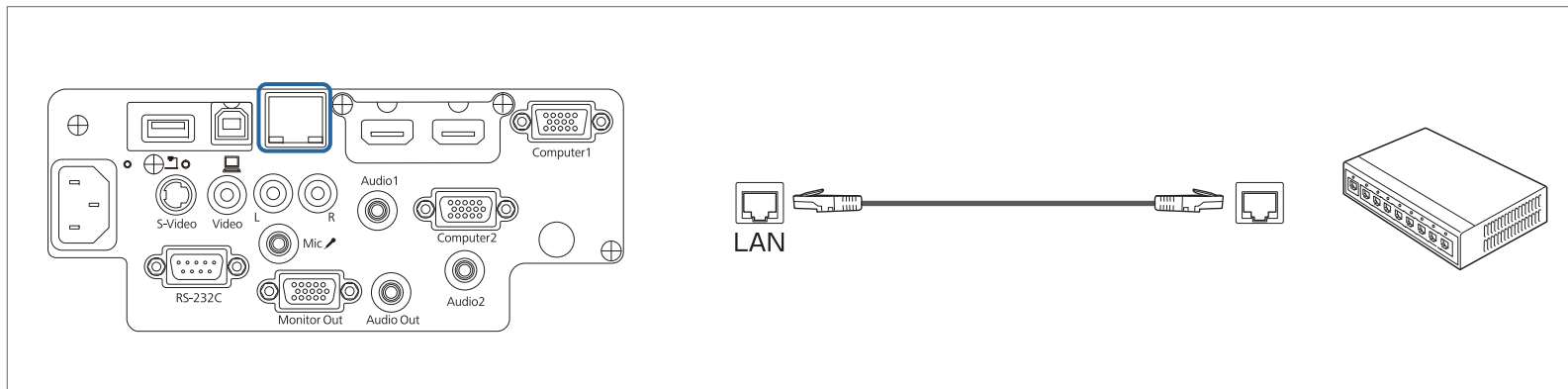



To prevent malfunctions, use a category 5 or higher shielded LAN cable.

Installing the Wireless LAN Unit

By installing the optional Wireless LAN unit, you can project a computer screen over a network.

Connect the Wireless LAN unit to the projector's USB-A port.



- When connecting to the network using wireless LAN, make sure you make network settings from the Configuration menu.
 - ☛ "Wireless LAN menu" [p.111](#)
- If you normally leave the Wireless LAN unit installed, make sure you attach the supplied wireless LAN unit cover as a theft deterrent.
- When moving the projector, make sure you remove the Wireless LAN unit and cover for safety reasons.

- 1** Use a cross-head screwdriver to remove the screw that secures the wireless LAN unit cover.

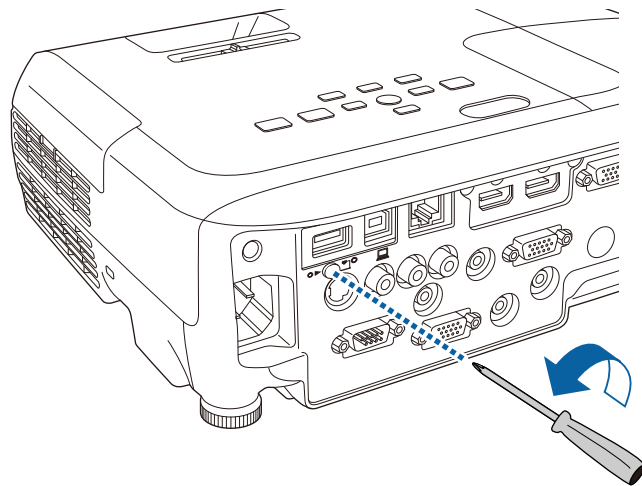

- 2** Connect the Wireless LAN unit to the USB-A port.

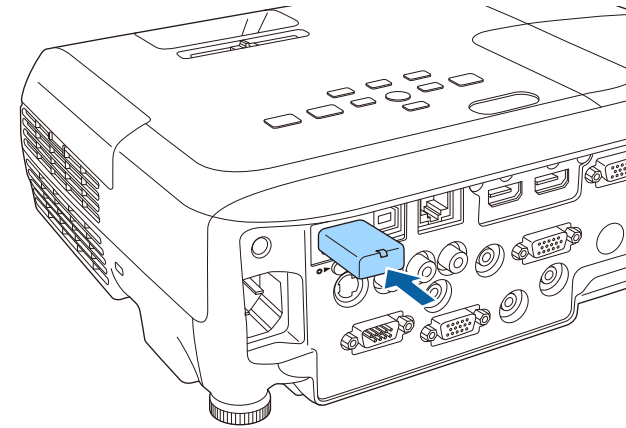

- 3** Attach the wireless LAN unit cover, and secure it in place with the screw.

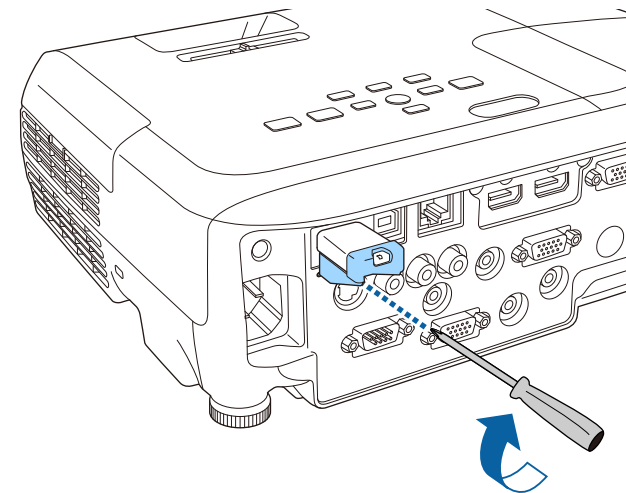

Installing the Quick Wireless Connection USB Key

When installing the optional Quick Wireless Connection USB Key, you need to remove the Wireless LAN unit first, and then connect the Quick Wireless Connection USB Key to the USB-A port.

- 1** Turn on the projector, and then press the [LAN] button on the remote control.

The LAN standby screen is displayed.

- 2** Check that the SSID and IP address information are displayed on the LAN standby screen, and then remove the Wireless LAN unit.

- 3** Connect the Quick Wireless Connection USB Key to the USB-A port.

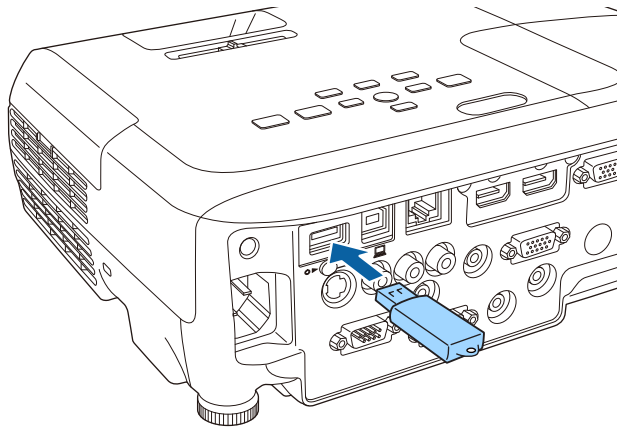

- 4** When the message "Network information update complete. Remove the Quick Wireless Connection USB Key Adapter." is displayed, remove the Quick Wireless Connection USB Key.

- 5** Reinstall the Wireless LAN unit on the projector.

- 6** Connect the Quick Wireless Connection USB Key to the computer you are using.

For the steps from here on, see the User's Guide supplied with the Quick Wireless Connection USB Key.



Basic Usage

This chapter explains how to project and adjust images.

Turning On the Projector

Connect the computer or video equipment you want to use with the projector before you turn on the projector.

☛ "Connecting Equipment" [p.28](#)

- 1** Connect the projector to an electrical outlet with the power cord.

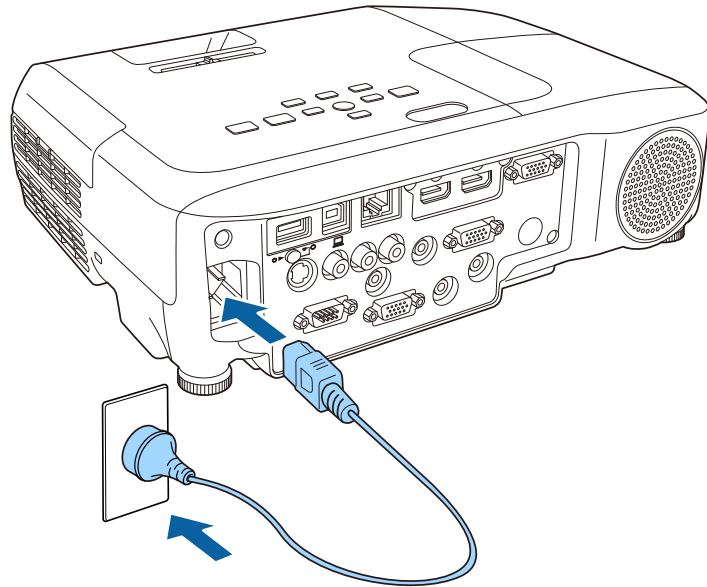

The projector's power indicator turns blue (standby status). In standby status, power is being supplied to the projector, however it is not turned on.

- 2** Press the [⏻] power button on the control panel or the remote control to turn on the projector.

Check that a beep sounds and the status indicator flashes blue (warm-up status). When warm-up is complete, the status indicator stops flashing and remains blue.

- 3** Open the A/V mute slide.

Try one of the following if the image is not projected.

- Check that the A/V mute slide is completely open.
- Turn on the connected computer or video device.
- Change the screen output from the computer when using a laptop computer.
- Insert a DVD or other video media, and press play (if necessary).
- Press the [Source Search] button on the control panel or the remote control to detect the input sources.
 - ☛ "Automatically Detect Input Signals and Change the Projected Image (Source Search)" [p.41](#)
- Press the button for the desired video source on the remote control.
 - ☛ "Switching to the Target Image by Remote Control" [p.42](#)

Warning

- Do not look into the projector's lens during projection. Doing so could damage your eyes. Take particular care when there are children present.
- During projection, do not block the light from the projector with a book and so on. If the light from the projector is blocked, the area on which the light shines becomes hot which could cause melting, burning, or starting a fire. Also, the lens may get hot due to the reflected light which could cause the projector to malfunction. To stop projection, use the A/V Mute function or turn off the projector.
- A mercury lamp with high internal pressure is used as the projector's light source. If the lamp is subjected to vibrations, shocks, or if it is used for an overly extended length of time, the lamp may break or it may not turn on. If the lamp explodes, gases may escape and small fragments of glass may be scattered which could cause an injury. Be sure to observe the instructions below.
 - Do not disassemble or damage the lamp or subject it to any impacts.
 - Do not bring your face close to the projector while it is in use.
 - Particular care should be taken when the projector is installed to a ceiling, as small pieces of glass may fall down when the lamp cover is removed. (When cleaning the projector or replacing the lamp yourself, be very careful not to allow such pieces of glass to get into the eyes or mouth.)

If the lamp breaks, ventilate the area immediately, and contact a doctor if any fragments of broken glass are inhaled or get into the eyes or mouth.



- When **Direct Power On** is set to **On** from the **Extended** menu, the projector turns on automatically when the power cord is connected. When the power cord is plugged in, note that the projector turns on automatically in cases such as a power outage being restored.
 - ☛ **Extended - Operation - Direct Power On** [p.106](#)
- When **Auto Power On** is set to **Computer1** in the **Extended** menu, when an image signal is being input into the projector's Computer1 input port, the power turns on automatically. (Only when **Standby Mode** is set to **Communication On** in the ECO menu.)
 - ☛ **Extended - Operation - Auto Power On** [p.106](#)

Turning Off the Projector



Turn off this product when it is not in use to prolong the life of the projector. The lamp's operating life changes depending on the Configuration menu settings, environmental conditions, and usage. Brightness decreases over time.

- 1** Press the [⏻] button on the control panel or the remote control. The shutdown confirmation screen is displayed.

Power Off?

Yes: Press  button

No : Press any other button

- 2** Press the [⏻] power button again. (To leave it on, press any other button.)

After the beep sounds twice, the projected image disappears and the status indicator turns off.



Since this projector does not require a cool-down time, you can put it away or move it immediately.

- 3** When moving or storing the projector, unplug the power cord.

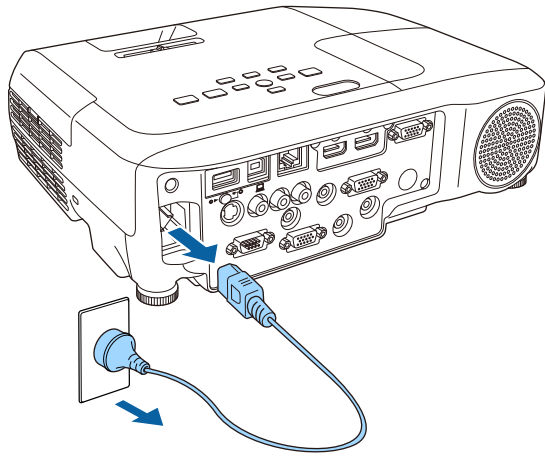

4 Close the A/V mute slide.

Automatically Detect Input Signals and Change the Projected Image (Source Search)

Press the [Source Search] button to project images from the port currently receiving an image.

Using the remote control

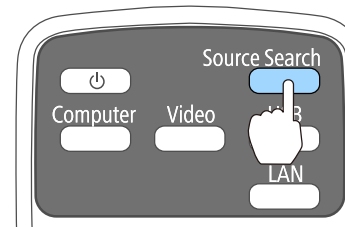

Using the control panel

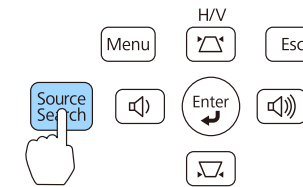

For EB-955WH/EB-950WH/EB-965H/EB-945H/EB-940H/EB-98H/EB-97H

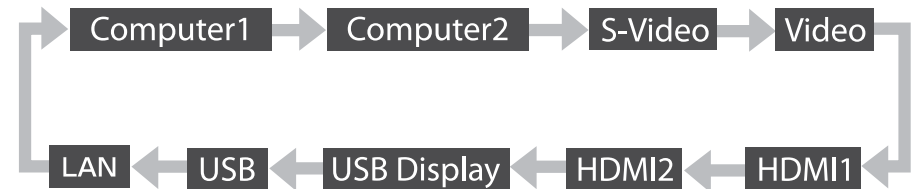

For EB-W29/EB-X30/EB-X29/EB-X27/EB-S29/EB-S27

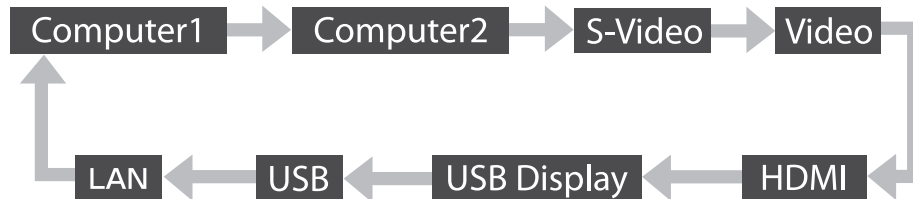

When two or more image sources are connected, press the [Source Search] button until the target image is projected.

When your video equipment is connected, start playback before beginning this operation.



The following screen is displayed while no image signals are input.

Example: EB-955WH/EB-950WH/EB-965H/EB-945H/EB-940H/
EB-98H/EB-97H



Switching to the Target Image by Remote Control

You can change directly to the target image by pressing the following buttons on the remote control.

Remote control

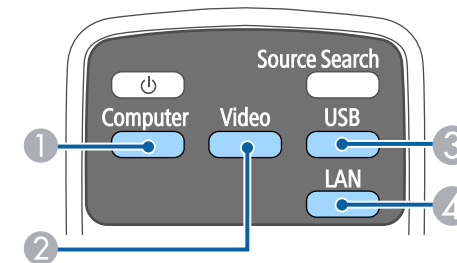

- ① Each time the button is pressed, it cycles through the images being input from the following sources.
 - Computer1
 - Computer2
- ② Each time the button is pressed, it cycles through the images being input from the following sources.
 - S-Video port
 - Video port
 - HDMI port or HDMI1 port
 - HDMI2/MHL port (EB-955WH/EB-950WH/EB-965H/
EB-945H/EB-940H/EB-98H/EB-97H only)
- ③ Each time the button is pressed, it cycles through the images being input from the following sources.
 - USB Display
 - Images from the device connected to the USB-A port
- ④ Switches to the image from the network connected device.

Projecting with USB Display

You can use a USB cable to connect the projector to a computer to project images from the computer.

You can project images and send audio with one USB cable.

System requirements

For Windows

OS	Windows 2000*1	
	Windows XP*2	Professional 32bit Home Edition 32bit Tablet PC Edition 32bit
	Windows Vista	Ultimate 32bit Enterprise 32bit Business 32bit Home Premium 32bit Home Basic 32bit
	Windows 7	Ultimate 32/64bit Enterprise 32/64bit Professional 32/64bit Home Premium 32/64bit Home Basic 32bit Starter 32bit
	Windows 8	Windows 8 32/64 bit Windows 8 Pro 32/64 bit Windows 8 Enterprise 32/64 bit
	Windows 8.1	Windows 8.1 32/64 bit Windows 8.1 Pro 32/64 bit Windows 8.1 Enterprise 32/64 bit

CPU	Mobile Pentium III 1.2 GHz or faster Recommended: Pentium M 1.6 GHz or faster
Amount of Memory	256 MB or more Recommended: 512 MB or more
Hard Disk Space	20 MB or more
Display	Resolution of no less than 640x480 and no higher than 1920x1200. Display color in 16-bit color or greater

*1 Service Pack 4 only

*2 Except for Service Pack 1

For OS X

OS	Mac OS X 10.5.x 32 bit Mac OS X 10.6.x 32/64 bit OS X 10.7.x 32/64 bit OS X 10.8.x OS X 10.9.x
CPU	Power PC G4 1GHz or faster Recommended: Core Duo 1.83GHz or faster
Amount of Memory	512 MB or more
Hard Disk Space	20 MB or more
Display	Resolution of no less than 640x480 and no higher than 1920x1200. Display color in 16-bit color or greater

Connecting for the first time

The first time you connect the projector and the computer using the USB cable, the driver needs to be installed. The procedure is different for Windows and OS X.



- You do not need to install the driver the next time you connect.
- When inputting images from multiple sources, change the input source to USB Display.
- If you use a USB hub, the connection may not operate correctly. Connect the USB cable directly to the projector.
- You cannot change option settings while using USB Display.

For Windows

- 1 Connect the computer's USB port to the projector's USB-B port using a USB cable.



For Windows 2000 or Windows XP, a message asking you if you want to restart your computer may be displayed. Select **No**.

For Windows 2000

Double-click **Computer**, **EPSON PJ_UD**, and then **EMP_UDSE.EXE**.

For Windows XP

Driver installation starts automatically.

For Windows Vista/Windows 7/Windows 8/Windows 8.1

When the dialog box is displayed, click **Run EMP_UDSE.exe**.

- 2 When the License Agreement screen is displayed, click **Agree**.

- 3 Computer images are projected.

It may take a while before computer images are projected. Until computer images are projected, leave the equipment as it is and do not disconnect the USB cable or turn off the power to the projector.

- 4 Disconnect the USB cable when you finish projection.

When disconnecting the USB cable, there is no need to use **Safely Remove Hardware**.



- If it is not installed automatically, double-click **My Computer - EPSON_PJ_UD - EMP_UDSE.EXE** on your computer.
- If nothing is projected for some reason, click **All Programs - EPSON Projector - Epson USB Display - Epson USB Display Vx.xx** on your computer.
- When using a computer running Windows 2000 under user authority, a Windows error message is displayed and you may not be able to use the software. In this case, try updating Windows to the latest version, restart, and then try to connect again.
For more details, contact your local dealer or the nearest address provided in the following document.
[Epson Projector Contact List](#)

For OS X

- 1 Connect the computer's USB port to the projector's USB-B port using a USB cable.

The Setup folder of USB Display is displayed in the Finder.

- 2 Double-click the **USB Display Installer** icon.

- 3 Follow the on-screen instructions to install.

- 4** When the License Agreement screen is displayed, click **Agree**.
Enter the administrator authority password and start the installation.
When the installation is complete, the USB Display icon is displayed in the Dock and menu bar.
- 5** Computer images are projected.
It may take a while before computer images are projected. Until computer images are projected, leave the equipment as it is and do not disconnect the USB cable or turn off the power to the projector.
- 6** When you finish projection, select **Disconnect** from the **USB Display** icon menu on the menu bar or Dock, and then remove the USB cable.



- If the USB Display setup folder is not displayed automatically in the Finder, double-click **EPSON PJ_UD - USB Display Installer** on your computer.
- If nothing is projected for some reason, click the **USB Display** icon in the Dock.
- If there is no **USB Display** icon in the Dock, double-click **USB Display** from the Applications folder.
- If you select **Exit** from the **USB Display** icon menu on the Dock, USB Display does not start automatically when you connect the USB cable.

Uninstalling

For Windows 2000

- 1 Click **Start**, select **Settings**, and then click **Control Panel**.
- 2 Double-click **Add/Remove Programs**.
- 3 Click **Change or Remove Programs**.
- 4 Select **Epson USB Display** and click **Change/Remove**.

For Windows XP

- 1 Click **Start**, and then click **Control Panel**.
- 2 Double-click **Add or Remove Programs**.
- 3 Select **Epson USB Display** and click **Remove**.

For Windows Vista/Windows 7

- 1 Click **Start**, and then click **Control Panel**.
- 2 Click **Uninstall a program** under **Programs**.
- 3 Select **Epson USB Display** and click **Uninstall**.

For Windows 8/Windows 8.1

- 1 Open Charms, and then select **Search**. Right-click (press and hold) **Epson USB Display Ver.x.xx**.
- 2 Select **Uninstall** from the app bar.
- 3 Select **Epson USB Display**, and then select **Uninstall**.

- 4 Follow the on-screen instructions to uninstall.

For OS X

- 1 Open the **Applications** folder, double-click **USB Display**, and then double-click **Tool**.
- 2 Run **USB Display Uninstaller**.

Correcting Keystone Distortion

You can correct keystone distortion using one of the following methods.

- Correcting automatically (Auto V-Keystone)
Automatically corrects vertical keystone distortion.
- Correcting manually (H-Keystone Adjuster)
Manually corrects horizontal keystone distortion using the horizontal keystone adjuster.

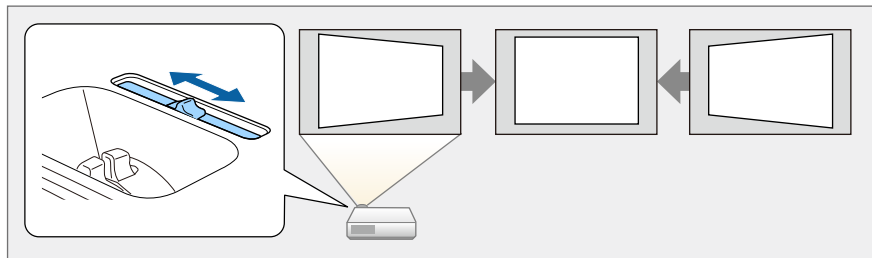

- Correcting manually (H/V-Keystone)
Manually correct distortion in the horizontal and vertical directions independently.

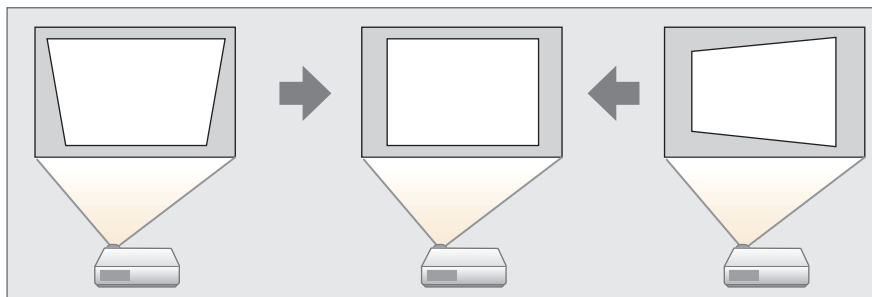

- Correcting manually (Quick Corner)
Manually correct the four corners independently.

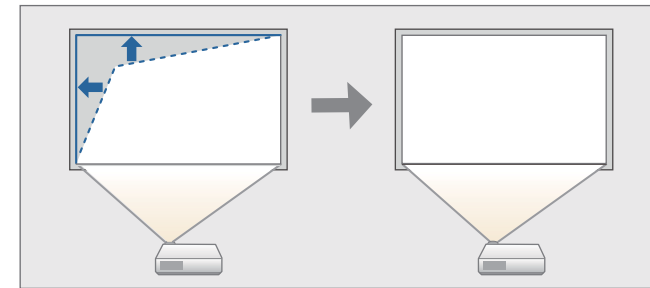

When you correct keystone distortion, the projected image may be reduced, or the projected light may appear around the projected image.

Correcting automatically

Auto V-Keystone

When the projector detects any movement, for example when it is installed, moved, or tilted, it automatically corrects vertical keystone distortion. This function is called Auto V-Keystone.

When the projector remains still for about two seconds after it detects movement, it displays a screen for adjustment and then automatically corrects the projected image.

You can use Auto V-Keystone to correct the projected image under the following conditions.

Correction angle: approx. 30° up and down



- Auto V-Keystone works only when **Projection** is set to **Front** from the Configuration menu.
 - ☛ **Extended - Projection** [p.106](#)
- If you do not want to enable Auto V-Keystone, set **Auto V-Keystone** to **Off**.
 - ☛ **Settings - Keystone - H/V-Keystone - Auto V-Keystone** [p.105](#)

Correcting manually

You can manually correct keystone distortion.

You can use H/V-Keystone to correct the projected image under the following conditions.

Correction angle: approx. 30° right and left/approx. 30° up and down

H-Keystone Adjuster

Move the horizontal keystone adjuster to the right or left to perform horizontal keystone correction.

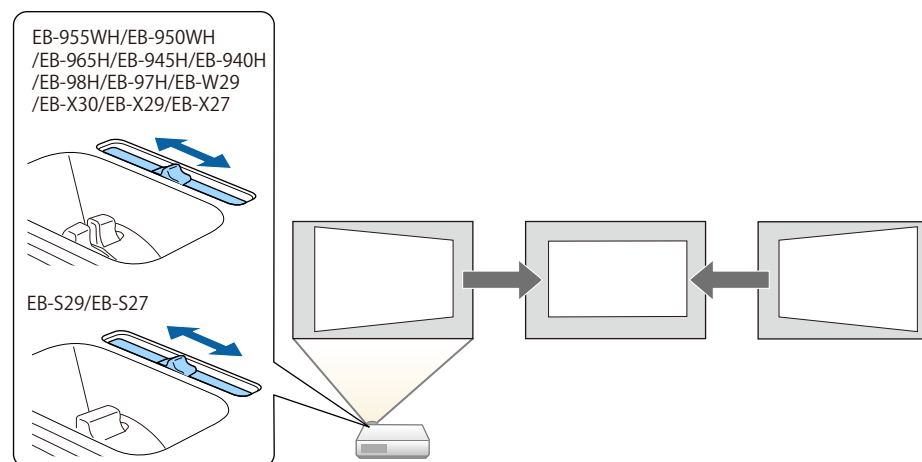

- When using horizontal keystone adjuster, set **H-Keystone Adjuster** to **On**.
 - ☛ **Settings - Keystone - H/V-Keystone - H-Keystone Adjuster** [p.105](#)
- You can also correct keystone distortion in the horizontal direction using H/V-Keystone.

H/V-Keystone

Manually correct distortion in the horizontal and vertical directions independently.

- 1 Press the [↖] or [↘] button on the control panel during projection to display the Keystone screen.

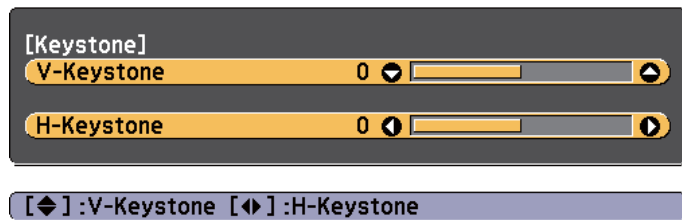

- 2 Press the following buttons to correct keystone distortion. Press the [↖] or [↘] button to correct vertical distortion.

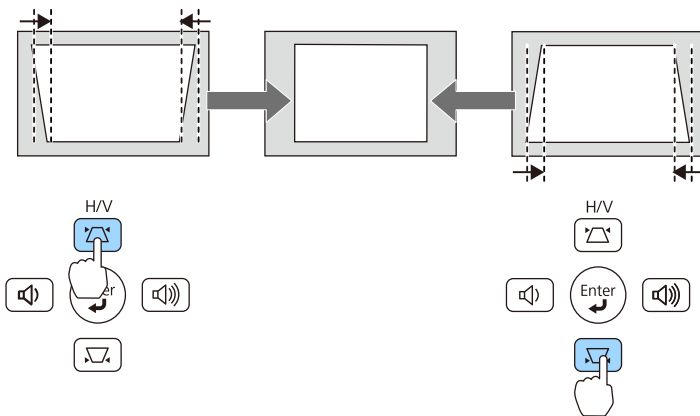

Press the [↔]/[↵] buttons or the [Wide]/[Tele] buttons to correct horizontal distortion.

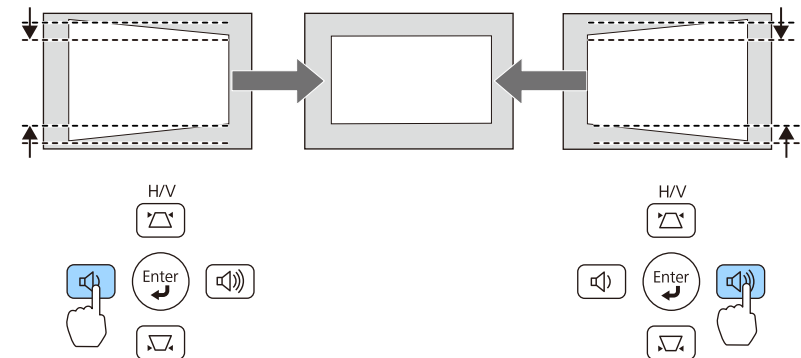

You can also set H/V-Keystone from the Configuration menu.
 Settings - Keystone - H/V-Keystone p.105

Quick Corner

This allows you to manually correct each of the four corners of the projected image separately.

- 1 Press the [Menu] button while projecting.
 "Using the Configuration Menu" p.99

Using the remote control

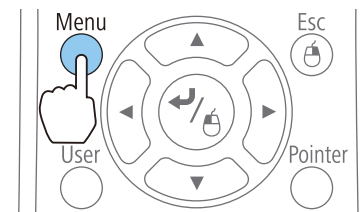

Using the control panel

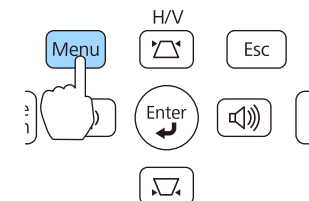

- 2 Select **Keystone** from **Settings**.

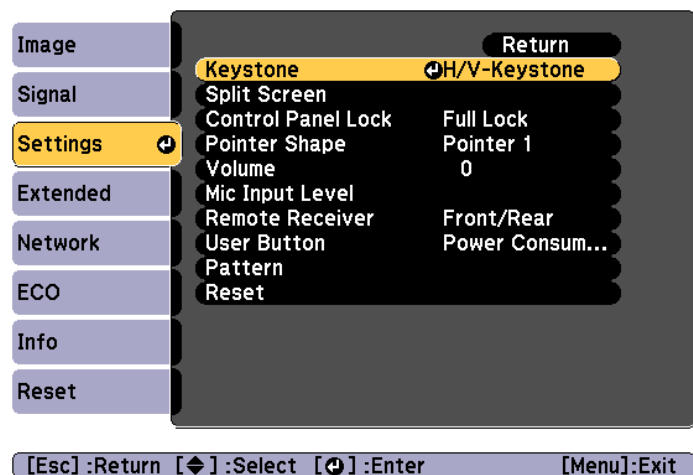

3 Select **Quick Corner**, and then press the [↵] button.

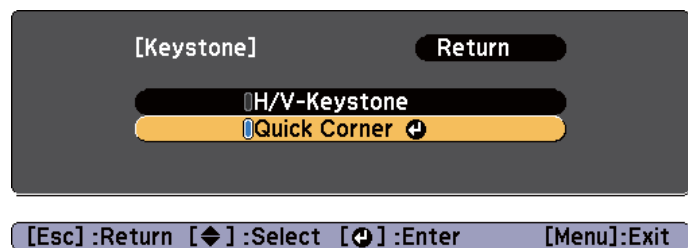

4 Using the [↶], [↷], [↸], and [↹] buttons on the remote control, or the [Z], [V], [L], and [R] buttons (or the [Wide]/[Tele] buttons) on the control panel, select the corner to correct, and then press the [↵] button.

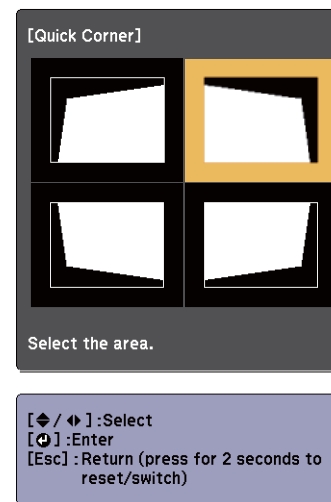

5 Using the [↶], [↷], [↸], and [↹] buttons on the remote control, or the [Z], [V], [L], and [R] buttons (or the [Wide]/[Tele] buttons) on the control panel, correct the position of the corner.

When you press the [↵] button, the screen shown in step 4 is displayed.

If the message "Cannot adjust any further." is displayed while adjusting, you cannot adjust the shape any further in the direction indicated by the gray triangle.

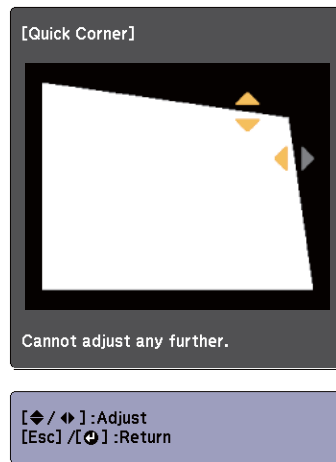

6 Repeat procedures 4 and 5 as needed to adjust any remaining corners.

7 When you are done, press the [Esc] button to exit the correction menu.

Because **Keystone** was changed to **Quick Corner**, the corner selection screen shown in step 4 is displayed the next time you press the [△] or [▽] button on the control panel. Change **Keystone** to **H/V-Keystone** if you want to perform horizontal and vertical correction using the [△] or [▽] button on the control panel.

☛ **Settings - Keystone - H/V-Keystone** p.105



If the [Esc] button is held down for about two seconds while the corner selection screen from step 4 is displayed, the following screen is displayed.

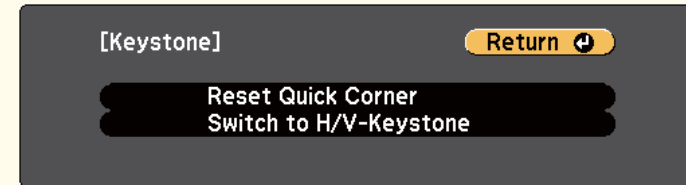

[Esc] / [⏪] : Return [◀] : Select [Menu] : Exit

Reset Quick Corner: Resets the result of Quick Corner corrections.

Switch to H/V-Keystone: Switches the correction method to H/V-Keystone.

☛ "Settings Menu" p.105

Adjusting the Image Size

For EB-955WH/EB-950WH/EB-965H/EB-945H/EB-940H/EB-98H/EB-97H/EB-W29/EB-X30/EB-X29/EB-X27

Turn the zoom ring to adjust the size of the projected image.

For EB-S29/EB-S27

Adjust by using the [Wide]/[Tele] buttons on the control panel.

Wide: Enlarges the size of the projected image.

Tele: Reduces the size of the projected image.

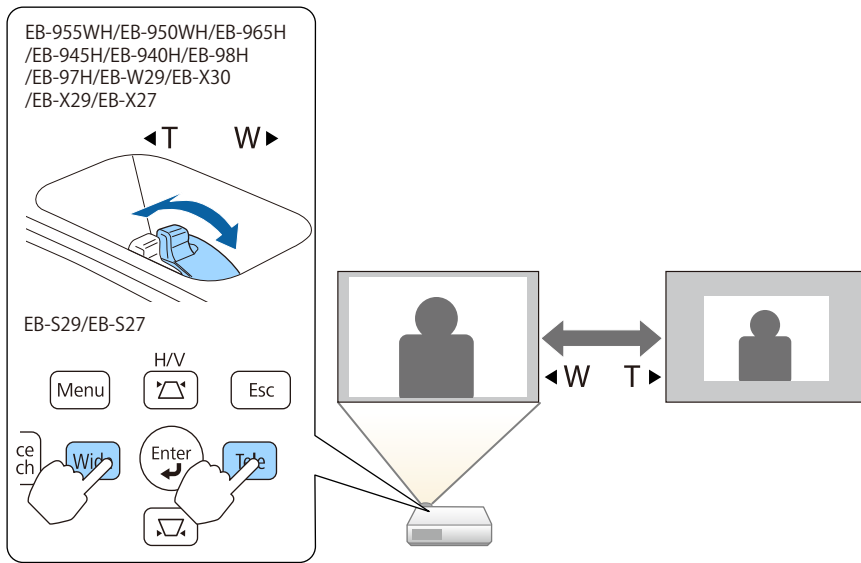

Adjusting the Horizontal Tilt

Extend and retract the rear feet to adjust the projector's horizontal tilt.

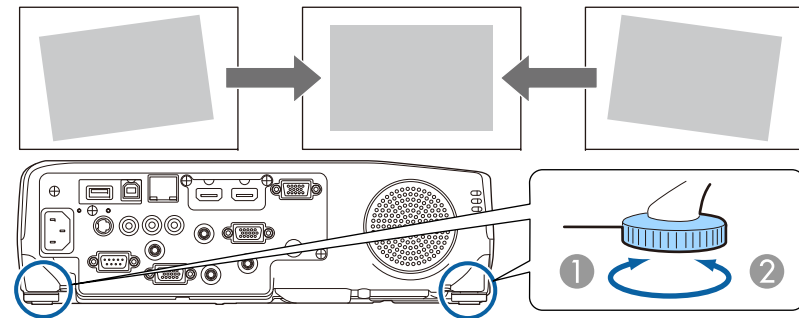

- ① Extend the rear foot.
- ② Retract the rear foot.

Adjusting the Image Position

Press the foot adjust lever to extend the front adjustable foot. You can adjust the position of the image by tilting the projector up to 12 degrees.

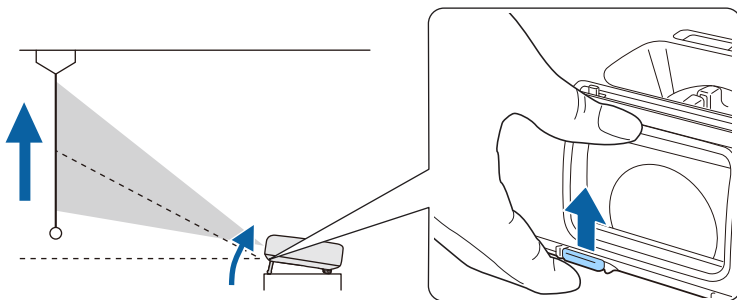

The larger the angle of tilt, the harder it becomes to focus. Install the projector so that it only needs to be tilted at a small angle.

Correcting the Focus

You can correct the focus using the focus ring.

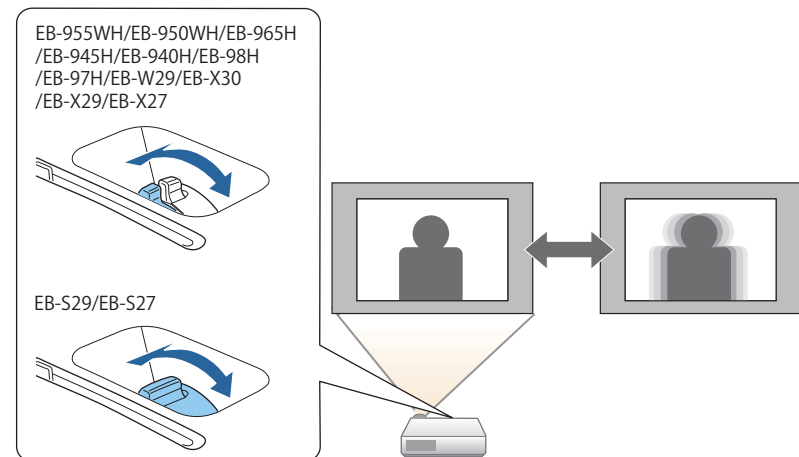

Adjusting the Volume

You can adjust the volume using one of the following methods.

- Press the [Volume] button on the control panel or the remote control to adjust the volume.
 - [◀] Decreases the volume.
 - [▶] Increases the volume.

Using the remote control

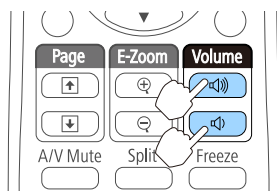

Using the control panel (Except for EB-S29/EB-S27)

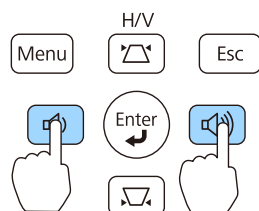

- Adjust the volume from the Configuration menu.
 - ☛ **Settings - Volume** p.105

Caution

Do not start at high volume.
A sudden excessive volume may cause loss of hearing. Always lower the volume before powering off, so that you can power on and then gradually increase the volume.

Selecting the Projection Quality (Selecting Color Mode)

You can easily obtain the optimum image quality simply by selecting the setting that best corresponds to your surroundings when projecting. The brightness of the image varies depending on the mode selected.

Mode	Application
Dynamic	This is the brightest mode. Ideal for use in a bright room.
Presentation	The images are vivid and brought to life. Ideal for making presentations or watching TV programs in a bright room.
Theatre	Gives images a natural tone. Ideal for watching films in a dark room.
sRGB	Ideal for reproducing images that conform to the <u>sRGB</u> color standard. Ideal for projecting still pictures, such as photos.
Blackboard	Even if you are projecting onto a blackboard (greenboard), this setting gives your images a natural tint, just like when projecting onto a screen.

Each time you press the [Color Mode] button, the Color Mode name is displayed on the screen and the Color Mode changes.

Remote control

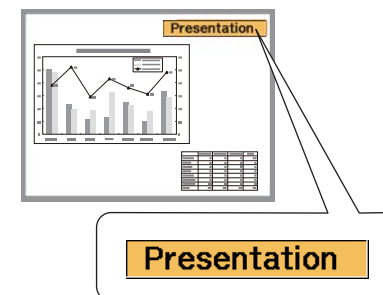
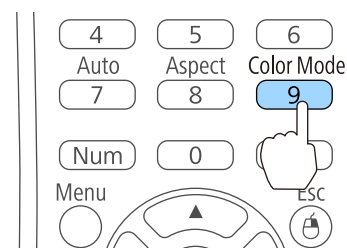



You can set Color Mode from the Configuration menu.

☛ **Image - Color Mode** p.102

Setting Auto Iris

By automatically setting the luminance according to the brightness of the displayed image, it lets you enjoy deep and rich images.

1 Press the [Menu] button.

☛ "Using the Configuration Menu" p.99

Using the remote control

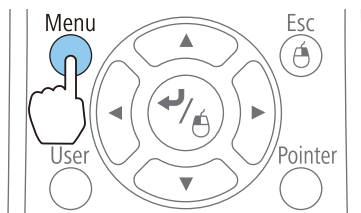

Using the control panel

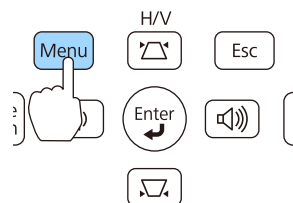

2 Select **Auto Iris** from **Image**.

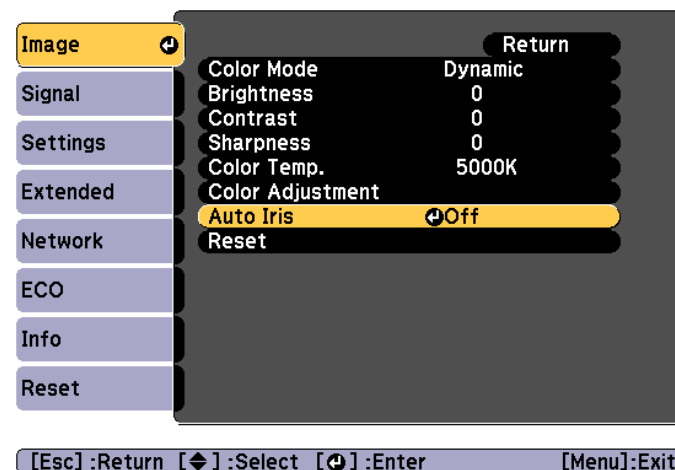

3 Select **Normal** or **High Speed**.

The setting is stored for each Color Mode.



When set to **High Speed**, the brightness of the image is adjusted as soon as the scene changes.

4 Press the [Menu] button to finish making settings.



- Auto Iris can only be set when the **Color Mode** is **Dynamic** or **Theatre**.
- When **Auto Iris** is set to **Normal** or **High Speed**, **Light Optimizer** is enabled (this is also enabled when **Light Optimizer** is set to **Off** and the **Light Optimizer** settings cannot be changed).

Changing the Aspect Ratio of the Projected Image

You can change the Aspect Ratio of the projected image to suit the type, the ratio of height and width, and the resolution of the input signals.

Available aspect modes vary depending on the image signal currently being projected.

Changing methods

Each time you press the [Aspect] button on the remote control, the aspect mode name is displayed on the screen and the aspect ratio changes.

Remote control

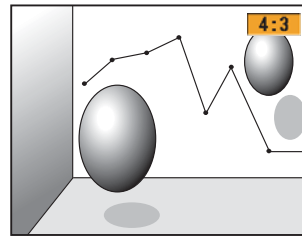
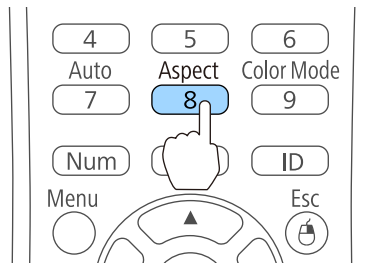

You can set the aspect ratio from the Configuration menu.

➡ **Signal - Aspect** [p.103](#)

Changing the aspect mode

Projecting images from video equipment or from the HDMI port (For EB-955WH/EB-950WH/EB-W29)

Each time the [Aspect] button is pressed, the aspect mode changes in the order **Normal or Auto**, **16:9**, **Full**, **Zoom**, and **Native**.

Example: 1080p signal input (resolution: 1920x1080, aspect ratio: 16:9)

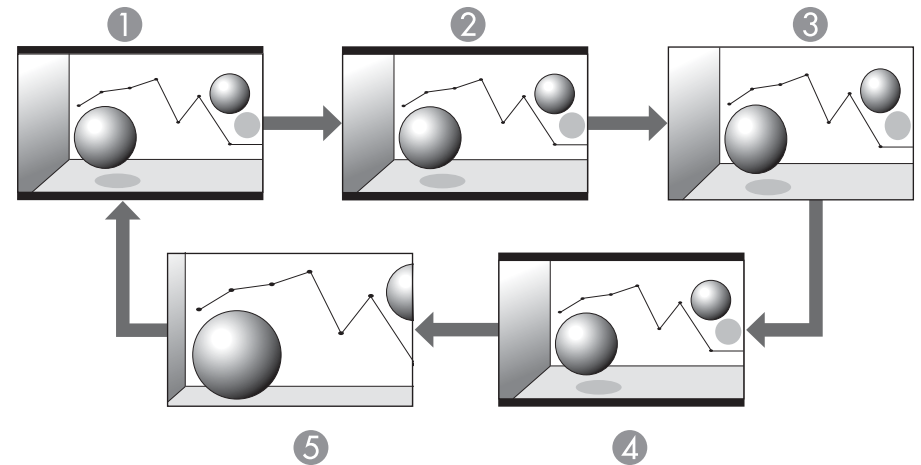

- ① Normal or Auto
- ② 16:9
- ③ Full
- ④ Zoom
- ⑤ Native

Projecting images from video equipment (For EB-965H/EB-945H/EB-940H/EB-98H/EB-97H/EB-X30/EB-X29/EB-X27/EB-S29/EB-S27)

Each time the [Aspect] button is pressed, the aspect mode changes in the order **4:3** and **16:9**.

When inputting a 720p/1080i signal and the aspect mode is set to **4:3**, a 4:3 zoom is applied (the right and left sides of the image are cut off).

Example: 720p signal input (resolution: 1280x720, aspect ratio: 16:9)

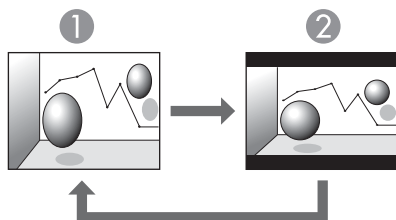

- ① 4:3
- ② 16:9

Projecting images from the HDMI port (For EB-965H/EB-945H/EB-940H/EB-98H/EB-97H/EB-X30/EB-X29/EB-X27/EB-S29/EB-S27)

Each time the [Aspect] button is pressed, the aspect mode changes in the order **Auto**, **4:3**, and **16:9**.

Example: 1080p signal input (resolution: 1920x1080, aspect ratio: 16:9)

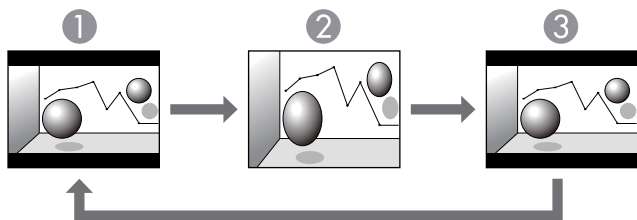

- ① Auto
- ② 4:3
- ③ 16:9

Projecting images from a computer

The following shows projection examples for each aspect mode.

For EB-955WH/EB-950WH/EB-W29

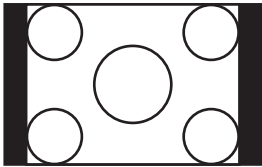
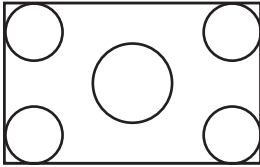
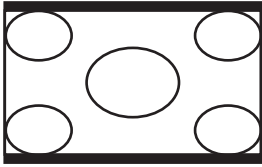
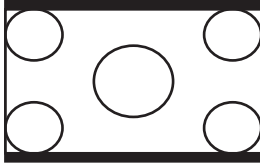
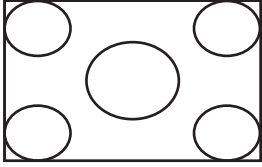
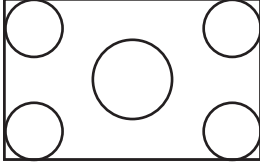
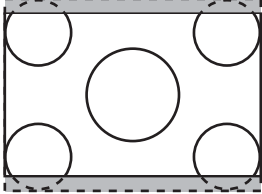
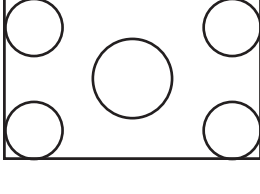
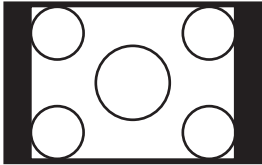
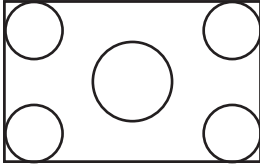
Aspect Mode	Input Signal	
	XGA 1024X768(4:3)	WXGA 1280X800(16:10)
Normal		
16:9		
Full		
Zoom		
Native		

For EB-965H/EB-945H/EB-940H/EB-98H/EB-97H/EB-X30/EB-X29/EB-X27/EB-S29/EB-S27

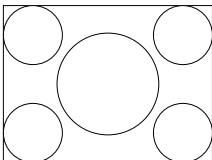
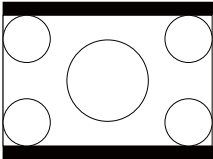
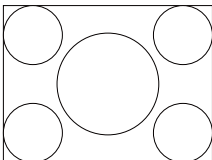
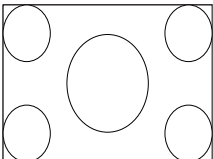
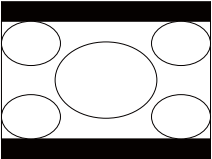
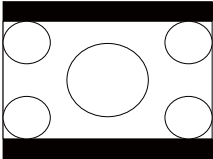
Aspect Mode	Input Signal	
	XGA 1024X768(4:3)	WXGA 1280X800(16:10)
Normal		
4:3		
16:9		



If parts of the image are missing, set the **Resolution** setting to **Wide** or **Normal** from the Configuration menu, according to the size of the computer panel.

☛ **Signal - Resolution** [p.103](#)



Useful Functions

This chapter explains useful tips for giving presentations, and the Security functions.

Projecting Two Images Simultaneously (Split Screen)

You can simultaneously project images from two sources on the right and left of the screen.

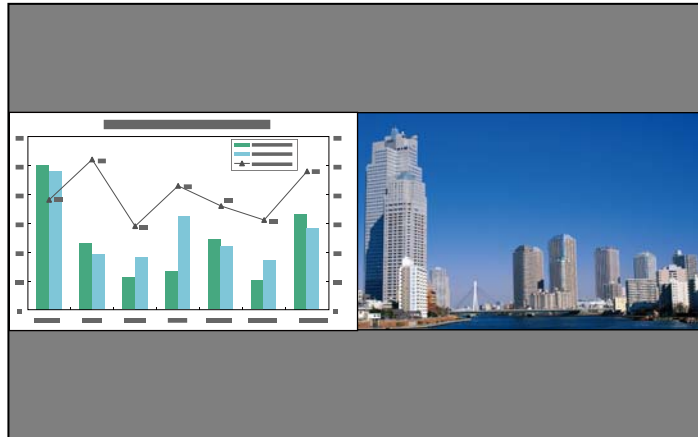

Input sources for split screen projection

The combinations of input sources that can be projected on a split screen are listed below.

Left Screen	Right Screen								
	Compu-ter1	Compu-ter2	S-Vid-eeo	Vid-eeo	HD MI or HD MI1	HD MI2*	USB Dis-play	USB	LAN
Comput-er1	-	-	-	-	✓	✓	✓	✓	✓
Comput-er2	-	-	-	-	✓	✓	✓	✓	✓
S-Video	-	-	-	-	✓	✓	✓	✓	✓
Video	-	-	-	-	✓	✓	✓	✓	✓
HDMI or HDMI1	✓	✓	✓	✓	-	✓	✓	✓	✓
HDMI2*	✓	✓	✓	✓	✓	-	✓	✓	✓
USB Dis-play	✓	✓	✓	✓	✓	✓	-	-	-
USB	✓	✓	✓	✓	✓	✓	-	-	-
LAN	✓	✓	✓	✓	✓	✓	-	-	-

* The HDMI2 port is only available for EB-955WH/EB-950WH/EB-965H/EB-945H/EB-940H/EB-98H/EB-97H.

Operating procedures

Projecting on a split screen

- 1 Press the [Split] button while projecting.
The currently selected input source is projected on the left of the screen.

Remote control

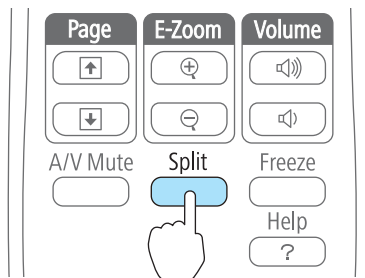

You can perform the same operations from the configuration menu.

👉 [Settings - Split Screen p.105](#)

- 2 Press the [Menu] button.
The Split Screen Setup screen is displayed.

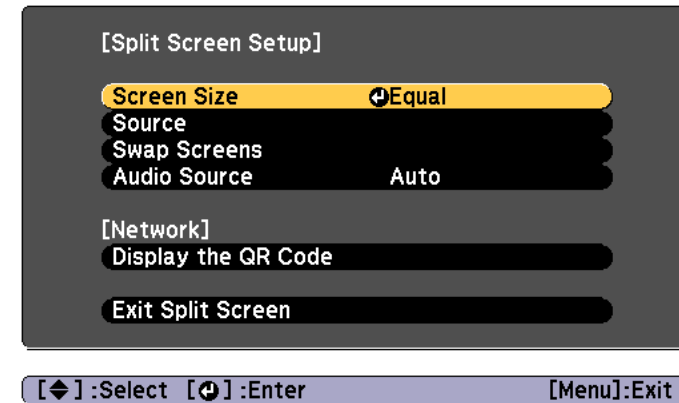

- 3 Select **Source**, and then press the [↵] button.

4 Select each input source for **Left** and **Right**.

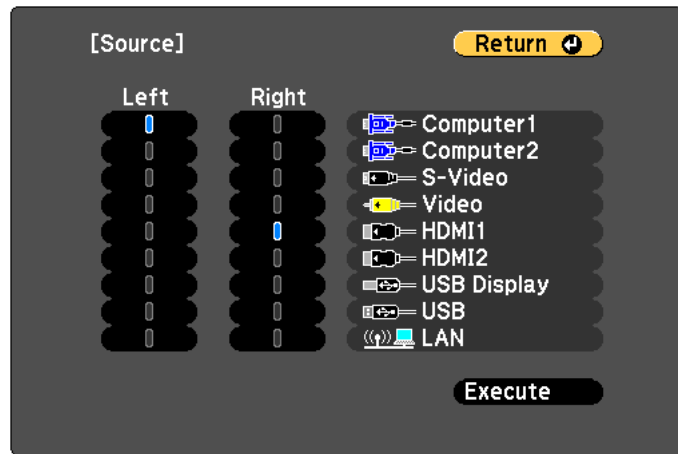

[Esc]/[⏏]:Return [⏏]:Select [Menu]:Exit

Only input sources that can be combined can be selected.

☞ "Input sources for split screen projection" [p.59](#)



The Source screen is also displayed when the following buttons are pressed during split screen projection.

- [Source Search] button
- [Computer] button
- [Video] button
- [USB] button
- [LAN] button

5 Select **Execute**, and then press the [↵] button.

To switch the source during split screen projection, start the procedure from step 2.

Switching the left and right screens

Use the following procedure to switch the projected images displayed on the left and right screens.

- 1 Press the [Menu] button during split screen projection.
- 2 Select Swap Screens, and then press the [↵] button.
The projected images on the left and right are swapped.



Switching the left and right image sizes

- 1 Press the [Menu] button during split screen projection.
- 2 Select the **Screen Size**, and then press the [↵] button.
- 3 Select the screen size you want to display, and then press the [↵] button.

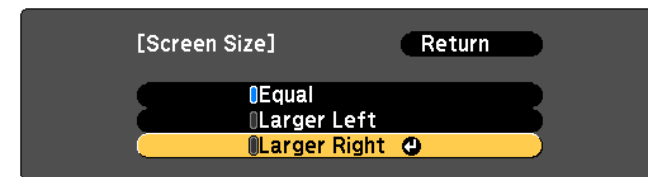

The projected images will appear as shown below after setting the screen size.

Equal

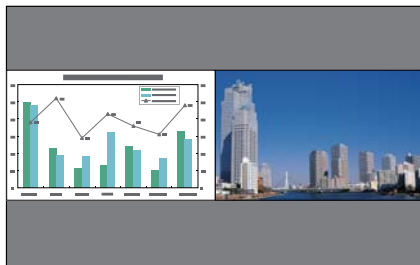

Larger Left

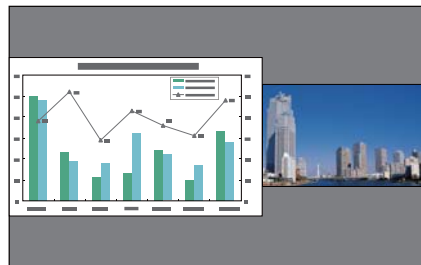

Larger Right

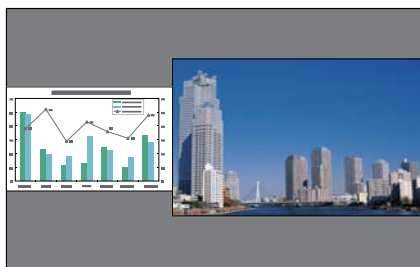

- You cannot enlarge both the left screen and right screen images at the same time.
- When one image is enlarged, the other image is reduced.
- Depending on the video signals that are input, the images on the left and right may not appear to be the same size even if **Equal** is set.

Ending the split screen

To end split screen, press the [Esc] button.

The following steps can also be used to end the split screen.

- Press the [Split] button on the remote control.

- Select **Exit Split Screen** from the configuration menu.
 **Settings - Split Screen - Split Screen Setup** p.105

Restrictions during split screen projection

Operating restrictions

The following operations cannot be performed during split screen projection.

- Setting the configuration menu
- E-Zoom
- Switching the aspect mode (**Normal** is used for the aspect mode.)
- Operations using the [User] button on the remote control (This can be operated when **User Button** is set to **Flip Horizontal**.)
- Auto Iris

Help can be displayed only when image signals are not input or when an error or warning notification is displayed.

Restriction relating to images

- The default values for the **Image** menu are applied to the image on the right screen. However, the settings for the image projected on the left screen are applied to the image on the right screen for **Color Mode**, **Color Temp.**, **Color Adjustment**, **Brightness**, **Contrast**, **Color Saturation**, and **Tint**.
- The setting value **Off** for **Progressive** and **Noise Reduction** is applied to the image on the right screen.
 "Signal Menu" p.103
- When there is no image signal being input, the display screen is the color that is set in Display Background. When **Logo** is selected, the display is **Blue**.
- When A/V Mute is performed, the display is **Black**.

Projecting Without a Computer (PC Free)

By connecting a USB storage device such as a USB flash drives or a USB hard disk to the projector, you can project the files stored on the device without using a computer. This function is called PC Free.



- You may not be able to use USB storage devices that incorporate security functions.
- You cannot correct keystone distortion while projecting in PC Free, even if you press the [↖] and [↗] buttons on the control panel.

Specifications for files that can be projected using PC Free

Type	File Type (Extension)	Notes
Image	.jpg	The following cannot be projected. - CMYK color mode formats - Progressive formats - Images with a resolution greater than 8192 x 8192 Due to the characteristics of JPEG files, images may not be projected clearly if the compression ratio is too high.
	.bmp	Cannot project images with a resolution greater than 1280 x 800.
	.gif	<ul style="list-style-type: none"> • Cannot project images with a resolution greater than 1280 x 800. • Cannot project animated GIFs.
	.png	Cannot project images with a resolution greater than 1280 x 800.

Type	File Type (Extension)	Notes
Movie	.avi (Motion JPEG)	<ul style="list-style-type: none"> • Cannot project images with a resolution greater than 1280 x 720. • The audio format can only playback linear PCM and ADPCM. • Supports AVI 1.0. You cannot project files over 2 GB.



- When connecting and using a USB-compatible hard disk, make sure you connect the AC adaptor supplied with the hard disk.
- The projector does not support some file systems, so use media that has been formatted in Windows.
- Format the media in FAT16/32.

PC Free examples

Projecting images stored on USB storage





☛ "Projecting the selected image" [p.66](#)

☛ "Projecting image files in a folder in sequence (Slideshow)" [p.67](#)

PC Free operating methods





Although the following steps are explained based on the remote control, you can perform the same operations from the control panel.

Starting PC Free

- 1** Change the source to USB.
 "Switching to the Target Image by Remote Control" [p.42](#)
- 2** Connect the USB storage device to the projector.
 "Connecting USB Devices" [p.32](#)

PC Free starts and the file list screen is displayed.

- The following files are displayed as thumbnails (file contents are displayed as small images).
 - JPEG files
 - AVI files (displays the image at the start of the movie)
- Other files or folders are displayed as icons as shown in the following table.

Icon	File	Icon	File
	JPEG files*		BMP files
	GIF files		PNG files
	AVI (Motion JPEG) files*		

* When it cannot be displayed as a thumbnail, it is displayed as an icon.





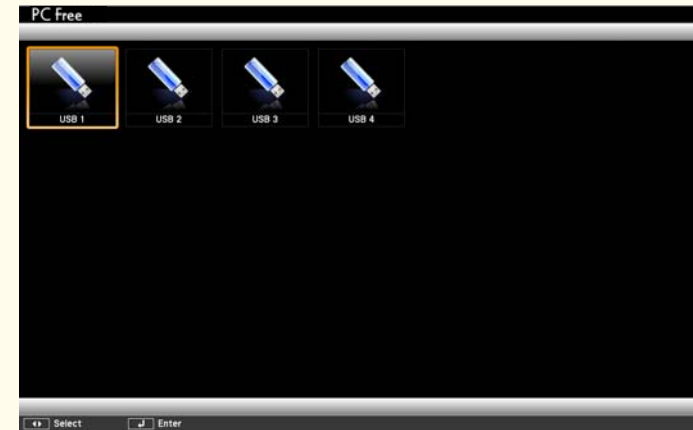

- You can also insert a memory card into a USB card reader and then connect the reader to the projector. However, some commercially available USB card readers may not be compatible with the projector.
- The projector can recognize up to five media at a time.
- If the following screen (Select Drive screen) is displayed, press the [⏪], [⏩], [⏴], or [⏵] buttons to select the drive you want to use, and then press the [↵] button.







- To display the Select Drive screen, position the cursor on **Select Drive** at the top of the file list screen, and then press the [↵] button.



Projecting images

- 1 Press the , , , or  buttons to select the file or folder you want to project.





If not all of the files and folders are displayed on the current screen, press the  button on the remote control, or position the cursor on **Next Page** at the bottom of the screen and press the  button.

To return to the previous screen, press the  button on the remote control, or position the cursor on **Previous Page** at the top of the screen and press the  button.

- 2 Press the  button.
The selected image is displayed.
When a folder is selected, the files in the selected folder are displayed. To return to the previous screen, position the cursor on **Back to Top** and press the  button.

Rotating images

You can rotate the played images in 90° increments. The rotating function is also available during Slideshow.

- 1 Play images, or run Slideshow.
- 2 While projecting, press the  or  button.

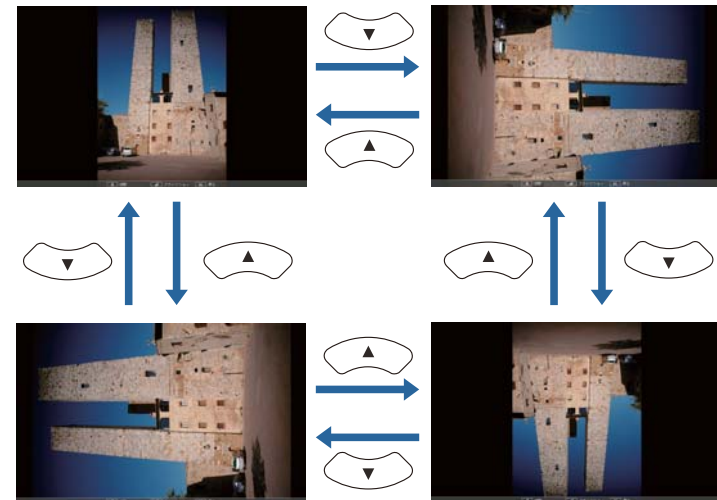

Stopping PC Free





To close PC Free, disconnect the USB device from the USB port on the projector. For devices such as digital cameras or hard disks, turn off the device and then remove it from the projector.

Projecting the selected image

Attention

Do not disconnect the USB storage device while it is being accessed. PC Free may not operate correctly.



- 1 Start PC Free.
The file list screen is displayed.
☛ "Starting PC Free" p.64

- 2 Press the , , , and  buttons to select the image file you want to project.



- 3 Press the  button.
The image is displayed or the movie is played back.



Press the ,  buttons to move to the next or previous image file.

- 4 To finish projecting, perform one of the following operations.
 - Projecting an image: Press the [Esc] button.
 - Projecting a movie: Press the [Esc] button to display the message screen, select **Exit**, and then press the  button.

When projection is finished, you are returned to the file list screen.







Projecting image files in a folder in sequence (Slideshow)

You can project the image files in a folder in sequence, one at a time. This function is called Slideshow. Use the following procedure to run Slideshow.



To change files automatically when you run Slideshow, set **Screen Switching Time** from **Option** in Slideshow to anything other than **No**. The default setting is 3 seconds.

☛ "Image file display settings and Slideshow operation settings"
p.68

- 1** Start PC Free.
The file list screen is displayed.
☛ "Starting PC Free" p.64
- 2** Press the [, [, [, or [] buttons to position the cursor over the folder for the Slideshow that you want to run, and then press the [] button.
- 3** Select **Slideshow** at the bottom right of the file list screen, and then press the [] button.



Slideshow starts, and the image files in the folder are automatically projected in sequence, one at a time.

When the last file is projected, the file list is displayed again automatically. If you set **Continuous Play** to **On** in the Option window, projection starts again from the beginning when it reaches the end.

☛ "Image file display settings and Slideshow operation settings"
p.68

You can proceed to the next screen, return to the previous screen, or stop playback while projecting a Slideshow.



If **Screen Switching Time** on the Option screen is set to **No**, files do not change automatically when you select Play Slideshow. Press the [, the [, or the [] button to continue to the next file.

You can use the following functions when projecting a file with PC Free.

- Freeze
☛ "Freezing the Image (Freeze)" p.72
- A/V Mute
☛ "Hiding the Image and Sound Temporarily (A/V Mute)" p.71
- E-Zoom
☛ "Enlarging Part of the Image (E-Zoom)" p.73
- Pointer
☛ "Pointer Function (Pointer)" p.72

Image file display settings and Slideshow operation settings

You can set the file display order and Slideshow operations on the Option screen.

- 1** Select **Option** at the bottom of the file list screen, and then press the [**↵**] button.
- 2** When the following Option screen is displayed, set each of the items.
Select any of the options as necessary and press the [**↵**] button.
The following table shows the details for each item.

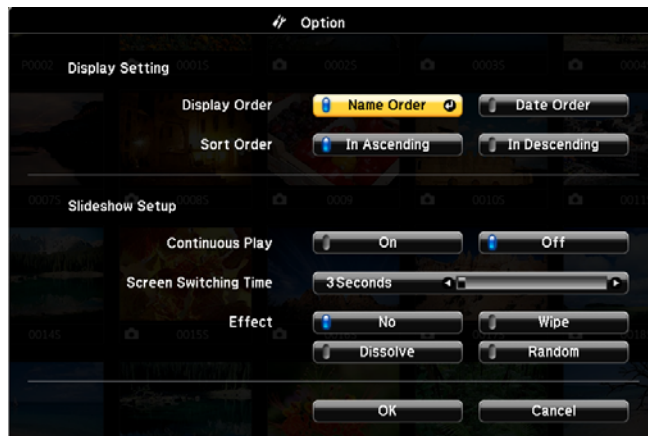

Display Order	You can select to display the files in Name Order or Date Order .
Sort Order	You can select to sort the files In Ascending or In Descending order.
Continuous Play	You can set whether to repeat the Slideshow.

Screen Switching Time	You can set the time for a single file to be displayed in Slideshow. You can set a time between No (0) to 60 Seconds. When you set No , auto play is disabled.
Effect	You can set the screen effects when changing slides.

- 3** When you have finished making settings, use the [**⏪**], [**⏩**], [**⏴**], or [**⏵**] buttons to position the cursor over **OK**, and then press the [**↵**] button.
The settings are applied.
If you do not want to apply the settings, position the cursor on **Cancel**, and then press the [**↵**] button.

Flipping the Image Horizontally (Flip Horizontal)

You can temporarily flip the image horizontally and project.

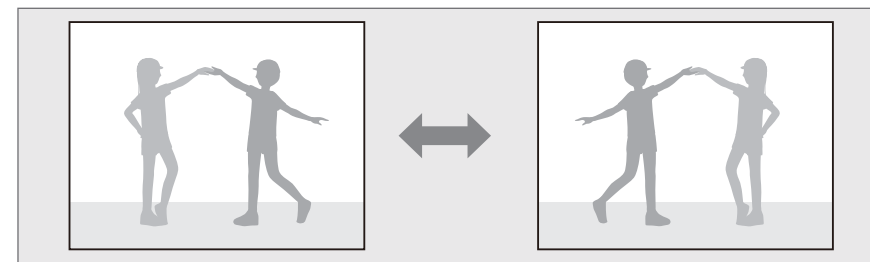

When **User Button** is set to **Flip Horizontal** from the Configuration menu, each time you press the [User] button, Flip Horizontal turns on or off.

☛ **Settings - User Button p.105**

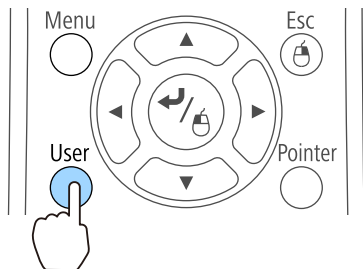

In the following situations, Flip Horizontal turns off.

- When the projector is off
- When the Configuration menu is displayed
- When the projector's **Projection** mode is changed
- When performing Keystone
- When Message Broadcasting is running

Projecting Using a QR Code

By reading a QR code displayed on the projected screen with Epson iProjection (V1.3.0 or later), you can easily project data on a smartphone or tablet device.

Check the following points before starting projection using a QR code.

When using the projector's wireless LAN function

- The optional Wireless LAN unit is installed
- **Wireless Mode** is set to **Wireless LAN On** from the Configuration menu

When using the projector's wired LAN function

- A LAN cable is connected to the projector



You can download Epson iProjection for free from the App Store or from Google play. Any fees incurred when communicating with the App Store or Google play are the responsibility of the customer.

Setting the display method for QR codes

Set the QR code display from the Configuration menu.

1

Press the [Menu] button.

☛ "Using the Configuration Menu" [p.99](#)

Using the remote control

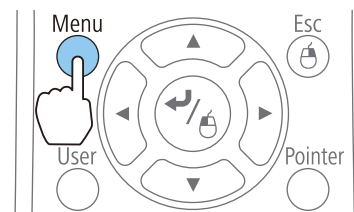

Using the control panel

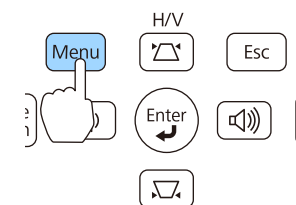

2

Select **Network Configuration** from **Network**.

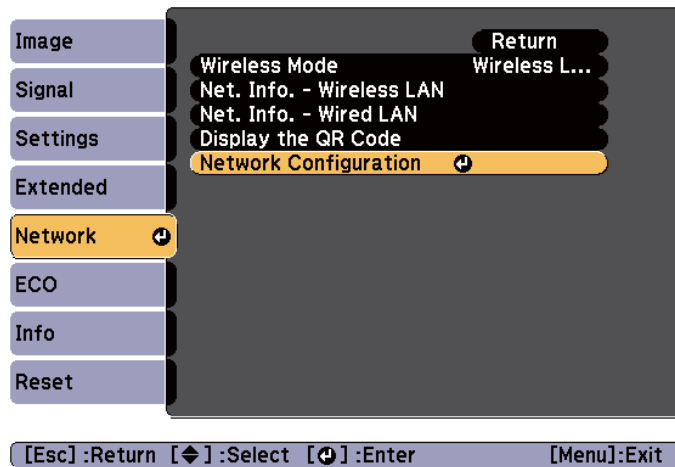

3 Select **Display LAN Info.** from **Basic.**

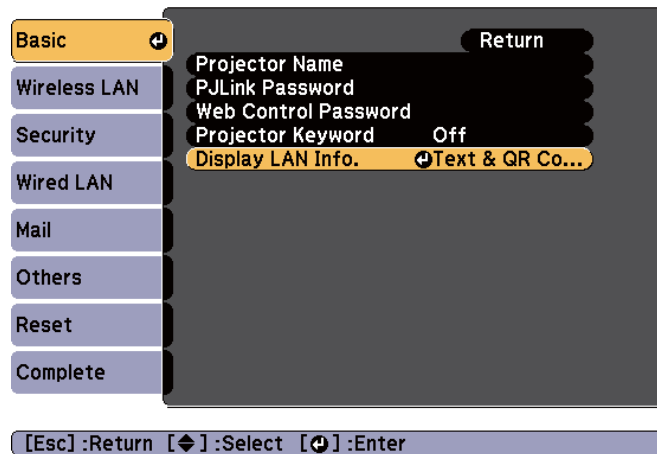

4 Select **Text & QR Code.**

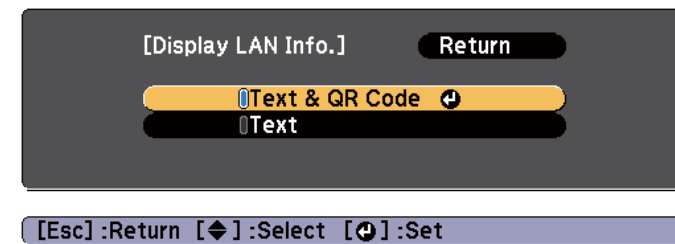

Text & QR Code



Projecting data from a smartphone or tablet device

Project data from your device using Epson iProjection.

- 1** Start Epson iProjection on your smartphone or tablet device.
- 2** Tap **Projector** on the application screen.
The projector's search screen is displayed.
- 3** Tap **Read QR code** on the application screen.
The camera starts and the preview screen is displayed.

- 4** Press the [LAN] button on the remote control, or select **Display the QR Code** from the **Network** menu to display the QR code.

Remote control

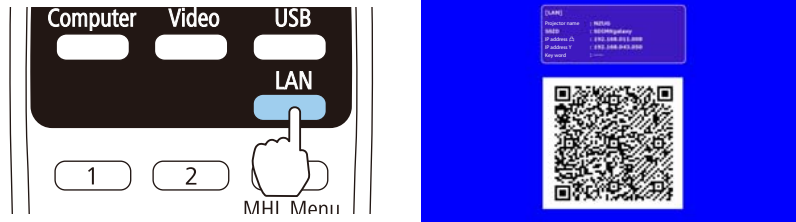

- When the projector is already receiving an image signal over the network, the QR code is not displayed even if you press the [LAN] button. Press the [] button on the remote control or the control panel (only when the source is LAN), or select **Display the QR Code** from the **Network** menu to display the QR code.
- To hide the QR code, press the [Esc] button on the remote control or the control panel.

- 5** Read the projected QR code with your smartphone or tablet device.

Make sure you read the QR code from in front of the screen so that it fits into the guide. If you are too far from the screen, the code may not be read.

When the connection is established, the image from the connected device is displayed. Tap **Files** on the application screen, and then select the file you want to project.

Hiding the Image and Sound Temporarily (A/V Mute)

You can use this when you want to focus the audience's attention on what you are saying, or if you do not want to show details such as when you are changing between files during presentations from a computer.

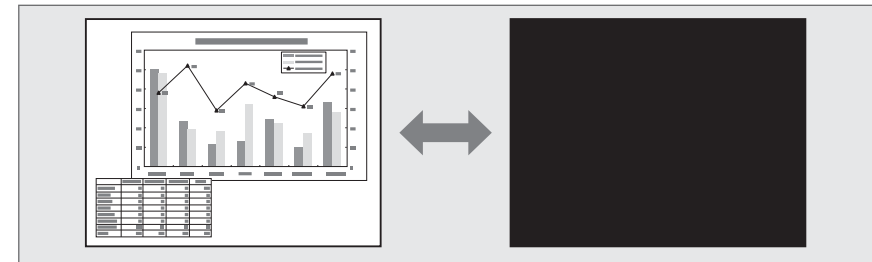

Each time you press the [A/V Mute] button or open/close the A/V mute slide, A/V Mute turns on or off.

Remote control

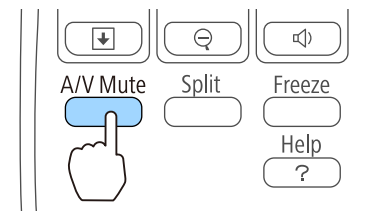

Projector

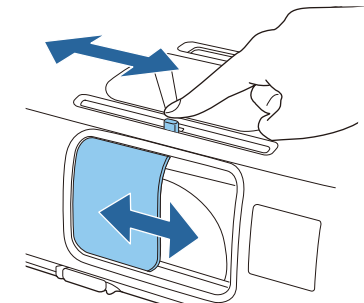



- When you operate the projector during A/V Mute, the A/V Mute function is released.
- When projecting moving images, the images and sound continue to be played back while A/V Mute is on. It is not possible to resume projection from the point where A/V Mute was activated.
- Microphone audio is still output even when [A/V Mute] is turned on. (EB-955WH/EB-950WH/EB-965H/EB-945H/EB-940H/EB-98H/EB-97H only)
- You can select the screen displayed when the [A/V Mute] button is pressed from the Configuration menu.
 - ☛ **Extended - Display - A/V Mute** p.106
- When A/V mute is enabled with the [A/V Mute] button, **A/V Mute Timer** activates and the power is automatically turned off after approximately 30 minutes. If you do not want to enable **A/V Mute Timer**, set **A/V Mute Timer** to **Off**.
 - ☛ **ECO - A/V Mute Timer** p.117
- When the A/V mute slide is closed for approximately 30 minutes, **Lens Cover Timer** activates and the power is automatically turned off. If you do not want **Lens Cover Timer** to activate, set **Lens Cover Timer** to **Off**.
 - ☛ **ECO - Lens Cover Timer** p.117
- The lamp is still lit during A/V Mute, so the lamp hours continue to accumulate.

Freezing the Image (Freeze)

When Freeze is activated on moving images, the frozen image continues to project on the screen, so you can project a moving image one frame at a time like a still photo. Also, you can perform operations such as changing between files during presentations from a computer without projecting any images if the Freeze function is activated beforehand.

Each time you press the [Freeze] button, Freeze turns on or off.

Remote control

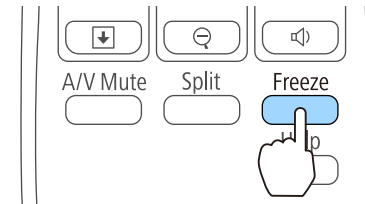

- Audio does not stop.
- When projecting moving images, the images continue to be played back while the screen is frozen. It is not possible to resume projection from the point where the screen was frozen.
- If the [Freeze] button is pressed while the Configuration menu or the Help screen is displayed, the menu or the Help screen that is displayed is closed.
- Freeze still works while E-Zoom is being used.

Pointer Function (Pointer)

This allows you to move a Pointer icon on the projected image, and helps you draw attention to the area you are talking about.

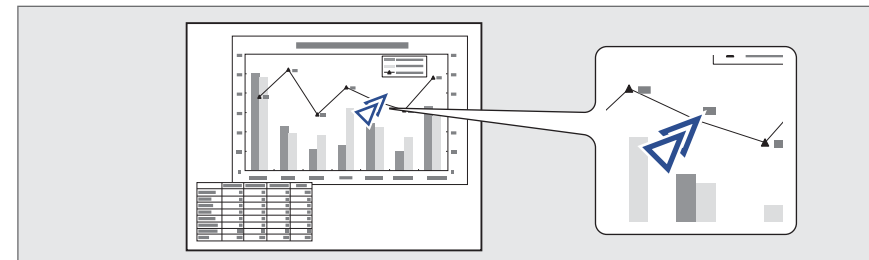

1 Display the Pointer.

Each time you press the [Pointer] button, the pointer appears or disappears.



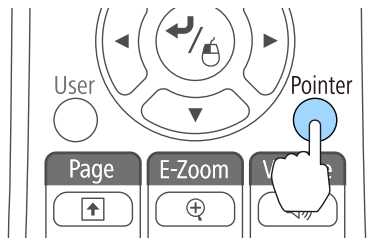

Remote control

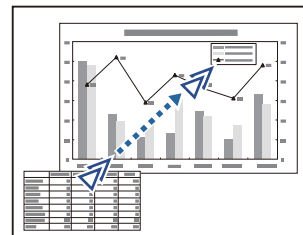
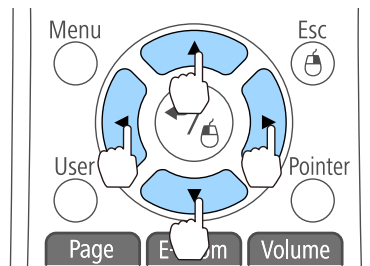

2 Move the Pointer icon (↖).

Remote control



When any pair of adjacent [, , , or ] buttons are pressed at the same time, the pointer can be moved diagonally.



You can select the shape of the pointer icon from the Configuration menu.



 **Settings - Pointer Shape** [p.105](#)

Enlarging Part of the Image (E-Zoom)

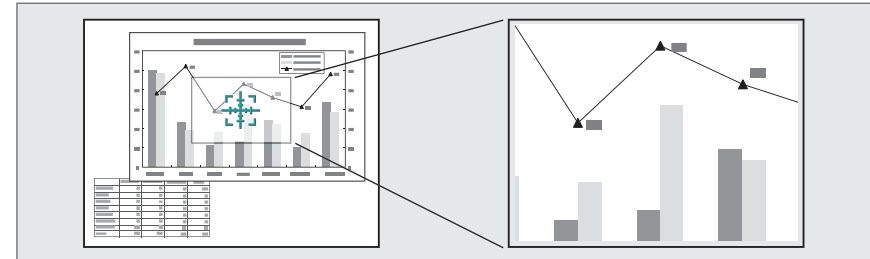
This is useful when you want to expand images to see them in greater detail, such as graphs and tables.



1 Start E-Zoom.

Press the [] button to display the Cross ().

Remote control

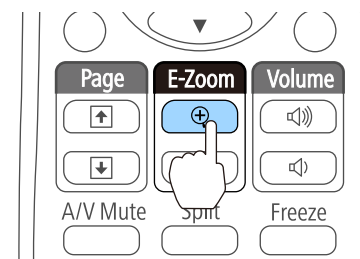

- 2 Move the Cross (⊕) to the area of the image that you want to enlarge.

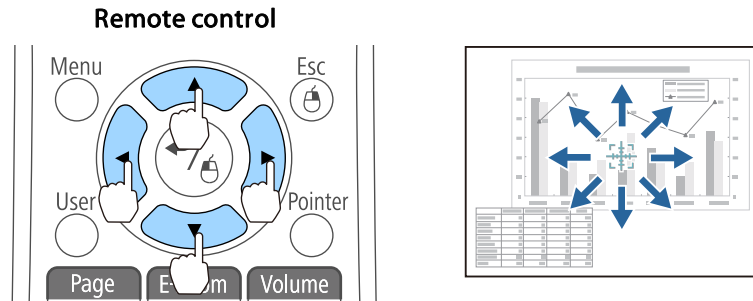

When any pair of adjacent [⏪], [⏩], [⏴], or [⏵] buttons are pressed at the same time, the pointer can be moved diagonally.

- 3 Enlarge.

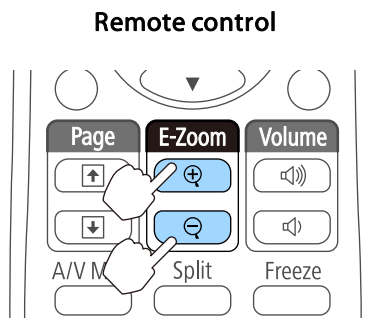

[⊕] button: Expands the area each time it is pressed. You can expand quickly by holding the button down.

[⊖] button: Reduces images that have been enlarged.

[Esc] button: Cancels E-Zoom.



- The enlargement ratio appears on the screen. The selected area can be enlarged to between 1 to 4 times in 25 incremental steps.
- During enlarged projection, press the [⏪], [⏩], [⏴], or [⏵] buttons to scroll the image.

Using the Remote Control to Operate the Mouse Pointer (Wireless Mouse)

You can control the computer's mouse pointer from the projector's remote control. This function is called Wireless Mouse.

The following operating systems are compatible with Wireless Mouse.

	Windows	OS X
OS	Windows 2000 Windows XP Windows Vista Windows 7 Windows 8 Windows 8.1	Mac OS X 10.3.x Mac OS X 10.4.x Mac OS X 10.5.x Mac OS X 10.6.x OS X 10.7.x OS X 10.8.x OS X 10.9.x

* It may not be possible to use the Wireless Mouse function under some versions of the operating systems.





Use the following procedure to enable the Wireless Mouse function.

- 1 Connect the projector to the computer with the USB cable.
 - ☛ "Connecting a Computer" p.28
- 2 Change the source to one of the following.
 - USB Display
 - Computer
 - HDMI
 - ☛ "Switching to the Target Image by Remote Control" p.42

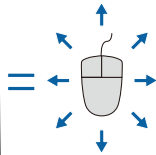
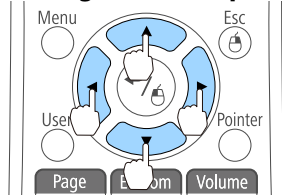
Once set, the mouse pointer can be controlled as follows.

Moving the mouse pointer



[][][][] buttons:
Moves the mouse pointer.



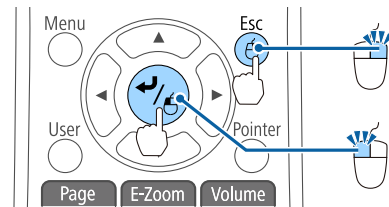



Mouse clicks

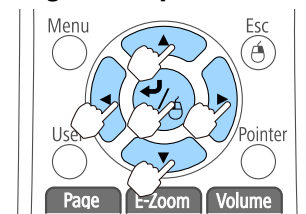

[Esc] button: Right click.
[] button: Left click. Press quickly twice to double-click.



Drag and drop





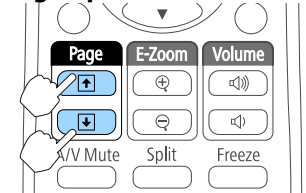

While holding down the [] button, press the [, [, [, or [] button.
Release the [] button to drop at the desired location.

Page Up/Down



[] button: Moves to the previous page.
[] button: Moves to the next page.



- When any pair of adjacent [, [, [, or [] buttons are pressed at the same time, the pointer can be moved diagonally.
- If the mouse button settings are set to reverse on the computer, the operation of the remote control buttons will also be reversed.
- The Wireless Mouse function does not work under the following conditions.
 - When projecting images from a device connected to the HDMI2/MHL port using an MHL cable
 - When the Configuration menu or a Help screen is displayed
 - When operating functions other than the Wireless Mouse function (such as adjusting the volume)
 However, when using the E-Zoom or Pointer function, the page up or down function is available.

Correcting the Color Difference when Projecting from Multiple Projectors

When lining up multiple projectors and projecting in parallel, use the **Image** menu to adjust the difference in brightness, tint, and so on between each image.



- In some cases the brightness and tint may not match completely even after correction.
- After some time has elapsed, the difference between brightness and tint may become more noticeable. If the difference between brightness and tint becomes noticeable, perform adjustments again.

Summary of correction procedure

When multiple projectors are set up and you need to make corrections, use the following procedure to correct one projector at a time.

1. Set the projector ID.

Set a unique projector ID for each of the target projectors so that you can limit which projector is being corrected.

2. Correct the color difference.





You can carry out color correction when projecting from multiple projectors.



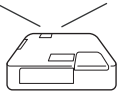

Setting an ID and using the remote control

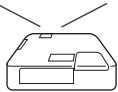
By setting an ID for each projector, you can limit which projector is operated from the remote control.

You can set an ID for the projector within a range of "1" to "9". The default value is Off.

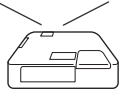
On the remote control, select the Projector ID from 0 to 9 for the projector you want to operate. The following examples show the combination of IDs for the Projector ID and the ID selected with the remote control.

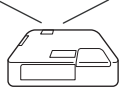
Operation	Combinations		Descriptions
Possible		Projector ID: 1	When the Projector ID and the ID selected with the remote control match, you can operate the projector from the remote control.
		ID selected with remote control: 1	
Possible		Projector ID: Off	When the Projector ID is set to Off, you can operate the projector regardless of the ID selected with the remote control.
		ID selected with remote control: 1	

Operation	Combinations		Descriptions
Possible		Projector ID: 1	When 0 is selected with the remote control, you can operate the projector from the remote control regardless of the Projector ID.
		ID selected with remote control: 0	
Not possible		Projector ID: 1	When the Projector ID and the ID selected with the remote control do not match, you cannot operate the projector from the remote control.
		ID selected with remote control: 3	

Setting the Projector ID

- 1 Press the [Menu] button while projecting.
 "Using the Configuration Menu" p.99

Control panel

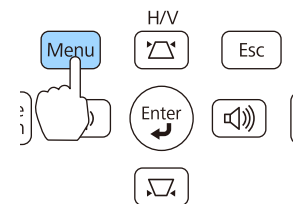

2 Select **Projector ID** from **Extended**.

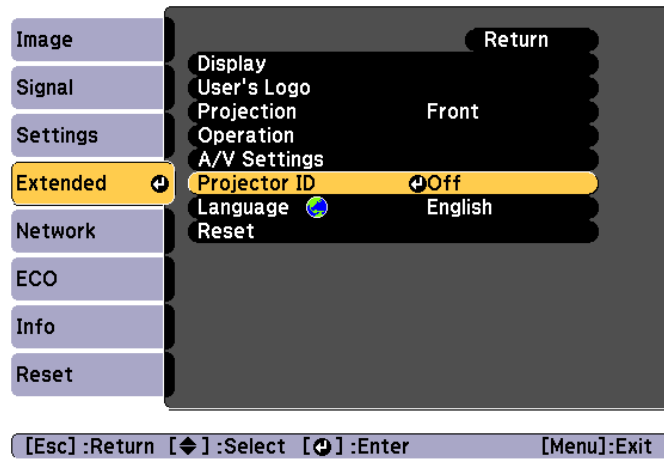

3 Choose the ID you want to set and press the [↵] button.

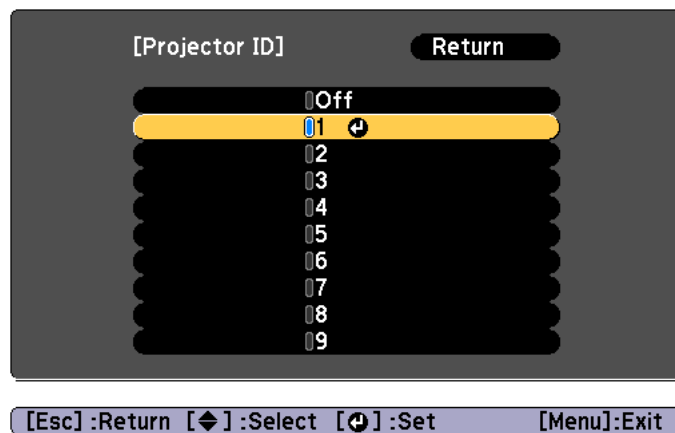

4 Press the [Menu] button to finish making settings. Perform steps 1 to 4 for all projectors and set a unique ID for each one.

Selecting the ID for the projector you want to operate using the remote control



Select the ID each time you turn on the projector. When the projector is turned on, the ID set for the remote control is 0.

- 1 Point the remote control at the remote receiver of the target projector and press the [ID] button on the remote control. When you press the [ID] button, the current Projector ID is displayed on the projection screen. It disappears in about three seconds.

Remote control

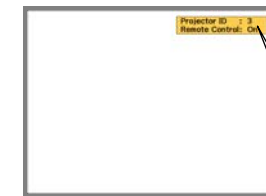
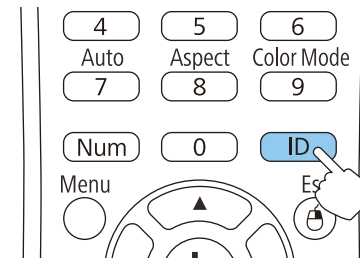

Projector ID : 3
Remote Control: On

- 2 While holding the [ID] button, press the number button that matches the ID of the projector you want to operate.

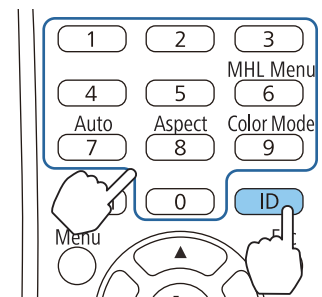

Correcting

After setting up the projectors, correct the brightness and tone for each projector to reduce the differences.

Correcting color differences

Operate using the remote control with the ID set according to the projector being used.

- 1** Press the [Menu] button.
 ☛ "Using the Configuration Menu" [p.99](#)
- 2** Select the item you want to set from **Image**, and then make each setting.

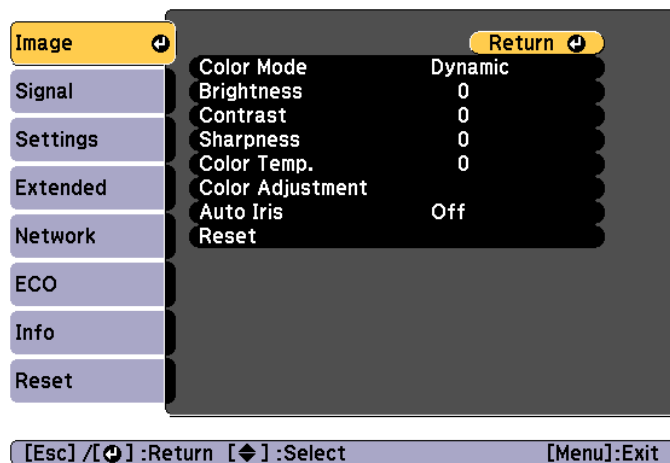

- 3** When all corrections are finished, press the [Menu] button to finish making settings.
 After matching the ID for the remote control to the projector, perform steps 1 to 3 for all projectors that need to be corrected.

Saving a User's Logo

You can save the image that is currently being projected as a User's Logo.



- Once a User's Logo has been saved, the logo cannot be returned to the factory default.
- If the content of the Configuration menu is set from another projector using the batch setup function, the registered User's Logo is set for the other projectors. Do not register confidential information and so on as the User's Logo.
 ☛ "Performing Batch Setup for Multiple Projectors" [p.120](#)

- 1** Project the image you want to save as the User's Logo, and then press the [Menu] button.
 ☛ "Using the Configuration Menu" [p.99](#)

Using the remote control

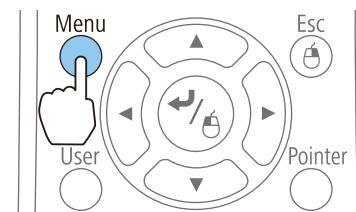

Using the control panel

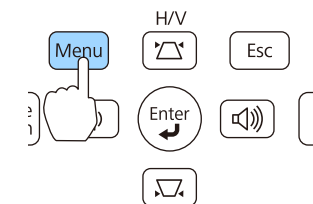

- 2** Select **User's Logo** from **Extended**.

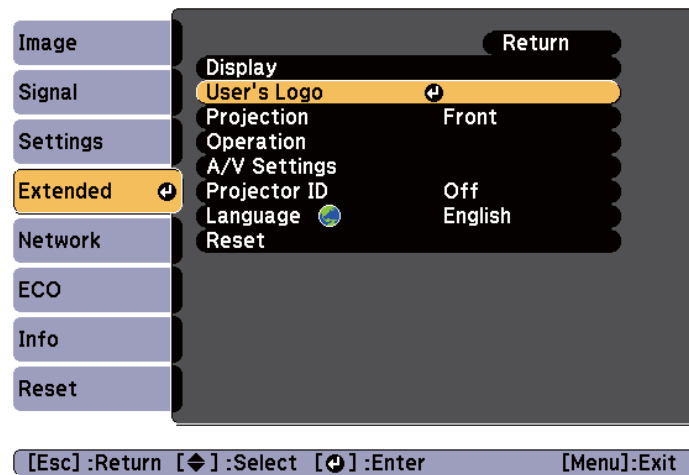

- When **User's Logo Protection** from **Password Protection** is set to **On**, a message is displayed and the User's Logo cannot be changed. You can make changes after setting **User's Logo Protection** to **Off**.
 - "Managing Users (Password Protection)" p.82
- If **User's Logo** is selected when Keystone, E-Zoom, Aspect, or Zoom is being performed, the function currently being performed is temporarily cancelled.

3 When the message "Choose this image as the User's Logo?" is displayed, select **Yes**.



When you press the [Left Arrow] button on the remote control or the control panel, the screen size may change depending on the signal to match the actual resolution of the image signal.

4 Move the box to select the part of the image to use as the User's Logo.

You can perform the same operations from the projector's control panel.

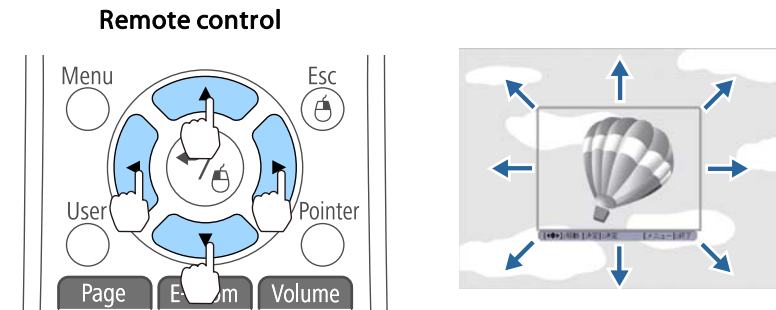

You can save at 400x300 dots in size.

5 When you press the [Left Arrow] button and the message "Select this image?" is displayed, select **Yes**.

6 Select the zoom factor from the zoom setting screen.

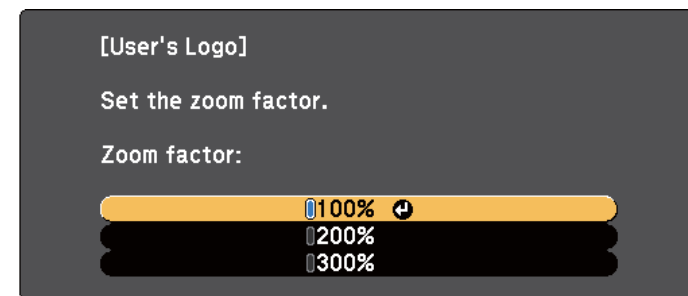

[Esc]:Return [Left Arrow]:Select [Right Arrow]:Set [Menu]:Exit

- When the message "Save this image as the User's Logo?" is displayed, select **Yes**.

The image is saved. After the image has been saved, the message "Completed." is displayed.



When a User's Logo is saved, the previous User's Logo is erased.

Saving User Pattern

You can save the image that is currently being projected as a User Pattern.



When a User Pattern is saved, the previous User Pattern is erased.

- Project the image you want to use as the User Pattern, and then press the [Menu] button.

"Using the Configuration Menu" p.99

Using the remote control

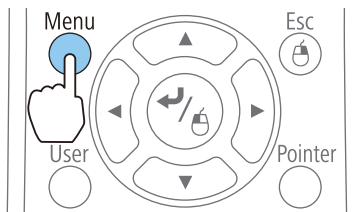

Using the control panel

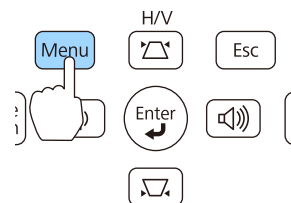

- Select **Pattern** from **Settings**.

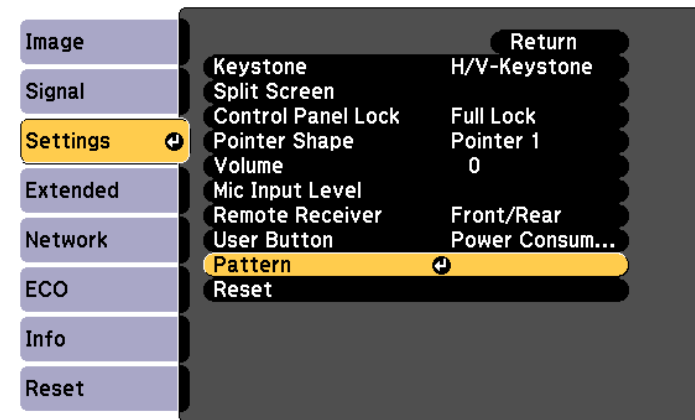

[Esc]:Return [◆]:Select [↵]:Enter [Menu]:Exit

- Select **User Pattern**.

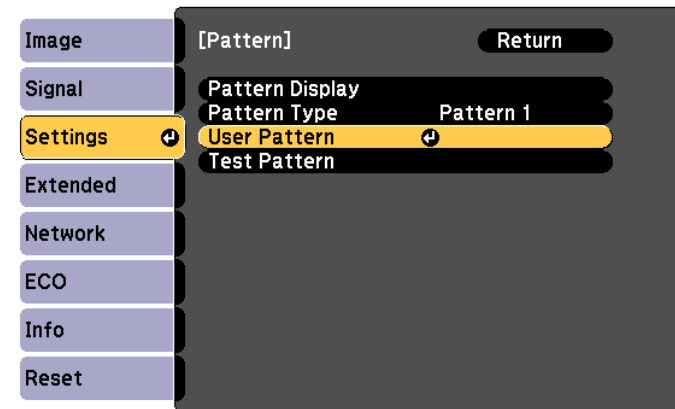

[Esc]:Return [◆]:Select [↵]:Enter [Menu]:Exit



If **User Pattern** is selected when Keystone, E-Zoom, Aspect, Progressive, or Zoom is being performed, the function currently being performed is temporarily cancelled.

4 When "Do you want to use the currently projected image as the User Pattern?" is displayed, select **Yes**.

5 When you press the [Enter] button, the message "Do you save this image as the User Pattern?" is displayed. Then, select **Yes**.

The image is saved. After the image has been saved, the message "The User Pattern setting is complete". is displayed.



Once a User Pattern has been saved, User Pattern cannot be returned to the factory default.

The projector has the following enhanced security functions.

- **Password Protect**
You can limit who can use the projector.
- **Control Panel Lock**
You can prevent people changing the settings on the projector without permission.
☛ "Restricting Operation (Control Panel Lock)" [p.84](#)
- **Anti-Theft Lock**
The projector is equipped with the following anti-theft security device.
☛ "Anti-Theft Lock" [p.86](#)

Managing Users (Password Protection)

When Password Protection is activated, people who do not know the password cannot use the projector to project images even if the projector power is on. Furthermore, the user's logo that is displayed when you turn on the projector cannot be changed. This acts as an anti-theft function as the projector cannot be used even if it is stolen. At the time of purchase, Password Protection is not activated.

Kinds of Password Protection

The following three kinds of Password Protection settings can be made according to how the projector is being used.

- **Power On Protection**
When **Power On Protection** is **On**, you need to enter a preset password after the projector is plugged in and turned on (this also applies to Direct Power On). If the correct password is not entered, projection does not start.

- **User's Logo Protection**

Even if someone tries to change the User's Logo set by the owner of the projector, it cannot be changed. When **User's Logo Protection** is set to **On**, the following setting changes for the User's Logo are prohibited.

- Capturing a User's Logo
- Setting **Display Background**, **Startup Screen**, or **A/V Mute** from **Display**
☛ **Extended - Display** [p.106](#)

- **Network Protection**

When **Network Protection** is set to **On**, changing the settings for **Network** is prohibited.

- ☛ "Network Menu" [p.108](#)

Setting Password Protection

Use the following procedure to set Password Protect.

- 1** During projection, hold down the [Freeze] button for about five seconds.

The Password Protection setting menu is displayed.

Remote control

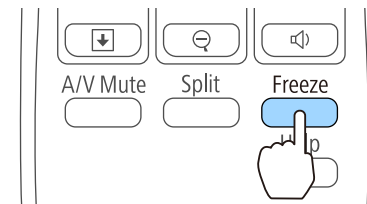



- If Password Protection is already activated, you must enter the password.
If the password is entered correctly, the Password Protection setting menu is displayed.
☞ "Entering the Password" p.83
- When the password is set, stick the password protect sticker in a visible position on the projector as a further theft deterrent.
☞ *Password Protect Sticker*

- 2** Select the type of Password Protect you want to set, and then press the [↵] button.

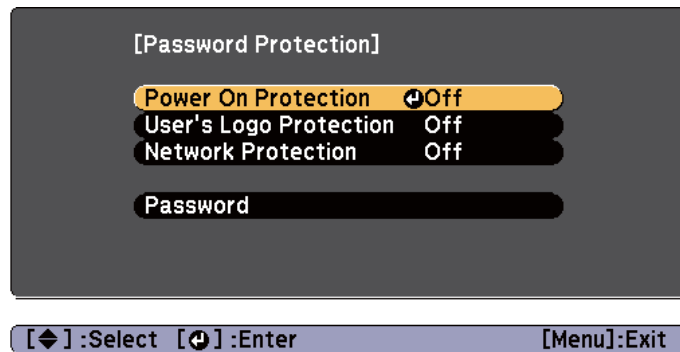

- 3** Select **On**, and then press the [↵] button.
Press the [Esc] button, the screen displayed in step 2 is displayed again.
- 4** Set the password.
- (1) Select **Password**, and then press the [↵] button.

- (2) When the message "Change the password?" is displayed, select **Yes** and then press the [↵] button. The default password is set to "0000". Change this to your own desired Password. If you select **No**, the screen displayed in step 2 is displayed again.
- (3) While holding down the [Num] button, enter a four digit number using the numeric buttons. The number entered is displayed as "* * * *". When you enter the fourth digit, the confirmation screen is displayed.

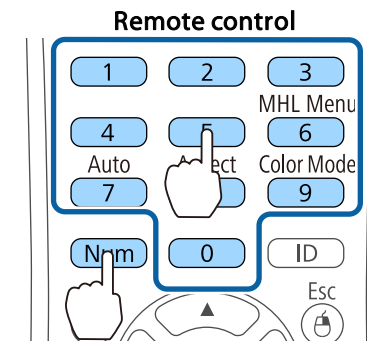

- (4) Re-enter the password.
The message "Password accepted." is displayed.
If you enter the password incorrectly, a message is displayed prompting you to re-enter the password.

Entering the Password

When the password entry screen is displayed, enter the password using the remote control.

While holding down the [Num] button, enter the password by pressing the numeric buttons.

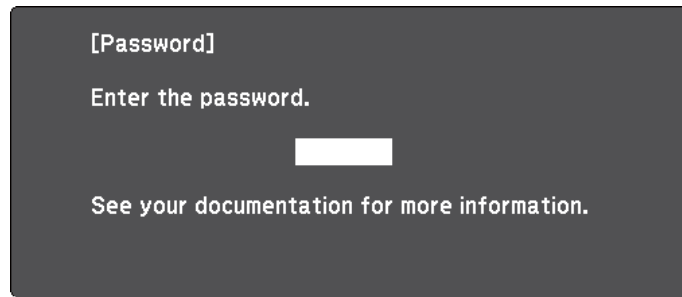

[0-9] :Enter

When you enter the correct password, Password Protect is temporarily released.

Attention

- If an incorrect password is entered three times in succession, the message "The projector's operation will be locked." is displayed for approximately five minutes, and then the projector switches to standby mode. If this happens, disconnect the power plug from the electrical outlet and then reinsert it and turn the projector's power back on. The projector displays the password entry screen again so that you can enter the correct password.
- If you have forgotten the password, make a note of the "**Request Code:** xxxxx" number that appears on the screen and contact the nearest address provided in the Epson Projector Contact List.
 - ☛ [Epson Projector Contact List](#)
- If you continue to repeat the above operation and enter the wrong password thirty times in succession, the following message is displayed and the projector does not accept any more password entries. "The projector's operation will be locked. Contact Epson as described in your documentation."
 - ☛ [Epson Projector Contact List](#)

Restricting Operation (Control Panel Lock)

Perform one of the following to lock the operation buttons on the control panel.

- **Full Lock**
All of the buttons on the control panel are locked. You cannot perform any operations from the control panel, including turning the power on or off.
- **Partial Lock**
All of the buttons on the control panel, except for the [⏻] power button, are locked.

This is useful at events or shows when you want to deactivate all buttons during projection or at schools when you want to limit button operation. The projector can still be operated using the remote control.

- 1 Press the [Menu] button while projecting.
 - ☛ "Using the Configuration Menu" p.99

Using the remote control

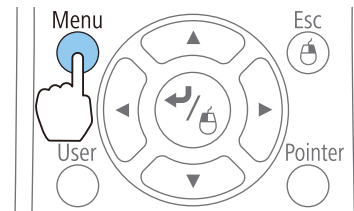

Using the control panel

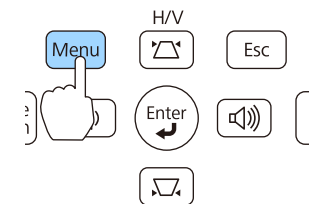

- 2** Select **Control Panel Lock** from **Settings**.

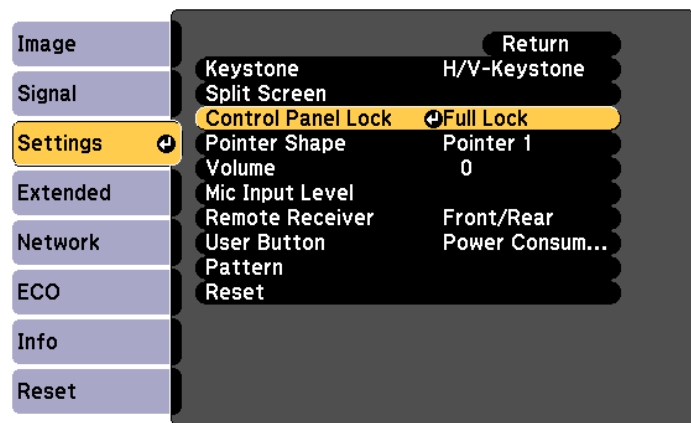

[Esc]:Return [◆]:Select [↵]:Enter [Menu]:Exit

- 3** Select either **Full Lock** or **Partial Lock** according to your purpose.

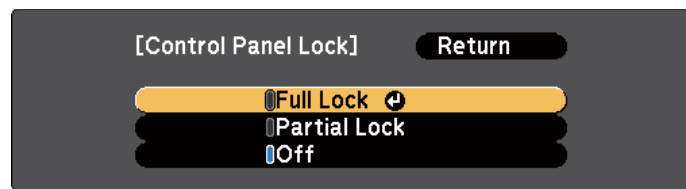

[Esc]:Return [◆]:Select [↵]:Set [Menu]:Exit

- 4** Select **Yes** when the confirmation message is displayed.
The control panel buttons are locked according to the setting you chose.



You can release the control panel lock by one of the following two methods.

- Select **Off** from **Control Panel Lock**.
 **Settings - Control Panel Lock** p.105
- Press and hold down the [↵] button on the control panel for about seven seconds, a message is displayed and the lock is released.

Anti-Theft Lock

The projector is equipped with the following types of anti-theft security devices.

- Security slot

The security slot is compatible with the Microsaver Security System manufactured by Kensington.

See the following for more details on the Microsaver Security System.

☞ <http://www.kensington.com/>

- Security cable installation point

A commercially available theft-prevention wire lock can be passed through the installation point to secure the projector to a desk or pillar.

Installing the wire lock

Pass an anti-theft wire lock through the installation point.

See the documentation supplied with the wire lock for locking instructions.

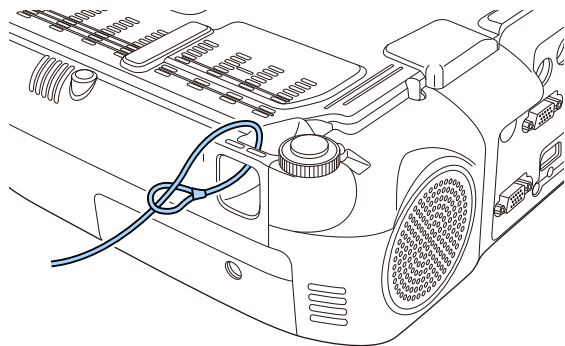

About EasyMP Monitor

EasyMP Monitor lets you carry out operations such as checking the status of multiple Epson projectors that are connected to a network at a computer monitor, and controlling the projectors from the computer.

You can download EasyMP Monitor from the following Web site.

<http://www.epson.com>

The following provides descriptions of the monitoring and control functions that can be carried out using EasyMP Monitor.

- Registering projectors for monitoring and control
- Group registration for registered projectors
- Monitoring the status of registered projectors
- Controlling registered projectors
- Mail Notification settings
- Sending messages to registered projectors

Message Broadcasting

Message Broadcasting is plugin software for EasyMP Monitor. Message Broadcasting can be used to send a message (JPEG file) to project on all Epson projectors or specified projectors connected on the network.

The data can be sent manually, or sent automatically using Timer Settings of EasyMP Monitor.

Download the Message Broadcasting software from the following Web site.

<http://www.epson.com>

Changing Settings Using a Web Browser (Web Control)

By using a Web browser of a computer connected to the projector on a network, you can make settings and control the projector. This function

allows you to perform setup and control operations remotely. In addition, since you can use the computer's keyboard, entering characters required for the setup is easier.

Use Microsoft Internet Explorer 8.0 or later as the Web browser. Use Safari for OS X.



If you set **Standby Mode** to **Communication On**, you can use the Web browser to make settings and perform control even if the projector is in standby mode (when the power is off).

☛ **ECO - Standby Mode** [p.117](#)

Projector setup

In a Web browser, you can set items that are usually set in the projector's Configuration menu. The settings are reflected in the Configuration menu. There are also items that can only be set in the Web browser.

Items in the Configuration menu that cannot be set by the Web browser

- Settings Menu - Pointer Shape
- Settings Menu - Pattern
- Settings Menu - User Button
- Extended Menu - User's Logo
- Extended Menu - Language
- Reset Menu - Reset All and Reset Lamp Hours

The settings for items on each menu are the same as the projector's Configuration menu.

☛ "Configuration Menu" [p.98](#)

Items that can only be set with a Web browser

- SNMP Community Name (up to 32 single-byte alphanumeric characters)
- Monitor Password (up to 16 single-byte alphanumeric characters)

Displaying the Web Control screen

Use the following procedure to display the Web Control screen.

Make sure the computer and projector are connected to the network. When communicating with a wireless LAN, connect in Advanced mode.



If your Web browser is set up to connect via a proxy server, the Web Control screen cannot be displayed. To display Web Control, you need to make settings so that a proxy server is not used for a connection.

- 1** Start a Web browser on the computer.
- 2** Enter the IP address of the projector in the address input box of the Web browser, and press the Enter key on the computer's keyboard.

The Web Control screen is displayed.

When Web Control Password is set from the Configuration menu, the password entry screen is displayed.

- 3** Enter the user ID and password.
Enter "**EPSONWEB**" as the user ID.
The initial password is "**admin**".



- Enter the user ID even if a password has not been set. You cannot change the user ID.
- You can change the password on the Network menu from the Configuration menu.

☞ **Network - Basic - Web Control Password** p.110

Displaying the Web Remote screen

The Web Remote function allows you to perform projector remote control operations with a Web browser.

- 1** Display the Web Control screen.
- 2** Click **Web Remote**.

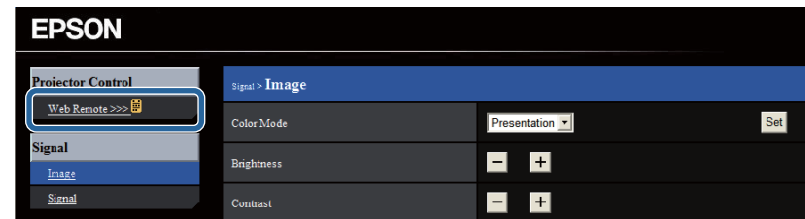

- 3** The Web Remote screen is displayed.

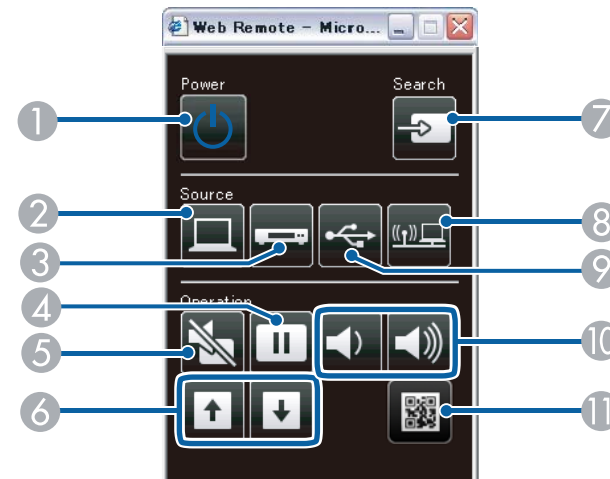

Name		Function
1	[Power] button [⏻]	Turns the projector power on or off. ☞ "Turning On the Projector" p.39

Name	Function
② [Computer] button	Each time you press the button, the input changes between images from the Computer1 port and the Computer2 port.
③ [Video] button	Each time the button is pressed, the image cycles through the Video, S-Video, and HDMI ports.
④ [Freeze] button	Images are paused or unpaused. ☛ "Freezing the Image (Freeze)" p.72
⑤ [A/V Mute] button	Turns the video and audio on or off. ☛ "Hiding the Image and Sound Temporarily (A/V Mute)" p.71
⑥ [Page] buttons [+] [v]	Changes pages in files such as PowerPoint files when using the following projection methods. <ul style="list-style-type: none"> • When using the Wireless Mouse function ☛ "Using the Remote Control to Operate the Mouse Pointer (Wireless Mouse)" p.74 • When using USB Display ☛ "Projecting with USB Display" p.43 • During a network connection When projecting images using PC Free, pressing these buttons displays the previous/next screen.
⑦ [Source Search] button	Changes to the next input source that is sending an image. ☛ "Automatically Detect Input Signals and Change the Projected Image (Source Search)" p.41
⑧ [LAN] button	Switches to the image from the network connected device. ☛ "Switching to the Target Image by Remote Control" p.42
⑨ [USB] button	Each time the button is pressed, it cycles through the following images: <ul style="list-style-type: none"> • USB Display • Images from the device connected to the USB-A port ☛ "Switching to the Target Image by Remote Control" p.42

Name	Function
⑩ [Volume] buttons [<v>] [<v>v]	[<v>] Decreases the volume. [<v>v] Increases the volume. ☛ "Adjusting the Volume" p.53
⑪ [Display the QR Code] button	Displays the QR code.

Using the Mail Notification Function to Report Problems

When you set Mail Notification, notification messages are sent to the preset email addresses when a problem or warning occurs with a projector. This will enable the operator to be notified of problems with projectors even at locations away from the projectors.

☛ **Network - Mail - Mail Notification** p.115



- Up to a maximum of three notification destinations (addresses) can be registered, and notification messages can be sent to all three destinations at once.
- If a projector develops a critical problem and suddenly stops working, it may not be able to send a message notifying an operator of the problem.
- If you set **Standby Mode** to **Communication On**, you can control the projector even if it is in standby mode (when the power is off).
☛ **ECO - Standby Mode** p.117

Reading error notification mail

When the Mail Notification function is set to On and a problem or warning occurs in the projector, the following email will be sent.

Mail sender: Address for Address 1

Subject: EPSON Projector

Line 1: The projector name where the problem has occurred

Line 2: The IP address set for the projector where the problem has occurred.

Line 3 and on: Details of the problem

The details of the problem are listed line by line. The messages are listed below.

- Internal error
- Fan related error
- Sensor error
- Lamp cover is open
- Lamp timer failure
- Lamp out
- Internal temperature error
- High-speed cooling in progress
- Lamp replacement notification
- No-signal
No Signal is input to the projector. Check the connection status or check that the power for the signal source is turned on.
- Auto Iris Error
- Power Err. (Ballast)

See the following to deal with problems or warnings.

☛ "Reading the Indicators" [p.130](#)

Management Using SNMP

By setting **SNMP** to **On** in the Configuration menu, notification messages are sent to the specified computer when a problem or warning occurs. This will enable the operator to be notified of problems with projectors even at locations away from the projectors.

☛ [Network - Others - SNMP p.116](#)



- SNMP should be managed by a network administrator or someone who is familiar with the network.
- To use the SNMP function to monitor the projector, you need to install the SNMP manager program on your computer.
- The SNMP Agent for this projector complies with version 1 (SNMPv1).
- The managing function using SNMP cannot be used via wireless LAN in Quick mode.
- Up to two destination IP addresses can be saved.

ESC/VP21 Commands

You can control the projector from an external device using ESC/VP21.

Command list

When the power ON command is transmitted to the projector, the power turns on and it enters warm-up mode. When the projector's power has turned on, a colon ":" (3Ah) is returned.

When a command is input, the projector executes the command and returns a ":", and then accepts the next command.

If the command being processed terminates abnormally, an error message is output and a ":" is returned.

Item		Command	
Power ON/OFF	On	PWR ON	
	Off	PWR OFF	
Signal selection	Computer1	Auto	SOURCE 1F
		RGB	SOURCE 11
		Component	SOURCE 14
	Computer2	Auto	SOURCE 2F
		RGB	SOURCE 21
		Component	SOURCE 24
	HDMI or HDMI1		SOURCE 30
	HDMI2		SOURCE A0
	Video		SOURCE 41
	S-Video		SOURCE 42
	USB Display		SOURCE 51
USB		SOURCE 52	
LAN		SOURCE 53	
A/V Mute On/Off	On	MUTE ON	
	Off	MUTE OFF	
A/V Mute selection	Black	MSEL 00	
	Blue	MSEL 01	
	Logo	MSEL 02	

Add a Carriage Return (CR) code (0Dh) to the end of each command and transmit.

For more details, contact your local dealer or the nearest address provided in the Epson Projector Contact List.

 [Epson Projector Contact List](#)

Cable layouts

Serial connection

- Connector shape: D-Sub 9-pin (male)
- Projector input port name: RS-232C

<At the projector>

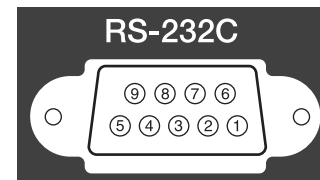

<At the computer>

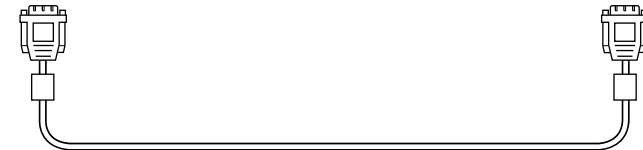
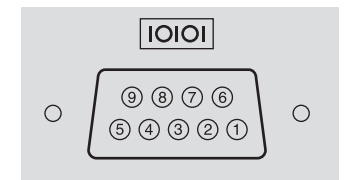

<At the projector>

(PC serial cable)

<At the computer>

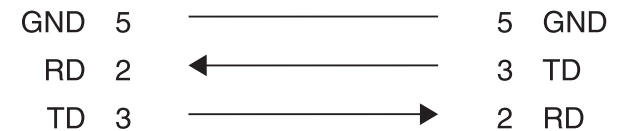

Signal Name	Function
GND	Signal wire ground
TD	Transmit data
RD	Receive data

Communications protocol

- Default baud rate setting: 9600 bps
- Data length: 8 bit

- Parity: None
- Stop-bit: 1 bit
- Flow control: None

About PJLink (Except for EB-S29/EB-S27)

PJLink Class1 was established by the JBMIA (Japan Business Machine and Information System Industries Association) as a standard protocol for controlling network-compatible projector's as part of their efforts to standardize projector control protocols.

The projector complies with the PJLink Class1 standard established by the JBMIA.

See the Network menu for more information on PJLink network settings.

☛ "Network Menu" p.108

It complies with all commands except for the following commands defined by PJLink Class1, and agreement was confirmed by the PJLink standard adaptability verification.

URL: <http://pjlink.jbmia.or.jp/english/>

• Non-compatible commands

Function		PJLink Command
Mute settings	Image muting set	AVMT 11
	Audio muting set	AVMT 21

• Input names defined by PJLink and corresponding projector sources

Source	PJLink Command
Computer1	INPT 11
Computer2	INPT 12

Source	PJLink Command
Video	INPT 21
S-Video	INPT 22
HDMI or HDMI1	INPT 32
HDMI2/MHL (EB-955WH/EB-950WH/EB-965H/ EB-945H/EB-940H/EB-98H/EB-97H only)	INPT 33
USB	INPT 41
LAN	INPT 52
USB Display	INPT 53

- Manufacturer name displayed for "Manufacture name information query"
EPSON
- Model name displayed for "Product name information query"
EPSON 965H
EPSON 955WH
EPSON 945H
EPSON 950WH
EPSON 940H
EPSON 98H
EPSON 97H
EPSON X30
EPSON W29
EPSON X29
EPSON X27
EPSON S29
EPSON S27

About Crestron RoomView® (Except for EB-S29/EB-S27)

Crestron RoomView® is an integrated control system provided by Crestron®. It can be used to monitor and control multiple devices connected on a network.

The projector supports the control protocol, and can therefore be used in a system built with Crestron RoomView®.

Visit the Crestron® Web site for details on Crestron RoomView®.

<http://www.crestron.com>

The following provides an overview of Crestron RoomView®.

- **Remote operation using a Web browser**

You can operate a projector from your computer just like using a remote control.

- **Monitoring and control with application software**

You can use Crestron RoomView® Express or Crestron RoomView® Server Edition provided by Crestron® to monitor devices in the system, to communicate with the help desk, and to send emergency messages. See the following Web site for details.

<http://www.crestron.com/getroomview>

This manual describes how to perform operations on your computer using a Web browser.



- You can only enter single-byte alphanumeric characters and symbols.
- The following functions cannot be used while using Crestron RoomView®.
 - ☛ "Changing Settings Using a Web Browser (Web Control)" [p.87](#)
Message Broadcasting (EasyMP Monitor plug-in)
 - If you set **Standby Mode** to **Communication On**, you can control the projector even if it is in standby mode (when the power is off).
 - ☛ **ECO - Standby Mode** [p.117](#)

Operating a projector from your computer

Displaying the operation window

Check the following before carrying out any operations.

- Make sure the computer and projector are connected to the network. When communicating with a wireless LAN, connect in Advanced mode.
 - ☛ "Wireless LAN menu" [p.111](#)
- Set **Crestron RoomView** to **On** from the **Network** menu.
 - ☛ **Network - Others - Crestron RoomView** [p.116](#)

1

Start a Web browser on the computer.

2

Enter the IP address of the projector in the address field of the Web browser, and press the Enter key on the keyboard.

The operation window is displayed.

Using the operation window

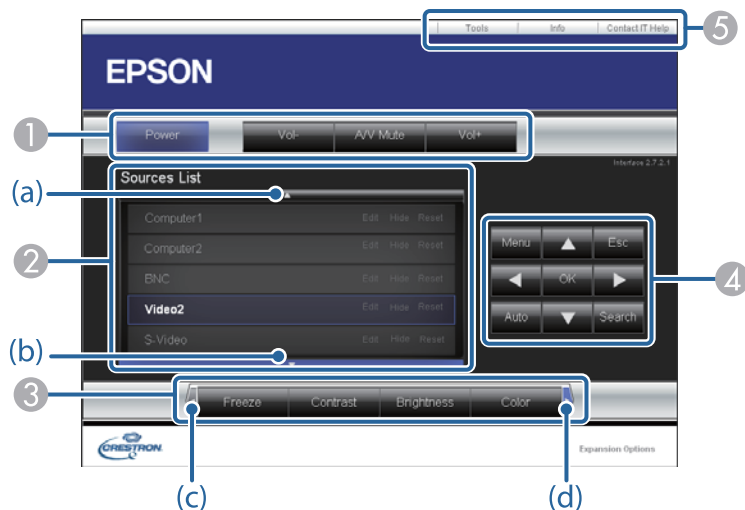

- 1 You can perform the following operations when you click the buttons.



Button	Function
Power	Turns the projector power on or off.
Vol-/Vol+	Adjusts the volume.
A/V Mute	Turns the video and audio on or off. ☛ "Hiding the Image and Sound Temporarily (A/V Mute)" p.71

- 2 Switch to the image from the selected input source. To display input sources that are not shown in Source List, click (a) or (b) to scroll up or down. You can change the source name if necessary.
- 3 You can perform the following operations when you click the buttons. To display buttons that are not shown in Source List, click (c) or (d) to scroll left or right.

Button	Function
Freeze	Images are paused or unpaused. ☛ "Freezing the Image (Freeze)" p.72
Contrast	You can adjust the difference between light and dark in the images.
Brightness	You can adjust the image brightness.
Color	You can adjust the color saturation for the images.
Sharpness	You can adjust the image sharpness.
Zoom	Click the [⊕] button to enlarge the image without changing the projection size. Click the [⊖] button to reduce an image that was enlarged with the [⊕] button. Click the [▲], [▼], [◀], or [▶] buttons to change the position of an enlarged image. ☛ "Enlarging Part of the Image (E-Zoom)" p.73

- 4 The [▲], [▼], [◀], and [▶] buttons perform the same operations as the [⊕], [⊖], [◀], and [▶] buttons on the remote control. You can perform the following operations when you click the other buttons.

Button	Function
OK	Performs the same operation as the [↵] button on the remote control. ☛ "Remote Control" p.18
Menu	Displays and closes the Configuration menu.
Auto	If clicked while projecting analog RGB signals from Computer1 port or Computer2 port, automatically optimizes the image by adjusting the Tracking, Sync., and Position.

Button	Function
Search	Changes to the next input source that is sending an image.  "Automatically Detect Input Signals and Change the Projected Image (Source Search)" p.41
Esc	Performs the same operation as the [Esc] button on the remote control.  "Remote Control" p.18

5 You can perform the following operations when you click the tabs.

Tab	Function
Contact IT Help	Displays the Help Desk window. Used to send messages to, and receive messages from, the administrator using Crestron RoomView® Express.
Info	Displays information on the projector that is currently connected.
Tools	Changes settings in the projector that is currently connected. See the next section.

Using the tools window

The following window is displayed when you click the **Tools** tab on the operation window. You can use this window to change settings in the projector that is currently connected.

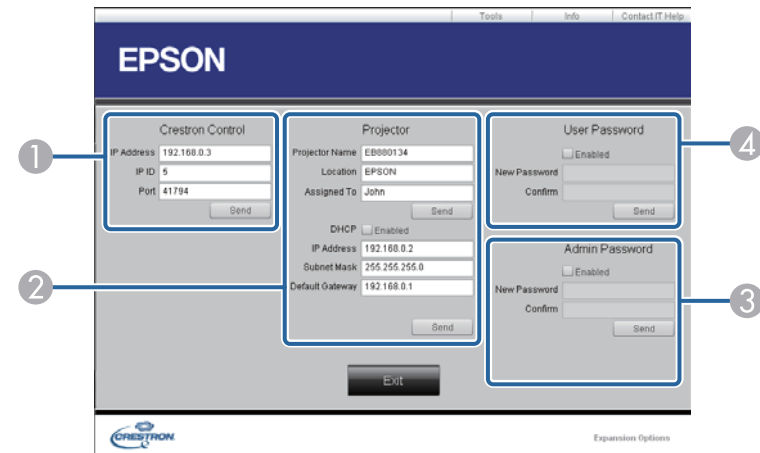

- 1 **Crestron Control**
Make settings for Crestron® central controllers.
- 2 **Projector**
The following items can be set.

Item	Function
Projector Name	Enter a name to differentiate the projector that is currently connected from other projectors on the network. (The name can contain up to 15 single-byte alphanumeric characters.)
Location	Enter an installation location name for the projector that is currently connected on the network. (The name can contain up to 32 single-byte alphanumeric characters and symbols.)
Assigned To	Enter a user name for the projector. (The name can contain up to 32 single-byte alphanumeric characters and symbols.)



Item	Function
DHCP	Select the Enabled check box to use DHCP. You cannot enter an IP address if DHCP is enabled.
IP Address	Enter the IP address to assign to the currently connected projector.
Subnet Mask	Enter a subnet mask for the currently connected projector.
Default Gateway	Enter the gateway address for the currently connected projector.
Send	Click this button to confirm the changes made to the Projector .

Item	Function
New Password	Enter the new password when changing the password to open the operation window. (The name can contain up to 26 single-byte alphanumeric characters.)
Confirm	Enter the same password as you entered in New Password . If the passwords are not the same, an error is displayed.
Send	Click this button to confirm the changes made to the User Password .

3 Admin Password

Select the **Enabled** check box to require a password to open the Tools window. The following items can be set.



Item	Function
New Password	Enter the new password when changing the password to open the Tools window. (The name can contain up to 26 single-byte alphanumeric characters.)
Confirm	Enter the same password as you entered in New Password . If the passwords are not the same, an error is displayed.
Send	Click this button to confirm the changes made to the Admin Password .

4 User Password

Select the **Enabled** check box to require a password to open the operation window on the computer. The following items can be set.

Check the numbers and then apply the following countermeasures. If you cannot resolve the problem, contact your network administrator, or contact your local dealer or the nearest address provided in the Epson Projector Contact List.

 [Epson Projector Contact List](#)

Event ID	Cause	Remedy
0432 0435	Failed to startup EasyMP Network Projection.	Restart the projector.
0434 0481 0482 0485	Network communication is unstable.	Check the network communication status, and reconnect after waiting for a while.
0433	Cannot play transferred images.	Restart EasyMP Network Projection.
0484	Communication was disconnected from the computer.	
0483 04FE	EasyMP Network Projection ended unexpectedly.	Check the network communication status, and then restart the projector.
0479 04FF	A system error occurred in the projector.	Restart the projector.
0891	Cannot find an access point with the same SSID.	Set the computer, the access point, and the projector to the same SSID.
0892	The WPA/WPA2 authentication type does not match.	Check that the wireless LAN security settings are correct.
0893	The TKIP/AES encryption type does not match.	 Security p.113
0894	Communication was disconnected because the projector connected to an unauthorized access point.	Contact your network administrator for more information.
0898	Failed to acquire DHCP.	Check that the DHCP server is operating correctly. If you are not using DHCP, turn off the DHCP setting.  Wireless LAN - IP Settings p.111
0899	Other communication errors	If restarting the projector or EasyMP Network Projection does not solve the problem, contact your local dealer or the nearest address provided in the Epson Projector Contact List.  Epson Projector Contact List



Configuration Menu

This chapter explains how to use the Configuration menu and its functions.

This section explains how to use the Configuration menu.

Although steps are explained using the remote control as an example, you can perform the same operations from the control panel. Check the guide under the menu for the available buttons and their operations.

1 Display the Configuration menu screen.

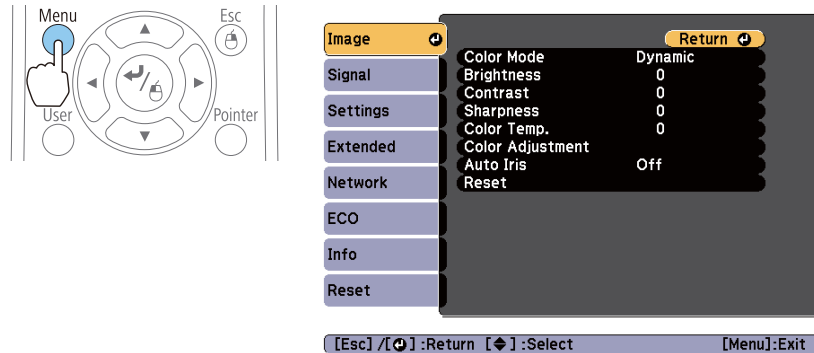

2 Select a top menu item.

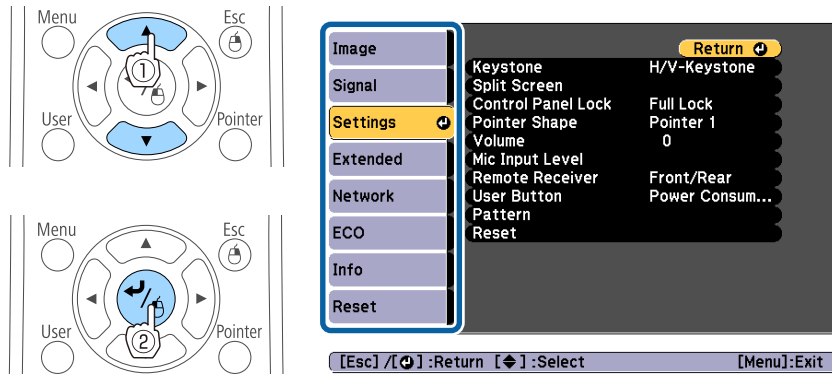

3 Select a submenu item.

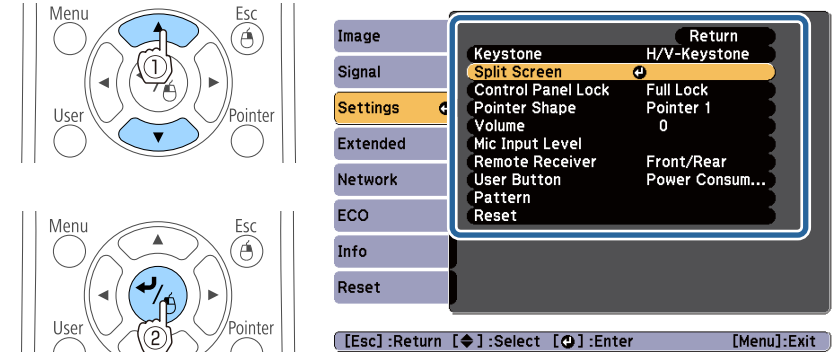

4 Change settings.

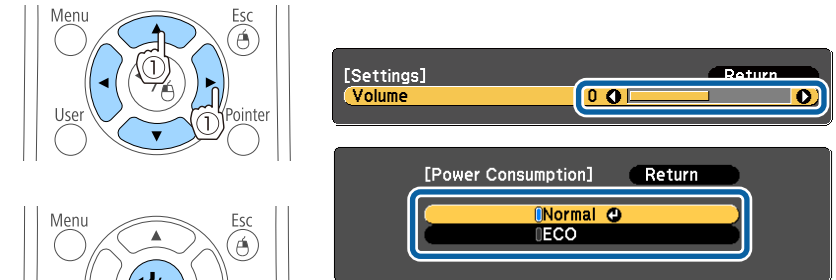



5 Press the [Menu] button to finish making settings.

Configuration Menu Table

Settable items vary depending on the model being used and the image signal and source being projected.

Top Menu Name	Submenu Name	Items or Setting Values
Image menu ☛ p.102	Color Mode	Dynamic, Presentation, Theatre, sRGB, and Blackboard
	Brightness	-24 to 24
	Contrast	-24 to 24
	Color Saturation	-32 to 32
	Tint	-32 to 32
	Sharpness	-5 to 5
	Color Temp.	5000K to 10000K, -3 to 6
	Color Adjustment	Red: -16 to 16 Green: -16 to 16 Blue: -16 to 16
	Auto Iris	Off, Normal, and High Speed
Signal menu ☛ p.103	Auto Setup	On and Off
	Resolution	Auto, Wide, and Normal
	Tracking	-
	Sync.	0 to 31
	Position	Top, Bottom, Left, and Right
	Progressive	Off, Video, and Film/Auto
	Noise Reduction	Off, NR1, and NR2
	HDMI Video Range	Auto, Normal, and Expanded
	Input Signal	Auto, RGB, and Component
Video Signal	Auto, NTSC, NTSC4.43, PAL, M-PAL, N-PAL, PAL60, and SECAM	



Top Menu Name	Submenu Name	Items or Setting Values
	Aspect	Normal, Auto, 4:3, 16:9, Full, Zoom, and Native
	Overscan	Auto, Off, 4%, and 8%
Settings menu ☛ p.105	Keystone	H/V-Keystone and Quick Corner
	Split Screen	-
	Zoom (EB-S29/EB-S27 only)	-
	Control Panel Lock	Full Lock, Partial Lock, and Off
	Pointer Shape	Pointer 1, 2, and 3
	Volume	0 to 20
	Mic Input Level (EB-955WH/ EB-950WH/EB-965H/ EB-945H/EB-940H/ EB-98H/EB-97H only)	0 to 5
	Remote Receiver	Front/Rear, Front, Rear, and Off
	User Button	Power Consumption, Info, Progressive, Test Pattern, Resolution, Pattern Display, Mic Input Level (EB-955WH/EB-950WH/EB-965H/EB-945H/EB-940H/EB-98H/EB-97H only), Display the QR Code, and Flip Horizontal
	Pattern	Pattern Display, Pattern Type, User Pattern, and Test Pattern
Extended menu ☛ p.106	Display	Messages, Display Background, Startup Screen, and A/V Mute
	User's Logo	-
	Projection	Front, Front/Ceiling, Rear, and Rear/Ceiling

Top Menu Name	Submenu Name	Items or Setting Values
	Operation	Direct Power On, High Altitude Mode, Startup Source Search, and Auto Power On
	A/V Settings	A/V Output, Audio Output, HDMI(1) Audio Output, HDMI2 Audio Output (EB-955WH/EB-950WH/EB-965H/EB-945H/EB-940H/EB-98H/EB-97H only), and Plug-in Power (EB-955WH/EB-950WH/EB-965H/EB-945H/EB-940H/EB-98H/EB-97H only)
	Projector ID	Off, or 1 to 9
	Language	15 or 36 languages*1
ECO menu  p.117	Power Consumption	Normal and ECO
	Light Optimizer	On and Off
	Sleep Mode	On and Off
	Sleep Mode Timer	1 to 30
	Lens Cover Timer	On and Off
	A/V Mute Timer	On and Off
	Standby Mode	Communication On and Communication Off
	ECO Display	On and Off
Info menu  p.118	Projector Info	Lamp Hours, Source, Input Signal, Resolution, Video Signal, Refresh Rate, Sync Info, Status, Serial Number, and Event ID
	Version	-
Reset menu  p.119	Reset All	-

Top Menu Name	Submenu Name	Items or Setting Values
	Reset Lamp Hours	-

*1 The number of supported languages differs depending on the region where the projector is used.

Network menu

Top Menu Name	Submenu Name	Setting Values
Basic menu  p.110	Projector Name	-
	PJLink Password (Except for EB-S29/EB-S27)	-
	Web Control Password	-
	Projector Keyword	On and Off
	Display LAN Info.	Text & QR Code and Text
Wireless LAN menu  p.111	Connection Mode	Quick and Advanced
	Channel	1ch, 6ch, 11ch
	SSID Auto Setting	On and Off
	SSID	-
	Search Access Point	-
	IP Settings	DHCP, IP Address, Subnet Mask, and Gateway Address
	SSID Display	On and Off
	IP Address Display	On and Off
Security menu  p.113	Security	No, WPA2-PSK, and WPA/WPA2-PSK
	Passphrase	-
Wired LAN menu (Except for EB-S29/EB-S27)	IP Settings	DHCP, IP Address, Subnet Mask, and Gateway Address





Top Menu Name	Submenu Name	Setting Values
 p.114	IP Address Display	On and Off
Mail menu  p.115	Mail Notification	On and Off
	SMTP Server	-
	Port Number	-
	Address 1 Setting, Address 2 Setting, and Address 3 Setting	-
Others menu  p.116	SNMP	On and Off
	Trap IP Address 1 and Trap IP Address 2	-
	Priority Gateway (Except for EB-S29/EB-S27)	Wired LAN and Wireless LAN
	AMX Device Discovery	On and Off
	Crestron RoomView (Except for EB-S29/EB-S27)	On and Off
	Control4 SDDP	On and Off
	Bonjour	On and Off
	Message Broadcasting	On and Off

Image Menu

Settable items vary depending on the image signal and source currently being projected. Setting details are saved for each image signal.

 "Automatically Detect Input Signals and Change the Projected Image (Source Search)" [p.41](#)

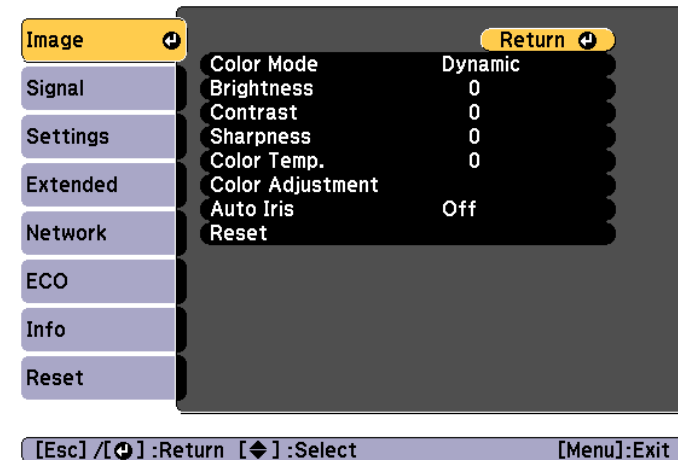

Submenu	Function
Color Mode	You can select the quality of the image to suit your surroundings.  "Selecting the Projection Quality (Selecting Color Mode)" p.53
Brightness	You can adjust the image brightness.
Contrast	You can adjust the difference between light and dark in the images.
Color Saturation	You can adjust the color saturation for the images.
Tint	(Adjustment is possible when a component video signal is being input. If a composite video or S-video signal is input, adjustment is only possible when NTSC signals are being input.) You can adjust the image tint.
Sharpness	You can adjust the image sharpness.

Submenu	Function
Color Temp.	The image is tinted blue when a high value is selected and tinted red when a low value is selected. Content that can be adjusted depends on the Color Mode settings. For sRGB : One of the 10 available values from 5000K to 10000K is set. Otherwise: Adjust from one of the 10 available values from -3 to 6.
Color Adjustment	(This item cannot be selected if Color Mode is set to sRGB.) You can adjust the color strength for Red , Green , and Blue individually.
Auto Iris	(This item can be set only if Color Mode is set to Dynamic or Theatre .) Set to Normal or High Speed to adjust the iris to obtain the optimum light for images being projected. Select High Speed to make faster iris corrections to match the speed of the scene. The setting is stored for each Color Mode. ☛ "Setting Auto Iris" p.54
Reset	You can reset all adjustment values for the Image menu to their default settings. See the following to return all menu items to their default settings. ☛ "Reset Menu" p.119

Signal Menu

Settable items vary depending on the image signal and source currently being projected. Setting details are saved for each image signal.

You cannot make settings on the Signal menu when the source is USB Display, USB, or LAN.

☛ "Automatically Detect Input Signals and Change the Projected Image (Source Search)" [p.41](#)

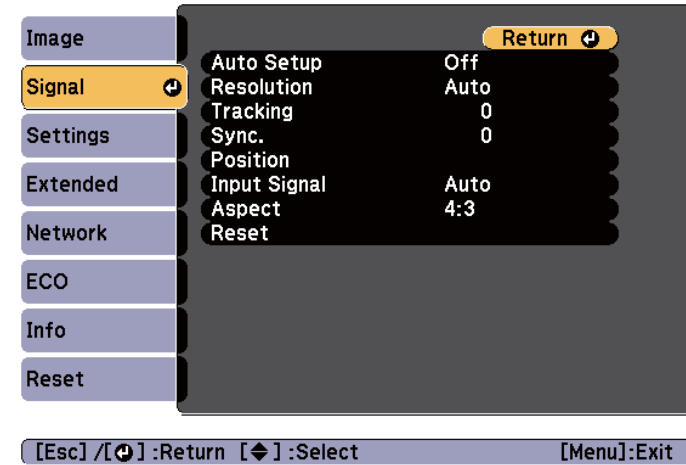

Submenu	Function
Auto Setup	Set to On to automatically adjust Tracking, Sync., and Position to the optimum state when the input signal changes.
Resolution	Set to Auto to automatically identify the resolution of the input signal. If images are not projected correctly when set to Auto , for example if some of the image is missing, adjust to Wide for wide screens, or set to Normal for 4:3 or 5:4 screens depending on the connected computer.
Tracking	You can adjust computer images when vertical stripes appear in the images.
Sync.	You can adjust computer images when flickering, fuzziness, or interference appear in the images.
Position	You can adjust the display position up, down, left, and right when a part of the image is missing so that the whole image is projected.

Submenu	Function
Progressive	<p>(When a component video or RGB video is being input, this setting can only be adjusted if the signal being input is an interlaced signal (480i/576i/1080i). This cannot be set when a digital RGB signal is being input.)</p> <p><u>Interlace</u> (i) signal is converted to <u>Progressive</u> (p). (IP conversion)</p> <p>Off: Ideal for images with a large amount of movement.</p> <p>Video: Ideal for general video images.</p> <p>Film/Auto: This is ideal for movie films, computer graphics, and animation.</p>
Noise Reduction	<p>(This cannot be set when a digital RGB signal is input or when projecting an interlaced signal while Progressive is set to Off.)</p> <p>Smooths out rough images. There are two modes. Select your favorite setting. It is recommended that this is set to Off when viewing image sources in which noise is very low, such as for DVDs.</p>
HDMI Video Range	<p>When the projector's HDMI port is connected to a DVD player, set the projector's video range according to the DVD player's video range setting.</p>
Input Signal	<p>You can select input signal from Computer port.</p> <p>If set to Auto, the input signal is set automatically according to the connected equipment.</p> <p>If colors do not appear correctly when set to Auto, select the appropriate signal according to the connected equipment.</p>
Video Signal	<p>You can select the input signal from the Video port. If set to Auto, video signals are recognized automatically. If interference appears in the image or a problem occurs such as no image is being projected when set to Auto, select the appropriate signal according to the connected equipment.</p>
Aspect	<p>You can set the <u>aspect ratio</u> for projected images.</p> <p>"Changing the Aspect Ratio of the Projected Image" p.55</p>



Submenu	Function
Overscan	<p>Changes the output image ratio (the range of the projected image). You can set the cropping range to Off, 4%, or 8%. When the source is HDMI, Auto is available. When Auto is selected, it automatically changes to Off or 8% according to the input signal.</p>
Reset	<p>You can reset all adjustment values on the Signal menu to their default settings, except for Input Signal.</p> <p>See the following to return all menu items to their default settings.</p> <p>"Reset Menu" p.119</p>

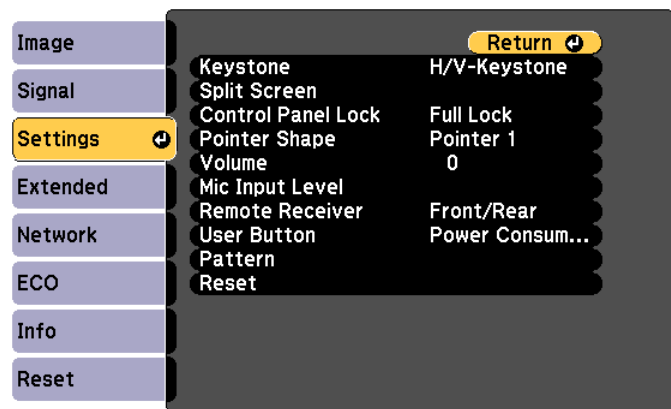



Settings Menu



[Esc] / [⏪] :Return [↵] :Select [Menu] :Exit

Submenu	Function
Keystone	<p>You can correct keystone distortion.</p> <ul style="list-style-type: none"> When H/V-Keystone is selected: Adjust V-Keystone and H-Keystone to correct horizontal and vertical keystone distortion. You can also set H-Keystone Adjuster and Auto V-Keystone to On or Off. When Quick Corner is selected: Select and correct the four corners of the projected image. ☛ "Quick Corner" p.49
Split Screen	<p>Switches to split screen projection.</p> <p>☛ "Projecting Two Images Simultaneously (Split Screen)" p.59</p>
Zoom (EB-S29/EB-S27 only)	<p>Adjusts the size of the projected image.</p>



Submenu	Function
Control Panel Lock	<p>You can use this to restrict operation of the projector's control panel.</p> <p>☛ "Restricting Operation (Control Panel Lock)" p.84</p>
Pointer Shape	<p>You can select the shape of the pointer.</p> <p>Pointer 1: </p> <p>Pointer 2: </p> <p>Pointer 3: </p> <p>☛ "Pointer Function (Pointer)" p.72</p>
Volume	<p>You can adjust the volume. Setting values are saved for each source.</p>
Mic Input Level (EB-955WH/ EB-950WH/ EB-965H/ EB-945H/ EB-940H/ EB-98H/EB-97H only)	<p>Adjust this if the microphone input level is low and the microphone audio output from the projector's speaker is difficult to hear, or if the input level is too high, resulting in a crackling sound in audio from the microphone.</p> <p>When the Mic Input Level is turned down to 0, no audio is output from the speaker.</p>
Remote Receiver	<p>You can limit the reception of the operation signal from the remote control.</p> <p>When set to Off, you cannot perform any operations from the remote control. If you want to make operations from the remote control, hold down the [Menu] button on the remote control for at least 15 seconds to reset the setting to its default value.</p>

Submenu	Function
User Button	<p>You can select and assign an item from the Configuration menu with the remote control's [User] button. Pressing the [User] button directly displays the assigned menu item selection/adjustment screen, allowing you to make one-touch changes to settings/adjustments. You can assign one of the following items to the [User] button.</p> <p>Power Consumption, Info, Progressive, Test Pattern, Resolution, Pattern Display, Mic Input Level (EB-955WH/EB-950WH/EB-965H/EB-945H/EB-940H/EB-98H/EB-97H only), Display the QR Code, and Flip Horizontal</p>
Pattern	<p>Pattern Display: Display a pattern.</p> <p>Pattern Type: You can select from Patterns 1 to 4 or User Pattern. Patterns 1 to 4 display projection lines such as ruled lines or a grid.</p> <div style="display: flex; justify-content: space-around; align-items: flex-start;"> <div style="text-align: center;"> <p>Pattern 1:</p>  </div> <div style="text-align: center;"> <p>Pattern 2:</p>  </div> </div> <div style="display: flex; justify-content: space-around; align-items: flex-start; margin-top: 20px;"> <div style="text-align: center;"> <p>Pattern 3:</p>  </div> <div style="text-align: center;"> <p>Pattern 4:</p>  </div> </div> <p>User Pattern: Captures a user pattern.  "Saving User Pattern" p.80</p> <p>Test Pattern: When the projector is set up, a test pattern is displayed so that you can adjust the projection status without connecting equipment. While the test pattern is displayed, zoom, focus adjustments, and keystone correction can be performed. To cancel the test pattern, press the [Esc] button on the remote control or the control panel.</p> <div style="border: 1px solid black; padding: 10px; margin-top: 10px;"> <p>Attention</p> <p>If a pattern is displayed for a long time, a residual image may be visible in projected images.</p> </div>

Submenu	Function
Reset	<p>You can reset all adjustment values on the Settings menu to their default settings, except for Zoom (EB-S29/EB-S27 only) and User Button.</p> <p>See the following to return all menu items to their default settings.  "Reset Menu" p.119</p>

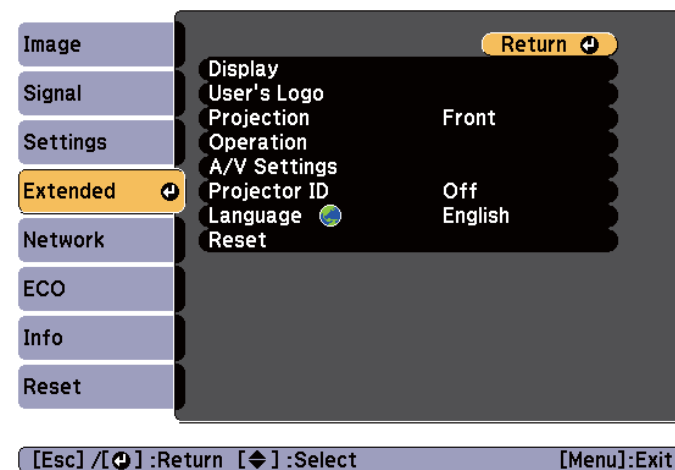
Extended Menu



Submenu	Function
Display	<p>You can make settings related to the projector's display.</p> <p>Messages: When set to Off, the following items will not be displayed.</p> <p>Item names when the Source, Color Mode, or Aspect Ratio is changed, messages when no signal is being input, and warnings such as High Temp Warning.</p> <p>Display Background*1: You can set the screen background to Black, Blue, or Logo when no image signal is available.</p> <p>Startup Screen*1: Set to On to display the User's Logo when projection starts.</p> <p>A/V Mute*1: You can set the screen displayed when the remote control's [A/V Mute] button is pressed to Black, Blue, or Logo.</p>
User's Logo*1	<p>You can change the user's logo that is displayed as a background during Display Background, A/V Mute, and so on.</p> <p> "Saving a User's Logo" p.78</p>
Projection	<p>Select from one of the following projection methods depending on how the projector is installed.</p> <p>Front, Front/Ceiling, Rear, and Rear/Ceiling</p> <p>You can change the setting as follows by pressing down the [A/V Mute] button on the remote control for about five seconds.</p> <p>Front ↔ Front/Ceiling</p> <p>Rear ↔ Rear/Ceiling</p> <p> "Installation Methods" p.24</p>

Submenu	Function
Operation	<p>Direct Power On: Set to On to turn on the projector simply by plugging it in.</p> <p>When the power cord is plugged in, note that the projector turns on automatically in cases such as a power outage being restored.</p> <p>High Altitude Mode: Set to On when using the projector above an altitude of 1500 m.</p> <p>Startup Source Search: Set to On to project images from the port currently receiving an image when the projector starts. Set to Off to project images from the same source as the last time the projector was used.</p> <p>Auto Power On: (Only available when Standby Mode is set to Communication On.) If this is set to Computer1, the projector turns on when signals are received from the Computer1 port, even when the projector is in standby mode.</p>

Submenu	Function
A/V Settings	<p>A/V Output: (This item can be set only if Standby Mode is set to Communication On.)</p> <p>When the projector is in standby status, set to Always On in the following situations.</p> <ul style="list-style-type: none"> • When outputting audio and images to external equipment. • When outputting audio from the projector's speaker. <div style="border: 1px solid black; padding: 5px; margin: 10px 0;">  The fan may rotate in standby status. Also, when the projector wakes from standby status, the fan may make a loud noise as it rotates, but this is not a malfunction. </div> <p>Audio Output: Set the audio input port when projecting images from the Computer1, Computer2, S-Video, Video, and USB-A ports. When set to Audio1, Audio2, or Audio (L/R), audio is output from the selected port regardless of the source.</p> <p>☛ "Connecting Equipment" p.28</p> <p>HDMI(1) Audio Output/HDMI2 Audio Output: Set the input audio when projecting images from the HDMI port. When set to Audio1, Audio2, or Audio (L/R), audio is output from the selected audio input port.</p> <p>Plug-in Power (EB-955WH/EB-950WH/EB-965H/EB-945H/EB-940H/EB-98H/EB-97H only): When set to On, you can use a microphone with Plug-in Power support.</p>
Projector ID	<p>When you want to restrict the target projector for remote control operation, set an ID from 1 to 9 for the projector. Off indicates that no ID is set.</p> <p>☛ "Setting the Projector ID" p.76</p>
Language	You can set the language for messages and menus.

Submenu	Function
Reset	<p>You can reset the adjustment values for Display*1, Operation*2, and A/V Settings*3 from the Extended menu to their default settings.</p> <p>See the following to return all menu items to their default settings.</p> <p>☛ "Reset Menu" p.119</p>

*1 When **User's Logo Protection** is set to **On** in **Password Protection**, settings related to user's logo cannot be changed. You can make changes after setting **User's Logo Protection** to **Off**.

☛ "Managing Users (Password Protection)" [p.82](#)

*2 Except for High Altitude Mode and Startup Source Search.

*3 Except for A/V Output.

Network Menu

When **Network Protection** is set to **On** in **Password Protection**, a message is displayed and the network settings cannot be changed. Set **Network Protection** to **Off** and then configure the network.

☛ "Setting Password Protection" [p.82](#)

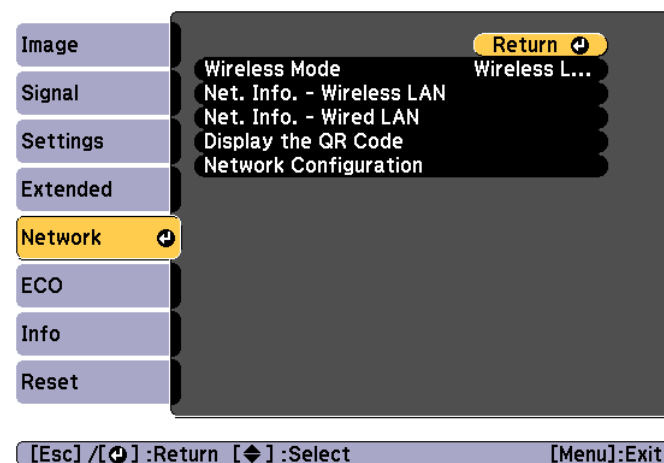

Submenu	Function
Wireless Mode	Set to Wireless LAN On when connecting the projector to the computer over wireless LAN. If you do not want to connect via wireless LAN, turn it Off to prevent unauthorized access by others. The default value is Wireless LAN On .
Net. Info. - Wireless LAN	Displays the following network setting status information. <ul style="list-style-type: none"> • Connection Mode • Wireless LAN Sys. • Antenna Level • Projector Name • SSID • DHCP • IP Address • Subnet Mask • Gateway Address • MAC Address • Region Code*
Net. Info. - Wired LAN (Except for EB-S29/EB-S27)	Displays the following network setting status information. <ul style="list-style-type: none"> • Projector Name • DHCP • IP Address • Subnet Mask • Gateway Address • MAC Address
Display the QR Code	Displays the QR code.
Network Configuration	The following menus are available for setting Network items. Basic, Wireless LAN, Security, Wired LAN, Mail, Others, Reset, and Complete

* Displays available region information for the Wireless LAN unit being used. For more details, contact your local dealer or the nearest address provided in the Epson Projector Contact List.

 [Epson Projector Contact List](#)



- By using a Web browser of a computer connected to the projector on a network, you can set functions and control the projector. This function is called Web Control. You can easily enter text using a keyboard to make settings for Web Control such as Security settings.
 -  "Changing Settings Using a Web Browser (Web Control)" [p.87](#)
- Contact your network administrator for details on network settings.

Notes on operating the Network menu

Selecting from the top menu and sub menus, and changing selected items is the same as making operations from the Configuration menu.

When done, make sure you go to the **Complete** menu, and select **Yes**, **No**, or **Cancel**. When you select **Yes** or **No**, you are returned to the Configuration menu.

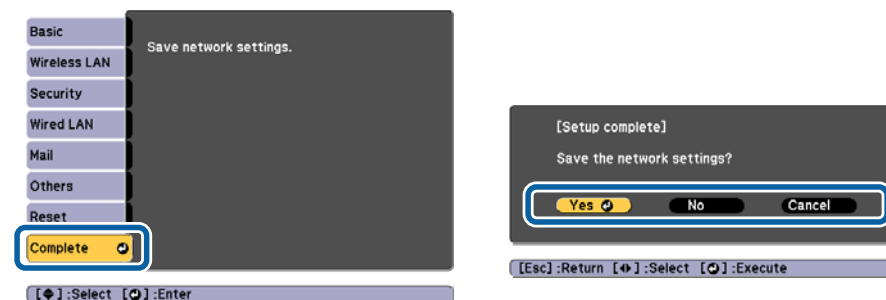

Yes: Saves the settings and exits the Network menu.

No: Does not save the settings and exits the Network menu.

Cancel: Continues displaying the Network menu.

Soft keyboard operations

The Network menu contains items that require input of alphanumeric characters during setup. In this case, the following software keyboard is displayed.

Press the [Home][Back][Power] buttons on the remote control or the [Home][Back] buttons (or the [Wide][Tele]) on the control panel. Use the buttons to move the cursor to the desired key, and then press the [Enter] button. Enter figures by holding down the [Num] button on the remote control, and pressing the numeric buttons. After inputting, press **Finish** on the keyboard to confirm your input. Press **Cancel** on the keyboard to cancel your input.

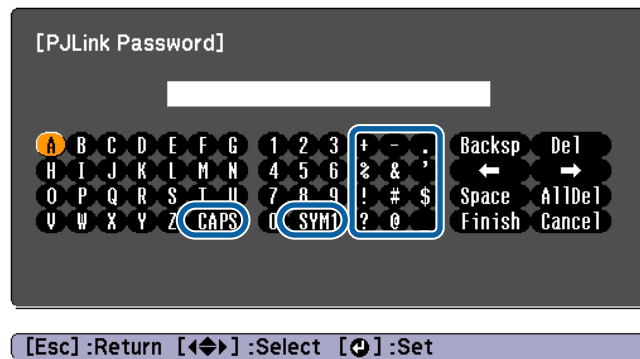

- Each time the **CAPS** key is selected and the [Enter] button is pressed, it sets and changes between upper case and lower case letters.
- Each time the **SYM1/2** key is selected and the [Enter] button is pressed, it sets and changes the symbol keys for the section enclosed by the frame. The following text can be entered.

Numbers	0123456789
Alphabet	ABCDEFGHIJKLMNOPQRSTUVWXYZ abcdefghijklmnopqrstuvwxyz
Symbols	! # \$ % & ' () + - . / < = > ? @ ^ _ ` { } ~



- Except for the **SSID**, colons and spaces cannot be entered on the Network menu.
- Some symbols (" * , ; [\]) cannot be entered using the software keyboard. Use your Web browser to enter the text.
- "Changing Settings Using a Web Browser (Web Control)" [p.87](#)

Basic menu

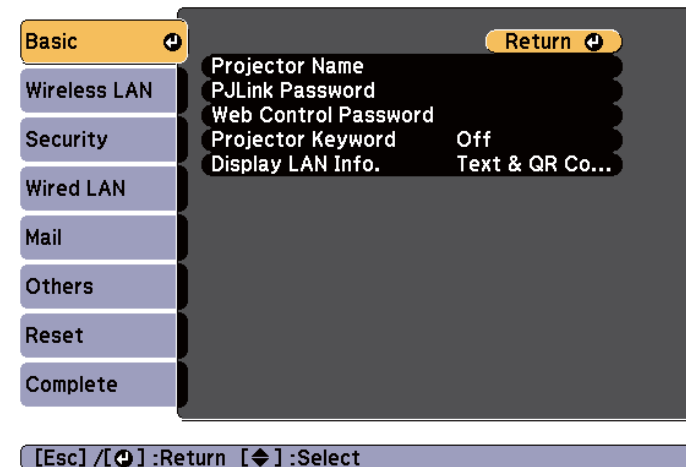

Submenu	Function
Projector Name	Displays the projector name used to identify the projector when connected to a network. When editing, you can enter up to 16 single-byte alphanumeric characters. The following characters cannot be used: " * + , / ; < = > ? [\] `
PJLink Password (Except for EB-S29/ EB-S27)	Set a password to use when you access the projector using compatible PJLink software. You can enter up to 32 single-byte alphanumeric characters.

Submenu	Function
Web Control Password	<p>Set a password to use when making settings and controlling the projector using Web Control. You can enter up to eight single-byte alphanumeric characters (* cannot be used). Web Control is a computer function that allows you to set up and control the projector by using the Web browser on a computer connected on a network.</p> <p>☛ "Changing Settings Using a Web Browser (Web Control)" p.87</p>
Projector Keyword	<p>When set to On, you have to enter the keyword when you try to connect the projector to a computer via a network. As a result, you can prevent presentations from being interrupted by connections from other computers. Normally this should be set to On.</p> <p>☛ EasyMP Network Projection Operation Guide</p> <p>☛ EasyMP Multi PC Projection Operation Guide</p>
Display LAN Info.	<p>Set the display format for the projector's network information. When a QR code is displayed, you can connect to the network by simply reading the QR code in Epson iProjection. The default value is Text & QR Code.</p> <p>☛ "Projecting Using a QR Code" p.69</p>

Wireless LAN menu

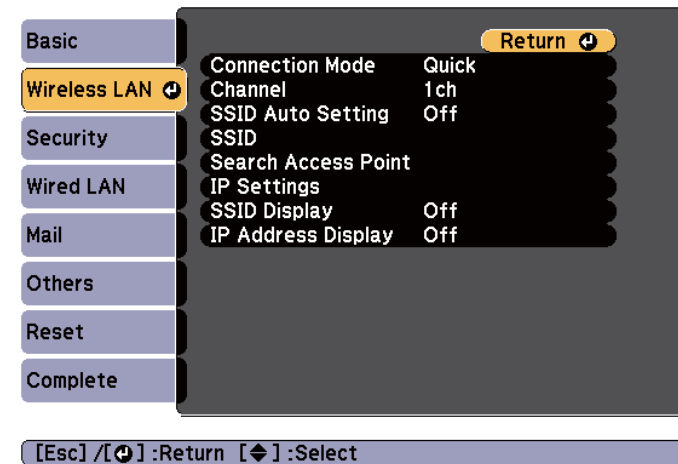

Submenu	Function
Connection Mode	<p>Set the connection mode to use when connecting the projector and a computer via a wireless LAN.</p> <p>If you select Quick, a small network is created automatically by the projector and computer. It is used with EasyMP Network Projection. If SSID Auto Setting is set to On, the projector becomes an easy access point; if it is set to Off, the network is created in Ad hoc mode.</p> <p>If you select Advanced, the connection is established in Infrastructure mode.</p>
Channel	<p>(This can only be set if Connection Mode is set to Quick.)</p> <p>Select the frequency band used by the wireless LAN from 1ch, 6ch, or 11ch.</p> <p>The default value is 11ch.</p>



Submenu	Function
SSID Auto Setting	(This can only be set if Connection Mode is set to Quick .) When you set this to On , you can search for the projector more quickly from among multiple projectors. SSID is set automatically. When connecting to multiple projectors from one computer in Quick mode, set this to Off , and set the same SSID in all the projectors that will connect.
SSID	(This item can only be set when SSID Auto Setting is set to Off .) Enter an <u>SSID</u> . When an SSID is provided for the wireless LAN system in which the projector participates, enter the SSID. You can enter up to 32 single-byte alphanumeric characters (^ can only be entered from the Web browser). If the SSID is left blank or set to ANY, an ANY connection (selects a connection from local access points without specifying an SSID) is established.
Search Access Point	(This item can be set only if Wireless Mode is set to Wireless LAN On , and Connection Mode is set to Advanced .) The projector searches for a local access point. This allows you to perform wireless LAN setup by simply selecting the connection location of the wireless LAN.

Submenu	Function
IP Settings	(This item can only be set if Connection Mode is set to Advanced .) You can make network settings. DHCP : Set to On to make network settings using <u>DHCP</u> . If this is set to On , you cannot set any more addresses. IP Address : You can input the <u>IP address</u> assigned to the projector. You can enter a number from 0 to 255 in each field of the address. However, the following IP addresses cannot be used. 0.0.0.0, 127.x.x.x, 224.0.0.0 to 255.255.255.255 (where x is a number from 0 to 255) Subnet Mask : You can input the <u>subnet mask</u> for the projector. You can enter a number from 0 to 255 in each field of the address. However, the following subnet masks cannot be used. 0.0.0.0, 255.255.255.255 Gateway Address : You can input the IP address for the gateway for the projector. You can enter a number from 0 to 255 in each field of the address. However, the following <u>Gateway addresses</u> cannot be used. 0.0.0.0, 127.x.x.x, 224.0.0.0 to 255.255.255.255 (where x is a number from 0 to 255)
SSID Display	To prevent the <u>SSID</u> from being displayed on the LAN Standby screen, set this to Off .
IP Address Display	To prevent the <u>IP address</u> from being displayed on the LAN Standby screen, set this to Off .

Search Access Point screen

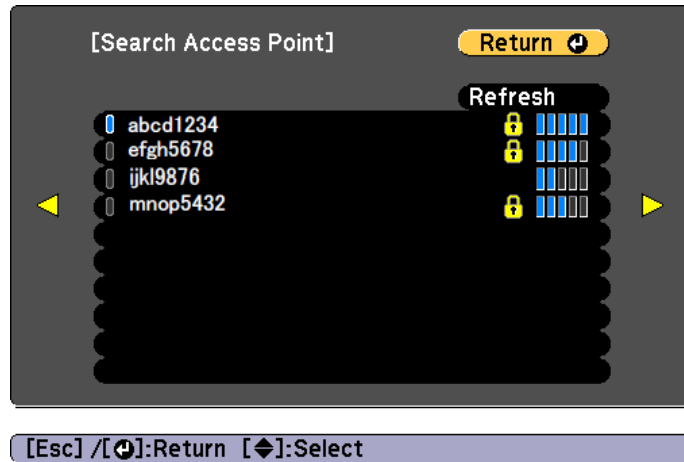
Detected access points are displayed in a list. The application can detect up to 30 access points.



Submenu	Function
Refresh	Searches for the access point again.
	Indicates an already set access point.
	Indicates the access points where security is set. If you select an access point where security has not been set, the Wireless LAN menu is displayed. If you select an access point where security has been set, the Security menu is displayed. Select a type of security according to the security settings for the access point.

Security menu

Available when the Wireless LAN unit is installed.

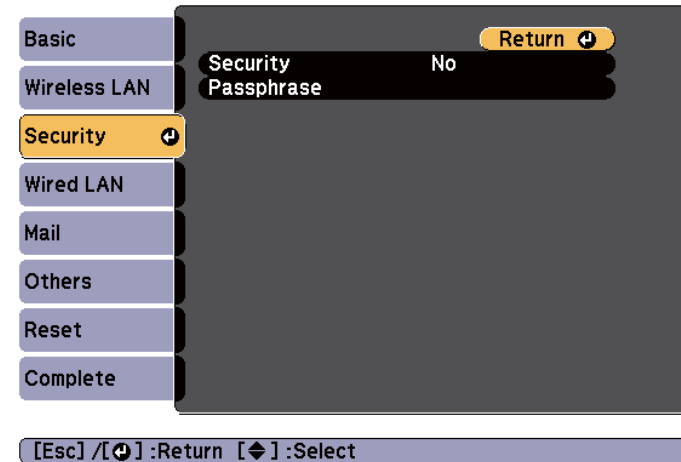

Submenu	Function
Security	Select the security type from the items that are displayed. When setting up Security, follow the instructions from the administrator of the network system you are about to access.

Submenu	Function
Passphrase	<p>Enter the passphrase. You can enter at least 8 and up to 63 single-byte alphanumeric characters (colons and spaces cannot be used).</p> <p>When using it with EasyMP Network Projection, you do not need to input the passphrase in the computer if it is the initial (default) passphrase.</p> <p>In the interests of security, we recommended that you change the passphrase periodically. If the network settings are initialized, it returns to the initial passphrase.</p> <p>☛ "Reset menu" p.117</p> <p>You can enter up to 32 characters on the Configuration menu. When entering more than 32 characters, use your Web browser to enter the text.</p> <p>☛ "Changing Settings Using a Web Browser (Web Control)" p.87</p> <p>In Quick mode, the initial passphrase is set.</p>

Type of security

When the Wireless LAN unit is installed and you are using Advanced, it is strongly recommended that you set security.

WPA is an encryption standard that improves the security for wireless networks. The projector supports TKIP and AES encryption methods.

WPA also includes user authentication functions. WPA authentication provides two methods: using an authentication server, or authenticating between a computer and an access point without using a server. This projector supports the latter method, without a server.



For setting details, follow the directions from the network administrator of your network.

Wired LAN menu (except for EB-S29/EB-S27)

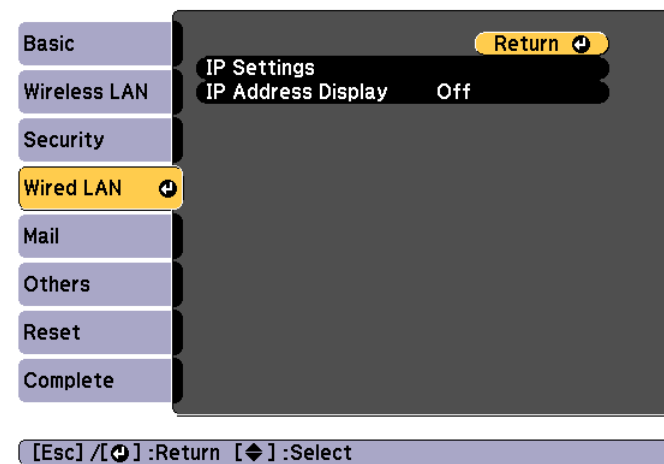

Submenu	Function
IP Settings	<p>You can make settings related to the following addresses.</p> <p>DHCP ▶▶: Set to On to configure the network using DHCP. If this is set to On, you cannot set any more addresses.</p> <p>IP Address ▶▶: You can input the IP address assigned to the projector. You can input a number from 0 to 255 in each field of the address. However, the following IP addresses cannot be used. 0.0.0.0, 127.x.x.x, 224.0.0.0 to 255.255.255.255 (where x is a number from 0 to 255)</p> <p>Subnet Mask ▶▶: You can input the subnet mask for the projector. You can input a number from 0 to 255 in each field of the address. However, the following subnet masks cannot be used. 0.0.0.0, 255.255.255.255</p> <p>Gateway Address ▶▶: You can input the IP address for the gateway for the projector. You can input a number from 0 to 255 in each field of the address. However, the following gateway addresses cannot be used. 0.0.0.0, 127.x.x.x, 224.0.0.0 to 255.255.255.255 (where x is a number from 0 to 255)</p>

Submenu	Function
IP Address Display	To prevent the IP address from being displayed on Network Info in the Network Menu and on the LAN Standby screen, set this to Off .

Mail menu

When this is set, you receive an email notification if a problem or warning occurs in the projector.

☛ "Using the Mail Notification Function to Report Problems" p.89

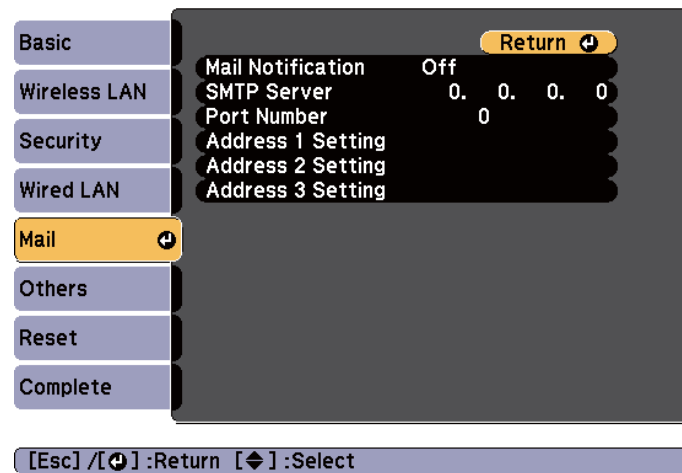

Submenu	Function
Mail Notification	Set to On to send an email to the preset addresses when a problem or warning occurs with a projector.
SMTP Server	You can input the <u>IP address</u> for the SMTP server for the projector. You can enter a number from 0 to 255 in each field of the address. However, the following IP addresses cannot be used. 127.x.x.x, 224.0.0.0 to 255.255.255.255 (where x is a number from 0 to 255)

Submenu	Function
Port Number	You can input the port number for the SMTP server. The default value is 25. You can input numbers between 1 to 65535.
Address 1 Setting/Address 2 Setting/Address 3 Setting	You can input the email address of the destination to send the notification email to. You can register up to three destinations. You can enter up to 32 single-byte alphanumeric characters for the email address. The following characters cannot be used: " () , ; < > [\] You can select the problems or warnings to be notified about by email. When the selected problem or warning occurs in the projector, an email is sent to the specified destination address notifying that a problem or warning has occurred. You can select multiple items from the displayed items.

Others menu

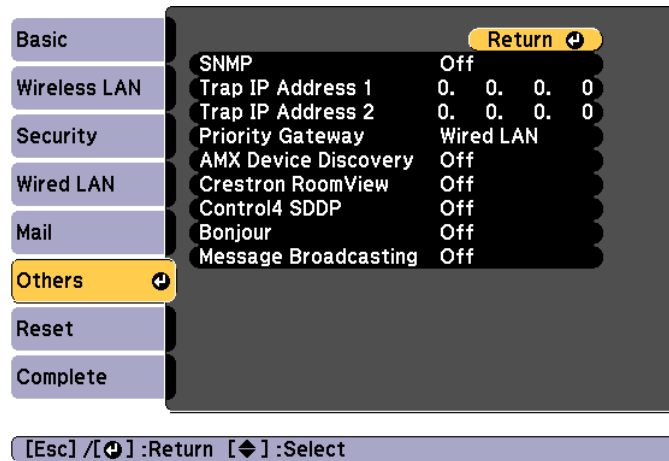

Submenu	Function
SNMP	Set to On to monitor the projector using SNMP. To monitor the projector, you need to install the SNMP manager program on your computer. SNMP should be managed by a network administrator. The default value is Off .
Trap IP Address 1/Trap IP Address 2	You can register up to two IP addresses for the SNMP trap notification destination. You can enter a number from 0 to 255 in each field of the address. However, the following IP addresses cannot be used. 127.x.x.x, 224.0.0.0 to 255.255.255.255 (where x is a number from 0 to 255)
Priority Gateway (Except for EB-S29/EB-S27)	You can set the priority gateway to a Wired LAN or Wireless LAN .
AMX Device Discovery	When the projector is connected to a network, set this to On to allow the projector to be detected by <u>AMX Device Discovery</u> . Set this to Off if you are not connected to an environment controlled with a controller from AMX or AMX Device Discovery.

Submenu	Function
Crestron Room View (Except for EB-S29/EB-S27)	Set this to On only when monitoring or controlling the projector over the network using Crestron RoomView®. Otherwise, set this to Off . ☛ "About Crestron RoomView® (Except for EB-S29/EB-S27)" p.93 When this is set to On , the following functions are not available. <ul style="list-style-type: none"> • Web control • Message Broadcasting (EasyMP Monitor plugin)
Control4 SDDP	Set this to On to allow device information to be acquired using <u>Control4® Simple Device Discovery Protocol (SDDP)</u> .
Bonjour	Set this to On when connecting to the network using Bonjour. See Apple's Web site for more information on the Bonjour service. ☛ http://www.apple.com/
Message Broadcasting	You can switch the EPSON Message Broadcasting function to enable or disable.

Reset menu

Resets all of the network settings.

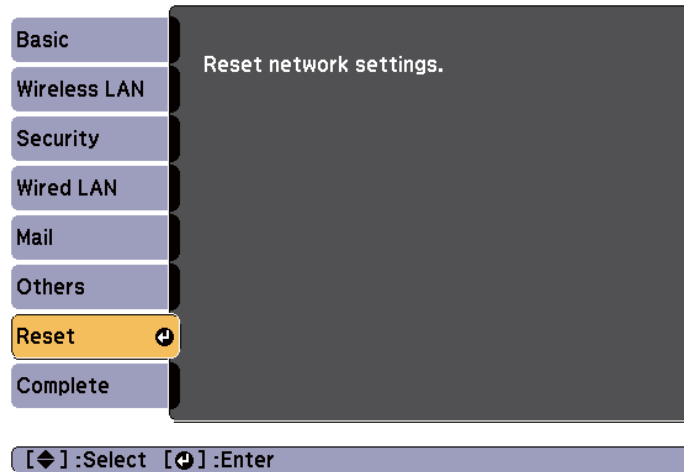

Submenu	Function
Reset network settings.	To reset all of the Network settings, select Yes .

ECO Menu

When you make ECO menu settings, the projector performs functions to save power. When power saving settings have been enabled, a leaf icon is displayed next to each submenu.

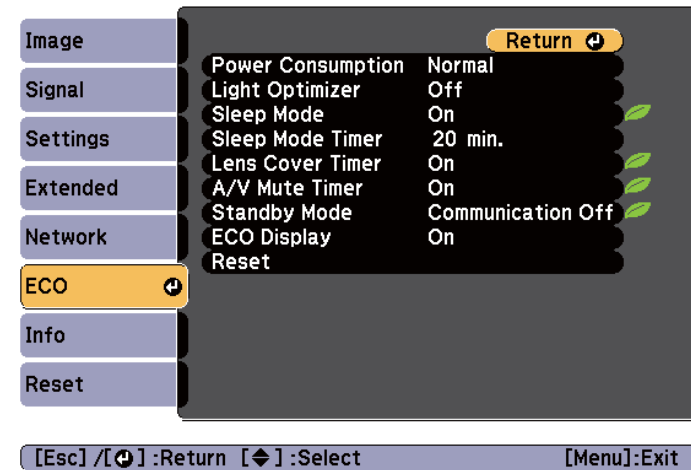

Submenu	Function
Power Consumption	You can set the lamp brightness to one of two settings. Select ECO if the images being projected are too bright, such as when projecting images in a dark room or onto a small screen. When ECO is selected, power consumption during projection decreases, and fan rotation noise is reduced. When using at high altitude or in locations subject to high temperatures, you may not be able to change settings.
Light Optimizer	(This item can only be set when Power Consumption is set to Normal and Auto Iris is set to Off .) When set to On , the lamp brightness is adjusted according to the image being projected. This helps to reduce the amount of electricity being used by lowering the lamp's brightness according to the scene being projected. The setting is stored for each Color Mode.

Submenu	Function
Sleep Mode	When set to On , this automatically stops projection when no image signal is being input and no operations are carried out for a specified length of time. Also, if no image signal is input for approximately five minutes, the lamp dims until the power turns off. When an image signal is input, the projector returns to normal operating status.
Sleep Mode Timer	When Sleep Mode is set to On , you can set the time before the projector automatically turns off within a range of 1 to 30 minutes.
Lens Cover Timer	When set to On , this turns off the power automatically 30 minutes after the A/V mute slide is closed. Also, if the A/V mute slide is closed for approximately five minutes, the lamp dims until the power turns off. When the A/V mute slide is opened, the projector returns to normal operating status.
A/V Mute Timer	When set to On , this turns off the power automatically 30 minutes after A/V mute is enabled. Also, if A/V mute is enabled, the lamp dims until the power turns off. When A/V mute is disabled, the projector returns to normal operating status.
Standby Mode	If you set Communication On , you can perform the following operations even if the projector is in standby mode. <ul style="list-style-type: none"> • Monitoring and controlling the projector over a network. • Outputting audio and images to external equipment. (Only when A/V Output is set to Always On.) • Outputting audio from the projector's speaker. (Only when A/V Output is set to Always On.)
ECO Display	When set to On , when the lamp brightness changes from normal to low or low to normal, leaf icons are displayed at the bottom-left of the projected screen to indicate the power-saving status.
Reset	You can reset all adjustment values on the ECO menu to their default settings, except for Standby Mode . See the following to return all menu items to their default settings. <ul style="list-style-type: none"> • "Reset Menu" p.119

Info Menu (Display Only)

Lets you check the status of the image signals being projected and the status of the projector. Items that can be displayed vary depending on the source currently being projected. Depending on the model used, some input sources are not supported.

☛ "Automatically Detect Input Signals and Change the Projected Image (Source Search)" [p.41](#)

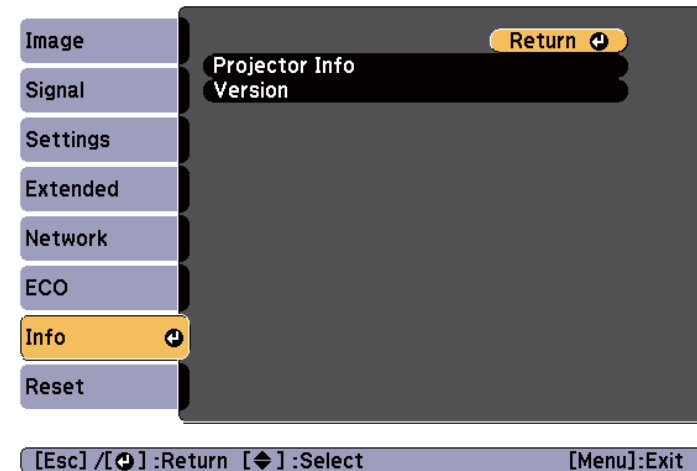

Submenu	Function
Projector Info	<ul style="list-style-type: none"> • Lamp Hours: Displays the cumulative lamp operating time*. When it reaches the lamp warning time, the characters are displayed in yellow. • Source: Displays the source name for the connected equipment currently being projected. • Input Signal: Displays the setting for Input Signal in the Signal menu according to the source. • Resolution: Displays the resolution. • Video Signal: Displays the settings for Video Signal in the Signal menu. • Refresh Rate: Displays the <u>refresh rate</u>▶▶. • Sync Info: Displays the image signal information. This information may be needed if service is required. • Status: Displays the information about errors that have occurred in the projector. This information may be needed if service is required. • Serial Number: Displays the projector's serial number. • Event ID: Displays the problems occurred in the projector using the Event IDs, when the projector and the computer are connected through the network. See the following page for the detailed information on the Event ID.  "About Event ID" p.97
Version	Displays the projector's software version information.

* The cumulative use time is displayed as "0H" for the first 10 hours. 10 hours and above is displayed as "10H", "11H", and so on.

Reset Menu

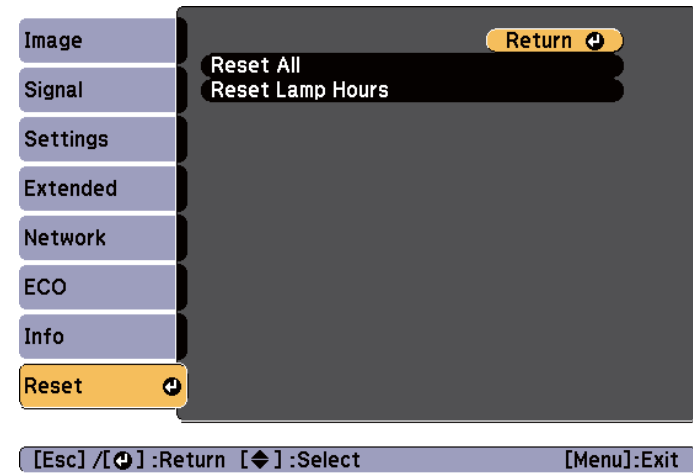

Submenu	Function
Reset All	<p>You can reset all items in the Configuration menu to their default settings.</p> <p>The following items are not reset to their defaults: Input Signal, User's Logo, Lamp Hours, Language, Password, Zoom (EB-S29/EB-S27 only), and all items on the Network menu.</p>
Reset Lamp Hours	Clears the cumulative lamp hours use time. Reset when you replace the lamp.

Once the Configuration menu content has been set for one projector, you can use it to perform batch setup for multiple projectors (batch setup function). The batch setup function is only for projectors with the same model number.

Use one of the following methods.

- Setup using a USB memory.
- Setup by connecting the computer and projector with a USB cable.

This manual explains the USB storage device and the USB cable methods.



- The following content is not reflected by the batch setup function.
 - Settings in the Network menu (except for the Mail menu and the Others menu)
 - Lamp Hours and Status from the Info menu
- Perform batch setup before adjusting the projected image. Adjustment values for the projected image, such as H/V-Keystone correction, are reflected by the batch setup function. If batch setup is performed after adjusting the projected image, the adjustments you made may change.
- By using the batch setup function, the registered User's Logo is set for the other projectors. Do not register confidential information and so on as the User's Logo.



Caution

Performing batch setup is the customer's responsibility. If batch setup fails due to a power failure, communication error, and so on, the customer is responsible for any repair costs incurred.

Setting Up Using a USB Storage Device

This section explains how to perform batch setup using a USB storage device.



- Use a FAT format USB storage device.
- The batch setup function cannot be used by USB storage devices that incorporate security functions. Use a USB storage device that does not incorporate security functions.
- The batch setup function cannot be used by USB card readers or USB hard disks.

Saving settings to the USB storage device

- 1** Disconnect the power cord from the projector, and check that all of the projector's indicators have turned off.
- 2** Connect the USB storage device to the projector's USB-A port.

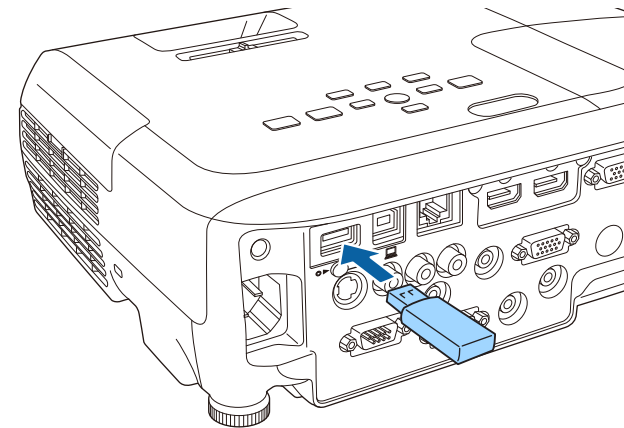



- Connect the USB storage device directly to the projector. If the USB storage device is connected to the projector through a USB hub, the settings may not be saved correctly.
- Connect an empty USB storage device. If the USB storage device contains data other than the batch setup file, the settings may not be saved correctly.
- If you have saved a batch setup file from another projector to the USB storage device, delete the file or change the file name. The batch setup function cannot overwrite a batch setup file.
- The file name for the batch setup file is PJCONFDATA.bin. If you need to change the file name, add text after PJCONFDATA. If you change the file name in any other way, the projector may not be able to recognize the file correctly.
- You can only use single-byte characters for the file name.

- 3** While holding down the [Esc] button, connect the power cord to the projector.

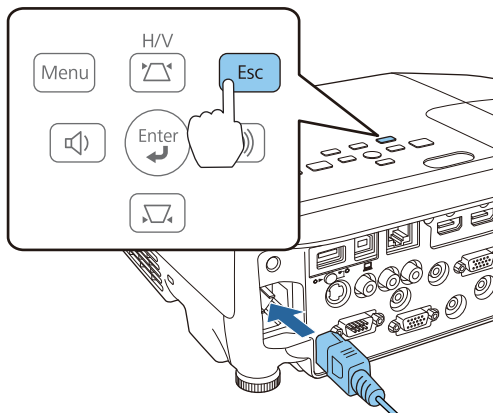

When the projector's indicators turn on as follows, release the [Esc] button.

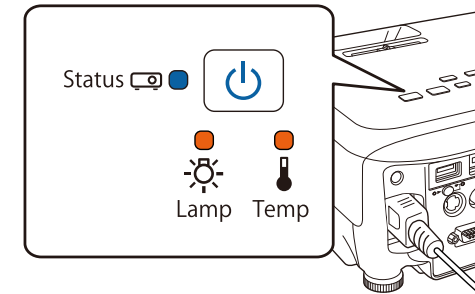

Power: Blue - On/Status: Blue - On/Lamp: Orange - On/Temp: Orange - On

When all of the indicators start flashing, the batch setup file is being written.

Caution

- Do not disconnect the power cord from the projector while the file is being written. If the power cord is disconnected, the projector may not start correctly.
- Do not disconnect the USB storage device from the projector while the file is being written. If the USB storage device is disconnected, the projector may not start correctly.

When writing completes normally, the projector enters standby status.

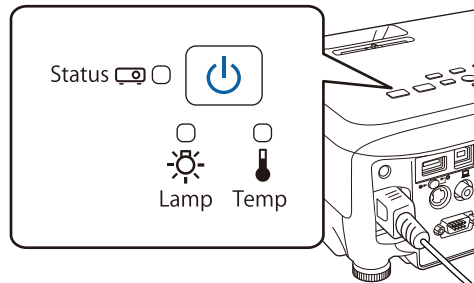

Power: Blue - On

When the projector is in standby status, remove the USB storage device.

Reflecting saved settings to other projectors

- 1** Disconnect the power cord from the projector, and check that all of the projector's indicators have turned off.
- 2** Connect the USB storage device containing the saved batch setup file to the projector's USB-A port.

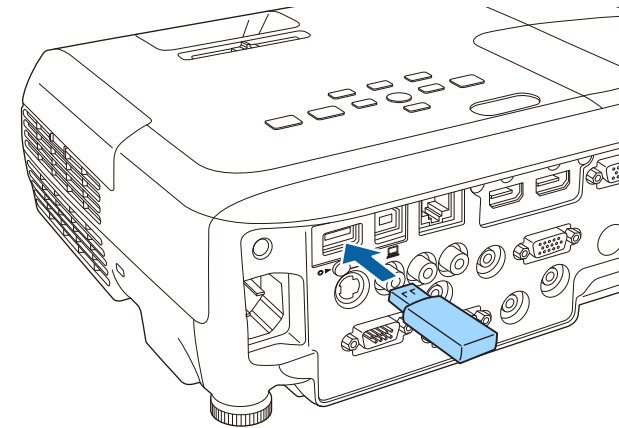

- When the USB storage device contains 1 to 3 types of batch setup files, the file is reflected to the projector with the same model number. If there are multiple files for a projector with the same model number, the settings may not be reflected correctly.
- When there are four or more types of batch setup files on the USB storage device, the settings may not be reflected correctly.
- Do not store any data except for the batch setup file on the USB storage device. If the USB storage device contains data other than the batch setup file, the settings may not be reflected correctly.

- 3** While holding down the [Menu] button, connect the power cord to the projector.

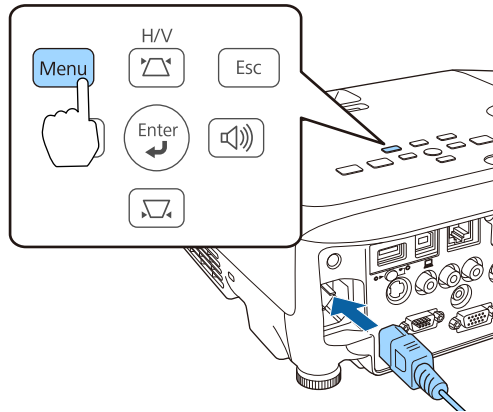

When the projector's indicators turn on as follows, release the [Menu] button.

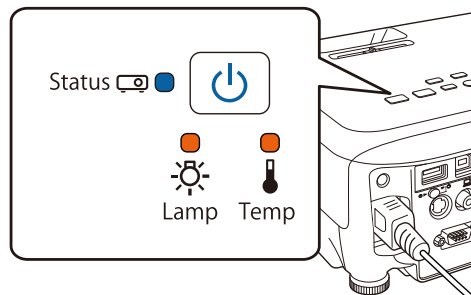

Power: Blue - On/Status: Blue - On/Lamp: Orange - On/Temp: Orange - On

The indicators remain on for about 75 seconds.

When all of the indicators start flashing, the settings are being written.

Caution

- Do not disconnect the power cord from the projector while the settings are being written. If the power cord is disconnected, the projector may not start correctly.
- Do not disconnect the USB storage device from the projector while the settings are being written. If the USB storage device is disconnected, the projector may not start correctly.

- 4** When writing completes normally, the projector enters standby status.

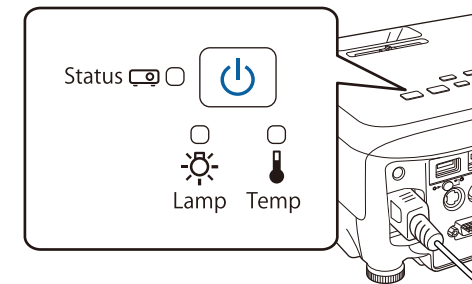

Power: Blue - On

When the projector is in standby status, remove the USB storage device.

Setup by Connecting the Computer and Projector with a USB Cable



The following operating systems support the batch setup function.

- Windows Vista or later
- Mac OS X 10.5.3 or later

Saving settings to a computer

- 1 Disconnect the power cord from the projector, and check that all of the projector's indicators have turned off.
- 2 Connect the computer's USB port to the projector's USB-B port with a USB cable.

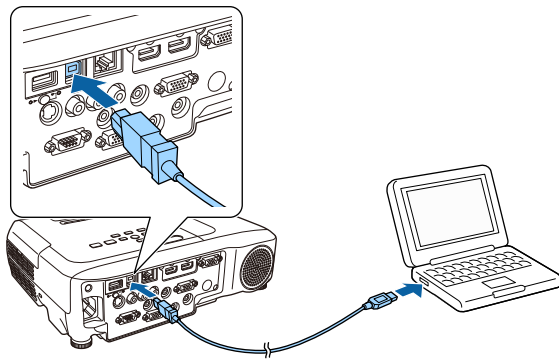

- 3 While holding down the [Esc] button, connect the power cord to the projector.

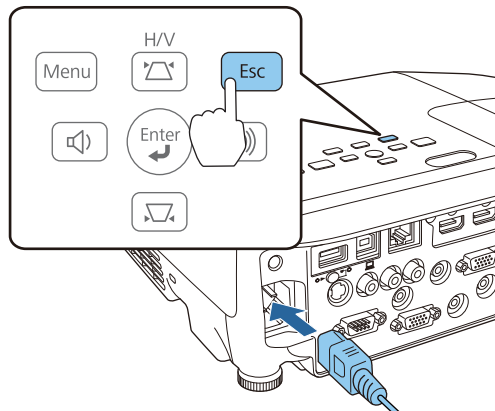

When the projector's indicators turn on as follows, release the [Esc] button.

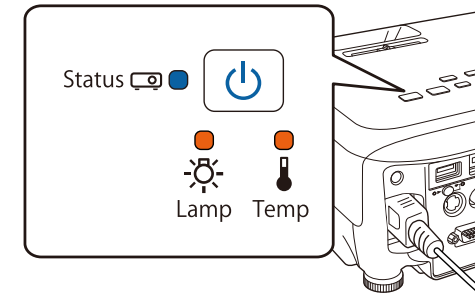

Power: Blue - On/Status: Blue - On/Lamp: Orange - On/Temp: Orange - On

The projector is recognized as a removable disk by the computer.

- 4 Open the removable disk, and save the batch setup file (PJCONFDATA.bin) to the computer.



If you need to change the name of the batch setup file, add text after PJCONFDATA. If you change the PJCONFDATA section of the file name, the projector may not be able to recognize the file correctly.

- 5 Perform **"Remove USB device"** on your computer, and then disconnect the USB cable.



When using OS X, perform **"Remove EPSON_PJ"**.

The projector enters standby status.

Reflecting saved settings to other projectors

- 1** Disconnect the power cord from the projector, and check that all of the projector's indicators have turned off.
- 2** Connect the computer's USB port to the projector's USB-B port with a USB cable.

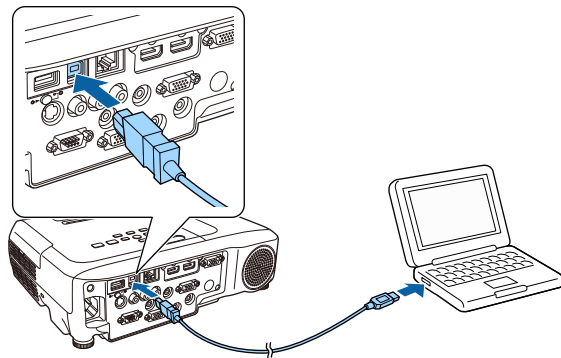

- 3** While holding down the [Menu] button, connect the power cord to the projector.

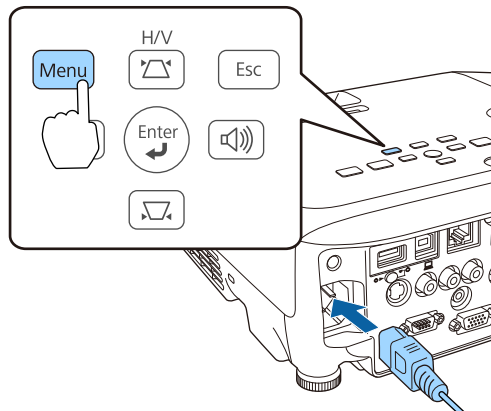

When the projector's indicators turn on as follows, release the [Menu] button.

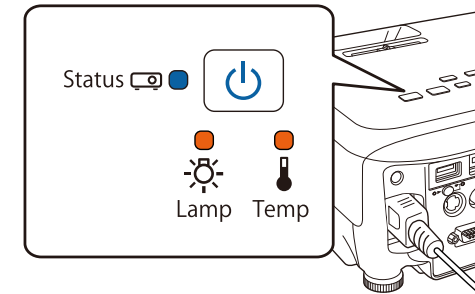

Power: Blue - On/Status: Blue - On/Lamp: Orange - On/Temp: Orange - On

The projector is recognized as a removable disk by the computer.

- Copy the batch setup file (PJCONFDATA.bin) that you saved to your computer to the top level folder of the removable disk.



Do not copy any files or folders other than the batch setup file to the removable disk.

- Perform **Remove USB device** on your computer, and then disconnect the USB cable.



When using OS X, perform **Remove EPSON_PJ**.

When all of the indicators start flashing, the settings are being written.



Caution

Do not disconnect the power cord from the projector while the settings are being written. If the power cord is disconnected, the projector may not start correctly.

When writing completes normally, the projector enters standby status.

When Setup Fails

The indicators notify you if an error occurs. Check the status of the indicators.

Status of the Indicators	Remedy
<p>Status </p> <p> </p> <p>Lamp: Orange - flashing fast Temp: Orange - flashing fast</p>	<p>The batch setup file may be corrupt, or the USB storage device or USB cable may not be connected correctly. Disconnect the USB storage device or the USB cable, unplug and then plug in the projector's power cord, and then try again.</p>
<p>Status </p> <p> </p> <p>Power: Blue - flashing fast Status: Blue - flashing fast Lamp: Orange - flashing fast Temp: Orange - flashing fast</p>	<p>Writing the settings may have failed and an error may have occurred in the projector's firmware. Stop using the projector, remove the power plug from the electrical outlet, and contact your local dealer or the nearest address provided in the Epson Projector Contact List.</p>



Troubleshooting

This chapter explains how to identify problems and what to do if a problem is found.

If a problem occurs with the projector, the Help screen is displayed to assist you by pressing the Help button. You can solve problems by answering the questions.

- 1 Press the [Help] button.
The Help screen is displayed.

Using the remote control

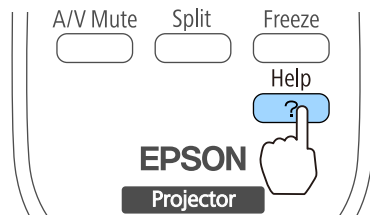

Using the control panel

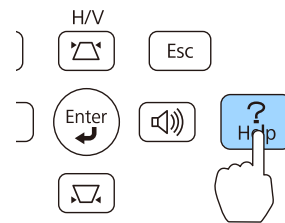

- 2 Select a menu item.

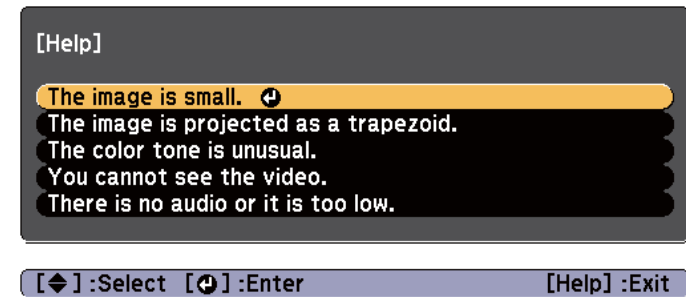

Using the remote control

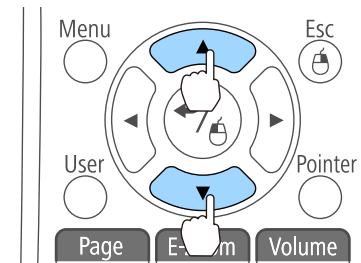

Using the control panel

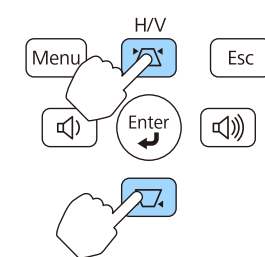

- 3 Confirm the selection.

Using the remote control

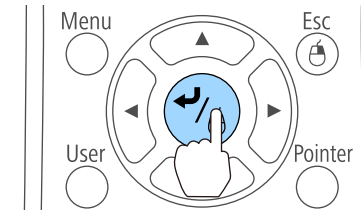

Using the control panel

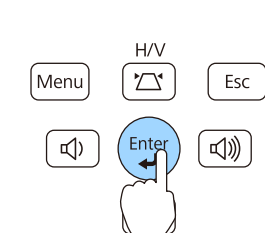

Questions and solutions are displayed as shown on the screen below. Press the [Help] button to exit the Help.

The image is small.

- ❓ Is zoom set to minimum?
· Use the zoom ring to change the size of the image.
- ❓ Is the projector too close to the screen?
· Move the projector away from the screen.

[Esc] :Return

[Help] :Exit



See the following if the Help function does not provide a solution to the problem.

☞ "Problem Solving" [p.130](#)

If you are having a problem with the projector, first check the projector's indicators and refer to "Reading the Indicators" below. See the following if the indicators do not show clearly what the problem might be.



☛ "When the Indicators Provide No Help" [p.134](#)



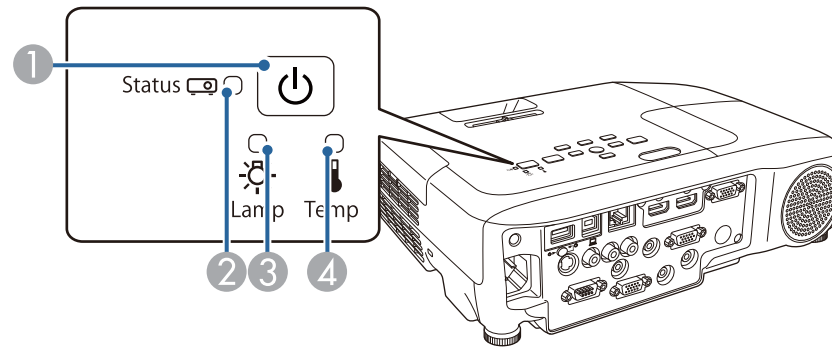

Reading the Indicators

The projector is provided with the following four indicators that indicate the operating status of the projector.



- ① Power indicator Indicates the projector's status.
- ② Status indicator Indicates the projector's status.
- ③ Lamp indicator Indicates the projection lamp status.
- ④ Temp indicator Indicates the internal temperature status.

















Indicators		Status	Explanation
Power supply	Status		
 Blue - Lit	<input type="checkbox"/> Off	Standby condition	Power is being supplied to the projector. When the [⏻] power button is pressed in this condition, projection starts.
			Network monitoring status
 Blue - Lit	 Blue - Flashing	Warm-up status	This is the status immediately after turning on the projector. Warm-up takes approximately 30 seconds after the lamp turns on. In this status you cannot turn off the projector, even if you press the [⏻] power button.























Indicators		Status	Explanation
Power supply	Status		
 Blue - Lit	 Blue - Flashing	Cool down status	This is the status immediately after turning off the projector. In this status, all buttons are disabled.
 Blue - Lit	 Blue - Lit	Normal status	The projector is projecting.



Refer to the following table to see what the indicators mean and how to remedy problems that they indicate.

If all indicators are off, check that the power cord is connected correctly and that the power is being supplied normally.



Sometimes, when the power cord is unplugged, the [⏻] power indicator remains lit for a short period, but this is not a fault.

Indicators				Cause	Remedy or Status
Power supply	Status	Lamp	Temperature		
 Off	 Blue - Flashing	 Orange - Flashing	 Off	Internal Error	Stop using the projector, remove the power plug from the electrical outlet, and contact your local dealer or the nearest address provided in the Epson Projector Contact List.  Epson Projector Contact List
 Off	 Blue - Flashing	 Off	 Orange - Flashing	Fan Error Sensor Error	Stop using the projector, remove the power plug from the electrical outlet, and contact your local dealer or the nearest address provided in the Epson Projector Contact List.  Epson Projector Contact List
 Off	 Blue - Flashing	 Off	 Orange - Lit	High Temp Error (Overheating)	<p>The lamp turns off automatically and projection stops. Wait for about five minutes. After about five minutes the projector switches to standby mode, so check the following two points.</p> <ul style="list-style-type: none"> • Check that the air filter and air exhaust vent are clear, and that the projector is not positioned against a wall. • If the air filter is clogged, clean or replace it.  "Cleaning the Air Filter" p.146, "Replacing the Air Filter" p.151 <p>If the error continues after checking the points above, stop using the projector, remove the power plug from the electrical outlet, and contact your local dealer or the nearest address provided in the Epson Projector Contact List.  Epson Projector Contact List</p>
					When using at an altitude of 1500 m or more, set High Altitude Mode to On .  "Extended Menu" p.106

Indicators				Cause	Remedy or Status
Power supply	Status	Lamp	Temperature		
 Off	 Blue - Flashing	 Orange - Lit	 Off	Lamp Error Lamp Failure	Check the following two points. <ul style="list-style-type: none"> Take out the lamp and check if it is cracked.  "Replacing the Lamp" p.148 Clean the air filter.  "Cleaning the Air Filter" p.146 If the lamp is not cracked: Reinstall the lamp and plug in the power cord. If the error continues: Stop using the projector, remove the power plug from the electrical outlet, and contact your local dealer or the nearest address provided in the Epson Projector Contact List.  Epson Projector Contact List
				Lamp Cover Open	Check that the lamp and the lamp cover are securely installed. The lamp does not turn on if the lamp and the lamp cover are not installed correctly.  "Replacing the Lamp" p.148
 Off	 Blue - Flashing	 Orange - Flashing	 Orange - Flashing	Auto Iris Error	Stop using the projector, remove the power plug from the electrical outlet, and contact your local dealer or the nearest address provided in the Epson Projector Contact List.  Epson Projector Contact List
 Off	 Blue - Flashing	 Orange - Lit	 Orange - Lit	Power Err.	
 Blue - Flashing	 State dependant indication	 State dependant indication	 Orange - Flashing	High Temp Warning	(This is not an abnormality. However, if the temperature rises too high again, projection stops automatically.) <ul style="list-style-type: none"> Check that the air filter and air exhaust vent are clear, and that the projector is not positioned against a wall. If the air filter is clogged, clean or replace it.  "Cleaning the Air Filter" p.146, "Replacing the Air Filter" p.151

Indicators				Cause	Remedy or Status
Power supply	Status	Lamp	Temperature		
 Blue - Flashing	<input type="checkbox"/> State dependant indication	 Orange - Flashing	<input type="checkbox"/> State dependant indication	Replace Lamp	Replace it with a new lamp.  "Replacing the Lamp" p.148 If you continue to use the lamp after the replacement period has passed, the possibility that the lamp may explode increases. Replace it with a new lamp as soon as possible.













- See the following if the projector is not operating properly, even though the indicators are all showing normal.
 -  "When the Indicators Provide No Help" [p.134](#)
- If the indicators are in a state not shown in this table, stop using the projector, remove the power plug from the electrical outlet, and contact your local dealer or the nearest address provided in the Epson Projector Contact List.
 -  [Epson Projector Contact List](#)

When the Indicators Provide No Help

If any of the following problems occur and the indicators do not offer a solution, refer to the pages given for each problem.







Problems Relating to Images

<ul style="list-style-type: none"> • No images appear Projection does not start, the projection area is completely black, or the projection area is completely blue. 	 p.135
<ul style="list-style-type: none"> • Moving images are not displayed Moving images being projected from a computer appear black and nothing is projected. 	 p.136
<ul style="list-style-type: none"> • Projection stops automatically 	 p.136
<ul style="list-style-type: none"> • The message "Not supported" is displayed 	 p.136
<ul style="list-style-type: none"> • The message "No Signal" is displayed 	 p.137
<ul style="list-style-type: none"> • Images are fuzzy, out of focus, or distorted 	 p.137
<ul style="list-style-type: none"> • Interference or distortion appear in images 	 p.138
<ul style="list-style-type: none"> • The mouse cursor flickers (only when projecting USB Display) 	 p.139
<ul style="list-style-type: none"> • The image is truncated (large) or small, the aspect ratio is not suitable, or the image has been reversed Only part of the image is displayed, the height and width ratios of the image are not correct, or the image may appear reversed from top to bottom or left to right. 	 p.139
<ul style="list-style-type: none"> • Image colors are not right The whole image appears purplish or greenish, images are black & white, or colors appear dull. 	 p.140
<ul style="list-style-type: none"> • Images appear dark 	 p.140

Problems when projection starts

<ul style="list-style-type: none"> • The projector does not turn on 	 p.141
---	---

Other Problems

<ul style="list-style-type: none"> • No sound can be heard or the sound is faint 	 p.142
<ul style="list-style-type: none"> • There is noise in the audio 	 p.142
<ul style="list-style-type: none"> • No sound can be heard from the microphone (EB-955WH/EB-950WH/EB-965H/EB-945H/EB-940H/EB-98H/EB-97H only) 	 p.143
<ul style="list-style-type: none"> • The remote control does not work 	 p.143
<ul style="list-style-type: none"> • I want to change the language for messages and menus 	 p.143
<ul style="list-style-type: none"> • Mail is not received even if a problem occurs in the projector 	 p.144
<ul style="list-style-type: none"> • Cannot change settings using a Web browser 	 p.144

Problems Relating to Images

No images appear

Check	Remedy
Did you press the [⏻] power button?	Press the [⏻] power button to turn the power on.
Are the indicators switched off?	The power cord is not connected correctly or power is not being supplied. Connect the projector's power cord correctly. ☛ "Turning On the Projector" p.39 Check that your electrical outlet or power source is functioning correctly.
Is A/V Mute active?	Press the [A/V Mute] button on the remote control to cancel A/V Mute. ☛ "Hiding the Image and Sound Temporarily (A/V Mute)" p.71
Is the A/V mute slide closed?	No images are displayed if the A/V mute slide is closed even a little. Open the A/V mute slide completely. ☛ "Front/Top" p.12
Are the Configuration menu settings correct?	Reset all of the settings. ☛ Reset - Reset All p.119
Is the image to be projected completely black? (Only when projecting computer images)	Some input images, such as screen savers, may be completely black.
Is the image signal format setting correct? (Only when projecting images from a video source)	Change the setting according to the signal for the connected equipment. ☛ Signal - Video Signal p.103
Is the USB cable connected correctly? (Only when projecting USB Display)	Check that the USB cable is connected correctly. Reconnect it if it is not connected or not connected properly.
Is Windows Media Center displayed in full screen? (Only when projecting using USB Display or network connection)	When Windows Media Center is displayed at full screen, you cannot project using USB Display or network connection. Reduce the screen size.
Is an application using the Windows DirectX function displayed? (Only when projecting using USB Display or network connection)	Applications using the Windows DirectX function may not display images correctly.

Moving images are not displayed

Check	Remedy
Is the computer's image signal being output to the LCD and the monitor? (Only when projecting images from a laptop computer or a computer with a built-in LCD screen)	Change the image signal from the computer to external output only. Check your computer's documentation, or contact the computer's manufacturer.
Are the contents of the moving image you are trying to project copyright protected?	The projector may not be able to project copyright protected moving images that are being played back on a computer. For more details, see the user's guide supplied with the player and so on.

Projection stops automatically

Check	Remedy
Are Sleep Mode , Lens Cover Timer , or A/V Mute Timer set to On ?	If any of these are set to On , the power turns off automatically in the following situations. <ul style="list-style-type: none"> • When Sleep Mode is set to On: If no operations are performed for a specified length of time while no image signal is being input. • When Lens Cover Timer is set to On: If approximately 30 minutes has passed since the A/V mute slide was closed. • When A/V Mute Timer is set to On: If approximately 30 minutes has passed since the A/V mute was enabled. To prevent the projector from switching off automatically, make sure each setting is set to Off . ☛ "ECO Menu" p.117
Is the computer in power-saving mode?	If the computer is in power-saving mode and no operations are performed for a specified period of time, the image may disappear. Perform an operation on the computer to display the image again.

The message "Not supported" is displayed

Check	Remedy
Is the image signal format setting correct? (Only when projecting images from a video source)	Change the setting according to the signal for the connected equipment. ☛ Signal - Video Signal p.103
Do the image signal resolution and the refresh rate correspond to the mode? (Only when projecting computer images)	Refer to the computer's documentation for how to change the image signal resolution and the refresh rate output from the computer. ☛ "Supported Monitor Displays" p.165

The message "No Signal" is displayed

Check	Remedy
Are the cables connected correctly?	Check that all the cables required for projection are securely connected. ☛ "Turning On the Projector" p.39
Is the correct port selected?	Change the image by pressing the [Source Search] button on the remote control or the control panel. ☛ "Automatically Detect Input Signals and Change the Projected Image (Source Search)" p.41
Is the power for the computer or video source turned on?	Turn the power on for the equipment.
Are the image signals being output to the projector? (Only when projecting images from a laptop computer or a computer with a built-in LCD screen)	If the image signals are only being output to the computer's LCD monitor or to the accessory monitor, you need to change the output to an external destination as well as the computer's own monitor. For some computer models, when the image signals are output externally, they no longer appear on the LCD monitor or accessory monitor. If the connection is made while the power of the projector or computer is already turned on, the Fn key (Function key) that changes the computer's image signal to external output may not work. Turn the power for the computer and the projector off and then back on again. ☛ "Turning On the Projector" p.39 ☛ Computer's documentation
Is the computer in power-saving mode?	If the computer is in power-saving mode and no operations are performed for a specified period of time, the image may disappear. Perform an operation on the computer to display the image again.

Images are fuzzy, out of focus, or distorted

Check	Remedy
Is Auto V-Keystone set to Off?	Setting it to On enables Auto V-Keystone. ☛ Settings - Keystone - H/V-Keystone - Auto V-Keystone p.105 If you are using the projector with this setting off, manually adjust the projected image. ☛ "Correcting manually" p.48
Is the focus adjusted correctly?	Turn the focus ring to adjust the focus. ☛ "Correcting the Focus" p.52
Is the projector at the correct distance?	Is it projecting outside of the recommended projection distance range? Setup within the recommended range. ☛ "Screen Size and Projection Distance" p.155

Check	Remedy
Is the Keystone adjustment value too large?	Lower the projection angle to reduce the amount of keystone correction. ☛ "Adjusting the Image Position" p.52
Has condensation formed on the lens?	If the projector is suddenly taken from a cold environment to a warm environment, or if sudden ambient temperature changes occur, condensation may form on the surface of the lens, and this may cause the images to appear fuzzy. Set the projector up in the room about one hour before it is used. If condensation forms on the lens, turn the projector off and wait for the condensation to disappear.

Interference or distortion appear in images

Check	Remedy
Is the image signal format setting correct? (Only when projecting images from a video source)	Change the setting according to the signal for the connected equipment. ☛ Signal - Video Signal p.103
Are the cables connected correctly?	Check that all the cables required for projection are securely connected. ☛ "Connecting Equipment" p.28
Is an extension cable being used?	If an extension cable is used, electrical interference may affect the signals. Use the cables supplied with the projector to check if the cables you are using may be causing the problem.
Is the correct resolution selected? (Only when projecting computer images)	Set the computer so that the signals being output are compatible with the projector. ☛ "Supported Monitor Displays" p.165 ☛ Computer's documentation
Are the Sync and Tracking settings adjusted correctly? (Only when projecting computer images)	Press the [Auto] button on the remote control or the [↶] button on the control panel to perform automatic adjustment. If the images are not adjusted correctly even after performing automatic adjustment, you can also make adjustments from the Configuration menu. ☛ Signal - Tracking, Sync. p.103
Is Transfer layered window selected? (Only when projecting USB Display)	Click All Programs - EPSON Projector - Epson USB Display - Epson USB Display Vx.xx Settings , and then clear the Transfer layered window check box.

The mouse cursor flickers (only when projecting USB Display)

Check	Remedy
Is Make the movement of the mouse pointer smooth. selected?	Click All Programs - EPSON Projector - Epson USB Display - Epson USB Display Ver.x.xx Settings , and then select the Make the movement of the mouse pointer smooth. checkbox. (This is not available for Windows 2000.) For Windows Vista/7, Windows Aero is disabled when this is selected.

The image is truncated (large) or small, the aspect is not suitable, or the image has been reversed

Check	Remedy
Is a wide panel computer image being projected? (Only when projecting computer images)	Change the setting according to the signal for the connected equipment. ☛ Signal - Resolution p.103
Is the image still being enlarged by E-Zoom?	Press the [Esc] button on the remote control to cancel E-Zoom. ☛ "Enlarging Part of the Image (E-Zoom)" p.73
Is the image position adjusted correctly?	Press the [Auto] button on the remote control or the [Enter] button on the control panel to perform automatic adjustment of the computer image being projected. If the images are not adjusted correctly even after performing automatic adjustment, you can also make adjustments from the Configuration menu. Apart from computer image signals, you can adjust other signals while projecting from the Configuration menu. ☛ Signal - Position p.103
Is the computer set for dual display? (Only when projecting computer images)	If dual display is activated in the Display Properties of the computer's Control Panel, only about half of the image on the computer screen is projected. To display the entire image on the computer screen, turn off the dual display setting. ☛ Computer video driver documentation
Is the correct resolution selected? (Only when projecting computer images)	Set the computer so that the signals being output are compatible with the projector. ☛ "Supported Monitor Displays" p.165 ☛ Computer's documentation
Is the projection mode correct?	Depending on how the projector is installed, set the projection mode from one of the following: Front, Front/Ceiling, Rear, Rear/Ceiling. ☛ Extended - Projection p.106 ☛ "Installation Methods" p.24

Image colors are not right

Check	Remedy
Do the input signal settings match the signals from the connected device?	Change the following settings according to the signal for the connected equipment. <ul style="list-style-type: none"> • When the image is from a device connected to the Computer port. <ul style="list-style-type: none"> ☛ Signal - Input Signal p.103 • When the image is from a device connected to the Video or S-Video port. <ul style="list-style-type: none"> ☛ Signal - Video Signal p.103
Is the image brightness adjusted correctly?	Adjust the Brightness setting from the Configuration menu. <ul style="list-style-type: none"> ☛ Image - Brightness p.102
Are the cables connected correctly?	Check that all the cables required for projection are securely connected. Check that no cables are disconnected and that there are no poor contacts in the cables. <ul style="list-style-type: none"> ☛ "Connecting Equipment" p.28
Is the <u>contrast</u>  adjusted correctly?	Adjust the Contrast setting from the Configuration menu. <ul style="list-style-type: none"> ☛ Image - Contrast p.102
Is the color adjustment set correctly?	Adjust the Color Adjustment setting from the Configuration menu. <ul style="list-style-type: none"> ☛ Image - Color Adjustment p.102
Are the color saturation and tint adjusted correctly? (Only when projecting images from a video source)	Adjust the Color Saturation and Tint settings from the Configuration menu. <ul style="list-style-type: none"> ☛ Image - Color Saturation, Tint p.102

Images appear dark

Check	Remedy
Is the image brightness set correctly?	Adjust the Brightness and Power Consumption settings from the Configuration menu. <ul style="list-style-type: none"> ☛ Image - Brightness p.102 ☛ ECO - Power Consumption p.117
Is the <u>contrast</u>  adjusted correctly?	Adjust the Contrast setting from the Configuration menu. <ul style="list-style-type: none"> ☛ Image - Contrast p.102
Is it time to replace the lamp?	When the lamp is nearly ready for replacement, the images become darker and the color quality becomes poorer. When this happens, replace the lamp with a new lamp. <ul style="list-style-type: none"> ☛ "Replacing the Lamp" p.148

Check	Remedy
Are you using the projector at a high altitude or in a location subject to high temperatures?	The screen may become dark when using at high altitude or in a location subject to high temperatures. Although you cannot make Power Consumption settings at this time, you can continue to use the projector.
Is it projecting outside of the recommended projection distance range?	The image becomes darker if the projection distance is too large. Setup within the recommended range. ☛ "Screen Size and Projection Distance" p.155

Problems when Projection Starts

The projector does not turn on

Check	Remedy
Did you press the [⏻] power button?	Press the [⏻] power button to turn the power on.
Are the indicators switched off?	The power cord is not connected correctly or power is not being fully supplied. Disconnect and then reconnect the power cord. ☛ "Turning On the Projector" p.39 Check that your electrical outlet or power source is functioning correctly.
Do the indicators turn on and off when the power cord is touched?	There is probably a poor contact in the power cord, or the power cord may be defective. Reinsert the power cord. If this does not solve the problem, stop using the projector, disconnect the power cord from the electrical outlet, and contact your local dealer or the nearest address provided in the Epson Projector Contact List. ☛ Epson Projector Contact List
Is the Control Panel Lock set to Full Lock ?	Press the [⏻] power button on the remote control. If you do not want to use Control Panel Lock , change the setting to Off . ☛ Settings - Control Panel Lock p.105
Is remote control operation restricted?	Check the Remote Receiver from the Configuration menu. ☛ Settings - Remote Receiver p.105

Other Problems

No sound can be heard or the sound is faint

Check	Remedy
Check that the audio/video cable is securely attached to both the projector and audio source.	Disconnect the cable from the Audio port, and then reconnect the cable.
Is the volume for the projector or the connected equipment set to the minimum?	Adjust the volume so that sound can be heard. ● Settings - Volume p.105 ● "Adjusting the Volume" p.53
Is the Mic Input Level set at the maximum?	Lower the Mic Input Level . ● Settings - Mic Input Level p.105
Is A/V Mute active?	Press the [A/V Mute] button on the remote control to cancel A/V Mute. ● "Hiding the Image and Sound Temporarily (A/V Mute)" p.71
Is the audio cable's specification "No resistance"?	When using a commercially available audio cable, make sure it is labeled "No resistance".
Is it connected with an HDMI cable?	If no audio is output when connecting via an HDMI cable, set the connected equipment to PCM output.
Is Output audio from the projector selected? (Only when projecting in USB Display, when projecting one screen in EasyMP Network Projection, or one screen in EasyMP Multi PC Projection.)	Click All Programs - EPSON Projector - Epson USB Display - Epson USB Display Vx.xx Settings , and then select Output audio from the projector . When projecting in EasyMP Network Projection or EasyMP Multi PC Projection: In the software you are using, select Output audio from the projector from the Audio Output tab in Set options .

There is noise in the audio (when projecting EasyMP Network Projection, EasyMP MultiPC Projection, USB Display, or Quick Wireless Connection)

Check	Remedy
Is the volume for the computer set to the minimum while the projector is set to the maximum?	If the volume for the computer is set to the minimum while the projector is set to the maximum, the noise may be mixed. Turn up the computer's volume and turn down the projector's volume.

No sound can be heard from the microphone (EB-955WH/EB-950WH/EB-965H/EB-945H/EB-940H/EB-98H/EB-97H only)

Check	Remedy
Is the microphone connected correctly?	Disconnect the cable from the Microphone (Mic) input port, and then reconnect the cable. ☛ "Connecting External Equipment" p.33
Is the microphone input volume turned down too low?	Adjust the microphone input volume so that sound can be heard. ☛ Settings - Mic Input Level p.105
Is Plug-in Power set correctly?	When using a condenser microphone, set Plug-in Power to On from the menu. ☛ Extended - A/V Settings - Plug-in Power p.106

The remote control does not work

Check	Remedy
Is the remote control light-emitting area pointing towards the remote receiver on the projector during operation?	Point the remote control towards the remote receiver. ☛ "Remote control operating range" p.22
Is the remote control too far from the projector?	The operating range for the remote control is about six meters. ☛ "Remote control operating range" p.22
Is direct sunlight or strong light from fluorescent lamps shining onto the remote receiver?	Set the projector up in a location where strong light does not shine onto the remote receiver. ☛ Settings - Remote Receiver p.105
Is the correct setting for the Remote Receiver selected?	Check the Remote Receiver from the Configuration menu. ☛ Settings - Remote Receiver p.105
Are the batteries dead or have the batteries been inserted correctly?	Make sure the batteries are inserted correctly or replace the batteries with new ones if necessary. ☛ "Replacing the remote control batteries" p.21

I want to change the language for messages and menus

Check	Remedy
Change the Language setting.	Adjust the Language setting from the Configuration menu. ☛ Extended - Language p.106

Mail is not received even if a problem occurs in the projector

Check	Remedy
Is Standby Mode set to Communication On ?	To use the Mail Notification function when the projector is in standby, set Communication On in Standby Mode from the Configuration menu. ☛ ECO - Standby Mode p.117
Did a fatal abnormality occur and the projector come to a sudden stop?	If the abnormal state continues, contact your local dealer or the nearest address provided in the Epson Projector Contact List. ☛ Epson Projector Contact List
Is power being supplied to the projector?	Check that your electrical outlet or power source is functioning correctly.
Is Mail Notification function set correctly in the Configuration menu?	An error notification email is sent according to the Mail settings in the Configuration menu. Check if it is set correctly. ☛ "Mail menu" p.115

Cannot change settings using a Web browser

Check	Remedy
Are the user ID and password correct?	Enter "EPSONWEB" as the user ID. This cannot be changed. Enter the user ID even if the password setting is disabled. Enter the characters set for the Web Control Password as the password. The initial password is "admin".



Maintenance

This chapter provides information on maintenance procedures to ensure the best level of performance from the projector for a long time to come.

You should clean the projector if it becomes dirty or if the quality of projected images starts to deteriorate.



Caution

Turn off the projector's power before cleaning. Otherwise, it could cause an electric shock.

Cleaning the Projector's Surface

Clean the projector's surface by wiping it gently with a soft cloth.

If the projector is particularly dirty, moisten the cloth with water containing a small amount of neutral detergent, and then firmly wring the cloth dry before using it to wipe the projector's surface.

Attention

Do not use volatile substances such as wax, alcohol, or thinner to clean the projector's surface. The quality of the case may change or become discolored.

Cleaning the Lens

Use a commercially available cloth for cleaning glasses to gently wipe the lens.



Warning

Do not use sprays that contain flammable gas to remove dust and lint from the lens. The projector may catch fire due to the high internal temperature of the lamp.

Attention

Do not rub the lens with harsh materials or subject the lens to shocks as it can easily become damaged.

Cleaning the Air Filter

Clean the air filter and the air intake vent when the following message is displayed.

"The projector is overheating. Make sure nothing is blocking the air vent, and clean or replace the air filter."

Attention

- If dust collects on the air filter, it can cause the internal temperature of the projector to rise, and this can lead to problems with operation and shorten the optical engine's service life. Clean the air filter immediately when the message is displayed.
- Do not rinse the air filter in water. Do not use detergents or solvents.

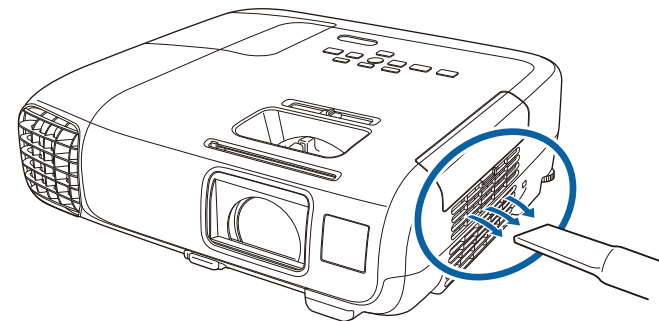



- If a message is frequently displayed, even after cleaning, it is time to replace the air filter. Replace it with a new air filter.
 - ☛ "Replacing the Air Filter" [p.151](#)
- It is recommended that you clean these parts at least once every three months. Clean them more often than this if using the projector in a particularly dusty environment.

This section explains how to replace the lamp and the air filter.

Replacing the Lamp

Lamp replacement period

It is time to replace the lamp when:

- The following message is displayed.
"Time to replace the lamp. Please contact your Epson projector reseller or visit www.epson.com to purchase."

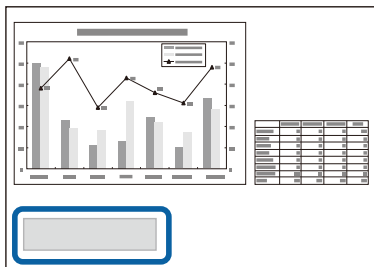

The message is displayed for 30 seconds.

- The power indicator is flashing blue, and the lamp indicator is flashing orange.

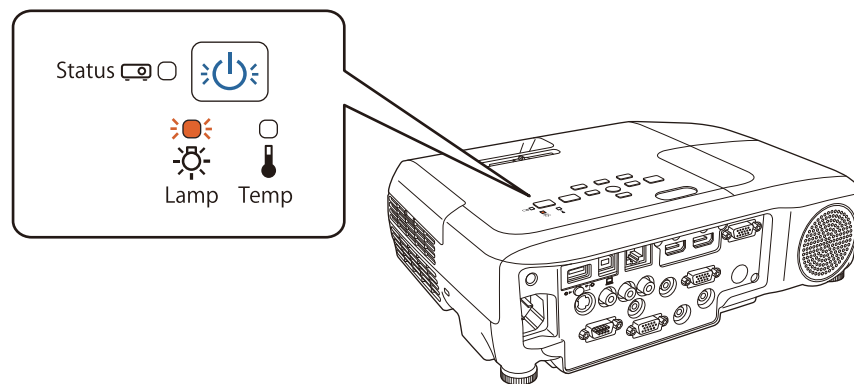

- The projected image gets darker or starts to deteriorate.

Attention

- The lamp replacement message is set to appear after the following time periods in order to maintain the initial brightness and quality of the projected images.
When **Power Consumption** is set to **Normal**: About 4,900 hours
When **Power Consumption** is set to **ECO**: About 9,900 hours
☛ **ECO - Power Consumption** p.117
- If you continue to use the lamp after the replacement period has passed, the possibility that the lamp may explode increases. When the lamp replacement message appears, replace the lamp with a new one as soon as possible, even if it is still working.
- Do not repeatedly turn off the power and immediately back on. Turning the power on and off frequently may shorten the lamp's operating life.
- Depending on the characteristics of the lamp and the way it has been used, the lamp may become darker or stop working before the lamp warning message appears. You should always have a spare lamp unit ready in case it is needed.
- We recommend the use of genuine EPSON option lamps. The use of non-genuine lamps may affect projection quality and safety. Any damage or malfunction caused by the use of non-genuine lamps may not be covered by Epson's warranty.

How to replace the lamp

The lamp can be replaced even when the projector is suspended from a ceiling.

Warning

- When replacing the lamp because it has stopped illuminating, there is a possibility that the lamp may be broken. If replacing the lamp of a projector which has been installed on the ceiling, you should always assume that the lamp is cracked, and you should stand to the side of the lamp cover, not underneath it. Remove the lamp cover gently. Be careful when removing the lamp cover as shards of glass may fall out and could cause an injury. If any shards of glass get into your eyes or mouth, contact your local physician immediately.
- Never disassemble or remodel the lamp. If a modified or disassembled lamp is installed in the projector and used, it could cause a fire, electric shock, or an accident.

Caution

Wait until the lamp has cooled down sufficiently before removing the lamp cover. If the lamp is still hot, burns or other injuries may result. It takes about one hour after the power has been turned off for the lamp to be cool enough.

- 1** After you turn off the projector's power and the confirmation buzzer beeps twice, disconnect the power cord.
- 2** Wait until the lamp has sufficiently cooled down, and then remove the lamp cover at the top of the projector.
Loosen the Lamp cover fixing screw with the screwdriver supplied with the new lamp unit or a cross-head screwdriver. Then slide the lamp cover straight forward and lift it to remove.

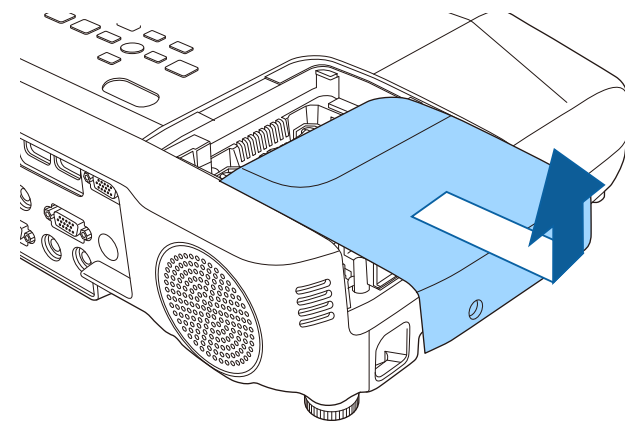
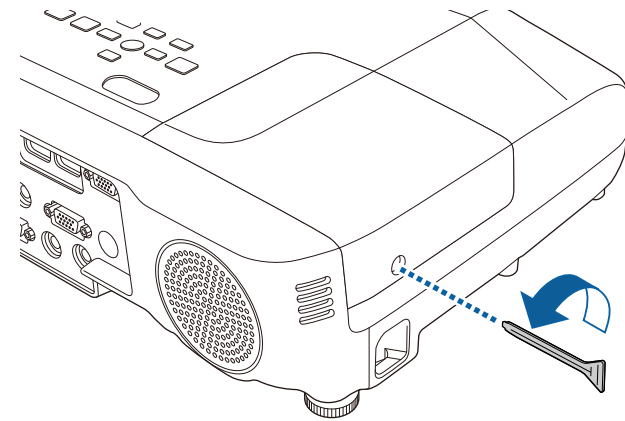

- 3** Loosen the two lamp fixing screws.

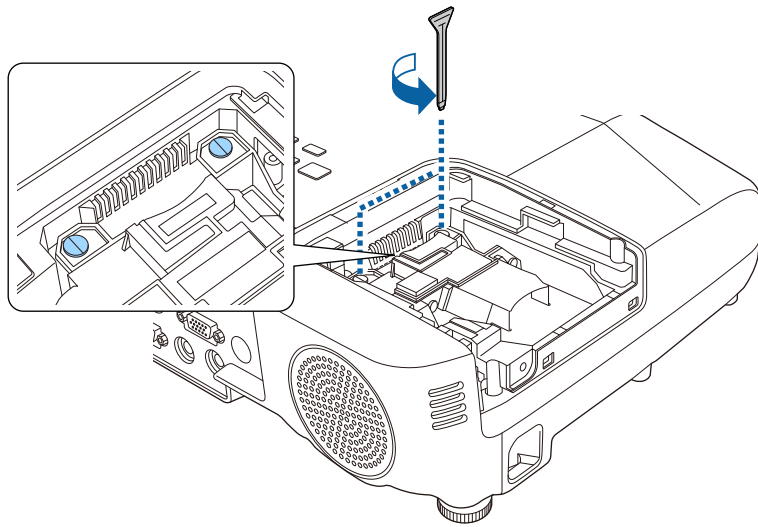

- 4** Grip the raised section of the old lamp and remove it.
If the Lamp is cracked, replace it with a new lamp, or contact your local dealer for further advice.

 [Epson Projector Contact List](#)

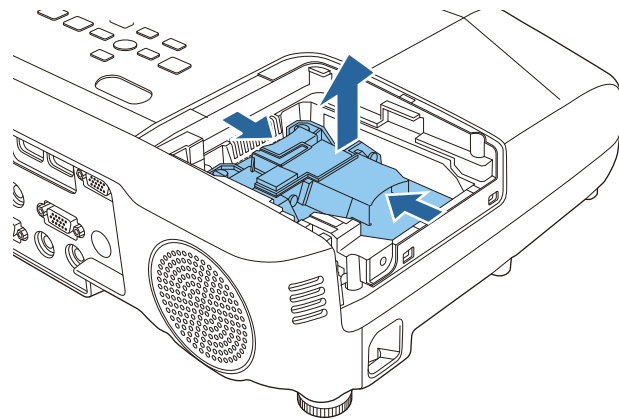

- 5** Install the new lamp.
Insert the new Lamp along the guide rail in the correct direction so that it fits in place, push in firmly, and once it is fully inserted tighten the two screws.

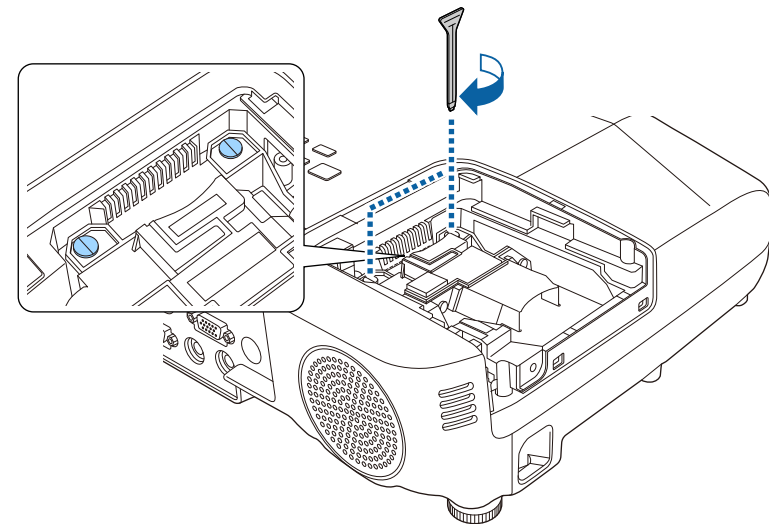
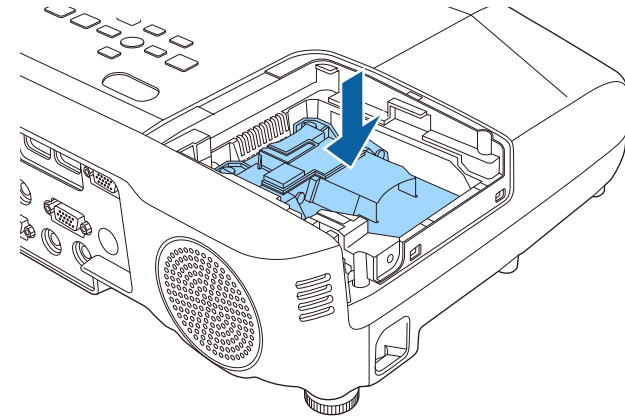

- 6** Replace the lamp cover.

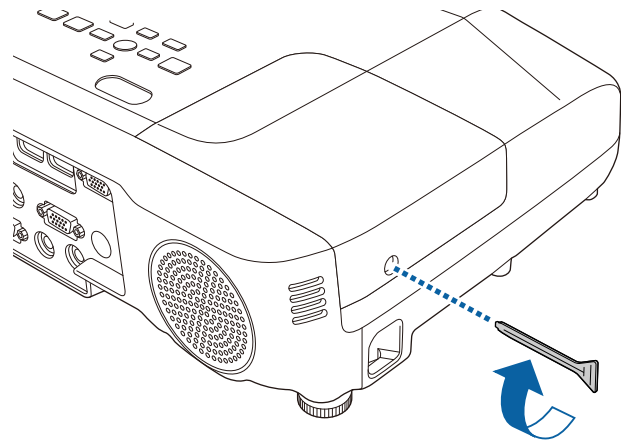

Attention

- Make sure you install the lamp securely. If the lamp cover is removed, the lamps turn off automatically as a safety precaution. If the lamp or the lamp cover is not installed correctly, the lamp will not turn on. Make sure the lamp cover is not loose or deformed before use.
- This product includes a lamp component that contains mercury (Hg). Please consult your local regulations regarding disposal or recycling. Do not dispose of it with normal waste.

Resetting the lamp hours

The projector records how long the lamp is turned on and a message and indicator notify you when it is time to replace the lamp. After replacing the lamp, make sure you reset the Lamp Hours from the Reset menu.

☛ **Reset - Reset Lamp Hours** [p.119](#)



Only reset the **Lamp Hours** after the lamp has been replaced. Otherwise the lamp replacement period is not indicated correctly.

Replacing the Air Filter

Air filter replacement period

If the message is displayed frequently even though the air filter has been cleaned, replace the air filter.

How to replace the air filter

The air filter can be replaced even when the projector is suspended from a ceiling.

- 1** After you turn off the projector's power and the confirmation buzzer beeps twice, disconnect the power cord.
- 2** Open the air filter cover.

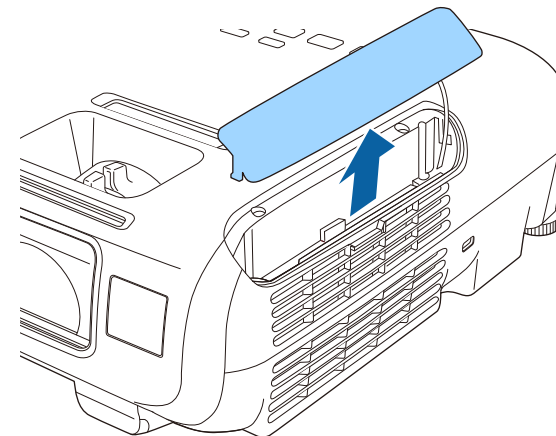

- 3** Remove the air filter.
Grip the air filter cover tab and pull it straight out.

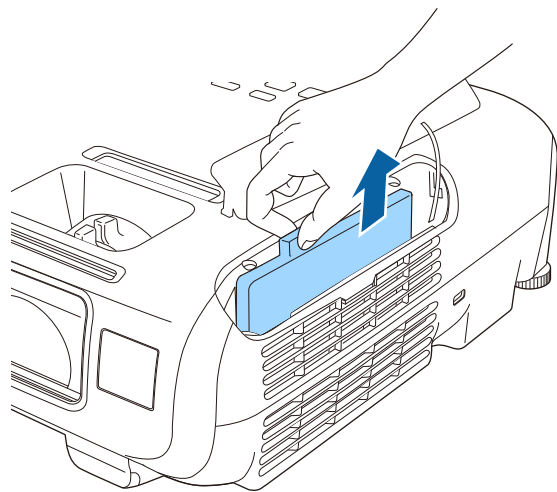

4 Install the new air filter.

Slide the air filter from the outside and press in until it firmly clicks into place.

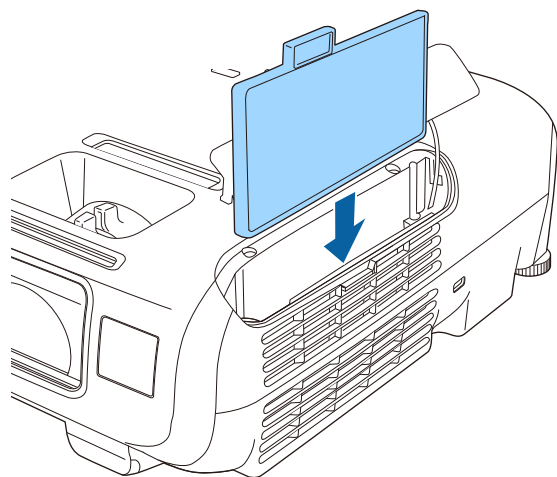

5 Close the air filter cover.



Dispose of used air filters properly in accordance with your local regulations.

Filter frame: ABS

Filter: Polyurethane foam



Appendix

The following optional accessories and consumables are available. Please purchase these products as and when needed. The following list of optional accessories and consumables is current as of: October 2014. Details of accessories are subject to change without notice and availability may vary depending on the country of purchase.

Optional Accessories

Wireless LAN unit ELPAP07

Use this to project images from a computer via a wireless communication.

Quick Wireless Connection USB Key ELPAP09

Use when you want to quickly establish one-to-one connection between the projector and a computer with Windows installed.

Document Camera ELPDC06/ELPDC11/ELPDC12/ELPDC20

Use when projecting images such as books, OHP documents, or slides.

Soft carrying case ELPKS67

A soft case to carry the projector.

Multi-aspect screen ELPSC26

This is a portable multi-aspect screen.

50" portable screen ELPSC32

A compact screen that can be carried easily. (Aspect Ratio▶▶ 4:3)

60" portable screen ELPSC27

80" portable screen ELPSC28

100" screen ELPSC29

Portable roll-type screens. (aspect ratio 4:3)

70" portable screen ELPSC23

80" portable screen ELPSC24

90" portable screen ELPSC25

Portable roll-type screens. (aspect ratio 16:10)

64" portable screen ELPSC31

Portable magnetic screens. (aspect ratio 4:3)

Computer cable ELPKC02

(1.8 m - for mini D-Sub15-pin/mini D-Sub 15pin)

Computer cable ELPKC09

(3 m - for mini D-Sub15-pin/mini D-Sub 15pin)

Computer cable ELPKC10

(20 m - for mini D-Sub15-pin/mini D-Sub 15pin)

Component video cable ELPKC19

(3 m - for mini D-Sub 15-pin/RCA male×3)

Use to connect a [component video](#)▶▶ source.

Ceiling pipe (450 mm)* ELPFP13

Ceiling pipe (700 mm)* ELPFP14

Use when installing the projector on a high ceiling.

Ceiling mount* ELPMB23

Use when installing the projector on a ceiling.

Speaker ELPSP02

External speaker with built-in amplifier.

* Special expertise is required to suspend the projector from a ceiling. Contact your local dealer or the nearest address provided in the Epson Projector Contact List.

🔍 [Epson Projector Contact List](#)

Consumables

Lamp unit ELPLP88

Use as a replacement for used lamps.

Air filter ELPAF32

Use as a replacement for used air filters.

Projection Distance (For EB-X30)

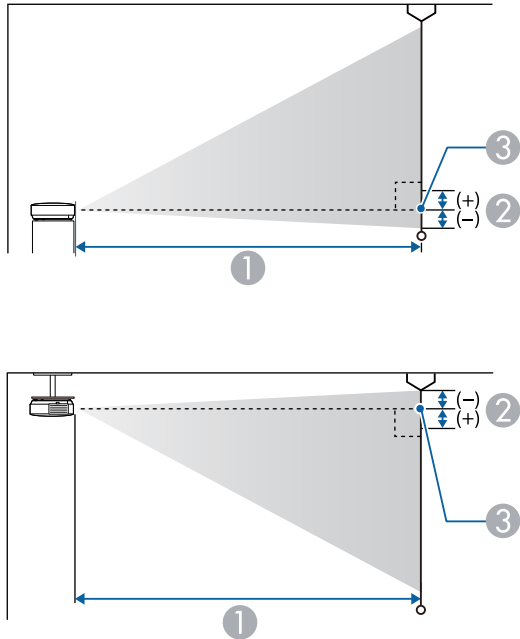

- ① Projection distance
- ② Distance from the center of the receiver's lens to the base of the screen (or to the top of the screen, if suspended from a ceiling)
- ③ Center of lens

Unit: cm

4:3 Screen Size		① Minimum (Wide) to Maximum (Tele)	②
30"	61x46	84 - 101	-5
40"	81x61	113 - 136	-6
50"	100x76	142 - 171	-8

4:3 Screen Size		① Minimum (Wide) to Maximum (Tele)	②
60"	120x91	171 - 206	-10
80"	160x120	229 - 275	-13
100"	200x150	287 - 345	-16
150"	300x230	432 - 519	-24
200"	410x300	577 - 693	-32
250"	510x380	722 - 867	-40
300"	610x460	867 - 1041	-48

Unit: cm

16:9 Screen Size		① Minimum (Wide) to Maximum (Tele)	②
30"	66x37	91 - 110	1
40"	89x50	123 - 148	1
50"	110x62	155 - 186	2
60"	130x75	186 - 224	2
80"	180x100	249 - 300	3
100"	220x120	313 - 376	3
150"	330x190	471 - 566	5
200"	440x250	629 - 755	7
250"	550x310	787 - 945	9
275"	610x340	866 - 1040	10

Projection Distance (For EB-98H/EB-97H/EB-X29/EB-X27)

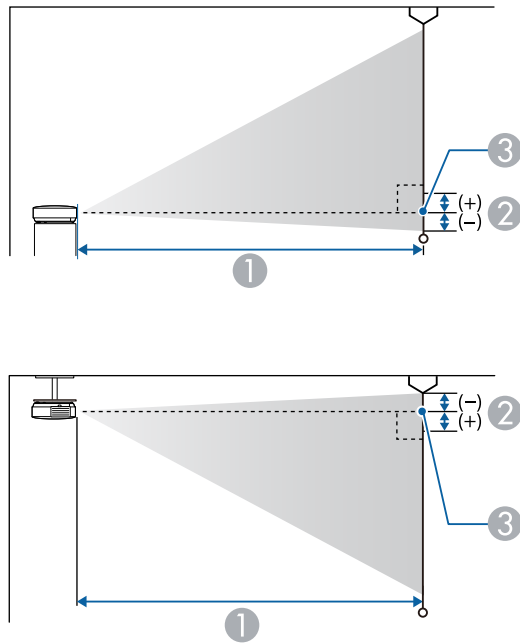

- ① Projection distance
- ② Distance from the center of the receiver's lens to the base of the screen (or to the top of the screen, if suspended from a ceiling)
- ③ Center of lens

Unit: cm

4:3 Screen Size		① Minimum (Wide) to Maximum (Tele)	②
30"	61x46	89 - 107	-5
40"	81x61	119 - 143	-7

4:3 Screen Size		① Minimum (Wide) to Maximum (Tele)	②
50"	100x76	150 - 180	-8
60"	120x91	180 - 217	-10
80"	160x120	241 - 290	-14
100"	200x150	302 - 363	-17
150"	300x230	454 - 546	-25
200"	410x300	607 - 729	-34
250"	510x380	759 - 912	-42
300"	610x460	912 - 1095	-51

Unit: cm

16:9 Screen Size		① Minimum (Wide) to Maximum (Tele)	②
30"	66x37	97 - 117	1
40"	89x50	130 - 156	1
50"	110x62	163 - 196	1
60"	130x75	196 - 236	1
80"	180x100	263 - 316	2
100"	220x120	329 - 396	2
150"	330x190	495 - 595	3
200"	440x250	661 - 794	5
250"	550x310	827 - 994	6
275"	610x340	910 - 1093	6

Projection Distance (For EB-W29)

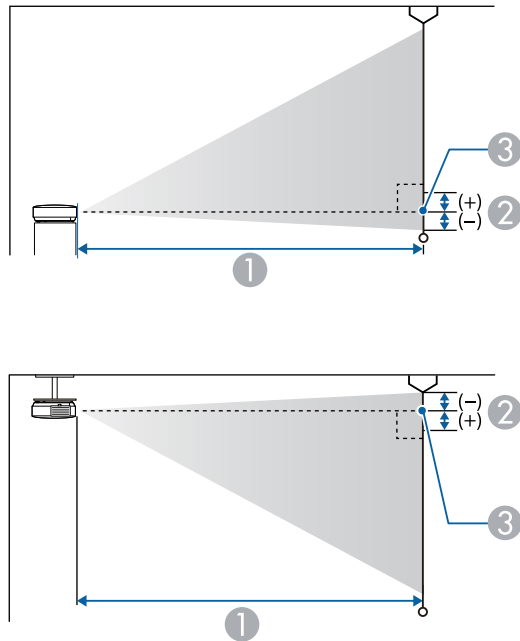

- ① Projection distance
- ② Distance from the center of the receiver's lens to the base of the screen (or to the top of the screen, if suspended from a ceiling)
- ③ Center of lens

Unit: cm

4:3 Screen Size		① Minimum (Wide) to Maximum (Tele)	②
30"	61x46	94 - 113	-4
40"	81x61	126 - 152	-5
50"	100x76	158 - 190	-7

4:3 Screen Size		① Minimum (Wide) to Maximum (Tele)	②
60"	120x91	190 - 229	-8
70"	142x107	222 - 267	-10
80"	160x120	255 - 306	-11
100"	200x150	319 - 383	-14
150"	300x230	480 - 577	-20
200"	410x300	641 - 770	-27
280"	570x430	898 - 1079	-38

Unit: cm

16:9 Screen Size		① Minimum (Wide) to Maximum (Tele)	②
32"	71x40	91 - 109	-2
35"	78x44	99 - 120	-2
40"	89x50	114 - 137	-2
50"	110x62	143 - 172	-3
60"	130x75	172 - 208	-3
70"	155x87	202 - 243	-4
80"	180x100	231 - 278	-4
100"	220x120	289 - 348	-5
150"	330x190	435 - 523	-8
200"	440x250	582 - 699	-11
310"	690x390	903 - 1084	-17

Unit: cm

16:10 Screen Size		①	②
		Minimum (Wide) to Maximum (Tele)	
33"	71x44	91 - 110	-4
35"	76x47	97 - 117	-4
40"	86x54	111 - 134	-5
50"	110x67	139 - 168	-6
60"	130x81	168 - 202	-7
80"	170x110	225 - 270	-10
100"	220x130	281 - 338	-12
150"	320x200	424 - 509	-18
200"	430x270	566 - 680	-24
320"	690x430	907 - 1089	-39

Projection Distance (For EB-S29/EB-S27)

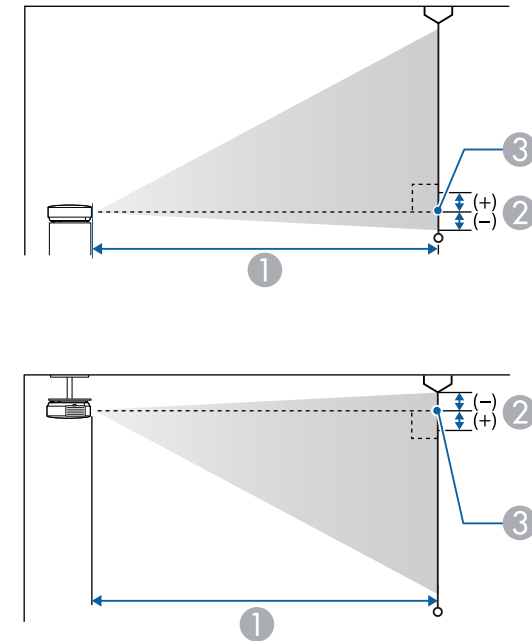

- ① Projection distance
- ② Distance from the center of the receiver's lens to the base of the screen (or to the top of the screen, if suspended from a ceiling)
- ③ Center of lens

Unit: cm

4:3 Screen Size		①	②
		Minimum (Wide) to Maximum (Tele)	Wide
30"	61x46	88 - 119	-5
50"	100x76	147 - 200	-8
60"	120x91	177 - 240	-10

4:3 Screen Size		①	②
		Minimum (Wide) to Maximum (Tele)	Wide
70"	142x107	207 - 280	-12
80"	160x120	237 - 321	-13
100"	200x150	297 - 401	-17
150"	300x230	446 - 603	-25
200"	410x300	595 - 805	-33

Unit: cm

16:9 Screen Size		①	②
		Minimum (Wide) to Maximum (Tele)	Wide
28"	62x35	89 - 121	1
30"	66x37	96 - 130	1
50"	110x62	161 - 218	1
60"	130x75	193 - 262	2
70"	155x87	226 - 306	2
80"	180x100	258 - 349	2
100"	220x120	323 - 437	3
150"	330x190	486 - 657	4
200"	440x250	649 - 877	5

Unit: cm

Projection Distance (For EB-965H/EB-945H)

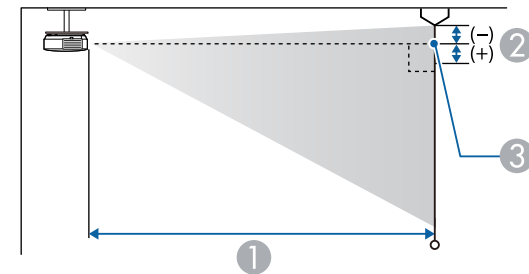
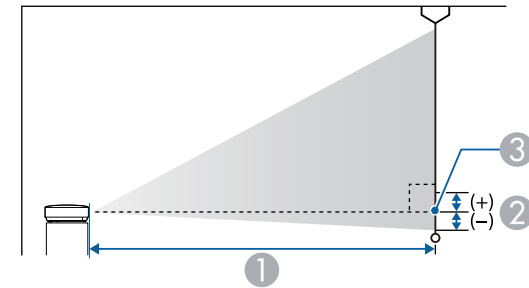

- ① Projection distance
- ② Distance from the center of the receiver's lens to the base of the screen (or to the top of the screen, if suspended from a ceiling)
- ③ Center of lens

4:3 Screen Size		①	②
		Minimum (Wide) to Maximum (Tele)	
30"	61x46	83 - 136	-5
40"	81x61	111 - 182	-6
50"	100x76	140 - 229	-8

4:3 Screen Size		①	
		Minimum (Wide) to Maximum (Tele)	
60"	120x91	169 - 275	
80"	160x120	226 - 368	
100"	200x150	283 - 460	
150"	300x230	426 - 692	
200"	410x300	568 - 923	
250"	510x380	711 - 1155	
300"	610x460	854 - 1386	

Unit: cm

16:9 Screen Size		①	
		Minimum (Wide) to Maximum (Tele)	
30"	66x37	91 - 149	
40"	89x50	122 - 199	
50"	110x62	153 - 249	
60"	130x75	184 - 300	
80"	180x100	246 - 401	
100"	220x120	308 - 502	
150"	330x190	464 - 754	
200"	440x250	619 - 1006	
250"	550x310	775 - 1258	
275"	610x340	853 - 1384	

Unit: cm

Projection Distance (For EB-955WH)

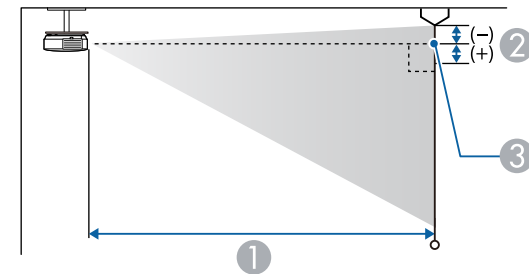
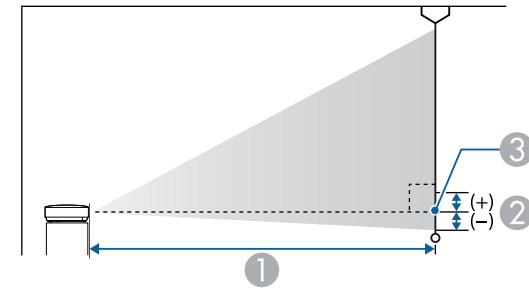

- ① Projection distance
- ② Distance from the center of the receiver's lens to the base of the screen (or to the top of the screen, if suspended from a ceiling)
- ③ Center of lens

4:3 Screen Size		①	
		Minimum (Wide) to Maximum (Tele)	
30"	61x46	100 - 164	
40"	81x61	134 - 219	
50"	100x76	169 - 275	

4:3 Screen Size		①	②
		Minimum (Wide) to Maximum (Tele)	
60"	120x91	203 - 331	-2
70"	142x107	237 - 386	-3
80"	160x120	271 - 442	-3
100"	200x150	340 - 553	-4
150"	300x230	511 - 831	-6
200"	410x300	682 - 1108	-8
240"	490x370	820 - 1330	-9

Unit: cm

16:9 Screen Size		①	②
		Minimum (Wide) to Maximum (Tele)	
32"	71x40	97 - 159	1
35"	78x44	106 - 174	1
40"	89x50	122 - 199	1
50"	110x62	153 - 249	2
60"	130x75	184 - 300	2
70"	155x87	215 - 350	2
80"	180x100	246 - 401	3
100"	220x120	308 - 502	3
150"	330x190	464 - 754	5
200"	440x250	619 - 1006	7
270"	600x340	837 - 1359	9

Unit: cm

16:10 Screen Size		①	②
		Minimum (Wide) to Maximum (Tele)	
33"	71x44	97 - 159	-1
35"	76x47	103 - 169	-1
40"	86x54	118 - 193	-1
50"	110x67	149 - 243	-2
60"	130x81	179 - 292	-2
80"	170x110	239 - 390	-3
100"	220x130	300 - 488	-3
150"	320x200	451 - 733	-5
200"	430x270	603 - 979	-7
280"	600x380	845 - 1371	-9

Projection Distance (For EB-950WH)

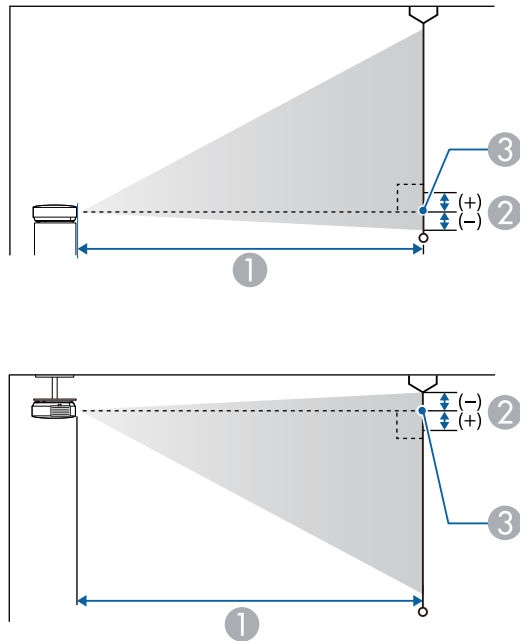

- ① Projection distance
- ② Distance from the center of the receiver's lens to the base of the screen (or to the top of the screen, if suspended from a ceiling)
- ③ Center of lens

Unit: cm

4:3 Screen Size		① Minimum (Wide) to Maximum (Tele)	②
30"	61x46	76 - 91	-4
40"	81x61	102 - 122	-6
50"	100x76	127 - 153	-7

4:3 Screen Size		① Minimum (Wide) to Maximum (Tele)	②
60"	120x91	153 - 184	-8
80"	160x120	205 - 246	-11
100"	200x150	256 - 308	-14
150"	300x230	385 - 462	-21
200"	410x300	514 - 617	-28
250"	510x380	643 - 771	-35
260"	530x400	668 - 802	-36

Unit: cm

16:9 Screen Size		① Minimum (Wide) to Maximum (Tele)	②
30"	66x37	69 - 83	-2
40"	89x50	92 - 111	-2
50"	110x62	115 - 139	-3
60"	130x75	139 - 167	-3
70"	155x87	162 - 195	-4
80"	180x100	186 - 223	-5
100"	220x120	232 - 279	-6
150"	330x190	349 - 419	-8
200"	440x250	466 - 560	-11
250"	550x310	583 - 700	-14
280"	620x350	653 - 784	-16

Unit: cm

16:10 Screen Size		①	②
		Minimum (Wide) to Maximum (Tele)	
30"	65x40	67 - 80	-4
35"	76x47	78 - 94	-4
40"	86x54	89 - 108	-5
50"	110x67	112 - 135	-6
60"	130x81	135 - 162	-7
80"	170x110	181 - 217	-10
100"	220x130	226 - 271	-12
150"	320x200	340 - 408	-18
200"	430x270	454 - 545	-24
300"	650x400	681 - 818	-37

Projection Distance (For EB-940H)

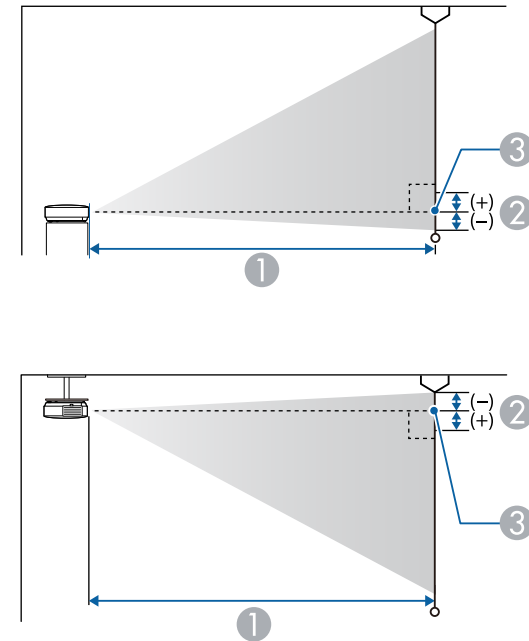

- ① Projection distance
- ② Distance from the center of the receiver's lens to the base of the screen (or to the top of the screen, if suspended from a ceiling)
- ③ Center of lens

Unit: cm

4:3 Screen Size		①	②
		Minimum (Wide) to Maximum (Tele)	
30"	61x46	72 - 86	-5
40"	81x61	96 - 116	-7
50"	100x76	120 - 145	-9

4:3 Screen Size		①	②
		Minimum (Wide) to Maximum (Tele)	
60"	120x91	145 - 174	-10
80"	160x120	194 - 233	-14
100"	200x150	242 - 291	-17
150"	300x230	364 - 438	-26
200"	410x300	486 - 584	-34
250"	510x380	608 - 730	-43
300"	610x460	730 - 877	-51

Unit: cm

16:9 Screen Size		①	②
		Minimum (Wide) to Maximum (Tele)	
30"	66x37	78 - 94	1
40"	89x50	105 - 126	1
50"	110x62	131 - 158	1
60"	130x75	158 - 190	1
70"	155x87	185 - 222	1
80"	180x100	211 - 254	2
100"	220x120	264 - 317	2
150"	330x190	397 - 477	3
200"	440x250	530 - 636	4
250"	550x310	663 - 796	5
275"	610x340	729 - 875	6

Supported Resolutions

Computer signals (analog RGB)

For EB-955WH/EB-950WH/EB-965H/EB-945H/EB-940H/EB-98H/EB-97H/
EB-W29/EB-X30/EB-X29/EB-X27

Signal	Refresh Rate (Hz)	Resolution (dots)
VGA	60/72/75/85	640x480
SVGA	56/60/72/75/85	800x600
XGA	60/70/75/85	1024x768
WXGA	60	1280x768
	60	1366x768
	60/75/85	1280x800
WXGA+	60/75/85	1440x900
WXGA++	60	1600x900
SXGA	70/75/85	1152x864
	60/75/85	1280x1024
	60/75/85	1280x960
SXGA+	60/75	1400x1050
WSXGA+*1,2	60	1680x1050
UXGA	60	1600x1200
MAC13"	67	640x480
MAC16"	75	832x624
MAC19"	75	1024x768
	59	1024x768
MAC21"	75	1152x870

*1 EB-955WH/EB-950WH/EB-W29 only.

*2 Only compatible when **Wide** is selected as the **Resolution** from the Configuration menu.

For EB-S29/EB-S27

Signal	Refresh Rate (Hz)	Resolution (dots)
VGA	60/72/75/85	640x480
SVGA	56/60/72/75/85	800x600
XGA	60/70/75/85	1024x768
WXGA	60	1280x768
	60	1366x768
	60/75	1280x800
WXGA+	60	1440x900
SXGA	70/75	1152x864
	60	1280x1024
	60	1280x960
SXGA+	60	1400x1050
MAC13"	67	640x480
MAC16"	75	832x624
MAC19"	75	1024x768
	59	1024x768
MAC21"	75	1152x870

Even when signals other than those mentioned above are input, it is likely that the image can be projected. However, not all functions may be supported.

Component video

Signal	Refresh Rate (Hz)	Resolution (dots)
SDTV (480i)	60	720x480
SDTV (576i)	50	720x576

Signal	Refresh Rate (Hz)	Resolution (dots)
SDTV (480p)	60	720x480
SDTV (576p)	50	720x576
HDTV (720p)	50/60	1280x720
HDTV (1080i)	50/60	1920x1080

Composite video

Signal	Refresh Rate (Hz)	Resolution (dots)
TV (NTSC)	60	720x480
TV (SECAM)	50	720x576
TV (PAL)	50/60	720x576

Input signal from the HDMI port

Signal	Refresh Rate (Hz)	Resolution (dots)
VGA	60	640x480
SVGA	60	800x600
XGA	60	1024x768
WXGA	60	1280x800
	60	1366x768
WXGA+	60	1440x900
WXGA++*1	60	1600x900
SXGA	60	1280x960
	60	1280x1024
SXGA+	60	1400x1050
UXGA*1	60	1600x1200
WSXGA+*2	60	1680x1050

Signal	Refresh Rate (Hz)	Resolution (dots)
SDTV (480i/480p)	60	720x480
SDTV (576i/576p)	50	720x576
HDTV (720p)	50/60	1280x720
HDTV (1080i)	50/60	1920x1080
HDTV (1080p)	24/30/50/60	1920x1080

*1 Except for EB-S29/EB-S27.

*2 EB-955WH/EB-950WH/EB-W29 only.

Input signal from the MHL port (EB-955WH/EB-950WH/EB-965H/EB-945H/EB-940H/EB-98H/EB-97H only)

Signal	Refresh Rate (Hz)	Resolution (dots)
VGA	60	640x480
SDTV (480i/480p)	60	720x480
SDTV (576i/576p)	50	720x576
HDTV (720p)	50/60	1280x720
HDTV (1080i)	50/60	1920x1080
HDTV (1080p)	24/30	1920x1080

Projector General Specifications

Product name		EB-940H/EB-98H/EB-97H	EB-950WH	EB-965H/EB-945H	EB-955WH
Dimensions		297 (W) x 89 (H) x 248 (D) mm		297 (W) x 89 (H) x 273 (D) mm	
LCD panel size		0.55"	0.59" Wide	0.63"	0.59" Wide
Display method		Polysilicon TFT active matrix			
Resolution		786,432 XGA (1024 (W) x 768 (H) dots)x 3	1,024,000 WXGA (1280 (W) x 800 (H) dots) x 3	786,432 XGA (1024 (W) x 768 (H) dots)x 3	1,024,000 WXGA (1280 (W) x 800 (H) dots) x 3
Focus adjustment		Manual			
Zoom adjustment		Manually (1-1.2)		Manually (1-1.6)	
Lamp		UHE lamp, 200 W Model No.: ELPLP88			
Max. audio output		16 W			
Speaker		1			
Power supply		100-240 V AC±10%, 50/60 Hz 3.0-1.4 A			
Power consumption	100 to 120 V area	Operating: 299 W Standby power consumption (Communication On): 2.3 W Standby power consumption (Communication Off): 0.21 W			
	220 to 240 V area	Operating: 287 W Standby power consumption (Communication On): 2.3 W Standby power consumption (Communication Off): 0.26 W			
Operating altitude		Altitude 0 to 3,000 m			
Operating temperature		+5 to +35°C (No condensation) (Altitude 0 to 2,286 m) +5 to +30°C (No condensation) (Altitude 2,287 to 3,000 m)			
Storage temperature		-10 to +60°C (No condensation)			
Mass		Approx. 2.7 kg		Approx. 2.9 kg	



Product name	EB-S29/EB-S27	EB-X29/EB-X27	EB-W29	EB-X30
Dimensions	297 (W) x 89 (H) x 244 (D) mm			
LCD panel size	0.55"	0.55"	0.59" Wide	0.63"
Display method	Polysilicon TFT active matrix			
Resolution	480,000 SVGA (800 (W) x 600 (H) dots) x 3	786,432 XGA (1024 (W) x 768 (H) dots)x 3	1,024,000 WXGA (1280 (W) x 800 (H) dots) x 3	786,432 XGA (1024 (W) x 768 (H) dots)x 3
Focus adjustment	Manual			
Zoom adjustment	Digital (1-1.35)	Manually (1-1.2)		
Lamp	UHE lamp, 200 W Model No.: ELPLP88			
Max. audio output	5 W			
Speaker	1			
Power supply	100-240 V AC±10%, 50/60 Hz 2.9-1.3A			
Power consumption	100 to 120 V area	Operating: 284 W Standby power consumption (Communication On): 2.3 W Standby power consumption (Communication Off): 0.21 W		
	220 to 240 V area	Operating: 273 W Standby power consumption (Communication On): 2.3 W Standby power consumption (Communication Off): 0.26 W		
Operating altitude	Altitude 0 to 3,000 m			
Operating temperature	+5 to +35°C (No condensation) (Altitude 0 to 2,286 m) +5 to +30°C (No condensation) (Altitude 2,287 to 3,000 m)			
Storage temperature	-10 to +60°C (No condensation)			
Mass	Approx. 2.5 kg	Approx. 2.6 kg		

Connectors	Computer1 port	1	Mini D-Sub15-pin (female)
	Computer2 port	1	
	Video port	1	RCA pin jack
	S-Video port	1	Mini DIN 4-pin
	Audio1 port	1	Stereo mini jack
	Audio2 port	1	
	Audio-L/R port	1	RCA pin jack x 2 (L-R)
	Mic port*1	1	Stereo mini jack
	Audio Out port	1	Stereo mini jack
	Monitor Out port	1	Mini D-Sub15-pin (female)
	HDMI port*2	1	HDMI (Audio is only supported by PCM)
	HDMI1 port*1	1	
	HDMI2/MHL port*1	1	
	USB-A port*3	1	USB connector (Type A)
	USB-B port*3, 4	1	USB connector (Type B)
	LAN Port*5	1	RJ-45
	RS-232C port	1	Mini D-Sub 9-pin (male)

*1 EB-955WH/EB-950WH/EB-965H/EB-945H/EB-940H/EB-98H/EB-97H only.

*2 EB-W29/EB-X30/EB-X29/EB-X27/EB-S29/EB-S27 only.

*3 Supports USB 2.0. However, USB ports are not guaranteed to operate all devices that support USB.

*4 USB 1.1 is not supported.

*5 EB-955WH/EB-950WH/EB-965H/EB-945H/EB-940H/EB-98H/EB-97H/EB-W29/EB-X30/EB-X29/EB-X27 only.

This product is also designed for IT power distribution system with phase-to-phase voltage 230V.

Angle of tilt

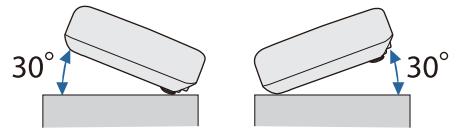

If you use the projector tilted at an angle of more than 30° it could be damaged and cause an accident.

DECLARATION of CONFORMITY

According to 47CFR, Part 2 and 15

Class B Personal Computers and Peripherals; and/or
CPU Boards and Power Supplies used with Class B Personal Computers

We: Epson America, Inc.
Located at: 3840 Kilroy Airport Way
MS: 3-13
Long Beach, CA 90806
Tel: 562-981-3840

Declare under sole responsibility that the product identified herein, complies with 47CFR Part 2 and 15 of the FCC rules as a Class B digital device. Each product marketed, is identical to the representative unit tested and found to be compliant with the standards. Records maintained continue to reflect the equipment being produced can be expected to be within the variation accepted, due to quantity production and testing on a statistical basis as required by 47CFR 2.909. Operation is subject to the following two conditions : (1) this device may not cause harmful interference, and (2) this device must accept any interference received, including interference that may cause undesired operation.

Trade Name: EPSON
Type of Product: LCD Projector
Model: H682C/H683C/H684C/H685C/H686C/H687C/
H688C/H689C/H690C/H691C/H692C/H693C/
H694C/H696C

**FCC Compliance Statement
For United States Users**

This equipment has been tested and found to comply with the limits for a Class B digital device, pursuant to Part 15 of the FCC Rules. These limits are designed to provide reasonable protection against harmful interference in a residential installation. This equipment generates, uses, and can radiate radio frequency energy and, if not installed and used in accordance with the instructions, may cause harmful interference to radio communications. However, there is no guarantee that interference will not occur in a particular installation. If this equipment does cause interference to radio and television reception, which can be determined by turning the equipment off and on, the user is encouraged to try to correct the interference by one or more of the following measures.

- Reorient or relocate the receiving antenna.
- Increase the separation between the equipment and receiver.
- Connect the equipment into an outlet on a circuit different from that to which the receiver is connected.
- Consult the dealer or an experienced radio/TV technician for help.

WARNING

The connection of a non-shielded equipment interface cable to this equipment will invalidate the FCC Certification or Declaration of this device and may cause interference levels which exceed the limits established by the FCC for this equipment. It is the responsibility of the user to obtain and use a shielded equipment interface cable with this device. If this equipment has more than one interface connector, do not leave cables connected to unused interfaces. Changes or modifications not expressly approved by the manufacturer could void the user's authority to operate the equipment.

EB-955WH/EB-965H/EB-945H

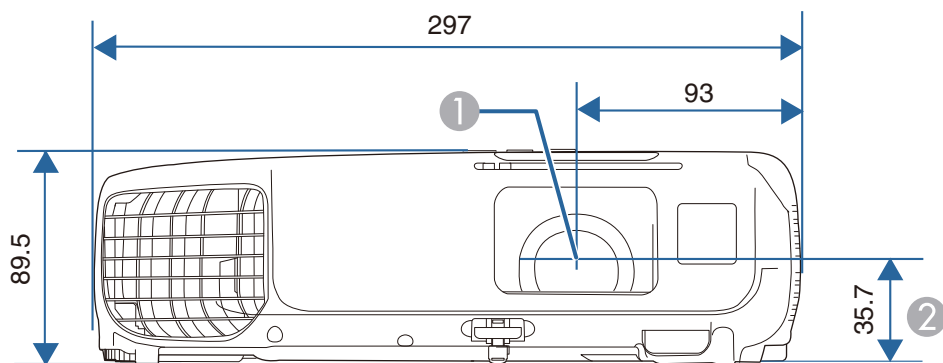

- ① Center of lens
- ② Distance from center of lens to suspension bracket fixing point

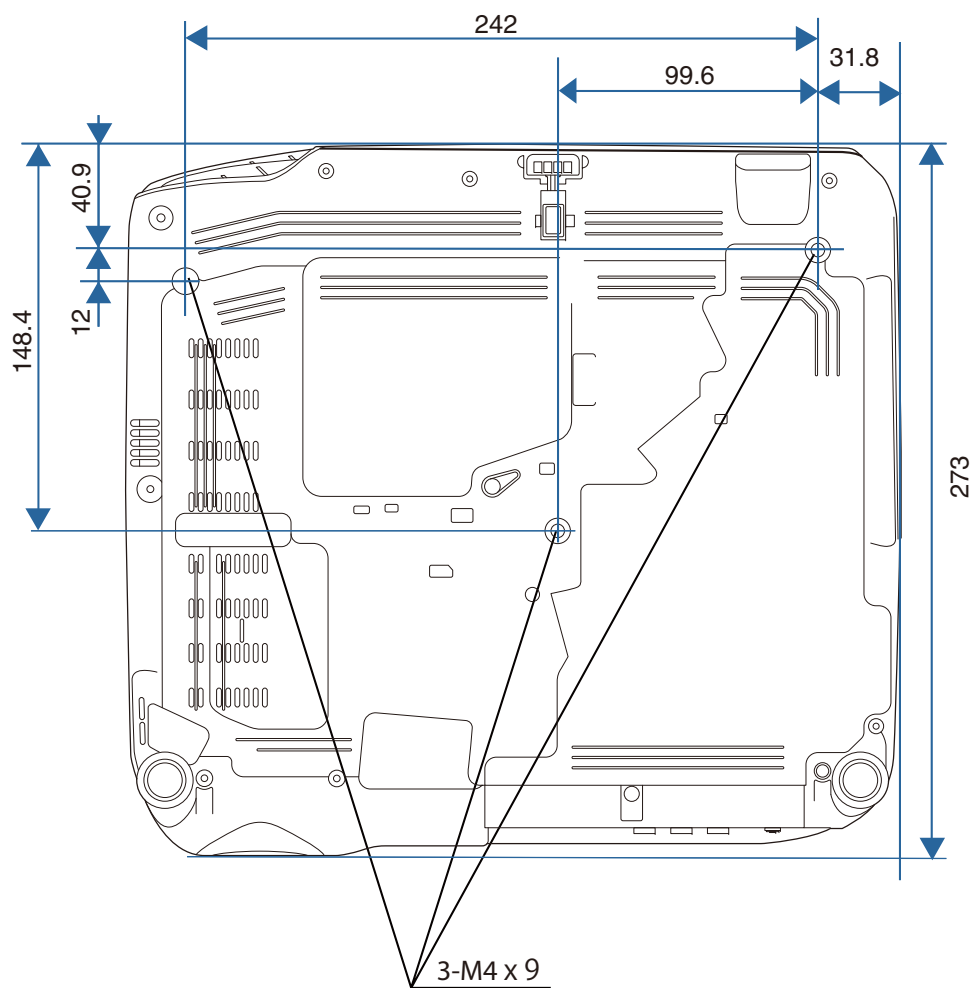

Units: mm

EB-950WH/EB-940H/EB-98H/EB-97H

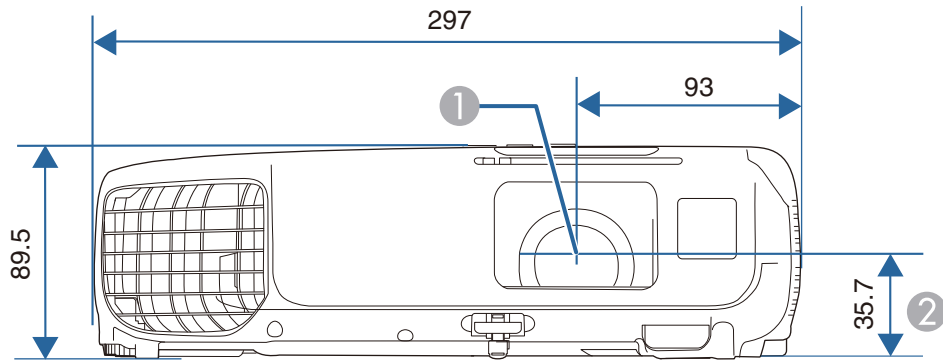

- ① Center of lens
- ② Distance from center of lens to suspension bracket fixing point

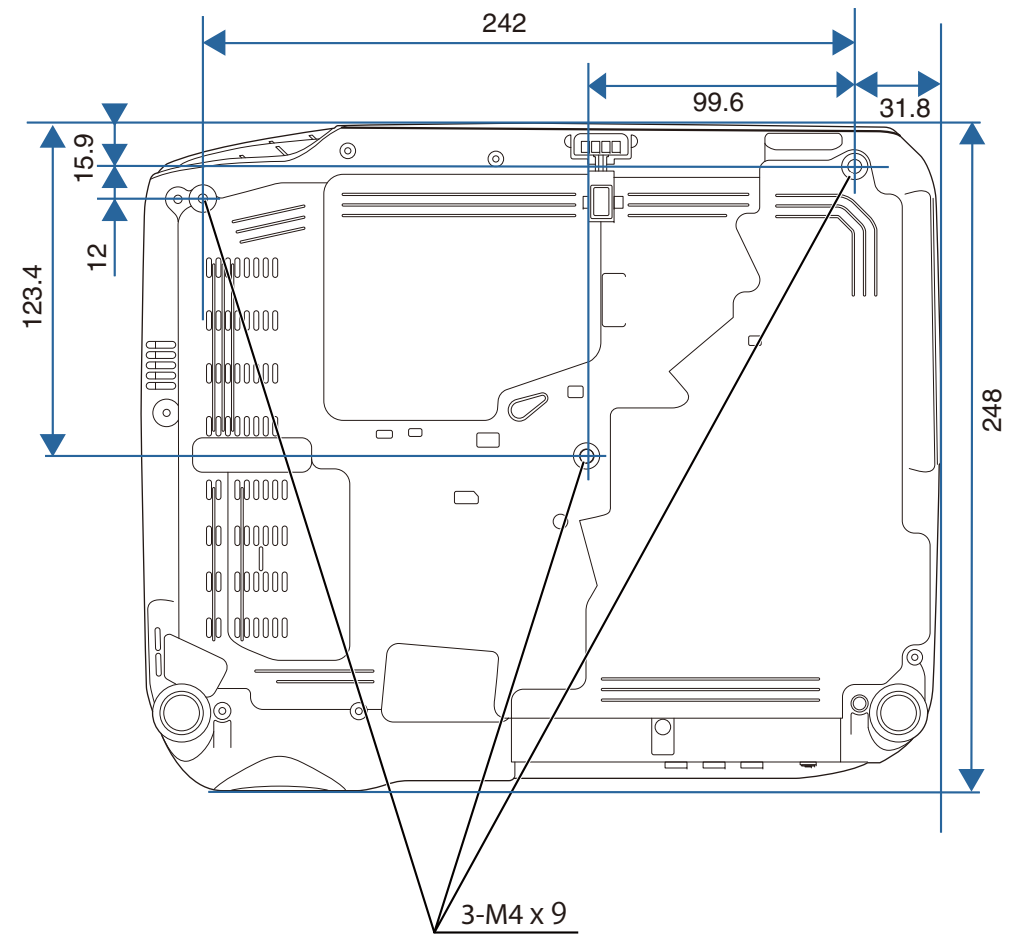

Units: mm

EB-W29/EB-X30/EB-X29/EB-X27/EB-S29/EB-S27

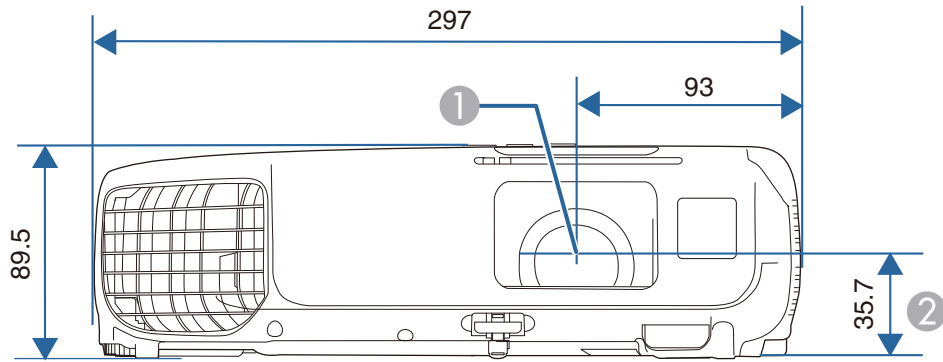

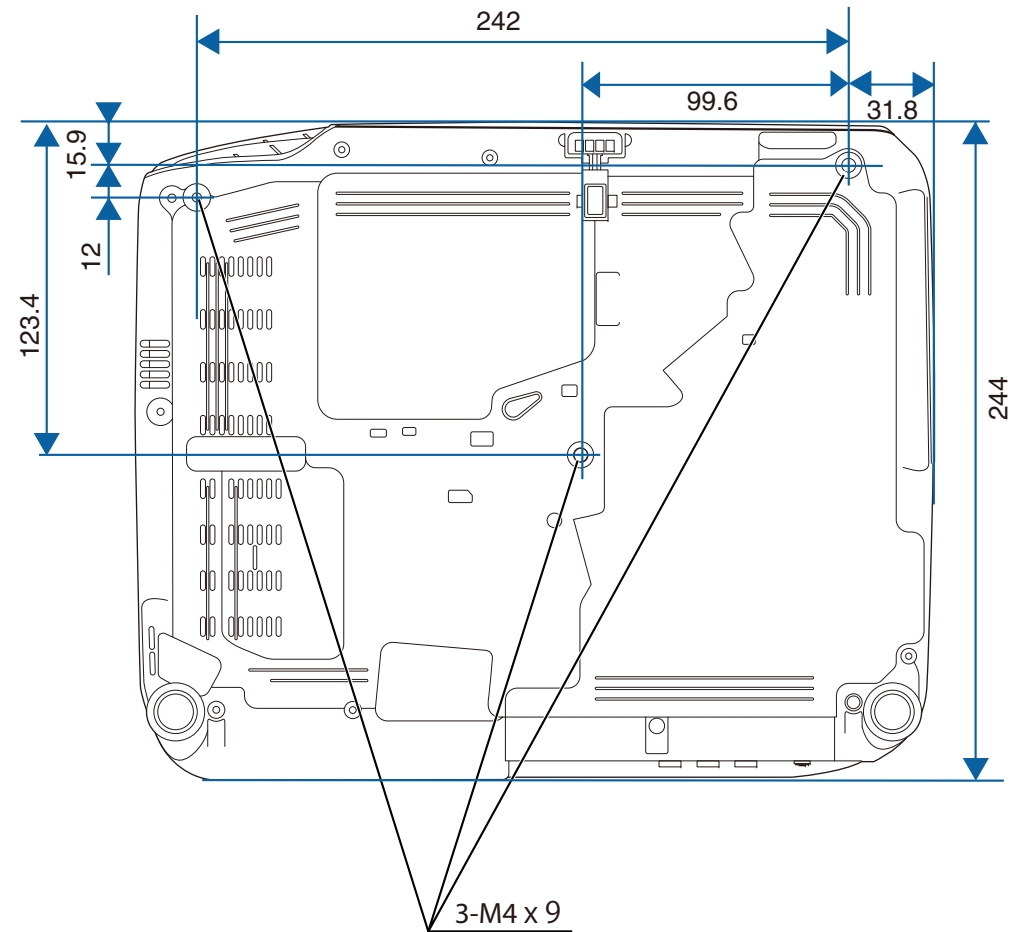

- ① Center of lens
- ② Distance from center of lens to suspension bracket fixing point



Units: mm

This section briefly explains the difficult terms that are not explained in the text of this guide. For details, refer to other commercially available publications.

Ad hoc mode	A method of wireless LAN connection that communicates with wireless LAN clients without using an access point.
AMX Device Discovery	AMX Device Discovery is a technology developed by AMX to facilitate AMX control systems for easy operation of the target equipment. Epson have implemented this protocol technology, and have provided a setting to enable the protocol function (ON). See the AMX Web site for more details.  http://www.amx.com/
Aspect Ratio	The ratio between an image's length and its height. Screens with a horizontal:vertical ratio of 16:9, such as HDTV screens, are known as wide screens. SDTV and general computer displays have an aspect ratio of 4:3.
Component Video	A method that separates the video signal into a luminance component (Y), and a blue minus luminance (Cb or Pb) and a red minus luminance (Cr or Pr).
Composite video	A method that combines the video signal into a luminance component and a color component for transmission down a single cable.
Contrast	The relative brightness of the light and dark areas of an image can be increased or decreased to make text and graphics stand out more clearly, or to make them appear softer. Adjusting this particular property of an image is called contrast adjustment.
Control4 Simple Device Discovery Protocol (SDDP)	Control4 SDDP is a technology developed by Control4 to allow Control4 control systems to acquire device information for the projector. Epson have implemented this protocol technology, and have provided a setting to enable the protocol function (ON). See the Control4 Web site for more details.  http://www.control4.com/
DHCP	An abbreviation of Dynamic Host Configuration Protocol, this protocol automatically assigns an IP address to equipment connected to a network.
Gateway Address	This is a server (router) for communicating across a network (subnet) divided according to subnet mask .
HDCP	HDCP is an abbreviation for High-bandwidth Digital Content Protection. It is used to prevent illegal copying and protect copyrights by encrypting digital signals sent over DVI and HDMI ports. Because the HDMI port on this projector supports HDCP, it can project digital images protected by HDCP technology. However, the projector may not be able to project images protected with updated or revised versions of HDCP encryption.
HDTV	An abbreviation for High-Definition Television that refers to high-definition systems which satisfy the following conditions. <ul style="list-style-type: none"> • Vertical resolution of 720p or 1080i or greater (p = Progressive, i = Interlace) • Screen aspect ratio of 16:9
Infrastructure mode	A method for wireless LAN connection in which devices communicate through access points.
Interlace	Transmits information needed to create one screen by sending every other line, starting from the top of the image and working down to the bottom. Images are more likely to flicker because one frame is displayed every other line.
IP Address	A number to identify a computer connected to a network.
MHL	An abbreviation for Mobile High-definition Link, a standard for connection interfaces aimed at mobile devices such as smartphones and tablets. Images can be transferred at high quality and at high speeds without compressing the digital signal, and also charges connected devices.

Progressive	Projects information to create one screen at a time, displaying the image for one frame. Even though the number of scan lines is the same, the amount of flicker in images decreases because the volume of information has doubled compared with an interlace system.
Refresh Rate	The light-emitting element of a display maintains the same luminosity and color for an extremely short time. Because of this, the image must be scanned many times per second to refresh the light-emitting element. The number of refresh operations per second is called the Refresh Rate and is expressed in hertz (Hz).
SDTV	An abbreviation for Standard Definition Television that refers to standard television systems which do not satisfy the conditions for HDTV ▶ High-Definition Television.
SNMP	An abbreviation for Simple Network Management Protocol, which is the protocol for monitoring and controlling devices such as routers and computers connected to a TCP/IP network.
sRGB	An international standard for color intervals that was formulated so that colors that are reproduced by video equipment can be handled easily by computer operating systems (OS) and the Internet. If the connected source has an sRGB mode, set both the projector and the connected signal source to sRGB.
SSID	SSID is identification data for connecting to another device on a wireless LAN. Wireless communication is possible between devices with the same SSID.
Subnet Mask	This is a numerical value that defines the number of bits used for the network address on a divided network (subnet) from the IP address.
SVGA	A screen size standard with a resolution of 800 (horizontal) x 600 (vertical) dots.
S-Video	A method that separates the video signal into a luminance component (Y) and a color component (C).
SXGA	A screen size standard with a resolution of 1,280 (horizontal) x 1,024 (vertical) dots.
Sync.	The signals output from computers have a specific frequency. If the projector frequency does not match this frequency, the resulting images are not of a good quality. The process of matching the phases of these signals (the relative position of the crests and the troughs in the signal) is called Synchronization. If the signals are not synchronized, flickering, blurriness, and horizontal interference occur.
Tracking	The signals output from computers have a specific frequency. If the projector frequency does not match this frequency, the resulting images are not of a good quality. The process of matching the frequency of these signals (the number of crests in the signal) is called Tracking. If Tracking is not carried out correctly, wide vertical stripes appear in the signal.
Trap IP Address	This is the IP address ▶ for the destination computer used for error notification in SNMP.
VGA	A screen size standard with a resolution of 640 (horizontal) x 480 (vertical) dots.
XGA	A screen size standard with a resolution of 1,024 (horizontal) x 768 (vertical) dots.

All rights reserved. No part of this publication may be reproduced, stored in a retrieval system, or transmitted in any form or by any means, electronic, mechanical, photocopying, recording, or otherwise, without the prior written permission of Seiko Epson Corporation. No patent liability is assumed with respect to the use of the information contained herein. Neither is any liability assumed for damages resulting from the use of the information contained herein.

Neither Seiko Epson Corporation nor its affiliates shall be liable to the purchaser of this product or third parties for damages, losses, costs, or expenses incurred by the purchaser or third parties as a result of: accident, misuse, or abuse of this product or unauthorized modifications, repairs, or alterations to this product, or (excluding the U.S.) failure to strictly comply with Seiko Epson Corporation's operating and maintenance instructions.

Seiko Epson Corporation shall not be liable against any damages or problems arising from the use of any options or any consumable products other than those designated as Original Epson Products or Epson Approved Products by Seiko Epson Corporation.

The contents of this guide may be changed or updated without further notice.

Illustrations in this guide and the actual projector may differ.

Restriction of Use

When this product is used for applications requiring high reliability/safety such as transportation devices related to aviation, rail, marine, automotive etc.; disaster prevention devices; various safety devices etc; or functional/precision devices etc, you should use this product only after giving consideration to including fail-safes and redundancies into your design to maintain safety and total system reliability. Because this product was not intended for use in applications requiring extremely high reliability/safety such as aerospace equipment, main communication equipment, nuclear power control equipment, or medical equipment related to direct medical care etc, please make your own judgment on this product's suitability after a full evaluation.

About Notations

Microsoft® Windows® 2000 operating system
Microsoft® Windows® XP operating system
Microsoft® Windows Vista® operating system
Microsoft® Windows® 7 operating system
Microsoft® Windows® 8 operating system
Microsoft® Windows® 8.1 operating system

In this guide, the operating systems above are referred to as "Windows 2000", "Windows XP", "Windows Vista", "Windows 7", "Windows 8", and "Windows 8.1". Furthermore, the collective term Windows may be used to refer to Windows 2000, Windows XP, Windows Vista, Windows 7, Windows 8, and Windows 8.1, and multiple versions of Windows may be referred to as, for example, Windows 2000/XP/Vista/7/8/8.1, with the Windows notation omitted.

Mac OS X 10.3.x
Mac OS X 10.4.x
Mac OS X 10.5.x
Mac OS X 10.6.x
OS X 10.7.x
OS X 10.8.x
OS X 10.9.x

In this guide, the operating systems above are referred to as "Mac OS X 10.3.9", "Mac OS X 10.4.x", "Mac OS X 10.5.x", "Mac OS X 10.6.x", "OS X 10.7.x", "OS X 10.8.x", and "OS X 10.9.x". Furthermore, the collective term "OS X" is used to refer to them all.

General Notice:

EPSON is a registered trademark, EXCEED YOUR VISION, ELPLP and their logos are registered trademarks or trademarks of Seiko Epson Corporation.

Mac, Mac OS, and OS X, are trademarks of Apple Inc.

App Store is a service mark of Apple Inc.

Google play is a trademark of Google Inc.

Microsoft, Windows, Windows Vista, PowerPoint, and Windows logo are trademarks or registered trademarks of Microsoft Corporation in the United States and/or other countries.

WPA™ and WPA2™ are registered trademarks of Wi-Fi Alliance.

HDMI and High-Definition Multimedia Interface are the trademarks or registered trademarks of HDMI Licensing LLC. 

MHL, the MHL logo, and Mobile High-Definition Link are the trademarks or registered trademarks of MHL and LLC in the United States and/or other countries.

Crestron and Crestron RoomView are registered trademarks of Crestron Electronics, Inc.

"QR Code" is a registered trademark of DENSO WAVE INCORPORATED.

PJLink trademark is a trademark applied for registration or is already registered in Japan, the United States of America and other countries and areas.

All other trademarks are the property of their respective owners and used for identification purpose only.

©SEIKO EPSON CORPORATION 2014. All rights reserved.

Indication of the manufacturer and the importer in accordance with requirements of directive 2011/65/EU (RoHS)

Manufacturer: SEIKO EPSON CORPORATION

Address: 3-5, Owa 3-chome, Suwa-shi, Nagano-ken 392-8502 Japan

Telephone: 81-266-52-3131

Importer: SEIKO EUROPE B.V.

Address: Azië building, Atlas ArenA, Hoogoorddreef 5, 1101 BA Amsterdam Zuidoost The Netherlands

Telephone: 31-20-314-5000

A

A/V Mute	71
A/V Mute Timer	118
A/V Settings	108
Air exhaust vent	13
Air filter replacement period	151
AMX Device Discovery	116
Aspect	55, 104
Audio1 port	15
Audio2 port	15
Audio-L/R port	14
Auto Iris	54, 103
Auto Setup	103
Auto V-Keystone	105

B

Basic menu	110
Blackboard	53
Bonjour	116
Brightness	102

C

Ceiling	24, 107
Ceiling mount fixing points	16
Cleaning	146
Cleaning the air filter and air intake vent	146
Cleaning the projector's surface	146
Color Adjustment	103
Color Mode	53, 102
Color Saturation	102
Color Temp.	103
Computer port	15

Configuration menu	99
Connection mode	111
Consumables	154
Continuous play	68
Contrast	102
Control panel	17
Control Panel Lock	85, 105
Crestron RoomView	93
Cross	74

D

DHCP	114
Direct Power On	107
Display	107
Display Background	107
Display order	68
Display settings	68
Document Camera	154
Dynamic	53

E

EasyMP Monitor	87
ECO Display	118
ECO menu	117
Email Address	115
ESC/VP21	90
Extended menu	106
E-Zoom	73

F

Flip Horizontal	9, 68
Focus ring	13
Foot adjust lever	13

Freeze	72
Front	24, 107
Front adjustable foot	13
Full Lock	84

G

Gateway Address	112, 114
-----------------------	----------

H

HDMI port	15
HDMI Video Range	104
HDMI2/MHL port	15
Help function	128
High Altitude Mode	107
H-Keystone adjuster	48
Horizontal keystone adjuster	8, 48
How to replace the air filter	151
How to replace the lamp	148

I

ID (projector)	76
ID (remote control)	77
Image menu	102
Indicators	130
Info menu	118
Input Signal	104, 119
IP Address	115

K

Keystone	105
----------------	-----

L

Lamp cover	13
Lamp hours	117
Lamp indicator	130
Lamp replacement period	148
LAN port	15
Language	108
Lens Cover Timer	118
Light Optimizer	117

M

Mail Notification	89, 115
Mail Notification menu	115
Message Broadcasting	87, 116
Messages	107
Microphone input port	14
Monitor Displays	165
Mouse pointer	74

N

Network Configuration	109
Network information	109
Network Menu	108
Network Protection	82
Noise Reduction	104

O

Operating temperature	167, 168
Operation	107
Optional accessories	154
Overheating	131

P

Part names and functions	12
Password Protect Sticker	83
Password protection	82
Pattern	106
PC Free	64, 67
PJLink	92
PJLink Password	110
Pointer	72
Pointer shape	105
Port Number	115
Position	103
Power indicator	130
Power inlet	14
Power On Protection	82
Presentation	53, 63
Problem solving	130
Progressive	104
Projection	107
Projection distance	155
Projector	39, 40
Projector ID	77
Projector Info	119
Projector keyword	111
Projector Name	110
Projector Setup	87

Q

Quick Corner	105
Quick Wireless Connection USB Key	154

R

Reading Mail	89
Rear	24, 107
Rear feet	17
Rear screen	24
Refresh	113
Refresh Rate	119
Remote control	18
Remote receiver	13, 15
Replacing batteries	21
Reset all	119
Reset menu	117, 119
Resetting the lamp operating time ..	119, 151
Resolution	119
Rotating images	65
RS-232C	14

S

Screen size	155
Screen switching time	68
Security menu	113
Select Drive	64
Settings menu	105
Sharpness	102
Signal menu	103
Sleep Mode	118
Sleep Mode Timer	118
SMTP Server	115
SNMP	90
Soft keyboard	109
Source Search	17, 41
Speaker	15
Specifications	167

sRGB	53
SSID	112
Standby Mode	118
Startup Screen	107
Storage temperature	167, 168
Subnet Mask	112, 114
Supported Monitor Displays	165
S-Video Port	14
Sync Info	119
Sync.	103

T

Temp indicator	130
Theatre	53
Tint	102
Tracking	103

U

USB-A port	15
USB-B port	15
User button	106
User Pattern	80
User's Logo	78
User's Logo Protection	82

V

Version	119
Video Port	14
Video Signal	104, 119
Volume	105
Volume buttons	18

W

Web Browser	87
Web Control	88
Web Control Password	111
Web Remote	88
Wired LAN menu	114
Wireless LAN menu	111
Wireless LAN unit	154
Wireless mouse function	74

Z

Zoom	105
Zoom ring	13

Free Manuals Download Website

<http://myh66.com>

<http://usermanuals.us>

<http://www.somanuals.com>

<http://www.4manuals.cc>

<http://www.manual-lib.com>

<http://www.404manual.com>

<http://www.luxmanual.com>

<http://aubethermostatmanual.com>

Golf course search by state

<http://golfingnear.com>

Email search by domain

<http://emailbydomain.com>

Auto manuals search

<http://auto.somanuals.com>

TV manuals search

<http://tv.somanuals.com>