

Multimedia Projector

EB-U32 EB-S04
EB-W32 EB-U130
EB-W31 EB-W130
EB-X36 EB-X130
EB-X31 EB-S130
EB-S31 EB-X350
EB-U04 EB-X300
EB-W04 EB-S300
EB-X04

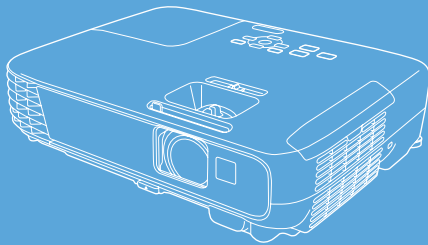

EN	Quick Start Guide	LV	Ātrās darba uzsākšanas pamācība
DE	Kurzanleitung	LT	Trumpas pradžios vadovas
FR	Guide de démarrage rapide	EL	Οδηγός γρήγορης εκκίνησης
IT	Guida di avvio rapido	TR	Hızlı Başlangıç Kılavuzu
ES	Guía de inicio rápido	SL	Priročnik za hitri zagon
PT	Guia de Referência Rápida	HR	Kratke upute
NL	Introductiehandleiding	MK	Прирачник брз почеток
DA	Introduktion	SR	Uputstvo za brz početak
FI	Pika-aloitusopas	CA	Guia d'inici ràpid
NO	Hurtigveiledning	RU	Руководство по быстрой установке
SV	Snabbstartsguide	UK	Коротка інструкція "Початок роботи"
CS	Úvodní příručka	KK	Қысқа іске қосу нұсқаулығы
HU	Bevezetés	KO	빠른 시작 가이드
PL	Przewodnik szybkiego startu	AR	دليل البداية السريعة
SK	Stručná príručka	FA	راهنمای سریع برای شروع بکار
BG	Ръководство за бърз старт	HE	מדריך להפעלה מהירה
RO	Ghid de pornire rapidă	ZHS	設定手冊
ET	Lühijuhend	ZHT	設定説明書

1

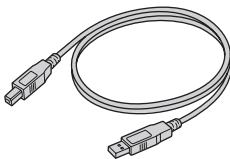
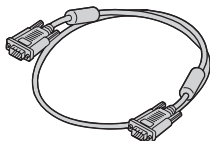
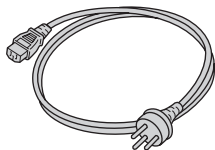
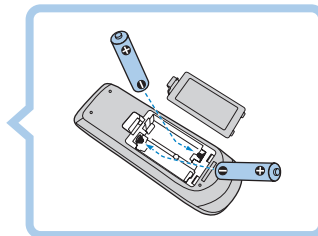
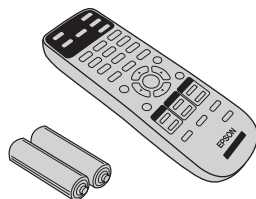
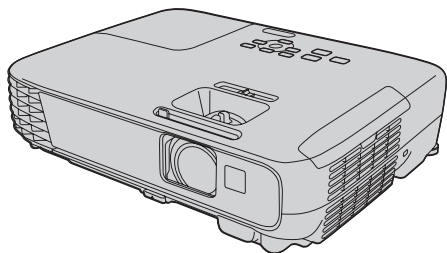

EB-U32/W32/W31/X36
/X31/S31 only

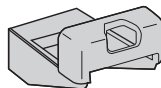
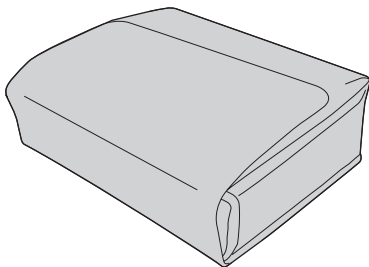
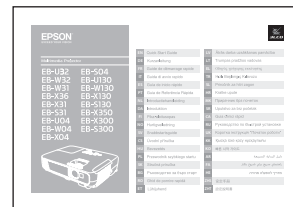

EB-W31/X36/X31/S31/W04
/X04/S04/W130/X130/S130
/X350/X300/S300 only



EB-W130/X130 only



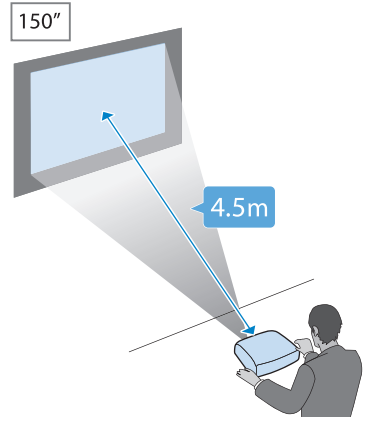
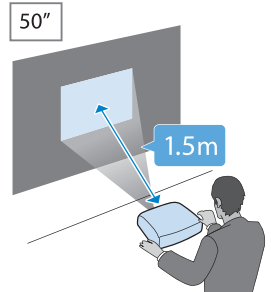
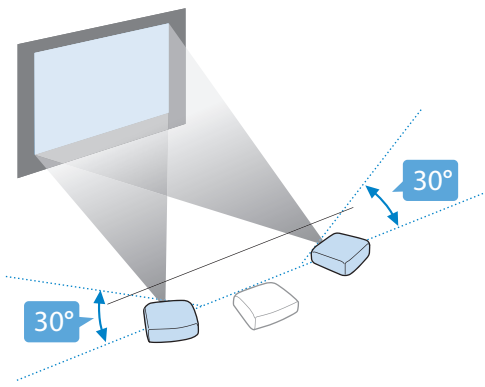
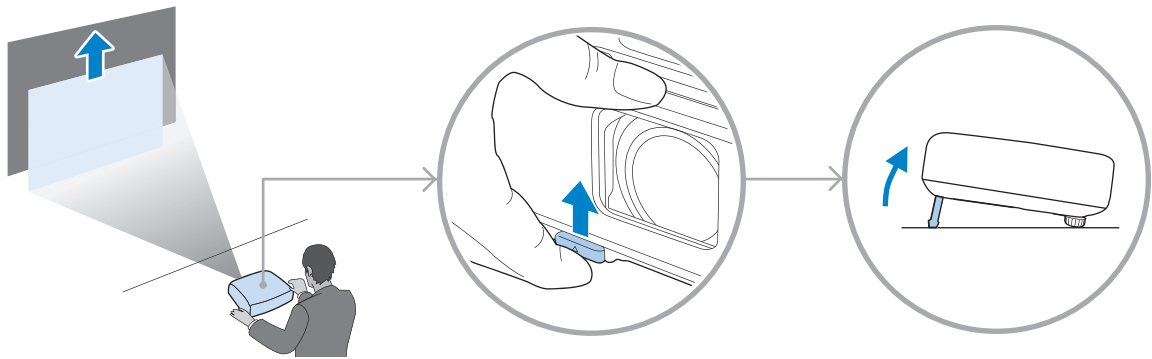

3

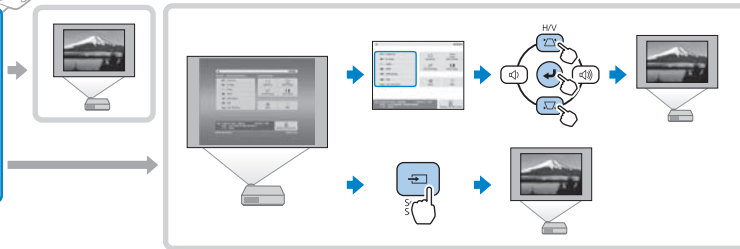
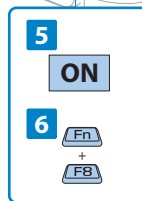
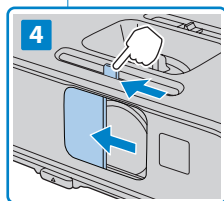
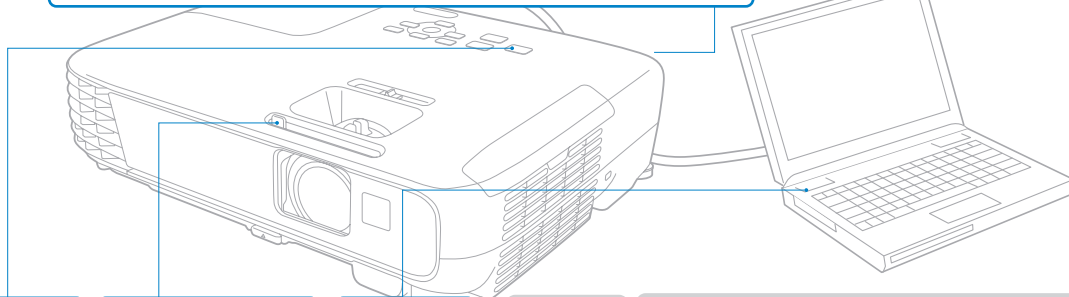
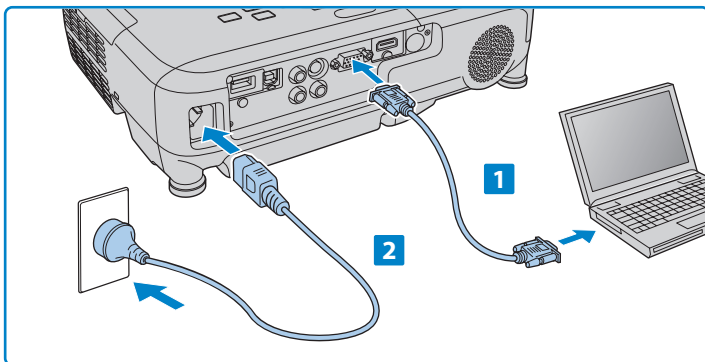



EB-U32/W32/W31/X36/X31/U04
/W04/X04/U130/W130/X130
/X350/X300

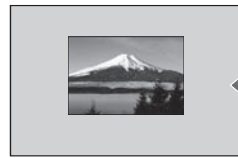
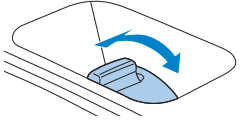
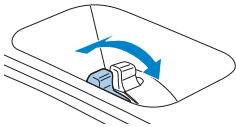

◀ T W ▶

EB-U32/W32/W31/X36/X31/U04
/W04/X04/U130/W130/X130
/X350/X300

EB-S31/S04/S130/S300

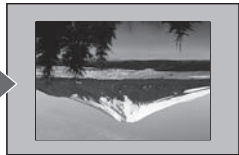
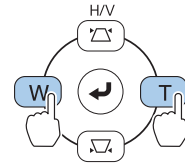
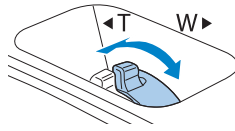

5 Sec.

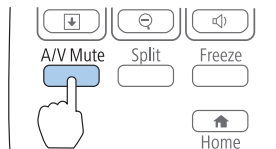

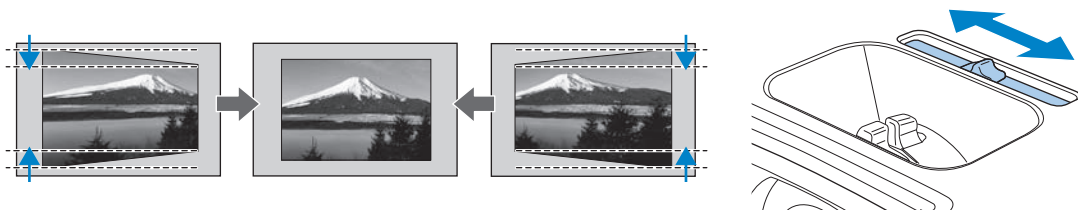

1

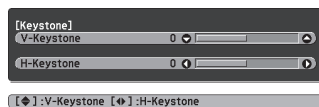
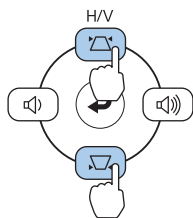

2

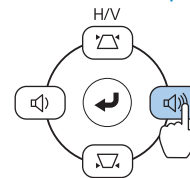
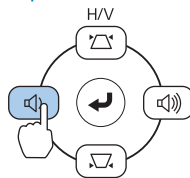
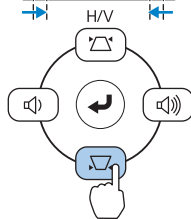
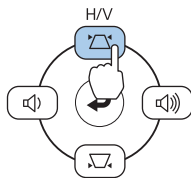

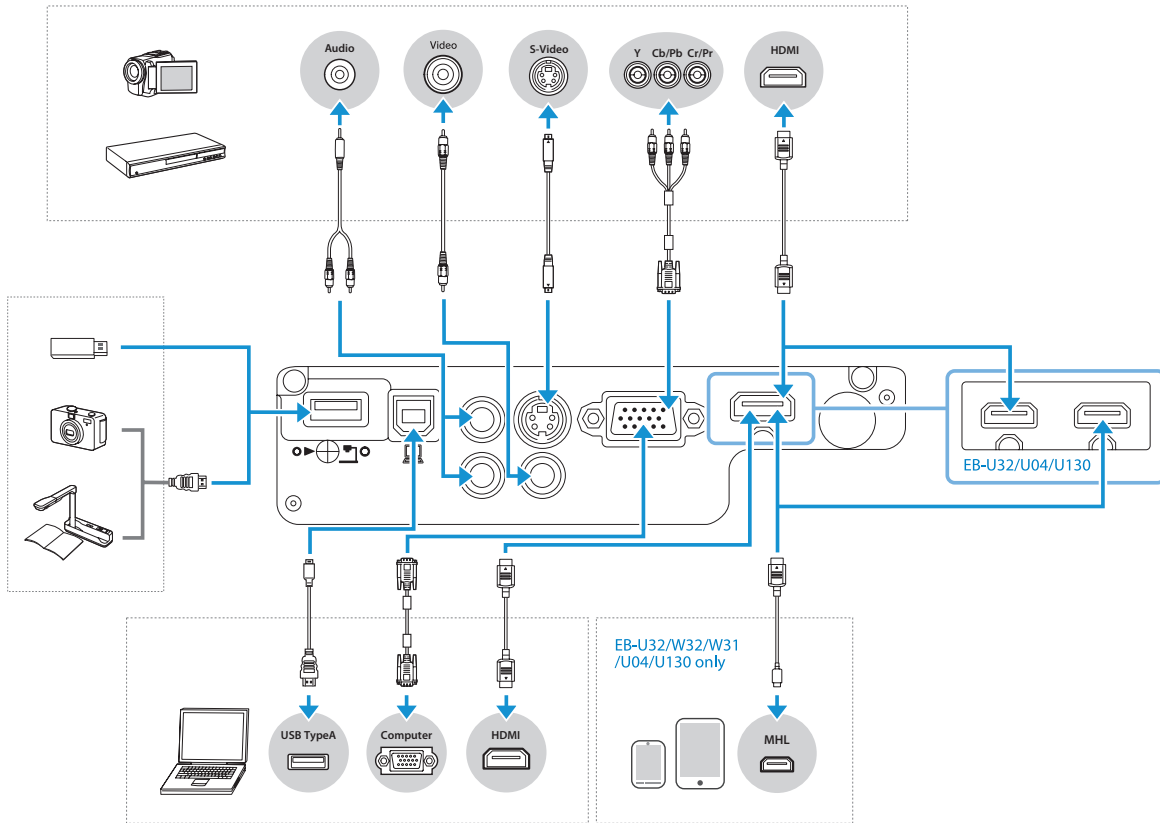

EB-W32/W31/W04/W130

Units: cm

4:3 XGA			
A	B	① Minimum (Wide) to Maximum(Tele)	②
29"	59 x 44	90 - 109	-4
60"	122 x 91	190 - 229	-8
80"	163 x 122	255 - 306	-11
100"	203 x 152	319 - 383	-14
150"	305 x 229	480 - 577	-20
280"	569 x 427	898 - 1079	-38

16:9 Widescreen			
A	B	① Minimum (Wide) to Maximum(Tele)	②
32"	71 x 40	91 - 109	-2
60"	133 x 75	172 - 208	-3
80"	177 x 100	231 - 278	-4
100"	221 x 125	289 - 348	-5
150"	332 x 187	435 - 523	-8
310"	686 x 386	903 - 1084	-17

16:10 WXGA			
A	B	① Minimum (Wide) to Maximum(Tele)	②
33"	71 x 44	91 - 110	-4
60"	129 x 81	168 - 202	-7
80"	172 x 108	225 - 270	-10
100"	215 x 135	281 - 338	-12
150"	323 x 202	424 - 509	-18
320"	689 x 431	907 - 1089	-39

EB-X36

Units: cm

4:3 XGA			
A	B	① Minimum (Wide) to Maximum(Tele)	②
30"	61 x 46	84 - 101	-5
60"	122 x 91	171 - 206	-10
80"	163 x 122	229 - 275	-13
100"	203 x 152	287 - 345	-16
150"	305 x 229	432 - 519	-24
300"	610 x 457	867 - 1041	-48

16:9 Widescreen			
A	B	① Minimum (Wide) to Maximum(Tele)	②
28"	62 x 35	85 - 103	1
60"	133 x 75	186 - 224	2
80"	177 x 100	249 - 300	3
100"	221 x 125	313 - 376	3
150"	332 x 187	471 - 566	5
275"	609 x 342	866 - 1040	10

EB-X31/X04/X130/X350/X300

Units: cm

4:3 XGA			
A	B	① Minimum (Wide) to Maximum(Tele)	②
30"	61 x 46	89 - 107	-5
60"	122 x 91	180 - 217	-10
80"	163 x 122	241 - 290	-14
100"	203 x 152	302 - 363	-17
150"	305 x 229	454 - 546	-25
300"	610 x 457	912 - 1095	-51

16:9 Widescreen			
A	B	① Minimum (Wide) to Maximum(Tele)	②
28"	62 x 35	90 - 109	1
60"	133 x 75	196 - 236	1
80"	177 x 100	263 - 316	2
100"	221 x 125	329 - 396	2
150"	332 x 187	495 - 595	3
275"	609 x 342	910 - 1093	6

EB-S31/S04/S130/S300

Units: cm

4:3 XGA			
A	B	① Minimum (Wide) to Maximum(Tele)	② Minimum (Wide)
30"	61 x 46	88 - 119	-5
60"	122 x 91	177 - 240	-10
80"	163 x 122	237 - 321	-13
100"	203 x 152	297 - 401	-17
150"	305 x 229	446 - 603	-25
200"	406 x 305	595 - 805	-33

16:9 Widescreen			
A	B	① Minimum (Wide) to Maximum(Tele)	② Minimum (Wide)
28"	62 x 35	89 - 121	1
60"	133 x 75	193 - 262	2
80"	177 x 100	258 - 349	2
100"	221 x 125	323 - 437	3
150"	332 x 187	486 - 657	4
200"	443 x 249	649 - 877	5

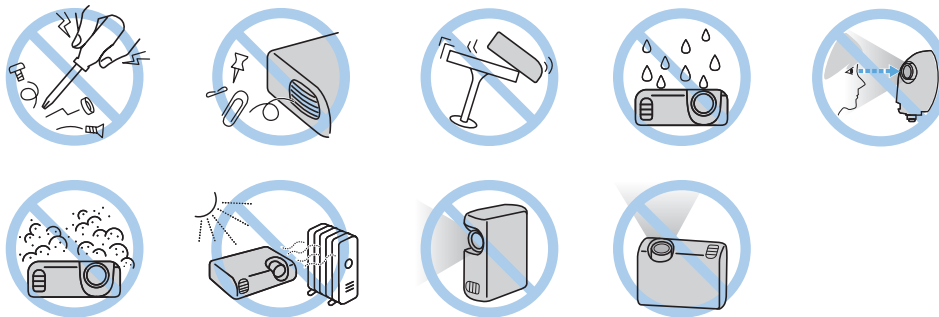
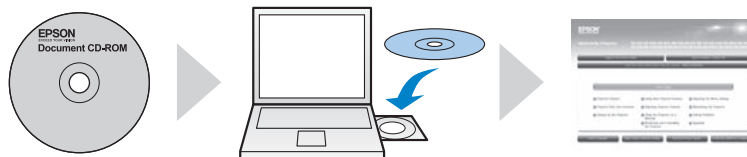

Printed in China
XX.XX-XX(XXX)



412877800

Free Manuals Download Website

<http://myh66.com>

<http://usermanuals.us>

<http://www.somanuals.com>

<http://www.4manuals.cc>

<http://www.manual-lib.com>

<http://www.404manual.com>

<http://www.luxmanual.com>

<http://aubethermostatmanual.com>

Golf course search by state

<http://golfingnear.com>

Email search by domain

<http://emailbydomain.com>

Auto manuals search

<http://auto.somanuals.com>

TV manuals search

<http://tv.somanuals.com>