

User's Guide

EH-TW5350
EH-TW5300
EH-TW5210

Home Projector



Using Each Guide

The guides for this projector are organized as shown below.

Safety Instructions/Support and Service Guide

Contains information on using the projector safely, as well as a support and service guide, troubleshooting check lists, and so on. Make sure you read this guide before using the projector.



User's Guide (this guide)

Contains information on setting up and basic operations before using the projector, using the Configuration menu, and handling problems and performing routine maintenance.



Quick Start Guide

Contains information on the procedures for setting up the projector. Read this first.

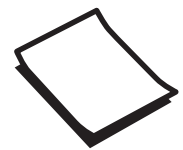



Notations Used in This Guide

Safety Indications

The documentation and the projector use graphical symbols to show how to use the projector safely. The following shows the symbols and their meanings. Please understand and respect these caution symbols in order to avoid injury to persons or property.

 **Warning**

This symbol indicates information that, if ignored, could possibly result in personal injury or even death due to incorrect handling.



 **Caution**

This symbol indicates information that, if ignored, could possibly result in personal injury or physical damage due to incorrect handling.

General Information Indications

Attention

Indicates procedures which may result in damage or malfunctions to occur.

	Indicates additional information and points which may be useful to know regarding a topic.
	Indicates a page where detailed information regarding a topic can be found.
Menu Name	Indicates Configuration menu items. Example: Image - Color Mode
Button Name	Indicates the buttons on the remote control or the control panel. Example:  button

About the Use of "This Product" or "This Projector"

As well as the main projector unit, supplied items or optional extras may be referred to using the phrase "this product" or "this projector".

Organization of the Guide and Notations in the Guide

Using Each Guide	1
Notations Used in This Guide	2
Safety Indications	2
General Information Indications	2
About the Use of "This Product" or "This Projector"	2

Introduction

Projector Features	6
Dynamic 3D Display	6
Project Images from Mobile Devices	6
Quick and Easy to Install, Use, and Remove	6
Quick Image Adjustments	6
Other Useful Functions	6

Part Names and Functions	8
Front/Top	8
Control Panel	9
Remote Control	11
Rear	13
Base	13

Preparing

Installing	15
Projected Image and Position of Projector	15
Installing in parallel with the screen	15
Installing the projector horizontally by adjusting the height of either side	15
Various Setting Methods	16
Placing on a table and projecting	16
Suspending from the ceiling and projecting ..	16
Adjusting the Projection Size	17

Connecting a Device	19
Connecting Video Equipment	19
Connecting a Computer	19
Connecting Smartphones or Tablets	20
Connecting USB Devices	20
Connecting External Speakers	21
Connecting Bluetooth® Devices	21

Preparing the Remote Control	24
Installing the Remote Control Batteries	24
Remote Control Operating Range	25
Operating range (left to right)	25
Operating range (top to bottom)	25

Basic Operations

Projecting Images	26
Turning On the Projector	26
If the target image is not projected	26
Using the Home Screen	27
Turning Off	28

Adjusting the Projected Image	29
Displaying the Test Pattern	29
Adjusting the Focus	29
Adjusting the Projection Size	29
Adjust the Height of the Image	29
Adjusting the Projector's Tilt	30
Correcting Distortion	30
Correct automatically (Auto V-Keystone) (EH-TW5350/EH-TW5300 only)	30
Correct manually (H-Keystone adjuster)	31
Correct manually (H/V-Keystone)	31
Adjusting the Volume	32
Hiding the Image and Muting the Audio Temporarily (A/V Mute)	32

Adjusting the Image

Adjusting the Image	33
Selecting the Projection Quality (Color Mode) ..	33
Switching the Screen Between Full and Zoom (Aspect)	34
Adjusting the Sharpness	35
Adjusting Image Resolution (Image Enhancement)	35
Setting Auto Iris	36
Setting Frame Interpolation	36
Adjusting the Color	37
Adjusting the Color Temp.	37
Adjusting the RGB (Offset and Gain)	37
Adjusting Hue, Saturation, and Brightness	37

Viewing the Image at the Saved Image Quality (Memory Function) 39

- Saving a Memory 39
- Loading a Memory 39
- Deleting a Saved Memory 40
- Renaming a Memory 40

Useful Functions

Enjoying 3D Images 42

- Preparing to View 3D Images 42
 - If the 3D image cannot be viewed 42
- Using 3D Glasses 43
 - Charging the 3D Glasses 43
 - Pairing 3D Glasses 44
 - Wearing 3D Glasses 44
 - Reading the indicator on the 3D Glasses 44
- Converting 2D Images to 3D 45
- Warnings Regarding Viewing 3D Images 46

Using the HDMI Link Function 48

- HDMI Link Function 48
- HDMI Link Settings 48
- Connecting 49

Playing Back Image Data (Slideshow) . . 50

- Compatible Data 50
- Playing a Slideshow 50
- Settings for Slideshow 51

Projecting Two Images Simultaneously (Split Screen) (EH-TW5350 Only) 52

- Projecting in Split Screen 52
- Changing the Split Screen Settings 52
- Exiting Split Screen 52

Using the Projector on a Network (EH-TW5350 Only)

Projecting Using Wireless LAN 53

- Selecting Network Settings for the Projector . . . 53
- Selecting the Computer's Wireless LAN Settings . 55
 - Selecting wireless network settings in Windows 55
 - Selecting wireless network settings in OS X . . 55

- Setting Up Wireless Network Security 56
- Projecting in Epson iProjection 56
 - Operating using a smartphone (remote control function) 57

Projecting in Screen Mirroring 59

- Selecting Screen Mirroring Settings 59
- Projecting in Windows 8.1 60
- Projecting Using Intel WiDi Software 61
- Projecting Using the Miracast Function 62

Configuration Menu

Configuration Menu Functions 64

- Configuration Menu Operations 64
- Configuration Menu Table 65
 - Image menu 65
 - Signal menu 66
 - Settings menu 68
 - Extended menu 70
 - Network menu (EH-TW5350 only) 71
 - Info menu 74
 - Reset menu 74

Troubleshooting

Problem Solving 75

- Reading the Indicators 75
 - Indicator status during an error/warning 75
 - Indicator status during normal operation 77
 - Screen Mirroring indicator and status (EH-TW5350 only) 77
 - Wireless LAN indicator and status (EH-TW5350 only) 78
- When the Indicators Provide No Help 78
 - Check the problem 78
 - Problems relating to images 79
 - Problems when projection starts 83
 - Problems with the remote control 83
 - Problems with 3D 83
 - Problems with HDMI 84
 - Network problems 85
 - Bluetooth device problems 86
 - Other problems 87

About Event ID 88

Maintenance

Maintenance 90

Cleaning the Parts 90

 Cleaning the air filter 90

 Cleaning the main unit 90

 Cleaning the lens 91

 Cleaning the 3D Glasses 91

Replacement Periods for Consumables 91

 Air filter replacement period 91

 Lamp replacement period 91

Replacing Consumables 92

 Replacing the air filter 92

 Replacing the lamp 92

 Resetting lamp hours 94

Appendix

Optional Accessories and Consumables 95

 Optional Items 95

 Consumables 95

Supported Resolutions 96

 Computer Signals (Analog RGB) 96

 Composite Video 96

 HDMI1/HDMI2 Input Signal 96

 MHL Input Signal 96

 3D Input Signal HDMI 97

 3D Input Signal MHL 97

Specifications 98

Appearance 101

List of Safety Symbols 102

Glossary 104

General Notes 106

 General Notice 107

Projector Features

Dynamic 3D Display

Enjoy 3D contents on Blu-ray and images filmed with a 3D camera through a stunning projection display.  [p.42](#)

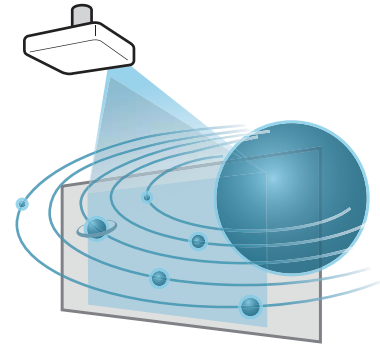

Project Images from Mobile Devices

HDMI1/MHL port to connect a commercially available MHL cable to the mobile device and to the projector.

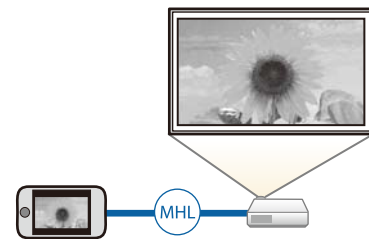

Screen Mirroring to connect your projector and mobile device wirelessly using Intel® WiDi or Miracast technology. (EH-TW5350 only)  [p.59](#)

Epson iProjection to connect your projector and mobile device wirelessly. You can download Epson iProjection free of charge from App Store or Google Play. (EH-TW5350 only)  [p.56](#)



Quick and Easy to Install, Use, and Remove

- Capable of projecting large screen images at a short distance
- Single lever for easy height adjustments

Quick Image Adjustments

If you cannot install the projector parallel to the screen, quickly correct keystone distortion using the horizontal keystone adjuster. Slider controlled adjustments make for intuitive control.  [p.31](#)

Other Useful Functions

In addition, the following useful functions are provided.

- Since you can play back audio over the built-in speakers, no external speakers are needed.

- Sending audio to Bluetooth® audio devices. You can wirelessly connect speakers and headphones that support Bluetooth and enjoy the audio. (This function may not be available in some countries and regions.) 🖱️ [p.21](#)
- You can view slideshows by simply connecting a USB memory to the projector. When a digital camera is connected, you can view the photos on the camera using **Slideshow**. 🖱️ [p.50](#)
- Operate by remote control from a smartphone (EH-TW5350 only). By using Epson iProjection, you can operate the projector from a smartphone or tablet. 🖱️ [p.57](#)

Part Names and Functions

Front/Top

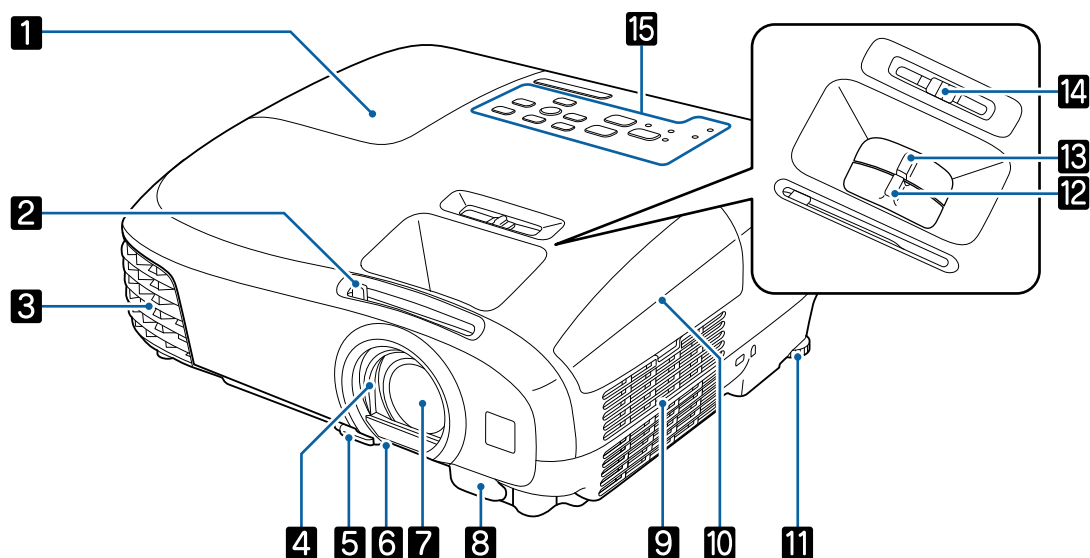







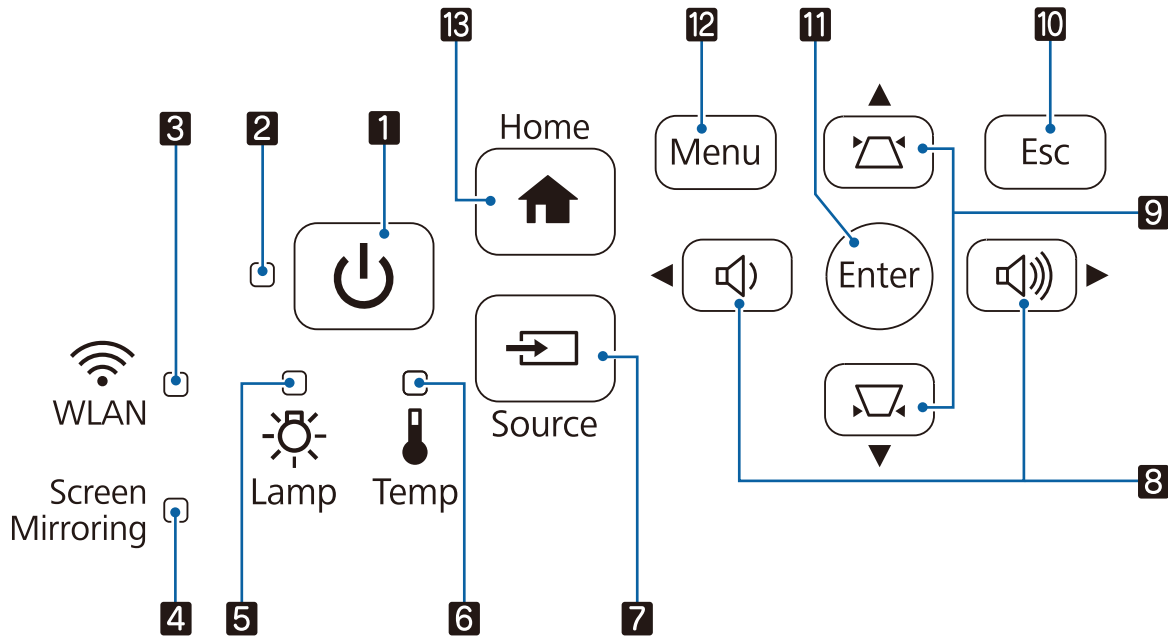





Name		Function
1	Lamp cover	Open when replacing the projector's lamp. p.92
2	A/V mute slide lever	Slide the knob to open and close the lens cover. Close during projection to delete audio and video. p.32
3	Air exhaust vent	Exhaust vent for air used to cool the projector internally. <div style="border: 1px solid black; padding: 5px;"> <p> Caution</p> <p>While projecting, do not put your face or hands near the air exhaust vent, and do not place objects that may become warped or damaged by heat near the vent. Hot air from the air exhaust vent could cause burns, warping, or accidents to occur.</p> </div>
4	Lens cover	Close when not using the projector to protect the lens from being scratched or soiled. p.28
5	Foot release lever	Press the foot release lever to extend and retract the front adjustable foot. p.29
6	Front adjustable foot	When set up on a surface such as a table, extend the foot to adjust the height of the image. p.29
7	Lens	Images are projected from here.
8	Remote receiver	Receives signals from the remote control. p.25
9	Air intake vent	Intake vent for air used to cool the projector internally.
10	Air filter cover	When replacing the air filter, open this cover and remove the air filter. p.92
11	Rear foot	When set up on a surface such as a table, extend the foot to adjust horizontal tilt. p.30
12	Focus ring	Adjusts the image focus. p.29

Name	Function
13 Zoom ring	Adjusts the image size. p.29
14 Horizontal keystone adjuster	Performs horizontal keystone correction. p.31
15 Control panel	Operates the projector. p.9

Control Panel



Buttons/Indicators	Function
1	Turns the projector on or off. p.26 Shows the projector's status through a combination of other indicators lit and flashing. p.77
2 Operation indicator	Flashes blue to indicate the projector is warming up or cooling down. Shows the projector's status through a combination of other indicators lit and flashing. p.75
3 WLAN	Shows the access status to the wireless LAN by lighting or flashing. p.78 EH-TW5300/EH-TW5210 do not light or flash.
4 Screen Mirroring	Shows the usage status of Screen Mirroring by lighting or flashing. p.77 EH-TW5300/EH-TW5210 do not light or flash.
5 Lamp	Flashes orange when it is time to replace the lamp. Shows the projector's errors through a combination of other indicators lit and flashing. p.75
6 Temp	Flashes orange if the internal temperature is too high. Shows the projector's errors through a combination of other indicators lit and flashing. p.75
7 Source	Changes to the image from each input port. p.26



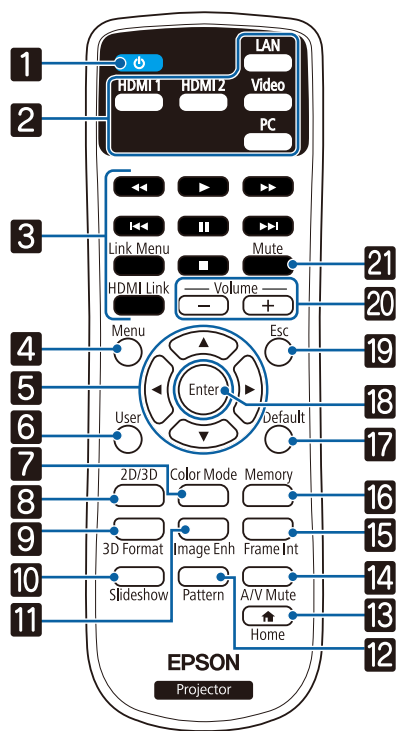

	Buttons/Indicators	Function
8		<ul style="list-style-type: none"> • Adjusts the volume. You cannot control the volume for Bluetooth audio devices. • Selects menu items or adjustment values while displaying the projector's menu.  p.32 • Performs horizontal keystone correction when the Keystone screen is displayed.  p.31
9		<ul style="list-style-type: none"> • Adjusts keystone distortion in projected images. • Selects menu items or adjustment values while displaying the projector's menu.  p.31
10		Return to the previous menu level when a menu is displayed.  p.64
11		Selects functions and settings when a menu is displayed.  p.64
12		Displays and closes the Configuration menu. On the Configuration menu, you can make adjustments and settings for Signal, Image, Input Signal, and so on.  p.64
13		Displays and closes the Home screen.  p.27

Remote Control

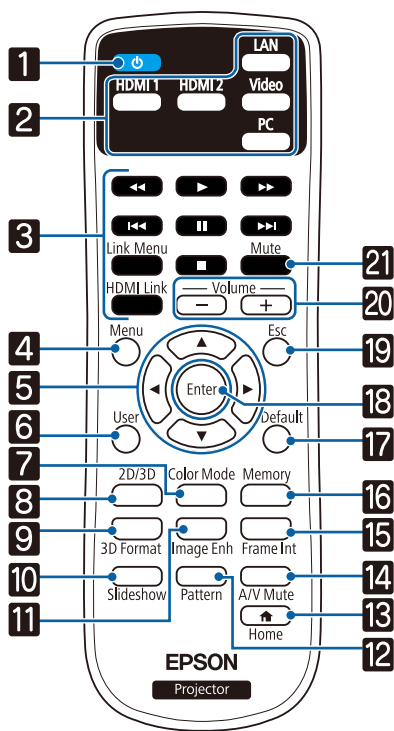

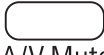
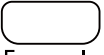
Button	Function
1	Turns the projector on or off. p.26
2	Changes to the image from each input port. p.26 If you press the button when using EH-TW5350, the source switches between LAN and Screen Mirroring.
3	<ul style="list-style-type: none"> • When HDMI Link is On Displays the device connections list. Press other buttons to control playback, stop, or adjust the volume of connected devices compatible with the HDMI CEC or MHL standards. p.48 • When HDMI Link is Off Displays the HDMI Link settings menu.
4	Displays and closes the Configuration menu. On the Configuration menu, you can make adjustments and settings for Signal, Image, Input Signal, and so on. p.64
5	Selects menu items and adjustment values. p.64
6	Performs the function assigned to the User Button . p.68
7	Changes the Color Mode . p.33
8	Changes the 3D Display to Auto, 3D, or 2D. p.45
9	Changes the 3D format. p.42
10	Changes to the image from the USB port. p.50
11	Displays the Image Enhancement menu. p.35
12	Displays and closes the test pattern. p.29
13	Displays and closes the Home screen. p.27

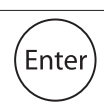
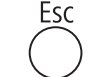
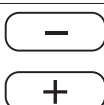

Button	Function
14 	Turns the video and audio on or off temporarily. p.32
15 	Sets the strength for Frame Interpolation. p.36
16 	Registers and loads a memory. p.39
17 	The adjustment value returns to its default value when pressed while the menu's adjustment screen is displayed. p.64
18 	When a menu is displayed, it accepts and enters the current selection and moves to the next level. p.64
19 	Returns to the previous menu level when a menu is displayed. p.64
20 	Adjusts the volume. p.32 You cannot control the volume for Bluetooth audio devices.
21 	Temporarily mutes or plays the audio. p.32

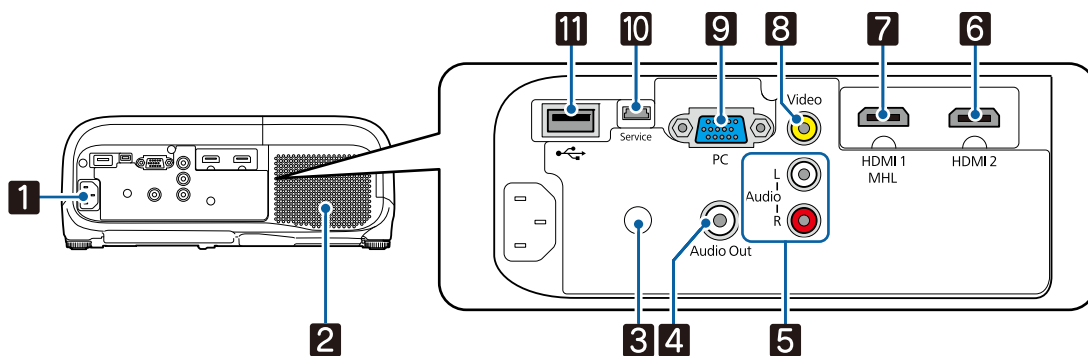

Rear

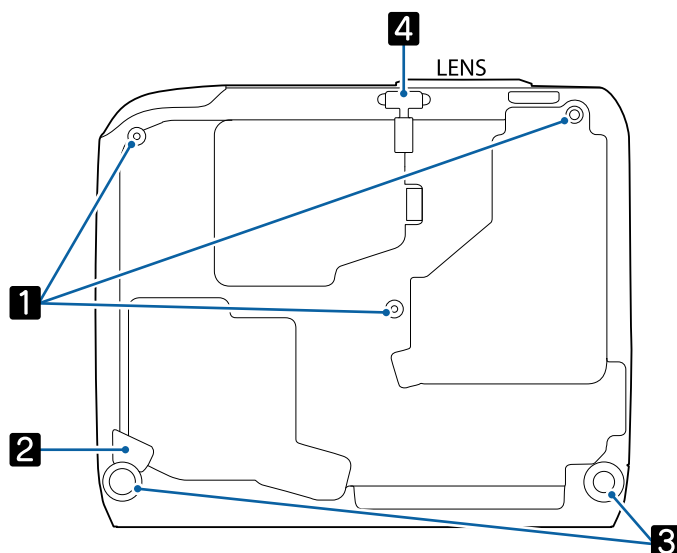

Name		Function
1	Power inlet	Connect the power cord. p.26
2	Speaker	The projector's built-in speaker. Outputs audio.
3	Remote receiver	Receives signals from the remote control. p.25
4	Audio Out port	Outputs audio during playback to the external speakers. p.21
5	Audio (L-R) port	Inputs audio from equipment connected to the Video port or the PC port. p.19
6	HDMI2 port	Connects HDMI compatible video equipment and computers. p.19
7	HDMI1/MHL port	Connects HDMI compatible video equipment and computers. p.19 Also, connects MHL compatible smartphones and tablets. p.20
8	Video port	Connects to the composite video output port on video equipment. p.19
9	PC port	Connects to the RGB output port on a computer. p.19
10	Service port	Service port. This is not normally used.
11	USB port	Connects USB devices such as a USB memory device or a digital camera, and projects images as a slideshow. p.20

Base



Name		Function
1	Ceiling mount fixing points (three points)	Attaches the optional ceiling mount here when suspending the projector from a ceiling.  p.95
2	Security cable fitting	Thread a commercially available theft-prevention wire lock through this opening to secure and lock the projector.
3	Rear foot	When set up on a surface such as a table, extend the foot to adjust horizontal tilt.  p.30
4	Front adjustable foot	When set up on a surface such as a table, extend the foot to adjust the height of the image.  p.29

Installing

Projected Image and Position of Projector

Install the projector as follows.

■ Installing in parallel with the screen

If the projector is installed at an angle to the screen, keystone distortion occurs in the projected image. Adjust the projector's position so that it is installed in parallel with the screen.

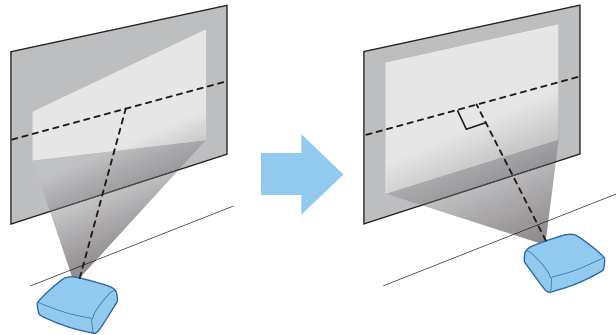

If you cannot install the projector parallel to the screen, correct keystone distortion using the horizontal keystone adjuster or H/V-Keystone correction. [p.30](#)

■ Installing the projector horizontally by adjusting the height of either side

If the projector is tilted, the projected image is also tilted.

Install the projector horizontally so that both sides are at the same height.

If the projector cannot be installed horizontally, you can adjust the projector's tilt with the rear foot. [p.30](#)

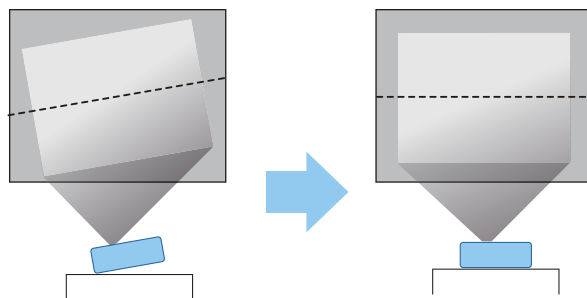

Various Setting Methods

Warning

- A special method of installation is required when suspending the projector from a ceiling (ceiling mount). If it is not installed correctly, it could fall causing an accident and injury.
- If you use adhesives, lubricants, or oil on the ceiling mount fixing points to prevent screws from loosening, or if you use things such as lubricants or oils on the projector, the projector case may crack causing it to fall from its ceiling mount. This could cause serious injury to anyone under the projector and also damage the projector.
- Do not install it on an unstable shelf or in a place out of load range. Otherwise, it could fall or topple causing an accident and injury.
- When installing it in a high position such as on a shelf, take measures against falling by using wires to ensure the safety in an emergency, such as an earthquake, and prevent accidents. If it is not installed correctly, it could fall causing an accident and injury.
- Do not block the air intake vent and air exhaust vent of the projector. Blocking its air intake vent and air exhaust vent may trap heat inside causing fire.

Attention

- Try not to setup the projector in locations subject to high humidity and dust, or in locations subject to smoke from fires or tobacco smoke.
- Do not use the projector installed vertically. Doing so could cause a malfunction.
- Clean the air filter once every three months. Clean it more often if the environment is particularly dusty.

 [p.90](#)

Placing on a table and projecting

You can install the projector on a table in your living room or on a low shelf to project images.

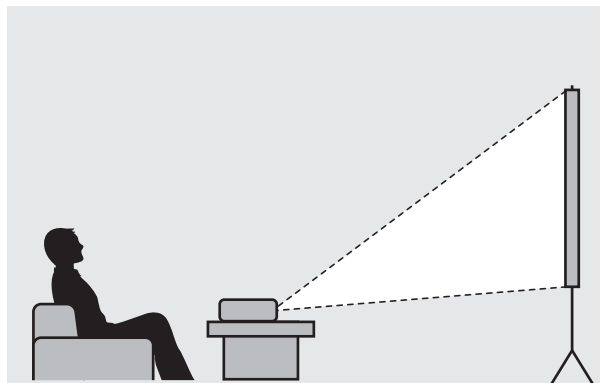

Suspending from the ceiling and projecting

You can suspend the projector from the ceiling with the optional ceiling mount to project images.

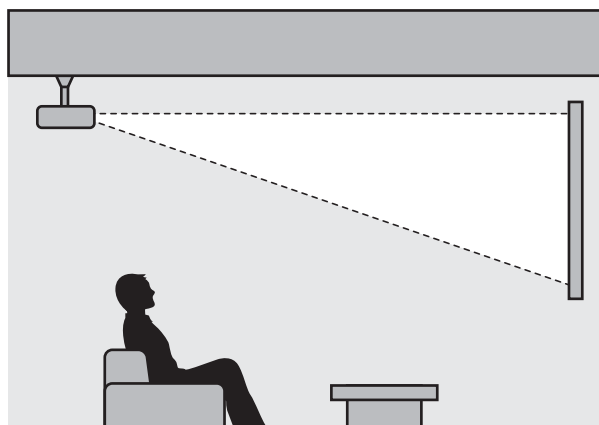

When suspending from the ceiling and projecting, set **Projection** to **Front/Ceiling** or **Rear/Ceiling**. **Extended - Projection** p.70

Adjusting the Projection Size

The size of the projection increases as the projector is moved away from the screen.

Use the table below to setup the projector at the optimum position from the screen. The values given here are for your reference only.

The projected image becomes smaller after correcting distortion. Increase the projection distance to fit the projected image to the screen size.

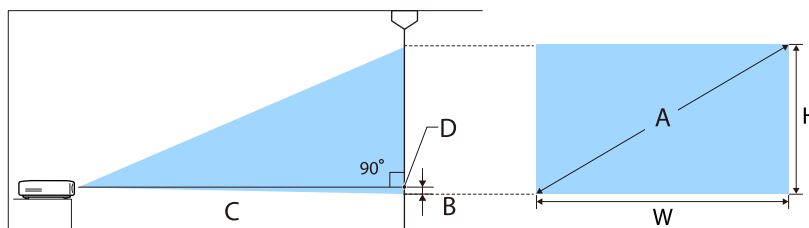

- B Distance from the center of the lens to the base of the projected image
- D The center of the lens

Unit: cm

16:9 Screen Size		Projection Distance (C)		Distance (B)
A	W x H	Minimum (Wide)	Maximum (Tele)	
30"	66 x 37	80	96	-3
40"	89 x 50	107	129	-5
50"	111 x 62	135	162	-6
60"	133 x 75	162	195	-7
80"	177 x 100	217	261	-9
100"	221 x 125	272	327	-11
150"	332 x 187	410	492	-17
200"	443 x 249	547	658	-23
250"	553 x 311	685	823	-28

Preparing

16:9 Screen Size		Projection Distance (C)		Distance (B)
A	W x H	Minimum (Wide)	Maximum (Tele)	
300"	664 x 374	823	988	-34

Connecting a Device

Attention

- Make cable connections before connecting to a power outlet.
- Check the shape of the cable's connector and the shape of the port, and then connect. If you force a connector of a different shape into the port, it could cause damage and a malfunction to occur.

Connecting Video Equipment

To project images from DVD players or VHS video and so on, connect to the projector using one of the following methods.

When using a commercially available HDMI cable

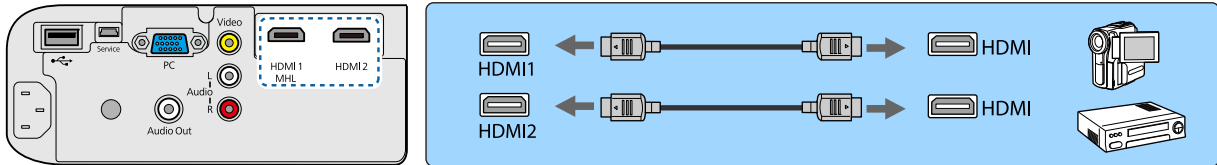

When using a commercially available video cable

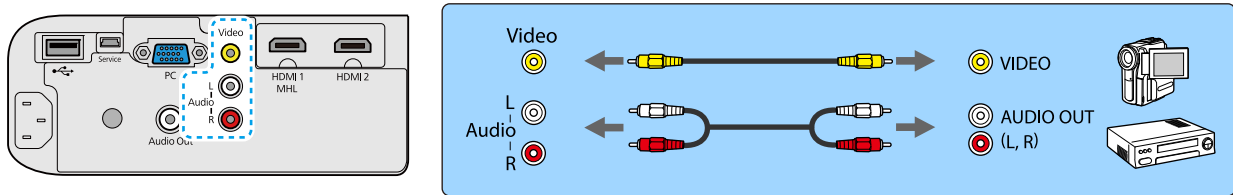

- The cable differs depending on the output signal from the connected video equipment.
- Some types of video equipment are capable of outputting different types of signals. Check the user's guide supplied with the video equipment to confirm what type of signals can be output.
- If audio is not output correctly, check the settings in **Audio Out Device**. **Settings - HDMI Link - Audio Out Device p.68**

Connecting a Computer

To project images from a computer, connect the computer using one of the following methods.

When using a commercially available computer cable

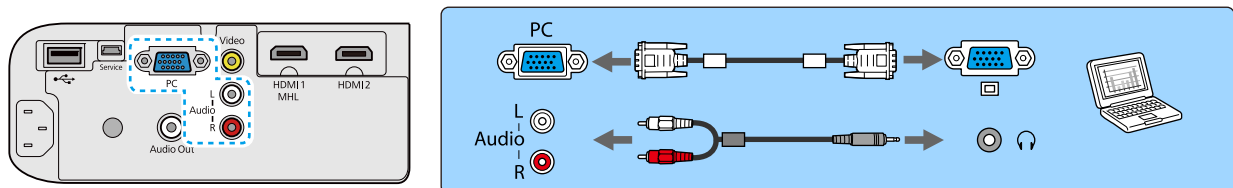

When using a commercially available HDMI cable

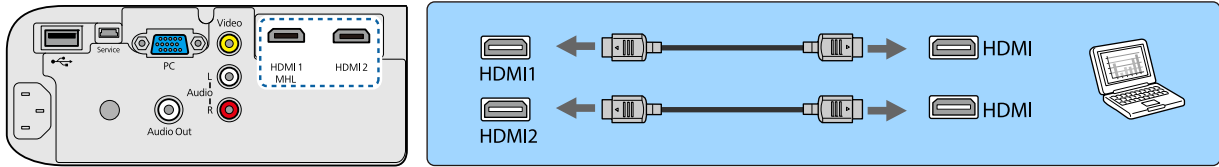

Connecting Smartphones or Tablets

You can connect MHL compatible smartphones or tablets.

Use a commercially available MHL cable to connect the micro USB port of smartphones and tablets to the HDMI1/MHL port on the projector.

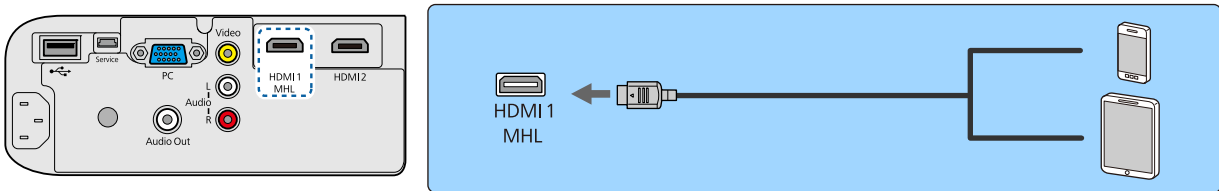

The connected smartphone or tablet begins charging when images are projected.

Attention

- Be sure to use an MHL compatible cable for making connections. If a cable that does not meet the MHL standards is connected, the smartphone or tablet could generate heat, cause a liquid leak, explode or generate other conditions that could result in a fire.
- If you connect using a commercially available MHL-HDMI conversion adapter, charging the smartphone or tablet may not work or you may not be able to perform operations using the projector's remote control.



- When using a lot of power, such as when playing a movie, you may not be able to charge.
- This projector will not charge devices in standby mode or when the battery in a smartphone or tablet is depleted.

Connecting USB Devices

You can connect USB devices such as USB memories, and USB compatible digital cameras.

Using the USB cable supplied with the USB device, connect the USB device to the USB (TypeA) port on the projector.

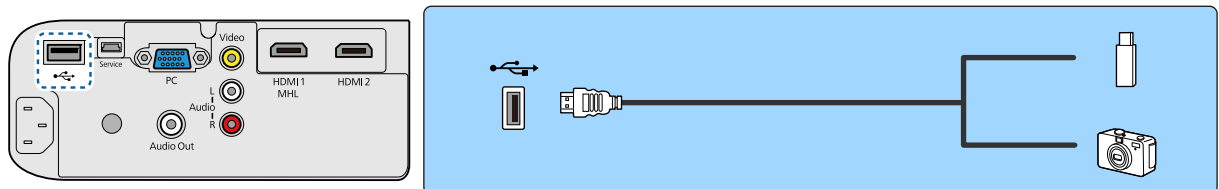

When the USB device is connected, you can project image files on the USB memory or digital camera as a slideshow. p.50

When you have finished projecting, remove USB devices from the projector. For devices with a power switch, make sure you turn them off before disconnecting the USB device.

Attention

- If you use a USB hub, the connection may not operate correctly. Devices such as digital cameras and USB devices should be connected to the projector directly.
- Connect a digital camera using a USB cable specified for use with the device.
- Use a USB cable less than 3 m in length. If the cable exceeds 3 m, slideshows may not function correctly.

Connecting External Speakers

To output audio from external speakers, connect the speakers to the projector's Audio Out port with a commercially available audio cable.

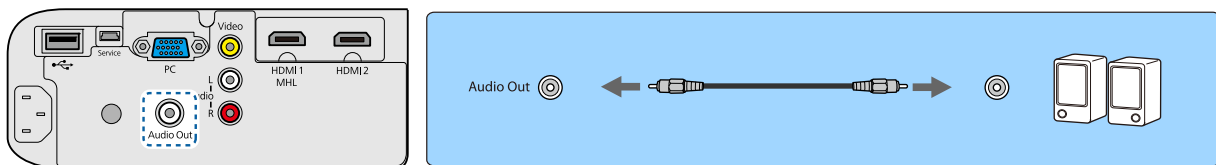

To output audio from external speakers, set **Audio Out Device** to **Projector**. When an AV system is not connected to the projector, audio is output from the external speakers, even if **Audio Out Device** is set to **AV System**. **Settings - HDMI Link - Audio Out Device** p.68

Connecting Bluetooth® Devices

You can connect audio devices that support Bluetooth (A2DP compliant) or 3D Glasses (Bluetooth 3DS Profile compliant).

Bluetooth audio devices are not supported in some countries and regions.

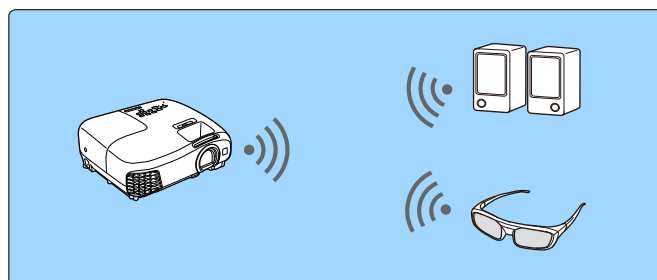

See the following for information on connecting 3D Glasses.

"Pairing 3D Glasses" p.44



Audio input to the HDMI1 port, HDMI2 port, Audio (L-R) port, or Screen Mirroring is output from speakers or headphones that support Bluetooth.



- 1 Press the  button to display the menu in the following order; **Settings - Bluetooth - Bluetooth Audio**.

- 2 Use the   buttons to select **On**, and then press the  button to confirm the selection.



- 3 Turn on "pairing mode" on the Bluetooth device you want to connect to. See the documentation supplied with the Bluetooth device for more information.

- 4 Select **Search Bluetooth Device**. A list of available devices is displayed.

- 5 Use the   buttons to select the Bluetooth device you want to connect to, and then press the  button to connect.

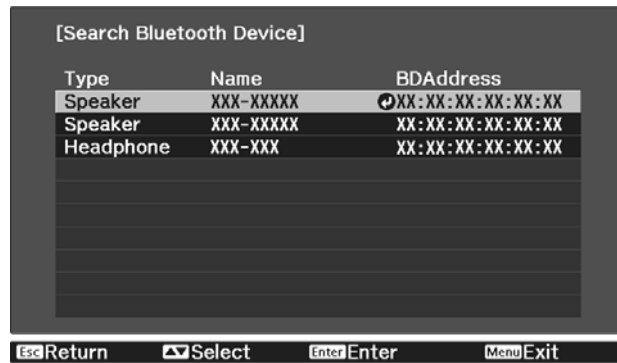

The next time you turn on the projector, it automatically connects to the last device it connected to. To change the connected device, repeat the procedure from step 3.



- When **Audio Out Device** is set to **AV System**, audio cannot be output from Bluetooth audio devices. To output audio from Bluetooth audio devices, set **Audio Out Device** to **Projector**.  **Settings - HDMI Link - Audio Out Device** [p.68](#)
- There is a delay in the audio output from any Bluetooth audio devices.

Bluetooth specifications

Version	Bluetooth Ver. 3.0
Output	Class 2
Communication distance	Approx. 10 m
Supported profiles	A2DP
Content protection	SCMS-T
Frequency used	2.4 GHz band (2.402 to 2.480 GHz)



Warning

- Electromagnetic interference may cause medical equipment to malfunction. Before using the device, make sure there is no medical equipment in the vicinity.
- Electromagnetic interference may cause automatically controlled equipment to malfunction which could cause an accident. Do not use the device near automatically controlled equipment such as automatic doors or fire alarms.



- Connect a Bluetooth device that supports copyright protection (SCMS-T).
- You may not be able to connect depending on the standard and type of device.
- Even when connecting within the specified communication distance, connections can be lost due to the status of the signal.
- The communication method for Bluetooth uses the same frequency (2.4 GHz) as wireless LAN (IEEE802.11b/g) or microwave ovens. Therefore, if these devices are used at the same time, radio wave interference may occur, the image and audio may be interrupted, or communication may not be possible. If you do need to use these devices at the same time, make sure there is enough distance between them and the Bluetooth device.
- You cannot connect multiple Bluetooth devices to the projector at the same time.

Preparing the Remote Control

Installing the Remote Control Batteries

Attention

- Check the positions of the (+) and (-) marks inside the battery holder to ensure the batteries are inserted the correct way.
- You cannot use other batteries except for the AA size manganese or alkaline.

- 1** Remove the battery cover.
While pushing the battery compartment cover catch, lift the cover up.

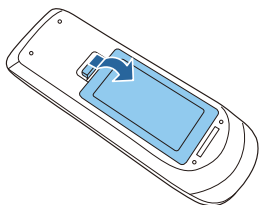

- 2** Replace the old batteries with new batteries.
Check the polarity of the batteries (+) and (-) before installing.

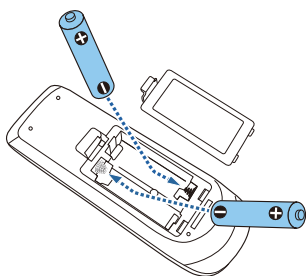

- 3** Reattach the battery cover.
Press the cover until it clicks into place.

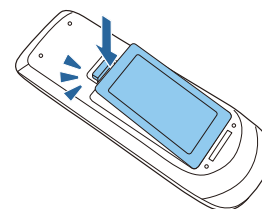

 If delays in the responsiveness of the remote control occur or if it does not operate, it probably means that the batteries are becoming flat. When this happens, replace them with new batteries. Have two AA size manganese or alkaline batteries ready.

Remote Control Operating Range

Operating range (left to right)

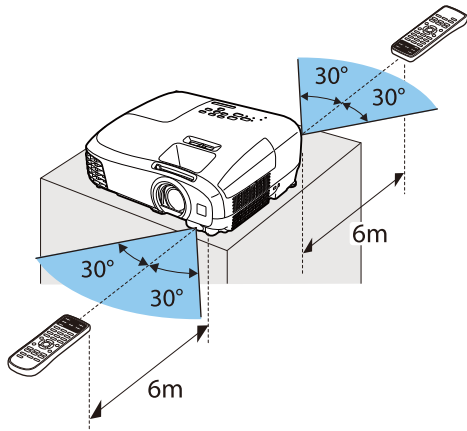

Operating range (top to bottom)

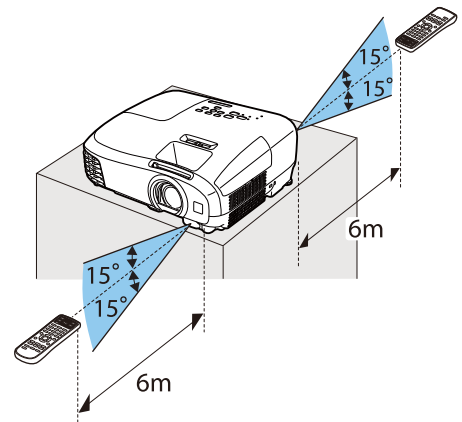

Projecting Images

Turning On the Projector

1 Connect the equipment to the projector.

2 Connect using the power cord supplied.

The projector's power indicator turns blue. This indicates that the projector is receiving power, but is not yet turned on (it is in standby mode).

3 Open the lens cover.

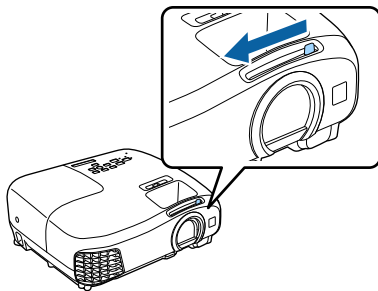

4 Turn on the connected equipment.

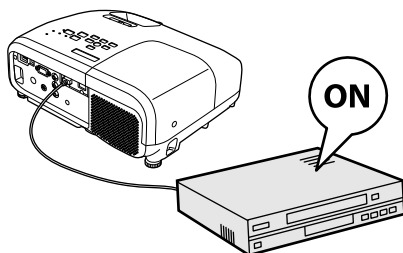

5 Press the  button on the remote control or the control panel.

Remote control

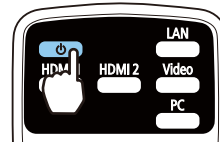

Control panel

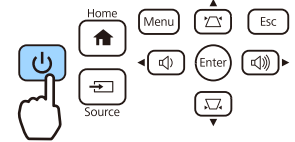

The operation indicator flashes blue as the projector warms up. Once the projector is warmed up, the operation indicator stops flashing and turns blue.





When **Direct Power On** is set to **On**, you can start projecting by simply connecting the power cord to the projector without having to press any buttons.  **Extended - Operation - Direct Power On** [p.70](#)



Warning

- Do not look into the lens during projection. The powerful light emitted could cause damage to eyesight.
- Do not stand in front of the lens during projection. Clothes could be damaged due to the high temperature.



- This projector provides a Child Lock function to prevent children from accidentally turning the power on and a Control Panel Lock function to prevent accidental operations and so on.  **Settings - Lock Setting - Child Lock/Control Panel Lock** [p.68](#)
- This projector provides an Auto Setup function to automatically select the optimum settings when the input signal for the connected computer image changes.  **Signal - Auto Setup** [p.66](#)
- When using at an altitude of 1500 m or more, set **High Altitude Mode** to **On**.  **Extended - Operation - High Altitude Mode** [p.70](#)

 If the target image is not projected

If the image is not projected, you can change the source using one of the following methods.

Remote control

Press the button for the target port.

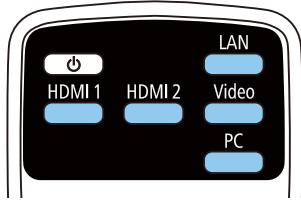

Control panel

Press the button and select the target port.
Press the button to confirm the selection.

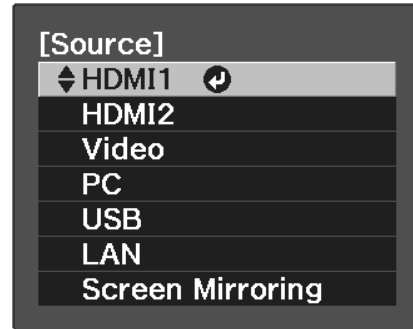

Using the Home Screen

The Home screen feature allows you to easily select an image source and access useful functions.

Press the button on the remote control or the control panel to display the Home screen.

Under the following conditions, the Home screen is displayed automatically when the projector is turned on.

- **Home Screen Auto Disp.** is set to **On**. **Extended - Home Screen - Home Screen Auto Disp.** p.70
- There are no signals from any sources.

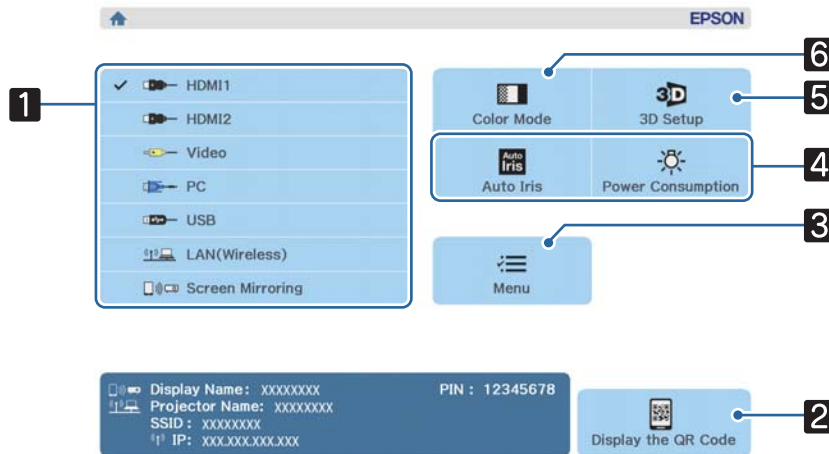

1	Selects the source you want to project.
2	Displays the QR code and connects wirelessly to a smartphone or tablet (EH-TW5350 only). p.56
3	Displays the Configuration menu. p.64
4	Performs menu options assigned to Home Screen in the Extended menu. Extended - Home Screen p.70
5	Sets the 3D function. p.66
6	Changes the Color Mode . p.33

The Home screen disappears after 10 minutes of inactivity.

Turning Off

1 Turn off the connected equipment.

2 Press the  button on the remote control or the control panel.

Remote control

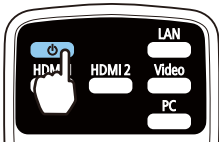

Control panel

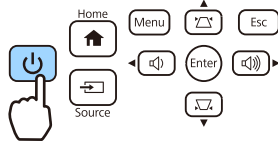

A confirmation message is displayed.

3 Press the  button again.

Power Off?

Yes : Press  button
No : Press any other button

The operation indicator flashes and the projector begins to cool down.

4 Wait until cool-down is complete.

When cool-down is complete, the operation indicator stops flashing.

5 Disconnect the power cord.



If the power cord is connected, some electricity is consumed even if no operations are made.

6 Close the lens cover.

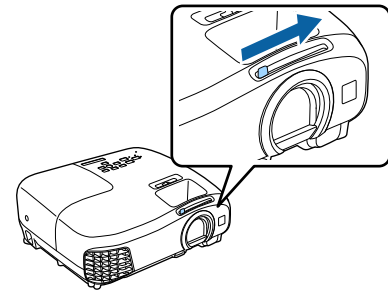



Adjusting the Projected Image

Displaying the Test Pattern

When adjusting the zoom/focus or the projection position just after setting up the projector, you can display a test pattern instead of connecting video equipment.

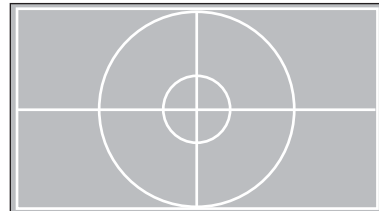
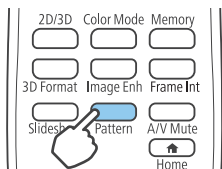
Press the  button on the remote control to display the test pattern.



Press the  button again to end the test pattern display.

Adjusting the Focus

Turn the focus ring to adjust the focus.

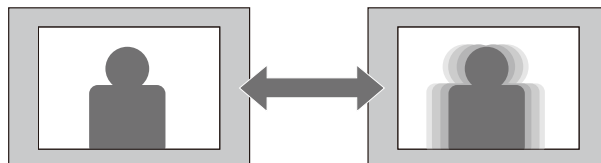

Adjusting the Projection Size

Turn the zoom ring to adjust the size of the projected image.

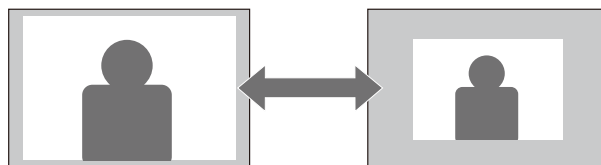

Adjust the Height of the Image

Press the foot release lever to extend the front adjustable foot. You can tilt the projector up to 12° to adjust image height.

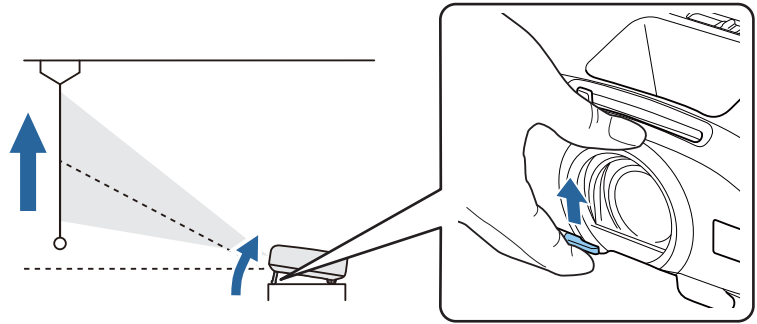

 It becomes more difficult to focus the higher the tilt angle is. Use a moderate tilt angle.

Adjusting the Projector's Tilt

If the projected image is horizontally tilted (the left and right sides of the projected image are at different heights) when the projector is setup on a table, adjust the rear foot so that both sides are level with each other.

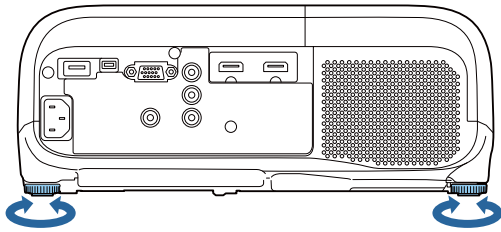

Correcting Distortion

You can correct keystone distortion using one of the following methods.

Correct automatically (EH-TW5350/EH-TW5300 only)	Auto V-Keystone	Automatically correct vertical keystone distortion.
Correct manually	H-Keystone Adjuster	Correct horizontal keystone distortion with the horizontal keystone adjuster.
	H/V-Keystone	Manually correct distortion in the horizontal and vertical directions independently.

-  • The projected image becomes smaller after correcting distortion. Increase the projection distance to fit the projected image to the screen size.
- Install the projector parallel with the screen without any loss in image quality. If you cannot install the projector parallel to the screen, adjust the shape of the image using H/V-Keystone correction.

Correct automatically (Auto V-Keystone) (EH-TW5350/EH-TW5300 only)

When the projector is moved or tilted during projection, Auto V-Keystone automatically corrects any vertical keystone distortion. Two seconds after the projector is moved, it displays an adjustment screen and then automatically corrects the projected image.

Auto V-Keystone can correct the projected image distortion in these conditions:

- Projection angle is less than 30° up or down.
- **Projection** is set to **Front**.  **Extended - Projection** p.70



If you do not want to use the Auto V-Keystone function, set **Auto V-Keystone** to **Off**. **Settings - Keystone - Auto V-Keystone** p.68

Correct manually (H-Keystone adjuster)

Move the horizontal keystone adjuster to the right or left to perform horizontal keystone correction.

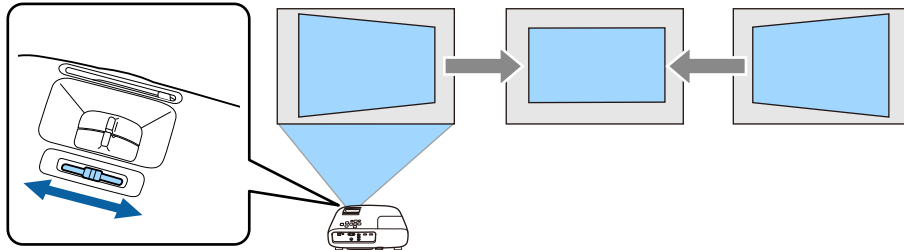

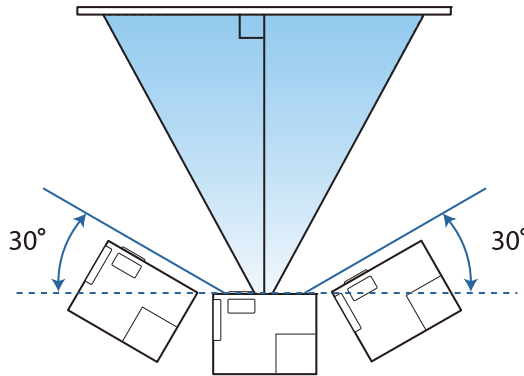

You can make effective corrections within a projection angle of 30° left to right.



Correct manually (H/V-Keystone)

You can use the  buttons on the control panel to correct keystone distortion.

Press the  buttons to display the V-Keystone/H-Keystone gauges.

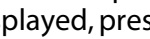
When the gauges are displayed, press the  buttons to perform vertical correction, and press the  buttons to perform horizontal correction.

You can correct images up to 30° right, left, up, or down.

When the top or bottom is too wide

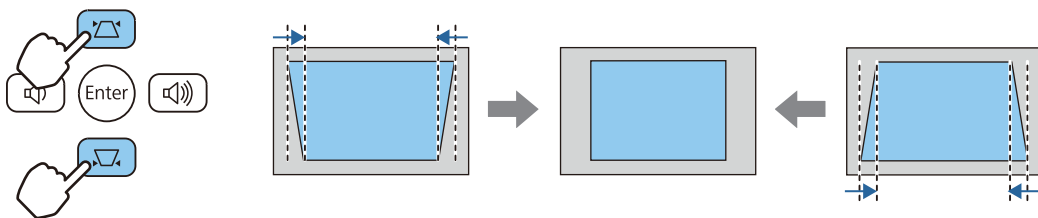

When the left or right is too wide

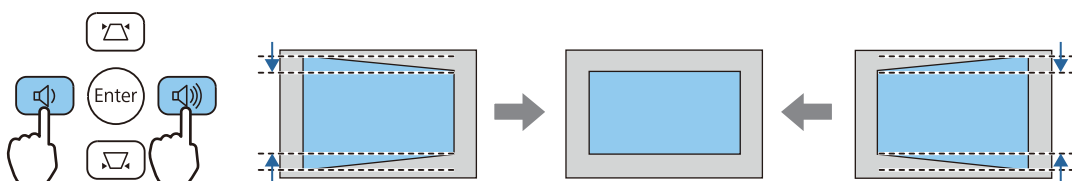



- You can adjust the volume by pressing the buttons when the gauges are not displayed. [p.32](#)
- You can set H/V-Keystone from the Configuration menu. **Settings - Keystone - V-Keystone/H-Keystone** [p.68](#)

Adjusting the Volume

You can adjust the volume by using the buttons on the remote control or the buttons on the control panel.

Remote control

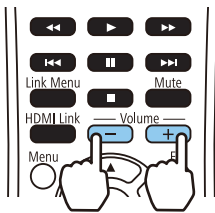

Control panel

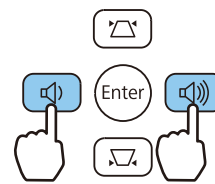

- You can also adjust the volume from the Configuration menu. **Settings - Volume** [p.68](#)
- When an AV System is connected to the projector and you want to adjust the volume for the AV system, set **HDMI Link** to **On** and **Audio Out Device** to **AV System**. **Settings - HDMI Link** [p.68](#)
- You cannot adjust the volume of Bluetooth audio devices from the projector.



Caution

Do not start at high volume.

A sudden excessive volume may cause loss of hearing. Always lower the volume before powering off, so that you can gradually increase the volume when you next turn on the power.

Hiding the Image and Muting the Audio Temporarily (A/V Mute)

You can temporarily stop projection and mute any sound by pressing the button on the remote control or by closing the lens cover. To turn the image and sound back on, press the button again or open the lens cover.

Remote control

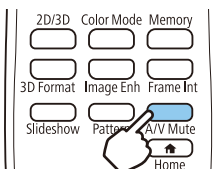

Main unit

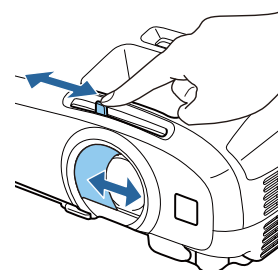

- Because a movie continues to play even when it is hidden, you cannot return to the point at which you hid the image and muted the audio.
- The button also switches between muting and playing the audio.



Adjusting the Image

Selecting the Projection Quality (Color Mode)

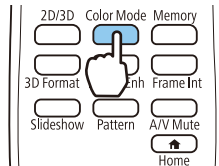

You can obtain the optimum image quality to suit your surroundings when projecting. The brightness of the image varies depending on the mode selected.

1 Press the  button.



- You can make settings from the Configuration menu.  **Image - Color Mode** p.65
- If you press the  button, you can also make settings from the Home screen.  p.27

2 Select **Color Mode**.

Use the   buttons to select a mode, and then press the  button to confirm the selection.

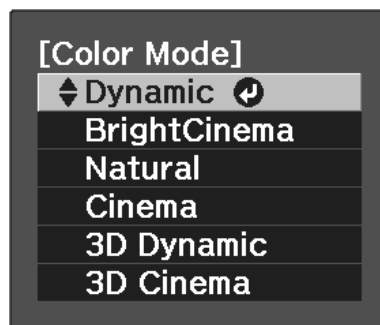

Choices when projecting 2D images

Mode	Application
Dynamic	Ideal for use in a bright room.
BrightCinema	Ideal for use in a bright room. Images are clear and sharp.
Natural	Ideal for use in a dark room. We recommend selecting this mode when performing color adjustment for the image.  p.37
Cinema	Ideal for watching movies and concerts in a dark room.

Choices when projecting 3D images

Mode	Application
3D Dynamic	Images are bright and sharper than 3D Cinema.
3D Cinema	Produces crisper colors than 3D Dynamic.



Switching the Screen Between Full and Zoom (Aspect)

You can change the input signal's type, aspect ratio, and resolution to match the **Aspect** of the projected image.

The available settings vary depending on the image signal currently being projected.

Press the  button to displays menus in the following order.

Signal - Aspect

Use the   buttons to select the item, and then press the  button to confirm the selection.

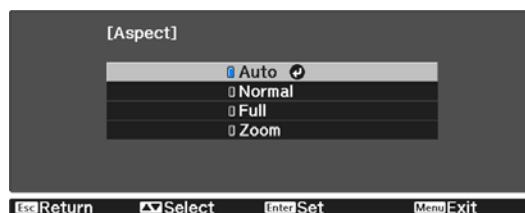

 You may not be able to change the **Aspect** depending on the signal.

By normally selecting **Auto**, the optimum aspect is used to display the input signal. Change the setting if you want to use a different aspect.

The table below shows the image projected on a 16:9 screen.

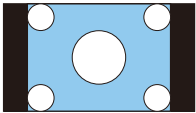
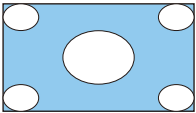
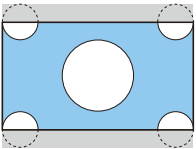
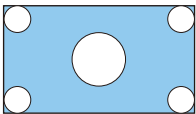
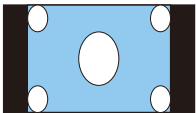
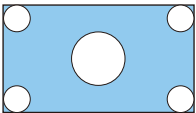
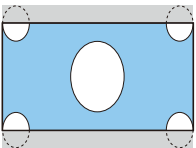
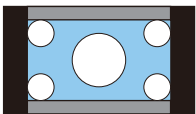
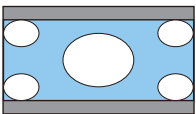
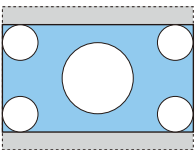
Input Image	Setting Name		
	Normal	Full	Zoom
4:3 Images			
16:9 Images		When projecting 16:9 images, Full and Zoom cannot be selected.	
Images Recorded Using Squeeze			
Letterbox Images*			

Input Image	Setting Name		
	Normal	Full	Zoom
Notes	Matches the vertical size of the projection panel. The aspect ratio differs depending on the input image.	Uses the entire projection panel. The aspect ratio differs depending on the input resolution.	Retains the aspect ratio of the input signal, and matches the horizontal size of the projection panel. The top and bottom of the image may be truncated.

* The letterbox image used in this explanation is a 4:3 aspect ratio image displayed in 16:9 with black margins at the top and bottom for subtitle placement. The margins at the top and bottom of the screen image are used for subtitles.

 Note that using the aspect ratio function of the projector to reduce, enlarge, or split the projected image for commercial purposes or for public viewing may infringe upon the rights of the copyright holder of that image based on copyright law.

Adjusting the Sharpness

You can adjust the outline of the image.



Press the  button to displays menus in the following order.

Image - Sharpness

Use the   buttons to make adjustments.

The image becomes sharper as the value is increased, and becomes softer as the value is decreased.



Adjusting Image Resolution (Image Enhancement)



You can adjust the resolution of the image using the Image Enhancement function.

This is only available when receiving signal input from Video, HDMI1, HDMI2, PC, or Screen Mirroring.



The following content can be adjusted.

Image Preset Mode	Select the settings prepared in advance as the settings for Noise Reduction , MPEG Noise Reduction , and Detail Enhancement .
Noise Reduction	(Only available when Image Processing is set to Fine) Smoothes out rough images.
MPEG Noise Reduction	Smoothes out rough images in MPEG format.
Detail Enhancement	Enhances the contrast in an image to create a more emphatic texture and material feel. Depending on the image, a highlight may be noticeable at the border between colors. If this bothers you, set a smaller value.

- 1 Press the  button to display menus in the order **Image - Image Enhancement**.

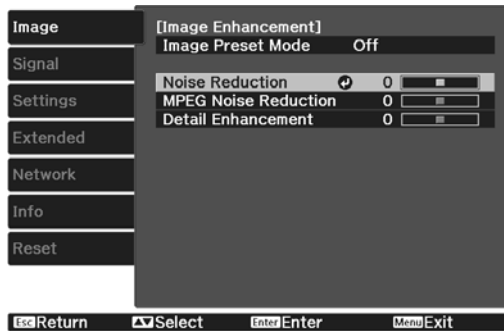
2 Use the   buttons to select the item you want to adjust, and then press the  button to confirm the selection.



3 Use the   buttons to make adjustments.

Press the  button to adjust another item.

Press the  button to return the adjustments to their default values.



4 Press the  button to exit the menu.

Setting Auto Iris

By automatically setting the luminance according to the displayed image, you can enjoy deep and rich images. You can select the luminance adjustment tracking for changes in brightness in the displayed image from **Normal** to **High Speed**.





Press the  button to displays menus in the following order.

Image - Auto Iris



Use the   buttons to select the item, and then press the  button to confirm the selection.

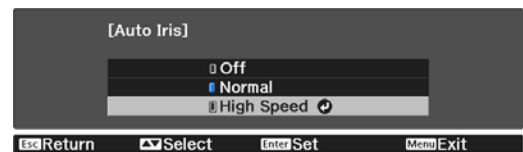

Setting Frame Interpolation



You can play fast moving images smoothly by automatically producing intermediate frames between the original frames.

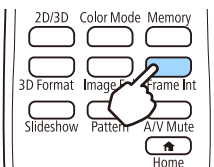

Frame Interpolation is available under the following conditions.

- When **Image Processing** is set to **Fine**.  **Signal - Advanced - Image Processing** p.66
- When the source is Video, HDMI1, or HDMI2.
- When inputting 2D signals or 3D signals (1080p 24 Hz).  p.96

1 Press the  button.



 You can make settings from the Configuration menu.  **Image - Frame Interpolation** p.65

2 Use the   buttons to select the item, and then press the  button to confirm the selection.



Adjusting the Color

Adjusting the Color Temp.

You can adjust the overall tint of the image. Make adjustments if the image is a little too blue or too red and so on.





Press the  button to displays menus in the following order.

Image - Color Temp. - Color Temp.

Use the   buttons to make adjustments.

Blue tints grow stronger as the value is increased, and red tints grow stronger as the value is reduced.



Press the  button to return the adjustments to their default values.

Adjusting the RGB (Offset and Gain)

You can adjust the brightness of dark areas (Offset) and bright areas (Gain) for R (red), G (green), and B (blue).





Press the  button to displays menus in the following order.

Image - Color Temp. - Customized

Use the   buttons to select the item, and then use the   buttons to make the adjustments. The image becomes brighter when moved to the right (positive) and darker when moved to the left (negative).



Offset	When the image is made brighter, shading for the darker sections is more vividly expressed. When the image is made darker, the image appears more full-bodied but shading for the darker sections is harder to distinguish.
Gain	When the image is made brighter, the bright sections become whiter and shading is lost. When the image is made darker, shading for the bright sections is more vividly expressed.

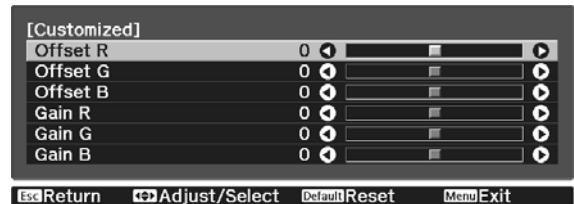



Press the  button to return the adjustments to their default values.

Adjusting Hue, Saturation, and Brightness



You can adjust the hue, saturation, and brightness for each of the R (red), G (green), B (blue), C (cyan), M (magenta), and Y (yellow) colors.



Hue	Adjusts the overall color of the image to be blue, green, or red.
Saturation	Adjusts the overall vividness of the image.
Brightness	Adjusts the overall color brightness of the image.

1 Press the ^{Menu} button to display menus in the order **Image - Advanced - RGBCMY**.

2 Use the   buttons to select the color you want to adjust, and then press the ^{Enter} button to confirm the selection.



3 Use the   buttons to select **Hue, Saturation, or Brightness**.

4 Use the   buttons to make adjustments.

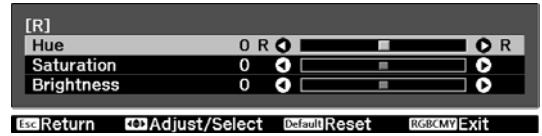

Press the ^{Esc} button to adjust another color.

Press the ^{Default} button to return the adjustments to their default values.

5 Press the ^{Menu} button to exit the menu.

Viewing the Image at the Saved Image Quality (Memory Function)

Saving a Memory

You can save the adjustment values for **Image** from the Configuration menu.

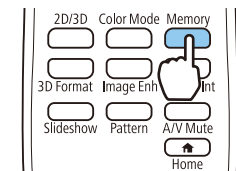

- 1 Press the  button, and then make the settings for **Image** that you want to save.

- 2 Press the  button.



- 3 Use the   buttons to select **Save Memory**, and then press the  button to confirm the selection.



- 4 Use the   buttons to select the memory name to be saved, and then press the  button to confirm the selection.

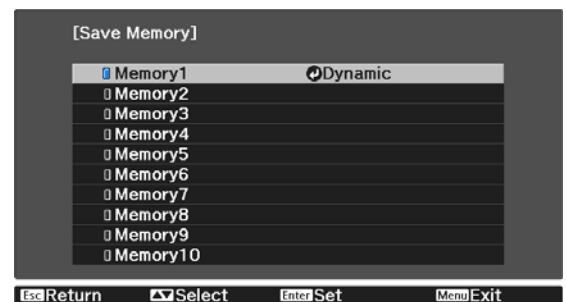

The current projector settings are saved to the memory.

If the mark on the left of the memory name is turned aqua, it means the memory has already been registered. When you select a registered memory, a message is displayed asking you to confirm that you want to overwrite the memory. If you select **Yes**, the previous content is erased and the current settings are saved.

Loading a Memory

You can load saved adjustment values from the remote control to change the image quality.

- 1 Press the  button, and then select **Load Memory**. The **Load Memory** screen is displayed.

- 2 Select the target memory name.



- The color mode saved to the memory is displayed on the right.
- Depending on the input signal, part of the loaded memory item may not be applied to the projected image.
- Memories saved for 2D images can only be loaded when projecting 2D images. Memories saved for 3D images can only be loaded when projecting 3D images.

Deleting a Saved Memory

- 1 Press the  button, and then select **Erase Memory**.
The **Erase Memory** screen is displayed.
- 2 Select the target memory name.
A confirmation message is displayed. If you select **Yes**, the content of the saved memory is erased.



When erasing all saved memories, perform **Reset Memory**.  **Reset - Reset Memory** p.74

Renaming a Memory



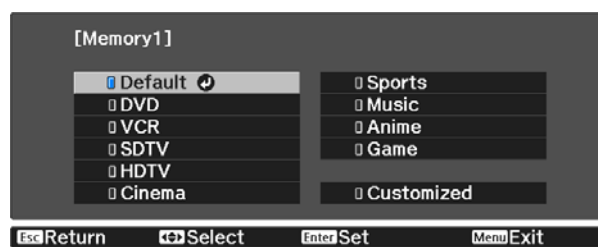

You can rename each memory name using up to 12 characters. Giving the memory a name that is easy to remember is useful when loading the memory.

- 1 Press the  button, and then select **Rename Memory**.
The **Rename Memory** screen is displayed.
- 2 Select the memory name you want to change.
The memory name selection screen is displayed.
- 3 Select the memory name prepared in advance or **Customized**.
To change a name of your own, select **Customized**, and then go to step 4. If you select **Customized**, a keyboard is displayed.
When selecting a memory name prepared in advance, check that the memory name has changed.



4

Enter a new name.

Use the     buttons to select a character, and then press the  button to confirm the selection. Enter up to 12 characters.

When you have finished entering the name, select **Finish**.

The memory name is changed.







Enjoying 3D Images

Preparing to View 3D Images

Check the following before viewing 3D images.

- The source is HDMI1 or HDMI2.
- Set **3D Display** to **Auto** or **3D**.
When **2D** is set, press the  button on the remote control and switch to **Auto** or **3D**.  **Signal - 3D Setup - 3D Display** p.66
- Pair 3D Glasses.  p.44

This projector supports the following 3D formats.

- Frame Packing
- Side by Side
- Top and Bottom

If the 3D image cannot be viewed

The projector automatically projects a 3D image when detecting a 3D format.

Some 3D TV broadcasts may not contain 3D format signals. If this happens, follow the steps below to set the 3D format.

- 1 Press the  button to set **3D Display** to **3D**.

The  button toggles **3D Display** between **Auto**, **3D**, and **2D**.

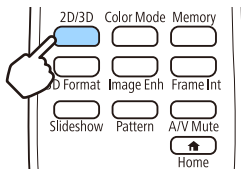

- 2 Press the  button to set the 3D format on the AV device.

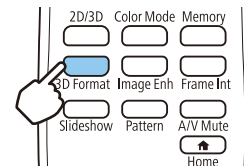



- If you are using a device or cable that does not support 3D images, 3D projection cannot be performed.
- For details on 3D format settings on the AV device, see the documentation supplied with the AV device.
- When the 3D format has not been correctly set up, an image will not be correctly projected as shown below.

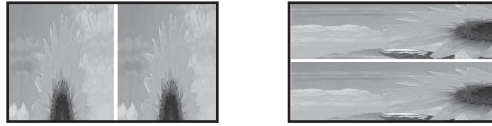

- If a 3D image is not projected correctly even when a 3D format is set, the synchronization timing for the 3D Glasses may be inverted. Inverse the synchronization timing using **Inverse 3D Glasses**.
☛ **Signal - 3D Setup - Inverse 3D Glasses** p.66
- How a 3D image is perceived varies depending on the individual.
- When you start projecting a 3D image, a warning about viewing 3D images is displayed. You can turn off this warning by setting **3D Viewing Notice** to **Off**. ☛ **Signal - 3D Setup - 3D Viewing Notice** p.66
- During 3D projection, the following Configuration menu functions cannot be changed.
Aspect (Normal fixed), Overscan (Off fixed)
- You cannot use the Split Screen function (EH-TW5350 only) during 3D projection.
- How the 3D image is viewed may change depending on the temperature of the surroundings and how long the lamp has been used. Refrain from using the projector if the image is not projected normally.

Using 3D Glasses

Use the optional 3D Glasses (ELPGS03) to view 3D images. ☛ p.95



The 3D Glasses come with protective stickers. Remove the protective stickers before use.

Charging the 3D Glasses

Use the USB charging cable to connect the 3D Glasses to the USB Charging Adapter (ELPAC01), and then connect the USB Charging Adapter to an electrical outlet.

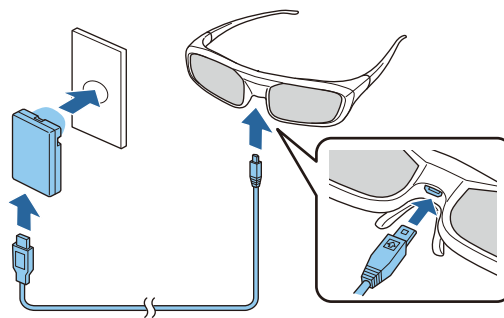

- You can only charge the 3D Glasses ELPGS03.
- You can use the glasses for approximately three hours after charging for just three minutes. A full charge takes 50 minutes and the glasses can be used for approximately 40 hours.
- You can also charge by connecting the 3D Glasses to the projector. When using the projector to charge the 3D Glasses, connect the USB charging cable to the USB (TypeA) port on the projector (you can only charge when the projector is turned on).

Attention

- Only connect to an electrical outlet that uses the voltage displayed on the adapter.
- Note the following points when handling the USB cable.
 - You should not bend, twist, or pull the cable with too much force.
 - You should not modify the cable.
 - You should not perform wiring near an electric heater.
 - You should not use the cable if it is damaged.

■ Pairing 3D Glasses

To view 3D images, you first need to pair the 3D Glasses with the projector.

Press the [Pairing] button for a while on the 3D Glasses to start pairing. See the User's Guide for the 3D Glasses for more information.



- When using the 3D Glasses for the first time, pairing is performed when the 3D Glasses are turned on. You do not need to perform pairing if 3D images can already be viewed correctly.
- Once pairing has been performed, you can view 3D images the next time the devices are turned on.
- You can perform pairing within a range of three meters from the projector. While pairing is being performed, make sure you stay within a range of three meters from the projector. Otherwise, pairing will fail.
- If synchronization cannot be performed within 30 seconds, pairing is automatically canceled. When pairing is cancelled, 3D images cannot be viewed because pairing fails.

■ Wearing 3D Glasses

1 Turn on the 3D Glasses by sliding the [Power] switch to On.

The indicator turns on for several seconds, and then turns off.

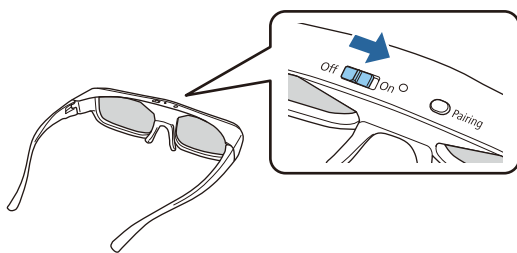

2 Put on the 3D Glasses and enjoy the show.



- When you have finished using the 3D Glasses, turn them off by sliding the [Power] switch to Off.
- If the 3D Glasses are not used for at least 30 seconds, they turn off automatically. To turn the 3D Glasses back on, slide the [Power] switch to Off, and then slide it back to On.

■ Reading the indicator on the 3D Glasses

You can check the status of the 3D Glasses by whether its indicator is lit or flashing.

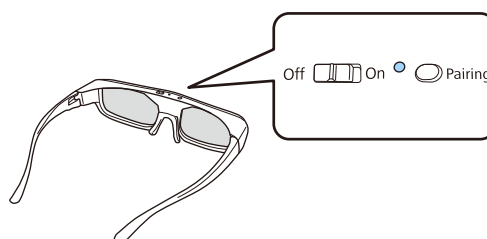

Indicators	Status
Flashes red two times ×5	Weak battery
Lit red	Charging
Lit green	Charging completed
Flashes green and red in turn	Pairing
Lit green for ten seconds and then turns off	Power on or pairing succeeded

Converting 2D Images to 3D



You can convert 2D images from HDMI1 or HDMI2 into 3D images.

1 Press the  button to set **3D Display to Auto**.

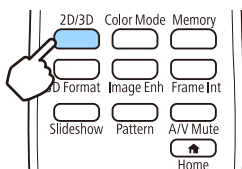
The  button toggles **3D Display** between **Auto**, **3D**, and **2D**.



2 Press the  button, to display the menu in the order **Signal - 3D Setup - 2D-to-3D Conversion**.

3 Use the   buttons to select the strength of the 3D effect, and then press the  button to confirm the selection.

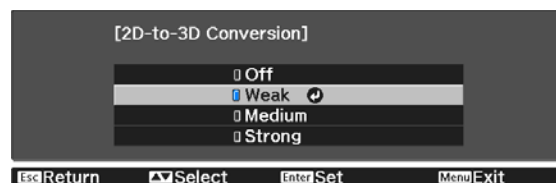

Warnings Regarding Viewing 3D Images

Note the following important points when viewing 3D images.

Warning

Disassembling or remodeling

- Do not disassemble or remodel the 3D Glasses.
This could cause a fire to occur or the images to appear abnormal when viewing, causing you to feel unwell.

Storage locations

- Do not leave the 3D Glasses or the supplied parts within reach of children.
They could be accidentally swallowed. If anything is accidentally swallowed, contact a doctor immediately.

Heating

- Do not place the 3D Glasses in a fire, on a heat source, or leave them unattended in a location subject to high temperatures. Because this device has a built-in rechargeable lithium battery, it could cause burns or a fire if it ignites or explodes.

Charging

- When charging, connect the supplied cable to the USB port designated by Epson. Do not charge using other devices as it may cause the battery to leak, overheat, or explode.
- Only use the supplied charging cable to charge the 3D Glasses. Otherwise, it could overheat, ignite, or explode.

Caution

3D Glasses

- Do not drop or press too forcefully on the 3D Glasses.
If the glass sections and so on are broken, an injury could occur. Store the glasses in the soft glasses case.
- Be careful of the edges of the frame when wearing the 3D Glasses.
If it pokes your eye and so on, an injury could occur.
- Do not place your finger in any of the moving sections (such as the hinges) of the 3D Glasses.
Otherwise an injury could occur.

Caution

Wearing 3D Glasses

- Make sure you wear the 3D Glasses correctly.
Do not wear the 3D Glasses upside down.
If the image is not displayed correctly into the right and left eyes, it could cause you to feel unwell.
- Do not wear the glasses unless you are viewing a 3D image.
- How a 3D image is perceived varies depending on the individual. Stop using the 3D function if you feel strange or cannot see in 3D.
Continuing to view the 3D images could cause you to feel unwell.
- Stop wearing the 3D Glasses immediately if they seem abnormal or a malfunction occurs.
Continuing to wear the 3D Glasses could cause an injury or cause you to feel unwell.
- Stop wearing the 3D Glasses if your ears, nose, or temples become red, painful, or itchy.
Continuing to wear the 3D Glasses could cause you to feel unwell.
- Stop wearing the 3D Glasses if your skin feels unusual when wearing the glasses.
In some very rare cases the paint or materials used in the 3D Glasses could cause an allergic reaction.

 **Caution**

Viewing Time

- When viewing 3D images, always take periodic breaks during extended viewing. Long periods of viewing 3D images may cause eye fatigue. The amount of time and frequency of such breaks varies from person to person. If your eyes still feel tired or uncomfortable even after taking a break from viewing, stop viewing immediately.

 **Caution**

Watching 3D Images

- If your eyes feel fatigued or uncomfortable when viewing 3D images, stop viewing immediately. Continuing to view the 3D images could cause you to feel unwell.
- When viewing 3D images be sure to always wear 3D Glasses. Do not attempt to view 3D images without 3D Glasses. Doing so could cause you to feel unwell.
- Do not place any breakable or fragile objects around you when using 3D Glasses. 3D images may cause you to move your body involuntarily, resulting in damage to nearby items or personal injury.
- Only wear 3D Glasses when viewing 3D images. Do not move around while wearing 3D Glasses. Your vision may appear darker than normal, causing you to fall or injure yourself.
- Try to stay as level with the viewing screen as possible when viewing 3D images. Viewing 3D images at an angle reduces the 3D effect and may cause you to feel unwell due to unintended color changes.
- If using 3D Glasses in a room with fluorescent or LED lighting, you may see flashing or flickering throughout the room. If this should occur, reduce the lighting until the flickering goes away or turn off the lights completely when viewing 3D images. In some very rare cases, this flickering could trigger seizures or fainting for some individuals. If you begin to feel uncomfortable or unwell at any time when viewing 3D images, stop immediately.
- Stay at least three times the height of the screen away from the screen when viewing 3D images. The recommended viewing distance for an 80-inch screen is at least 3 meters, and at least 3.6 meters for a 100-inch screen. Sitting or standing any closer than the recommended viewing distance may result in eye fatigue.

 **Caution**

Health Risks

- You should not use 3D Glasses if you are sensitive to light, have a heart condition, or are unwell. Doing so could aggravate your pre-existing conditions.

 **Caution**

Recommended Age of Use

- The minimum recommended age to view 3D images is six years old.
- Children under the age of six are still developing and viewing 3D images may cause complications. Consult your doctor if you have any concerns.
- Children viewing 3D images through 3D Glasses should always be accompanied by an adult. It is often difficult to tell when a child is feeling tired or uncomfortable, which could result in them feeling suddenly unwell. Always check with your child to ensure that they are not experiencing any eye fatigue during viewing.

Using the HDMI Link Function

HDMI Link Function

When an AV device that meets the HDMI CEC standards is connected to the projector's HDMI port, you can perform linked operations such as linked power on and volume adjustment for the AV system from one remote control.

- As long as the AV device meets the HDMI CEC standards, you can use the HDMI link function even if the AV system in-between does not meet the HDMI CEC standards.
- Up to 3 multi-media players that meet the HDMI CEC standards can be connected at the same time.

Connection Example

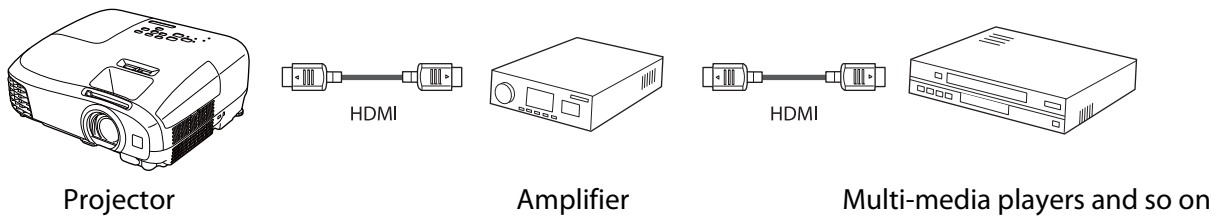

HDMI Link Settings

When **HDMI Link** is set to **On**, you can perform the following operations. **Settings - HDMI Link - HDMI Link p.68**

- Input Change Link**
Changes the input source of the projector to HDMI when content is played back on the connected device.
- Connected Devices Operations**
Using the projector's remote control, you can perform operations such as Play, Stop, Fast Forward, Rewind, Next Chapter, Previous Chapter, Pause, Volume Adjustment, and Audio Mute.

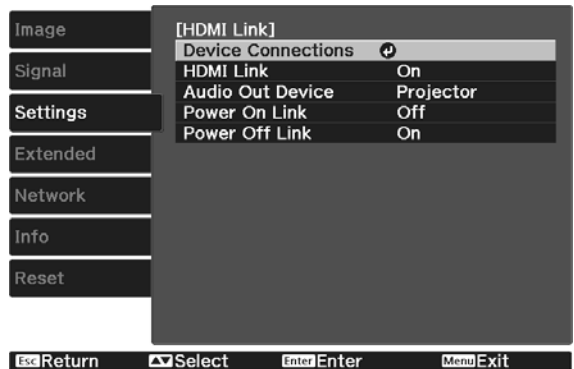

You can also select the following functions from the **HDMI Link** screen.

Function	Explanation
Audio Out Device	When an AV system is connected, you can output audio from the projector's speaker or from the AV system.
Power On Link	When Power On Link is set to On , operations are linked as shown below. <ul style="list-style-type: none"> When the projector is turned on, the connected devices are also turned on. Also, when the connected devices are turned on and content is played back, the projector turns on.
Power Off Link	When Power Off Link is set to On , when the projector is turned off, the connected devices are also turned off. <ul style="list-style-type: none"> This only works when the connected device's CEC power link function is enabled. Note that depending on the status of the connected device (for example, if it is recording), the device may not power off.



To use the HDMI Link function, you must configure the connected device. See the documentation supplied with the connected device for more information.

Connecting

You can check the connected devices that are available for HDMI Link, and select on the device you want to project the image from. Devices that can be controlled by HDMI Link automatically become the selected device.

Before displaying the list of connected devices, check that **HDMI Link** is set to **On**.  **Settings - HDMI Link - HDMI Link** [p.68](#)

1 Press the  button, and then select **Device Connections**.

The **Device Connections** list is displayed.

Devices that have an aqua icon to their left are linked by HDMI Link.

If the device name cannot be determined this field is left blank.

2 Select the device you want to operate using the HDMI Link function.

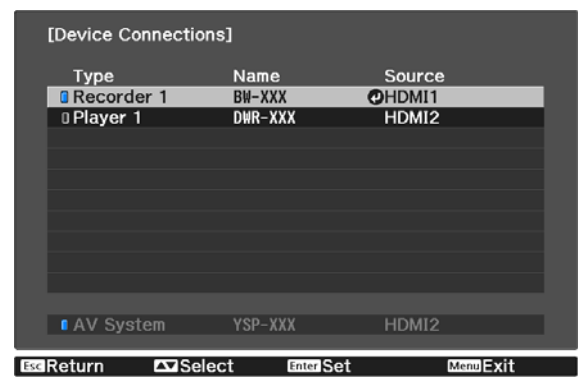

- If the cable does not meet the HDMI standards, operations are not possible.
- Some connected devices or functions of those devices may not operate properly even if they meet the HDMI CEC standards. See the documentation and so on supplied with the connected device for more information.

Playing Back Image Data (Slideshow)

Compatible Data

The following types of files stored on USB storage devices such as USB memories and digital cameras that are connected to the projector's USB port can be displayed as a slideshow.

Slideshow compatible file types

File Type (Extension)	Notes
.jpg	<ul style="list-style-type: none"> • Images using CMYK color mode are not compatible. • Progressive format images are not compatible. • Images with a resolution greater than 8192 x 8192 are not compatible. • Due to the characteristics of JPEG files, images may not be projected clearly if the compression ratio is too high.

Playing a Slideshow

1

Connect a USB storage device.

Files are displayed as thumbnails.



To open a folder, select the folder, and then press the  button.



If thumbnails of the files are not displayed, press the  button on the remote control to change the source.





2

Select **Slideshow**.

Use the     buttons to select **Slideshow** at the bottom right of the screen, and then press the  button.

Slideshow starts.



- To close the slideshow, disconnect the USB storage device.
- Select an image from the thumbnails and press the  button to enlarge the selected image. Press the   buttons on the remote control when viewing an enlarged image to change between images. You can also rotate the image using the   buttons.

Settings for Slideshow

You can set the file display order and slideshow operations on the option screen.

- 1 Use the     buttons to position the cursor over the folder where you want to change settings, and then press the  button.

The submenu is displayed.





- 2 Select **Option**, and then press the  button.

The option screen is displayed.

- 3 Position the cursor over the item you want to change, and press the  button to make settings for each item.

The following table shows the details for each item.

Display Order	You can select to display the files in Name Order or Date Order .
Sort Order	You can select to sort the files In Ascending or In Descending order.
Continuous Play	You can set whether to repeat a slideshow.
Screen Switching Time	When playing a slideshow, you can set the time for a single file to be displayed. You can set a time between No (0) to 60 seconds. When you set No , auto play is disabled.
Effect	You can set the screen effects when changing slides.

- 4 When you have finished making settings, use the     buttons to position the cursor over **OK**, and then press the  button.

The settings are applied.

If you do not want to apply the settings, position the cursor on **Cancel**, and then press the  button.

Projecting Two Images Simultaneously (Split Screen) (EH-TW5350 Only)

Projecting in Split Screen

You can use the split screen feature to simultaneously project two images from different image sources (HDMI1/HDMI2 and Screen Mirroring).

Check the following points before you start projecting in Split Screen.

- Connect devices to the projector using Screen Mirroring.  p.59
- Make sure the source is HDMI1 or HDMI2.

1 Press the  button to display the **Settings** menu.

2 Select **Split Screen**, and then press the  button.
 Images from the HDMI1 or HDMI2 source are projected on the left of the screen, and images from Screen Mirroring are projected on the right of the screen.

 3D images cannot be projected in the split screen projection.

Changing the Split Screen Settings

When you press the  button while performing the split screen projection, you can change the Split Screen settings.

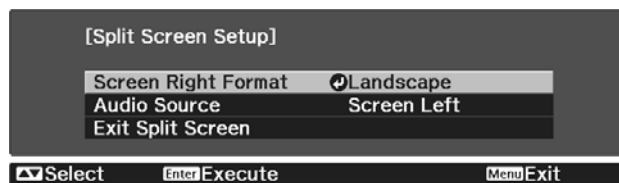

The following table shows the details for each item.

Screen Right Format	Select the orientation and size of the image sent by Screen Mirroring.
Audio Source	Select the source to output audio. When Screen Left is selected, audio is output from the HDMI1 or HDMI2 source. When Screen Right is selected, audio is output from Screen Mirroring.
Exit Split Screen	Exits the split screen display.

Exiting Split Screen

To exit the split screen projection, press the  button.

Projecting Using Wireless LAN

You can project images from smartphones, tablets, and computers over wireless LAN.

To project over wireless LAN, you need to make wireless network settings for the projector and the connected device in advance.



You can use one of the following methods to project over wireless LAN.

- EasyMP Network Projection to share your projector over a network and project images from any of the computers on the network.
Download EasyMP Network Projection from the following Web site.
<http://www.epson.com/>
- Epson iProjection to connect your projector and mobile device wirelessly using the app available on App Store or Google play.  p.56

Selecting Network Settings for the Projector

Before you can project from your wireless network, you need to select network settings for the projector.

1 Press the  button to display menus in the order **Network - Wireless LAN Power**.

2 Use the   buttons to select **On**, and then press the  button.

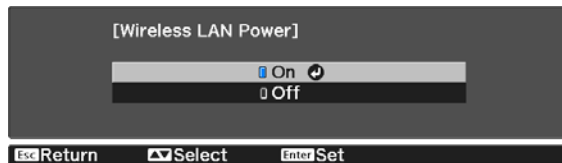



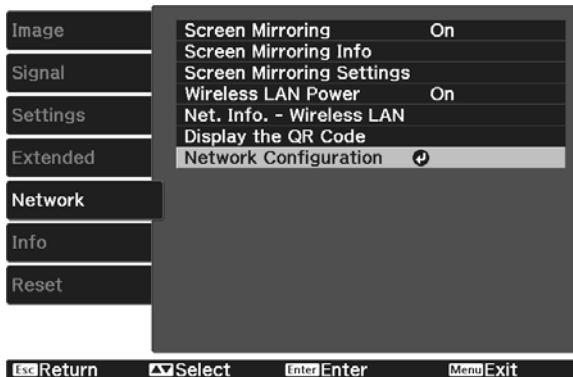



3 Select **Network Configuration**, and then press the  button.



4 Select **Basic**, and then set the following as necessary.

- **Projector Name:** Enter a name up to 16 alphanumeric characters long to identify the projector over the network.
- **Remote Password:** When operating the projector from a smartphone or a tablet, enter a password up to 8 alphanumeric characters long for accessing the projector.
- **Display LAN Info.:** Set the display format for the projector's network information.

 Use the displayed keyboard to enter the name, passwords and keyword. Press the    buttons on the remote control to highlight characters, and then press  to enter them.

5 Select **Wireless LAN**, and then press the  button.

6 Select the **Connection Mode** setting.

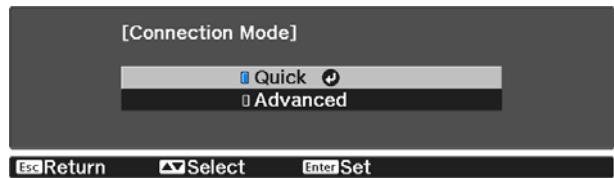

- **Quick:** Lets you quickly connect to one smartphone, tablet, or computer. When you select **Quick**, go to step 10.
- **Advanced:** Lets you connect to multiple smartphones, tablets, or computers over a wireless network access point. When you select **Advanced**, go to step 7.

When switching the connection mode, follow the on-screen instructions to save your settings. After saving the settings, the **Network** menu is displayed.

7 Select **Network Configuration - Wireless LAN - Search Access Point**, to select the access point you want to connect to.

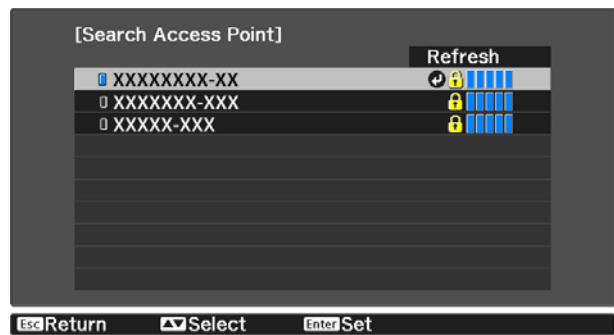

8 If you need to assign the SSID manually, select **SSID** to enter the SSID.

9 Assign an IP address to the projector as necessary.

- If your network assigns addresses automatically, select **IP Settings** to set the **DHCP** setting to **On**.
- If you need to set addresses manually, select **IP Settings** to set the **DHCP** setting to **Off**, and then enter the projector's **IP Address**, **Subnet Mask**, and **Gateway Address** as necessary.



10 When you have finished selecting settings, select **Complete** and then follow the on-screen instructions to save your settings and exit the menus.

11 Press the  button on the remote control. The wireless network settings are complete when you see the correct IP address on the LAN standby screen.

When you have finished making wireless settings for your projector, you need to make wireless settings on the connected device. Then start the network software to send images to your projector through a wireless network.



- When using EasyMP Network Projection, select the same connection mode that you selected in step 6.
- To prevent the SSID and IP address from being displayed on the LAN standby screen or the Home screen, set **SSID Display** and **IP Address Display** to **Off**. **Network - Network Configuration - Wireless LAN**

Selecting the Computer's Wireless LAN Settings

Before connecting to the projector, select the correct wireless network on your computer.

Selecting wireless network settings in Windows

- 1 To access your wireless utility software, double-click the network icon on the Windows taskbar.
- 2 When connecting in Advanced connection mode, select the network name (SSID) of the network the projector is connecting to.
- 3 Click **Connect**.

Selecting wireless network settings in OS X

- 1 Click the AirPort icon on the menu bar at the top of the screen.

- 2 When connecting in Advanced connection mode, make sure AirPort is turned on and select the network name (SSID) of the network the projector is connecting to.

Setting Up Wireless Network Security

You can set up security for your projector to use on a wireless network. Set up one of the following security options to match the settings used on your network:

- WPA2 security
- WPA/WPA2 security

- 1 Press the  button to display menus in the order **Network - Network Configuration - Security**.

- 2 Select the security settings to match your network settings.

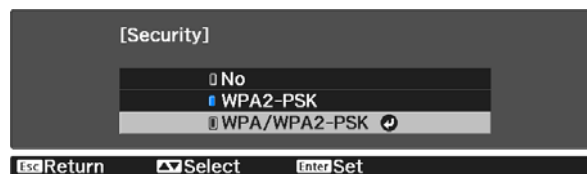



- 3 When you have finished making settings, select **Complete** and follow the on-screen instructions to save your settings and exit the menus.



Projecting in Epson iProjection

After selecting the wireless network settings for your projector, you can display a QR code on the screen and use it to connect a smartphone or tablet using the Epson iProjection app (Ver. 1.3.0 or later).



- You can download Epson iProjection free of charge from App Store or Google Play. Any fees incurred when communicating with the App Store or Google play are the responsibility of the customer.
- When using Epson iProjection in **Quick** connection mode, we recommend making security settings.  [p.56](#)

- 1 Press the  button to display menus in the order **Network - Wireless LAN Power**.

- 2 Use the   buttons to select **On**, and then press the  button.

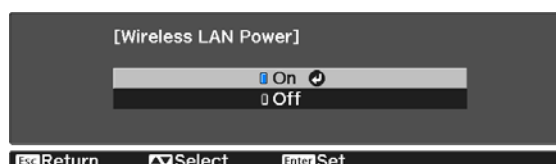



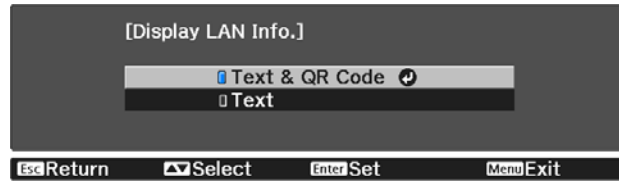

- 3 Display the **Network Configuration - Basic - Display LAN Info** menu.

4 Use the   buttons to select **Text & QR Code**, and then press the  button.



5 Press the  button on the remote control or select **Display the QR Code** in the projector's **Network** menu to display the QR code.



- If you press the  button, you can also display the QR code from the Home screen.  p.27
- If the projector is already receiving an image signal over the network, the QR code is not displayed even if you press the  button. Select **Display the QR Code** from the **Network** menu to display the QR code.
- To hide the QR code, press the  button.

6 Start Epson iProjection on your smartphone or tablet.

7 Tap  on the application screen.
The menu is displayed.

8 Tap **Connect** on the menu.
The projector search screen is displayed.

9 Tap **Read QR code** on the application screen.
Your camera starts and the preview screen is displayed.



When the projector you want to connect to is displayed in the list on the projector search screen, select the projector and tap **Connect** to connect.

10 Read the projected QR code on your smartphone or tablet.
Read the code from in front of the screen so that the QR code fits into the guide. If you are too far from the screen, the code may not be read.

When a connection is established, the image from the connected device is displayed. Tap **Photos**, **Documents**, or **Web Page** on the menu, and select the file you want to project.

Operating using a smartphone (remote control function)

By using Epson iProjection (Ver. 1.4.0 or later), you can operate the projector from a smartphone or tablet.

Tap  in Epson iProjection to display the menu.

Tap **Remote Control** on the menu to display the following screen.



When Remote Password is set, you need to enter the password. Once the password has been recognized, you do not need to enter it from the second time.

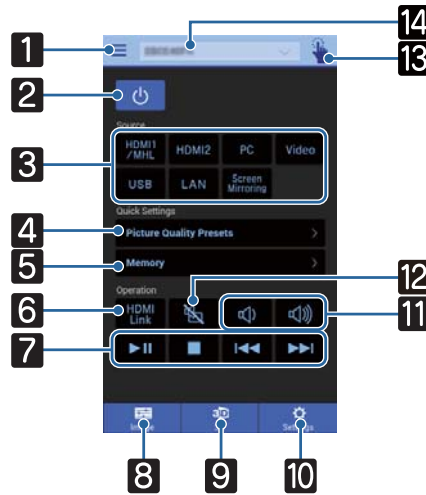

Button	Function
1	Displays the menu.
2	Turns the projector on or off.
3	Changes to the image from each input port. p.26
4	Sets the image quality using the on-screen instructions.
5	Saves, loads, erases, or rename a memory. p.39
6	Turns HDMI Link on or off. p.48
7	When HDMI Link is On, you can perform operations such as Play, Stop, Fast Forward, Rewind, Next Chapter, Previous Chapter, and Pause.
8	Sets the Color Mode, Frame Interpolation, Image Enhancement, Color Temp., RGBCMY, Power Consumption, and Auto Iris.
9	Sets the 3D Display, 3D Format, 2D-to-3D Conversion, 3D Depth, Diagonal Screen Size, and 3D Brightness.
10	Sets the Aspect, Image Processing, Keystone, Split Screen, Screen Mirroring, Reset All, Reset Memory, and Test Pattern.
11	Adjusts the volume.
12	Turns the video and audio on or off. p.32
13	Opens the touch pad screen. The touch pad allows you to operate the projector's menu screens by simply touching your device.
14	Select the projector you want to control when connecting to multiple projectors.

Projecting in Screen Mirroring

You can send images to your projector from mobile devices such as laptops, smartphones, and tablets using Intel WiDi (Ver. 3.5 or later) and Miracast technology.

If your device supports Intel WiDi or Miracast, you do not need to install any additional software.

Note the following limitations when using Screen Mirroring features.

- Multi-channel audio over 3 channels is played in 2 channels.
- The resolution and frame rate for images with a resolution above 1920 × 1080 and a frame rate above 50 fps are reduced before being projected.
- You cannot play 3D video.
- You may not be able to view contents with copyright protection with a Miracast connection.
- The audio and connection to Bluetooth audio devices may be lost due to radio wave interference.
- Bluetooth audio devices are not supported in some countries and regions.
- Audio may continue to be output from Screen Mirroring even when projecting images from a source other than Screen Mirroring.



Mobile devices such as Ultrabook, 2-in-1 devices with Intel Core 3rd generation or later processors installed mainly support Intel WiDi. Mobile devices with Android installed or Windows 8.1 installed mainly support Miracast. Support for Intel WiDi or Miracast varies depending on the mobile device. See your mobile device manual for details.

Selecting Screen Mirroring Settings

Select **Screen Mirroring Settings** on your projector to project images from your mobile device.

1 Press the  button to display menus in the order **Network - Screen Mirroring**.

2 Use the   buttons to select **On**, and then press the  button.



3 Select **Screen Mirroring Settings**, and then press the  button.

4 Select the Screen Mirroring settings as necessary.

- **Display Name:** Lets you enter a name up to 32 alphanumeric characters long to identify the projector from a list of available devices.
- **Adjust Image Quality:** Lets you adjust the Screen Mirroring speed/quality. Select a small number to improve the quality and select large number to increase the speed.



5 When you finish selecting settings, select **Set** and follow the on-screen instructions to save your settings and exit the menus.

Projecting in Windows 8.1

You can set up your computer for wireless projection from Charms in Windows 8.1. You can play audio through the projector's speaker system by connecting using Screen Mirroring.

1 Select **Screen Mirroring Settings** on your projector as necessary.

☞ [p.59](#)

2 Press the  button on the remote control to switch to the Screen Mirroring source. You see the Screen Mirroring standby screen.

3 On your computer, select **Devices** from Charms, and then select **Project**.



4 Select **Add a wireless display**.



You see a list of available devices.

5 Select the projector's Display Name from the list.

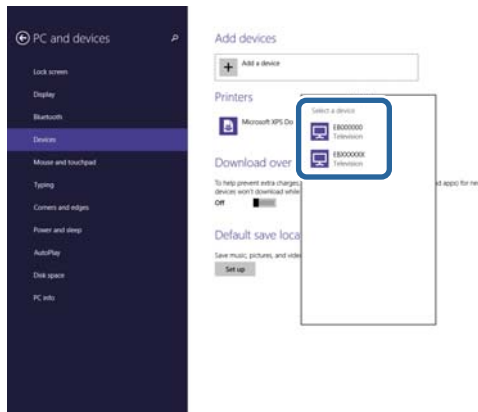

6 If you see the PIN entry screen on your computer, enter the PIN code displayed on the Screen Mirroring standby screen or at the bottom right of the projected image.

The projector displays the image from your computer.

 It may take some time until the connection is established. While connecting, do not disconnect the projector's power cord. Doing so may cause your device to freeze or malfunction.

Projecting Using Intel WiDi Software

If you are using Windows 7 or Windows 8 with the Intel WiDi software installed, you can connect to the projector wirelessly and project images.

You can play audio through the projector's speaker system by connecting using Screen Mirroring.

1 Select **Screen Mirroring Settings** on your projector as necessary.

 [p.59](#)

2 Press the  button on the remote control to switch to the Screen Mirroring source. You see the Screen Mirroring standby screen.

- 3 On your mobile device, start the Intel WiDi software.
You see a list of available devices.



- 4 Select the projector's Display Name from the list.

- 5 If you see the PIN entry screen on your mobile device, enter the PIN code displayed on the Screen Mirroring standby screen or at the bottom right of the projected image.
The projector displays the image from your mobile device.



It may take some time until the connection is established. While connecting, do not disconnect the projector's power cord. Doing so may cause your device to freeze or malfunction.

Projecting Using the Miracast Function

If your mobile device such as a smartphone supports Miracast, you can connect it to the projector wirelessly and project images.

You can play audio through the projector's speaker system by connecting using Screen Mirroring.

- 1 Select **Screen Mirroring Settings** on your projector as necessary.
 [p.59](#)

- 2 Press the  button on the remote control to switch to the Screen Mirroring source.
You see the Screen Mirroring standby screen.

- 3 On your mobile device, use your Miracast function to search for the projector.
You see a list of available devices.

- 4 Select the projector's Display Name from the list.

- 5 If you see the PIN entry screen on your mobile device, enter the PIN code displayed on the Screen Mirroring standby screen or at the bottom right of the projected image.

The projector displays the image from your mobile device.



It may take some time until the connection is established. While connecting, do not disconnect the projector's power cord. Doing so may cause your device to freeze or malfunction.

Depending on the mobile device, you may need to delete a device when connecting. Follow the on-screen instructions on your device.

Configuration Menu Functions



Configuration Menu Operations

On the Configuration menu, you can make adjustments and settings for Signal, Image, Input Signal, and so on.

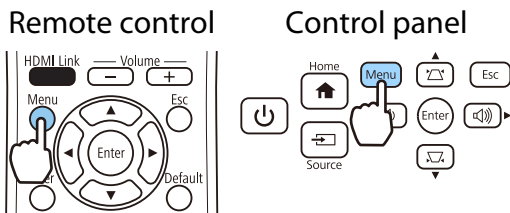
1 Press the  button.





The Configuration menu is displayed.

2 Use the   buttons to select the top menu on the left, and then press the  button to confirm the selection.

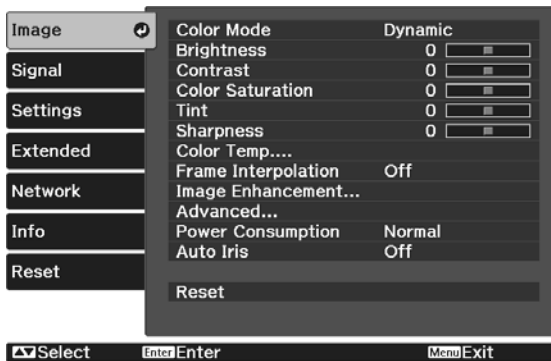
When you select the top menu on the left, the sub menu on the right changes.



The line at the bottom is a guide for operations.

3 Use the   buttons to select the sub menu on the right, and then press the  button to confirm the selection.

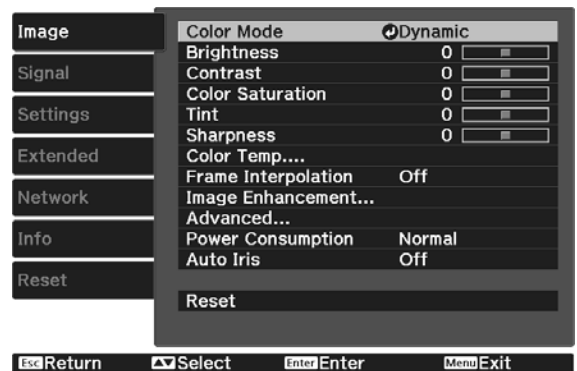

The adjustment screen for the selected function is displayed.

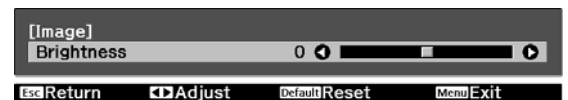

4 Use the     buttons to adjust the settings.

Ex.) Adjustment bar

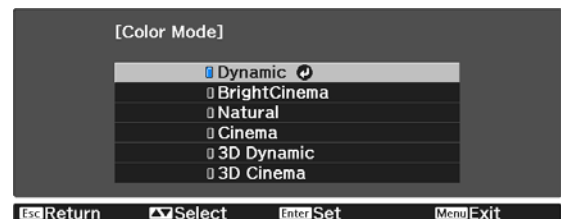

Ex.) Choices



Press the  button on an item displaying this  icon to change to the selection screen for that item.

Press the  button to return to the previous level.

5 Press the  button to exit the menu.

















For items adjusted using an adjustment bar, such as the brightness level, you can press the  button while the adjustment screen is displayed to return the adjustment value to its default value.

Configuration Menu Table

If there is no image signal being input, you cannot adjust items related to the **Image** or **Signal** in the Configuration menu. Note that the items displayed for the **Image**, **Signal**, and **Info** vary depending on the image signal being projected.

Image menu

Function	Menu/Settings		Explanation
Color Mode	Dynamic, BrightCinema, Natural, Cinema, 3D Dynamic, 3D Cinema		Select a color mode based on your surroundings and the image you are projecting.  p.33
Brightness			Adjusts the brightness when the image appears too dark.
Contrast			Adjusts the contrast between light and shade in the images. By increasing the contrast, the images become vivid.
Color Saturation			Adjusts the color saturation for the images.
Tint			Adjusts the tint for the images.
Sharpness			Adjusts the image sharpness.
Color Temp.	Color Temp.		Adjusts the tint for the images. The image is tinted blue for high values, and tinted red for low values.
	Customized		Adjusts the offset and gain for each R, G, and B color.
Frame Interpolation* ¹	Off, Weak, Normal, Strong		(This can only be set when Image Processing is set to Fine .) Adjusts the smoothness of movement of the image.
Image Enhancement* ²	Image Preset Mode	Off, Preset 1 to Preset 5	Select the settings prepared in advance as the settings for Noise Reduction , MPEG Noise Reduction , and Detail Enhancement .
	Noise Reduction		(This can only be set when Image Processing is set to Fine .) Adjusts the roughness of the image.
	MPEG Noise Reduction		Smooths out rough images in MPEG format.
	Detail Enhancement		Creates a more emphatic texture and material feel of the image.



Function	Menu/Settings			Explanation
Advanced	RGBCMY	R/G/B/C/M/Y	Hue, Saturation, Brightness	 Adjusts the hue, saturation, and brightness for each R, G, B, C, M, and Y color.  p.37
	EPSON Super White		On, Off	(This is only available when receiving signal input from the HDMI1 or HDMI2 port.) Set this to On if you are experiencing bright over exposure of whites in your image. When set to On , HDMI Video Range settings are disabled.
Power Consumption	Normal, ECO			You can set the lamp brightness to one of two settings. Select ECO if the images being projected are too bright. When ECO is selected, power consumption during projection decreases, and fan rotation noise is reduced.
Auto Iris	Off, Normal, High Speed			You can change the luminance adjustment tracking for changes in brightness in the displayed image.  p.36
Reset	Yes, No			Resets the adjustment values of Image set in the current Color Mode to the default settings.

*1 This is only displayed when a Video, HDMI1, or HDMI2 image signal is being input.

*2 This is only displayed when a Video, HDMI1, HDMI2, PC, or Screen Mirroring image signal is being input.

Signal menu

The Signal menu cannot be set when a USB or LAN image signal is being input.

Function	Menu/Settings		Explanation
3D Setup*1	3D Display	Auto, 3D, 2D	To view 3D images, set this to Auto or 3D .  p.42
	3D Format	Side by Side, Top and Bottom	Sets the 3D format for the input signal.
	2D-to-3D Conversion	Off, Weak, Medium, Strong	Converts 2D images to 3D images.
	3D Depth	-10 - 10	Sets the depth for the 3D image.
	Diagonal Screen Size	60 - 300	Sets the projection size for the 3D image. By matching this to the actual size, you can achieve the optimum 3D effect.
	3D Brightness	Low, Medium, High	Sets the brightness for the 3D image.
	Inverse 3D Glasses	Yes, No	Reverses the synchronization timing for the left/right shutters on the 3D Glasses and the left/right images. Enable this function if the 3D effect is not displayed correctly.
	3D Viewing Notice	On, Off	Turns the notice that appears when viewing 3D content on or off.
Aspect*2 *4	Auto*1, Normal, Full, Zoom		Selects the aspect mode.  p.34
Tracking*2 *3	Varies depending on the input signal.		Adjusts computer images when vertical stripes appear in the images.

Function	Menu/Settings		Explanation
Sync.*2 *3	0 - 31		<p>Adjusts computer images when flickering, fuzziness, or interference appear in the images.</p> <ul style="list-style-type: none"> Adjusting the Brightness, Contrast, or Sharpness may cause flickering or fuzziness. When adjusting Sync. after adjusting the Tracking, you can create a more vivid image.
Position*2 *4			Adjusts the display position up, down, left, and right when a part of the image is missing so that the whole image is projected.
Auto Setup*3	On, Off		Sets whether or not to automatically adjust the image whenever the input signal is changed. When enabled, the Tracking, Position, and Sync. are automatically configured.
Overscan *2	Auto *1, Off, 4%, 8%		<p>Changes the output image ratio (the range of the projected image).</p> <ul style="list-style-type: none"> Off, 4%, 8%: Sets the range of the image. Off projects all ranges. Depending on the image signal, you may notice noise at the top and bottom of the image. Auto: Automatically sets to Off or 8% depending on the input signal.
Advanced	HDMI Video Range*1 *2	Auto, Normal, Expanded	<p>(This can only be set when EPSON Super White is set to Off.)</p> <p>When set to Auto, the video level for the DVD input signal to the HDMI1 or HDMI2 ports is automatically detected and set.</p> <p>If you experience under or overexposure when set to Auto, set the video level of the projector to match that of the DVD player's video level. Your DVD player may be set to Normal or Expand.</p>
	Image Processing*1 *4 *5	Fine, Fast	Improves the response speed for images projected at high-speed, such as games.
Reset	Yes, No		Resets all Signal settings except for Diagonal Screen Size, 3D Viewing Notice, and Aspect.

*1 This is only displayed when a HDMI1 or HDMI2 image signal is being input.





*2 Settings are saved for each type of input source or signal.









*3 This is only displayed when a PC image signal is being input.

*4 This is only displayed when a PC or Video image signal is being input.

*5 This is only displayed when a Screen Mirroring image signal is being input.

Settings menu

Function	Menu/Settings		Explanation
Keystone	V-Keystone	-60 - 60	Corrects vertical distortion in an image.  p.31
	H-Keystone	-60 - 60	Corrects horizontal distortion in an image.  p.31
	Auto V-Keystone (EH-TW5350/EH-TW5300 only)	On, Off	Enables or disables Auto V-Keystone .  p.30
	H-Keystone Adjuster	On, Off	Enables or disables H-Keystone Adjuster .  p.31
Split Screen (EH-TW5350 only)	-		The screen is split in two, and images from the HDMI source and the Screen Mirroring source are displayed.
Volume	0 - 20		Adjusts the volume.
HDMI Link	Device Connections	-	Displays a list of devices connected to the HDMI1 or HDMI2 ports.
	HDMI Link	On, Off	Enables or disables the HDMI Link function.
	Audio Out Device	Projector, AV System	When an AV system is connected, you can set whether to output audio from the projector's speaker, or from the AV system's speaker.
	Power On Link	Off, Bidirectional, Device -> PJ, PJ -> Device	Sets the link function when the power is turned on. <ul style="list-style-type: none"> When linking operations to the connected device and turning on the projector, select Bidirectional or Device -> PJ. When linking power on for the projector to the connected device, select Bidirectional or PJ -> Device.
	Power Off Link	On, Off	Sets whether or not to power off connected devices when the projector is turned off.
Bluetooth*	Search Bluetooth Device	-	Searches for available Bluetooth devices and displays them as a list.
	Bluetooth Audio	On, Off	Enables or disables audio output from Bluetooth audio devices. Setup cannot be performed in the following cases. <ul style="list-style-type: none"> When the source is LAN When Audio Out Device is set to AV System from the HDMI Link menu

Function	Menu/Settings		Explanation
Lock Setting	Child Lock	On, Off	This locks the  button on the projector's control panel to prevent children from turning on the projector by accident. You can turn on the power when locked by holding down the  button for approximately three seconds. You can still turn off the device using the  button, or perform operations with the remote control as usual. If changed, this setting is enabled after you power off the projector and the cool-down process is complete. Note that even if Child Lock is set to On , the projector still turns on when the power cord is connected if Direct Power On is set to On .
	Control Panel Lock	Full Lock, Partial Lock, Off	Full Lock: Disables all of the projector's buttons. Partial Lock: Disables all of the projector's buttons except for the  button.  is displayed on the screen if buttons are pressed while the projector is locked. To unlock, press and hold the  button on the control panel for at least 7 seconds. If changed, this setting is enabled once you close the Configuration menu.
User Button	Fine/Fast, 2D-to-3D Conversion, Power Consumption, Info, Display the QR Code (EH-TW5350 only)		Select a Configuration menu item to assign to the  button on the remote control. By pressing the  button, the assigned menu item selection/adjustment screen is displayed, allowing you to make one-touch settings/adjustments.
Memory	Load Memory	Memory1 to Memory10	Loads the settings saved in Save Memory to adjust the image.
	Save Memory	Memory1 to Memory10	Saves the settings made in Image to a memory.
	Erase Memory	Memory1 to Memory10	Erases a saved memory.
	Rename Memory	Memory1 to Memory10, Default, DVD, VCR, SDTV, HDTV, Cinema, Sports, Music, Anime, Game, Customized	Changes the saved memory name.
Reset	Yes, No		Resets all Settings except for Audio Out Device, Power On Link, Power Off Link, User Button, and Memory .

* Bluetooth audio devices are not supported in some countries and regions.

Extended menu

Function	Menu/Settings		Explanation
Home Screen	Home Screen Auto Disp.	On, Off	Selects whether or not to display the Home screen automatically when the projector turns on. The Home screen is not displayed when the selected source has an image signal when the projector turns on.
	Custom Function 1	Power Consumption, Auto Iris, Keystone, Info	Select the function assigned to the Home screen.
	Custom Function 2		
Display	Messages	On, Off	<p>Sets whether or not to display the following messages (On or Off).</p> <ul style="list-style-type: none"> Item names for image signals, color modes, and aspect ratios. If the internal temperature is rising when no image signal is being input or an unsupported signal is detected.
	Display Background	Black, Blue, Logo	Selects the screen status when no image signal is being input.
	Startup Screen	On, Off	Sets whether or not to show a startup screen when projection begins (On or Off). If changed, this setting is enabled after you power off the projector and the cool-down process is complete.
Projection	Front, Front/Ceiling, Rear, Rear/Ceiling		Change this setting depending on how the projector is installed.
Operation	Direct Power On	On, Off	<p>You can set up the projector so that projection starts as soon as the power cord is plugged in without any button operations.</p> <p>Note that when this is set to On, projection starts if power is restored after a blackout or other power outage and the power cord is still plugged into the projector.</p>
	Sleep Mode	On, Off	If the set time is exceeded and no signal is input, the projector is automatically turned off and enters standby mode. When in standby mode, press the  button on the remote control or the control panel to start projection.
	Sleep Mode Timer	1 - 30	Sets the interval for Sleep Mode .
	Illumination	On, Off	Set this to Off if the light from the indicators on the control panel bother you when watching a movie in a dark room.
	High Altitude Mode	On, Off	Set this to On if you are using the projector above an altitude of 1500 meters.
	Auto Source Search	On, Off	Set to On to detect the input signal automatically and project images when there is no input signal.

Function	Menu/Settings	Explanation
Standby Mode	Communication Off, Communication On	Communication On indicates that the projector can be monitored over a network when the projector is in standby mode.
Language	-	Selects the display language.
Reset	Yes, No	Resets all Extended settings except for Projection, High Altitude Mode, Standby Mode, and Language .

■ Network menu (EH-TW5350 only)

Function	Menu/Settings	Explanation
Screen Mirroring	On, Off	Enables or disables Screen Mirroring.
Screen Mirroring Info	Display Name, MAC Address, Region Code, Version	Displays information on Screen Mirroring.
Screen Mirroring Settings	Display Name	- (Only available when Screen Mirroring is set to On .) Enter a name to identify the projector when searching for the projector using the Screen Mirroring feature.
	Adjust Image Quality	1 (Fine), 2, 3, 4 (Fast) (Only available when Screen Mirroring is set to On .) Adjusts the Screen Mirroring speed/quality.
	Reset	Yes, No Resets all adjustment values on the Screen Mirroring Settings menu to their default settings.
Wireless LAN Power	On, Off	Sets whether or not to use a wireless LAN (On or Off).
Network information - Wireless LAN	-	Displays the following network settings. <ul style="list-style-type: none"> • Connection Mode • Wireless LAN system • Antenna Level • Projector Name • SSID • DHCP • IP Address • Subnet Mask • Gateway Address • MAC Address • Region Code
Display the QR Code	-	(Only available when Wireless LAN Power is set to On .) Displays network information for the projector with a QR code.
Network Configuration	-	Displays the screen to set the network.  p.72

Notes on operating the Network menu

Basic operations are made in the same way as when using the Configuration menu. However, be sure to select the **Setup complete** menu to save your settings when done.



- Yes:** Saves the settings and exits the Network menu.
- No:** Exits the Network menu without saving the settings.
- Cancel:** Continues displaying the Network menu.

Soft Keyboard Operations

In the Network menu, the soft keyboard appears when you need to enter numbers and characters. Use the on the remote control or on the control panel to select the desired key, and then press the button to enter. Press **Finish** to confirm your input, or **Cancel** to cancel your input.

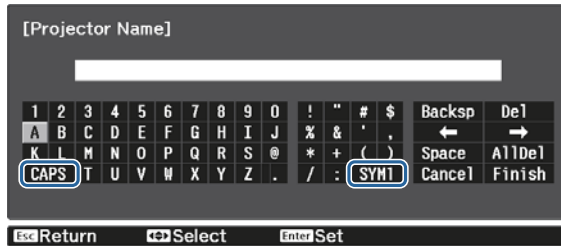



- CAPS key:** Switches between uppercase and lowercase letters.
- SYM1/2 key:** Switches the symbol keys.

Basic menu

Function	Menu/Settings	Explanation
Projector Name	Up to 16 alphanumeric characters	Enter a name to identify the projector over a network.
Remote Password	Up to 8 alphanumeric characters	When operating the projector from a smartphone or a tablet, enter a password for accessing the projector.
Display LAN Info.	Text & QR Code, Text	Set the display format for the projector's network information.

Wireless LAN menu

Function	Menu/Settings	Explanation
Connection Mode	Quick, Advanced	Determines how the wireless LAN is connected. Quick: lets you quickly connect to one smartphone, tablet, or computer. Advanced: lets you connect to multiple smartphones, tablets, or computers over a wireless network access point. The connection is established in infrastructure mode.
Channel	1ch, 6ch, 11ch	(This can only be set when Connection Mode is set to Quick .) Select the frequency bandwidth used by the wireless LAN.
SSID	Up to 32 alphanumeric characters	(This can only be set when Connection Mode is set to Advanced .) Enter an SSID. When an SSID is provided for the wireless LAN system in which the projector participates, enter the SSID.
Search Access Point	To Search View	(This can only be set when Connection Mode is set to Advanced .) Search for available wireless network access points.  indicates currently connected access points.  indicates the access points where security is set. If you select an access point which has security, Security menu appears.  p.73
IP Settings (This can only be set when Connection Mode is set to Advanced .)	DHCP	Sets whether or not to use DHCP (On or Off). If this is set to On , you cannot set any more addresses.
	IP Address	Inputs the IP address for the projector. The following IP addresses cannot be used. 0.0.0.0, 127.x.x.x, 224.0.0.0 to 255.255.255.255 (where x is a number from 0 to 255)
	Subnet Mask	Inputs the subnet mask for the projector. The following subnet masks cannot be used. 0.0.0.0, 255.255.255.255
	Gateway Address	Inputs the gateway IP address of the projector. The following gateway addresses cannot be used. 0.0.0.0, 127.x.x.x, 224.0.0.0 to 255.255.255.255 (where x is a number from 0 to 255)
SSID Display	On, Off	Sets whether or not to display the SSID on the LAN Standby screen and the Home screen (On or Off).
IP Address Display	On, Off	Sets whether or not to display the IP address on the LAN Standby screen and the Home screen (On or Off).

Security menu

Function	Menu/Settings	Explanation
Security	No, WPA2-PSK, WPA/WPA2-PSK	Sets the security. Select WPA2-PSK in Quick and WPA/WPA2-PSK in Advanced .
Passphrase	From 8 to 32 single-byte alphanumeric characters	Inputs the passphrase. It is recommended to change the passphrase periodically for the purpose of security.

Reset menu

Function	Explanation
Reset network settings.	You can reset all adjustment values for Network to their default settings.

Info menu

Function	Menu/Settings	Explanation
Projector Info	Lamp Hours	Displays the cumulative lamp operating time*.
	Source	Displays the current input source.
	Input Signal	Displays the input signal setting of the current input source.
	Resolution	Displays the resolution.
	Scan Mode	Displays the scan mode.
	Refresh Rate	Displays the refresh rate.
	3D Format	Displays the 3D format of the signal input during 3D projection (Frame Packing, Side by Side, or Top and Bottom).
	Sync Info	Displays the image signal information. This information may be needed if service is required.
	Deep Color	Displays deep color.
	Status	This is information about errors that have occurred on the projector. This information may be needed if service is required.
	Serial Number	Displays the projector's serial number.
	Event ID	The application error log appears.  p.88
Version	Main	Displays the firmware version of the projector.
	Video2	
	Screen Mirroring	







*The cumulative use time is displayed as "0H" for the first 10 hours. 10 hours and above is displayed as "10H", "11H", and so on.

Reset menu

Function	Explanation
Reset All	Resets all items in the Configuration menu to their default settings. The following items are not reset to their defaults: Memory, Lamp Hours, Language , and all adjustment values for the Network menu.
Reset Memory	Resets all items for Memory to their default settings.
Reset Lamp Hours	Resets the cumulative lamp hours use time to 0 H . Reset when you replace the lamp.

Problem Solving



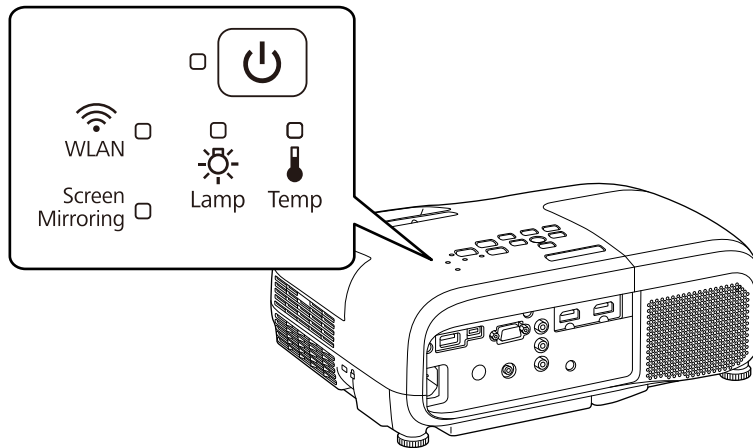

Reading the Indicators











You can check the status of the projector from the flashing and lit  ,  (operation indicators),  ,  ,  , and  on the control panel.



















Refer to the following table to check the projector's status and how to remedy problems shown by the indicators.

Indicator status during an error/warning

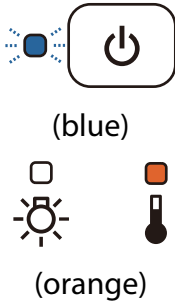

 : Lit  : Flashing  : Status maintained  : Off





Indicators	Status	Remedy
  (blue)   (orange)	Replace Lamp	It is time to replace your lamp. Replace the lamp with a new lamp as soon as possible.  p.92 The lamp may explode if you continue to use it in this status.
  (blue)   (orange)	High Temp Warning	You can continue projecting. If the temperature rises too high again, projection stops automatically. <ul style="list-style-type: none"> • If the projector is installed next to a wall, make sure there is at least 20 cm between the wall and the projector's exhaust vent. • If the air filter is clogged, clean it.  p.90

Indicators	Status	Remedy
 (blue)  (orange)	Internal Error	<p>The projector has malfunctioned. Remove the power plug from the electrical outlet, and contact your local dealer or the nearest Epson repair center.  Epson Projector Contact List</p>
 (blue)  (orange)	Fan Error Sensor Error	
 (blue)  (orange)	Auto Iris Error	
 (blue)  (orange)	Power Err. (Ballast)	
 (blue)  (orange)	Lamp Error Lamp Failure Lamp Cover Open	<p>There is a problem with the lamp, or it failed to turn on.</p> <ul style="list-style-type: none"> • Disconnect the power cord, and then check if the lamp is cracked.  p.92 If it is not cracked, reinstall the lamp and turn on the power. If reinstalling the lamp does not fix the problem, or if the lamp is cracked, remove the power plug from the electrical outlet, and contact your local dealer or the nearest Epson repair center.  Epson Projector Contact List • Check that the lamp cover has been properly closed.



Indicators	Status	Remedy
 <p>(blue)</p> <p>(orange)</p>	High Temp Error (Overheating)	<p>The internal temperature is too high.</p> <ul style="list-style-type: none"> • The lamp turns off automatically and projection stops. Wait for about five minutes. When the fan has stopped, disconnect the power cord. • If the projector is installed next to a wall, make sure there is at least 20 cm between the wall and the projector's exhaust vent. • If the air filter is clogged, clean it.  p.90 • When using at an altitude of 1500 m or more, set High Altitude Mode to On.  Extended - Operation - High Altitude Mode p.70 • If turning the power back on does not clear the problem, stop using the projector and remove the power plug from the electrical outlet. Contact your local dealer or the nearest Epson repair center.  Epson Projector Contact List

 Indicator status during normal operation



 : Flashing  : Lit  : Off





Indicators	Status	Remedy
 <p>(blue)</p>	Standby condition	When you press the  button on the remote control or the control panel, projection starts after a short wait.
 <p>(blue)</p>	Warm-up in progress	Warm-up time is about 30 seconds. The power-off operation is disabled while the projector is warming-up.
	Cool-down in progress	All operations are disabled while the projector is cooling-down. The projector enters standby condition when cool-down is complete. If for any reason the power cord is disconnected during cool-down, wait until the lamp has cooled down sufficiently (about 10 minutes), reconnect the power cord, and then press the  button on the remote control or the control panel.
 <p>(blue)</p>	Projection in progress	The projector is operating normally.







- Under normal operating conditions, the  and  indicators are off.
- When the **Illumination** function is set to **Off**, all indicators are off under normal projection conditions.  **Extended - Operation - Illumination** [p.70](#)





 Screen Mirroring indicator and status (EH-TW5350 only)

 : Flashing  : Lit  : Off

Indicators	Status	Explanation
Screen Mirroring  (blue)	Ready	Screen Mirroring is available.
Screen Mirroring  (Flashing blue quickly)	Connecting	Connecting to a mobile device.
Screen Mirroring  (Flashing blue slowly)	Error	Screen Mirroring error. Select Off as the Screen Mirroring setting in the projector's Network menu, and select On again.
Screen Mirroring 	Starting Screen Mirroring Off	Screen Mirroring is not available. Check that Screen Mirroring is set to On in the Network menu.

 Wireless LAN indicator and status (EH-TW5350 only)

 : Flashing  : Lit  : Off

Indicators	Status	Explanation
WLAN  (blue)	Ready	Wireless LAN is available.
WLAN  (Flashing blue quickly)	Connecting	Connecting to a device.
WLAN  (Flashing blue slowly)	Error	Wireless LAN error. Select Off as the Wireless LAN Power setting in the projector's Network menu, and select On again. If you cannot solve the problem, contact the following address.  Epson Projector Contact List
WLAN 	Starting Wireless LAN Off	Wireless LAN connection is unavailable. Check that Wireless LAN Power is set to On in the Network menu.

When the Indicators Provide No Help

 Check the problem

Check the following table to see if your problem is mentioned, and go to the appropriate page for information on handling the problem.

Problem		Page
Problems relating to images	No images appear. Projection does not start, the projection area is completely black, or the projection area is completely blue.	p.79
	Moving images being projected from a computer are not projected.	p.80
	" Not supported " is displayed.	p.80
	" No Signal " is displayed.	p.80
	Images are fuzzy or out of focus.	p.81
	Interference or distortion appears in the images.	p.81
	The image is truncated (large) or small, or only a part of the image is projected.	p.81
	Image colors are not right. The whole image appears purplish or greenish, images are black & white, or colors appear dull.*1	p.82
	Images appear dark.	p.82
	Projection stops automatically.	p.82
Problems when projection starts	The projector does not turn on.	p.83
Problems with the remote control	The remote control does not respond.	p.83
Problems with 3D	Cannot project correctly in 3D.	p.83
Problems with HDMI	HDMI Link does not function.	p.84
	The device name is not displayed under device connections.	p.85
Network problems	Cannot access the network via wireless LAN.	p.85
	The image contains static during network projection.	p.85
	Cannot connect using Screen Mirroring.	p.85
	The image contains static during Screen Mirroring connection.	p.86
Bluetooth device problems*2	Cannot connect Bluetooth device.	p.87
	The audio and connection for the Bluetooth device disconnects.	p.87
Other problems	No audio, or the audio is too low.	p.87
	Cannot make settings on the control panel.	p.88
	Slideshow does not start.	p.88



*1 Because color reproduction differs between monitors and computer LCD screens, the image projected by the projector and the color tones displayed on the monitor may not match, however this is not a fault.

*2 Bluetooth audio devices are not supported in some countries and regions.

Problems relating to images

No images appear



Check	Remedy
Is the projector turned on?	Press the  button on the remote control or the control panel.
Is the power cord connected?	Connect the power cord.

Check	Remedy
Are the indicators switched off?	Disconnect and then reconnect the projector's power cord. Check that pressing the power button after connection supplies the projector with power.
Is an image signal being input?	Check that the connected device is turned on. When Messages is set to On from the Configuration menu, image signal messages are displayed.  Extended - Display - Messages p.70
Are the Configuration menu settings correct?	Reset all of the settings.  Reset - Reset All p.74
(Only when projecting computer image signals) Was the connection made while the power of the projector or the computer was already turned on?	If the connection is made while the power is already turned on, the Fn key (Function key) that changes the computer's image signal to external output may not work. Turn off the power for the computer and the projector and then turn it back on again.



Moving images are not displayed

Check	Remedy
(Only when projecting computer image signals) Is the computer's image signal set to external output and to output to the LCD monitor at the same time?	Depending on the computer's specifications, moving images may not be displayed when the computer is set to external output and to the LCD monitor output at the same time. Change it so that the image signal is set to external output only. For the computer's specifications, see the documentation supplied with the computer.

"Not supported" is displayed



Check	Remedy
(Only when projecting computer image signals) Do the image signal's frequency and resolution correspond to the mode?	Check the image signal being input in Resolution from the Configuration menu, and check that it corresponds to the projector's resolution.  About - Projector Info p.74  p.96

"No Signal" is displayed



Check	Remedy
Are the cables connected correctly?	Check that all the cables required for projection are securely connected.  p.19
Is the correct image input port selected?	Change the image with the source buttons on the remote control, or the  button on the control panel.  p.26
Is the connected device turned on?	Turn on the device.

Check	Remedy
(Only when projecting computer image signals) Are the image signals being output to the projector?	Change it so that the image signal is set to external output, and not just the computer's LCD monitor. For some models, when the image signals are output externally, they no longer appear on the LCD monitor. For the computer's specifications, see the documentation supplied with the computer. If the connection is made while the power of the projector or the computer is already turned on, the Fn key (Function key) that changes the computer's image signal to external output may not work. Turn the power for the computer and the projector off and then back on again.

Images are fuzzy or out of focus

Check	Remedy
Has the focus been adjusted?	Adjust the focus.  p.29
Is the lens cover closed?	Open the lens cover.  p.26
Is the projector at the correct distance?	Check the recommended projection range.  p.17
Has condensation formed on the lens?	If the projector is suddenly taken from a cold environment to a warm environment, or if sudden ambient temperature changes occur, condensation may form on the surface of the lens, and this may cause the images to appear fuzzy. Set the projector up in the room about one hour before it is used. If the projector is wet from condensation, turn off the projector, disconnect the power cord, and leave it for a while.

Interference or distortion appear in images

Check	Remedy
Are the cables connected correctly?	Check that all the cables required for projection are securely connected.  p.19
Is an extension cable being used?	If an extension cable is used, electrical interference may affect the signals.
(Only when projecting computer image signals) Are the Sync. and Tracking settings adjusted correctly?	The projector uses automatic adjustment functions to project at the optimum status. However, depending on the signal, some may not be adjusted correctly even after performing self corrections. If this happens, adjust the Tracking and Sync. settings from the Configuration menu.  Signal - Tracking/Sync. p.66
(Only when projecting computer image signals) Is the correct resolution selected?	Set the computer so that the signals being output are compatible with the projector.  p.96

Part of the image is truncated (large) or small

Check	Remedy
Is the correct Aspect selected?	Select the aspect mode to match the input signal in Aspect from the Configuration menu.  Signal - Aspect p.66

Check	Remedy
Is the image Position adjusted correctly?	Adjust the Position setting from the Configuration menu. ☛ Signal - Position p.66
(Only when projecting computer image signals) Is the correct resolution selected?	Set the computer so that the signals being output are compatible with the projector. ☛ p.96

Image colors are not right

Check	Remedy
Are the cables connected correctly?	Check that all the cables required for projection are securely connected. ☛ p.19 For the Video and PC ports, make sure the connector is the same color as the cable port. ☛ p.19
Is the contrast adjusted correctly?	Adjust the Contrast setting from the Configuration menu. ☛ Image - Contrast p.65
Is the color adjusted correctly?	Adjust the Advanced setting from the Configuration menu. ☛ Image - Advanced p.65
(Only when projecting images from a video device) Are the color saturation and tint adjusted correctly?	Adjust the Color Saturation and Tint settings from the Configuration menu. ☛ Image - Color Saturation/Tint p.65

Images appear dark



Check	Remedy
Is the image brightness set correctly?	Adjust the Brightness setting from the Configuration menu. ☛ Image - Brightness p.65
Is the contrast adjusted correctly?	Adjust the Contrast setting from the Configuration menu. ☛ Image - Contrast p.65
Is it time to replace the lamp?	When the lamp is nearly ready for replacement, the images become darker and the color quality becomes poorer. When this happens, replace the lamp with a new lamp. ☛ p.92

Projection stops automatically

Check	Remedy
Is Sleep Mode enabled?	If the set time is exceeded and no signal is input, the lamp is automatically turned off and the projector enters standby mode. The projector returns from standby mode when you press the  button on the remote control or the control panel. If you want to disable Sleep Mode , change the setting to Off . ☛ Extended - Operation - Sleep Mode p.70

■ Problems when projection starts

The projector does not turn on

Check	Remedy
Is the power turned on?	Press the  button on the remote control or the control panel.
Is Child Lock set to On ?	When Child Lock is set to On from the Configuration menu, hold down the  button on the control panel for approximately three seconds, or perform operations from the remote control. ☛ Settings - Lock Setting - Child Lock p.68
Do the indicators turn on and off when the power cord is touched?	Turn off the projector, and then disconnect and reconnect the projector's power cord. If the problem continues, stop using the projector, remove the power plug from the electrical outlet, and contact your local dealer or the nearest projector information center. ☛ Epson Projector Contact List

■ Problems with the remote control





The remote control does not respond

Check	Remedy
Is the remote control light-emitting area pointing towards the remote receiver on the projector during operation?	Point the remote control towards the remote receiver. Also, check the operating range. ☛ p.25
Is the remote control too far from the projector?	Check the operating range. ☛ p.25
Is direct sunlight or strong light from fluorescent lamps shining onto the remote receiver?	Set the projector up in a location where strong light does not shine onto the remote receiver.
Are the batteries dead or have the batteries been inserted correctly?	Make sure the batteries are inserted correctly or replace the batteries with new ones if necessary. ☛ p.24

■ Problems with 3D



Cannot project correctly in 3D

Check	Remedy
Are the 3D Glasses turned on?	Turn on the 3D Glasses.
Is a 3D image being projected?	If the projector is projecting a 2D image, or if an error occurs on the projector that prevents the 3D image from being projected, you cannot view 3D images even if you are wearing the 3D Glasses.
Is the input image in 3D?	Check that the input image is 3D compatible. Since most TV broadcasts do not contain a 3D format signal, 3D reception must be set manually.

Check	Remedy
Is 3D Display set to 2D ?	If 3D Display is set to 2D from the Configuration menu, the projector does not automatically change to 3D even when a 3D image is input. Press the  button, and then set 3D Display to 3D or Auto .  Signal - 3D Setup - 3D Display p.66
Is 3D Format set correctly?	Unless the 3D format of the AV device and 3D Format of the projector are the same, part of the image may not be displayed. Check that the projector's 3D Format setting matches the 3D format setting for the AV device.  Signal - 3D Setup - 3D Format p.66 When changing the 3D Format , set 3D Display to Auto , and then press the  button.
Are you viewing within the reception range?	If the distance between the projector and the 3D Glasses exceed 10 m, the connection may be lost. Move the 3D Glasses closer to the projector.
Has pairing been performed correctly?	See the User's Guide for the 3D Glasses to perform pairing.
Are there any devices that cause radio wave interference in the vicinity?	When using other devices at the same time with the frequency band (2.4 GHz) such as Bluetooth communication devices, wireless LAN (IEEE802.11b/g), or microwave ovens, radio wave interference may occur, the image may be interrupted, or communication may not be possible. Do not use the projector near these devices.

■ Problems with HDMI

HDMI Link does not function

Check	Remedy
Are you using a cable that meets the HDMI standards?	Operations are not possible with cables that do not meet the HDMI standards.
Does the connected device meet the HDMI CEC standards?	If the connected device does not meet the HDMI CEC standards, it cannot be operated even if it is connected to the HDMI port. See the documentation and so on supplied with the connected device for more information. Also, press the  button, and then check if the device is available under Device Connections .  p.49
Are the cables connected correctly?	Check that all the cables required to use HDMI Link are securely connected.  p.48
Is the power for the amplifier or DVD recorder and so on turned on?	Put each device in standby status. See the documentation and so on supplied with the connected device for more information. If you have connected a speaker and so on, set the connected equipment to PCM output.
Was a new device connected, or was the connection changed?	If the CEC function for a connected device needs to be set again, for example when a new device is connected or the connection is changed, you may need to restart the device.
Are many multi-media players connected?	Up to 3 multi-media players that meet the HDMI CEC standards can be connected at the same time.

The device name is not displayed under Device Connections

Check	Remedy
Does the connected device meet the HDMI CEC standards?	If the connected device does not meet the HDMI CEC standards, it is not displayed. See the documentation and so on supplied with the connected device for more information.

■ Network problems

Cannot access the network via wireless LAN

Check	Remedy
Is Wireless LAN Power set to Off ?	Set Wireless LAN Power to On in the Configuration menu. If this is already set to On , set Wireless LAN Power to Off , and then set it to On again. 🖱️ Network - Wireless LAN Power p.71
Is the passphrase correct?	Note that the passphrase is case sensitive; upper case and lower case letters are treated as different characters. If you have forgotten your passphrase, set a new one. 🖱️ Network Settings - Security - Passphrase p.71
Have you checked the Event ID?	Check the Event ID number and perform the following steps. 🖱️ Info - Event ID p.74 🖱️ p.88

The image contains static during network projection

Check	Remedy
Are there any obstacles between the access point and the connected device?	Check for any obstacles between the access point, the mobile device, the computer, and the projector, and change their positions to improve communication.
Is the distance between the access point and the connected device too far?	Make sure that the access point, the mobile device, the computer, and the projector are not too far apart. Move them closer together and try to connect again.
Are there any Bluetooth devices or microwave oven in the vicinity?	If the wireless connection is slow or your projected image contains noise, check for interference from other equipment, such as a Bluetooth device or microwave. Move the interfering device farther away or expand your wireless bandwidth.
Are too many devices connected?	Reduce the number of connected devices if the connection speed declines.

Cannot connect using Screen Mirroring

Check	Remedy
Is Screen Mirroring set to Off ?	Set Screen Mirroring to On in the Configuration menu. If this is already set to On , set Screen Mirroring to Off , and then set it to On again. 🖱️ Network - Screen Mirroring p.71
Is there a hyphen (-) in the display name?	Change the Display Name so that it does not include "-" in the projector's Screen Mirroring Settings menu. If the Display Name includes "-", it may not be displayed correctly on your mobile device. 🖱️ Network - Screen Mirroring Settings p.71

Check	Remedy
Is the Screen Mirroring indicator lit blue?	Make sure the Screen Mirroring indicator turns blue and the Screen Mirroring standby screen is displayed.  p.77
Are other mobile devices already connected?	Make sure no other mobile device is connected to the projector.
Are the settings correct for the mobile device?	Make sure the settings on the mobile device are correct. If the settings are correct, restart the mobile device.
Are you trying to reconnect immediately after the Screen Mirroring connection has ended?	When connecting again immediately after disconnecting, it may take some time until the connection is established. Reconnect after waiting for a while.
Are you connecting from the connection history of the mobile device?	Once you have connected using Screen Mirroring, the projector connection information may be recorded on the mobile device. However, you may not be able to reconnect to the projector from the recorded information. Select the projector from the list of available devices.
Is wireless LAN with a 5 GHz bandwidth being used by devices with Intel WiDi?	If your mobile device supports Intel WiDi and uses 5 GHz Wireless LAN, you cannot connect using Screen Mirroring and Wireless LAN at the same time. Turn off the Wireless LAN and connect using Screen Mirroring.

The image contains static during Screen Mirroring connection

Check	Remedy
Is the Wi-Fi antenna of the mobile device covered?	Try not to cover the Wi-Fi antenna of the mobile device.
Is the mobile device connected to the internet?	If you use a Screen Mirroring connection and an internet connection at the same time, the image may stop or contain noise. Disconnect the internet connection to expand your wireless bandwidth and improve the connection speed of the mobile device.
Is there a problem in the projected content?	Content that can be projected in Screen Mirroring is subject to restrictions. Make sure the projected content meets the requirements.  p.59
Does the mobile device have a power saving setting?	Depending on the settings of the mobile device, the connection may be lost when the device enters the power saving mode. Check the electrical power saving settings on the mobile device.
Is the mobile device using the latest version of its wireless driver or firmware?	Update to the latest version of the wireless driver or firmware on the mobile device.

 Bluetooth device problems



Bluetooth audio devices are not supported in some countries and regions.

Cannot Connect Bluetooth Device



Check	Remedy
Was a device search performed?	When connecting a Bluetooth device for the first time, or when changing to another Bluetooth device, perform Search Bluetooth Device .  p.21
Does the device support copyright protection (SCMS-T)?	You cannot connect a Bluetooth device that does not support copyright protection (SCMS-T).
Is the device based on A2DP?	You cannot connect a Bluetooth device that does not support A2DP.

The audio and connection for the Bluetooth device disconnects

Check	Remedy
Are there any obstacles between the projector and the Bluetooth device?	Check for any obstacles between the projector and the Bluetooth device, and change their positions to improve communication.
Is the device connected within the specified communication distance?	If the distance between the projector and the Bluetooth device exceed 10 m, the connection may be lost. Move the Bluetooth device closer to the projector.
Are there any wireless equipment or microwave ovens in the vicinity?	If the device is used at the same time as other wireless equipment or microwave ovens, radio wave interference may occur, and the image and audio may be interrupted. Avoid equipment that could cause interference.



Other problems

No audio, or the audio is too low

Check	Remedy
Is the audio cable connected correctly?	Try disconnecting the cable from the Audio (L-R) port, and then reconnecting.
Is the volume too low?	Adjust the volume so that you can hear the audio.  p.32
Is it connected with an HDMI cable?	If no audio is output when connecting via an HDMI cable, set the connected equipment to PCM output.
Are the Audio Out Device settings correct?	Check that the Audio Out Device settings are correct on the Configuration menu.  Settings - HDMI Link - Audio Out Device p.68
Are the Bluetooth Audio settings correct?*	Make the following settings when connecting a Bluetooth audio device. <ul style="list-style-type: none"> • To output audio from the projector's speaker or an AV system, set Bluetooth Audio to Off. • To output audio from Bluetooth audio devices, set Bluetooth Audio to On.  Settings - Bluetooth - Bluetooth Audio p.68

* Bluetooth audio devices are not supported in some countries and regions.

Cannot make settings on the control panel

Check	Remedy
Is Control Panel Lock set to Full Lock or Partial Lock ?	When Control Panel Lock is set to Full Lock in the Configuration menu, all button operations on the control panel are disabled; when Partial Lock is set, only the  button on the control panel is available. Perform operations from the remote control.  Settings - Lock Setting - Control Panel Lock p.68

Slideshow does not start

Check	Remedy
Is the USB storage device using a security function?	You may not be able to use USB storage devices that incorporate security functions.

About Event ID

Check the event ID and perform the remedy given below. If you cannot resolve the problem, contact your local dealer or the nearest Epson repair center.

 [Epson Projector Contact List](#)

Event ID	Cause	Remedy
0021	Failed to startup Screen Mirroring.	Restart the projector.
0022 0027 0028 0029 0030 0031 0035 0434 0481 0482 0485	Network communication is unstable.	Check the network communication status, and reconnect after waiting for a while.
0023 0024 0025	Connection failed.	If you see the PIN entry screen on your computer, enter the PIN code displayed on the Screen Mirroring standby screen or at the bottom right of the projected image. If this does not solve the problem, restart the projector and the connected devices, and then check the connection settings.
0432 0435	Failed to startup EasyMP Network Projection.	Restart the projector.
0433	An image that was transferred cannot be reproduced.	Restart EasyMP Network Projection.
0484	Communications was cut off from the computer.	
0483 04FE	EasyMP Network Projection ended unexpectedly.	Check the status of network communications. Wait for a while and then try connecting again.

Event ID	Cause	Remedy
0479 04FF	A system error occurred in the projector.	Restart the projector.
0891	The same SSID access point cannot be found.	Set the computer, the access point, and the projector to the same SSID.
0892	WPA and WPA2 authentication type mismatch.	Check the setting of wireless LAN security to see if it is correct.
0894	Communications was cut off because a connection was made to the wrong access point.	Check with the network administrator and follow their instructions.
0898	Failed to acquire the DHCP.	Check the DHCP server to see if it is operating correctly. Turn off DHCP if it is not being used. ☛ Network Settings - Wireless LAN - IP Settings - DHCP p.71
0020 0026 0032 0036 0037 0038 0899	Other connection errors	If restarting the projector or network applications does not solve the problem, contact one of the following addresses. ☛ Epson Projector Contact List

Maintenance

Cleaning the Parts

You should clean the projector if it becomes dirty or if the quality of projected images starts to deteriorate.

Warning

Do not use sprays that contain flammable gas to remove dirt and dust from the projector's lens, air filter, and so on. The projector may catch fire due to the high internal temperature of the lamp.

Cleaning the air filter

Clean the air filter if dust has accumulated on the air filter or when the following message is displayed. **"The projector is overheating. Make sure nothing is blocking the air vent, and clean or replace the air filter."**

Attention

- If dust collects on the air filter, it can cause the internal temperature of the projector to rise, and this can lead to problems with operation and shorten the optical engine's service life. It is recommended that you clean the air filter at least once every three months. Clean them more often than this if using the projector in a particularly dusty environment.
- Do not rinse the air filter in water. Do not use detergents or solvents.
- Lightly brush the air filter to clean it. If it is brushed too strongly, dust will be ground into the air filter and cannot be removed.

1 Press the  button on the remote control or the control panel to turn off the power, and then disconnect the power cord.

2 Remove any dust on the air filter by using a vacuum cleaner from the front side.

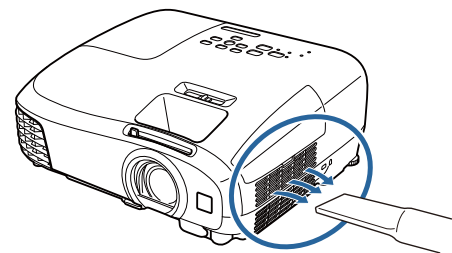

Cleaning the main unit

Clean the projector's surface by wiping it gently with a soft cloth.

If it is particularly dirty, moisten the cloth with water containing a small amount of neutral detergent, and then firmly wring the cloth dry before using it to wipe the surface.

Attention

Do not use volatile substances such as wax, alcohol, or thinner to clean the projector's surface. The quality of the case may change or the paint may peel off.

■ Cleaning the lens

Use a commercially available cloth for cleaning glasses to gently wipe off dirt from the lens.

Attention

Do not rub the lens with harsh materials or handle the lens too roughly as it can easily become damaged.

■ Cleaning the 3D Glasses

Use the cloth supplied to gently wipe off dirt from the lenses of the 3D Glasses.

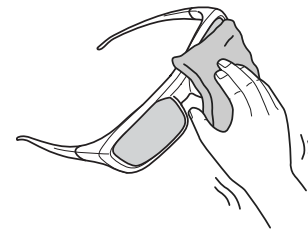

Attention

- Do not rub the lenses of the glasses with harsh materials or handle the lenses too roughly as they can easily become damaged.
- When maintenance is necessary, disconnect the USB Charging Adapter from the electrical outlet, and check that all cables have been disconnected.



The 3D Glasses contain rechargeable batteries. Observe local regulations when you dispose of them.

Replacement Periods for Consumables

■ Air filter replacement period

- If the message is displayed even though the air filter has been cleaned  [p.90](#)

■ Lamp replacement period

- The following message is displayed when projection starts:
"It is time to replace your lamp. Please contact your Epson projector reseller or visit www.epson.com to purchase."
- The projected image gets darker or starts to deteriorate.



- The lamp replacement message is set to appear after 3,900 H in order to maintain the initial brightness and quality of the projected images. The message display time changes depending on the usage situation, such as the color mode setting and so on.
If you continue to use the lamp after the replacement period has passed, the possibility that the lamp may explode increases. When the lamp replacement message appears, replace the lamp with a new one as soon as possible, even if it is still working.
- Depending on the characteristics of the lamp and the way it has been used, the lamp may become darker or stop working before the lamp warning message appears. You should always have a spare lamp unit ready in case it is needed.

Replacing Consumables

Replacing the air filter



Dispose of used air filters properly in accordance with your local regulations.

Filter frame: ABS

Filter: Polyurethane foam

- 1 Press the  button on the remote control or the control panel to turn off the power, and then disconnect the power cord.

- 2 Open the air filter cover.

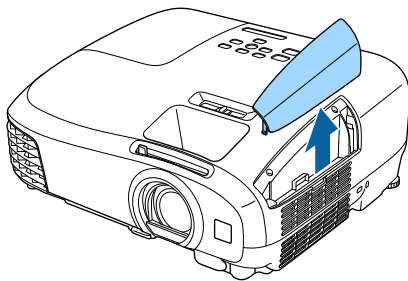

- 3 Remove the old air filter.
Grip the air filter cover tab and pull it straight up.

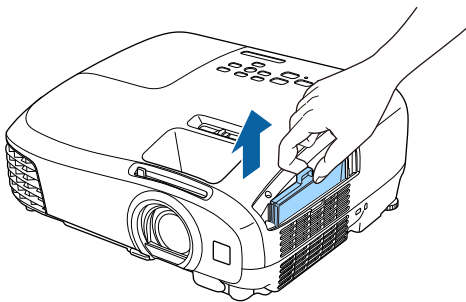

- 4 Install the new air filter.
Slide in the air filter until it clicks into place.

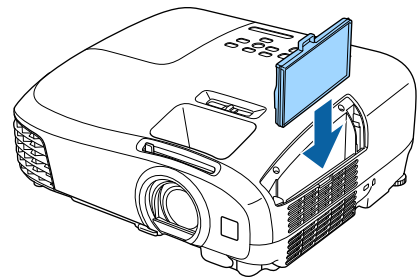

- 5 Close the air filter cover.

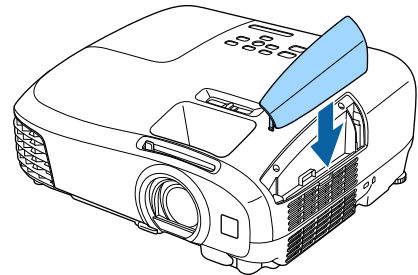

Replacing the lamp



Warning

When replacing the lamp because it has stopped illuminating, there is a possibility that the lamp may be broken. If replacing the lamp of a projector that has been suspended from the ceiling, you should always assume that the lamp is cracked, and remove the lamp cover with care. When you open the lamp cover, small shards of glass could fall out. If any shards of glass get into your eyes or mouth, contact a doctor immediately.

 **Caution**

- Do not touch the lamp cover immediately after turning off the projector as it is still hot. Wait until the lamp has cooled down sufficiently before removing the lamp cover. Otherwise, you could get burnt.
- We recommend the use of genuine EPSON option lamps. The use of non-genuine lamps may affect projection quality and safety.
Any damage or malfunction caused by the use of non-genuine lamps may not be covered by Epson's warranty.

1 Press the  button on the remote control or the control panel to turn off the power, and then disconnect the power cord.

2 Loosen the lamp cover fixing screw.

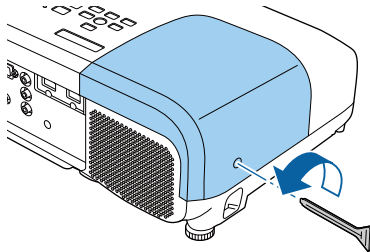

3 Remove the lamp cover.
Slide the lamp cover straight forward and remove it.

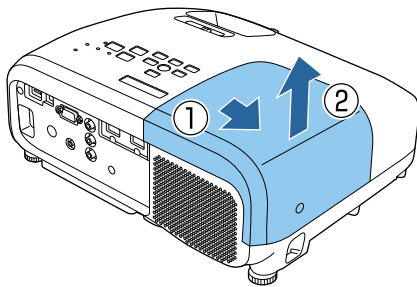

4 Loosen the two lamp fixing screws.

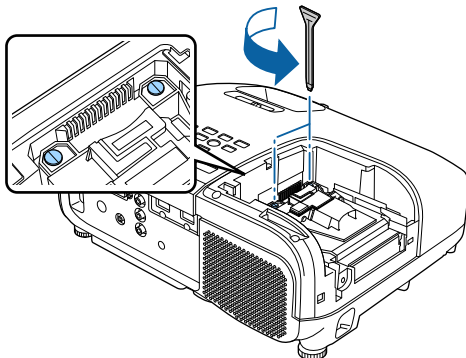

5 Remove the old lamp.
Grip the projection and pull it straight out.

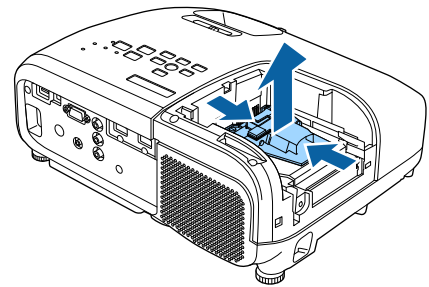

6 Install the new lamp.
Make sure the lamp is facing the correct direction and press it in.

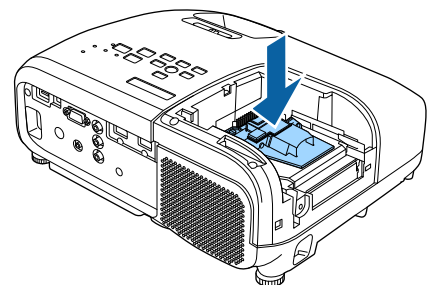

7 Tighten the two lamp fixing screws.

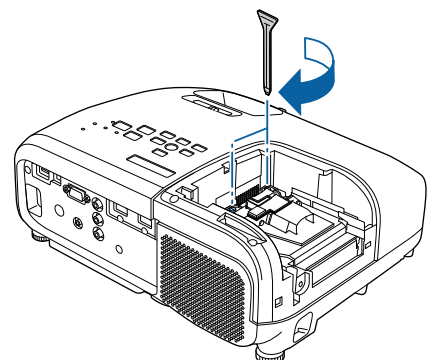

- 8 Replace the lamp cover.
Slide the cover back into place.

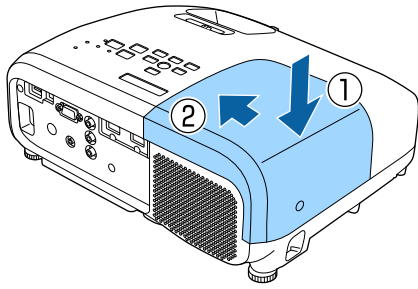

- 9 Tighten the lamp cover fixing screw.

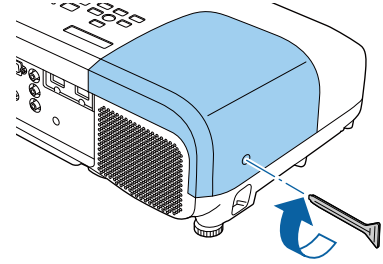

Warning

Do not disassemble or remodel the lamp. If a modified or disassembled lamp is installed in the projector and used, it could cause a fire, electric shock, or an accident.

Caution

- Make sure you install the lamp and lamp cover securely. If they are not installed correctly, the power does not turn on.
- The lamp contains mercury (Hg). Dispose of used lamps in accordance with your local laws and regulations on disposing of fluorescent tubing.

Resetting lamp hours

After replacing the lamp, make sure you reset the lamp hours.

The projector records how long the lamp is turned on and a message and indicator notify you when it is time to replace the lamp.

- 1 Turn on the power.
- 2 Press the **Menu** button.
The Configuration menu is displayed.
- 3 Select **Reset - Reset Lamp Hours**.
A reset confirmation message is displayed.

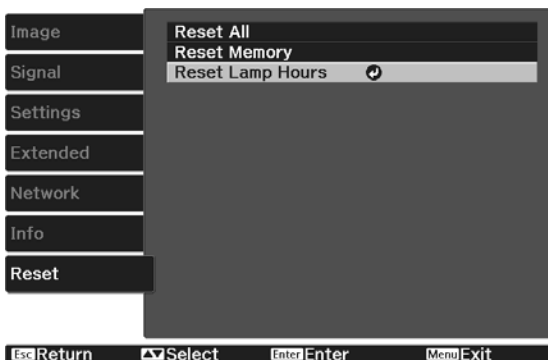

- 4 Use the **Left/Right** buttons to select **Yes**, and then press the **Enter** button to execute.

The lamp hours are reset.

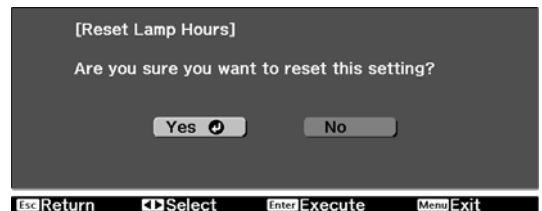

Optional Accessories and Consumables

The following optional accessories/consumables are available for purchase if required. This list of optional accessories and consumables is current as of: May, 2015. Details of accessories are subject to change without notice.

Varies depending on country of purchase.

Optional Items

Name	Model No.	Explanation
Ceiling mount (white)*	ELPMB23	Use when installing the projector on a ceiling.
Ceiling pipe 450 (450 mm white)*	ELPFP13	Use when installing the projector on a high ceiling.
Ceiling pipe 700 (700 mm white)*	ELPFP14	
RF system 3D Glasses	ELPGS03	Use when viewing 3D images.
USB Charging Adapter	ELPAC01	Use when charging the 3D Glasses.
Computer cable (1.8 m)	ELPKC02	Use when projecting a computer's screen.
Computer cable (3.0 m)	ELPKC09	
Computer cable (20.0 m)	ELPKC10	

* Special expertise is required to suspend the projector from a ceiling. Contact your local dealer.

Consumables

Name	Model No.	Explanation
Lamp unit	ELPLP88	Use as a replacement for used lamps. (1 lamp)
Air filter	ELPAF32	Use as a replacement for used air filters. (1 air filter)



Supported Resolutions

Computer Signals (Analog RGB)

Signal	Refresh Rate (Hz)	Resolution (dots)
VGA	60	640 x 480
SVGA	60	800 x 600
XGA	60	1024 x 768
SXGA	60	1280 x 960
	60	1280 x 1024
WXGA	60	1280 x 768
	60	1366 x 768
	60	1280 x 800
WXGA++	60	1600 x 900

Composite Video

Signal	Refresh Rate (Hz)	Resolution (dots)
TV (NTSC)	60	720 x 480
TV (SECAM)	50	720 x 576
TV (PAL)	50/60	720 x 576

HDMI1/HDMI2 Input Signal

Signal	Refresh Rate (Hz)	Resolution (dots)
VGA	60	640 x 480
SDTV (480i)	60	720 x 480
SDTV (576i)	50	720 x 576
SDTV (480p)	60	720 x 480
SDTV (576p)	50	720 x 576
HDTV (720p)	50/60	1280 x 720
HDTV (1080i)	50/60	1920 x 1080
HDTV (1080p)	24/30/50/60	1920 x 1080

MHL Input Signal

Signal	Refresh Rate (Hz)	Resolution (dots)
VGA	60	640 x 480
SDTV (480i)	60	720 x 480

Signal	Refresh Rate (Hz)	Resolution (dots)
SDTV (576i)	50	720 x 576
SDTV (480p)	60	720 x 480
SDTV (576p)	50	720 x 576
HDTV (720p)	50/60	1280 x 720
HDTV (1080i)	50/60	1920 x 1080
HDTV (1080p)	24/30	1920 x 1080

3D Input Signal HDMI

Signal	Refresh Rate (Hz)	Resolution (dots)	3D Format		
			Frame Packing	Side by Side	Top and Bottom
HDTV750p (720p)	50/60	1280 x 720	✓	✓	✓
HDTV1125i (1080i)	50/60	1920 x 1080	-	✓	-
HDTV1125p (1080p)	50/60	1920 x 1080	-	✓	-
HDTV1125p (1080p)	24	1920 x 1080	✓	✓	✓

3D Input Signal MHL

Signal	Refresh Rate (Hz)	Resolution (dots)	3D Format		
			Frame Packing	Side by Side	Top and Bottom
HDTV750p (720p)	50/60	1280 x 720	-	✓	✓
HDTV1125i (1080i)	50/60	1920 x 1080	-	✓	-
HDTV1125p (1080p)	50/60	1920 x 1080	-	-	-
HDTV1125p (1080p)	24	1920 x 1080	-	✓	✓



Specifications

Product name	EH-TW5350	EH-TW5300/EH-TW5210
Appearance	297 (W) x 119 (H) x 249 (D) mm	
Panel Size	0.61" wide	
Display method	Polysilicon TFT active matrix	
Resolution	1920 (W) x 1080 (H) x 3	
Focus adjustment	Manual	
Zoom adjustment	Manual (Approx. 1 to 1.2)	
Lamp (light source)	UHE lamp 200 W, Model No.: ELPLP88	
Lamp replacement time	3,900 hours	
Power supply	100 - 240 V AC \pm 10%, 50/60 Hz, 3.1 - 1.4 A	
Power consumption	100 to 120 V area	Operating: 307 W
		Standby power consumption (Communication On): 2.1 W Standby power consumption (Communication Off): 0.21 W
	220 to 240 V area	Operating: 291 W
		Standby power consumption (Communication On): 2.4 W Standby power consumption (Communication Off): 0.28 W
Operating altitude	Altitude 0 to 3,000 m	
Operating temperature	+5 to +35°C * (No condensation)	
Storage temperature	-10 to +60°C (No condensation)	
Mass	Approx. 3.1 kg	Approx. 2.9 kg
Connectors	PC port x 1, Mini D-Sub15-pin (female) blue	
	HDMI port x 2, HDMI For HDCP, For CEC signals, For MHL signals (HDMI1 port only), For 3D signals, For linear PCM, Deep Color	
	Video port x 1, RCA pin jack	
	Audio-L/R port x 1, RCA pin jack	
	USB 2.0 TypeA port x 1	
	Audio Out port x 1, Stereo mini jack	
Speaker	Maximum input 5 W x 1	

* The operating temperature is +5 to 30°C at an altitude of 2287 to 3000m.

This product is also designed for IT power distribution system with phase-to-phase voltage 230V.

Обладнання відповідає вимогам Технічного регламенту обмеження використання деяких небезпечних речовин в електричному та електронному обладнанні.



001

Angle of tilt

If you use the projector tilted at an angle of more than 12°, it could be damaged or cause an accident.

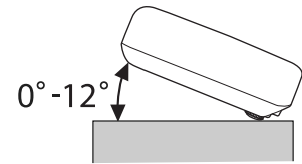

DECLARATION of CONFORMITY

According to 47CFR, Part 2 and 15

Class B Personal Computers and Peripherals; and/or

CPU Boards and Power Supplies used with Class B Personal Computers

We: Epson America, Inc.
Located at: 3840 Kilroy Airport Way
MS: 3-13
Long Beach, CA 90806
Tel: 562-981-3840

Declare under sole responsibility that the product identified herein, complies with 47CFR Part 2 and 15 of the FCC rules as a Class B digital device. Each product marketed, is identical to the representative unit tested and found to be compliant with the standards. Records maintained continue to reflect the equipment being produced can be expected to be within the variation accepted, due to quantity production and testing on a statistical basis as required by 47CFR 2.909. Operation is subject to the following two conditions : (1) this device may not cause harmful interference, and (2) this device must accept any interference received, including interference that may cause undesired operation.

Trade Name: EPSON
Type of Product: LCD Projector
Model: H707C/H708C/H709C

FCC Compliance Statement**For United States Users**

This equipment has been tested and found to comply with the limits for a Class B digital device, pursuant to Part 15 of the FCC Rules. These limits are designed to provide reasonable protection against harmful interference in a residential installation. This equipment generates, uses, and can radiate radio frequency energy and, if not installed and used in accordance with the instructions, may cause harmful interference to radio communications. However, there is no guarantee that interference will not occur in a particular installation. If this equipment does cause harmful interference to radio or television reception, which can be determined by turning the equipment off and on, the user is encouraged to try to correct the interference by one or more of the following measures.

- Reorient or relocate the receiving antenna.
- Increase the separation between the equipment and receiver.
- Connect the equipment into an outlet on a circuit different from that to which the receiver is connected.
- Consult the dealer or an experienced radio/TV technician for help.

WARNING

The connection of a non-shielded equipment interface cable to this equipment will invalidate the FCC Certification or Declaration of this device and may cause interference levels which exceed the limits established by the FCC for this equipment. It is the responsibility of the user to obtain and use a shielded equipment interface cable with this device. If this equipment has more than one interface connector, do not leave cables connected to unused interfaces. Changes or modifications not expressly approved by the manufacturer could void the user's authority to operate the equipment.



Appearance

Units: mm

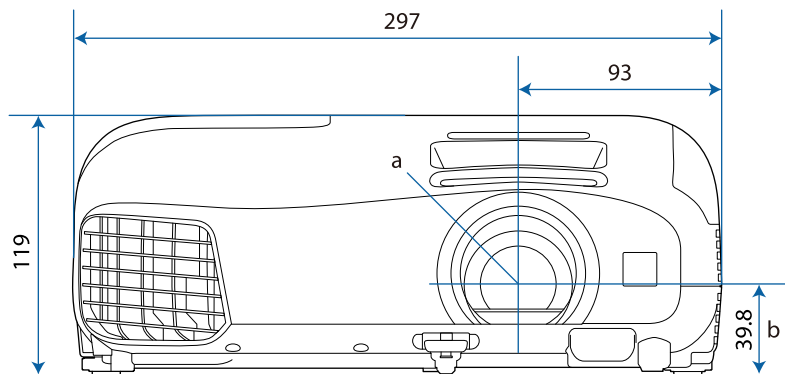



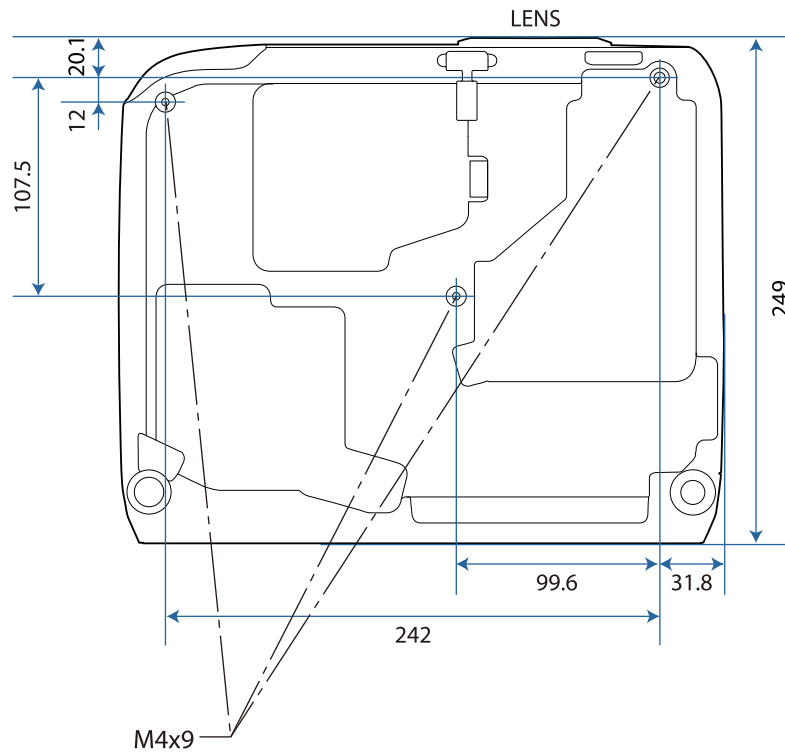





















- a Center of lens
- b Distance from center of lens to suspension bracket fixing point



List of Safety Symbols

The following table lists the meaning of the safety symbols labeled on the equipment.

Symbol mark	Approved standards	Meaning
	IEC60417 No. 5007	"ON" (power) To indicate connection to the mains.
	IEC60417 No. 5008	"OFF" (power) To indicate disconnection from the mains.
	IEC60417 No. 5009	Stand-by To identify the switch or switch position by means of which part of the equipment is switched on in order to bring it into the stand-by condition.
	ISO7000 No. 0434B IEC3864-B3.1	Caution To identify general caution when using the product.
	IEC60417 No. 5041	Caution, hot surface To indicate that the marked item can be hot and should not be touched without taking care.
	IEC60417 No. 6042 ISO3864-B3.6	Caution, risk of electric shock To identify equipment that has risk of electric shock.
	IEC60417 No. 5957	For indoor use only To identify electrical equipment designed primarily for indoor use.
	IEC60417 No. 5926	Polarity of d.c. power connector To identify the positive and negative connections (the polarity) on a piece of equipment to which a d.c. power supply may be connected.
	---	
	IEC60417 No. 5001B	Battery, general On battery powered equipment. To identify a device for instance a cover for the battery compartment, or the connector terminals.
	IEC60417 No. 5002	Positioning of cell To identify the battery holder itself and to identify the positioning of the cell(s) inside the battery holder.
	---	
	IEC60417 No. 5019	Protective earth To identify any terminal which is intended for connection to an external conductor for protection against electric shock in case of a fault, or the terminal of a protective earth electrode.
	IEC60417 No. 5017	Earth To identify an earth (ground) terminal in cases where neither the symbol  is explicitly required.

Symbol mark	Approved standards	Meaning
	IEC60417 No. 5032	Alternating current To indicate on the rating plate that the equipment is suitable for alternating current only; to identify relevant terminals.
	IEC60417 No. 5031	Direct current To indicate on the rating plate that the equipment is suitable for direct current only; to identify relevant terminals.
	IEC60417 No. 5172	Class II equipment To identify equipment meeting the safety requirements specified for Class II equipment according to IEC 61140.
	ISO 3864	General prohibition To identify actions or operations that are prohibited.
	ISO 3864	Contact prohibition To indicate injury that could occur due to touching a specific part of the equipment.
	---	Never look into the optical lens while the projector is on.
	---	To indicate that the marked item don't place anything on projector.
	ISO3864 IEC60825-1	Caution, laser radiation To indicate the equipment has a laser radiation part.
	ISO 3864	Disassembly prohibition To indicate a risk of injury, such as electric shock, if the equipment is disassembled.



Glossary

This section briefly explains the difficult terms that are not explained in context in the text of this guide. For details, refer to other commercially available publications.

Aspect Ratio	<p>The ratio between an image's length and its height. Screens with a horizontal:vertical ratio of 16:9, such as HDTV screens, are known as wide screens.</p> <p>SDTV and general computer displays have an aspect ratio of 4:3.</p>
HDCP	<p>HDCP is an abbreviation for High-bandwidth Digital Content Protection. It is used to prevent illegal copying and protect copyrights by encrypting digital signals sent over DVI and HDMI ports. Because the HDMI port on this projector supports HDCP, it can project digital images protected by HDCP technology. However, the projector may not be able to project images protected with updated or revised versions of HDCP encryption.</p>
HDMI™	<p>An abbreviation for High Definition Multimedia Interface. This is the standard by which HD images and multichannel audio signals are digitally transmitted.</p> <p>HDMI™ is a standard aimed at digital consumer electronics and computers. By not compressing the digital signal, the image can be transferred at the highest quality possible. It also provides an encryption function for the digital signal.</p>
HDTV	<p>An abbreviation for High-Definition Television. This refers to high-definition systems which satisfy the following conditions.</p> <ul style="list-style-type: none"> • Vertical resolution of 720p or 1080i or greater (p = Progressive, i = Interlace) • Screen aspect of 16:9 Dolby Digital audio reception and playback (or output)
Interlace	<p>Transmits information needed to create one screen by sending every other line, starting from the top of the image and working down to the bottom. Images are more likely to flicker because one frame is displayed every other line.</p>
MHL	<p>An abbreviation for Mobile High-definition Link, which is a standard high-definition interface that enables high-speed transfer of video signals on mobile devices.</p> <p>It is a standard targeting smartphones and tablets that transfers uncompressed digital signals without loss of quality and also enables simultaneous charging of such devices.</p>
NTSC	<p>An abbreviation for the National Television Standards Committee. A terrestrial analog color broadcasting method. This method is used in Japan, North America, and Latin America.</p>
Pairing	<p>Register devices in advance when connecting with Bluetooth devices to ensure mutual communication.</p>
PAL	<p>An abbreviation for Phase Alternation by Line. A terrestrial analog color broadcasting method. This method is used in various Western European countries (with the exception of France), Asian countries such as China, and Africa.</p>
SDTV	<p>An abbreviation for Standard Definition Television. This refers to standard television systems which do not satisfy the conditions for HDTV High-Definition Television.</p>
SECAM	<p>An abbreviation for SEquential Couleur A Memoire. A terrestrial analog color broadcasting method. This method is used in France, Eastern Europe, the former Soviet Union, the Middle East, Africa, and so on.</p>
SVGA	<p>A screen size standard with a resolution of 800 (horizontal) x 600 (vertical) dots.</p>
SXGA	<p>A screen size standard with a resolution of 1,280 (horizontal) x 1,024 (vertical) dots.</p>
VGA	<p>A screen size standard with a resolution of 640 (horizontal) x 480 (vertical) dots.</p>
XGA	<p>A screen size standard with a resolution of 1,024 (horizontal) x 768 (vertical) dots.</p>

YCbCr	In component image signals for SDTV, Y is the brightness, while Cb and Cr indicate the color difference.
YPbPr	In component image signals for HDTV, Y is the brightness, while Pb and Pr indicate the color difference.



General Notes

All rights reserved. No part of this publication may be reproduced, stored in a retrieval system, or transmitted in any form or by any means, electronic, mechanical, photocopying, recording, or otherwise, without the prior written permission of Seiko Epson Corporation. No patent liability is assumed with respect to the use of the information contained herein. Neither is any liability assumed for damages resulting from the use of the information contained herein.

Neither Seiko Epson Corporation nor its affiliates shall be liable to the purchaser of this product or third parties for damages, losses, costs, or expenses incurred by the purchaser or third parties as a result of: accident, misuse, or abuse of this product or unauthorized modifications, repairs, or alterations to this product, or (excluding the U.S.) failure to strictly comply with Seiko Epson Corporation's operating and maintenance instructions.

Seiko Epson Corporation shall not be liable against any damages or problems arising from the use of any options or any consumable products other than those designated as Original Epson Products or Epson Approved Products by Seiko Epson Corporation.

The contents of this guide may be changed or updated without further notice.

Illustrations in this guide and the actual projector may differ.

Restriction of Use

When this product is used for applications requiring high reliability/safety such as transportation devices related to aviation, rail, marine, automotive etc.; disaster prevention devices; various safety devices etc; or functional/precision devices etc, you should use this product only after giving consideration to including fail-safes and redundancies into your design to maintain safety and total system reliability. Because this product was not intended for use in applications requiring extremely high reliability/safety such as aerospace equipment, main communication equipment, nuclear power control equipment, or medical equipment related to direct medical care etc, please make your own judgment on this product's suitability after a full evaluation.

General Notice

EPSON and ELPLP are the trademarks or registered trademarks of Seiko Epson Corporation.

HDMI and High-Definition Multimedia Interface are the trademarks or registered trademarks of HDMI Licensing LLC. 

The Bluetooth® word mark and logo are registered trademarks of Bluetooth SIG, Inc., and the Seiko Epson Corporation uses these marks under license. Other trademarks or trade names are the property of their respective owners.

Bluetopia® is provided for your use by Stonestreet One, LLC® under a software license agreement. Stonestreet One, LLC® is and shall remain the sole owner of all right, title and interest whatsoever in and to Bluetopia® and your use is subject to such ownership and to the license agreement. Stonestreet One, LLC® reserves all rights related to Bluetopia® not expressly granted under the license agreement and no other rights or licenses are granted either directly or by implication, estoppel or otherwise, or under any patents, copyrights, mask works, trade secrets or other intellectual property rights of Stonestreet One, LLC®.

© 2000-2012 Stonestreet One, LLC® All Rights Reserved.

MHL, the MHL logo, and Mobile High-Definition Link are trademarks, registered trademarks, or service marks of MHL and LLC in the United States and/or other countries.

Miracast™, WPA™, and WPA2™ are registered trademarks of the Wi-Fi Alliance.

Intel® is a registered trademark of the Intel Corporation in the U.S. and/or other countries.

App Store is a service mark of Apple Inc.

Google Play is a trademark of Google Inc.

Other product names used herein are also for identification purposes only and may be trademarks of their respective owners. Epson disclaims any and all rights in those marks.

©SEIKO EPSON CORPORATION 2015. All rights reserved.

Indication of the manufacturer and the importer in accordance with requirements of EU directive

Manufacturer: SEIKO EPSON CORPORATION

Address: 3-5, Owa 3-chome, Suwa-shi, Nagano-ken 392-8502 Japan

Telephone: 81-266-52-3131

<http://www.epson.com/>

Importer: EPSON EUROPE B.V.

Address: Atlas Arena, Asia Building, Hoogoorddreef 5, 1101 BA Amsterdam Zuidoost The Netherlands

Telephone: 31-20-314-5000

<http://www.epson.com/europe.html>

- 3**
- 3D brightness 66
 - 3D conversion 45
 - 3D display 66
 - 3D format 66
 - 3D Glasses 43
 - 3D images 42
 - 3D settings 66
 - 3D viewing notice 66
- A**
- Adjusting focus 29
 - Adjusting RGB 37
 - Adjusting the tilt 30
 - Advanced 66, 67
 - Air filter 90
 - Air filter cover 92
 - Air filter replacement period 91
 - Appearance 101
 - Aspect 34, 66
 - Auto iris 36, 66
 - Auto setup 67
 - Auto V-Keystone 30, 68
- B**
- Basic menu 72
 - Bluetooth 68
 - Brightness 37, 65, 66
- C**
- CEC standards 48
 - Channel 73
 - Child lock 69
 - Cleaning the 3D Glasses 91
 - Cleaning the air filter 90
 - Cleaning the lens 91
 - Cleaning the main unit 90
 - Color mode 33, 65
 - Color saturation 65
 - Color Temp. 65
 - Configuration menu 64
 - Connecting 19
 - Connecting a computer 19
 - Connecting Bluetooth devices 21
 - Connecting external speakers 21
 - Connecting smartphones or tablets 20
 - Connecting USB devices 20
 - Connecting video equipment 19
 - Connection Mode 73
 - Contrast 65
 - Control Panel 9
- D**
- Control panel 8
 - Control panel lock 69
 - Cool-down 28
- E**
- DHCP 73
 - Direct power on 70
 - Display 70
 - Display Background 70
 - Displaying the test pattern 29
- F**
- Erase memory 40
 - Error/Warning indicators 75
 - Event ID 88
 - Extended menu 70
- G**
- Focus 81
 - Focus adjustment 29
 - Focus ring 8, 29
 - Frame Interpolation 65
 - Full 34
- H**
- Gain 37, 66
 - Gateway Address 73
- I**
- H/V-Keystone 31, 68
 - HDMI link 48
 - HDMI port 48
 - Height adjustment 29
 - High altitude mode 70
 - H-Keystone 68
 - H-Keystone adjuster 31, 68
 - Home screen 27
 - Horizontal keystone adjuster 9
 - Hue 37, 66
- J**
- Illumination 70
 - Image 33
 - Image Enhancement 65
 - Image enhancement 35
 - Image menu 65
 - Images 50
 - Indicators 75
 - Info menu 74
 - Inverse 3D Glasses 66
 - IP Address 73

- IP Address Display 73
 IP Settings 73
- K**
- Keystone 68
- L**
- Lamp cover 8, 93
 Lamp cover fixing screw 93
 Lamp replacement period 91
 Language 71
 Load memory 39
 Lock setting 69
- M**
- Memory 69
 Memory function 39
 Menu 64
 Messages 70
- N**
- Network menu 71
 Noise 81
- O**
- Offset 37, 66
 Operating range 25
 Operating time 94
 Operation 70
 Overscan 67
- P**
- Pairing 44
 Passphrase 73
 Position 67
 Power 28
 Power consumption 66
 Power supply 26
 Projection 70
 Projection size 17, 29
- R**
- Remote Control 11
 Remote control 24
 Rename memory 40
 Replacement periods for consumables 91
 Replacement time 91
 Replacing consumables 92
 Replacing the air filter 92
 Replacing the lamp 92
- Reset 66, 67, 69, 71
 Reset all 74
 Reset lamp hours 74, 94
 Reset memory 40, 74
 Reset menu 74
 RGB 66
 RGBCMY 37, 66
- S**
- Saturation 37, 66
 Save memory 39
 Search Access Point 73
 Security 73
 Security menu 73
 Settings menu 68
 Sharpness 35, 65
 Signal menu 66
 Sleep mode 70
 Slideshow 50
 Soft Keyboard 72
 Source 26
 Specifications 98
 Split Screen 52
 Split screen 68
 SSID 73
 SSID Display 73
 Standby Mode 71
 Startup Screen 70
 Sub menu 64
 Subnet Mask 73
 Supported resolutions 96
 Sync. 67
- T**
- Tint 65
 Top menu 64
 Tracking 66
- U**
- USB 50
 User button 69
- V**
- Version 74
 V-Keystone 68
 Volume 32, 68
- W**
- Wireless LAN menu 73

Z

Zoom	34
Zoom adjustment	29
Zoom ring	8

Free Manuals Download Website

<http://myh66.com>

<http://usermanuals.us>

<http://www.somanuals.com>

<http://www.4manuals.cc>

<http://www.manual-lib.com>

<http://www.404manual.com>

<http://www.luxmanual.com>

<http://aubethermostatmanual.com>

Golf course search by state

<http://golfingnear.com>

Email search by domain

<http://emailbydomain.com>

Auto manuals search

<http://auto.somanuals.com>

TV manuals search

<http://tv.somanuals.com>